

CentreCOM[®] GS980MX Series

Gigabit Ethernet Switches

AlliedWare Plus™

GS980MX/10HSm

GS980MX/28 GS980MX/28PSm

GS980MX/52 GS980MX/52PSm

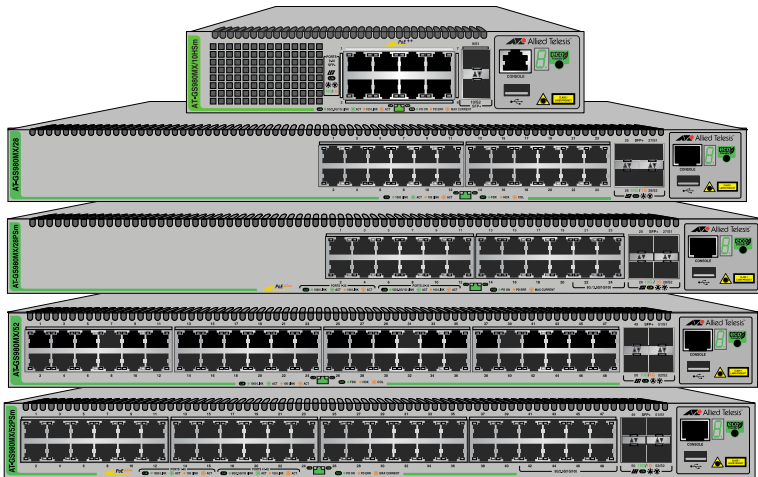

Quick Installation Guide



613-003064 Rev. A

Introduction

This Quick Installation Guide contains a short version of the installation instructions for the GS980MX Series of Gigabit Ethernet Switches. For more instructions, refer to the *GS980MX Series of Gigabit Ethernet Switches Installation Guides* on the Allied Telesis web site at www.alliedtelesis.com/us/en/services-support. This guide contains the following sections:

- ❑ “Front Panels” next
- ❑ “PoE+ and PoE++ Power Budgets” on page 5
- ❑ “VCStack™ Feature” on page 5
- ❑ “Beginning the Installation” on page 6
- ❑ “Installing the Switch” on page 11
- ❑ “Ports” on page 18
- ❑ “Powering On the Switch” on page 21
- ❑ “LEDs” on page 22
- ❑ “Starting a Local Management Session” on page 24
- ❑ “Disabling the VCStack Feature” on page 25
- ❑ “Troubleshooting” on page 26

Front Panels

The front panels of the switches are shown here.

GS980MX/10HSm

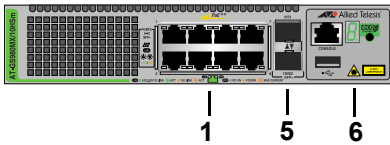

GS980MX/28

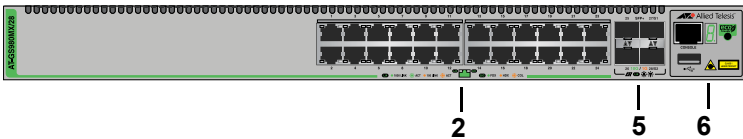

GS980MX/28PSm

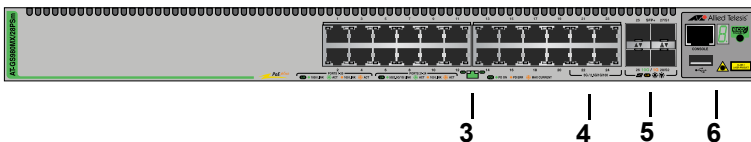

GS980MX/52

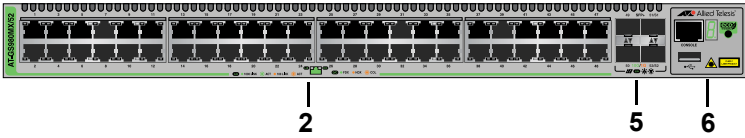

GS980MX/52PSm

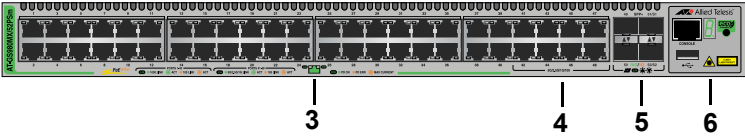

1	100M/1/2.5/5Gbps Ethernet copper ports with PoE++
2	10/100/1000Mbps Ethernet copper ports
3	10/100/1000Mbps Ethernet copper ports with PoE+
4	100M/1/2.5/5Gbps Ethernet copper ports with PoE+
5	1/10Gbps SFP+ transceiver ports
6	Management panel

Here are the 10/100/1000Mbps Ethernet copper ports.

Switch	10/100/1000Mbps Ports (no PoE)	10/100/1000Mbps Ports with PoE+
GS980MX/10HSm	-	-
GS980MX/28	Ports 1 to 24	-
GS980MX/28PSm	-	Ports 1 to 20
GS980MX/52	Ports 1 to 48	-
GS980MX/52PSm	-	Ports 1 to 40

Here are the 100M/1/2.5/5Gbps Ethernet copper ports, with PoE+ and PoE++.

Switch	100M/1/2.5/5Gbps Ports with PoE+	100M/1/2.5/5Gbps Ports with PoE++
GS980MX/10HSm	-	Ports 1 to 8
GS980MX/28PSm	Ports 21 to 24	-
GS980MX/52PSm	Ports 41 to 48	-

Here are the 1/10Gbps SFP+ ports.

Switch	1/10Gbps SFP+ Ports
GS980MX/10HSm	Ports 9 and 10
GS980MX/28	Ports 25 to 28
GS980MX/28PSm	Ports 25 to 28
GS980MX/52	Ports 49 to 52
GS980MX/52PSm	Ports 49 to 52

The management panel is shown here.

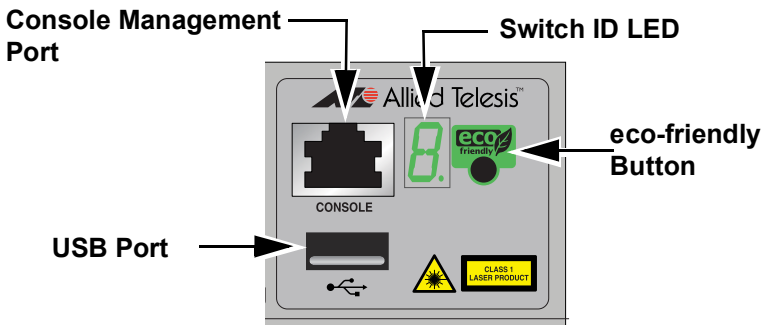

PoE+ and PoE++ Power Budgets

The PoE+ and PoE++ power budgets of the GS980MX/28PSm, GS980MX/52PSm, and GS980MX/10HSm Switches are listed here. Power budgets are the maximum amounts of power that PoE switches can provide to powered devices on the Ethernet copper ports.

Switch	PoE+ Budget	PoE++ Budget
GS980MX/10HSm	-	500 watts
GS980MX/28PSm	370 watts	-
GS980MX/52PSm	370 watts	-

The GS980MX/10HSm Switch supports IEEE 802.3bt PoE++ Classes 0 to 8 devices. (Maximum 90.0W at the switch ports.)

The GS980MX/28PSm and GS980MX/52PSm Switches support IEEE 802.3at PoE+ Classes 0 to 4 devices. (Maximum 30.0W at the switch ports.)

VCStack™ Feature

The VCStack feature is used to manage up to four GS980MX Switches as a single virtual unit. The switches synchronize their actions so that switching operations (such as spanning tree protocols, virtual LANs, and static port trunks) span across all the ports and switches. Two advantages of stacks are:

- ❑ You can manage multiple units simultaneously, which can simplify network management.
- ❑ You can add redundancy to your network topology by distributing functions across multiple switches. For instance, static port trunks on standalone switches have to consist of ports from the same switch. In contrast, static port trunks in a stack can have ports from different switches.

Note: For instructions, refer to the *GS980MX Series Installation Guide for Virtual Chassis Stacking*.

Beginning the Installation

Reviewing Safety Precautions

Review the following safety precautions before installing the product.

Note: The  symbol indicates that a translation of the safety statement is available in the PDF document “**Translated Safety Statements**” on the Allied Telesis website at www.alliedtelesis.com/us/en/documents/translated-safety-statements.



Warning: Class 1 Laser product.  L1



Warning: Do not stare into the laser beam.  L2



Warning: Power cord is used as a disconnection device. To de-energize equipment, disconnect the power cord.  E3



Warning: To prevent electric shock, do not remove the cover. No user-serviceable parts inside. This unit contains hazardous voltages and should only be opened by a trained and qualified technician. To avoid the possibility of electric shock, disconnect electric power to the product before connecting or disconnecting the cables.  E1



Warning: Class I Equipment. This equipment must be earthed. The power plug must be connected to a properly wired earth ground socket outlet. An improperly wired socket outlet could place hazardous voltages on accessible metal parts.  E4



Warning: The device is heavy. Always ask for assistance before moving or lifting it to avoid injuring yourself or damaging the equipment.  E122



Warning: To reduce the risk of electric shock, the PoE ports on this product must not connect to cabling that is routed outside the building where this device is located.

⚡ E40

Installation Options

These figures illustrate the installation options.

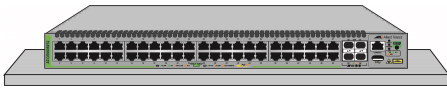

Table

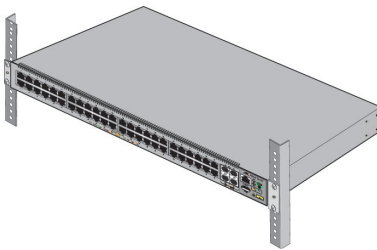

**Standard 19-inch
equipment rack**



**Wood or concrete
wall**

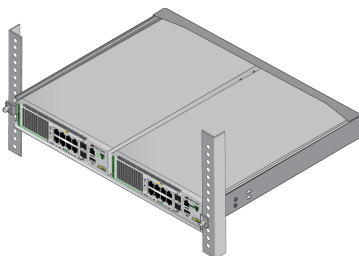

**GS980MX/10HSm in a
Standard 19-inch
equipment rack with
RKMT-J15 brackets**

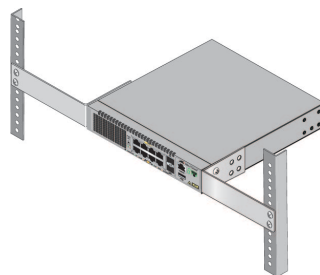

**GS980MX/10HSm in a
Standard 19-inch
equipment rack with
RKMT-J14 brackets**

Unpacking the Switches

All GS980MX Series Switches come with these items.



One 2m (6.6 ft) local management cable with RJ-45 (8P8C) and DB-9 (D-sub 9-pin) connectors



One AC power cord



Four bumper feet with rivets



One power cord retaining clip

The GS980MX/10HSm Switch comes with these additional items.

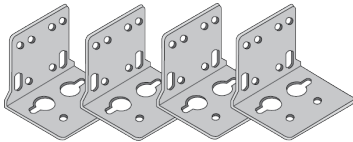

Four BRKT-J24 wall/equipment rack brackets



Sixteen 4x6mm screws for attaching the wall/equipment rack brackets to the switch

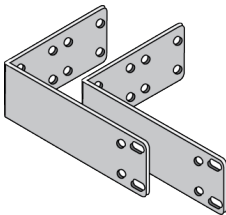

Two RKMT-J14 equipment rack brackets



Four 3x6mm screws for attaching handles to RKMT-J14 brackets:



Two handles for the RKMT-J14 equipment rack brackets

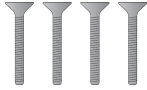

Four 4x32.3mm screws for wood or concrete walls

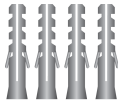

Four 6x4x29.6mm wall anchors

The GS980MX/28 and GS980MX/28PSm Switches come with these additional items.

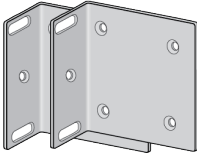

Two wall/equipment rack brackets



Eight 3x6mm screws for attaching the wall/equipment rack brackets to the switch



Two 4x32.3mm screws for wood or concrete walls



Two 6x4x29.6mm anchors for concrete walls

The GS980MX/52 and GS980MX/52PSm Switches come with these additional items.

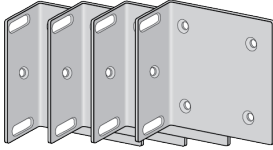

Four wall/equipment rack brackets



Sixteen 3x6mm screws for attaching the wall/equipment rack brackets to the switch

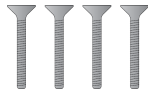

Four 4x32.3mm screws for wood or concrete walls

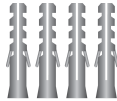

Four 6x4x29.6mm anchors for concrete walls

Choosing a Site for the Switch

Review these site recommendations and requirements.

- ❑ Before installing the switch in an equipment rack, check that the rack is safely secured so that it will not tip over. Devices in a rack should be installed starting at the bottom of the rack, with the heavier devices near the bottom.
- ❑ Before installing the switch on a table, verify that the table is level and stable.
- ❑ Before installing the switch on a wall, verify that the wall's material is strong enough to hold the switch's weight. You should position the device so that it can be screwed into the wall's framing timber or equivalent structural element.
- ❑ The power outlet should be located near the switch and be easily accessible.
- ❑ The site should allow for easy access to the ports on the front of the switch so that you can easily connect and disconnect cables, and view the port LEDs.

- ❑ The site should allow for adequate air flow around the unit and through the cooling vents on the front and rear panels. (The ventilation direction is from front to back.)
- ❑ Do not place objects on top of the switch.
- ❑ The site should not expose the switch to moisture or water.
- ❑ The site should be a dust-free environment.
- ❑ The site should use dedicated power circuits or power conditioners to supply reliable electrical power to the network devices.
- ❑ Do not install the switch in a wiring or utility box that does not have adequate airflow.



Warning: Switches should not be stacked on a table or desktop. They could present a physical safety hazard if you need to move or replace switches. ⚡ E91

Ventilation Direction in the Switches

The direction of ventilation in the switches is from front to back.

Installing the Switch

Installing the Switch on a Desk or Table

To install the switch on a desk or table, perform the following procedure:

1. Place the switch upside down on a table.
2. Inset a rivet housing into a bumper foot.
3. Place the bumper foot on one of the corner holes in the bottom panel of the switch.
4. Insert the rivet to secure the bumper foot to the base.

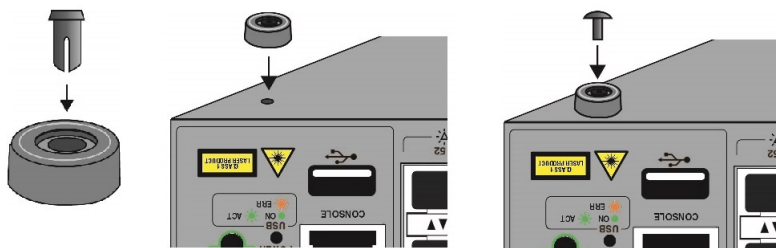

5. Repeat steps 2 to 4 to install the remaining bumper feet.
6. Turn the switch over.
7. Go to “Ports” on page 18.

Installing the Switch in an Equipment Rack

Note: For installation instructions for the GS980MX/10HSm Switch and the RKMT-J15 equipment rack shelf, refer to the *GS980MX Series Standalone Gigabit Layer 3+ Ethernet Switches Installation Guide* or *RKMT-J15 Equipment Rack Shelf Installation Guide*.

The following items are required to install the switch in an equipment rack:

- Two equipment rack brackets (included with the switch)
- Eight bracket screws (included with the switch)
- Two bracket handles (included with the GS980MX/10HSm Switch)
- Four M3x6mm screws for the bracket handles (included with the GS980MX/10HSm Switch)
- Cross-head screwdriver (not provided)
- Four standard equipment rack screws (not provided)

To install the switch, perform the following procedure:

1. If the bumper feet are attached to the bottom of the switch, remove them using a flat-head screwdriver.
2. For the GS980MX/10HSm Switch, attach the two handles to the RKMT-J14 brackets with the four M3x6mm screws. This step is optional.

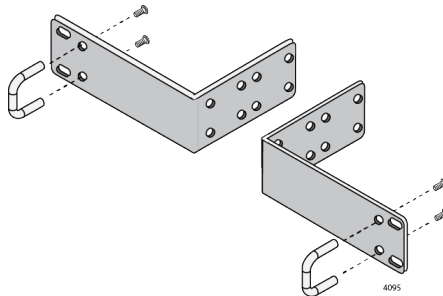

3. Attach two brackets to the sides of the switch with eight bracket screws included with the unit. The following figures illustrate the positions of the brackets on the switches in a standard 19-inch equipment rack.

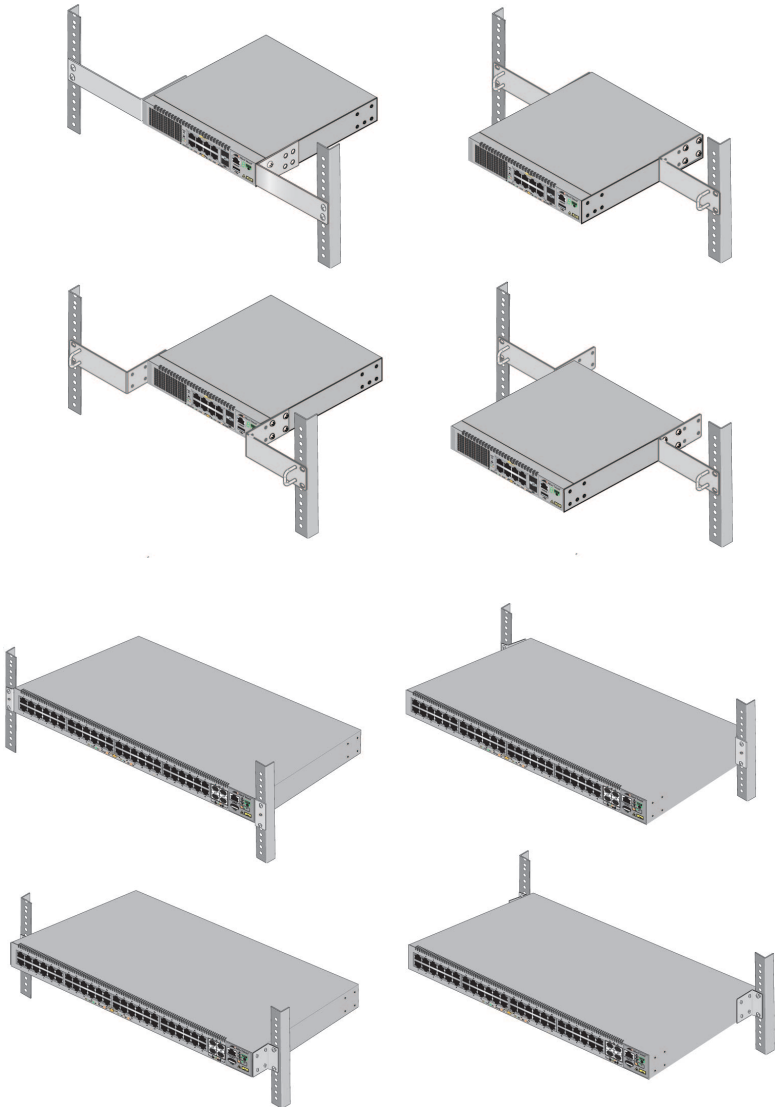

4. Have another person hold the switch in the equipment rack while you secure it using four standard equipment rack screws (not provided).

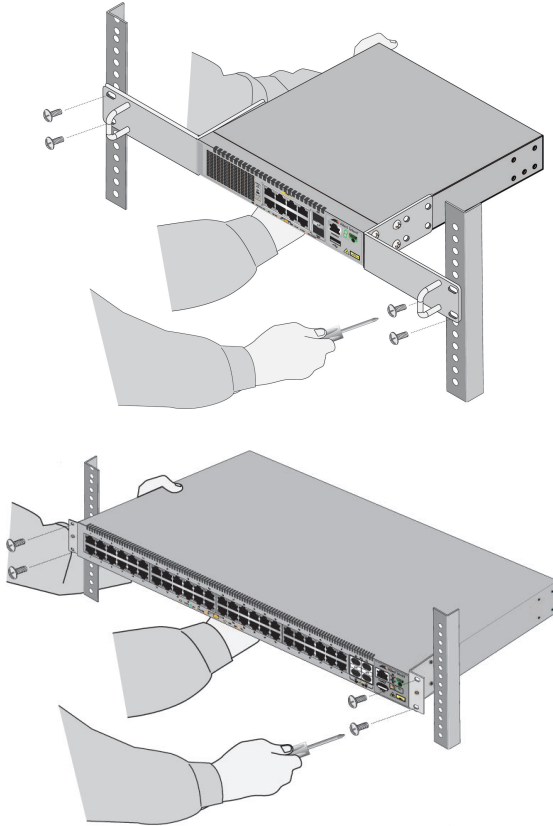

5. Go to “Ports” on page 18.

Installing the Switch on a Wall

Here are guidelines for installing the GS980MX/28 and GS980MX/28PSm switches on a wall:

- You install the switches with two brackets.
- You can install the switches with the front panels facing up, left, or right. Do not install switches with the front panels facing down.

Here are guidelines for installing the GS980MX/10HSm, GS980MX/52, and GS980MX/52PSm Switches on a wall:

- You install the switches with four brackets.

- ❑ You can install the switches with the front panels facing left or right. Do not install them with the front panels facing up or down.

Here are the required tools and material for installing the switch on a wall:

- ❑ Two or four wall/equipment rack brackets (included with the switch)
- ❑ Eight or sixteen screws (included with the switch)
- ❑ Two or four wood or concrete wall screws (included with the switch)
- ❑ Two or four wall anchors (included with the switch)
- ❑ Cross-head screwdriver (not provided)
- ❑ Flat-head screwdriver (not provided)
- ❑ Stud finder for a wooden wall, capable of identifying the middle of wall studs and hot electrical wiring (not provided)
- ❑ Drill and 1/4" carbide drill bit for a concrete wall (not provided)



Warning: The device should be installed on the wall by a qualified building contractor. Serious injury to yourself or others or damage to the equipment may result if it is not properly fastened to the wall. *⚡* E105



Caution: The supplied screws and anchors might not be suitable for all walls. A qualified building contractor should determine the hardware requirements of your wall prior to installing the switch. *⚡* E88

To install the switch on a wall, perform the following procedure:

1. Place the switch on a table.
2. If the bumper feet are attached to the bottom of the switch, remove them using a flat-head screwdriver.
3. Attach two or four brackets to the sides of the switch, as follows:
 - ❑ For the GS980MX/28 and GS980MX/28PSm Switches, install two brackets with eight screws, as shown here.

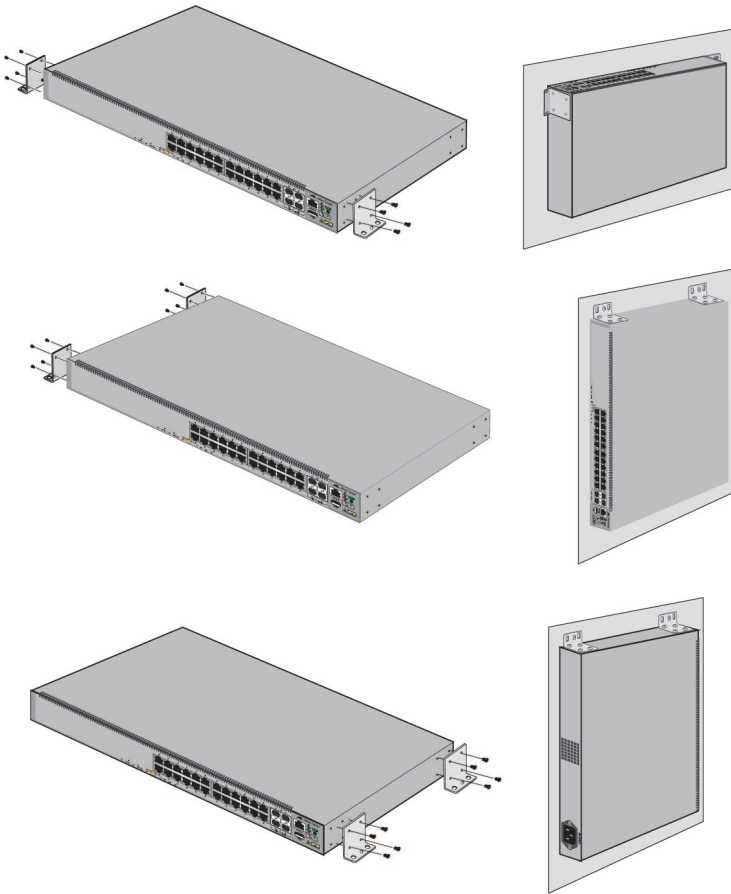

- For the GS980MX/10HSm, GS980MX/52, and GS980MX/52PSm Switches, attach four brackets with sixteen screws, as shown here.

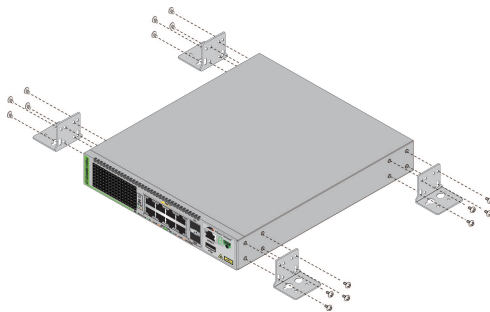

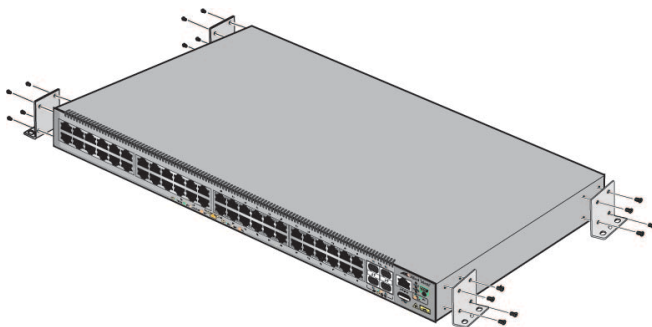

Note: If you need to drill holes in the wall for the screws, perform steps 4 to 8. Otherwise, go to step 9.

4. Have another person hold the switch on the concrete wall at the selected location for the device while you use a pencil or pen to mark the wall with the locations of the four screw holes in the four brackets (one screw per bracket).

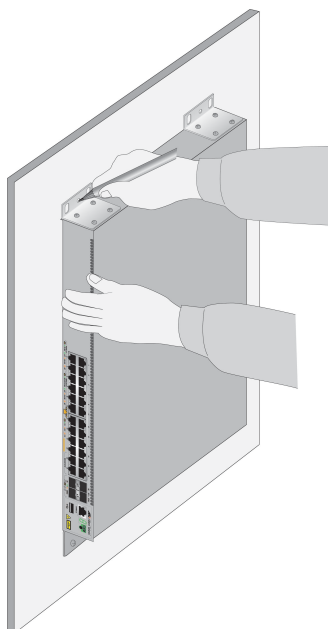

5. Place the switch on a table or desk.
6. Use the stud finder to check for hot electrical wires at the locations of the screw holes.



Warning: Do not install the switch on a wall near hot electrical wires.

7. If the wall material requires pre-drilling the screw holes, use an appropriate drill to drill the holes you marked in step 4. Refer to “Unpacking the Switches” on page 8 for the dimensions of the supplied screws and anchors.
8. If the wall material requires anchors, insert the anchors into the screw holes.
9. Have another person hold the switch at the selected wall location while you secure it to the wall with two or four screws.
10. Go to “Ports” next.

Ports

Ethernet Copper Cable Specifications

The minimum cable requirements for the Ethernet copper ports are:

- ❑ 10/100Mbps ports: Standard TIA/EIA 568-B-compliant Category 3 unshielded cabling.
- ❑ 1/2.5/5Gbps ports: Standard TIA/EIA 568-A-compliant Category 5 or TIA/EIA 568-B-compliant Enhanced Category 5 (Cat 5e) unshielded cabling.
- ❑ 10Gbps ports: Standard TIA/EIA 568-C-compliant Category 6a unshielded cabling.

Cabling Ethernet Copper Ports

Observe the following guidelines when connecting Ethernet copper cables to the ports on the switch:

- ❑ The connectors on the cables should fit snugly into the ports, and the tabs should lock the connectors into place.
- ❑ The default speed setting for the ports is Auto-Negotiation. This setting is appropriate for ports connected to network devices that also support Auto-Negotiation.

- ❑ The ports must be set to Auto-Negotiation, the default setting, to operate at 1000Mbps or higher.
- ❑ The ports support half- and full-duplex at 10Mbps or 100Mbps.
- ❑ The ports support only full-duplex at 1000Mbps or higher.
- ❑ Do not attach cables to ports of static or LACP port trunks until after you configure the trunks on the switch. Otherwise, the ports will form network loops that can adversely affect network performance.
- ❑ PoE is enabled by default on the ports on PoE+ and PoE++ switches.



Caution: Do not connect or disconnect copper cables from PoE++ devices (Class 5, 40W or higher) when the GS980MX/10HSm Switch is powered on. It might damage the switch. Before cabling PoE++ devices on the GS980MX/10HSm Switch, do one of the following:

- Power off the switch, or:
- Disable PoE on the ports with the NO POWER-INLINE ENABLE command. After cabling the ports, activate it again with the POWER-INLINE ENABLE command.

Installing SFP+ Transceivers

Here are general installation guidelines:

- ❑ You can install SFP transceivers while the switch is powered on.
- ❑ For a list of supported transceivers, refer to the product's data sheet on the Allied Telesis web site at www.alliedtelesis.com.
- ❑ The operational specifications and fiber optic cable requirements are included with the transceivers.
- ❑ Install the transceivers before connecting their fiber optic cables.
- ❑ Fiber optic transceivers are dust sensitive. Always keep the dust cover in the optical ports when a fiber optic cable is not installed.
- ❑ Unnecessary removal and insertion of transceivers can lead to premature failures.



Warning: Transceivers can be damaged by static electricity. Be sure to observe all standard electrostatic discharge (ESD) precautions, such as wearing an antistatic wrist strap, to avoid damaging the devices. 
E86

To install SFP+ transceivers, perform the following procedure:

1. To install a transceiver in a top port, position it with the Allied Telesis label facing up. To install it in a bottom port, position it with the label facing down.

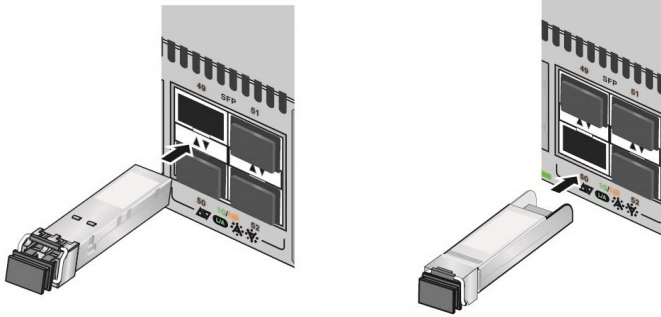

2. Slide the transceiver into the port until it clicks into place.
To attach the fiber optic cable to the transceiver, continue with the next step. Otherwise, repeat steps 1 and 2 to install the remaining transceivers in the switch.
3. Remove the dust cover from the transceiver.
4. Connect the fiber optic cable to the transceiver. The connector should fit snugly into the port, and the tab should lock the connector into place.
5. Repeat this procedure to install additional transceivers.
6. Go to “Powering On the Switch” next.

Powering On the Switch



Warning: Power cord is used as a disconnection device. To de-energize equipment, disconnect the power cord.

⚡ E3

1. Install the power cord retaining clip on the AC power connector on the rear panel of the switch, and raise the clip.

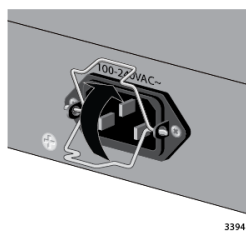
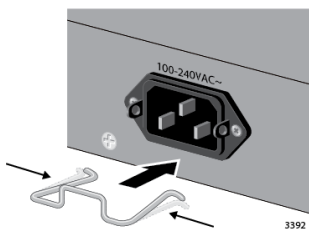

2. Connect the power cord to the connector and lower the retaining clip to secure the power cord.

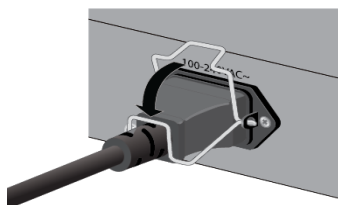
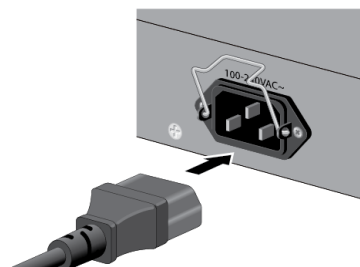

3. Plug the other end of the power cord into an appropriate AC power source.

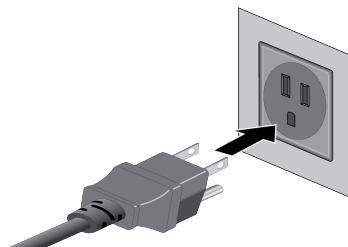

4. Wait two minutes for the switch to initialize its management software.
5. Verify that the POWER LED is green. If the LED is OFF, see “Troubleshooting” on page 26.

LEDs

Ethernet Copper Port LEDs

The Ethernet copper port LEDs on the switches are described here.

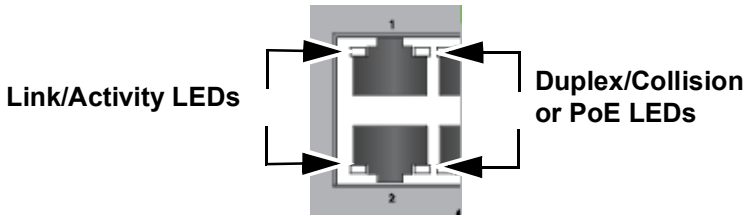

Link/Activity LEDs (Left LED)	
Solid Green	The port has established a 1Gbps or 1/2.5/5Gbps link to a network device.
Flashing Green	The port is transmitting or receiving packets at 1Gbps or 1/2.5/5Gbps.
Solid Amber	The port has established a 100Mbps link to a network device.
Flashing Amber	The port is transmitting or receiving packets at 100Mbps.
Off	Possible causes of this state are listed here: <ul style="list-style-type: none"> - The port has not established a link with another network device. - The LEDs are turned off. To turn on the LEDs, use the eco-friendly button.
Duplex/Collision LEDs - GS980MX/28 and GS980MX/52 Switches (non-PoE models)	
Solid Green	The port is operating in full-duplex mode.
Solid Amber	The port is operating in half-duplex mode.
Flashing Amber	The port is encountering collisions in half-duplex mode.

PoE LEDs - GS980MX/10HSm, GS980MX/28PSm, and GS980MX/52PSm Switches (PoE models)	
Solid Green	The port is delivering power to a powered device.
Solid Amber	The switch has shut down PoE on the port because of a fault condition.
Flashing Amber	The switch has detected a powered device on the port but cannot supply power to it because it is already providing its maximum power to other devices. Refer to “PoE+ and PoE++ Power Budgets” on page 5.
Off	This LED state can result from the following conditions: <ul style="list-style-type: none"> - The port is not connected to a powered device or the device is powered off. - The port is disabled in the management software. - PoE is disabled on the port. - The LEDs are turned off. To turn on the LEDs, use the eco-friendly button.

SFP+ Port LEDs

The SFP+ port LEDs are described here.

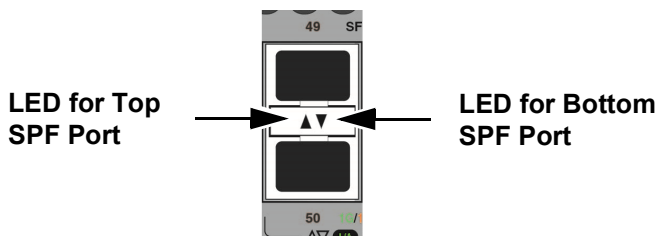

Solid green	The port has established a 10Gbps link to a network device.
Flashing green	The port is transmitting or receiving packets at 10Gbps.
Solid amber	The port has established a 1Gbps link to a network device.
Flashing amber	The port is transmitting or receiving packets at 1Gbps.

Off	<p>Possible causes of this state are listed here:</p> <ul style="list-style-type: none">- The SFP+ transceiver port is empty.- The SFP+ transceiver has not established a link with another network device.- A non-supported module is installed.- The LEDs are turned off. To turn on the LEDs, use the eco-friendly button.
-----	--

Starting a Local Management Session

This procedure explains how to start local management sessions on the switch. You perform local management sessions by connecting your computer to the Console port on the front panel. The switch does not need an IP address for local management sessions.

Local management sessions require a management cable. If your workstation has a DB-9 connector, you can use the cable that comes with the switch. It is two meters long, with an RJ-45 connector that connects to the Console port and a DB-9 connector that connects to your computer. See “Unpacking the Switches” on page 8.

If your computer does not have a DB-9 connector, such as laptop computer, Allied Telesis offers the VT-Kit3 management cable for local management sessions. It has a USB-A male connector that connects to a USB port on your computer. The VT-Kit3 management cable and its software are sold separately.

To start a local management session with the management cable that comes with the switch, perform the following procedure:

1. Connect the RJ-45 end of the management card to the Console port on the management panel.
2. Connect the other end of the cable to an RS-232 port on a terminal or personal computer with a terminal emulation program.
3. Configure the VT-100 terminal or terminal emulation program as follows:
 - Default baud rate: 9600 bps (The baud rates of the Console port are 9600, 19200, 38400, 57600, and 115200 bps.)
 - Data bits: 8
 - Parity: None
 - Stop bits: 1
 - Flow controller: None

4. Press Enter. You are prompted for a user name and password.
5. Enter the default user name and password. They are “manager” and “friend” (without quotes), respectively. The user name and password are case sensitive. The local management session starts when the User Exec mode prompt is displayed: `awplus>`.

For more information, refer to the *Software Reference for GS980MX Series Switches, AlliedWare Plus Operating System* from www.alliedtelesis.com/us/en/services-support.

Disabling the VCStack Feature

The SFP+ S1 and S2 ports can function either as regular Ethernet SFP+ ports or as stacking ports for the VCStack feature. At their default settings, the SFP+ S1 and S2 ports are VCStack stacking ports. To use them as regular Ethernet SFP+ ports, you have to disable the VCStack feature. For instructions, perform the following procedure:

1. Start a local management session. Refer to “Starting a Local Management Session” on page 24.

2. Enter the commands in bold:

```
awplus> enable
awplus# configure terminal
Enter configuration commands, one per line. End
with CNTL/Z.
awplus(config)# no stack 1 enable
```

3. At the confirmation prompt, type **Y** for yes to disable VCStack,
4. Enter the commands in bold:

```
awplus(config)# exit
awplus# write
Building configuration ...
{OK}
awplus# reboot
```

5. Wait two minutes for the switch to start the management software. The switch is now in standalone mode. The SFP+ S1 and S2 ports are now regular Ethernet ports.
6. You can now cable the SFP+ S1 and S2 transceiver ports.

Troubleshooting

Problem: All port and system LEDs are off, and the fan has stopped.

Solutions: The unit is not receiving power. Try the following:

- ❑ Verify that the power cord is securely connected to the power source and the AC connector on the back panel of the switch.
- ❑ Verify that the power outlet has power by connecting another device to it.

Problem: All of the port LEDs are off even though the ports are connected to active network devices.

Solution: The switch might be operating in the low power mode. To toggle on the LEDs, press the eco-friendly button on the front panel of the switch. You can also toggle the LEDs off and on with the ECOFRIENDLY LED and NO ECOFRIENDLY LED commands in the command line interface.

Problem: A LINK/ACT LED is off for a Ethernet copper port that is connected to an active network device.

Solutions: The port is unable to establish a link to a network device. Try the following:

- ❑ Verify that the network device connected to the port is powered on and is operating properly.
- ❑ Verify that the port is connected to the correct Ethernet copper cable.

Problem: The LINK/ACT LED is off for an SFP+ transceiver that is connected to an active network device.

Solutions: The fiber optic port on the transceiver is unable to establish a link to a network device. Try the following:

- ❑ Verify that the fiber optic cable is securely connected to the port on the transceiver and to the port on the remote network device.
- ❑ Check that the transceiver is fully inserted in the slot.

Problem: A port on a PoE switch is not providing power to a powered device.

Solutions: Try the following:

- ❑ Check the port's PoE LED. Refer to "Ethernet Copper Port LEDs" on page 22. If the LED is flashing amber, the switch cannot support additional PoE devices because it is already providing its maximum power to other devices. The maximum

PoE budgets for powered devices are listed in “PoE+ and PoE++ Power Budgets” on page 5.

- ❑ For powered devices of Classes 0 to 4 (Types 1 to 3 up to 30W), review their documentation to confirm that they support Mode A (MDI-x) of the IEEE 802.3at standard and that they use pins 1, 2, 3, and 6 on the RJ-45 port to receive power.
- ❑ For powered devices of Classes 5 and 6 (Type 3 up to 60W) and Classes 7 and 8 (Type 4 up to 75W/90W), review their documentation to confirm they support Mode A (MDI-x) and Mode B (MDI-x, MDI).

Copyright © 2022 Allied Telesis, Inc.

All rights reserved. No part of this publication may be reproduced without prior written permission from Allied Telesis, Inc.

Allied Telesis, VCStack, and the Allied Telesis logo are trademarks of Allied Telesis, Incorporated. CentreCOM is a registered trademark of Allied Telesis, Incorporated. All other product names, company names, logos or other designations mentioned herein are trademarks or registered trademarks of their respective owners.

Allied Telesis, Inc. reserves the right to make changes in specifications and other information contained in this document without prior written notice. The information provided herein is subject to change without notice. In no event shall Allied Telesis, Inc. be liable for any incidental, special, indirect, or consequential damages whatsoever, including but not limited to lost profits, arising out of or related to this manual or the information contained herein, even if Allied Telesis, Inc. has been advised of, known, or should have known, the possibility of such damages.