

Fast Ethernet Switches

AT-8118

AT-8124XL

AT-8126XL



Installation Guide

Copyright © 1998-1999 Allied Telesyn International, Corp.
960 Stewart Drive Suite B, Sunnyvale, CA 94086 USA

All rights reserved. No part of this publication may be reproduced without prior written permission from Allied Telesyn International, Corp.

CentreCom is a registered trademark of Allied Telesyn International, Corp.

All other product names, company names, logos or other designations mentioned herein are trademarks or registered trademarks of their respective owners.

Allied Telesyn International, Corp. reserves the right to make changes in specifications and other information contained in this document without prior written notice. The information provided herein is subject to change without notice. In no event shall Allied Telesyn International, Corp. be liable for any incidental, special, indirect, or consequential damages whatsoever, including but not limited to lost profits, arising out of or related to this manual or the information contained herein, even if Allied Telesyn International, Corp. has been advised of, known, or should have known, the possibility of such damages.

Radiated Energy

Standards: This product meets the following standards

U.S. Federal Communications Commission

Radiated Energy

Note: This equipment has been tested and found to comply with the limits for a Class A digital device pursuant to Part 15 of the FCC Rules. These limits are designed to provide reasonable protection against harmful interference when the equipment is operated in a commercial environment. This equipment generates, uses, and can radiate radio frequency energy and, if not installed and used in accordance with this instruction manual, may cause harmful interference to radio communications. Operation of this equipment in a residential area is likely to cause harmful interference in which case the user will be required to correct the interference at his own expense.

Note: Modifications or changes not expressly approved by the manufacturer or the FCC can void your right to operate this equipment.

Canadian Department of Communications

This Class A digital apparatus meets all requirements of the Canadian Interference-Causing Equipment Regulations.

Cet appareil numérique de la classe A respecte toutes les exigences du Règlement sur le matériel brouilleur du Canada.

RFI Emission

EN55022 Cl a s 1

WARNING: In a domestic environment this product may cause radio interference in which case the user may be required to take adequate measures. 2

Immunity

EN5008 2 - 3

IMPORTANT: Appendix A contains translated safety statements for installing this equipment. When you see the symbol, go to Appendix A for the translated safety statement in your language.

WICHTIG: Anhang A enthält übersetzte Sicherheitshinweise für die Installation dieses Geräts. Wenn Sie das Symbol sehen, schlagen Sie in Anhang A den übersetzten Sicherheitshinweis in Ihrer Sprache nach.

VIGTIGT: Tillæg A indeholder oversatte sikkerhedsadvarsler, der vedrører installation af dette udstyr. Når De ser symbolet, skal De slå op i tillæg A og finde de oversatte sikkerhedsadvarsler i Deres eget sprog.

BELANGRIJK: Appendix A bevat vertaalde veiligheidsopmerkingen voor het installeren van deze apparatuur. Wanneer u de symbolen ziet, raadpleeg Appendix A voor vertaalde veiligheidsinstructies in uw taal.

IMPORTANT : L'annexe A contient les instructions de sécurité relatives à l'installation de cet équipement. Lorsque vous voyez le symbole, reportez-vous à l'annexe A pour consulter la traduction de ces instructions dans votre langue.

TÄRKEÄÄ: Liite A sisältää tämän laitteen asentamiseen liittyvät käännetyt turvaohjeet. Kun näet symbolin, katso käännettyä turvaohjetta liitteestä A.

IMPORTANTE: l'Appendice A contiene avvisi di sicurezza tradotti per l'installazione di questa apparecchiatura. Il simbolo, indica di consultare l'Appendice A per l'avviso di sicurezza nella propria lingua.

VIKTIG: Tillegg A inneholder oversatt sikkerhetsinformasjon for installering av dette utstyret. Når du ser symbolet, åpner du til Tillegg A for å finne den oversatte sikkerhetsinformasjonen på ønsket språk.

IMPORTANTE: O Anexo A contém advertências de segurança traduzidas para instalar este equipamento. Quando vir o símbolo, leia a advertência de segurança traduzida no seu idioma no Anexo A.

IMPORTANTE: El Apéndice A contiene mensajes de seguridad traducidos para la instalación de este equipo. Cuando vea el símbolo, vaya al Apéndice A para ver el mensaje de seguridad traducido a su idioma.

OBS! Bilaga A innehåller översatta säkerhetsmeddelanden avseende installationen av denna utrustning. När du ser symbolet, skall du gå till Bilaga A för att läsa det översatta säkerhetsmeddelandet på ditt språk.

Table of Contents

Preface	Preface-i
Purpose of This Guide	Preface-i
How This Guide is Organized	Preface-i
Document Conventions	Preface-ii
Where to Find Related Guides	Preface-iii
Chapter 1	
Hardware Description	1-1
The Base Switch Models	1-1
Hardware Features	1-3
Network Management Features	1-4
Switching Modes	1-5
Physical Description	1-6
Port LEDs	1-7
RS232 Connector	1-7
Reset Button	1-7
System LEDs	1-8
AC Power Connector	1-8
The Media Dependent Adapters (MDAs)	1-9
Where to Go Next	1-11
Chapter 2	
Installation	2-1
Verifying Your Switch Package Contents	2-1
Safety Information	2-2
Preparing the Site	2-3
Installing the Switch on the Desktop	2-4
Installing the Switch in the Rack	2-5
Installing the Media Dependent Adapters (MDAs)	2-7
MDA Package Contents	2-7
MDA Installation	2-7
Setting Up The Terminal for Local Management Using Omega	2-10
Connecting Devices to the Switch	2-11
Where to Go Next	2-12

Chapter 3

Troubleshooting	3-1
At the First Sign of a Problem	3-1
Network Cabling Problems	3-2
Calling Technical Support	3-3
How the Switch Reports Problems	3-4
Common Problems	3-5
Link/Receive LED on Any Port is OFF	3-5
Power LED is OFF	3-6
Fault LED is ON	3-6

Chapter 4

Switch Configurations	4-1
The Switch in a Standalone Configuration	4-1
The Switch in Workgroup Configurations	4-2

Appendix A

Translated Safety Information	A-1
--	-----

Appendix B

Technical Specifications	B-1
---------------------------------------	-----

Appendix C

Switch Default Settings	C-1
--------------------------------------	-----

Preface

Purpose of This Guide

This guide is written for network administrators who are responsible for installing and maintaining the AT-8118, AT-8124XL, and AT-8126XL switches.

How This Guide is Organized

This guide consists of the following sections:

Chapter 1, **Hardware Description**, describes the features and functions of the switches and the media dependent adapters (MDAs).

Chapter 2, **Installation**, describes the procedures for installing the switch and the MDAs, connecting a terminal for local management, and connecting devices to the switch.

Chapter 3, **Troubleshooting**, describes how to troubleshoot the switch in case of problems.

Chapter 4, **Switch Configurations**, presents illustrations of several switch configurations.

Appendix A, **Translated Safety Information**, contains translations of the safety warnings documented throughout this guide.

Appendix B, **Technical Specifications**, presents in tabular form switch and MDA specifications.

Appendix C, **Switch Default Settings**, lists the switch's default software settings as configured by the factory.

Index, at the end of this guide, is according to subject matter.

Document Conventions

The conventions used in this guide are as follows:

- Notes:

Note

A note provides additional information.

- Warnings:



Warning

A warning indicates that performing or omitting a specific action may result in bodily injury.

- Cautions:



Caution

A caution indicates that performing or omitting a specific action may result in equipment damage or loss of data.

Where to Find Related Guides

Allied Telesyn wants our customers to be well informed by providing the most up-to-date and most easily accessible way to find our guides and other technical information.

Visit our website at: www.alliedtelesyn.com and download the following guide:

AT-S21 Software Management User's Guide, 613-10727-00

AT-8118, AT-8124XL, and AT-8126XL Installation Guide,
613-10726-00

The following guides are shipped with their respective products:

AT-8118, AT-8124XL, and AT-8126XL Quick Install Guide,
613-10729-00

**AT-8118, AT-8124XL, and AT-8126XL Translated Safety
Information Booklet**, 613-10728-00

AT-A10, AT-A11, AT-A20, and AT-A21 Quick Install Guide,
613-10742-00

Chapter 1

Hardware Description

This chapter describes the hardware features of the following products:

- ❑ The base switch models: AT-8118, AT-8124XL, and AT-8126XL
- ❑ The uplink options, also called media dependent adapters (MDAs): AT-A10, AT-A11, AT-A20, and AT-A21

The Base Switch Models

The AT-8118, AT-8124XL, and AT-8126XL switches are standalone managed Fast Ethernet switches that provide 16 or 24 10Base-T/100Base-TX station ports. The AT-8118 and AT-8126XL additionally provide uplink options of up to two 100Base-TX or 100Base-FX (SC, MT-RJ or VF-45) ports for backbone connectivity

They are primarily intended for connections to the desktop as well as workgroup applications. The AT-8118 and AT-8126XL, when populated with optional uplink ports, implement direct high-speed server and backbone connections. Half- or full-duplex capability on all ports eliminate collisions and provide up to 200 Mbps of bandwidth per port to servers, routers, and other switches. The auto-negotiating ports allow connectivity between devices operating at 10 Mbps and 100 Mbps speeds.

With built-in management, the switches provide seamless management capability such as SNMP and web-based management.

Figure 1-1 shows the AT-8118, a 16-port model with two slots for uplink options

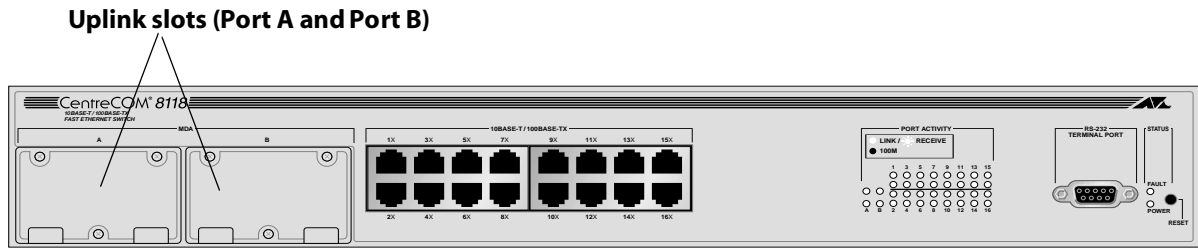

Figure 1-1 The AT-8118 Switch (Front)

Figure 1-2 shows the AT-8124XL, a 24-port model with no uplink options.

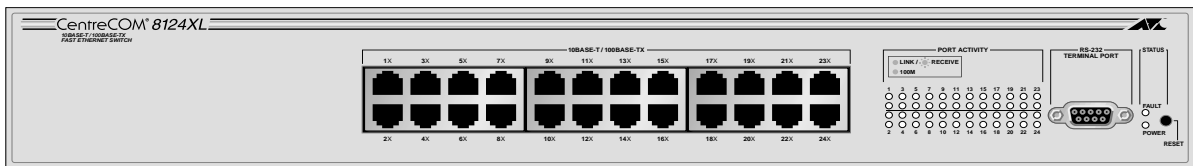

Figure 1-2 The AT-8124XL Switch (Front)

Figure 1-3 shows the AT-8126XL, a 24-port model with two uplink options.

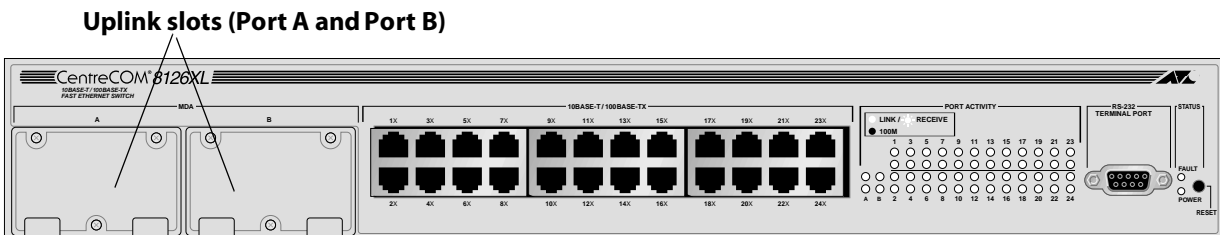

Figure 1-3 The AT-8126XL Switch (Front)

Hardware Features

Table 1-1 summarizes the basic features of each switch model.

Table 1-1 Switch Models

Model	Port Description
AT-8124XL	Twenty-four 10Base-T/100Base-TX ports
AT-8118	<ul style="list-style-type: none"> <input type="checkbox"/> Sixteen 10Base-T/100Base-TX ports <input type="checkbox"/> Two slots, Port A and Port B, for optional uplink connectivity to either 100Base-TX or 100Base-FX backbones
AT-8126XL	<ul style="list-style-type: none"> <input type="checkbox"/> Twenty-four 10Base-T/100Base-TX ports <input type="checkbox"/> Two slots, Port A and Port B, for optional uplink connectivity to either 100Base-TX or 100Base-FX backbones

The switches have the following common hardware features:

- Half- or full-duplex operation on all switched ports delivering up to 200 Mbps of bandwidth to servers, routers, or other switches
- Auto-negotiation on all 10Base-T/100Base-TX ports for speed and duplex in compliance with IEEE 802.3U specifications
- Non-blocking, clear-channel architecture delivers wire-speed switching and up to 2.7 Gbps aggregate bandwidth for exceptional performance
- Shared memory architecture per 4 ports to support 256 maximum-size packets
- Store-and-forward switching mode, or, for 100 Mbps ports only, fragment-free cut-through switching mode
- Packet buffer memory of 3.0 MB for the AT-8118, 3.5 MB for the AT-8124XL, and 3.5 MB for the AT-8126XL
- 16K MAC addresses per switch; automatic aging
- 8 MB DRAM and 2 MB Flash memory for software upgrades
- In-band Telnet capability for remote switch management
- Pre-installed management software, Omega (model AT-S21)

- ❑ Out-of-band capability with RS232 connector for local switch management
- ❑ Port-based Virtual LANs (VLANs)
- ❑ BootP and DHCP support

Network Management Features

The following lists the switches' network management features.

- ❑ SNMP Management Information Base (MIB) II, SNMP MIB extensions, Bridging MIB (RFC 1493), and Telnet support deliver comprehensive in-band management
- ❑ Local Omega, a menu-based management console, provides detailed out-of-band management
- ❑ Management through a web browser
- ❑ IEEE 802.1d Spanning Tree Protocol support for redundant backbone connections and loop-free networks simplifies configuration and improves fault tolerance

For detailed information concerning software and management features, see the **AT-S21 Software Management User's Guide** located on Allied Telesyn's website at **www.alliedtelesyn.com**.

Switching Modes

Each switch port has the following user-selectable switching modes:

- Store-and-forward (default)
- Fragment-free cut-through for 100 Mbps ports

Network administrators can configure the sending port with the appropriate switching mode to optimize performance and enable full-error checking. The modes reduce network bottlenecks by offering low latency wire rate switching for the port.

With the store and forward method, the port waits to receive an entire packet before forwarding it to its destination. This method ensures that packets being forwarded are free of errors. The store and forward mode (default) is automatic when data is exchanged between 10Base-T and 100Base-TX ports.

With the cut-through method (for 100 Mbps ports only), the port starts to forward the packet once the packet has exceeded the smallest size (64 bytes), therefore filtering fragment frames or runts (frames less than 64 bytes). This method provides low latency for forwarding frames and also provides some network error protection.

Physical Description

The switches have the following major front panel components:

- ❑ 16 or 24 Ethernet 10Base-T/100Base-TX unshielded twisted pair (RJ45) ports
- ❑ RS232 (DB9-F) connector for out-of-band management (Omega Local)
- ❑ Reset button
- ❑ System and port status LEDs
- ❑ Two slots, Port A and Port B, for optional 100Base-TX or 100Base-FX (SC, MT-RJ or VF-45) backbone connectivity on the AT-8118 or AT-8126XL

Refer to Figure 1-4 for the location of front panel components.

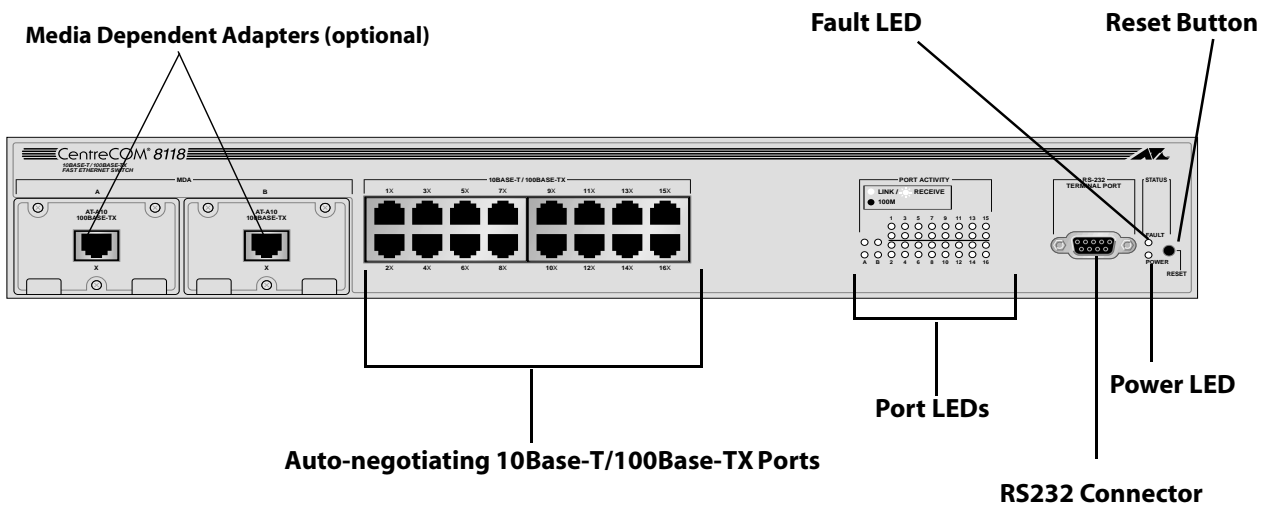

Figure 1-4 The AT-8118 Switch With Fully-Populated Uplink Slots

Port LEDs

Each switch port and uplink port is associated with two LEDs indicating the following:

- ❑ Valid physical link with a device and packets being received, as indicated by the top row of LEDs
- ❑ Speed of transmission, 10 Mbps or 100 Mbps, as indicated by the bottom row of LEDs

Figure 1-5 is a closeup of the AT-8118's port LEDs. (The AT-8126XL is similar to the AT-8118. The AT-8124XL does not have Uplink Port LEDs.)

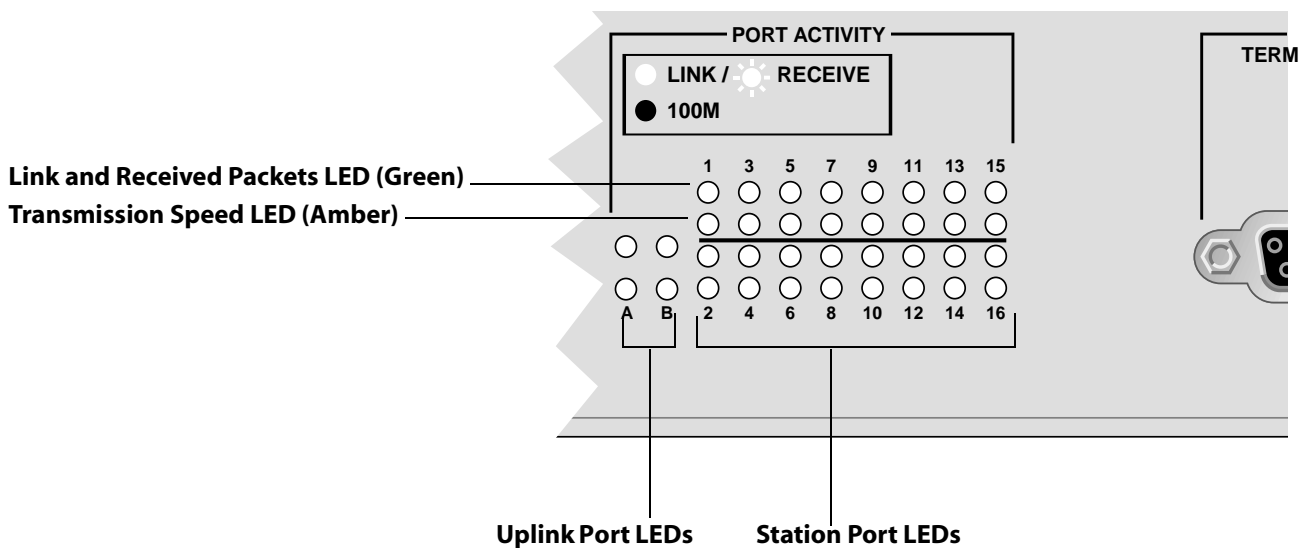

Figure 1-5 Port LEDs

The LEDs are further described in Chapter 2, Table 2-1 on page 2-4.

RS232 Connector

The RS232, DB-9 female connector provides out-of-band local management via a VT100 terminal or MS-Windows' VTERM terminal emulation using a straight-through cable.

Reset Button

The Reset button is used to reset the switch with power still applied. It is mainly used for diagnostics or resetting switch statistics as recorded by the management software, Omega. You can also reset the switch via the software. Download the **AT-S21 Software Management User's Guide** from the web at www.alliedtelesyn.com for more information.

System LEDs

The switch's system LEDs are Power and Fault. They indicate the overall operating status of the switch.

More details on the LEDs are shown in Table 2-1, **Switch LEDs**, on page 2-4.

AC Power Connector

The switch has a single power supply in the rear panel, which has autoswitch AC inputs. The input voltage range is from 100-240 VAC, 50/60 Hz.

The Media Dependent Adapters (MDAs)

AlliedTelesyn offers optional MDAs, shown in Figure 1-6. You may install any combination of uplink options in Port A or Port B on the AT-8118 or AT-8126XL. Table 1-2 describes the MDAs.

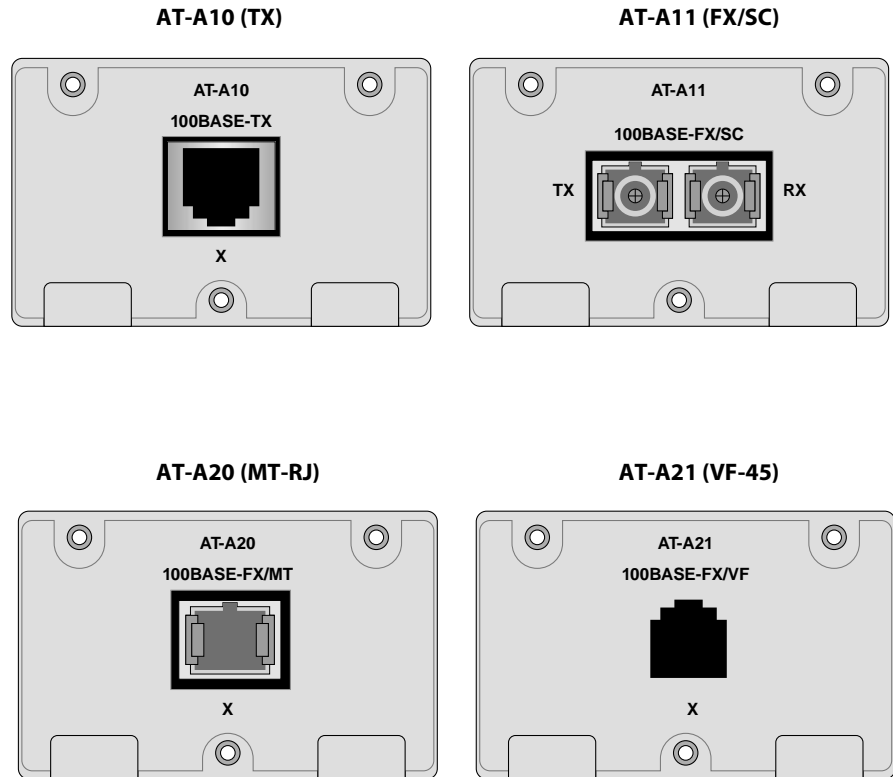

Figure 1-6 Media Dependent Adapter Faceplates

Table 1-2 Media Dependent Adapter Features

Adapter	Connector Type	Description
AT-A10	RJ45	<ul style="list-style-type: none"> ❑ Auto-negotiating 10Base-T/100Base-TX Fast Ethernet port ❑ Auto-negotiating 10/100 Mbps and duplex mode ❑ Maximum segment length: 330 ft (100 m), Category 5 UTP cable
AT-A11	Fiber SC	<ul style="list-style-type: none"> ❑ 100Base-FX Fast Ethernet port ❑ Default transmission speed fixed at 100 Mbps ❑ Multimode SC fiber connector ❑ Auto-negotiating duplex mode (100 Mbps only) ❑ Maximum segment length: 1.25 mi (2 km), 50/125- and 62/5/125-micron multimode fiber cable for full-duplex; 1,351 ft (412 m) for half-duplex
AT-A20	Fiber MT-RJ	<ul style="list-style-type: none"> ❑ 100Base-FX Fast Ethernet port ❑ Default transmission speed fixed at 100 Mbps ❑ Multimode MT-RJ fiber connector ❑ Auto-negotiating duplex mode (100 Mbps only) ❑ Maximum segment length: 1.25 mi (2 km), 50/125- and 62/5/125-micron multimode fiber cable for full-duplex; 1,351 ft (412 m) for half-duplex
AT-A21	Fiber VF-45	<ul style="list-style-type: none"> ❑ 100Base-FX Fast Ethernet port ❑ Default transmission speed fixed at 100 Mbps ❑ Multimode VF-45 fiber connector ❑ Auto-negotiating duplex mode (100 Mbps only) ❑ Maximum segment length: 1.25 mi (2 km), 50/125- and 62/5/125-micron multimode fiber cable for full-duplex; 1,351 ft (412 m) for half-duplex

Like the switch's station ports, the uplink ports are associated with two LEDs that indicate port speed and valid physical link. See Figure 1-5 for the location of the Uplink Ports' LEDs. The LEDs are further described in Chapter 2, Table 2-1 on page 2-4.

Where to Go Next

Proceed to Chapter 2 for details on how to install the switch and the MDAs.

Chapter 2

Installation

This chapter describes the following procedures:

- Switch installation on the desktop or in the 19-inch rack
- MDA installation
- Terminal connection for local management and initial setup
- Device installation

Verifying Your Switch Package Contents

Make sure the following hardware components are included in your switch package. If any of the following items are missing or damaged, contact your sales representative.

- One AT-8118, AT-8124XL, or AT-8126XL switch
- Two mounting brackets
- Six flathead Phillips screws
- Power cord (Americas, EC, and UK only)
- One AT-8118, AT-8124XL, and AT-8126XL Quick Install Guide
- Translated Safety Information Booklet
- Warranty card

Safety Information

Refer to Appendix A for translated safety statements in your language.



Warning
Electric Shock Hazard

To prevent ELECTRIC shock, do not remove cover. No user-serviceable parts inside. This unit contains HAZARDOUS VOLTAGES and should only be opened by a trained and qualified technician. To avoid the possibility of ELECTRIC SHOCK disconnect electric power to the product before connecting or disconnecting the LAN cables.

8



Laser

Warning Class 1 Laser product. 6



Laser

Warning Do not stare into the Laser beam. 7



Caution
Lightning Danger

DO NOT WORK on equipment or CABLES during periods of LIGHTNING ACTIVITY. 9



Caution
Electrical—Type Class 1 Equipment

This Equipment Must Be Earthed. Power plug must be connected to a properly wired earth ground socket outlet. An improperly wired socket outlet could place hazardous voltages on accessible metal parts. 11



Caution
Electrical—Cord Notice

Use power cord, maximum 4.5 meters long, rated 5 amp minimum, 250V, made of HAR cordage molded IEC 320 connector on one end and on the other end a plug approved by the country of end use.

12



Caution

Air vents must not be blocked and must have free access to the room ambient air for cooling. 13



Caution
Operating Temperature

This product is designed for a maximum ambient temperature of **40° C.** 14



Caution

All Countries: Install product in accordance with local and National Electrical Codes. 15

Preparing the Site

Make sure that you follow common sense installation site requirements and observe the following:

- Make sure that the switch's power is accessible and cables can be connected easily.
- Cabling must be away from sources of electrical noise such as radios, transmitters, broadband amplifiers, power lines, and fluorescent fixtures.
- Air flow around the switch and through its vents on the side and rear cannot be restricted.
- If you are desk mounting the switch, make sure it is placed on a level, secure desktop.
- Do not place objects on top of the switch.
- Do not expose the switch to moisture or water.
- Make sure it is in a dust-free environment.
- Use dedicated power circuits or power conditioners to supply reliable electrical power to the network devices.

Installing the Switch on the Desktop

1. Locate a level, secure surface for the switch.
2. Apply power to the switch as follows:



Caution

The power cord is used as a disconnect device. To de-energize equipment, disconnect the power cord. ⚡ 10

Attach the power cord to the unit and plug it in the wall outlet. Verify that the Power LED lights green. See Table 2-1.

As power is applied to the switch, the Fault LED flashes as the switch runs internal self testing.

Table 2-1 Switch LEDs

LED	Color	State	Description
Power (system)	Green	On	The switch is receiving power, voltage is within the acceptable range, and the power supply is working.
Fault (system)	Red	On	The switch or management software is malfunctioning.
		Flashing	The switch is booting, running diagnostics, writing images to FLASH, or transferring files via XMODEM.
		Off	Normal operation.
Link/Receive (port, top row)	Green	On	There is a physical link with a device.
		Flashing	The port is receiving packets.
		Off	No link.
100 M (port, bottom row)	Amber	On	The port is operating at 100 Mbps.
		Off	The port is operating at 10 Mbps.

If the Power LED does not light green, see Chapter 3, **Troubleshooting**, for further information.

3. Connect the data cables, making sure each connection has a good valid link and that the switch is receiving packets.

Installing the Switch in the Rack



Caution

Do not use power tools to perform this installation.



To rack mount the unit

1. Remove all cables and power cord from the switch (if previously attached).
2. Remove the snap-on plastic feet, as shown in Figure 2-1.

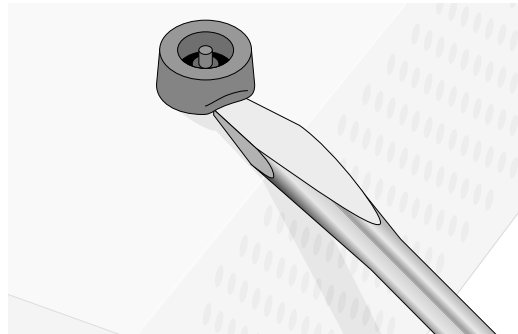

Figure 2-1 Removing the Feet



Caution

Air vents must not be blocked and must have free access to the room ambient air for cooling. 13

3. Attach the rackmounting brackets to each side of the switch, using the 6 flathead screws that came with the switch package.

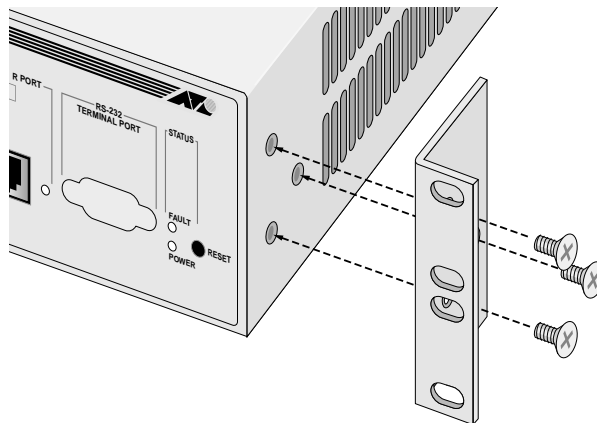

Figure 2-2 Attaching Rackmounting Brackets

4. Mount the switch in the rack using standard screws (not provided).
5. Ensure that there is unrestricted air flow around the switch.
6. Apply power to the unit as follows:



Caution

Power cord is used as a disconnection device. To de-energise equipment disconnect the power cord. *GS* 10

Attach the power cord to the unit and plug it in the wall outlet. Verify that the Power LED lights green. See Table 2-1 on page 2-4.

As power is applied to the switch, the Fault LED flashes as the switch runs internal self testing.

Installing the Media Dependent Adapters (MDAs)

If you have the AT-8118 or AT-8126XL switch, you may order and install one of the following MDAs in any combination:

- The AT-A10 with the 100Base-TX port
- The AT-A11 with the 100Base-FX port (SC)
- The AT-A20 with the 100Base-FX port (MT-RJ)
- The AT-A21 with the 100Base-FX port (VF-45)

These MDAs are installed in either the Port A or Port B slot on the switch. Contact your Allied Telesyn representative for ordering information.

MDA Package Contents

Check your MDA package for the following items:

- One MDA, either the AT-A10, AT-A11, AT-A20 or the AT-A21
- Three Phillips flathead screws
- One AT-A10, AT-A11, AT-A20, and AT-A21 Quick Install Guide
- Warranty card

MDA Installation

You may install the MDAs in any slot position, Port A or Port B.



Caution Lightning Danger

DO NOT WORK on equipment or CABLES during periods of LIGHTNING ACTIVITY. ⚡ 9

1. Disconnect the switch's power cord, if attached.
2. Unscrew the three Phillips flathead screws on the switch's blank faceplate and save for future use. Keep the blank panel attached if the MDA slot is empty.



Caution

Do not remove the MDA blank faceplates if you are not installing MDAs.

3. Unpack the MDA making sure to observe ESD precautions.

The standoff on the MDA guides it correctly into position so that the MDA's 50-pin plug aligns with the 50-pin receptacle on the main board. Refer to Figure 2-3 for the location of the standoff and the 50-pin connector.

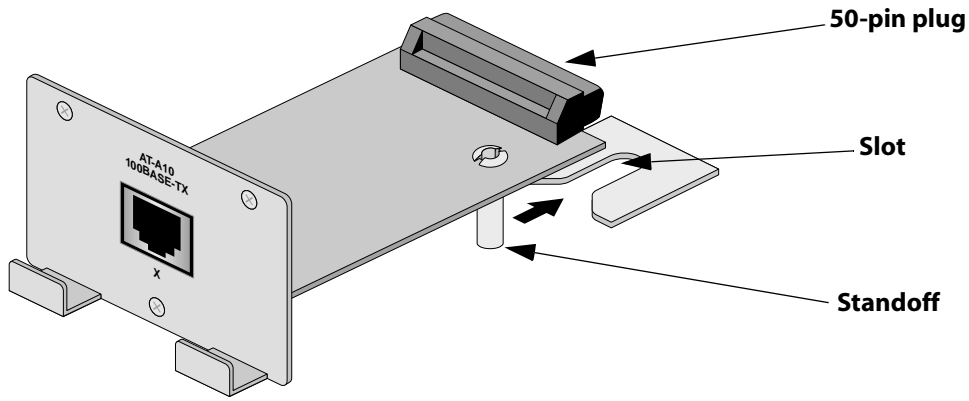

Figure 2-3 Guiding the MDA's Standoff Into Its Slot

4. Slide the MDA into its empty slot making sure that the standoff is aligned properly. See Figure 2-3.
5. Push the MDA into position so that the front panel contacts the front of the switch's chassis. See Figure 2-4.

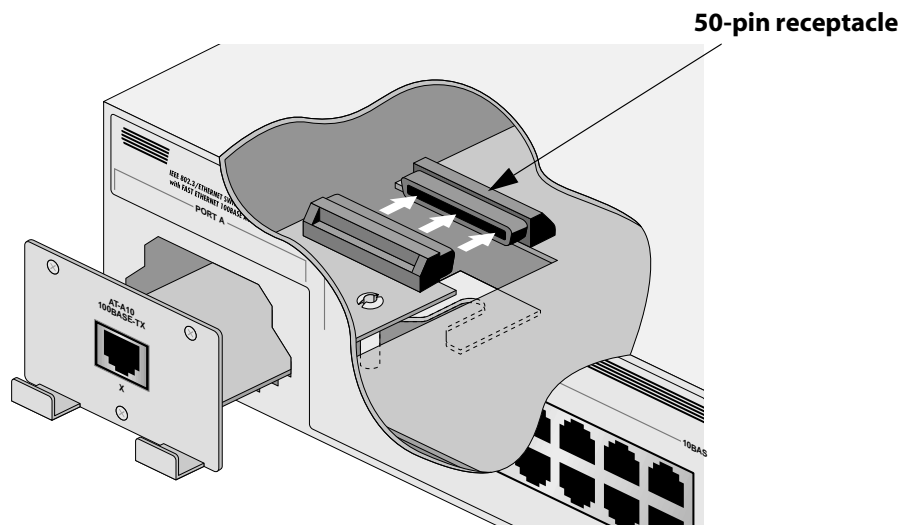

Figure 2-4 Connecting the 50-pin Plug

6. Secure the MDA to the front of the switch with the Phillips flathead screws that came with the MDA package.
7. Apply power to the unit as follows:



Caution

The power cord is used as a disconnect device. To de-energize equipment, disconnect the power cord.  10

Re-attach the power cord to the unit and plug it into the wall outlet. Verify that the Power LED lights green.

8. Connect the data cable. Verify that the uplink's LEDs on the switch's front panel lights green. The LEDs light as described in Table 2-2:

Table 2-2 Uplink Port LEDs

Uplink Port LED (Port A or B)	Color	State	Description
Link/Receive (port, top row)	Green	On	There is a physical link with the device
		Flashing	The port is receiving packets.
100 M (port, bottom row)	Amber	On	The port is operating at 100 Mbps

Setting Up The Terminal for Local Management Using Omega

1. Connect your terminal to the RS232 connector on the switch's front panel. Use an RS232, DB-9 straight-through cable.
2. Access your terminal emulation program, i.e., VT100.
3. Set your terminal emulator to the following:
 - Data bits: **8**
 - Stop bits: **1**
 - Parity: **None**
 - Baud rate: **9600**
4. Press **Return**.

The switch runs diagnostics and shortly displays the Omega main menu.

You are now ready to access the switch's management software, Omega. The software comes with the default settings listed in Appendix C.

If you intend to manage the switch from a remote site, or if you are in a TCP/IP environment, you must first assign an IP address to the switch using local Omega.

For remote management and further details concerning the Omega management software, refer to the **AT-S21 Software Management User's Guide**. Download this guide from the web at www.alliedtelesyn.com.

Connecting Devices to the Switch

The switch supports connectivity with DTEs such as workstations and servers, and also DCEs such as hubs, routers, and other switches. The switch supports devices that operate at fixed speeds, 10 Mbps or 100 Mbps, or auto-negotiating, 10/100 Mbps.

When connecting devices, consider the following:

- ❑ For dedicated 10Base-T connections, use Category 3, 4, or 5 Unshielded Twisted Pair (UTP) cables with maximum length of 330 ft (100 m).
- ❑ For 10Base-T/100Base-TX or dedicated 100Base-TX connections, use Category 5 UTP cables with maximum length of 330 ft (100 m).
- ❑ For 100Base-FX fiber connections, use 50/125- or 62.5/125-micron multimode fiber cables with maximum length of 1,351 ft (412 m) for half-duplex or 1.25 mi (2 km) for full-duplex.
- ❑ Use straight-through cables to connect to workstations and servers.
- ❑ Use crossover cables to connect to hubs, routers, and other switches.

Refer to Chapter 4 for examples of switch applications in a network environment.

Where to Go Next

Now that the switch is operational, you are ready to configure and monitor it.

Download the **AT-S21 Software Management User's Guide** from Allied Telesyn's website at www.alliedtelesyn.com for the information.

Chapter 3

Troubleshooting

This chapter provides information on how to detect and resolve problems with your switch.

At the First Sign of a Problem

Perform the following tasks when you first become aware of a problem with the switch:

- ❑ Make sure the power cord is securely connected and the power voltage is not fluctuating.
- ❑ Check the data cables for secure connections and make sure the device at the other end of a connection is operational.
- ❑ Press the **Reset** button so the switch can run self-diagnostics.
- ❑ Use Omega to read statistics and run diagnostics. Refer to the **AT-S21 Software Management User's Guide** for further details on gathering Ethernet statistics and running diagnostics using the Omega menus.
- ❑ If the management software has failed, check the LEDs to see if the switch continues to forward packets. Then, at a convenient time, reboot the switch by pressing **Reset**; or power ON and OFF the switch by disconnecting and reconnecting the power cord.
- ❑ If problems still persist, for example, the **Fault** LED remains on, call Allied Telesyn's Technical Support or visit Allied Telesyn's website at www.alliedtelesyn.com.

Network Cabling Problems

If you have 100Base-TX (Fast Ethernet), some network problems may be related to exceeding cabling distances. Refer to the standard IEEE 802.3U, Clause 29.3.1.2 on **Worst Case Path Delay Value**. This document specifies that the collision domain diameter must be within the following limits:

- Under 330 ft (100 m) for TX cabling
- Under 1,331.56 ft (412 m) for half-duplex FX cabling

Calling Technical Support

When contacting Allied Telesyn for support on any of its products, provide Technical Support with the following information:

- Model and serial number
- Software version number
- Description of the problem

Refer to Allied Telesyn's website at **www.alliedtelesyn.com** for a list of worldwide Allied Telesyn locations.

How the Switch Reports Problems

The switch detects and processes errors as follows:

- ❑ The LEDs indicate problems with the port and power. Table 3-1 describes the switch LEDs.
- ❑ In a TCP/IP environment, if you have configured the software correctly, the management software triggers an SNMP trap message. As a result, the software then sends traps to alert the network manager when a trigger occurs. This type of software configuration allows the network administrator to proactively monitor their network.

Table 3-1 lists and describes the switch LEDs.

Table 3-1 Switch LEDs

LED	Color	State	Description
Power (system)	Green	On	The switch is receiving power, voltage is within the acceptable range, and the power supply is working.
		Off	No power.
Fault (system)	Red	On	The switch or management software is malfunctioning.
		Flashing	The switch is booting, running diagnostics, writing images to FLASH, or transferring files via XMODEM.
		Off	Normal operation.
Link/Receive (port, top row)	Green	On	There is a physical link with a device.
		Flashing	The port is receiving packets.
		Off	No link.
100 M (port, bottom row)	Amber	On	The port is operating at 100 Mbps.
		Off	The port is operating at 10 Mbps.

Common Problems

Link/Receive LED on Any Port is OFF

This section lists common possible sources of error and actions required to fix them.

This may indicate:

- A loose data cable.
- The device at the other end of the connection is turned OFF.
- The data cable is not wired correctly (straight/crossed) for the device.
- The network administrator manually disabled the port through the software.
- The port's selected transmission mode does not match that of the attached device.

Perform the following steps in sequence; you need not proceed to the next step if the problem is resolved:

1. Make sure the data cables are secure.
2. Make sure the device at the end of the connection is turned ON.
3. Make sure the data cable is wired correctly (straight/crossed) for the device.
4. Logon to Omega if you can and check the port status (`Port status and configuration`<port number> menu).

If the port is Enabled, make sure the transmission speed matches that of the connected device (auto-negotiating, full- or half-duplex).

Refer to the **AT-S21 Software Management User's Guide** to check that the port is Disabled. If the port is Disabled, someone has manually disabled the port through the software for a specific reason. Verify that the reason no longer exists before you enable this port (`Port status and configuration`).

5. Contact Allied Telesyn's Technical Support for help.

Power LED is OFF

If there is no power to the switch, it cannot function.

A **Power** LED that is OFF may indicate:

- A loose power cord.
- Power supply failure, malfunction, or loss of power to the power supply.
- A power supply voltage below acceptable levels.
- A high switch temperature due to fan failure or ambient temperature extreme.

Perform the following steps in sequence; you need not proceed to the next step if the problem is resolved:

1. Secure the power cord to the power source and check the **Power** LED to see if it is ON.
2. Ensure that the voltage is within the required levels in your region.
3. Logon to Omega and run `Diagnostics` if you can (`Administration>Diagnostics`) and record any failures.
4. Contact Allied Telesyn's Technical Support and report the results of the tests.

Fault LED is ON

This might indicate problems with the network management software, such as:

- Unsuccessful software downloads.
- Power-on diagnostics has failed.

Perform the following steps in sequence; you need not proceed to the next step if the problem is resolved:

1. Reset the switch either by:
 - Pressing the **Reset** button on the front panel, or
 - Selecting `Administration>Reset` and restart the system from Omega, if you can.
2. Make sure the RS232 connection from the local terminal or PC to the switch is secure; change the cable if necessary.

If you cannot access `Omega Local` because of a faulty RS232 connection, use `Omega Remote` via Telnet or manage the switch using SNMP until the problem is fixed.

3. Unplug the switch from the power source, then plug it back in again.
4. Try to log on to Omega and run diagnostics (Administration>Diagnostics).
5. Download software using the Administration menu. Refer to the **AT-S21 Software Management User's Guide**, downloaded from **www.alliedtelesyn.com** and follow the procedures in Chapter 4.
6. Contact Allied Telesyn's Technical Support for help.

Chapter 4

Switch Configurations

This chapter provides network configuration examples using the switch models described in this guide.

The Switch in a Standalone Configuration

Figure 4-1 shows the AT-8124XL used as a standalone switch for a group of heavy traffic users. Switching is brought to the desktop either through a single end-station per switch port or through a multi-port hub. A 100 Mbps server is connected to a port, providing end stations high-speed accessibility to its applications.

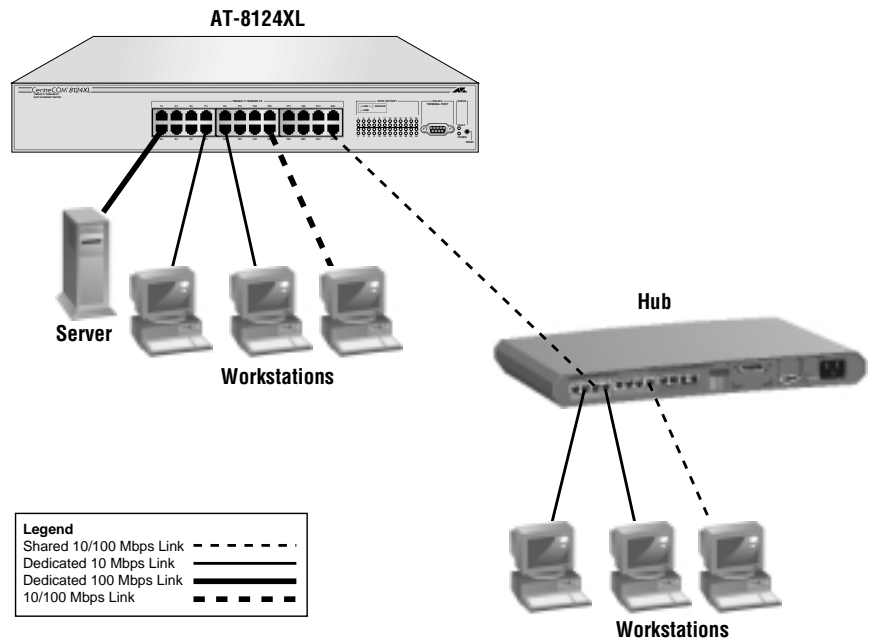

Figure 4-1 The AT-8124XL Switch in Standalone Configuration

The Switch in Workgroup Configurations

Figure 4-2 shows how the different switches fit into a large corporate network with a Fast Ethernet infrastructure. A switch is located on each floor and servers are centralized in one room.

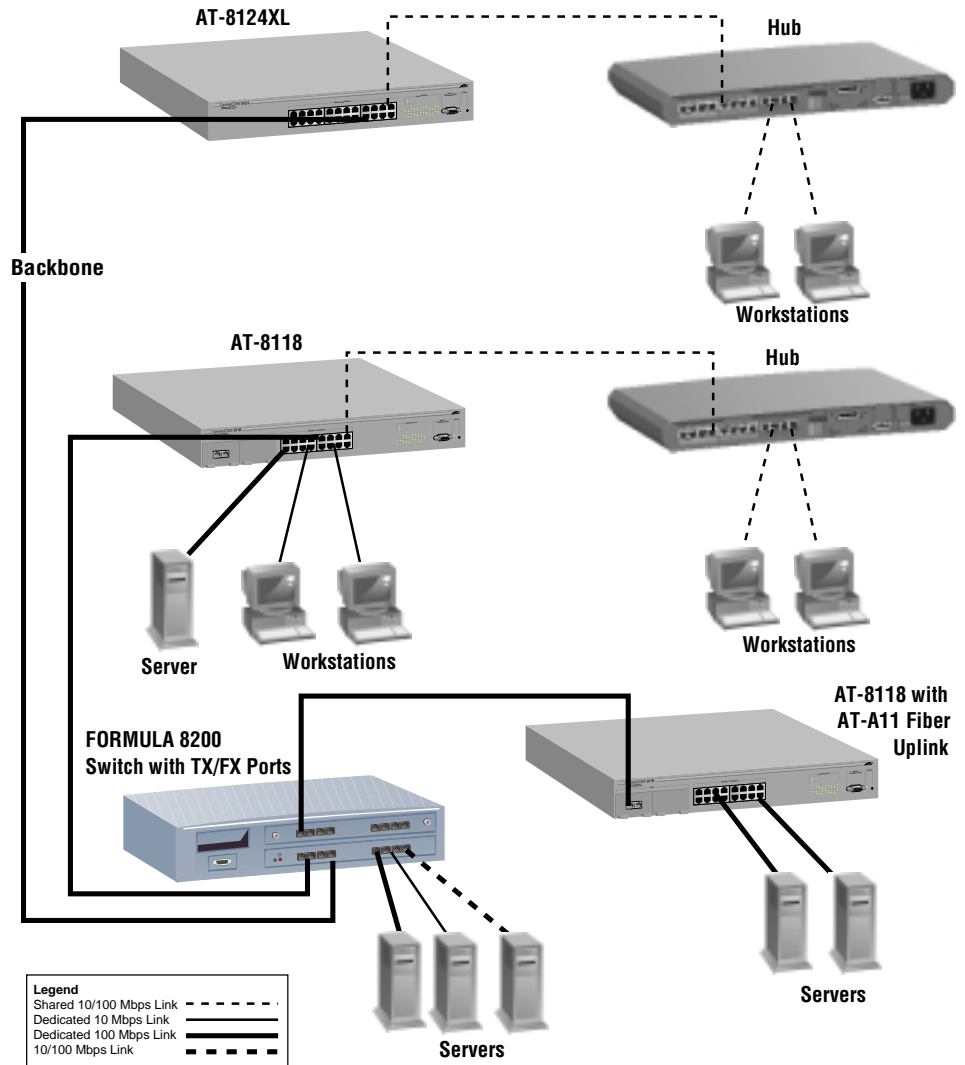

Figure 4-2 Switches in Workgroup Configurations

Appendix A

Translated Safety Information

IMPORTANT: This appendix contains multiple-language translations for the safety statements in this guide.

WICHTIG: Dieser Anhang enthält Übersetzungen der in diesem Handbuch enthaltenen Sicherheitshinweise in mehreren Sprachen.

VIGTIG: Dette tillæg indeholder oversættelser i flere sprog af sikkerhedsadvarslerne i denne håndbog.

BELANGRIJK: Deze appendix bevat vertalingen in meerdere talen van de veiligheidsopmerkingen in deze gids.

IMPORTANT: Cette annexe contient la traduction en plusieurs langues des instructions de sécurité figurant dans ce guide.

TÄRKEÄÄ: Tämä liite sisältää tässä oppaassa esiintyvät turvaohjeet usealla kielellä.

IMPORTANTE: questa appendice contiene traduzioni in più lingue degli avvisi di sicurezza di questa guida.

VIKTIG: Dette tillegget inneholder oversettelser til flere språk av sikkerhetsinformasjonen i denne veiledningen.

IMPORTANTE: Este anexo contém traduções em vários idiomas das advertências de segurança neste guia.



IMPORTANTE: Este apéndice contiene traducciones en múltiples idiomas de los mensajes de seguridad incluidos en esta guía.



























OBS! Denna bilaga innehåller flerspråkiga översättningar av säkerhetsmeddelandena i denna handledning.









Standards: This product meets the following safety standards.













U.S. Federal Communications Commission	
Radiated Energy	
<p>Note: This equipment has been tested and found to comply with the limits for a Class A digital device pursuant to Part 15 of the FCC Rules. These limits are designed to provide reasonable protection against harmful interference when the equipment is operated in a commercial environment. This equipment generates, uses, and can radiate radio frequency energy and, if not installed and used in accordance with this instruction manual, may cause harmful interference to radio communications. Operation of this equipment in a residential area is likely to cause harmful interference in which case the user will be required to correct the interference at his own expense.</p> <p>Note: Modifications or changes not expressly approved by the manufacturer or the FCC can void your right to operate this equipment.</p>	





















Canadian Department of Communications	
<p>This Class A digital apparatus meets all requirements of the Canadian Interference-Causing Equipment Regulations.</p> <p>Cet appareil numérique de la classe A respecte toutes les exigences du Règlement sur le matériel brouilleur du Canada.</p>	

















- 🌀 1 RFI Emission EN55022 Class A
- 🌀 2 **WARNING:** In a domestic environment this product may cause radio interference in which case the user may be required to take adequate measures.
- 🌀 3 Immunity EN50082-1
- 🌀 4 Electrical Safety TUV-EN60950, UL1950, CSA 950
- 🌀 5  Laser EN60825
 At time of installation the Fiber Optic Lasers comply with FDA Radiation Performance Standard 21CFR Subchapter J, applicable at date of manufacture.
- 🌀 6 Warning Class 1 Laser product.
- 🌀 7 Warning Do not stare into the Laser beam.
- 🌀 8  **ELECTRICAL NOTICES**
WARNING: ELECTRIC SHOCK HAZARD
 To prevent ELECTRIC shock, do not remove cover. No user-serviceable parts inside. This unit contains HAZARDOUS VOLTAGES and should only be opened by a trained and qualified technician. To avoid the possibility of ELECTRIC SHOCK disconnect electric power to the product before connecting or disconnecting the LAN cables.
- 🌀 9 **LIGHTNING DANGER**
DANGER: DO NOT WORK on equipment or CABLES during periods of LIGHTNING ACTIVITY.
- 🌀 10 **CAUTION:** POWER CORD IS USED AS A DISCONNECTION DEVICE. TO DE-ENERGISE EQUIPMENT disconnect the power cord.
ELECTRICAL—AUTO VOLTAGE ADJUSTMENT
 This product will automatically adjust to any voltage between the ranges shown on the label.
- 🌀 11 **ELECTRICAL—TYPE CLASS 1 EQUIPMENT**
 THIS EQUIPMENT MUST BE EARTHED. Power plug must be connected to a properly wired earth ground socket outlet. An improperly wired socket outlet could place hazardous voltages on accessible metal parts.
- 🌀 12 **ELECTRICAL—CORD NOTICE**
 Use power cord, maximum 4.5 meters long, rated 5 amp minimum, 250V, made of <HAR> cordage molded IEC 320 connector on one end and on the other end a plug approved by the country of end use.
WARNING: Only use installed products in the HORIZONTAL position. DO NOT USE VERTICALLY.
- 🌀 13 **CAUTION:** Air vents must not be blocked and must have free access to the room ambient air for cooling.











	14 OPERATING TEMPERATURE	
	This product is designed for a maximum ambient temperature of 40 degrees C.	
	15 All Countries:	Install product in accordance with local and National Electrical Codes.
	NORMEN:	Dieses Produkt erfüllt die Anforderungen der nachfolgenden Sicherheitsnormen.
<hr/>		
	1	Hochfrequenzstörung EN55022 Klasse A
	2	WARNUNG: Bei Verwendung zu Hause kann dieses Produkt Funkstörungen hervorrufen. In diesem Fall müßte der Anwender angemessene Gegenmaßnahmen ergreifen.
	3	Störsicherheit EN50082-1
	4	Elektrische Sicherheit TUV-EN60950, UL1950, CSA 950
	5	 Laser EN60825
	6	WARNUNG Laserprodukt der Klasse 1.
	7	WARNUNG Nicht direkt in den Strahl blicken.
	8	 ACHTUNG: GEFÄHRLICHE SPANNUNG Das Gehäuse nicht öffnen. Das Gerät enthält keine vom Benutzer wartbaren Teile. Das Gerät steht unter Hochspannung und darf nur von qualifiziertem technischem Personal geöffnet werden. Vor Anschluß der LAN-Kabel, Gerät vom Netz trennen.
	9	GEFAHR DURCH BLITZSCHLAG GEFAHR: Keine Arbeiten am Gerät oder an den Kabeln während eines Gewitters ausführen.
	10	VORSICHT: DAS NETZKABEL DIENST ZUM TRENNEN DER STROMVERSORGUNG. ZUR TRENNUNG VOM NETZ, KABEL AUS DER STECKDOSE ZIEHEN. AUTOMATISCHE SPANNUNGSEINSTELLUNG Dieses Gerät stellt sich automatisch auf die auf dem Etikett aufgeführten Spannungswerte ein.
	11	GERÄTE DER KLASSE 1 DIESE GERÄTE MÜSSEN GEERDET SEIN. Der Netzstecker darf nur mit einer vorschriftsmäßig geerdeten Steckdose verbunden werden. Ein unvorschriftsmäßiger Anschluß kann die Metallteile des Gehäuses unter gefährliche elektrische Spannungen setzen.
	12	NETZKABEL Das Netzkabel sollte eine maximale Länge von 4,5 Metern, einen Nennwert von mindestens 5 A und 250 V haben, aus HAR-Material hergestellt und mit einer gepreßten, IEC320 entsprechenden, Anschlußverbindung an einem Ende, und am anderen Ende mit einem im Land des Endverbrauchers geprüften Stecker ausgestattet sein. WARNUNG: Die installierten Produkte dürfen nur in HORIZONTALER Position betrieben werden. NICHT IN VERTIKALER POSITION BETREIBEN.
	13	VORSICHT Die Entlüftungsöffnungen dürfen nicht versperrt sein und müssen zum Kühlen freien Zugang zur Raumluft haben.
	14	BETRIEBSTEMPERATUR Dieses Produkt wurde für den Betrieb in einer Umgebungstemperatur von nicht mehr als 40° C entworfen.
	15	ALLE LÄNDER: Installation muß örtlichen und nationalen elektrischen Vorschriften entsprechen. STANDARDER: Dette produkt opfylder følgende sikkerhedsstandarder.
<hr/>		
	1	Radiofrekvens forstyrrelsesemission EN55022 Klasse A
	2	ADVARSEL: I et hjemligt miljø kunne dette produkt forårsage radio forstyrrelse. Bliver det tilfældet, påkræves brugeren muligvis at tage tilstrækkelige foranstaltninger.
	3	Immunitet EN50082-1
	4	Elektrisk sikkerhed TUV-EN60950, UL1950, CSA 950
	5	 Laser EN60825
	6	ADVARSEL Laserprodukt av klasse 1.
	7	ADVARSEL Stirr ikke på strålen.







-  **8 ELEKTRISKE FORHOLDSREGLER**
ADVARSEL: RISIKO FOR ELEKTRISK STØD
 For at forebygge ELEKTRISK stød, undlad at åbne apparatet. Der er ingen indre dele, der kan repareres af brugeren. Denne enhed indeholder LIVSFARLIGE STRØMSPÆNDINGER og bør kun åbnes af en uddannet og kvalificeret tekniker. For at undgå risiko for ELEKTRISK STØD, afbrydes den elektriske strøm til produktet, før LAN-kablerne monteres eller afmonteres.
-  **9 FARE UNDER UVEJR**
FARE: UNDLAD at arbejde på udstyr eller KABLER i perioder med LYNAKTIVITET.
-  **10 ADVARSEL:** DEN STRØMFØRENDE LEDNING BRUGES TIL AT AFBRYDE STRØMMEN. SKAL STRØMMEN TIL APPARATET AFBRYDES, tages ledningen ud af stikket.
- ELEKTRISK—AUTOMATISK SPÆNDINGSREGULERING**
 Dette apparat vil automatisk tilpasse sig enhver spænding indenfor de værdier, der er angivet på etiketten.
-  **11 ELEKTRISK—KLASSE 1-UDSTYR**
 DETTE UDSTYR KRÆVER JORDFORBINDELSE. Stikket skal være forbundet med en korrekt installeret jordforbunden stikkontakt. En ukorrekt installeret stikkontakt kan sætte livsfarlig spænding til tilgængelige metaldele.
-  **12 ELEKTRISK—LEDNING**
 Anvend ledning af maksimum 4,5 meters længde, med en kapacitet på minimum 5 amp., 250 v, bestående af en IEC 320 connector med indstøbt <HAR> ledning i den ene ende og et stik i den anden ende, der er godkendt af myndighederne i brugerlandet.
- ADVARSEL:** Betjen kun de installerede produkter i den HORIZONTAL position (vandret). BETJEN DEM IKKE I DEN VERTIKALE POSITION (lodret).
-  **13 ADVARSEL:** Ventilationsåbninger må ikke blokeres og skal have fri adgang til den omgivende luft i rummet for afkøling.
-  **14 BETJENINGSTEMPERATUR**
 Dette apparat er konstrueret til en omgivende temperatur på maksimum 40 grader C.
-  **15 ALLE LANDE:** Installation af produktet skal ske i overensstemmelse med lokal og national lovgivning for elektriske installationer.
- NORMEN:** Dit product voldoet aan de volgende veiligheidsnormen.















-
-  **1** RFI Emissie EN55022 Klasse A
-  **2 WAARSCHUWING:** Binnenshuis kan dit product radiostoring veroorzaken, in welk geval de gebruiker verplicht kan worden om gepaste maatregelen te nemen.
-  **3** Immunititeit EN50082-1
-  **4** Electricische Veiligheid TUV-EN60950, UL1950, CSA 950
-  **5**  Laser EN60825
-  **6 WAARSCHUWING** Klasse-1 laser produkt.
-  **7 WAARCHUWING** Neit in de straal staren.
-  **8 WAARSCHUWINGEN MET BETREKKING TOT ELEKTRICITEIT**
WAARSCHUWING: GEVAAR VOOR ELEKTRISCHE SCHOKKEN
 Verwijder het deksel niet, teneinde ELEKTRISCHE schokken te voorkomen. Binnenin bevinden zich geen onderdelen die door de gebruiker onderhouden kunnen worden. Dit toestel staat onder GEVAARLIJKE SPANNING en mag alleen worden geopend door een daartoe opgeleide en bevoegde technicus. Om het gevaar op ELEKTRISCHE SCHOKKEN te vermijden, moet u het toestel van de stroombron ontkoppelen alvorens de LAN-kabels te koppelen of ontkoppelen.
-  **9 GEVAAR VOOR BLIKSEMINSLAG**
GEVAAR: NIET aan toestellen of KABELS WERKEN bij BLIKSEM.
-  **10 WAARSCHUWING:** HET TOESTEL WORDT UITGESCHAKELD DOOR DE STROOMKABEL TE ONTKOPPELEN.OM HET TOESTEL STROOMLOOS TE MAKEN: de stroomkabel ontkoppelen.
ELEKTRISCH: AUTOMATISCHE AANPASSING VAN DE SPANNING
 Dit toestel past zich automatisch aan elke spanning aan, tussen de op het label vermelde waarden.
-  **11 ELEKTRISCHE TOESTELLEN VAN KLASSE 1**
 DIT TOESTEL MOET GEAARD WORDEN. De stekker moet aangesloten zijn op een juist geaarde contactdoos. Een onjuist geaarde contactdoos kan de metalen onderdelen waarmee de gebruiker eventueel in aanraking komt onder gevaarlijke spanning stellen.

-  **12 ELEKTRISCHE SNOEREN**
Gebruik een elektrisch snoer, maximum 4,5 meter lang, berekend voor ten minste 5 ampère, 250 V, uit HAR vervaardigd, met aan het ene uiteinde een gevormd IEC 320 aansluitstuk en aan het andere uiteinde een stekker die goedgekeurd is door het land waar het toestel gebruikt zal worden.
- WAARSCHUWING:** Gebruik de geïnstalleerde producten slechts in HORIZONTALE stand. GEBRUIK ZE NIET VERTICAAL.
-  **13 OPGELET:** De ventilatiegaten mogen niet worden gesperd en moeten de omgevingslucht ongehinderd toelaten voor afkoeling.
-  **14 BEDRIJFSTEMPERAATUUR**
De omgevingstemperatuur voor dit produkt mag niet meer bedragen dan 40 graden Celsius.
-  **15 ALLE LANDEN:** het toestel installeren overeenkomstig de lokale en nationale elektrische voorschriften.
- NORMES:** ce produit est conforme aux normes de sécurité, suivantes:
-
-  **1** Emission d'interférences radioélectriques EN55022 Classe A
-  **2** **MISE EN GARDE:** dans un environnement domestique, ce produit peut provoquer des interférences radioélectriques. Auquel cas, l'utilisateur devra prendre les mesures adéquates.
-  **3** Immunité EN50082 - 1
-  **4** Sécurité électrique TUV-EN60950, UL1950, CSA 950
-  **5**  Laser EN60825
-  **6** **ATTENTION** Produit laser de classe 1.
-  **7** **ATTENTION** Ne pas fixer le faisceau des yeux.
-  **8**  **INFORMATION SUR LES RISQUES ÉLECTRIQUES**
AVERTISSEMENT : DANGER D'ÉLECTROCUTION
Pour éviter toute ÉLECTROCUTION, ne pas ôter le revêtement protecteur du matériel. Ce matériel ne contient aucun élément réparable par l'utilisateur. Il comprend des TENSIONS DANGEREUSES et ne doit être ouvert que par un technicien dûment qualifié. Pour éviter tout risque d'ÉLECTROCUTION, débrancher le matériel avant de connecter ou de déconnecter les câbles LAN.
-  **9** **DANGER DE Foudre**
DANGER: NE PAS MANIER le matériel ou les CÂBLES lors d'activité orageuse.
-  **10** **ATTENTION:** LE CORDON D'ALIMENTATION SERT DE MISE HORS CIRCUIT. POUR COUPER L'ALIMENTATION DU MATÉRIEL, débrancher le cordon.
- RÉGLAGE DE TENSION AUTOMATIQUE ÉLECTRIQUE**
Ce matériel peut s'ajuster automatiquement sur n'importe quelle tension comprise dans la plage indiquée sur l'étiquette.
-  **11** **ÉQUIPEMENT DE CLASSE 1 ÉLECTRIQUE**
CE MATÉRIEL DOIT ÊTRE MIS A LA TERRE. La prise de courant doit être branchée dans une prise femelle correctement mise à la terre car des tensions dangereuses risqueraient d'atteindre les pièces métalliques accessibles à l'utilisateur.
-  **12** **INFORMATION SUR LE CORDON ÉLECTRIQUE**
Utiliser un cordon secteur de 4.5 mètres de long maximum, calibré à 5 ampères minimum, 250V, fabriqué en câblage <HAR> avec connecteur IEC 32C moulé à une extrémité, et à l'autre extrémité, une prise de courant mâle répondant aux normes du pays d'utilisation.
- AVERTISSEMENT:** utiliser uniquement le matériel installé en position HORIZONTALE. NE PAS UTILISER EN POSITION VERTICALE.
-  **13** **ATTENTION:** Ne pas bloquer les fentes d'aération, ceci empêcherait l'air ambiant de circuler librement pour le refroidissement.
-  **14** **TEMPÉRATURE DE FONCTIONNEMENT**
Ce matériel est capable de tolérer une température ambiante maximum de 40 degrés Celsius.
-  **15** **POUR TOUS PAYS:** Installer le matériel conformément aux normes électriques nationales et locales.
- NORMIT:** T_m, tuote on seuraavien turvallisuusnormien mukainen.



 1	Radioaaltojen häirintä	EN55022 Luokka A
 2	VAROITUS: Kotiolosuhteissa tämä laite voi aiheuttaa radioaaltojen häiriitä, missä tapauksessa laitteen käyttäjän on mahdollisesti ryhdyttävä tarpeellisiin toimenpiteisiin.	
 3	Kestävyys	EN50082-1
 4	Sähköturvallisuus	TUV-EN60950, UL1950, CSA 950
 5	 Laser	EN60825
 6	VAROITUS Luokan 1 Lasertuote.	
 7	VARIOTUS Älä katso säteeseen.	
 8	 SÄHKÖÖN LIITTYVIÄ HUOMAUTUKSIA VAROITUS: SÄHKÖISKUVAARA Estääksesi SÄHKÖISKUN älä poista kantta. Sisällä ei ole käyttäjän huollettavissa olevia osia. Tämä laite sisältää VAARALLISIA JÄNNITTEITÄ ja sen voi avata vain koulutettu ja pätev teknikko. Vältä äläkä SÄHKÖISKUN mahdollisuuden katkaise sähkövirta tuotteeseen ennen kuin liität tai irrotat paikallisverkon (LAN) kaapelit.	
 9	SALAMANISKUVAARA HENGENVAAARA: ÄLÄ TYÖSKENTELE laitteiden tai KAAPELEIDEN KANSSA SALAMOINNIN AIKANA.	
 10	HUOMAUTUS: VIRTajohtoa KÄYTETÄÄN VIRRANKATKAISULAITTEENA. VIRTA KATKAISTAAN irrottamalla virtajohto. SÄHKÖ—AUTOMAATTINEN JÄNNITTEENSÄÄTÖ Tämä tuote säätää automaattisesti mihin tahansa jännitteeseen ohjetarrassa annettujen arvojen välillä.	
 11	SÄHKÖ—TYYPPILUOKAN 1 LAITTEET TÄMÄ LAITE TÄYTY MAADOITTAA. Pistoke täytyy liittää kunnollisesti maadoitettuun pistorasiaan. Virheellisesti johdotettu pistorasia voi altistaa metalliosat vaarallisille jännitteille.	
 12	SÄHKÖ—JOHTOON LIITTYVÄ HUOMAUTUS Käytä seuraavanlaista virtajohtoa: maksimipituus 4,5 metriä, minimito 5 ampeeria, 250 V, valmistettu <HAR> -johdostosta, muovattu IEC 320 -liitin toisessa päässä ja käyttömaassa hyväksytty pistoke toisessa päässä. VAROITUS: Asennettuja tuotteita saa ainoastaan käyttää VAAKA-asennossa. PYSTYASENNUSTA EI SAA TEHDÄ.	
 13	HUOMAUTUS: Ilmavaihtoreikiä ei pidä tukkia ja niillä täytyy olla vapaa yhteys ympäröivään huoneilmaan, jotta ilmanvaihto tapahtuisi.	
 14	KÄYTTÖLÄMPÖTILA Tämä tuote on suunniteltu ympäröivän ilman maksimilämpötilalle 40° C.	
 15	KAIKKI MAAT: Asenna tuote paikallisten ja kansallisten sähköturvallisuusmääräysten mukaisesti. STANDARD: questo prodotto soddisfa i seguenti standard di sicurezza.	

















 1	Emissione RFI (interferenza di radiofrequenza)	EN55022 Classe A
 2	AVVERTENZA: in ambiente domestico questo prodotto potrebbe causare radio interferenza. In questo caso potrebbe richiedersi all'utente di prendere gli adeguati provvedimenti.	
 3	Immunità	EN50082-1
 4	Sicurezza elettrica	TUV-EN60950, UL1950, CSA 950
 5	 Laser	EN60825
 6	AVVERTENZA Prodotto laser di Classe 1.	
 7	AVVERTENZA Non fissare il raggio con gli occhi.	
 8	 AVVERTENZE ELETTRICHE ATTENZIONE: PERICOLO DI SCOSSE ELETTRICHE Per evitare SCOSSE ELETTRICHE non asportare il coperchio. Le componenti interne non sono riparabili dall'utente. Questa unità ha TENSIONI PERICOLOSE e va aperta solamente da un tecnico specializzato e qualificato. Per evitare ogni possibilità di SCOSSE ELETTRICHE, interrompere l'alimentazione del dispositivo prima di collegare o staccare i cavi LAN.	





-  **9 PERICOLO DI FULMINI**
PERICOLO: NON LAVORARE sul dispositivo o sui CAVI durante PRECIPITAZIONI TEMPORALESCHIE.
-  **10 ATTENZIONE:** IL CAVO DI ALIMENTAZIONE È USATO COME DISPOSITIVO DI DISATTIVAZIONE. PER TOGLIERE LA CORRENTE AL DISPOSITIVO staccare il cavo di alimentazione.
- ELETTRICITÀ—REGOLAZIONE AUTOMATICA DELLA TENSIONE**
 Questo prodotto regolerà automaticamente la tensione ad un valore compreso nella gamma indicata sull'etichetta.
-  **11 ELETTRICITÀ—DISPOSITIVI DI CLASSE 1**
 QUESTO DISPOSITIVO DEVE AVERE LA MESSA A TERRA. La spina deve essere inserita in una presa di corrente specificamente dotata di messa a terra. Una presa non cablata in maniera corretta rischia di scaricare una tensione pericolosa su parti metalliche accessibili.
-  **12 ELETTRICITÀ—AVVERTENZA SUL CAVO**
 Usare un cavo della lunghezza massima di metri 4,5, con capacità minima di 5 A, 250 V, di filo <HAR>, dotato di connettore stampato IEC 320 ad un'estremità e di spina approvata dal paese di destinazione all'altra.
- AVVERTENZA:** usare i prodotti installati solo in posizione ORIZZONTALE. NON USARE VERTICALMENTE.
-  **13 ATTENZIONE:** le prese d'aria non vanno ostruite e devono consentire il libero ricircolo dell'aria ambiente per il raffreddamento.
-  **14 TEMPERATURA DI FUNZIONAMENTO**
 Questo prodotto è concepito per una temperatura ambientale massima di 40 gradi centigradi.
-  **15 TUTTI I PAESI:** installare il prodotto in conformità delle vigenti normative elettriche nazionali.
- SIKKERHETSKRAV:** Dette produktet oppfyller følgende sikkerhetskrav:







 1	RFI stråling	EN55022 Klasse A
 2	ADVARSEL: Hvis dette produktet benyttes til privat bruk, kan produktet forårsake radioforstyrrelse. Hvis dette skjer, må brukeren ta de nødvendige forholdsregler.	
 3	Immunitet	EN50082-1
 4	Elektrisk sikkerhet	TUV-EN60950, UL1950, CSA 950
 5	 Laser	EN60825
 6	ADVARSEL Laserprodukt av klasse 1.	
 7	ADVARSEL Stirr ikke på strålen.	
 8	 ELEKTRISITET ADVARSEL: FARE FOR ELEKTRISK SJOKK For å unngå ELEKTRISK sjokk, må dekslet ikke tas av. Det finnes ingen deler som brukeren kan reparere på innsiden. Denne enheten inneholder FARLIGE SPENNINGER, og må kun åpnes av en faglig kvalifisert tekniker. For å unngå ELEKTRISK SJOKK må den elektriske strømmen til produktet være avslått før LAN-kablene til- eller frakobles.	
 9	FARE FOR LYNNEDSLAG FARE: ARBEID IKKE på utstyr eller KABLER i TORDENVÆR.	
 10	FORSIKTIG: STRØMLEDNINGEN BRUKES TIL Å FRAKOBLE UTSTYRET. FOR Å DEAKTIVISERE UTSTYRET, må strømforsyningen kobles fra. ELEKTRISK—AUTO SPENNINGSTILPASNING Dette produktet vil automatisk bli tilpasset hvilken som helst strømspenning i de områdene som vises på etiketten.	
 11	ELEKTRISK—TYPE 1- KLASSE UTSTYR DETTE UTSTYRET MÅ JORDES. Strømkontakten må være tilkople en korrekt jordet kontakt. En kontakt som ikke er korrekt jordet kan føre til farlig spenninger i lett t ilgjengelige metalldeleler.	
 12	ELEKTRISK—MEDDELELSE OM LEDNINGER Bruk en strømledning av maksimalt 4.5 m. i lengde, godkjent for minst av 5 amp, 250V, fremstilt av <HAR> ledning IEC 320 koplingsstykke i den ene enden, og i den andre enden en plugg som er blitt godkjent i brukerlandet.	

ADVARSEL: Installerte produkter må bare benyttes i HORIZONTAL posisjon. MÅ IKKE BENYTTES VERTIKALT.

-  **13** **FORSIKTIG:** Lufteventilene må ikke blokkeres, og må ha fri tilgang til luft med romtemperatur for avkjøling.
-  **14** **DRIFTSTEMPERATUR**
Dette produktet er konstruert for bruk i maksimum romtemperatur på 40 grader celsius.
-  **15** **ALLE LAND:** Produktet må installeres i samsvar med de lokale og nasjonale elektriske koder.
- PADROES:** Este produto satisfaz os seguintes padroes de segurança:

-
-  **1** Emissão de interferência de radiofrequência EN55022 Classe A
-  **2** **AVISO:** Num ambiente doméstico este produto pode causar interferência na radiorrecepção e, neste caso, pode ser necessário que o utente tome as medidas adequadas.
-  **3** Imunidade EN50082-1
-  **4** Segurança Eléctrica TUV-EN60950, UL1950, CSA 950
-  **5**  Laser EN60825
-  **6** **AVISO** Produto laser de classe 1
-  **7** **AVISO** Não olhe fixamente para o raio.
-  **8**  **AVISOS SOBRE CARACTERÍSTICAS ELÉTRICAS**
ATENÇÃO: PERIGO DE CHOQUE ELÉTRICO
Para evitar CHOQUE ELÉTRICO, não retire a tampa. Não contém peças que possam ser consertadas pelo usuário. Este aparelho contém VOLTAGENS PERIGOSAS e só deve ser aberto por um técnico qualificado e treinado. Para evitar a possibilidade de CHOQUE ELÉTRICO, desconecte o aparelho da fonte de energia elétrica antes de conectar e desconectar os cabos da LAN.
-  **9** **PERIGO DE CHOQUE CAUSADO POR RAIOS**
PERIGO: NÃO TRABALHE no equipamento ou nos CABOS durante períodos suscetíveis a QUEDAS DE RAIOS.
-  **10** **CUIDADO:** O CABO DE ALIMENTAÇÃO É UTILIZADO COMO UM DISPOSITIVO DE DESCONEXÃO. PARA DESELETRIFICAR O EQUIPAMENTO, desconecte o cabo de ALIMENTAÇÃO.
ELÉTRICO—AJUSTE AUTOMÁTICO DE VOLTAGEM
Este produto ajustar-se-á automaticamente a qualquer voltagem que esteja dentro dos limites indicados no rótulo.
-  **11** **ELÉTRICO—EQUIPAMENTOS DO TIPO CLASSE 1**
DEVE SER FEITA LIGAÇÃO DE FIO TERRA PARA ESTE EQUIPAMENTO. O plugue de alimentação deve ser conectado a uma tomada com adequada ligação de fio terra. Tomadas sem adequada ligação de fio terra podem transmitir voltagens perigosas a peças metálicas expostas.
-  **12** **ELÉTRICO—AVISO SOBRE O CABO DE ALIMENTAÇÃO**
Use cabo de alimentação com comprimento máximo de 4,5 metros, com uma capacidade indicada mínima de 5 amp e 250 V, fabricado de material para cabo <HAR> com conector moldado IEC 320 em uma extremidade e, na outra extremidade, um plugue aprovado para uso no país em questão.
CUIDADO!: Use os produtos instalados na posição HORIZONTAL. NÃO OS USE VERTICALMENTE.
-  **13** **CUIDADO:** As aberturas de ventilação não devem ser bloqueadas e devem ter acesso livre ao ar ambiente para arrefecimento adequado do aparelho.
-  **14** **TEMPERATURA DE FUNCIONAMENTO**
Este produto foi projetado para uma temperatura ambiente máxima de 40 graus centígrados.
-  **15** **TODOS OS PAÍSES:** Instale o produto de acordo com as normas nacionais e locais para instalações elétricas.
NORMAS: este producto cumple con las siguientes normas de seguridad.

1	Emisión RFI	EN55022 Clase A
2	ADVERTENCIA: en un entorno doméstico, este producto puede causar radiointerferencias, en cuyo caso, puede requerirse del usuario que tome las medidas que sean convenientes al respecto.	
3	Inmunidad	EN50082-1
4	Seguridad eléctrica	TUV-EN60950, UL1950, CSA 950
5	 Laser	EN60825
6	¡ADVERTENCIA! Producto láser Clase 1.	
7	¡ADVERTENCIA! No mirat fijamente el haz.	
8	 AVISOS ELECTRICOS ADVERTENCIA: PELIGRO DE ELECTROCHOQUE Para evitar un ELECTROCHOQUE, no quite la tapa. No hay ningún componente en el interior al cual puede prestar servicio el usuario. Esta unidad contiene VOLTAJES PELIGROSOS y sólo deberá abrirla un técnico entrenado y calificado. Para evitar la posibilidad de ELECTROCHOQUE desconecte la corriente eléctrica que llega al producto antes de conectar o desconectar los cables LAN.	
9	PELIGRO DE RAYOS PELIGRO: NO REALICE NINGUN TIPO DE TRABAJO O CONEXION en los equipos o en LOS CABLES durante TORMENTAS ELECTRICAS.	
10	ATENCION: EL CABLE DE ALIMENTACION SE USA COMO UN DISPOSITIVO DE DESCONEXION. PARA DESACTIVAR EL EQUIPO, desconecte el cable de alimentación. ELECTRICO—AUTO-AJUSTE DE TENSION Este producto se ajustará automáticamente a cualquier tensión entre los valores máximos y mínimos indicados en la etiqueta.	
11	ELECTRICO—EQUIPO DEL TIPO CLASE 1 ESTE EQUIPO TIENE QUE TENER CONEXION A TIERRA. El cable tiene que conectarse a un enchufe a tierra debidamente instalado. Un enchufe que no está correctamente instalado podría ocasionar tensiones peligrosas en las partes metálicas que están expuestas.	
12	ELECTRICO—ADVERTENCIA SOBRE EL CABLE Use un cable eléctrico con un máximo de 4,5 metros de largo, con una capacidad mínima de 5 amperios, 250 V, hecho de cable <HAR>, con el conector moldeado IEC 320 en un extremo y con un enchufe que está aprobado por el país de uso final en el otro. ADVERTENCIA: Usar únicamente los productos instalados en posición HORIZONTAL. NO USARLOS EN POSICIÓN VERTICAL.	
13	ATENCION: Las aberturas para ventilación no deberán bloquearse y deberán tener acceso libre al aire ambiental de la sala para su enfriamiento.	
14	TEMPERATURA REQUERIDA PARA LA OPERACIÓN Este producto está diseñado para una temperatura ambiental máxima de 40 grados C.	
15	PARA TODOS LOS PAÍSES: Monte el producto de acuerdo con los Códigos Eléctricos locales y nacionales. NORMER: Denna produkt uppfyller följande säkerhetsnormer.	
1	Radiostörning	EN55022 Klass A
2	WARNING: Denna produkt kan ge upphov till radiostörningar i hemmet, vilket kan tvinga användaren till att vidtaga erforderliga åtgärder.	
3	Immunitet	EN50082-1
4	Elsäkerhet	TUV-EN60950, UL1950, CSA 950
5	 Laser	EN60825
6	WARNING! Laserprodukt av klass 1.	
7	WARNING! Laserstrålning när enheten är öppen.	
8	 TILLKÄNNAGIVANDEN BETRÄFFANDE ELEKTRICITETSRIK: RISK FÖR ELEKTRISK STÖT För att undvika ELEKTRISK stöt, ta ej av locket. Det finns inga delar inuti som behöver underhållas. Denna apparat är under HÖGSPÄNNING och får endast öppnas av en utbildad kvalificerad tekniker. För att undvika ELEKTRISK STÖT, koppla ifrån produktens strömanslutning innan LAN-kablarna ansluts eller kopplas ur.	

-  **9 FARA FÖR BLIXTNEDSLAG**
FARA: ARBETA EJ på utrustningen eller kablarna vid ÅSKVÄDER.
-  **10 VARNING: NÄTKABELN ANVÄNDS SOM STRÖMBRYTARE FÖR ATT KOPPLA FRÅN STRÖMMEN, dra ur nätkabeln.**
ELEKTRISKT—AUTOMATISK SPÄNNINGSJUSTERING
Denna produkt justeras automatiskt till alla spänningar inom omfånget som indikeras på produktens märkning.
-  **11 ELEKTRISKT—TYP KLASS 1 UTRUSTNING**
DENNA UTRUSTNING MÅSTE VARA JORDAD. Nätkabeln måste vara ansluten till ett ordentligt jordat uttag. Ett felaktigt uttag kan göra att närliggande metalldelar utsätts för högspänning. Apparaten skall anslutas till jordat uttag, när den ansluts till ett nätverk.
-  **12 ELEKTRISKT—ANMÄRKNING BETRÄFFANDE KABELN**
Använd en kabel med maximum längd 4,5 meter och minimum 5 amp nominal, 250V, av <HAR> kabelfabrikat med ett specialutformat IEC 320-kontaktdon i ena änden och i den andra en plugg som godkänts i landet där produkten används.
VARNING: Den installerade produkten bör endast användas i HORISONTALLÄGE. FÅR INTE ANVÄNDAS VERTIKALT.
-  **13 VARNING:** Luftventilerna får ej blockeras och måste ha fri tillgång till omgivande rumsluft för avsvälning.
-  **14 DRIFTSTEMPERATUR**
Denna produkt är konstruerad för rumstemperatur ej överstigande 40 grader Celsius.
-  **15 ALLA LÄNDER:** Installera produkten i enlighet med lokala och statliga bestämmelser för elektrisk utrustning.

Appendix B

Technical Specifications

Table B-1 lists the technical specifications for the AT-8118, AT-8124XL, and AT-8126XL switches.

Table B-1 Technical Specifications

Physical Specifications		
	Dimensions (H x W x D)	Weight
Base unit	2.55 in x 16.9 in x 14.5 in (6.48 cm x 42.93 cm x 36.83 cm)	11 lbs (5 kg)
Required ventilation on all sides	7.5 in (19 cm)	
Environmental Specifications		
Operating temperature	32° to 104° F (0° C to 40° C)	
Storage temperature	-4° to 140° F (-20° C to 60° C)	
Operating humidity	5% to 95% non-condensing	
Operating altitude range	up to 9,843 ft (3,000 m)	
Power Specifications		
Maximum power consumption	80 W	
AC input voltage	100-120/200-240VAC~ +6%-10% (autoranging), 1.0/0.5A	
Frequency	50/60 Hz ± 3 cycles of nominal input frequency	
Safety and Electromagnetic Emissions Certifications		
Safety: UL 1950	CSA 22.2 No. 950	EN 60950 (TUV)
EMI: FCC Class A	EN55022 Class A	VCCI Class A
Immunity: EN50082-1	Quality and Reliability MTBF > 50,000 hrs	MTTR < 1/2 hr DOA < 1%

Table B-2 shows the pin assignments for the switches' RJ45 connectors.

Table B-2 RJ45 Pin Assignments

Pin Number	Function
1	RD+
2	RD-
3	TD+
4	Unused
5	Unused
6	TD-
7	Unused
8	Unused

Table B-3 lists the specifications for the AT-A10, AT-A11, AT-A20 and AT-A21 media dependent adapters. The MDAs are installed in the AT-8118 or AT-8126XL switch's uplink slots.

Table B-3 Media Dependent Adapters

	AT-A10	AT-A11/AT-A20/AT-A21
Physical Dimensions (H x W x D)	0.85 in x 3 in x 4.5 in (2.16 cm x 7.62 cm x 11.43 cm)	0.85 in x 3 in x 4.5 in (2.16 cm x 7.62 cm x 11.43 cm)
Weight	.10 lbs (.045 kg)	.10 lbs (.045 kg)
Connector Type	RJ45	SC/MT-RJ/VF-45 multimode fiber 50/125- and 62.5/125-micron multimode fiber cable
Maximum Distance	330 ft (100 m) Category 5 UTP	Half-duplex: 1,351 ft (412 m) Full-duplex: 1.25 mi (2 km)
Ethernet Mode	10Base-T/100Base-TX Auto-negotiating Half- or Full-duplex	100Base-FX Half- or Full-duplex

Appendix C

Switch Default Settings

This appendix lists the switch's default software settings as configured by the factory.

Table C-1 Switch Default Settings

Settings	Default
IP Address	0.0.0.0
Subnet Mask	0.0.0.0
Gateway Address	0.0.0.0
Get community string	Public
Set community string	Private
Trap community string	Public
Spanning Tree Protocol	Disabled
Telnet Access	Enabled
System Name	None
Password (Omega)	No password assigned
Download Password	ATS21
Duplex mode	Auto-negotiating
High Port Speed	Auto-negotiating
Active Aging Time (MAC address table)	300 seconds
Forwarding Mode	Store and forward
Domain Name	None
Virtual LAN	Default VLAN (all ports)

Index

Numerics

100 M (port speed) LED, 2-4, 3-4

A

address, IP, 2-10

architecture

clear-channel, 1-3

shared memory, 1-3

AT-8118, AT-8124XL, and AT-8126XL

switches 1-1

AT-A10, AT-A11, AT-A20, and AT-A21

installation, 2-7

standoff, 2-7

auto-negotiation, 1-1, 1-3

B

backbone, redundant connections, 1-4

bandwidth capability, 1-1

buffer memory, size, 1-3

C

cabling requirements, 2-11, 3-2

clear-channel architecture, 1-3

configuration, 4-1

connections

redundant backbone, 1-4

conventions, document, Preface-ii

cut-through mode (for 100 Mbps ports only) 1-5

D

default settings, switch, C-1

desktop installation, switch, 2-4

diagnostics, running, 3-6

disabled port, 3-5

distances, cables, 2-11, 3-2

duplex

full-, 1-3

half-, 1-3

F

failure indication, software downloads, 3-6

fault LED, 2-4, 3-4, 3-6

fragment free cut-through mode, 1-5

full-duplex, 1-3, 2-11

H

half-duplex, 1-3, 2-11

I

installation

devices, cabling requirements, 2-11

devices, connecting to switch, 2-11

MDAs, 2-7

safety precautions, 2-2

site preparation, 2-3

switch, 19-inch rack, 2-5

switch, desktop, 2-4

IP address, 2-10

L

LED

100 M (port speed), 2-4, 3-4

descriptions, 2-4

fault, 2-4, 3-4

link/receive, 2-4, 3-4

power, 2-4, 3-4

uplink port, 2-9

link/receive LED, 2-4, 3-4

local management, Omega, 2-10

- M**
- management
 - local, Omega, 2-10
 - network features, 1-4
 - out-of-bandwith, 1-7
 - management information base (MIB), 1-4
 - media dependent adapters (MDAs), *see* AT-A10, AT-A11, AT-A20, and AT-A21
 - memory, packet buffer size, 1-3
 - mode
 - cut-through, fragment free (for 100 Mbps ports only), 1-5
 - store-and-forward, 1-5
 - models AT-8118, AT-8124XL and AT-8126XL, 1-2
- N**
- network management features, 1-4
- O**
- Omega, 1-4, 3-1
 - local management, 2-10
 - out-of-band management, 1-7
- P**
- package contents
 - MDA, 2-7
 - switch, 2-1
 - packet buffer memory size, 1-3
 - port
 - description, 1-3
 - disabled, 3-5
 - uplink LEDs, 2-9
 - port speed (100 M) LED, 2-4
 - port speed, 100 M LED, 3-4
 - power failure, 3-6
 - power LED, 2-4, 3-4, 3-6
 - preparation, site installation, 2-3
 - problems, troubleshooting, 3-1
 - protocol
 - spanning tree protocol, 1-4
 - publications, list of, Preface-iii
- R**
- rack installation, 2-5
 - receive (/link) LED, 2-4
 - redundant backbone connections, 1-4
 - remote connection, Telnet, 3-6
 - reset button, 3-1, 3-6
 - resetting through software, 3-6
 - RS232 connector, 1-7, 2-10
- S**
- safety information, A-1
 - safety precautions, 2-2
 - settings
 - terminal, 2-10
 - shared memory architecture, 1-3
 - site preparation, 2-3
 - SNMP Management Information Base, 1-4
 - SNMP traps from switch, TCP/IP, 3-4
 - software
 - resetting the switch, 3-6
 - software downloads
 - failure indication, 3-6
 - Spanning Tree Protocol, 1-4
 - specifications, technical, B-1
 - standalone switch 4-1
 - standoff, AT-A10, AT-A11, AT-A20, and AT-A21 2-7
 - store-and-forward mode, 1-5
 - switch
 - connecting devices, 2-11
 - desktop installation, 2-4
 - package contents, 2-1
- T**
- TCP/IP
 - environment, 2-10
 - SNMP traps from switch, 3-4
 - TCP/IP, 3-4
 - technical support, contacting, 3-3
 - Telnet, remote connection via, 3-6
 - terminal settings, 2-10
 - troubleshooting
 - power LED off 3-6
 - problems, 3-1
- U**
- uplink port (A or B) LED, 2-9
- W**
- worst case path delay value, 3-2