

Fast Ethernet Switches

AT-8316F/MT
AT-8316F/VF
AT-8316F/SC
AT-8324



Installation Guide



Copyright © 2003 Allied Telesyn, Inc.
960 Stewart Drive Suite B, Sunnyvale, CA 94086 USA

All rights reserved. No part of this publication may be reproduced without prior written permission from Allied Telesyn, Inc.

CentreCom is a registered trademark of Allied Telesyn, Inc.

All other product names, company names, logos or other designations mentioned herein are trademarks or registered trademarks of their respective owners.

Allied Telesyn, Inc. reserves the right to make changes in specifications and other information contained in this document without prior written notice. The information provided herein is subject to change without notice. In no event shall Allied Telesyn, Inc. be liable for any incidental, special, indirect, or consequential damages whatsoever, including but not limited to lost profits, arising out of or related to this manual or the information contained herein, even if Allied Telesyn, Inc. has been advised of, known, or should have known, the possibility of such damages.

Electrical Safety and Emission Compliance Statement

STANDARDS: This product meets the following standards

U.S. Federal Communications Commission

RADIATED ENERGY

Note: This equipment has been tested and found to comply with the limits for a Class A digital device pursuant to Part 15 of the FCC Rules. These limits are designed to provide reasonable protection against harmful interference when the equipment is operated in a commercial environment. This equipment generates, uses, and can radiate radio frequency energy and, if not installed and used in accordance with this instruction manual, may cause harmful interference to radio communications. Operation of this equipment in a residential area is likely to cause harmful interference in which case the user will be required to correct the interference at his own expense.

Note: Modifications or changes not expressly approved by the manufacturer or the FCC can void your right to operate this equipment.

Industry Canada

This Class A digital apparatus meets all requirements of the Canadian Interference-Causing Equipment Regulations.

Cet appareil numérique de la classe A respecte toutes les exigences du Règlement sur le matériel brouilleur du Canada.

RFI Emission

EN55022 Class A  1



WARNING: In a domestic environment this product may cause radio interference in which case the user may be required to take adequate measures.  2

Immunity

EN50082-1 1997  3

Electrical Safety

EN60950, UL 1950, CSA 950  4





Laser

EN60825  5

IMPORTANT: Appendix A contains translated safety statements for installing this equipment. When you see the , go to Appendix A for the translated safety statement in your language.

WICHTIG: Anhang A enthält übersetzte Sicherheitshinweise für die Installation dieses Geräts. Wenn Sie  sehen, schlagen Sie in Anhang A den übersetzten Sicherheitshinweis in Ihrer Sprache nach.

VIGTIGT: Tillæg A indeholder oversatte sikkerhedsadvarsler, der vedrører installation af dette udstyr. Når De ser symbolet , skal De slå op i tillæg A og finde de oversatte sikkerhedsadvarsler i Deres eget sprog.

BELANGRIJK: Appendix A bevat vertaalde veiligheidsopmerkingen voor het installeren van deze apparatuur. Wanneer u de  ziet, raadpleeg Appendix A voor vertaalde veiligheidsinstructies in uw taal.

IMPORTANT: L'annexe A contient les instructions de sécurité relatives à l'installation de cet équipement. Lorsque vous voyez le symbole , reportez-vous à l'annexe A pour consulter la traduction de ces instructions dans votre langue.

TÄRKEÄÄ: Liite A sisältää tämän laitteen asentamiseen liittyvät käännetyt turvaohjeet. Kun näet -symbolin, katso käännettyä turvaohjetta liitteestä A.

IMPORTANTE: L'Appendice A contiene avvisi di sicurezza tradotti per l'installazione di questa apparecchiatura. Il simbolo , indica di consultare l'Appendice A per l'avviso di sicurezza nella propria lingua.

VIKTIG: Tillegg A inneholder oversatt sikkerhetsinformasjon for installering av dette utstyret. Når du ser , åpner du til Tillegg A for å finne den oversatte sikkerhetsinformasjonen på ønsket språk.

IMPORTANTE: O Anexo A contém advertências de segurança traduzidas para instalar este equipamento. Quando vir o símbolo , leia a advertência de segurança traduzida no seu idioma no Anexo A.

IMPORTANTE: El Apéndice A contiene mensajes de seguridad traducidos para la instalación de este equipo. Cuando vea el símbolo , vaya al Apéndice A para ver el mensaje de seguridad traducido a su idioma.

OBS! Bilaga A innehåller översatta säkerhetsmeddelanden avseende installationen av denna utrustning. När du ser , skall du gå till Bilaga A för att läsa det översatta säkerhetsmeddelandet på ditt språk.

Table of Contents

Preface	7
Purpose of This Guide	7
How This Guide is Organized	7
Document Conventions	8
Where to Find Related Guides	9
Chapter 1	
Hardware Description	11
The Switch Models	12
Features and Components	13
Physical Description	14
Data Ports	15
Switch LEDs	16
RS232 Connector	18
Stacking Ports	19
Stacking Module Expansion Slot	20
Stack ID Switch	20
Expansion Module Slots	21
Optional Expansion Modules.....	21
R.P.S Input Connector	23
Reset Button	24
AC Power Connector	25
AT-S25 Management Software and Omega Management Interface	25
Network Topology	26
Where to Go Next	28
Chapter 2	
Planning the Installation	29
AT-8316F and AT-8324 Switch Cabling Specifications	30
Switch Stacks	31
Stack of Two or Three Switches.....	31
Stack of Four to Eight Switches.....	32
Expansion Modules	33
Port Trunking	35
Guideline 1: Number of Ports in a Trunk.....	35
Guideline 2: Using Ports from the Same Group	35
Guideline 3: Creating Only One Trunk Per Group.....	36
Guideline 4: Using Consecutive Ports.....	36

Guideline 5: Cabling Based on Port Number	37
Guideline 6: Using Expansion Modules	37
Where to Go Next	38
Chapter 3	
Installing the Switch	39
Verifying the Package Contents	40
Reviewing Safety Precautions	41
Selecting a Site for the Switch	42
Installing the Switch as a Standalone Unit	43
Installing the Switch in a Rack	45
Building a Stack of Two Switches	46
Building a Stack of Three Switches	49
Building a Stack of Four to Eight Switches	52
Powering On a Stack	57
Setting Up a Terminal for Local Management	59
Installing an Expansion Module	60
Resetting a Stack	62
Where to Go Next	63
Chapter 4	
Troubleshooting	65
At the First Sign of a Problem	66
Network Cabling Problems	67
Calling Technical Support	67
How the Switch Reports Problems	68
Common Problems	70
Link /Activity LED on Any Port is OFF	70
Power LED is OFF	71
Fault LED is ON	71
Appendix A	
Translated Electrical Safety and Emission Information	73
Appendix B	
Technical Specifications	85
Appendix C	
Switch Default Settings	89
Index	91

Preface

Purpose of This Guide

This guide is intended for network administrators who are responsible for installing and maintaining AT-8316F and AT-8324 Ethernet switches.

How This Guide is Organized

This guide contains the following chapters and appendices:

Chapter 1, **Hardware Description**, describes the features and functions of the switches and the expansion modules. The chapter also describes several network topologies that use the fast Ethernet switches.

Chapter 2, **Planning the Installation**, contains cabling specifications for the switches and expansion modules, and lists the rules to observe when creating a port trunk.

Chapter 3, **Installing the Switch**, contains the procedures for installing the switch, building a stack of switches, and installing the expansion modules.

Chapter 4, **Troubleshooting**, describes how to troubleshoot the switch in case of a problem.

Appendix A, **Translated Electrical Safety and Emission Information**, contains translations of the safety warnings documented throughout this guide.

Appendix B, **Technical Specifications**, presents in tabular form switch and expansion module specifications.

Appendix C, **Switch Default Settings**, lists the switch's factory default software settings.

An **Index**, at the end of this guide, is according to subject matter.

Document Conventions

The conventions used in this guide are as follows:

- Notes:

Note

A note provides additional information.

- Warnings:



Warning

A warning indicates that performing or omitting a specific action may result in bodily injury.

- Cautions:



Caution

A caution indicates that performing or omitting a specific action may result in equipment damage or loss of data.

Where to Find Related Guides

After you have performed the procedures in this guide and installed the switch on your network, go to the Allied Telesyn web site at www.alliedtelesyn.com and download the following guide:

AT-S25 Management Software User's Guide

PN 613-10844-00

This manual explains how to use the Omega management software and the AT-S25 software to configure and manage the device.

Chapter 1

Hardware Description

The AT-8316F and the AT-8324 switches are designed to provide your network with Ethernet, Fast Ethernet, and Gigabit Ethernet connectivity over fiber optic and twisted pair cabling.

The switches can operate as standalone units or can be interconnected together through special stacking ports to form logical switches. Logical switches, also referred to as stacks, can make it easier for you to manage your network because you can manage all of the switches as one unit. Logical switches are also easy to customize. You can add or remove switches from a logical switch so that the unit always has the number and types of ports that your network requires.

Two expansion slots on the front of the switches further add to the flexibility of the systems. You can use the slots to install 10Base-T, 100Base-TX, 100Base-FX, and 1000Base-FX expansion modules.

This chapter describes the hardware features of the following products:

- ❑ AT-8316F/MT switch
- ❑ AT-8316F/VF switch
- ❑ AT-8316F/SC switch
- ❑ AT-8324 switch
- ❑ The optional expansion modules: AT-A15/SX, AT-A15/LX, AT-A16, AT-A17, AT-A18, and AT-A19

The Switch Models

Table 1-1 lists the switch models.

Table 1-1 Switch Models

Model ¹	Number of Ports	Type of Port	Type of Connector	Maximum Distance
AT-8316F/MT	16	100Base-FX	MT-RJ	2 kilometers ² (1.25 miles)
AT-8316F/VF	16	100Base-FX	VF-45	2 kilometers ² (1.25 miles)
AT-8316F/SC	16	100Base-FX	SC	2 kilometers ² (1.25 miles)
AT-8324	24	10/100Base-TX	RJ-45	100 meters (328 feet)

1. All models include two expansion slots.
2. Assumes 50/125 micron or 62.5/125 micron multimode fiber optic cabling and full-duplex operation.

Figure 1-1 shows the front panel of each switch.

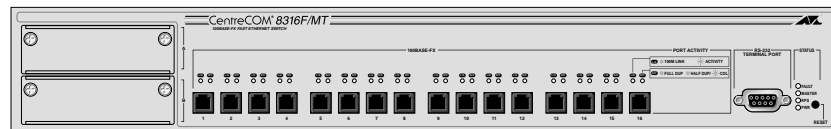

AT-8316/MT

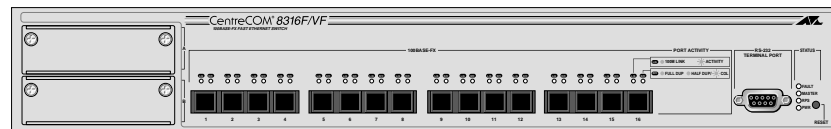

AT-8316/VF

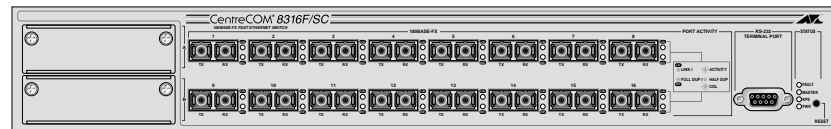

AT-8316F/SC

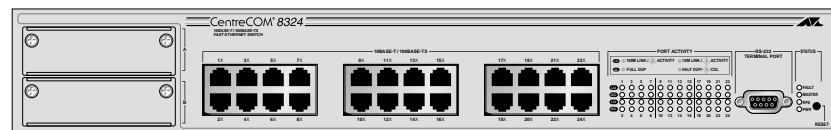

AT-8324

Figure 1-1 AT-8316F and AT-8324 Switches

Features and Components

The switches have the following common hardware features:

- Half- or full-duplex operation on all switched ports delivering up to 200 Mbps of bandwidth to servers, routers, workstations, or other switches
- Auto-negotiation on all 10Base-T/100Base-TX ports for speed and duplex in compliance with IEEE 802.3u specifications (AT-8324 switch only)
- Non-blocking, clear-channel architecture delivers wire-speed switching and up to 14 Gbps aggregate bandwidth
- Store-and-forward switching mode
- 8K MAC addresses per switch with automatic aging
- 4 MB SDRAM per eight 10Base-T/100Base-TX or 100Base-FX ports
- 2 MB Flash memory for software upgrades
- In-band Telnet capability for remote switch management
- AT-S25 software and Omega management software
- Two stacking ports for interconnecting switches to create logical switches
- One expansion slot for the optional AT-Stack8 Stacking Matrix Module for creating logical switches of up to eight switches
- Two expansion slots for optional uplink expansion modules
- RS232 connector for local switch management
- IEEE 802.1Q compliant Virtual LAN (VLAN) tagging support
- IEEE 802.1P compliant Quality of Service
- Two priority queues/levels per-port based on tagging information (IEEE 802.1P)
- IEEE 802.1d Spanning Tree Protocol
- SNMP Management Information Base (MIB) II, SNMP MIB extensions, Bridge MIB (RFC 1493), Ethernet MIB (RFC 1643), and Interface MIB (RFC 1573)
- BootP and DHCP support
- Port trunking for increased bandwidth to end nodes

Physical Description

Figure 1-2 through Figure 1-4 illustrate the location of the switch components.

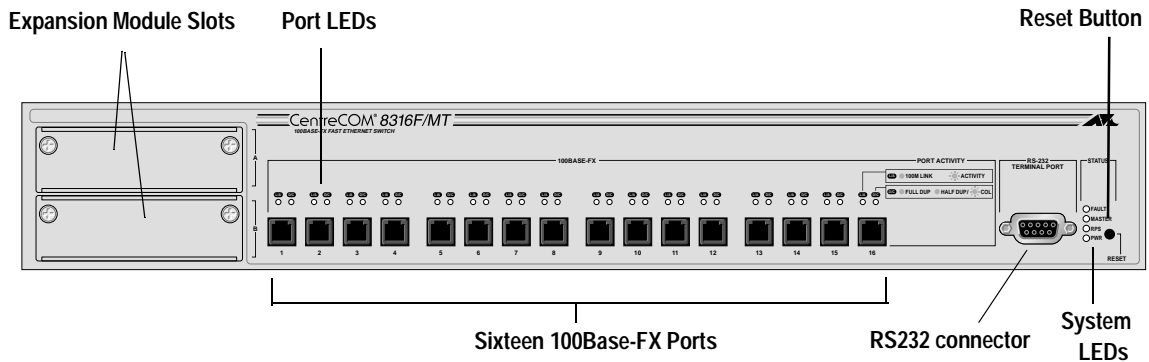

Figure 1-2 AT-8316F Switch (Model AT-8316F/MT)

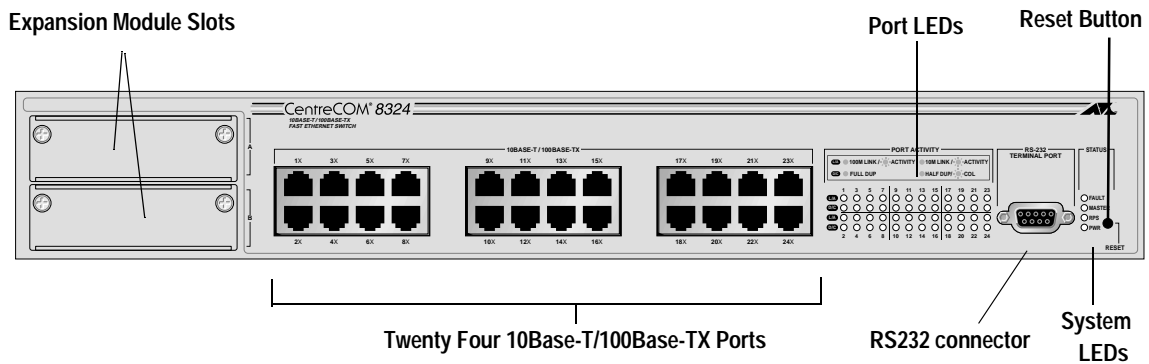

Figure 1-3 AT-8324 Switch

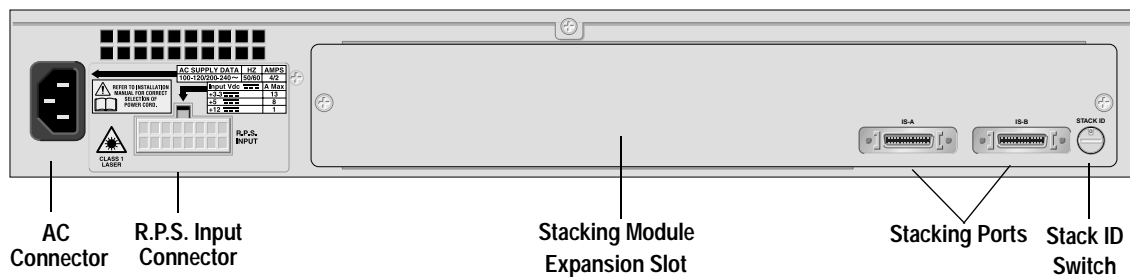

Figure 1-4 Switch Back Panel

Data Ports

Each model of the AT-8316F switch features 16 fiber optic ports with either MT-RJ, VF-45, or SC fiber optic connectors. The ports offer 100Base-FX performance and half- or full-duplex operation. Each port can operate up to a maximum distance of 2 kilometers (1.25 miles), assuming 50/125 micron or 62.5/125 micron multimode fiber optic cabling and full-duplex operation.

The AT-8324 switch has 24 twisted pair ports with RJ-45 connectors. The ports, which feature auto-negotiation on both speed and duplex mode, can operate as either 10Base-T or 100Base-TX ports and in half- or full-duplex mode.

Switch LEDs

The Ethernet switch has a series of LEDs for monitoring the status of the unit. There are system LEDs for monitoring the entire switch and port LEDs for monitoring the individual data ports.

The system LEDs are Fault, Master, RPS (Redundant Power Supply), and PWR. Figure 1-5 illustrates the location of the system LEDs. The location of the system LEDs is the same on all switch models.

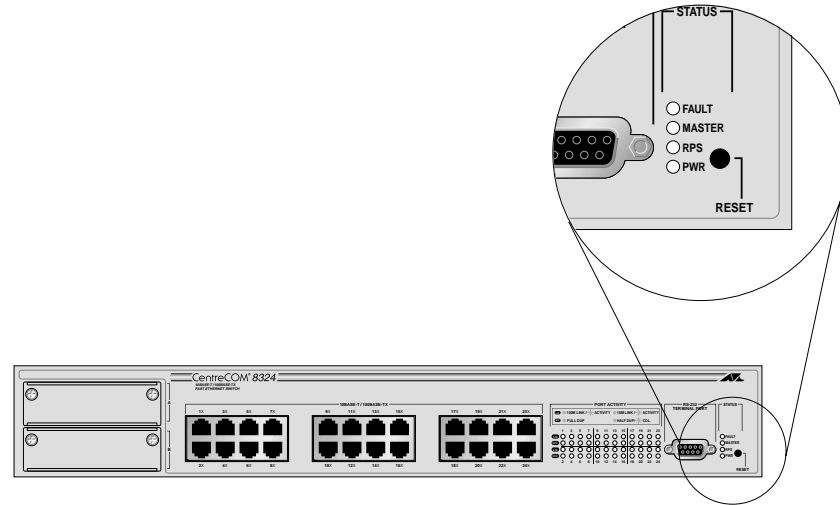

Figure 1-5 System LEDs

Table 1-2 describes the system LEDs on the Ethernet switch.

Table 1-2 Switch System LED Status

LED	State	Description
Fault	Solid Red	The switch or management software is malfunctioning.
	Flashing Red	The switch is booting, running diagnostic tests, writing messages to FLASH, or transferring files using XMODEM.
	OFF	Normal operation.
Master	Solid Amber	The switch is functioning as the master switch of the stack.
	Off	The switch is functioning as a slave switch in the stack or is not a part of a stack.
RPS (Redundant Power Supply)	Solid Green	The RPS is connected to the switch. To verify that the RPS is operating correctly, refer to the instructions in the RPS Quick Install Guide.
Power	Solid Green	The switch is receiving power, the voltage is within the acceptable range, and the power supply is working.

Each port has two LEDs that reflect the operating status of the port. On the AT-8316F switch, the port LEDs are located directly above or next to each port. On the AT-8324 switch, the port LEDs are grouped together on the right side of the switch. Table 1-3 describes the port LEDs on the Ethernet switch.

Table 1-3 Switch Port LED Status

LED	State	Description
L/A (Link/Activity)	Solid Green	This indicates a 100 Mbps link.
	Flashing Green	This indicates 100 Mbps activity.
	Solid Amber	This indicates a 10 Mbps link (AT-8324 switch only).
	Flashing Amber	This indicates 10 Mbps activity (AT-8324 switch only).
D/C (Duplex/Collision)	Solid Green	The port is operating at full-duplex.
	Solid Amber	The port is operating at half-duplex.
	Flashing Amber	Collisions are occurring on the line.

RS232 Connector

The RS232, DB-9 female port on the front of the switch (shown in Figure 1-6) is used with a VT100 terminal to manage the system. By connecting a terminal to the connector (or by using a personal computer with a terminal emulation program, such as the MS-Windows' Hyper Terminal emulation program), you can access the pre-installed Omega management program and configure the switch.

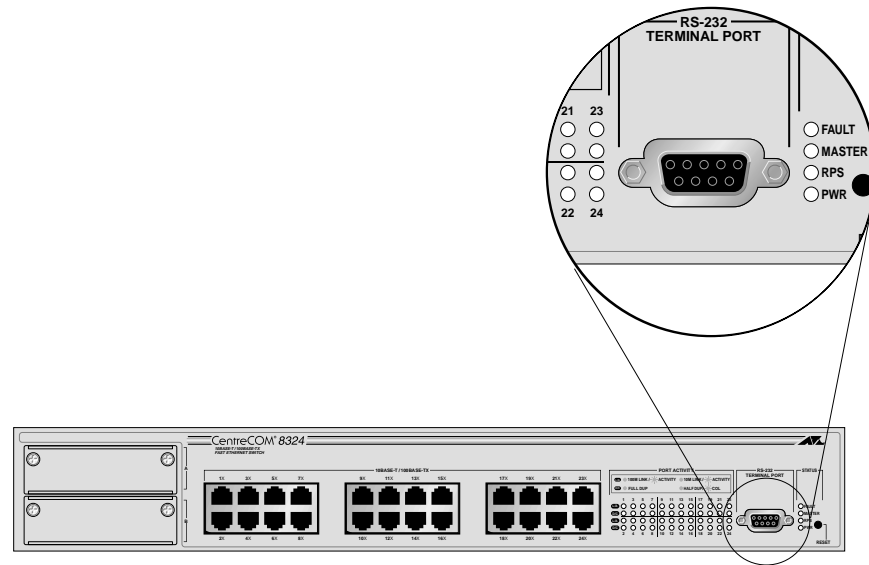

Figure 1-6 RS232 Port

This method for accessing the Omega program is referred to as “local access” or “out-of-band” access. You can also access the program over the web with a web browser or remotely via Telnet or an SNMP management program.

In an IP environment, after you have initially installed the switch you will be required to access the Omega program through the RS232 port in order to assign the switch its IP address and, if necessary, a gateway address. Once these addresses have been assigned, you can either continue to manage the switch through the RS232 port or access the program via one of the other available methods.

Note

Only the RS232 port on the master switch in a stack can be used to configure a stack locally. The RS232 ports on the slave switches are inactive and cannot be used. (For an explanation of master and slave switches, refer to , **Chapter 3, Installing the Switch.**)

Additionally, a straight-through cable is required in order to connect a terminal to the RS232 port on the master switch.

Stacking Ports

On the back of the switch are two stacking ports (Figure 1-7). The ports are used to interconnect AT-8316F and AT-8324 switches to form logical switches. A logical switch consists of two or more individual switches that function as one unit. This feature allows you to build a switch that is customized to the needs and requirements of your network. It also makes it easier to manage them since, rather than having to manage the switches individually, you can manage all the switches as one unit.

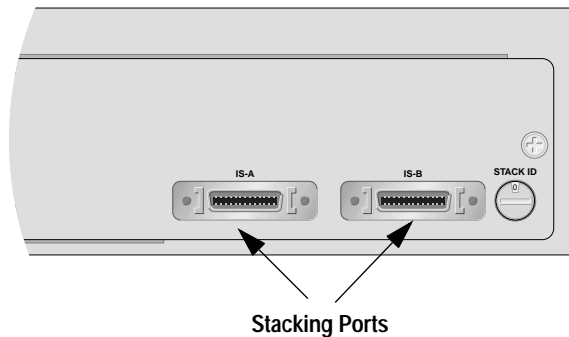

Figure 1-7 Stacking Ports

Interconnecting two or more AT-8316F or AT-8324 switches creates what is referred to as a stack. A stack can consist of either the same type of Ethernet switches or different types of switches. For example, a stack can consist of a combination of AT-8316F/MT and AT-8324 switches. The result would be one logical switch, where the individual switches themselves were different in the number and types of ports.

Each stacking port provides two gigabits of full-duplex bandwidth between switches. A stack of two or three switches does not require any additional hardware other than the switches and the AT-CABLE-4 cables that comes with the units. Creating a stack of four to eight switches requires the optional AT-Stack8 Stacking Matrix Module.

Stacking Module Expansion Slot

The stacking module expansion slot on the back panel of the switch is for the optional AT-Stack8 Stacking Matrix Module. This module allows you build a logical switch of up to eight switches.

Stack ID Switch

Next to the stacking ports on the back panel of the switch is the Stack ID switch (shown in Figure 1-8). You use this switch when you build a stack to assign each switch a unique identification number.

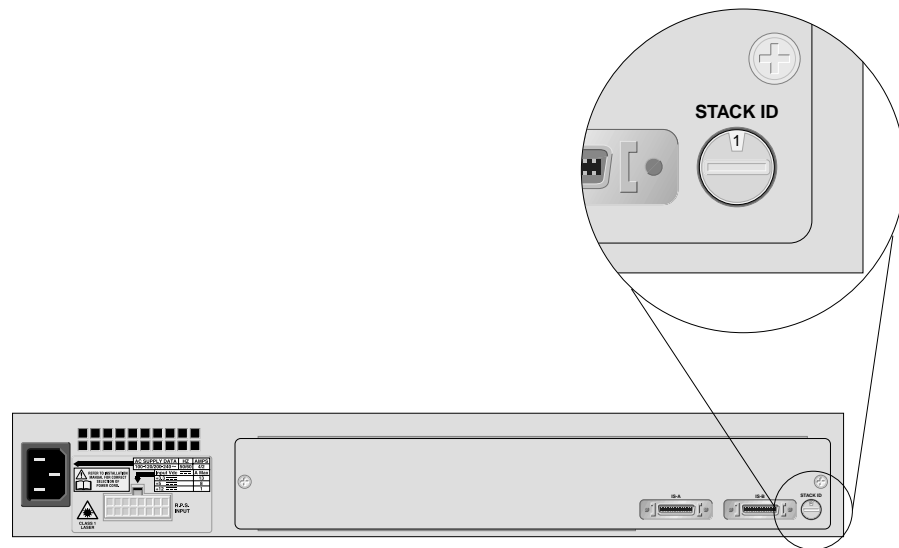

Figure 1-8 Stack ID Switch

Note

While the Stack ID switch has the range of settings of 0 to 9, only settings 1 through 8 are valid settings. Settings of 0 and 9 are invalid and should not be used. For information on setting this switch, refer to **Chapter 3, Installing the Switch**.

Expansion Module Slots

The capabilities of the AT-8316F and AT-8324XL Ethernet switches can be expanded by installing optional expansion modules in the two expansion slots on the front of the switches (shown in Figure 1-9).

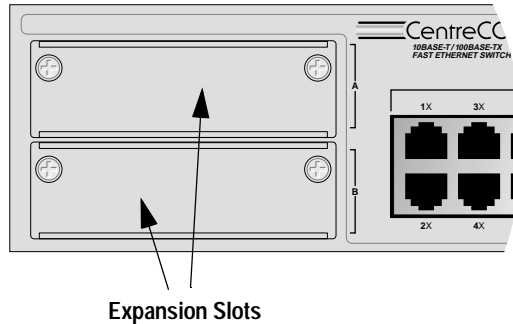

Figure 1-9 Expansion Slots

The modules offer you flexibility in building or expanding your network. For example, you can use the modules to build a high-speed backbone network between different switches, to expand the number of ports on a switch for additional nodes, or to provide a high-speed connection to shared devices, such as servers or routers.

Optional Expansion Modules

Table 1-4 lists the optional expansion modules for the AT-8316F and AT-8324 Ethernet switches. The modules can be installed in any combination in the switch. For example, you can install an AT-A15/LX module in one expansion slot and an AT-A18 module in the second expansion slot of the same switch.

Table 1-4 Optional Expansion Modules

Module	Number of Ports	Type of Port	Type of Connector	Maximum Distance
AT-A15/SX	1	1000Base-SX	SC	550 meters ¹ (1,804 feet)
AT-A15/LX	1	1000Base-LX	SC	10 kilometers ² (6.2 miles)
AT-A16	2	100Base-FX	VF-45	2 kilometers ³ (6,600 feet)
AT-A17	2	100Base-FX	SC	2 kilometers ³ (6,600 feet)
AT-A18	4	10/100Base-TX	RJ-45	100 meters (328 feet)
AT-A19	2	100Base-FX	MT-RJ	2 kilometers ³ (6,600 feet)

1. Assumes 50/125 micron multimode fiber optic cabling.

2. Assumes 9/125 micron single-mode fiber optic cabling.

3. Assumes 50/125 micron or 62.5/125 micron multimode fiber optic cabling and full-duplex operation.

Figure 1-10 illustrates the front panels of the expansion modules.

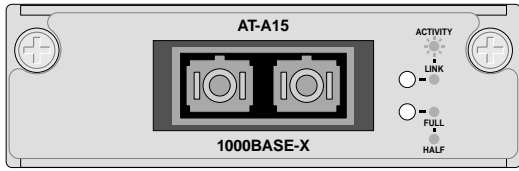

AT-A15 (SX or LX)



AT-A16

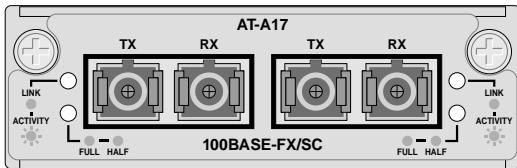

AT-A17

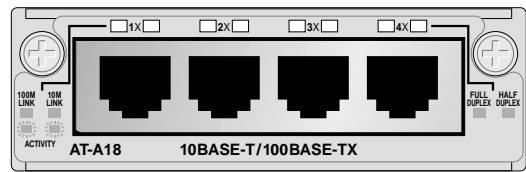

AT-A18

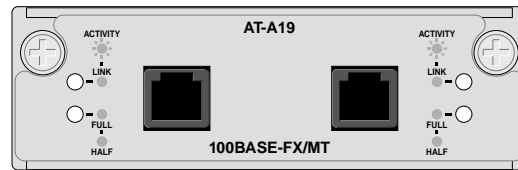

AT-A19

Figure 1-10 Optional Expansion Modules

R.P.S Input Connector

On the back panel of the Ethernet switch is a connector labelled R.P.S. Input (shown in Figure 1-11). This connector is used to connect the switch to a redundant power supply (RPS) unit. The RPS shares the load of powering the switch with the standard power supply that comes with the Ethernet switch. If one power supply fails, the remaining unit provides all power to the switch, thus protecting the switch from a system failure.

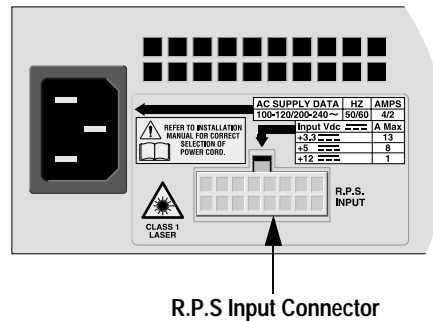

Figure 1-11 R.P.S Input Connector

Allied Telesyn offers the AT-RPS8000 redundant power supply system for the AT-8316F and AT-8324 switches. The RPS system comes with one redundant power module pre-installed that can support one Ethernet switch. The AT-RPS8000 unit has three expansion slots for three additional redundant power modules, each of which can support an additional switch. Contact your Allied Telesyn representative for more information about the AT-RPS8000 redundant power supply unit.

Reset Button

The Reset button on the front panel of the switch resets the switch. It is primarily used for diagnostics or resetting the switch statistics stored by the AT-S25 management software. You can also reset the switch using the Omega management interface, as explained in the **AT-S25 Management Software User's Guide**. This guide is available from the Allied Telesyn web site at www.alliedtelesyn.com/techhome.htm.

Note

If it becomes necessary to reset a switch that is a part of a stack, you must reset all of the switches in the stack. You cannot reset just one switch in a stack. Additionally, you should reset the slave switches first, then the master switch. For information on slave and master switches, refer to **Chapter 3, Installing the Switch**.

AC Power Connector

The switch has a single AC power supply socket on the back panel, which has autoswitch AC inputs. The input voltage range is from 100-120/200-240 VAC, 4/2A, 50/60 Hz. The power cord acts as an ON/OFF switch.

AT-S25 Management Software and Omega Management Interface

The AT-S25 software is the management program for the switch, and it comes pre-installed on the unit. Included with the AT-S25 software is the Omega management interface. This menu oriented interface makes it easy for you to manage the system. With Omega, you can perform all of the tasks necessary to configuring and monitoring the system, such as creating VLANs, assigning operational parameters to the switch, such as an IP address and gateway address, and viewing switch statistics, all through menu selections and easy-to-use windows.

In a network environment where you have created a stack of Ethernet switches, you will use the Omega management interface to manage all of the switches in the stack as a unit, that is, as one logical switch. You will not manage each switch in a stack separately.

There are several different methods for accessing the Omega management interface on an Ethernet switch:

- RS-232 connector on the switch
- Web browser
- Telnet program
- SNMP network management program

The Omega interface functions the same and has the same capabilities regardless of the method you choose to access it. The program has security features that allow you to disable one or more of the access methods to prevent unauthorized access to a switch. The program also has a password security feature.

Note

For instructions on how to access and how to use the Omega management interface, refer to the **AT-S25 Management Software User's Manual**. This guide is available from the Allied Telesyn web site at www.alliedtelesyn.com/techhome.htm.

Network Topology

Figure 1-12 is an example of a network consisting of AT-8316F and AT-8324 Ethernet switches. Some of the features of the network include the following:

- ❑ Though the Sales and Technical Support workgroups are distributed between several sites, the 802.1Q VLAN capabilities of the switches allow you to easily separate their traffic, improving network performance and enhancing network security as well.
- ❑ The stack of four switches at site 1 are interconnected with an AT-Stack8 stacking module.
- ❑ Port trunking at site 1 provides 200 Mbps of full-duplex operation to the network servers in the server farm.
- ❑ Expansion modules in the switches provide interconnections between the various sites. For example, site 1 and site 2 each have AT-A15/LX expansion modules to provide 1000Base-LX performance up to a maximum distance of 10 kilometers (6.2 miles).

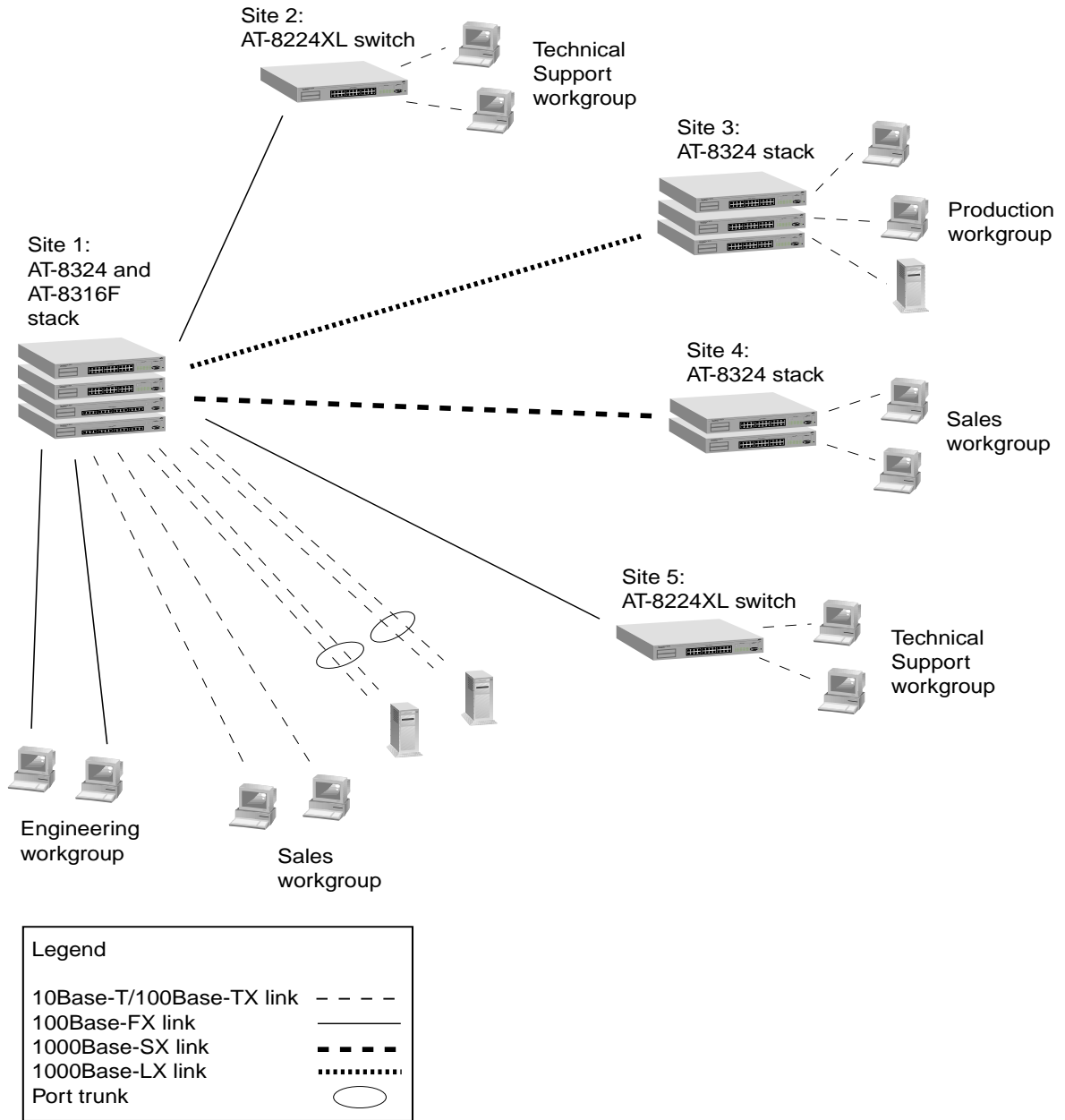

Figure 1-12 Topology Example

Where to Go Next

Proceed to Chapter 2 for information on how to plan the installation.

Chapter 2

Planning the Installation

This chapter contains information that will help you plan the installation of the switch. The information includes:

- AT-8316F and AT-8324 Switch Cabling Specifications
- Switch stacks
- Expansion Modules
- Port Trunking

AT-8316F and AT-8324 Switch Cabling Specifications

Table 2-1 contains the cabling specifications for the data ports on the switches.

Table 2-1 Switch Cabling Specifications

Model	Type of Cabling	Maximum Distance
AT-8316F (models MT, VF, and SC)	50/125 micron multimode or 62.5/125 micron multimode	Full-duplex: 2 kilometers (1.25 miles) Half-duplex: 412 meters (1,351 feet)
AT-8324	10Base-T operation: Category 3 or better 100Base-TX operation: Category 5 or better	100 meters (328 feet) 100 meters (328 feet)

Note

To connect a workstation or server to a twisted pair port on an AT-8324 switch, use a straight-through cable. To connect a hub, router, or other switch to a twisted pair port on the AT-8324 switch, use a crossover cable.

Switch Stacks

On the back panel of the Ethernet switches are two stacking ports. You use these ports to interconnect switches together to create a stack. A stack of switches functions as one logical switch, rather than as individual units.

A stack can consist of from two to eight switches. As explained in the following sections, building a stack of two or three switches does not require any additional hardware. A stack of from four to eight switches requires the optional AT-Stack8 module.

Stack of Two or Three Switches

Creating a stack of two or three Ethernet switches requires no additional hardware other than the AT-CABLE-4 cable that comes with the switches. Figure 2-1 illustrates two Ethernet switches that have been interconnected through the stacking ports to form a logical switch.

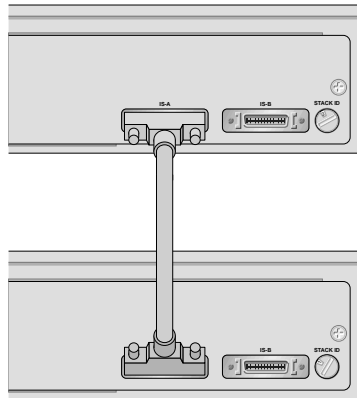

Figure 2-1 Stack of Two Ethernet Switches

Creating a stack of three switches also does not require any additional hardware, as illustrated in Figure 2-2.

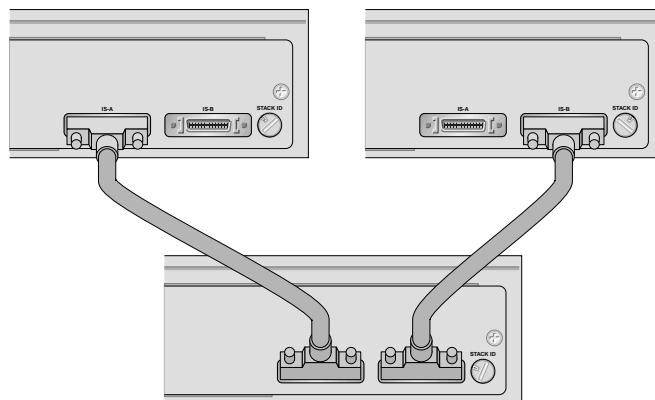

Figure 2-2 Stack of Three Ethernet Switches

Stack of Four to Eight Switches

In order to create a stack of from four to eight AT-8316F or AT-8324 Ethernet switches, you need the optional AT-Stack8 Stacking Matrix Module (shown in Figure 2-3). This module has eight ports, each providing two gigabits of full-duplex bandwidth. Each stack requires only one stacking module. You install the module into one of the switches of the stack and then connect all of the switches to the module using the AT-CABLE-4 cables.

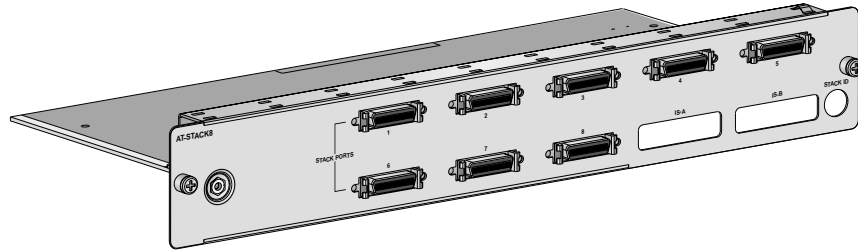

Figure 2-3 AT-Stack8 Stacking Matrix Module

Expansion Modules

If you are building a stack of Ethernet switches, it is important to know that the more switches in the stack, the fewer number of expansion modules allowed. (This relates to the number of device identification numbers that are available to the switches.)

Table 2-2 lists the number of expansion modules that you can install in stacks of one to eight switches. For example, for a stack of six switches you could install a total of eight expansion modules. The expansion modules themselves can be installed in any switch in a stack, and in any order.

Table 2-2 Permitted Number of Expansion Modules

Number of Switches in the Stack	Total Number of Expansion Slots in the Stack	Permitted Number of Expansion Modules
1	2	2
2	4	4
3	6	6
4	8	8
5	10	10
6	12	8
7	14	4
8	16	0

Table 2-3 contains the cabling specifications for the expansion modules.

Table 2-3 Expansion Module Cabling Specifications

Model	Type of Cabling ¹	Maximum Distance
AT-A15/SX	50/125 micron multimode fiber	550 meters ² (1,804 feet)
	62.5/125 micron multimode fiber	275 meters (902 feet) ³
AT-A15/LX	9/125 micron single-mode fiber	10 kilometers (6.2 miles)
	50/125 micron or 62.5/125 micron multimode fiber	550 meters (1,804 feet) ²
AT-A16	50/125 micron or 62.5/125 micron multimode fiber	Full-duplex: 2 kilometers (1.25 miles) Half-duplex: 412 meters (1,351 feet)
AT-A17	50/125 micron or 62.5/125 micron multimode fiber	Full-duplex: 2 kilometers (1.25 miles) Half-duplex: 412 meters (1,351 feet)
AT-A18	10Base-T operation: Category 3 or better	100 meters (328 feet)
	100Base-TX operation: Category 5 or better	100 meters (328 feet)
AT-A19	50/125 micron or 62.5/125 micron multimode fiber	Full-duplex: 2 kilometers (1.25 miles) Half-duplex: 412 meters (1,351 feet)

1. Refer to the IEEE 802.3 Standard for additional cable information.
2. Assumes a fiber optic cable rating of 500 Mhz/Km.
3. Assumes a fiber optic cable rating of 200 Mhz/Km

Port Trunking

As explained in Chapter 1, port trunking, also referred to as “link aggregation,” is an economical way for you to increase the bandwidth between an AT-8316F or AT-8324 switch and another network device, such as a server, router, workstation, or another switch. A port trunk is two or more data ports that have been grouped together to increase the bandwidth between a switch and a network node. This increase in bandwidth can prove useful in situations where a single connection between the switch and another node is insufficient to handle the traffic load.

When ports are trunked together, they act as one logical path. The increase in bandwidth is equal to the port speed times the number of ports trunked together. For example, if you were to trunk together four 100 Mbps ports, the result would be 400 Mbps of bandwidth.

The AT-8316F and AT-8324 switches allow you to trunk together two, four, or eight ports, providing 200 Mbps, 400 Mbps, or 800 Mbps of throughput. You can also trunk the ports on an expansion module to increase the bandwidth from an expansion module to another network device.

When implementing a port trunk, you will need to observe the following guidelines:

Guideline 1: Number of Ports in a Trunk

The number of ports in a port trunk must be 2, 4, or 8 ports.

Guideline 2: Using Ports from the Same Group

The ports on the Ethernet switches are divided into groups. When choosing ports for a port trunk, the selected ports must be members of the same group. You cannot create a port trunk consisting of ports from different groups.

The ports on an AT-8324 switch are divided into five groups, as illustrated in Figure 2-4.

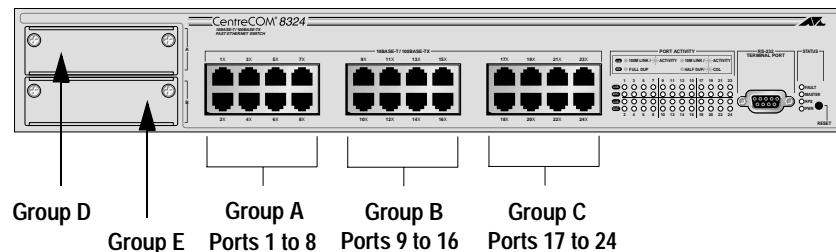

Figure 2-4 Port Groupings on an AT-8324 Switch

The ports on the AT-8316/MT and AT-8316/VF switches are divided into four groups, as shown in Figure 2-5.

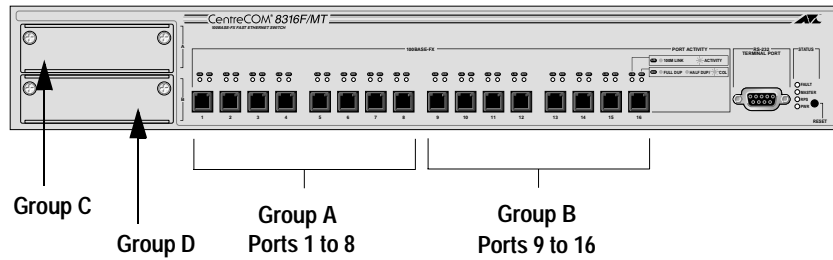

Figure 2-5 Port Groups on an AT-8316F/MT or AT-8316/VF Switch

The ports on the AT-8316/SC switch also are divided into four groups, as shown in Figure 2-6.

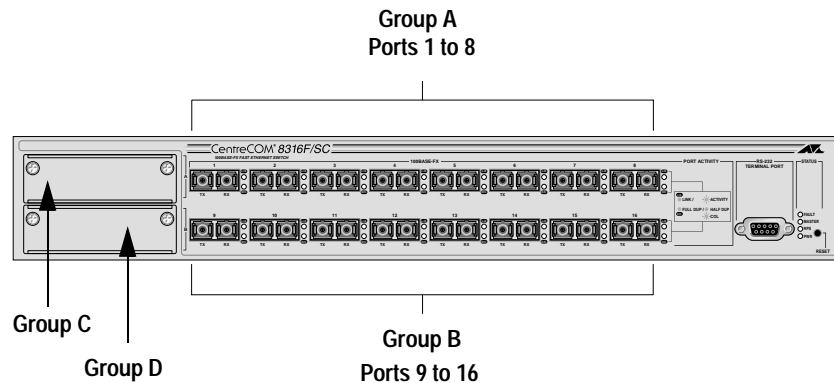

Figure 2-6 Port Groups on an AT-8316F/SC Switch

As mentioned previously, the ports for a port trunk must be members of the same group. A port trunk cannot consist of ports from different groups. For example, you could use ports 4 and 5 on an AT-8324 switch as one port trunk, and this would be valid since the ports are members of the same group. However, ports 7, 8, 9, and 10 cannot be combined to form one port trunk on an AT-8324 switch because these ports belong to different groups.

**Guideline 3:
Creating Only
One Trunk Per
Group**

Each group of ports on an Ethernet switch can support only one port trunk. For example, the AT-8324 Ethernet switch has three port groups, assuming no expansion modules. Consequently, this switch can support three port trunks, one port trunk for each port group. The addition of two expansion modules would enable the switch to support two additional port trunks, one for each module.

**Guideline 4:
Using
Consecutive
Ports**

The ports of a trunk must be consecutive. For example, you could use ports 4, 5, 6, and 7 as one port trunk, and this would be valid because the ports are consecutive. However, an invalid selection of ports for a trunk would be 1, 3, 5, and 7 since these ports are not consecutive.

Guideline 5: Cabling Based on Port Number

When cabling a trunk, it is important that the order of the connections be identical on both nodes. The lowest numbered port in a trunk must be connected to the lowest numbered port on the trunk on the other device, the next lowest numbered port must be connected to the next lowest numbered port on the other device, and so on.

For example, assume that you were installing a trunk from an AT-8316F/SC switch to an AT-8324 switch. On the AT-8316F/SC switch you had decided to use ports 12, 13, 14, 15 from port group two for the trunk. On the AT-8324 switch you had chosen ports 21, 22, 23, and 24 from port group 3. To maintain the order of the port connections, you would connect port 12 on the AT-8316F/SC switch to port 21 on the AT-8324XL, port 13 to port 22, and so on.

Guideline 6: Using Expansion Modules

Expansion modules also support port trunking. That is, you can group the ports on an expansion module together to increase the bandwidth to the end-node, whether that happens to be another switch, a server, or router. Table 2-4 lists the number of port trunks that you can create for each expansion module.

Table 2-4 Trunked Ports on Expansion Modules

Model of Expansion Module	Trunked Ports
AT-A15 (SX or LX)	0
AT-A16	2 ports
AT-A17	2 ports
AT-A18	2 or 4 ports
AT-A19	2 ports

Where to Go Next

Go to Chapter 3 for instructions on how to install the switch as a standalone unit or as part of a stack.

Chapter 3

Installing the Switch

This chapter describes the following installation procedures:

- Verifying the Package Contents
- Reviewing Safety Precautions
- Selecting a Site for the Switch
- Installing the Switch as a Standalone Unit
- Installing the Switch in a Rack
- Building a Stack of Two Switches
- Building a Stack of Three Switches
- Building a Stack of Four to Eight Switches
- Setting Up a Terminal for Local Management
- Modifying an Existing Stack
- Installing an Expansion Module

Verifying the Package Contents

Make sure the following hardware components are included in your switch package. If any of the following items are missing or damaged, contact your Allied Telesyn sales representative.

- One AT-8316F/MT, AT-8316F/VF, AT-8316F/SC, or AT-8324 switch
- Two mounting brackets
- Six flathead Phillips screws
- Power cord (Americas, EC, Australia, and UK only)
- One AT-CABLE-4 cable
- One AT-8316F/MT, AT-8316F/VF, AT-8316F/SC, and AT-8324 Quick Install Guide
- Warranty card

Reviewing Safety Precautions

Please review the following safety precautions before you begin to install the switch in your network. Refer to Appendix A for translated safety statements in your language.



Laser

Class 1 laser product. 6



Laser

Do not stare into the laser beam. 7



Caution

Electric Shock Hazard: To prevent electric shock, do not remove the cover. There are no user-serviceable parts inside. The unit contains hazardous voltages and should only be opened by a trained and qualified technician. 8



Caution

Lightning Danger: Do not work on this equipment or cables during periods of lightening activity. 9



Caution

Power cord is used as a disconnection device: To de-energize equipment, disconnect the power cord. 10



Caution

Electrical-Type Class 1 Equipment: This equipment must be earthed. The power plug must be connected to a properly wired earth ground socket outlet. An improperly wired socket outlet could place hazardous voltages on accessible metal parts. 11



Caution

Pluggable Equipment: The socket outlet should be installed near the equipment and should be easily accessible. 12



Caution

Air vents: The air vents must not be blocked on the unit and must have free access to the room ambient air for cooling. 13



Caution

Operating Temperature: This product is designed for a maximum ambient temperature of 40°C. 14



Caution

All Countries: Install this product in accordance with local and National Electric Codes. 15

Selecting a Site for the Switch

Be sure to observe the following requirements when choosing a site for your switch:

- Make sure that the switch's power is accessible and cables can be connected easily.
- Cabling must be away from sources of electrical noise such as radios, transmitters, broadband amplifiers, power lines, electric motors, and fluorescent fixtures.
- Air flow around the switch and through its vents on the side and rear must not be restricted.
- If you are installing the switch on a desk, make sure it is placed on a level, secure desktop.
- Do not place objects on top of the switch.
- Do not expose the switch to moisture or water.
- Make sure it is in a dust-free environment.
- Use dedicated power circuits or power conditioners to supply reliable electrical power to the network devices.

Having selected a site to install the switch, go to one of the following procedures:

- Installing the Switch as a Standalone Unit** on page 3-43
- Building a Stack of Two Switches** on page 3-46
- Building a Stack of Three Switches** on page 3-49
- Building a Stack of Four to Eight Switches** on page 3-52

Installing the Switch as a Standalone Unit

This section contains the procedure for installing an AT-8316F or AT-8324 switch as a standalone unit (not as part of a stack). To install the switch as a standalone unit, perform the following steps:

1. Remove all components from their shipping package and store the packaging material in a safe location.
2. Locate a level, secure surface for the switch.
3. If you purchased an expansion module for a switch, install the module by performing the procedure **Installing an Expansion Module** on page 3-60.
4. If you want to install the switch in a rack, perform the procedure **Installing the Switch in a Rack** on page 3-45.
5. Apply AC power to the switch by plugging the power cord into the AC power connector on the back panel of the unit (shown in Figure 3-1) and plugging the other end into a wall outlet.



Figure 3-1 AT-8316F and AT-8324 Ethernet Switch Rear Panel



Caution

The power cord is used as a disconnect device. To de-energize equipment, disconnect the power cord. ⚡ 10

As power is applied to the switch, the Fault LED (shown in Figure 3-2) flashes as the switch runs a series of internal self tests. After the switch has finished running its self tests, the Fault LED will stop flashing and will remain OFF.

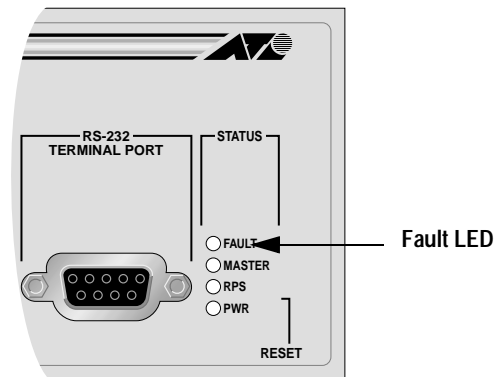

Figure 3-2 Fault LED

For information on all the switch LEDs, refer to the section **Switch LEDs** on page 1-16.

6. If you purchased a redundant power supply (RPS) unit for the Ethernet switch, connect the RPS unit to the R.P.S. Input connector on the rear of the switch by following the directions included with the RPS system.



Caution

If you intend to use a redundant power supply (RPS) with the switch, check to be sure that the cable with the RPS unit is compatible with the RPS Input Port on the switch. The pin assignments for the port are provided in Appendix B.

7. Connect the data cables to the ports on the switch.
8. Go to the procedure **Setting Up a Terminal for Local Management** on page 3-59 to access the Omega management software on the switch.

Installing the Switch in a Rack

To install the Ethernet switch in a standard 19-inch rack, perform the following steps:

1. Remove all components from the shipping package and store the packaging material in a safe location.
2. Locate a level, secure surface for the switch.
3. Remove the snap-on plastic feet from the bottom of the switch, as shown in Figure 3-3.

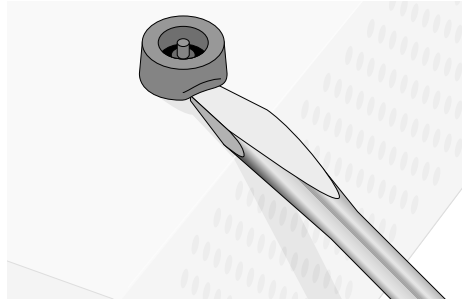

Figure 3-3 Removing the Feet

4. Attach the rackmounting brackets to each side of the switch, using the six flathead screws that came in the switch package as shown in Figure 3-4.

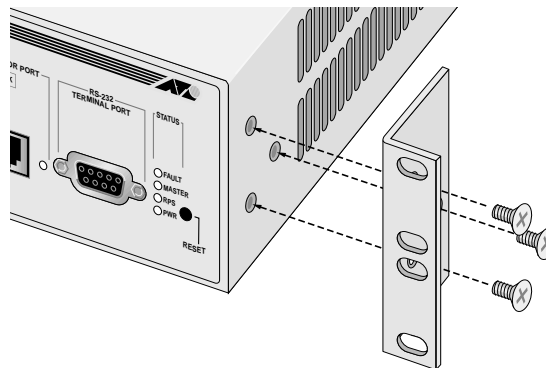

Figure 3-4 Attaching Rackmounting Brackets



Caution

Air vents must not be blocked and must have free access to the room ambient air for cooling. 13

5. Mount the switch in the rack using standard screws (not provided).

Building a Stack of Two Switches

To build a stack of two switches, perform the following steps:

1. Select one of the Ethernet switches to be the master switch of the stack. The other switch will be slave switch. In selecting the master switch, follow these guidelines:
 - The master switch can be either an AT-8316F or AT-8324 switch.
 - If the two switches have different versions of the AT-S25 agent software, select the switch that has the most recent version of the AT-S25 software as the master switch.

Note

During network operations, the master switch will overwrite the AT-S25 software in the slave switches with its own version of the management software. This occurs even if a slave switch contains a more recent version of the AT-S25 software. For this reason, it is important that the switch you select to be the master switch have the most recent version of the management software of all the switches in the stack.

2. Remove all components from the shipping package and store the packaging material in a safe location.
3. Locate a level, secure surface for the switches.

Note

If you are building a stack from existing AT-8316F and AT-8324 switches, power OFF the Ethernet switches. If the switches are connected to an AT-RPS8000 redundant power supply unit, power OFF the AT-RPS8000 unit using the ON/OFF switch on the back panel of the unit.

4. If you purchased expansion modules for the switches, install the modules by following the instructions in the section **Installing an Expansion Module** on page 3-60.
5. To install the switches in a rack, perform the procedure **Installing the Switch in a Rack** on page 3-45.
6. Connect an AT-CABLE-4 cable between the IS-A ports on the back panel of the master and slave switches.

Figure 3-5 illustrates a stack of two switches connected with one AT-CABLE-4 cable between Port IS-A on the master switch and Port IS-A on the slave switch.

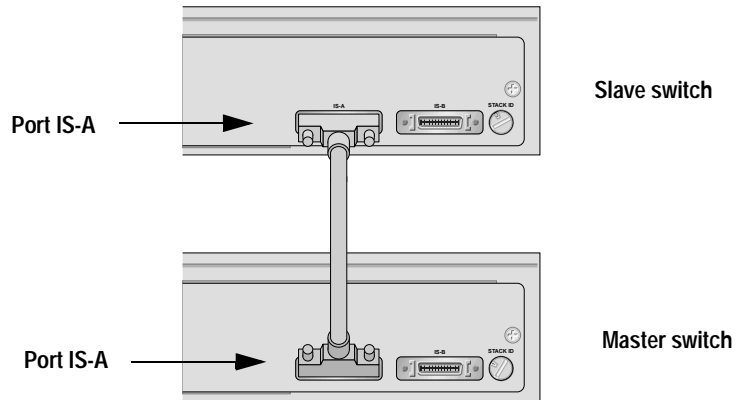

Figure 3-5 Stack of Two Switches with One AT-Cable-4 Cable

Figure 3-6 illustrates an invalid cabling configuration for a stack of two switches.

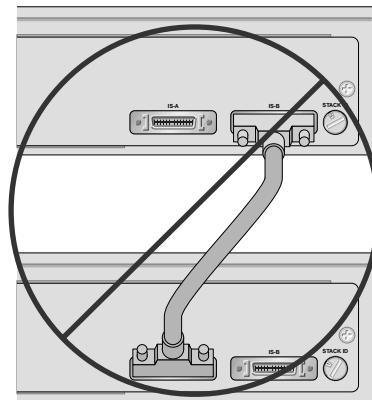

Figure 3-6 Invalid Cabling Configuration for a Stack of Two Switches

7. Set the Stack ID switch on the master switch to 1. Refer to Figure 3-7.

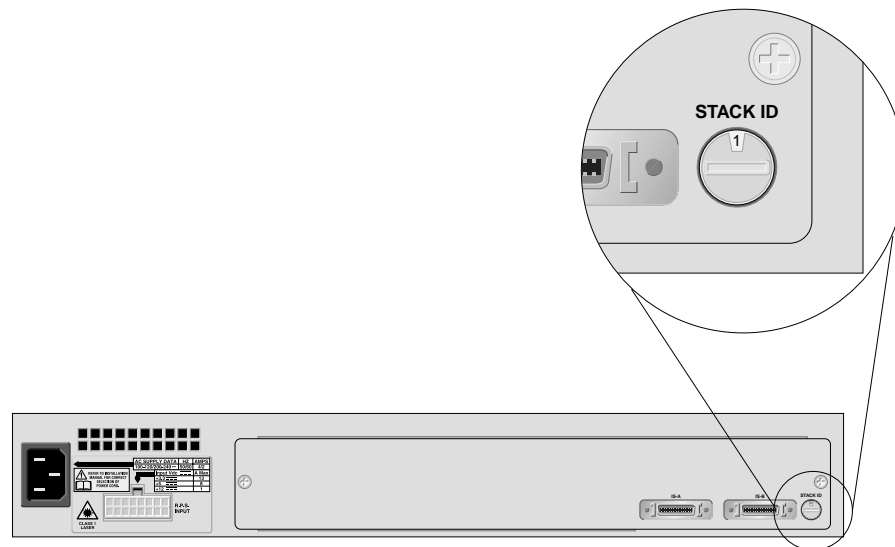

Figure 3-7 Stack ID Switch

8. Set the Stack ID switch on the slave switch to 2.
9. Connect the data cables to the ports on the front of each switch.
10. Go to the procedure **Powering On a Stack** on page 3-57.

Building a Stack of Three Switches

To build a stack of three switches, perform the following steps:

1. Select one of the Ethernet switches as the master switch of the stack. The other two switches will be slave switches. In selecting the master switch, follow these guidelines:
 - The master switch can be either an AT-8316F or AT-8324 switch.
 - If the switches have different versions of the AT-S25 agent software, select the switch that has the most recent version of the AT-S25 software as the master switch.

Note

During network operations, the master switch will overwrite the AT-S25 software in the slave switches with its own version of the management software. This occurs even if a slave switch contains a more recent version of the AT-S25 software. For this reason, it is important that the switch you select to be the master switch have the most recent version of the management software of all the switches in the stack.

2. Remove all components from the shipping package and store the packaging material in a safe location.
3. Locate a level, secure surface for the switches.

Note

If you are building a stack from existing AT-8316F and AT-8324 switches, power OFF the Ethernet switches. If the switches are connected to an AT-RPS8000 redundant power supply unit, power OFF the AT-RPS8000 unit using the ON/OFF switch on the back panel of the unit.

4. If you purchased expansion modules for the switches, install the modules by performing the procedure **Installing an Expansion Module** on page 3-60.
5. To install the switches in a rack, perform the procedure **Installing the Switch in a Rack** on page 3-45.

6. Connect one AT-CABLE-4 cable between the IS-A ports on the master switch and a slave switch, and another AT-CABLE-4 cable between the IS-B ports on the master switch and the other slave switch. Refer to Figure 3-8.

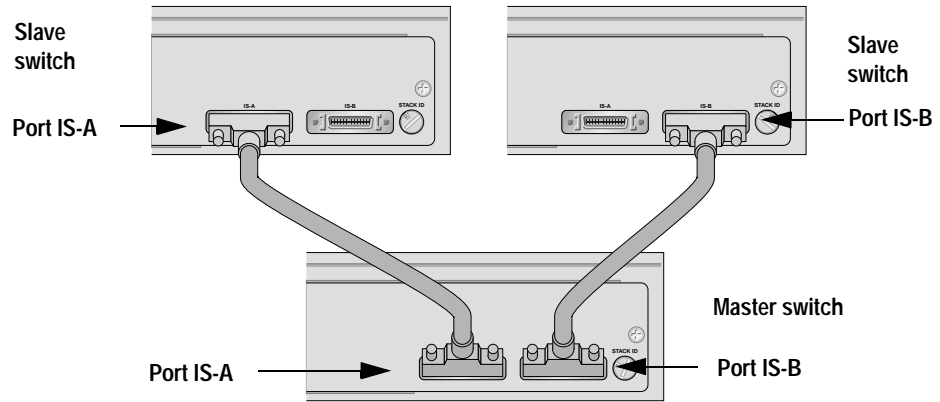

Figure 3-8 Valid Cabling Configuration for a Stack of Three Switches

Note

A stack of three switches can have only one cable between the switches.

Figure 3-9 illustrates an invalid cabling configuration for a stack of three switches.

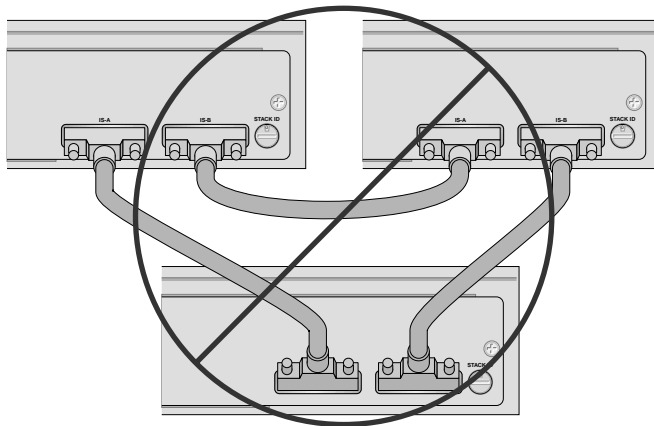

Figure 3-9 Invalid Cabling Configurations for a Stack of Three Switches

7. Set the Stack ID switch on the master switch to 1. Refer to Figure 3-7 for the location of the Stack ID switch.
8. Set the Stack ID switch on one slave switch to 2 and set the Stack ID switch on the other slave switch to 3.

Note

Do not use a setting of 0 (zero) or 9. These settings are invalid.

9. Connect the data cables to the ports on the front of each switch.
10. Go to the procedure **Powering On a Stack** on page 3-57.

Building a Stack of Four to Eight Switches

To build a stack of four to eight Ethernet switches with the optional AT-Stack8 Stacking Matrix Module, perform the following steps:

1. Select an AT-8316F or AT-8324 Ethernet switch in which to install the AT-Stack8 module. This switch will be referred to as the master switch. The other switches in the stack will be referred to as slave switches. In selecting the master switch, observe the following guidelines:
 - ❑ The AT-Stack8 module can be installed in either an AT-8316F or AT-8324 switch, even in stacks that will consist of a combination of AT-8316F and AT-8324 switches.
 - ❑ If the Ethernet switches have different versions of the AT-S25 software, install the module into the switch that has the most recent version of the software.

Note

During network operations, the master switch will overwrite the AT-S25 software in the slave switches with its own version of the management software. This occurs even if a slave switch contains a more recent version of the AT-S25 software. For this reason, it is important that the switch you select to be the master switch have the most recent version of the management software of all the switches in the stack.

2. Remove all components from the shipping package and store the packaging material in a safe location.
3. Locate a level, secure surface for the switches.

Note

If you are building a stack from existing AT-8316F and AT-8324 switches, power OFF all the Ethernet switches that will be a part of the stack. If the switches are connected to an AT-RPS8000 redundant power supply unit, power OFF the AT-RPS8000 unit using the ON/OFF switch on the back panel of the unit.

4. If you purchased optional expansion modules for the switches, install the modules by performing the procedure **Installing an Expansion Module** on page 3-60.
5. To install the switches in a rack, perform the procedure **Installing the Switch in a Rack** on page 3-45.

6. Remove the blank panel from the back of the switch selected to be the master switch by unscrewing the two captive screws. Refer to Figure 3-10.

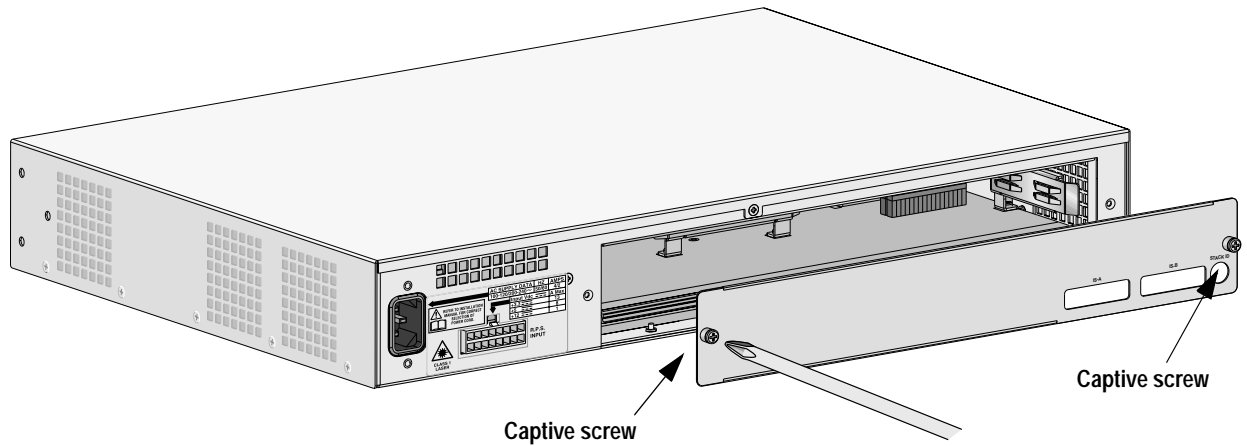

Figure 3-10 Removing the Blank Panel from an Ethernet Switch

7. Remove the AT-Stack8 module from its shipping package and store the packaging material in a safe location.
8. Slide the AT-Stack8 module into the expansion slot making sure that the board is aligned properly with the card guides. Slide the board into the switch until it snaps into place. Refer to Figure 3-11.

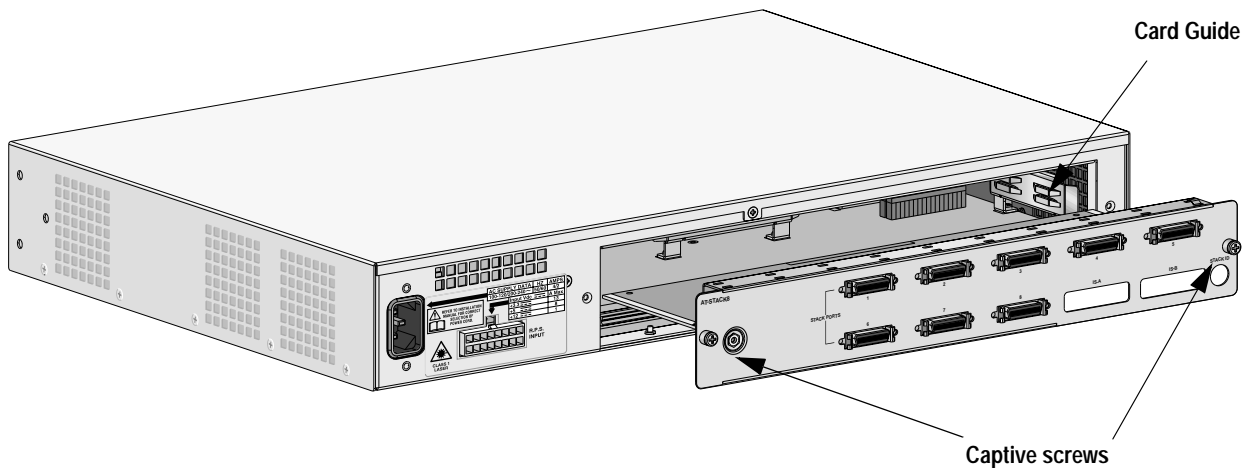

Figure 3-11 Installing the AT-Stack8 Module

9. Secure the AT-Stack8 module by tightening the two captive screws.
10. Connect one end of an AT-CABLE-4 cable to Port 1 on the AT-Stack8 module and the other end to Port IS-A on the master switch. Refer to Figure 3-12.

Note

Port 1 on the stacking module must be connected to Port IS-A on the master switch.

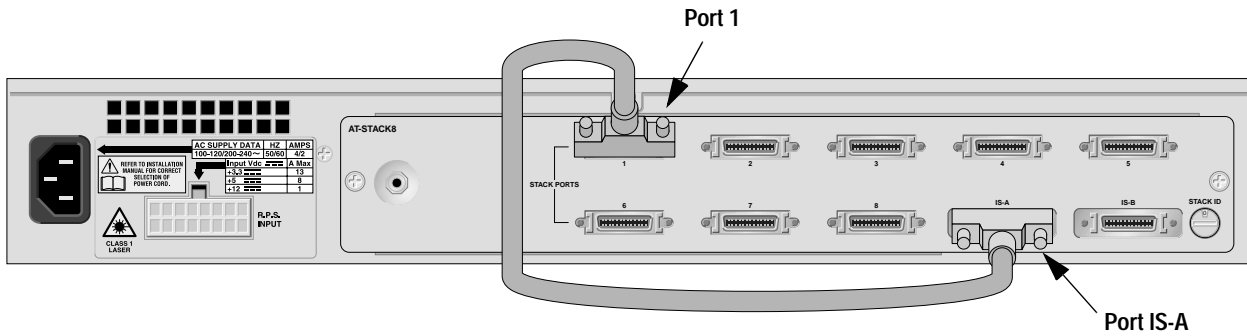

Figure 3-12 Cabling the Master Switch with an AT-CABLE-4 Cable

11. Connect the slave switches to the stacking module using additional AT-CABLE-4 cables. When connecting an AT-CABLE-4 cable to a switch, be sure to connect it to the IS-A port on the back of the switch rather than the IS-B port.

Figure 3-13 illustrates an example of a stack of five switches.

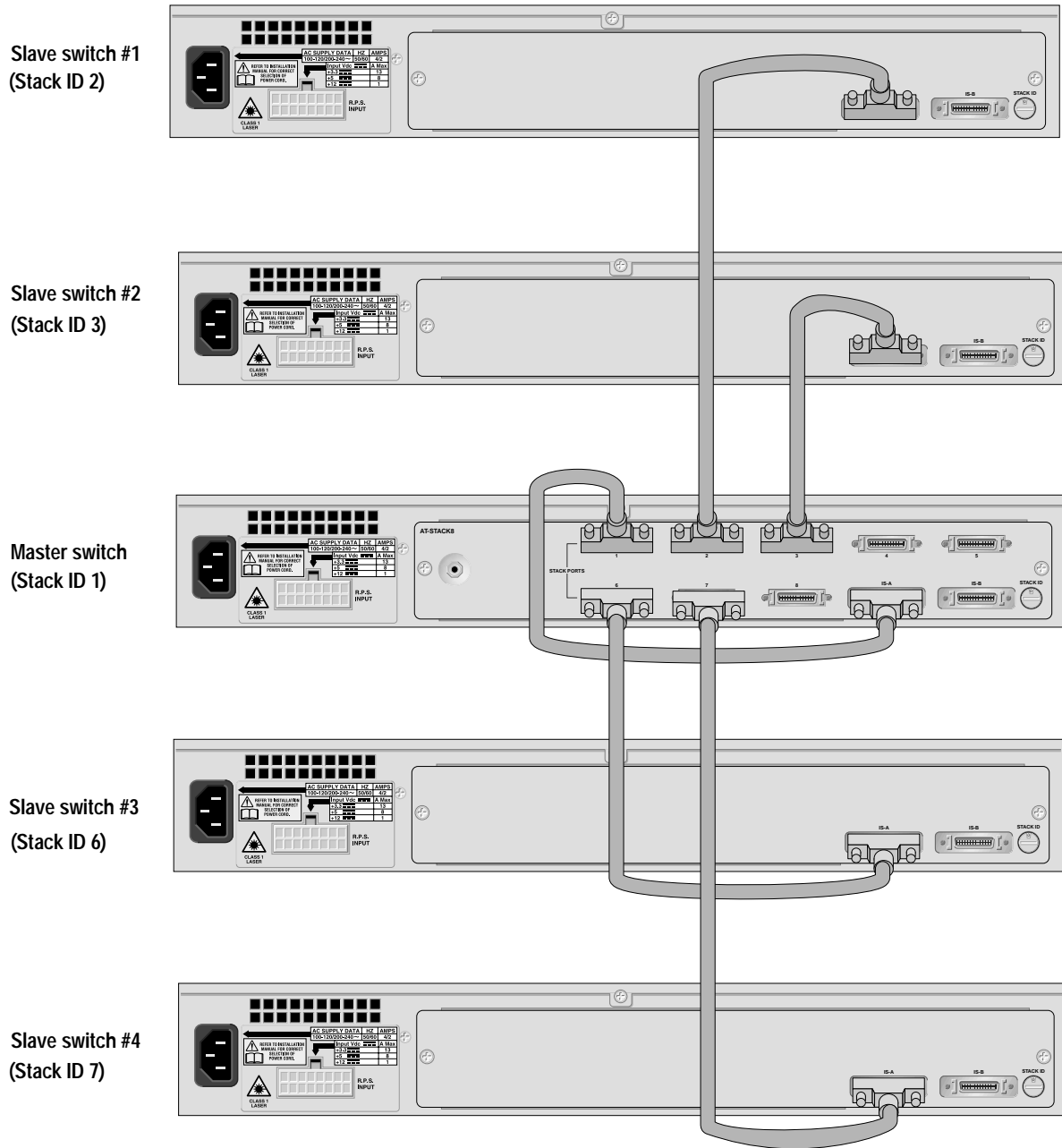

Figure 3-13 Example of a Stack of Five Switches

12. Set the Stack ID switch on the master switch to 1. Refer to Figure 3-7 for the location of the Stack ID switch.

Note

The Stack ID switch on the master switch must be set to 1.

13. Set the Stack ID switch on each slave switch to match the port number on the AT-Stack8 module to which the Ethernet switch is connected.

For example, referring to the stack example in Figure 3-13, the Stack ID setting for slave switch #1 would be 2 because it is connected to port 2 on the AT-Stack8 module. The Stack ID setting for slave switch #2 would be 3 it is connected to port 3 on the AT-Stack8 module. The Stack ID numbers for slave switch #3 would be 6 and the Stack ID setting for slave switch #4 would be 7.

Note

Do not use the Stack ID settings of 0 (zero) or 9 for any switch in a stack. These settings are invalid.

14. Connect the data cables to the ports on the front of each switch.
15. Go to the procedure **Powering On a Stack** on page 3-57.

Powering On a Stack

To power on an Ethernet stack, perform the following procedure:

1. Apply AC power to each slave and master switch in the stack by plugging a power cord into the AC power connector on the back panel of the switch (shown in Figure 3-1) and plugging the other end into a wall outlet.

To simplify the process, you can connect all of the switches, both master and slaves, to the same power circuit, such as a power strip, and so be able to apply power to all of the switches at the same time. If you power ON the switches individually, you should apply power to the slave switches first, and then the master switch.



Caution

The power cord is used as a disconnect device. To de-energize equipment, disconnect the power cord. *See* 10

As power is applied to a switch, the Fault LED (shown in Figure 3-14) flashes as a series of internal self tests are performed and as the hardware is configured. Wait for the Fault LED to stop flashing and remain OFF.

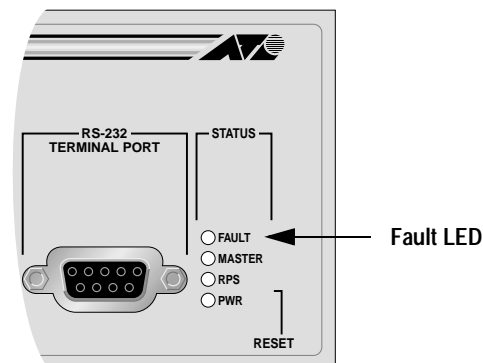

Figure 3-14 Fault LED

For further information on the switch LEDs, refer to the section **Switch LEDs** on page 1-16.

2. Wait while the master switch performs the topology discovery process. The master switch performs the process in order to determine the number and types of switches that are in the stack. During the discovery process, which takes less than one minute to complete, the port LEDs on each switch will flash in sequence, the slave switches first and the master switch last.

3. If you purchased a redundant power supply (RPS) unit for the Ethernet switches, connect the RPS unit to the R.P.S. Input connectors on the rear of the switch by following the directions included with the RPS system.



Caution

If you intend to use a redundant power supply (RPS) with the switch, check to be sure that the cable with the RPS unit is compatible with the RPS Input Port on the switch. The pin assignments for the port are provided in Appendix B.

4. Go to the next procedure, **Setting Up a Terminal for Local Management** on page 3-59, to access the Omega management software on the switch.

Setting Up a Terminal for Local Management

If you are installing the switch in a TCP/IP environment or if you intend to manage the switch from a remote site, you must first assign an IP address to the switch using the Omega management interface, which comes pre-installed on the switch. This is accomplished by connecting a terminal (such as a VT100 terminal) or a PC with a terminal emulation program to the RS232 port on the master switch, as explained in the following steps:

1. Using an RS232, DB-9 straight-through cable, connect a terminal or a PC with a terminal emulation program to the RS232 connector on the front panel of the master switch.

Note

Only the RS232 port on the master switch of a stack is active. The RS232 ports on the slave switches are inactive and cannot be used to manage a stack.

2. Configure the terminal or the terminal emulation program to the following settings:
 - Baud rate: **9600**
 - Data bits: **8**
 - Parity: **None**
 - Stop bits: **1**
 - Flow control: **None**
3. Press **Return**.

The switch displays the Omega main menu.

You are now ready to use the Omega management interface to configure the switch. For instructions, refer to the **AT-S25 Management Software User's Guide**. This guide is available on the Allied Telesyn web site at www.alliedtelesyn.com/techhome.htm.

Installing an Expansion Module

This section contains the instructions for installing an optional expansion module in a switch. For information on cabling specifications for the expansion modules, refer to the section **Expansion Modules** on page 2-33.

To install an expansion module, perform the following steps:

1. Disconnect the switch's power cord, if attached.



Caution

Be sure to disconnect the power cord to the switch before installing an expansion module. If the switch is connected to a redundant power supply (RPS) unit, disconnect the switch from the RPS unit as well. Installing the expansion module with the switch powered ON can damage the module.

2. Remove a blank faceplate from one of the expansion slots on the front of the switch by unscrewing the faceplates two captive screws. Refer to Figure 3-15. Do not remove the blank faceplate if you are not installing an expansion module in the slot.

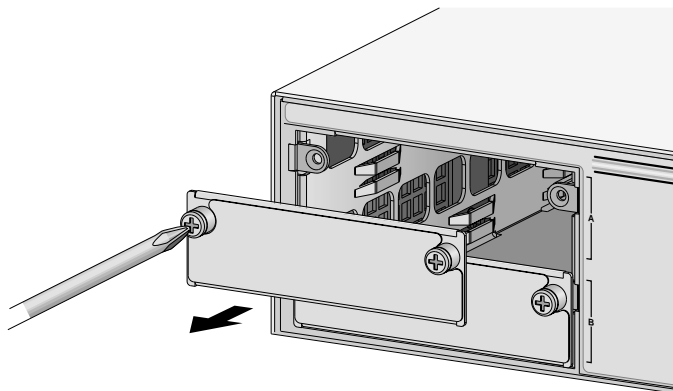

Figure 3-15 Removing the Blank Panel

If you are installing only one expansion module in the switch, install the module in slot A. While the module will work in slot B with slot A empty, the port numbering assignments will change if you later install a module in slot A. This could affect VLAN memberships on the switch, and this could require you to adjust your VLAN configurations.

For example, if you install an AT-A17 in slot B of an AT-8324 switch while leaving slot A empty, the switch will assign the port numbers 25 and 26 to the ports on the module. If you later install another AT-A17 in slot A, the switch will automatically reallocate port numbers 25 and 26 to the new module in slot A and assign the port numbers 27 and 28 to the module in slot B. If the module in slot B had been a member of a VLAN, you would be required to reconfigure the VLAN to reflect the change to its port numbers.

3. Remove the expansion module from the packing material.
4. Slide the expansion module into the empty slot making sure the board is aligned properly with the card guides. Refer to Figure 3-16.

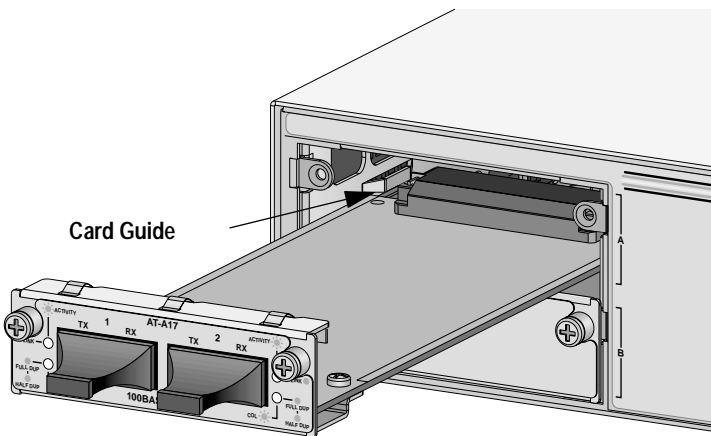

Figure 3-16 Installing an Expansion Module

5. Secure the expansion module to the switch by tightening the captive screws.
6. Connect the cabling to the ports on the expansion module.

Resetting a Stack

This section contains the procedure for resetting an AT-8316F or AT-8324 switch stack.

Note

You cannot reset just one switch in a switch stack. You must reset the entire stack.

To reset a stack, perform the following procedure:

1. Press the Reset button on the front panel of the slave switches.
2. Press the Reset button on the master switch.

Note

You should reset the slave switches first, before the master switch.

Each switch in the stack will perform a series of internal self-tests, indicated by a flashing Fault LED (shown in Figure 3-2). After a switch has finished running its self tests, the Fault LED will stop flashing and will remain OFF.

3. Wait while the master switch performs the topology discovery process. This process is used by the master switch to determine the number and types of switches that constitute the stack. During the discovery process, which takes less than one minute to complete, the port LEDs on each switch will flash in sequence, the slave switches first and the master switch last.

Where to Go Next

Now that the switch is operational, you are ready to configure and monitor it as explained in the **AT-S25 Management Software User's Guide**, which is available from Allied Telesyn's web site at www.alliedtelesyn.com/techhome.htm.

Chapter 4

Troubleshooting

This chapter provides information on how to detect and resolve problems with your switch. This section includes the following sections:

- At the First Sign of a Problem
- Network Cabling Problems
- Calling Technical Support
- How the Switch Reports Problems
- Common Problems

At the First Sign of a Problem

Perform the following tasks when you first become aware of a problem with the switch:

- ❑ Make sure the power cord is securely connected and the power voltage is not fluctuating.
- ❑ Check the data cables for secure connections and make sure the device at the other end of a connection is operational.
- ❑ Reset the stack so that the switches can run self-diagnostics. For instructions, refer to the section **Resetting a Stack** on page 3-62.
- ❑ Use Omega to read statistics and run diagnostics. Refer to the **AT-S25 Management Software User's Guide** for further details on gathering Ethernet statistics and running diagnostics using the Omega menus.
- ❑ If the management software has failed, check the LEDs to see if the switch continues to forward packets. Then, at a convenient time, reset the stack, as explained in the section **Resetting a Stack** on page 3-62.
- ❑ If problems still persist, for example, the Fault LED remains ON, call Allied Telesyn's Technical Support or visit Allied Telesyn's web site at www.alliedtelesyn.com.

Network Cabling Problems

If you have an AT-8324 switch, some network problems may be related to exceeding cabling distances. Refer to the standard IEEE 802.3u, Clause 29.3.1.2 on **Worst Case Path Delay Value**. This document specifies that the collision domain diameter must be within the following limits:

- Under 100 meters (328 feet) for TX cabling
- Under 412 meters (1,332 feet) for half-duplex FX cabling

Calling Technical Support

When contacting Allied Telesyn for support on any of its products, you will need to provide Technical Support with the following information:

- Model and serial number
- Software version number
- Description of the problem

Refer to Allied Telesyn's web site at www.alliedtelesyn.com for a list of worldwide locations.

How the Switch Reports Problems

The switch detects and processes errors as follows:

- ❑ The LEDs indicate problems with the ports and power. Table 4-1 and Table 4-2 describe the switch LEDs.
- ❑ In a TCP/IP environment, if you have configured the software correctly, the management software triggers an SNMP trap message. As a result, the software then sends traps to alert the network manager when a trigger occurs. This type of software configuration allows the network administrator to proactively monitor the network.

Table 4-1, Table 4-2, and Table 4-3 list and describe the switch and expansion module LEDs. As power is applied to the switch, the Fault LED flashes as the switch runs internal self tests.

Table 4-1 Switch System LED Status

LED	State	Description
Fault	Solid Red	The switch or management software is malfunctioning.
	Flashing Red	The switch is booting, running diagnostic tests, writing messages to FLASH, or transferring files using XMODEM.
	Off	Normal operation.
Master	Solid Amber	The switch is functioning as the master switch for the stack.
	OFF	The switch is a slave switch.
RPS (Redundant Power Supply)	Solid Green	The RPS is connected to the switch. To verify that the RPS is operating correctly, refer to the instructions in the RPS Quick Install Guide.
Power	Solid Green	The switch is receiving power, the voltage is within the acceptable range, and the power supply is working.

Table 4-2 Switch Port LED Status

LED	State	Description
L/A (Link/Activity)	Solid Green	This indicates a 100 Mbps link.
	Flashing Green	This indicates 100 Mbps activity.
	Solid Amber	This indicates a 10 Mbps link. (10/100 ports only)
	Flashing Amber	This indicates 10 Mbps activity. (10/100 ports only)
D/C (Duplex/Collision)	Solid Green	The port is operating at full duplex.
	Solid Amber	The port is operating at half duplex.
	Flashing Amber	Collisions are occurring on the line.

Table 4-3 describes the LEDs on the optional expansion modules.

Table 4-3 Expansion Module Port LED Status

LED	State	Description
L/A (Link/Activity)	Solid Green	This indicates a 100 Mbps link.
	Flashing Green	This indicates 100 Mbps activity.
	Solid Amber	This indicates a 10 Mbps link (AT-A18 module only).
	Flashing Amber	This indicates 10 Mbps activity (AT-A18 module only).
D/C (Duplex/Collision)	Solid Green	The port is operating at full-duplex.
	Solid Amber	The port is operating at half-duplex.
	Flashing Amber	Collisions are occurring on the line.

Common Problems

This section lists common possible sources of error and actions required to correct them.

Link /Activity LED on Any Port is OFF

This can indicate:

- A loose data cable.
- The device at the other end of the connection is turned OFF.
- The data cable is not wired correctly (straight/crossed) for the device.
- The network administrator manually disabled the port through the software.
- The port's selected transmission mode does not match that of the attached device.

Perform the following steps in sequence; you need not proceed to the next step if the problem is resolved:

1. Make sure the data cables are secure.
2. Make sure the device at the end of the connection is turned ON.
3. Make sure the data cable is wired correctly (straight/crossed) for the device.
4. Logon to Omega if you can and check the port status (`Port status and configuration><port number> menu`).

If the port is Enabled, make sure the transmission speed matches that of the connected device (auto-negotiating, full- or half-duplex).

Refer to the **AT-S25 Management Software User's Guide** to check that the port is Disabled. If the port is Disabled, someone has manually disabled the port through the software for a specific reason. Verify that the reason no longer exists before you enable this port (`Port status and configuration`).

5. Contact Allied Telesyn's Technical Support for help.

Power LED is OFF

If there is no power to the switch, it cannot function.

A Power LED that is OFF can indicate:

- A loose power cord.
- Power supply failure, malfunction, or loss of power to the power supply.
- A power supply voltage below acceptable levels.
- A high switch temperature due to fan failure or extreme ambient temperature.

Perform the following steps in sequence; you need not proceed to the next step if the problem is resolved:

1. Secure the power cord to the power source and check the Power LED to see if it is ON.
2. Ensure that the voltage is within the required levels in your region.
3. Logon to Omega and run `Diagnostics` if you can (`Administration>Diagnostics`) and record any failures.
4. Contact Allied Telesyn's Technical Support and report the results of the tests.

Fault LED is ON

This might indicate problems with the network management software, such as:

- An unsuccessful software download
- A failure of the power-on diagnostics

Perform the following steps in sequence; you need not proceed to the next step if the problem is resolved:

1. Reset the stack either by:
 - Pressing the **RESET** button on the front panel of the switches in the stack, or
 - Selecting `Administration>Reset` and restart the system from Omega, if you can.
2. Make sure the RS-232 connection from the local terminal or PC to the master switch is secure; change the cable if necessary.

If you cannot access the switch locally because of a faulty RS-232 connection, try to access the switch through a web browser or remotely with Telnet or an SNMP network management program until the problem is fixed.

3. Unplug the switch from the power source, then plug it back in again.
4. Try to log on to Omega and run diagnostics (Administration>Diagnostics).
5. Download software using the Administration menu. Refer to the **AT-S25 Management Software User's Guide** that you downloaded from www.alliedtelesyn.com/techhome.htm for instructions.
6. Contact Allied Telesyn's Technical Support for help.

Appendix A

Translated Electrical Safety and Emission Information

IMPORTANT: This appendix contains multiple-language translations for the safety statements in this guide.

WICHTIG: Dieser Anhang enthält Übersetzungen der in diesem Handbuch enthaltenen Sicherheitshinweise in mehreren Sprachen.

VIGTIGT: Dette tillæg indeholder oversættelser i flere sprog af sikkerhedsadvarslerne i denne håndbog.

BELANGRIJK: Deze appendix bevat vertalingen in meerdere talen van de veiligheidsopmerkingen in deze gids.

IMPORTANT: Cette annexe contient la traduction en plusieurs langues des instructions de sécurité figurant dans ce guide.

TÄRKEÄÄ: Tämä liite sisältää tässä oppaassa esiintyvät turvaohjeet usealla kielellä.

IMPORTANTE: questa appendice contiene traduzioni in più lingue degli avvisi di sicurezza di questa guida.

VIKTIG: Dette tillegget inneholder oversettelser til flere språk av sikkerhetsinformasjonen i denne veiledningen.

IMPORTANTE: Este anexo contém traduções em vários idiomas das advertências de segurança neste guia.













IMPORTANTE: Este apéndice contiene traducciones en múltiples idiomas de los mensajes de seguridad incluidos en esta guía.

OBS! Denna bilaga innehåller flerspråkiga översättningar av säkerhetsmeddelandena i denna handledning.













Standards: This product meets the following standards.

U.S. Federal Communications Commission
<p>RADIATED ENERGY</p> <p>Note: This equipment has been tested and found to comply with the limits for a Class A digital device pursuant to Part 15 of the FCC Rules. These limits are designed to provide reasonable protection against harmful interference when the equipment is operated in a commercial environment. This equipment generates, uses, and can radiate radio frequency energy and, if not installed and used in accordance with this instruction manual, may cause harmful interference to radio communications. Operation of this equipment in a residential area is likely to cause harmful interference in which case the user will be required to correct the interference at his own expense.</p> <p>Note: Modifications or changes not expressly approved by the manufacturer or the FCC can void your right to operate this equipment.</p>













Industry Canada
<p>This Class A digital apparatus meets all requirements of the Canadian Interference-Causing Equipment Regulations.</p> <p>Cet appareil numérique de la classe A respecte toutes les exigences du Règlement sur le matériel brouilleur du Canada.</p>

- 1 RFI Emission EN55022 Class A
- 2  **WARNING:** In a domestic environment this product may cause radio interference in which case the user may be required to take adequate measures.
- 3 Immunity EN50082-1 1997
- 4 Electrical Safety EN60950, UL 1950, CSA 950
- 5  Laser EN60825
- SAFETY**
- 6  **WARNING:** Class 1 Laser product.
- 7  **WARNING:** Do not stare into the laser beam.
- 8  **ELECTRICAL NOTICES**
WARNING: ELECTRIC SHOCK HAZARD
To prevent ELECTRIC shock , do not remove the cover. No user-serviceable parts inside. This unit contains HAZARDOUS VOLTAGES and should only be opened by a trained and qualified technician. To avoid the possibility of ELECTRIC SHOCK, disconnect electric power to the product before connecting or disconnecting the LAN cables.
- 9  **LIGHTNING DANGER**
DANGER: DO NOT WORK on equipment or CABLES during periods of LIGHTNING ACTIVITY.
- 10  **CAUTION:** POWER CORD IS USED AS A DISCONNECTION DEVICE. TO DE-ENERGIZE EQUIPMENT, disconnect the power cord.
- 11  **ELECTRICAL - TYPE CLASS 1 EQUIPMENT**
THIS EQUIPMENT MUST BE EARTHED. Power plug must be connected to a properly wired earth ground socket outlet. An improperly wired socket outlet could place hazardous voltages on accessible metal parts.
- 12  **PLUGGABLE EQUIPMENT,** the socket outlet shall be installed near the equipment and shall be easily accessible.
- 13  **CAUTION:** Air vents must not be blocked and must have free access to the room ambient air for cooling.
- 14  **OPERATING TEMPERATURE:** This product is designed for a maximum ambient temperature of 40° degrees C.
- 15  **ALL COUNTRIES:** Install product in accordance with local and National Electrical Codes.













Normen: Dieses Produkt erfüllt die Anforderungen der nachfolgenden Normen.

- ☞ 1 Hochfrequenzstörung EN55022 Klasse A
 - ☞ 2  **WARNUNG:** Bei Verwendung zu Hause kann dieses Produkt Funkstörungen hervorrufen. In diesem Fall müßte der Anwender angemessene Gegenmaßnahmen ergreifen.
 - ☞ 3 Störsicherheit EN50082-1 1997
 - ☞ 4 Elektrische Sicherheit EN60950, UL 1950, CSA 950
 - ☞ 5  Laser EN60825
- SICHERHEIT**
- ☞ 6  **WARNUNG** Laserprodukt der Klasse 1.
 - ☞ 7  **WARNUNG** Nicht direkt in den Strahl blicken.
 - ☞ 8  **ACHTUNG: GEFÄHRLICHE SPANNUNG**
Das Gehäuse nicht öffnen. Das Gerät enthält keine vom Benutzer wartbaren Teile. Das Gerät steht unter Hochspannung und darf nur von qualifiziertem technischem Personal geöffnet werden. Vor Anschluß der LAN-Kabel, Gerät vom Netz trennen.
 - ☞ 9  **GEFAHR DURCH BLITZSCHLAG**
GEFAHR: Keine Arbeiten am Gerät oder an den Kabeln während eines Gewitters ausführen.
 - ☞ 10  **VORSICHT: DAS NETZKABEL DIENT ZUM TRENNEN DER STROMVERSORGUNG. ZUR TRENNUNG VOM NETZ, KABEL AUS DER STECKDOSE ZIEHEN.**
 - ☞ 11  **GERÄTE DER KLASSE 1**
DIESE GERÄTE MÜSSEN GEERDET SEIN. Der Netzstecker darf nur mit einer vorschriftsmäßig geerdeten Steckdose verbunden werden. Ein unvorschriftsmäßiger Anschluß kann die Metallteile des Gehäuses unter gefährliche elektrische Spannungen setzen.
 - ☞ 12  **STECKBARES GERÄT:** Die Anschlußbuchse sollte in der Nähe der Einrichtung angebracht werden und leicht zugänglich sein."
 - ☞ 13  **VORSICHT**
Die Entlüftungsöffnungen dürfen nicht versperrt sein und müssen zum Kühlen freien Zugang zur Raumluft haben.
 - ☞ 14  **BETRIEBSTEMPERATUR:** Dieses Produkt wurde für den Betrieb in einer Umgebungstemperatur von nicht mehr als 40° C entworfen.
 - ☞ 15  **ALLE LÄNDER:** Installation muß örtlichen und nationalen elektrischen Vorschriften entsprechen.













Standarder: Dette produkt tilfredsstiller de følgende standarder.

- 1 Radiofrekvens forstyrrelsesemission EN55022 Klasse A
 - 2  **ADVARSEL:** I et hjemligt miljø kunne dette produkt forårsage radio forstyrrelse. Bliver det tilfældet, påkræves brugeren muligvis at tage tilstrækkelige foranstaltninger.
 - 3 Immunitet EN50082-1 1997
 - 4 Elektrisk sikkerhed EN60950, UL 1950, CSA 950
 - 5  Laser EN60825
- SIKKERHED**
- 6  **ADVARSEL** Laserprodukt av klasse 1.
 - 7  **ADVARSEL** Stirr ikke på strålen.
 - 8  **ELEKTRISKE FORHOLDSREGLER**
ADVARSEL: RISIKO FOR ELEKTRISK STØD
 For at forebygge ELEKTRISK stød, undlad at åbne apparatet. Der er ingen indre dele, der kan repareres af brugeren. Denne enhed indeholder LIVSFARLIGE STRØMSPÆNDINGER og bør kun åbnes af en uddannet og kvalificeret tekniker. For at undgå risiko for ELEKTRISK STØD, afbrydes den elektriske strøm til produktet, før LAN-kablerne monteres eller afmonteres.
 - 9  **FARE UNDER UVEJR**
FARE: UNDLAD at arbejde på udstyr eller KABLER i perioder med LYNAKTIVITET.
 - 10  **ADVARSEL: DEN STRØMFØRENDE LEDNING BRUGES TIL AT AFBRYDE STRØMMEN. SKAL STRØMMEN TIL APPARATET AFBRYDES, tages ledningen ud af stikket.**
 - 11  **ELEKTRISK - KLASSE 1-UDSTYR**
 DETTE UDSTYR KRÆVER JORDFORBINDELSE. Stikket skal være forbundet med en korrekt installeret jordforbunden stikkontakt. En ukorrekt installeret stikkontakt kan sætte livsfarlig spænding til tilgængelige metaldele.
 - 12  **UDSTYR TIL STIKKONTAKT**, stikkontakten bør installeres nær ved udstyret og skal være lettilgængelig.
 - 13  **ADVARSEL:** Ventilationsåbninger må ikke blokeres og skal have fri adgang til den omgivende luft i rummet for afkøling.
 - 14  **BETJENINGSTEMPERATUR:** Dette apparat er konstrueret til en omgivende temperatur på maksimum 40 grader C.
 - 15  **ALLE LANDE:** Installation af produktet skal ske i overensstemmelse med lokal og national lovgivning for elektriske installationer.













Eisen: Dit product voldoet aan de volgende eisen.













- | | | |
|-------------------|---|---------------------------|
| ☞ 1 | RFI Emissie | EN55022 Klasse A |
| ☞ 2 |  WAARSCHUWING: Binnenshuis kan dit product radiostoring veroorzaken, in welk geval de gebruiker verplicht kan worden om gepaste maatregelen te nemen. | |
| ☞ 3 | Immunititeit | EN50082-1 1997 |
| ☞ 4 | Electrische Veiligheid | EN60950, UL 1950, CSA 950 |
| ☞ 5 |  Laser | EN60825 |
| VEILIGHEID | | |
| ☞ 6 |  WAARSHUWING Klasse-1 laser produkt. | |
| ☞ 7 |  WAARCHUWING Neit in de straal staren. | |
| ☞ 8 |  WAARSCHUWINGEN MET BETREKKING TOT ELEKTRICITEIT
WAARSCHUWING: GEVAAR VOOR ELEKTRISCHE SCHOKKEN
Verwijder het deksel niet, teneinde ELEKTRISCHE schokken te voorkomen. Binnenin bevinden zich geen onderdelen die door de gebruiker onderhouden kunnen worden. Dit toestel staat onder GEVAARLIJKE SPANNING en mag alleen worden geopend door een daartoe opgeleide en bevoegde technicus. Om het gevaar op ELEKTRISCHE SCHOKKEN te vermijden, moet u het toestel van de stroombron ontkoppelen alvorens de LAN-kabels te koppelen of ontkoppelen. | |
| ☞ 9 |  GEVAAR VOOR BLIKSEMINSLAG
GEVAAR: NIET aan toestellen of KABELS WERKEN bij BLIKSEM. | |
| ☞ 10 |  WAARSCHUWING: HET TOESTEL WORDT UITGESCHAKELD DOOR DE STROOMKABEL TE ONTKOPPELEN. OM HET TOESTEL STROOMLOOS TE MAKEN: de stroomkabel ontkoppelen. | |
| ☞ 11 |  ELEKTRISCHE TOESTELLEN VAN KLASSE 1
DIT TOESTEL MOET GEAARD WORDEN. De stekker moet aangesloten zijn op een juist geaarde contactdoos. Een onjuist geaarde contactdoos kan de metalen onderdelen waarmee de gebruiker eventueel in aanraking komt onder gevaarlijke spanning stellen. | |
| ☞ 12 |  AAN TE SLUITEN APPARATUUR, de contactdoos wordt in de nabijheid van de apparatuur geïnstalleerd en is gemakkelijk te bereiken." | |
| ☞ 13 |  OPGELET: De ventilatiegaten mogen niet worden gesperd en moeten de omgevingslucht ongehinderd toelaten voor afkoeling. | |
| ☞ 14 |  BEDRIJFSTEMPERATUUR: De omgevingstemperatuur voor dit produkt mag niet meer bedragen dan 40 graden Celsius. | |
| ☞ 15 |  ALLE LANDEN: het toestel installeren overeenkomstig de lokale en nationale elektrische voorschriften. | |

Normes: ce produit est conforme aux normes de suivantes:













- 1 Emission d'interférences radioélectriques EN55022 Classe A
 - 2  **MISE EN GARDE** : dans un environnement domestique, ce produit peut provoquer des interférences radioélectriques. Auquel cas, l'utilisateur devra prendre les mesures adéquates.
 - 3 Immunité EN50082 - 1 1997
 - 4 Sécurité électrique EN60950, UL 1950, CSA 950
 - 5  Laser EN60825
- SÉCURITÉ**
- 6  **ATTENTION** Produit laser di classe 1.
 - 7  **ATTENTION** Ne pas fixer le faisceau des yeux.
 - 8  **INFORMATION SUR LES RISQUES ÉLECTRIQUES**
AVERTISSEMENT: DANGER D'ÉLECTROCUTION
 Pour éviter toute ÉLECTROCUTION, ne pas ôter le revêtement protecteur du matériel. Ce matériel ne contient aucun élément réparable par l'utilisateur. Il comprend des TENSIONS DANGEREUSES et ne doit être ouvert que par un technicien dûment qualifié. Pour éviter tout risque d'ÉLECTROCUTION, débrancher le matériel avant de connecter ou de déconnecter les câbles LAN.
 - 9  **DANGER DE Foudre**
DANGER: NE PAS MANIER le matériel ou les CÂBLES lors d'activité orageuse.
 - 10  **ATTENTION: LE CORDON D'ALIMENTATION SERT DE MISE HORS CIRCUIT. POUR COUPER L'ALIMENTATION DU MATÉRIEL,** débrancher le cordon.
 - 11  ÉQUIPEMENT DE CLASSE 1 ÉLECTRIQUE
 CE MATÉRIEL DOIT ÊTRE MIS A LA TERRE. La prise de courant doit être branchée dans une prise femelle correctement mise à la terre car des tensions dangereuses risqueraient d'atteindre les pièces métalliques accessibles à l'utilisateur.
 - 12  EQUIPEMENT POUR BRANCHEMENT ELECTRIQUE, la prise de sortie doit être placée près de l'équipement et facilement accessible".
 - 13  **ATTENTION:** Ne pas bloquer les fentes d'aération, ceci empêcherait l'air ambiant de circuler librement pour le refroidissement.
 - 14  **TEMPÉRATURE DE FONCTIONNEMENT:** Ce matériel est capable de tolérer une température ambiante maximum de ou 40 degrés Celsius.
 - 15  **POUR TOUS PAYS:** Installer le matériel conformément aux normes électriques nationales et locales.

Standardit: Tämä tuote on seuraavien standardien mukainen.



- | | | |
|---------------------|--|---------------------------|
| ☞ 1 | Radioaaltojen häirintä | EN55022 Luokka A |
| ☞ 2 |  VAROITUS: Kotiolosuhteissa tämä laite voi aiheuttaa radioaaltojen häiriitä, missä tapauksessa laitteen käyttäjän on mahdollisesti ryhdyttävä tarpeellisiin toimenpiteisiin. | |
| ☞ 3 | Kestävyys | EN50082-1 1997 |
| ☞ 4 | Sähköturvallisuus | EN60950, UL 1950, CSA 950 |
| ☞ 5 |  Laser | EN60825 |
| TURVALLISUUS | | |
| ☞ 6 |  VAROITUS Luokan 1 Lasertuote. | |
| ☞ 7 |  VAROITUS Älä katso säteeseen. | |
| ☞ 8 |  SÄHKÖÖN LIITTYVIÄ HUOMAUTUKSIA
VAROITUS: SÄHKÖISKUVAARA
Estääksesi SÄHKÖISKUN älä poista kantta. Sisällä ei ole käyttäjän huollettavissa olevia osia. Tämä laite sisältää VAARALLISIA JÄNNITTEITÄ ja sen voi avata vain koulutettu ja pätevä teknikko. Vältä äläkätkesi SÄHKÖISKUN mahdollisuuden katkaista sähkövirta tuotteeseen ennen kuin liität tai irrotat paikallisverkon (LAN) kaapelit. | |
| ☞ 9 |  SALAMANISKUVAARA
HENGENVAARA: ÄLÄ TYÖSKENTELE laitteiden tai KAAPELEIDEN KANSSA SALAMOINNIN AIKANA. | |
| ☞ 10 |  HUOMAUTUS: VIRTAJOHTOA KÄYTETÄÄN VIRRANKATKAISULAITTEENA. VIRTA KATKAISTAAN irrottamalla virtajohto. | |
| ☞ 11 |  SÄHKÖ - TYYPPILUOKAN 1 LAITTEET
TÄMÄ LAITE TÄYTYY MAADOITTAA. Pistoke täytyy liittää kunnollisesti maadoitettuun pistorasiaan. Virheellisesti johdotettu pistorasia voi altistaa metalliosat vaarallisille jännitteille. | |
| ☞ 12 |  PISTORASIAAN KYTKETTÄVÄ LAITE; pistorasia on asennettava laitteen lähelle ja siihen on oltava esteetön pääsy." | |
| ☞ 13 |  HUOMAUTUS: Ilmavaihtoreikiä ei pidä tukkia ja niillä täytyy olla vapaa yhteys ympäröivään huoneilmaan, jotta ilmanvaihto tapahtuisi. | |
| ☞ 14 |  KÄYTTÖLÄMPÖTILA: Tämä tuote on suunniteltu ympäröivän ilman maksimilämpötilalle 40°C. | |
| ☞ 15 |  KAIKKI MAAT: Asenna tuote paikallisten ja kansallisten sähköturvallisuusmääräysten mukaisesti. | |

-
- Standard:** Questo prodotto è conforme ai seguenti standard.
- 1 Emissione RFI (interferenza di radiofrequenza) EN55022 Classe A
 - 2  **AVVERTENZA:** in ambiente domestico questo prodotto potrebbe causare radio interferenza. In questo caso potrebbe richiedersi all'utente di prendere gli adeguati provvedimenti.
 - 3 Immunità EN50082-1 1997
 - 4 Sicurezza elettrica EN60950, UL 1950, CSA 950
 - 5  Laser EN60825
- NORME DI SICUREZZA**
- 6  **AVVERTENZA** Prodotto laser di Classe 1.
 - 7  **AVVERTENZA** Non fissare il raggio con gli occhi.
 - 8  **AVVERTENZE ELETTRICHE**
ATTENZIONE: PERICOLO DI SCOSSE ELETTRICHE
 Per evitare SCOSSE ELETTRICHE non asportare il coperchio. Le componenti interne non sono riparabili dall'utente. Questa unità ha TENSIONI PERICOLOSE e va aperta solamente da un tecnico specializzato e qualificato. Per evitare ogni possibilità di SCOSSE ELETTRICHE, interrompere l'alimentazione del dispositivo prima di collegare o staccare i cavi LAN.
 - 9  **PERICOLO DI FULMINI**
PERICOLO: NON LAVORARE sul dispositivo o sui CAVI durante PRECIPITAZIONI TEMPORALESCHIE.
 - 10  **ATTENZIONE:** IL CAVO DI ALIMENTAZIONE È USATO COME DISPOSITIVO DI DISATTIVAZIONE. PER TOGLIERE LA CORRENTE AL DISPOSITIVO staccare il cavo di alimentazione.
 - 11  **ELETTRICITÀ - DISPOSITIVI DI CLASSE 1**
 QUESTO DISPOSITIVO DEVE AVERE LA MESSA A TERRA. La spina deve essere inserita in una presa di corrente specificamente dotata di messa a terra. Una presa non cablata in maniera corretta rischia di scaricare una tensione pericolosa su parti metalliche accessibili.
 - 12  **APPARECCHIATURA COLLEGABILE,** la presa va installata vicino all'apparecchio per risultare facilmente accessibile".
 - 13  **ATTENZIONE:** le prese d'aria non vanno ostruite e devono consentire il libero ricircolo dell'aria ambiente per il raffreddamento.
 - 14  **TEMPERATURA DI FUNZIONAMENTO:** Questo prodotto è concepito per una temperatura ambientale massima di 40 gradi centigradi.
 - 15  **TUTTI I PAESI:** installare il prodotto in conformità delle vigenti normative elettriche nazionali.



Sikkerhetsnormer: Dette produktet tilfredsstiller følgende sikkerhetsnormer.

- | | | |
|-----|---|---------------------------|
| ☞ 1 | RFI stråling | EN55022 Klasse A |
| ☞ 2 |  ADVARSEL: Hvis dette produktet benyttes til privat bruk, kan produktet forårsake radioforstyrrelse. Hvis dette skjer, må brukeren ta de nødvendige forholdsregler. | |
| ☞ 3 | Immunitet | EN50082-1 1997 |
| ☞ 4 | Elektrisk sikkerhet | EN60950, UL 1950, CSA 950 |
| ☞ 5 |  Laser | EN60825 |
- SIKKERHET**
- | | | |
|------|--|--|
| ☞ 6 |  ADVARSEL Laserprodukt av klasse 1. | |
| ☞ 7 |  ADVARSEL Stirr ikke på strålen. | |
| ☞ 8 |  ELEKTRISITET
ADVARSEL: FARE FOR ELEKTRISK SJOKK
For å unngå ELEKTRISK sjokk, må dekslet ikke tas av. Det finnes ingen deler som brukeren kan reparere på innsiden. Denne enheten inneholder FARLIGE SPENNINGER, og må kun åpnes av en faglig kvalifisert tekniker. For å unngå ELEKTRISK SJOKK må den elektriske strømmen til produktet være avslått før LAN-kablene til- eller frakobles. | |
| ☞ 9 |  FARE FOR LYNNEDSLAG
FARE: ARBEID IKKE på utstyr eller KABLER i TORDENVÆR. | |
| ☞ 10 |  FORSIKTIG: STRØMLEDNINGEN BRUKES TIL Å FRAKOBLE UTSTYRET. FOR Å DEAKTIVISERE UTSTYRET, må strømforsyningen kobles fra. | |
| ☞ 11 |  ELEKTRISK - TYPE 1- KLASSE UTSTYR
DETTE UTSTYRET MÅ JORDES. Strømkontakten må være tilkopleet en korrekt jordet kontakt. En kontakt som ikke er korrekt jordet kan føre til farlig spenning i lett tilgjengelige metalldeleer. | |
| ☞ 12 |  UTSTYR FOR STIKKONTAKT. Stikkontakten skal monteres i nærheten av utstyret og skal være lett tilgjengelig." | |
| ☞ 13 |  FORSIKTIG: Lufteventilene må ikke blokkeres, og må ha fri tilgang til luft med romtemperatur for avkjøling. | |
| ☞ 14 |  DRIFTSTEMPERATUR: Dette produktet er konstruert for bruk i maksimum romtemperatur på 40 grader celsius. | |
| ☞ 15 |  ALLE LAND: Produktet må installeres i samsvar med de lokale og nasjonale elektriske koder. | |



Padrões: Este produto atende aos seguintes padrões.

- 1 Emissão de interferência de radiofrequência EN55022 Classe A
- 2  **AVISO:** Num ambiente doméstico este produto pode causar interferência na radiorrecepção e, neste caso, pode ser necessário que o utente tome as medidas adequadas.
- 3 Imunidade EN50082-1 1997
- 4 Segurança Eléctrica EN60950, UL 1950, CSA 950
- 5  Laser EN60825











SEGURANÇA

- 6  **AVISO** Produto laser de classe 1
- 7  **AVISO** Não olhe fixamente para o raio.
- 8  **AVISOS SOBRE CARACTERÍSTICAS ELÉTRICAS**
ATENÇÃO: PERIGO DE CHOQUE ELÉTRICO
 Para evitar CHOQUE ELÉTRICO, não retire a tampa. Não contém peças que possam ser consertadas pelo usuário. Este aparelho contém VOLTAGENS PERIGOSAS e só deve ser aberto por um técnico qualificado e treinado. Para evitar a possibilidade de CHOQUE ELÉTRICO, desconecte o aparelho da fonte de energia eléctrica antes de conectar e desconectar os cabos da LAN.
- 9  **PERIGO DE CHOQUE CAUSADO POR RAIOS**
PERIGO: NÃO TRABALHE no equipamento ou nos CABOS durante períodos suscetíveis a QUEDAS DE RAIOS.
- 10  **CUIDADO:** O CABO DE ALIMENTAÇÃO É UTILIZADO COMO UM DISPOSITIVO DE DESCONEXÃO. PARA DESELETRIFICAR O EQUIPAMENTO, desconecte o cabo de ALIMENTAÇÃO.
- 11  ELÉTRICO - EQUIPAMENTOS DO TIPO CLASSE 1 DEVE SER FEITA LIGAÇÃO DE FIO TERRA PARA ESTE EQUIPAMENTO. O plugue de alimentação deve ser conectado a uma tomada com adequada ligação de fio terra. Tomadas sem adequada ligação de fio terra podem transmitir voltagens perigosas a peças metálicas expostas.
- 12  EQUIPAMENTO DE LIGAÇÃO, a tomada eléctrica deve estar instalada perto do equipamento e ser de fácil acesso."
- 13  **CUIDADO:** As aberturas de ventilação não devem ser bloqueadas e devem ter acesso livre ao ar ambiente para arrefecimento adequado do aparelho.
- 14  **TEMPERATURA DE FUNCIONAMENTO:** Este produto foi projetado para uma temperatura ambiente máxima de 40 graus centígrados.
- 15  **TODOS OS PAÍSES:** Instale o produto de acordo com as normas nacionais e locais para instalações eléctricas.













Estándares: Este producto cumple con los siguientes estándares.

- 1 Emisión RFI EN55022 Clase A
- 2  **ADVERTENCIA:** en un entorno doméstico, este producto puede causar radiointerferencias, en cuyo caso, puede requerirse del usuario que tome las medidas que sean convenientes al respecto.
- 3 Inmunidad EN50082-1 1997
- 4 Seguridad eléctrica EN60950, UL 1950, CSA 950
- 5  Laser EN60825

SEGURIDAD

- 6  **¡ADVERTENCIA!** Producto láser Clase 1.
- 7  **¡ADVERTENCIA!** No mirat fijamente el haz.
- 8  **AVISOS ELECTRICOS**
ADVERTENCIA: PELIGRO DE ELECTROCHOQUE
Para evitar un ELECTROCHOQUE, no quite la tapa. No hay ningún componente en el interior al cual puede prestar servicio el usuario. Esta unidad contiene VOLTAJES PELIGROSOS y sólo deberá abrirla un técnico entrenado y calificado. Para evitar la posibilidad de ELECTROCHOQUE desconecte la corriente eléctrica que llega al producto antes de conectar o desconectar los cables LAN.
- 9  **PELIGRO DE RAYOS**
PELIGRO: NO REALICE NINGUN TIPO DE TRABAJO O CONEXION en los equipos o en LOS CABLES durante TORMENTAS ELECTRICAS.
- 10  **ATENCION: EL CABLE DE ALIMENTACION SE USA COMO UN DISPOSITIVO DE DESCONEXION.** PARA DESACTIVAR EL EQUIPO, desconecte el cable de alimentación.
- 11  **ELECTRICO - EQUIPO DEL TIPO CLASE 1**
ESTE EQUIPO TIENE QUE TENER CONEXION A TIERRA. El cable tiene que conectarse a un enchufe a tierra debidamente instalado. Un enchufe que no está correctamente instalado podría ocasionar tensiones peligrosas en las partes metálicas que están expuestas.
- 12  **EQUIPO CONECTABLE,** el tomacorriente se debe instalar cerca del equipo, en un lugar con acceso fácil".
- 13  **ATENCION:** Las aberturas para ventilación no deberán bloquearse y deberán tener acceso libre al aire ambiental de la sala para su enfriamiento.
- 14  **TEMPERATURA REQUERIDA PARA LA OPERACIÓN:** Este producto está diseñado para una temperatura ambiental máxima de 40 grados C.
- 15  **PARA TODOS LOS PAÍSES:** Monte el producto de acuerdo con los Códigos Eléctricos locales y nacionales.

Standarder: Denna produkt uppfyller följande standarder.

- 1 Radiostörning EN55022 Klass A
 - 2  **VARNING:** Denna produkt kan ge upphov till radiostörningar i hemmet, vilket kan tvinga användaren till att vidtaga erforderliga åtgärder.
 - 3 Immunitet EN50082-1 1997
 - 4 Elsäkerhet EN60950, UL 1950, CSA 950
 - 5  Laser EN60825
- SÄKERHET**
- 6  **VARNING!** Laserprodukt av klass 1.
 - 7  **VARNING!** Laserstrålning när enheten är öppen.
 - 8  **TILLKÄNNAGIVANDEN BETRÄFFANDE ELEKTRICITETSRIK:**
RISK FÖR ELEKTRISK STÖT För att undvika ELEKTRISK stöt, ta ej av locket. Det finns inga delar inuti som behöver underhållas. Denna apparat är under HÖGSPÄNNING och får endast öppnas av en utbildad kvalificerad tekniker. För att undvika ELEKTRISK STÖT, koppla ifrån produktens strömanslutning innan LAN-kablarna ansluts eller kopplas ur.
 - 9  **FARA FÖR BLIXTNEDSLAG**
FARA: ARBETA EJ på utrustningen eller kablarna vid ÅSKVÄDER.
 - 10  **VARNING:** NÄTKABELN ANVÄNDS SOM STRÖMBRYTARE FÖR ATT KOPPLA FRÅN STRÖMMEN, dra ur nätkabeln.
 - 11  **ELEKTRISKT - TYP KLASS 1 UTRUSTNING**
DENNA UTRUSTNING MÅSTE VARA JORDAD. Nätkabeln måste vara ansluten till ett ordentligt jordat uttag. Ett felaktigt uttag kan göra att närliggande metalldelar utsätts för högspänning. Apparaten skall anslutas till jordat uttag, när den ansluts till ett nätverk.
 - 12  **UTRUSTNING MED PLUGG.** Uttaget skall installeras i utrustningens närhet och vara lättåtkomligt".
 - 13  **VARNING:** Luftventilerna får ej blockeras och måste ha fri tillgång till omgivande rumsluft för avsvälning.
 - 14  **DRIFTSTEMPERATUR:** Denna produkt är konstruerad för rumstemperatur ej överstigande 40 grader Celsius.
 - 15  **ALLA LÄNDER:** Installera produkten i enlighet med lokala och statliga bestämmelser för elektrisk utrustning.

Appendix B

Technical Specifications

Table B-1 lists the technical specifications for the AT-8316F and AT-8324 switches.

Table B-1 Technical Specifications

Physical Specifications		
	Dimensions (H x W x D)	Weight
Base Unit	6.48 cm x 42.93 cm x 35.60 cm (2.55 in x 16.9 in x 14.0 in)	5 kg (11 lbs)
Required ventilation on all sides	19 cm (7.5 in)	
Environmental Specifications		
Operating temperature	0° C to 40° C (32° to 104° F)	
Storage temperature	-25° C to 70° C (-13° to 158° F)	
Operating humidity	5% to 95% non-condensing	
Operating altitude range	up to 3,000 m (9,843 ft)	
Power Specifications		
Maximum power consumption	95 W	
AC input voltage	100-120/200-240VAC~ +64/2A, 50/60Hz.	
Frequency	50/60 Hz ± 3 cycles of nominal input frequency	
Safety and Electromagnetic Emissions Certifications		
Safety: UL 1950	CSA 22.2 No. 950	EN 60950 (TUV)
EMI: FCC Class A	EN55022 Class A	
Immunity: EN50082-1	Quality and Reliability: MTBF > 50,000 hrs	MTTR < 1/2 hr DOA < 1%

Table B-2 shows the pin assignments for the switch’s RJ-45 connectors.

Table B-2 RJ-45 Port Pin Assignments

Pin Number	Function
1	RD+
2	RD-
3	TD+
4	Unused
5	Unused
6	TD-
7	Unused
8	Unused

Table B-3 shows the pin assignments for the R.P.S. Input port on the back of the switch. (Pin numbers 1 through 8 are the bottom row of pins on the connector, with pin 1 in the bottom right corner. Pin numbers 9 through 16 are the top row, with pin 9 in the top right position on the connector.)

Table B-3 R.P.S. Input Port Pin Assignments

Pin Number	Function
1	+12V dc
2	Remote Sense (RS) +5V dc
3	RS Ground
4	RS +3.3V dc
5	Redundant Power Supply (RPS) Present
6	Ground (+3.3V dc Return)
7	Ground (+5V dc Return)
8	+5V dc
9	Ground (+12V dc Return)
10	+3.3V dc
11	Ground (+3.3 dc Return)
12	+3.3V dc
13	Ground (+3.3V dc Return)
14	+3.3V dc
15	+5V dc
16	Ground (+5V dc Return)

Table B-4 through Table B-6 list the specifications for the AT-A15/SX, AT-A15/LX, AT-A16, AT-A17, AT-A18 and AT-A19 expansion modules.

Table B-4 AT-A15 and AT-A16 Expansion Module Specifications

	AT-A15	AT-A16
Physical Dimensions (H x W x D)	2.16 cm x 7.62 cm x 17.78 cm (0.85 in x 3 in x 7.0 in)	2.16 cm x 7.62 cm x 17.78 cm (0.85 in x 3 in x 7.0 in)
Weight	.045 kg (.10 lbs)	.045 kg (.10 lbs)
Connector Type	SC	VF-45
Maximum Distance	1000Base-SX 550 m (1,804 ft) 1000Base-LX 10 km (6.2 mi)	Half-duplex: 412 m (1,351 ft) Full-duplex: 2000 m (6600 ft)
Ethernet Mode	1000Base-SX or LX Half- of full-duplex operation	100Base-FX Half- of full-duplex operation

Table B-5 AT-A17 and AT-A18 Expansion Module Specifications

	AT-A17	AT-A18
Physical Dimensions (H x W x D)	2.16 cm x 7.62 cm x 17.78 cm (0.85 in x 3 in x 7.0 in)	2.16 cm x 7.62 cm x 17.78 cm (0.85 in x 3 in x 7.0 in)
Weight	.045 kg (.10 lbs)	.045 kg (.10 lbs)
Connector Type	SC	RJ-45
Maximum Distance	Half-duplex: 412 m (1,351 ft) Full-duplex: 2000 m (6,600 ft)	100 m (330 ft)
Ethernet Mode	100Base-FX Half- of full-duplex operation	10Base-T/100Base-TX Half- of full-duplex operation

Table B-6 AT-A19 Expansion Module Specifications

	AT-A19
Physical Dimensions (H x W x D)	2.16 cm x 7.62 cm x 17.78 cm (0.85 in x 3 in x 7.0 in)
Weight	.045 kg (.10 lbs)
Connector Type	MT-RJ
Maximum Distance	Half-duplex: 412 m (1,351 ft) Full-duplex: 2,000 m (6,600 ft)
Ethernet Mode	100Base-FX Half- of full-duplex operation

Appendix C

Switch Default Settings

This appendix lists the switch's factory default software settings.

Settings	Default
IP Address	0.0.0.0
Subnet Mask	0.0.0.0
Gateway Address	0.0.0.0
Get Community String	public
Set Community String	private
Trap Community String	public
Spanning Tree Protocol	Disabled
Bridge Priority	32768
Bridge Max Age	20
Bridge Hello Time	2
Bridge Forward Delay	15
Telnet Access	Enabled
System Name	None
Password (Omega)	No password assigned
Download Password	ATS25
AT-8324 Duplex Mode	Auto-negotiating
AT-8316F Duplex Mode	Full-duplex
Aging Time (MAC Address Table)	300 seconds
High Port Speed	Auto-negotiating
Domain Name	None
VLAN Name	Default VLAN (all ports)
PVID/VID	1

Index

A

- AC inputs, 25
- activity (/link) LED, 17
- AT-8316F switch
 - cabling specifications, 30
 - general specifications, 12
 - physical description, 14
 - port groups, 36
- AT-8324 switch
 - cabling specifications, 30
 - general specifications, 12
 - physical description, 14
 - port groups, 35
- AT-A1x expansion modules
 - cabling specifications, 34
 - general specifications, 21
 - installation, 60
 - supported port trunks, 37
- AT-S25 software, 25
- AT-Stack8 module, 20, 32, 52
- auto-negotiation, 13

B

bootp 13

C

- cabling specifications
 - expansion modules, 34
 - switches 30
- conventions, document, 8

D

- DHCP support 13
- diagnostics, running, 71
- disabled port, 70

duplex

- full-, 13
 - half-, 13
- duplex/collision LED, 17, 69

E

- expansion modules 21
 - cabling specifications, 34
 - general specifications, 21, 88
 - installation, 60
 - number in stack, 33
 - port trunks, 37
- expansion slots, 21

F

- fault LED, 16, 68, 71
- flash memory 13
- full-duplex, 13

H

half-duplex, 13

I

- IEEE 802.1P compliant 13
- IEEE 802.1Q compliant 13
- installation
 - expansion modules, 60
 - safety precautions, 41
 - stack of four to eight switches, 52
 - stack of three switches, 49
 - stack of two switches, 46
 - standalone switch, 43
 - switch, 19-inch rack, 45

- L**
- LED**
- descriptions, 16, 17, 68, 69
 - duplex collision 17, 69
 - fault, 16, 68, 71
 - link/activity, 17, 69
 - master, 16, 68
 - power, 16, 68
 - RPS 16, 68
 - uplink adapter descriptions, 69
- link/activity LED, 17, 69
- local management, omega, 59
- M**
- management
- local, omega, 59
- management information base (MIB), 13
- master LED, 16, 68
- O**
- omega management software, 25
- omega, 66
- local management, 59
- P**
- package contents, 40
- physical description, 14
- port
- description, 12
 - disabled, 70
- port groups, 35
- port trunking, 35
- power failure, 71
- power LED, 16, 68, 71
- powering on a stack, 57
- problems, troubleshooting, 66
- R**
- R.P.S. input connector, 23
- rack installation, 45
- reset button 71
- reset button, 24
- resetting a stack, 62
- RJ-45 pin assignments 86
- RPS LED, 16, 68
- RS232 connector, 18, 59
- S**
- safety precautions, 41
- SNMP management information base, 13
- SNMP traps from switch, TCP/IP, 68
- spanning tree protocol, 13
- specifications, technical, 85
- stack
- installing four to eight switches, 52
 - installing three switches, 49
 - installing two switches, 46
 - powering on, 57
 - resetting, 62
- stack ID switch
- location, 20
 - stack of four to eight switches, 56
 - stack of three switches, 51
 - stack of two switches, 48
- stacking module expansion slot, 20
- stacking ports, 19
- T**
- TCP/IP, 68
- technical support, contacting, 67
- troubleshooting
- power LED off 71
 - problems, 66
- W**
- worst case path delay value, 67