

Fast Ethernet Switch

AT-8326GB



Installation Guide



Simply connecting the  world



Copyright © 2002 Allied Telesyn, Inc.
960 Stewart Drive Suite B, Sunnyvale, CA 94085 USA

All rights reserved. No part of this publication may be reproduced without prior written permission from Allied Telesyn, Inc.

All other product names, company names, logos or other designations mentioned herein are trademarks or registered trademarks of their respective owners.

Allied Telesyn, Inc. reserves the right to make changes in specifications and other information contained in this document without prior written notice. The information provided herein is subject to change without notice. In no event shall Allied Telesyn, Inc. be liable for any incidental, special, indirect, or consequential damages whatsoever, including but not limited to lost profits, arising out of or related to this manual or the information contained herein, even if Allied Telesyn, Inc. has been advised of, known, or should have known, the possibility of such damages.

Electrical Safety and Emission Statement

Standards: This product meets the following standards.

U.S. Federal Communications Commission

RADIATED ENERGY

Note: This equipment has been tested and found to comply with the limits for a Class A digital device pursuant to Part 15 of the FCC Rules. These limits are designed to provide reasonable protection against harmful interference when the equipment is operated in a commercial environment. This equipment generates, uses, and can radiate radio frequency energy and, if not installed and used in accordance with this instruction manual, may cause harmful interference to radio communications. Operation of this equipment in a residential area is likely to cause harmful interference in which case the user will be required to correct the interference at his own expense.

Note: Modifications or changes not expressly approved by the manufacturer or the FCC can void your right to operate this equipment.

Canadian Department of Communications

This Class A digital apparatus meets all requirements of the Canadian Interference-Causing Equipment Regulations.

Cet appareil numérique de la classe A respecte toutes les exigences du Règlement sur le matériel brouilleur du Canada.

RFI Emission

FCC Class A, EN55022 Class A, CISPR22 Class A (VCCI), AS/NZS3548 (C-TICK), EN61000-3-2, EN61000-3-3  1



Warning: In a domestic environment this product may cause radio interference in which case the user may be required to take adequate measures.  2

Immunity

EN55024  3

Electrical Safety

UL 1950 (UL/cUL), EN60950  4





Laser

EN60825  5

Important: Appendix C contains translated safety statements for installing this equipment. When you see the , go to Appendix C for the translated safety statement in your language.

Wichtig: Anhang C enthält übersetzte Sicherheitshinweise für die Installation dieses Geräts. Wenn Sie  sehen, schlagen Sie in Anhang C den übersetzten Sicherheitshinweis in Ihrer Sprache nach.

Viktig: Tillæg C indeholder oversatte sikkerhedsadvarsler, der vedrører installation af dette udstyr. Når De ser symbolet , skal De slå op i tillæg C og finde de oversatte sikkerhedsadvarsler i Deres eget sprog.

Belangrijk: Appendix C bevat vertaalde veiligheidsopmerkingen voor het installeren van deze apparatuur. Wanneer u de  ziet, raadpleeg Appendix C voor vertaalde veiligheidsinstructies in uw taal.

Important : L'annexe C contient les instructions de sécurité relatives à l'installation de cet équipement. Lorsque vous voyez le symbole , reportez-vous à l'annexe C pour consulter la traduction de ces instructions dans votre langue.

Tärkeää: Liite C sisältää tämän laitteen asentamiseen liittyvät käännetyt turvaohjeet. Kun näet -symbolin, katso käännettyä turvaohjetta liitteestä C.

Importante: L'Appendice C contiene avvisi di sicurezza tradotti per l'installazione di questa apparecchiatura. Il simbolo , indica di consultare l'Appendice C per l'avviso di sicurezza nella propria lingua.

Viktig: Tillegg C inneholder oversatt sikkerhetsinformasjon for installering av dette utstyret. Når du ser , åpner du til Tillegg C for å finne den oversatte sikkerhetsinformasjonen på ønsket språk.

Importante: O Anexo C contém advertências de segurança traduzidas para instalar este equipamento. Quando vir o símbolo , leia a advertência de segurança traduzida no seu idioma no Anexo C.

Importante: El Apéndice C contiene mensajes de seguridad traducidos para la instalación de este equipo. Cuando vea el símbolo , vaya al Apéndice C para ver el mensaje de seguridad traducido a su idioma.

Obs! Bilaga C innehåller översatta säkerhetsmeddelanden avseende installationen av denna utrustning. När du ser , skall du gå till Bilaga C för att läsa det översatta säkerhetsmeddelandet på ditt språk.

Table of Contents

| | |
|--|----|
| Preface | 6 |
| How This Guide is Organized | 6 |
| Document Conventions | 7 |
| Where to Find Web-based Guides | 8 |
| Contacting Allied Telesyn | 9 |
| Telephone Support | 9 |
| For Sales or Corporate Information | 9 |
| Management Software Updates | 10 |
| | |
| Chapter 1 | |
| Product Description | 11 |
| Summary of Features | 11 |
| Location of Components | 12 |
| Hardware Features | 13 |
| Twisted Pair Ports | 13 |
| Gigabit Interface Converter (GBIC) Slots | 17 |
| Stacking Ports | 18 |
| System LEDs | 19 |
| Stack ID LEDs | 20 |
| 10/100 Mbps Port LEDs | 21 |
| 10/100/1000 Mbps Port LEDs | 22 |
| Gigabit Connector LEDs | 23 |
| RS-232 Terminal Port | 24 |
| AC Power Connector | 25 |
| Software Features | 26 |
| AT-S41 Management Software | 26 |
| Spanning Tree Protocol (STP) | 29 |
| Tagged and Port-based VLANs | 30 |
| Quality of Service (QoS) | 30 |
| IGMP Snooping | 31 |
| Dynamic Host Configuration Protocol (DHCP) | 32 |
| Port Monitoring | 32 |
| Port Trunking | 32 |
| Port Security | 35 |
| A Few Basics to Ethernet Switching | 36 |
| MAC Address Table | 36 |
| Duplex Mode | 37 |
| Store and Forward | 37 |

| | |
|--|----|
| Backpressure and Flow Control | 37 |
| Network Topologies | 39 |
| Power Workgroup Topology..... | 39 |
| Collapsed Backbone - Hub Topology..... | 40 |
| Switch Stacking Topology..... | 41 |

Chapter 2

| | |
|---|----|
| Installation | 42 |
| Installation Safety Precautions | 43 |
| Selecting a Site for the Switch | 44 |
| Required Cables | 45 |
| Unpacking the Switch | 46 |
| Installing the Switch on a Desktop | 47 |
| Installing the Switch in a Rack | 48 |
| Installing an Optional GBIC Module | 50 |
| Creating a Switch Stack | 52 |
| Cabling the Switch | 55 |
| Powering On the Switch | 58 |
| Starting a Local Management Session | 59 |
| Warranty Registration | 62 |

Chapter 3

| | |
|------------------------------|----|
| Troubleshooting | 63 |
|------------------------------|----|

Appendix A

| | |
|---|----|
| Technical Specifications | 67 |
| Physical Specifications | 67 |
| Environmental Specifications | 67 |
| Power Specifications | 67 |
| Safety and Electromagnetic Emissions Certifications | 68 |
| Standards | 68 |
| SNMP Support | 68 |

Appendix B

| | |
|--------------------------------------|----|
| Default Switch Settings | 69 |
|--------------------------------------|----|

Appendix C

| | |
|--|----|
| Translated Electrical Safety and Emission Information | 71 |
|--|----|

Preface

This guide contains instructions on how to install the stackable AT-8326GB Fast Ethernet switch.

How This Guide is Organized

This manual contains the following chapters and appendices:

Chapter 1, Hardware Description, describes the features and components of the switch.

Chapter 2, Installation, contains the installation instructions.

Chapter 3, Troubleshooting, provides information on how to resolve common problems that might occur with the switch.

Appendix A, Technical Specifications, contains the switch's technical specifications.

Appendix B, Switch Default Settings, lists the factory default settings.

Appendix C, Translated Electrical Safety and Emission Information, contains translations of the warnings and cautions in the manual.

Document Conventions

This document uses the following conventions to highlight important information.

Note

Notes provide additional information.

**Warning**

Warnings inform you that performing or omitting a specific action may result in bodily injury.

**Caution**

Cautions inform you that performing or omitting a specific action may result in equipment damage or loss of data.

Where to Find Web-based Guides

The Allied Telesyn web site at www.alliedtelesyn.com contains the most recent documentation for all Allied Telesyn International products. All documents are available as PDF files. You can either view the documents online or download them onto a local workstation or server.

Once you have installed the switch, refer to following manual for instructions on how to manage and configure the unit. The manual is available from the Allied Telesyn web site:

- **AT-S41 Management Software User's Guide**
PN 613-50283-00

Contacting Allied Telesyn

Telephone Support

To contact Technical Support by telephone, find your country or region in the table below.

| | |
|---|--|
| United States and Canada Tel: 1 800 428 4835 (option 4) | Europe, Africa, and the Middle East Tel: 00 800 287 877 67* or +31 20 711 4333 (Finland only: Tel: 990 287 877 67) |
| Asia and Southeast Asia Tel: (++65) 381 5612 | Australia Tel: 1 800 000 880 |
| New Zealand Tel: 0800 45 5782 | |

(* Valid in Austria, Belgium, France, Germany, Ireland, Italy, Luxembourg, The Netherlands, Norway, Sweden, Switzerland and the United Kingdom. For other European countries not listed here, ring +31 20 711 4333.)

You can also contact Technical Support online at:

<http://kb.alliedtelesyn.com>

For Sales or Corporate Information

Allied Telesyn, Inc.
 19800 North Creek Parkway,
 Suite 200
 Bothell, WA 98011
 Tel: (425) 487-8880
 Fax: (425) 489-9191

Management Software Updates

Allied Telesyn periodically updates the management software programs for our managed products. To obtain a copy of an updated management program, you can download the software either from our web site or our FTP server at <ftp.alliedtelesyn.com>. To use the FTP server, enter 'anonymous' for the user name when you log in and your e-mail address for the password.

Chapter 1

Product Description

The AT-8326GB is a stackable Layer 2 Fast Ethernet switch. It offers a wide range of features and capabilities, all designed to simplify the task of creating and maintaining a Fast Ethernet network.

Summary of Features

- 24 10/100Base-TX ports with RJ-45 connectors
- Two 10/100/1000Base-T ports with RJ-45 connectors
- Auto-MDI/MDI-X on all twisted pair ports
- Auto-Negotiation for speed and duplex mode (IEEE 803.3u-compliant)
- Two slots for Gigabit Interface Converter modules
- Two stacking ports
- Port trunking and port monitoring
- Port security
- Dynamic Host Configuration Protocol
- Internet Group Management Protocol snooping
- AT-S41 management software
- Port-based and tagged VLANs (IEEE 802.1Q-compliant)
- Spanning tree protocol (IEEE 802.1d-compliant)
- Quality of Service (IEEE 802.1p-compliant)

Location of Components

Figure 1 illustrates the front panel of the AT-8326GB Fast Ethernet Switch.

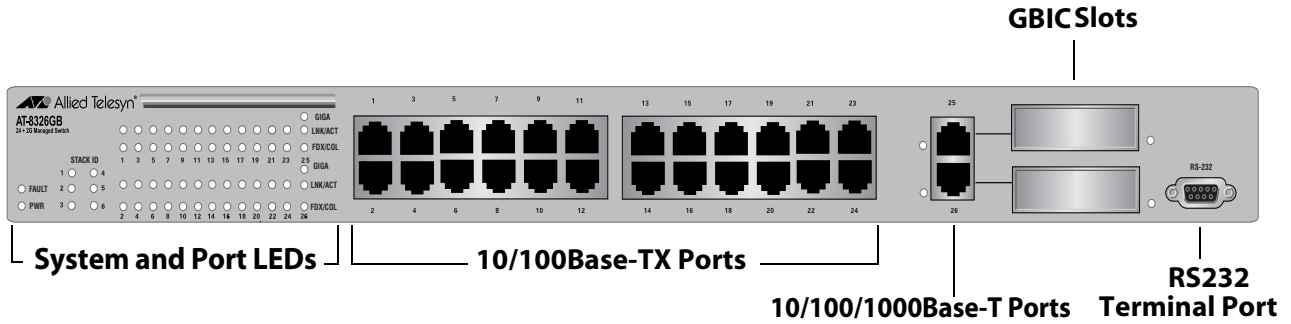

Figure 1 AT-8326GB Front Panel

Figure 2 illustrates the back panel.



Figure 2 Back Panel

Hardware Features

The following sections describe these hardware features of the AT-8326GB Fast Ethernet switch:

- 10/100Base-TX and 10/100/1000Base-T Ports
- Gigabit Interface Converter (GBIC) Slots
- Stacking Ports
- System LEDs
- Stack ID LEDs
- Port LEDs
- Gigabit Connector LEDs
- RS-232 Terminal Port
- AC Power Connector

Twisted Pair Ports

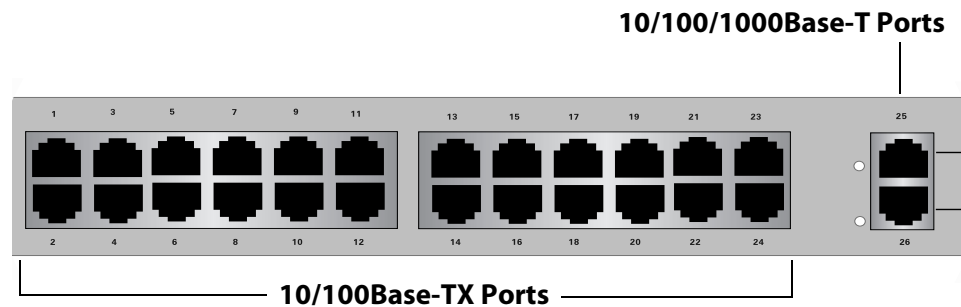

Figure 3 Twisted Pair Ports

The AT-8326GB Fast Ethernet switch features 24 10/100 Mbps twisted pair ports and two 10/100/1000 Mbps twisted pair ports. The features of the twisted pair ports are described below.

Type of Connector

All of the twisted pair ports feature RJ-45 connectors. (For the port pinout details, refer to **RJ-45 Port Pinouts** on page 15.)

Speed

The 10/100Base-TX ports are capable of 10 megabits per second (Mbps) or 100 Mbps speeds. The 10/100/1000Base-TX ports are capable of 10 Mbps, 100 Mbps, or 1000 Mbps speeds. You can set the port speed manually or, since the ports are IEEE 802.3u Auto-Negotiation compliant, you can allow the switch to set each port's speed automatically. With

Auto-Negotiation, the switch automatically matches the highest possible common speed between each switch port and each end node. For example, if an end node is capable of only 10 Mbps, the switch sets the port connected to the end node to 10 Mbps.

Note

Auto-Negotiation is activated as the default on all of the ports on the switch. To deactivate Auto-Negotiation and set the speeds manually, refer to the **AT-S41 Management Software User's Guide**.

Maximum Distance

Each twisted pair port has a maximum operating distance of 100 m (328 ft).

Type of Cabling

For 10 Mbps operation, Category 3 or better 100 ohm shielded or unshielded twisted pair cabling is required. For 100 or 1000 Mbps operation, Category 5 and Enhanced Category 5 (5E) 100 ohm shielded or unshielded twisted pair cabling is required.

Auto-MDI

All of the twisted pair ports on the switch are auto-MDI and IEEE 802.3ab-compatible. They automatically configure themselves as either MDI or MDI-X. This feature allows you to use either straight-through or cross-over twisted pair cables to connect devices to the ports.

Duplex Mode

Each twisted pair port on the switch can operate in either half- or full-duplex mode. The twisted pair ports are IEEE 802.3u-compliant and will Auto-Negotiate the duplex mode setting. If the end node connected to a twisted pair port on the switch is capable of full-duplex operation, the switch sets the port to full-duplex. If the end node is capable of only half-duplex, the port is set to half-duplex.

If desired, Auto-Negotiation on one or all of the twisted pair ports can be disabled so that you can set the duplex mode manually through the switch's management software.

RJ-45 Port Pinouts

Figure 4 illustrates the pin layout to an RJ-45 connector and port.

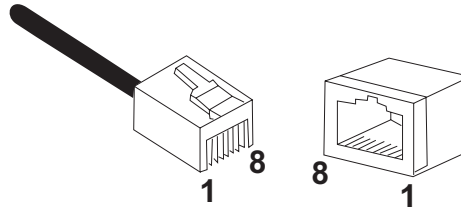

Figure 4 RJ-45 Connector and Port Pin Layout

Table 1 lists the RJ-45 pin signals when a twisted pair port is operating in the MDI configuration.

Table 1 MDI Pin Signals (10/100 Mbps)

| Pin | Signal |
|-----|--------|
| 1 | TX+ |
| 2 | TX- |
| 3 | RX+ |
| 6 | RX- |

Table 2 lists the RJ-45 port pin signals when a twisted pair port is operating in the MDI-X configuration.

Table 2 MDI-X Pin Signals (10/100 Mbps)

| Pin | Signal |
|-----|--------|
| 1 | RX+ |
| 2 | RX- |
| 3 | TX+ |
| 6 | TX- |

Table 3 lists the RJ-45 connector pins and their signals when a 10/100/1000 Mbps twisted pair port is operating at 1000 Mbps.

Table 3 1000 Mbps Pin Signals

| Pin | Pair | Signal |
|------------|-------------|---------------|
| 1 | 1 | TX and RX+ |
| 2 | 1 | TX and RX- |
| 3 | 2 | TX and RX+ |
| 4 | 2 | TX and RX+ |
| 5 | 3 | TX and RX- |
| 6 | 3 | TX and RX- |
| 7 | 4 | TX and RX+ |
| 8 | 4 | TX and RX- |

Gigabit Interface Converter (GBIC) Slots

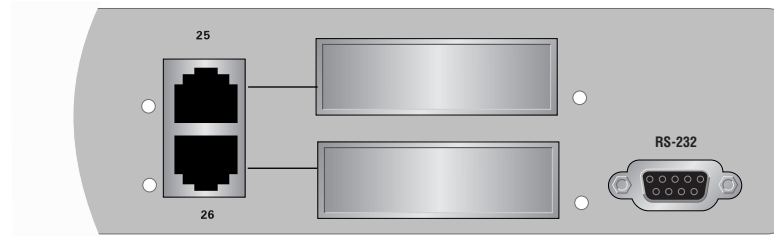

Figure 5 GBIC Slots

The AT-8326GB Fast Ethernet switch has two GBIC slots on the front panel, which correspond to Ports 25 and 26. Each slot can accommodate one optional GBIC module.

A GBIC module is a gigabit (1000Base) transceiver. GBIC modules can be used to extend the distance of your network, build a high-speed backbone network, or connect additional nodes to the network, such as high-speed servers. Figure 6 shows an example of a fiber optic GBIC module.

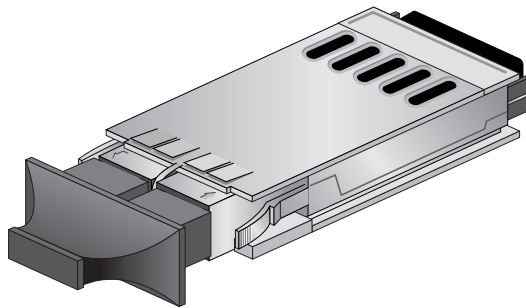

Figure 6 Example of a GBIC Module

Note

Ports 25 and 26 can each support only one medium type (i.e., twisted pair or GBIC) at a time. For example, if you install a GBIC for Port 25, you cannot use the corresponding twisted pair port.

In order to use Port 25 or 26 with a GBIC module, you must change the port setting in the management software to GBIC instead of twisted pair. For instructions, refer to the **AT-S41 Management Software User's Guide**.

The AT-8326GB Gigabit Ethernet Switch supports the AT-G8 series GBIC modules: SX, LX, LX25, LX40, LX75.

Stacking Ports

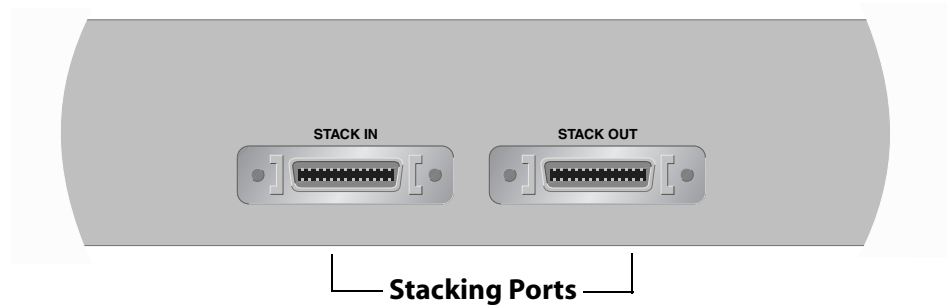

Figure 7 Stacking Ports

There are two stacking ports on the back of the switch (Figure 7). The ports are used to connect AT-8326GB switches to form a logical switch. A logical switch consists of two or more individual switches that function as one unit. This feature offers the following benefits:

- Stacking allows you to build a switch that is customized to the needs and requirements of your network.
- Stacking simplifies network management. Rather than having to manage the switches individually, you can manage all of the switches as one unit.
- Stacking allows you to manage multiple switches from one management session. All of the switches in a stack can be managed from one management session through the master switch of the switch stack.
- Stacking switches reduces the number of IP addresses you need to assign to the switches you want to manage, since you can use one IP address for all of the switches in a switch stack.

Up to six AT-8326GB switches can be stacked together in a daisy-chain stacking configuration. Star and redundant path configurations will not work.

A stack does not require any additional hardware other than the switches and the LVDS stacking cable that comes with the units.

System LEDs

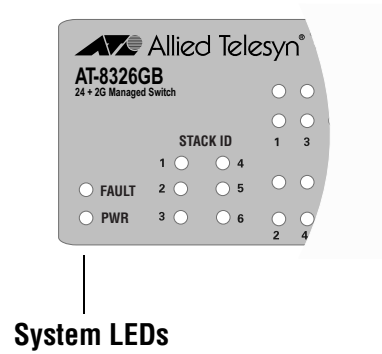

Figure 8 System LEDs

The system LEDs on the front panel display general status information about the entire switch. The system LEDs are defined in Table 4.

Table 4 System LEDs

| LED | State | Description |
|-------|----------------|--|
| PWR | Green | System power is ON. |
| | OFF | System power is OFF. |
| FAULT | Green | The switch or management software has malfunctioned. (Refer to Chapter 3, Troubleshooting on page 60 for instructions on how to determine and repair the problem.) |
| | Flashing Green | The switch is loading its operating software, running diagnostic tests, writing messages to FLASH, or downloading files using XMODEM. |

Stack ID LEDs

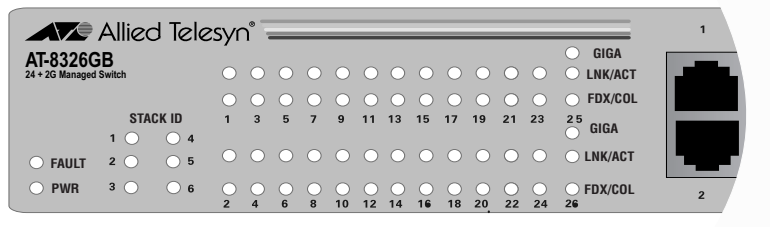

Stack ID LEDs

Figure 9 Stack ID LEDs

The stack ID LEDs indicate the switch's position in a switch stack. Since you can stack up to six AT-8326GB switches, there are six stack ID LEDs. For instructions on how to create a switch stack, refer to **Creating a Switch Stack** on page 52.

10/100 Mbps Port LEDs

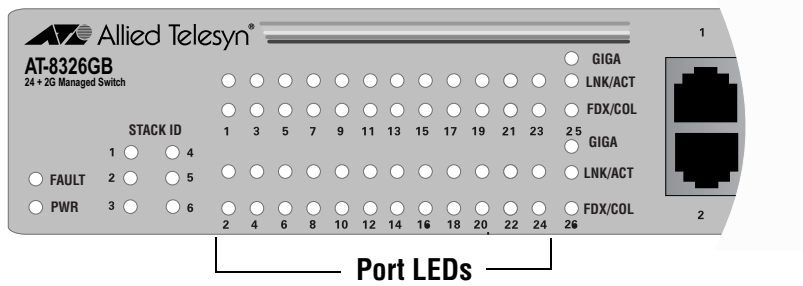

Figure 10 Port LEDs

The 10/100 Mbps port LEDs on the front panel display port status information for Ports 1-24. Each 10/100 Mbps port has two LEDs.

Each port has a LNK/ACT LED which displays the speed of an established link and whether or not there is any activity on the link.

Each port also has an FDX/COL LED. This LED displays the duplex mode of the port and whether or not there are any collisions occurring on the port.

Table 5 describes the 10/100Base-TX port LEDs.

Table 5 10/100 Mbps Port LEDs

| LED | State | Description |
|---------|-----------------|---|
| LNK/ACT | Steady Green | A 100 Mbps link with no activity. |
| | Flashing Green | A 100 Mbps link with activity. |
| | Steady Yellow | A 10 Mbps link with no activity. |
| | Flashing Yellow | A 10 Mbps link with activity. |
| | OFF | No link has been established. |
| FDX/COL | Green | The port is in full-duplex mode. |
| | Yellow | The port is in half-duplex mode and no data collisions are occurring on the port. |
| | Flashing Yellow | The port is in half-duplex mode with collisions. |

10/100/1000 Mbps Port LEDs

The 10/100/1000 Mbps port LEDs on the front panel display port status information for Ports 25 and 26. Each 10/100/1000 Mbps port has three LEDs.

Like the 10/100 Mbps ports, the 10/100/1000Mbps ports have the same LNK/ACT and FDX/COL LEDs that display status information when the port is operating at 10/100 Mbps speeds. The 10/100/1000 Mbps ports have an additional LED called the GIGA LED that displays the LNK/ACT status information when the port is operating at 1000 Mbps speeds.

Table 6 describes the 10/100/1000 Mbps port LEDs.

Table 6 10/100/1000 Mbps Port LEDs

| LED | State | Description |
|---------|-----------------|---|
| GIGA | Steady Green | A 1000 Mbps link with no activity. |
| | Flashing Green | A 1000 Mbps link with activity. |
| | OFF | No 1000 Mbps link has been established. |
| LNK/ACT | Steady Green | A 100 Mbps link with no activity. |
| | Flashing Green | A 100 Mbps link with activity. |
| | Steady Yellow | A 10 Mbps link with no activity. |
| | Flashing Yellow | A 10 Mbps link with activity. |
| | OFF | No 10/100 Mbps link has been established. |
| FDX/COL | Green | The port is in full-duplex mode. |
| | Yellow | The port is in half-duplex mode and no data collisions are occurring on the port. |
| | Flashing Yellow | The port is in half-duplex mode with collisions. |

Gigabit Connector LEDs

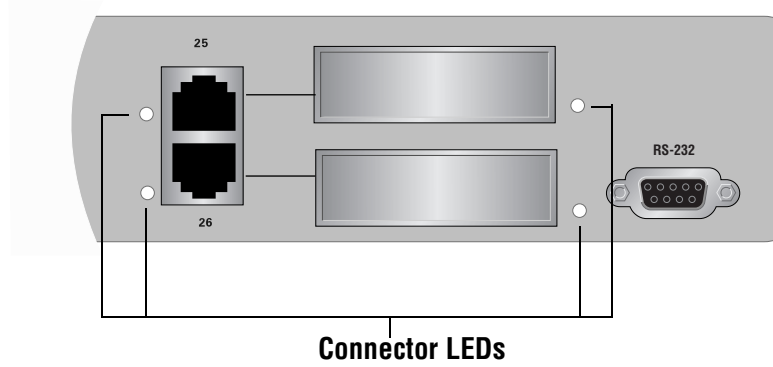

Figure 11 Gigabit Connector LEDs

Ports 25 and 26 each have two connector LEDs on the front panel that indicate which connector type is being used for each port: the RJ-45 or the GBIC. The connector LEDs for each port are located to the left of the RJ-45 connectors and to the right of the GBIC slots.

RS-232 Terminal Port

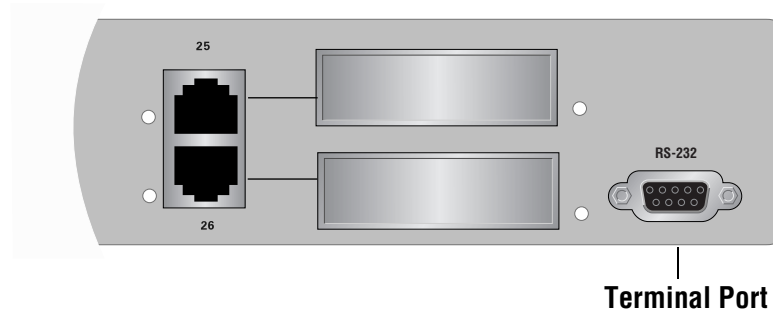

Figure 12 RS-232 Terminal Port

The RS-232 Terminal Port is used to establish a local (out-of-band) management session with the switch. Using the port, you can access the switch's management software and configure the switch's operating parameters.

You establish a local management session by connecting either a VT100 terminal or a personal computer with a terminal emulation program to the port.

Note

You are not required to manage an AT-8326GB Fast Ethernet switch. The default switch settings may be sufficient for your network, in which case you can use the unit as an unmanaged switch. For the switch's default settings, refer to **Default Switch Settings** on page 69.

The RS-232 Terminal Port has a DB-9 female connector and uses a null modem management cable.

The default settings for the RS-232 Terminal Port are:

- Emulation mode: VT100
- Data rate: 9600
- Data bits: 8
- Parity: None
- Stop bits: 1
- Flow control: None
- Key mode: Terminal

AC Power Connector

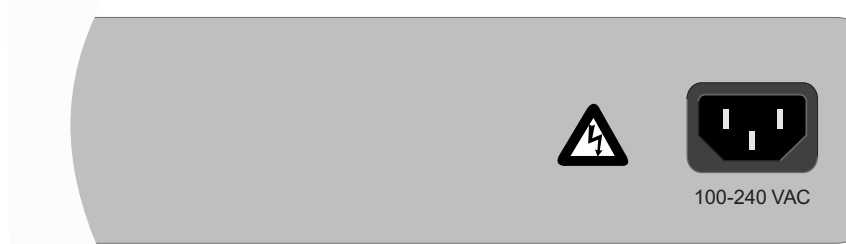

Figure 13 AC Power Connector

The switch has a single AC power supply socket on the back panel, which has autoswitch AC inputs. Refer to the **Technical Specifications** on page 67 for the input voltage range. To power ON or OFF the switch, you connect or disconnect the power cord.

Software Features

The following sections describe these software features:

- AT-S41 Management Software
- Spanning Tree Protocol (STP)
- Tagged and Port-based Virtual LANs (VLANs)
- Quality of Service
- IGMP Snooping
- Dynamic Host Configuration Protocol (DHCP)
- Port Monitoring
- Port Trunking
- Port Security

Note

All of the features described here are further described in the **AT-S41 Management Software User's Guide**.

AT-S41 Management Software

The AT-8326GB Fast Ethernet switch comes with the AT-S41 management software pre-installed. This management software has default values for all the operating parameters for a switch. In some network environments, the default settings might not need to be changed, allowing you to use the switch as an unmanaged switch.

If you want to manage the switch and change or monitor the operating parameters, you must access the AT-S41 management software. Some of the functions that you can do with the management software include assigning the switch an IP address and subnet mask, creating VLANs and port trunks, and activating and configuring the Spanning Tree Protocol parameters.

The management software's interface consists of menus and prompts that make it easy for you to configure the switch and view performance and status information.

There are four ways to access the switch's management software:

- RS-232 Terminal Port
- Web Browser
- Telnet Application Protocol
- SNMP management program

RS-232 Terminal Port

One method for accessing the management software is by connecting a terminal or a PC with a terminal emulation program to the RS-232 Terminal Port on the switch, as indicated in Figure 14. This is commonly referred to as local or out-of-band management. Please refer to **Starting a Local Management Session** on page 59 for instructions on how to start a local management session.

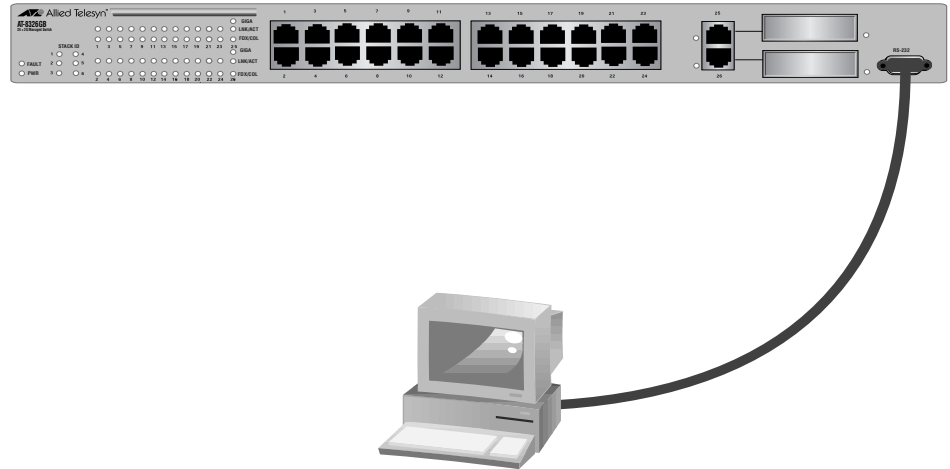

Figure 14 Local Management

Once the session has been established using “manager” as both the default login name and default password, the management software’s Main Menu is displayed on the terminal’s screen, as shown in Figure 15.

```

AT-8326GB Local Management System
Main Menu

[G]eneral Information
[B]asic Switch Configuration...
[A]dvanced Switch Configuration...
Switch [T]ools...
[S]tatistics
[Q]uit

Command>
Enter the character in square brackets to select option

```

Figure 15 AT-S41 Main Menu - Local Management Session

Web Browser

You can also manage the switch from a workstation on your network using a web browser, such as Internet Explorer. This is referred to as remote or in-band management.

To start a web browser management session, you simply enter the switch's IP address in the URL field of the web browser, as shown in Figure 16, and enter "manager" as both the default login name and default password. To manage an AT-8326GB switch stack, enter the IP address of the master switch of the stack.

URL Field with Switch IP Address

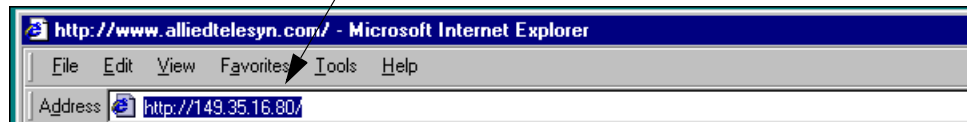

Figure 16 URL Field of a Web Browser

Figure 17 shows the AT-S41 management software's home page.

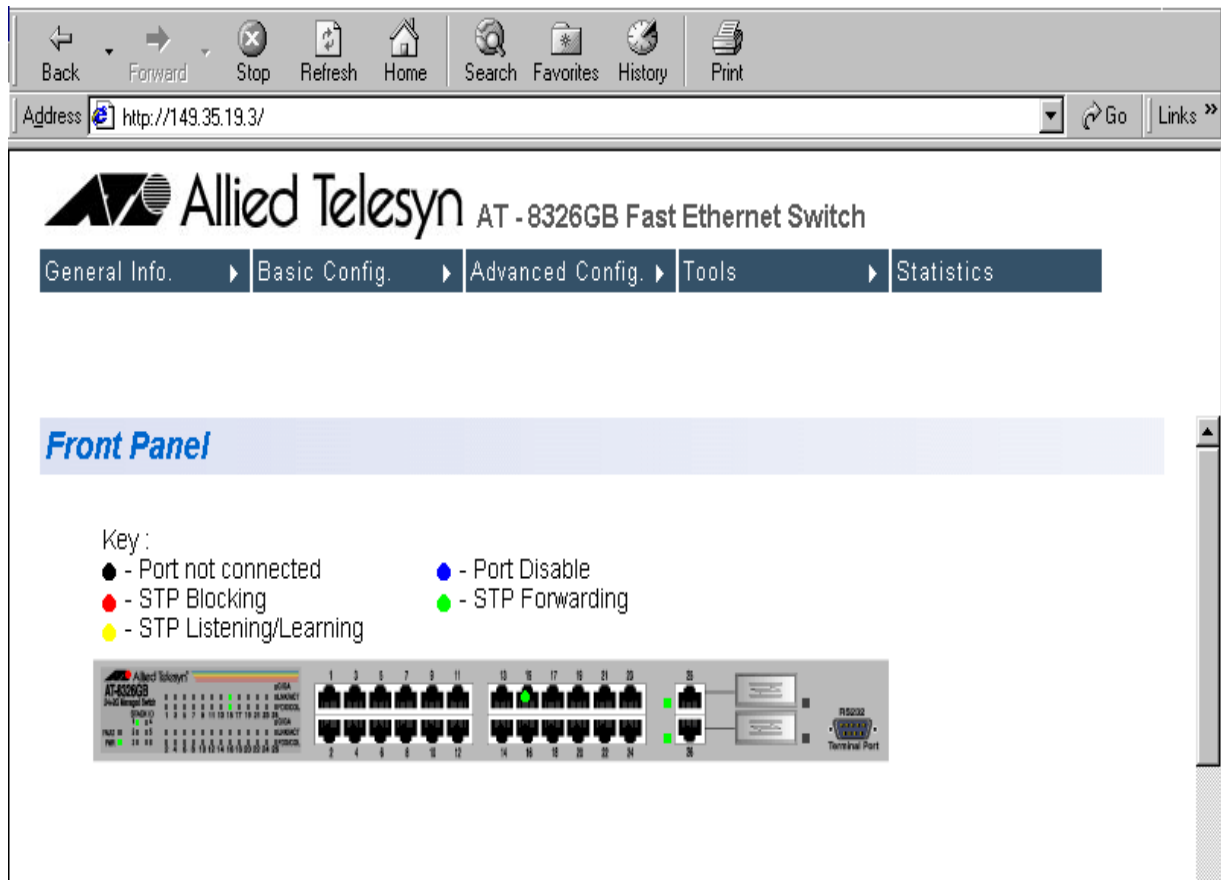

Figure 17 Web Browser Management Home Page

Telnet Application Protocol

Using the Telnet application protocol is another way for you to manage the switch remotely from a workstation on your network. Starting this type of remote access requires that you specify the IP address of the switch in the Telnet protocol and enter “manager” as both the default login name and default password.

SNMP Management

You can also manage a switch with an SNMP management program, such as HP Openview. This management method requires loading the AT-8326GB Fast Ethernet Switch MIBs into the SNMP management program. The Allied Telesyn Enterprise MIB is available in the software upgrades on the Allied Telesyn web site.

The standard MIBs supported by this switch include:

- RFC 1213 (MIB II)
- RFC 1493 (Bridge MIB)
- RFC 1757 (4-Group RMON)
- Allied Telesyn Enterprise MIB

Spanning Tree Protocol (STP)

The AT-8326GB Fast Ethernet switch is IEEE 802.1D standard-compliant and supports the spanning tree protocol. STP can be an important part of large networks where loops exist in the network topology.

A loop occurs when two or more nodes on your network can transmit data to each other over more than one link. Network loops can seriously impact network performance because packets can become caught in repeating cycles, often referred to as broadcast storms, that needlessly consume network bandwidth and reduce network performance.

STP addresses this problem by ensuring that there is only one path between the end nodes. Where multiple paths exist, STP places the extra paths in a redundant or standby mode, leaving only one main active path. The redundant paths can be activated by STP if the main path goes down. So not only does STP guard against multiple links between end nodes, but it also activates backup redundant paths in case a main link fails.

STP is disabled by default on the AT-8326GB Fast Ethernet switch.

Note

The AT-8326GB Fast Ethernet switch supports only one STP domain. All virtual LANs that you create will be members of that STP domain.

Tagged and Port-based VLANs

A VLAN is a group of end nodes that form an independent subnetwork. Each VLAN constitutes a separate broadcast domain, where the frames of a VLAN are not allowed to cross the VLAN boundary.

VLANs can be extremely useful in improving network performance and increasing network security. You can create VLANs to group the workstations, servers, and other networking equipment connected to your switches into logical workgroups. These VLAN groupings can be based on similar data needs or security requirements. When networking devices, such as workstations and servers, are grouped into a VLAN, data is exchanged between only those members of the group.

Other advantages of VLANs include:

- You can group workstations logically or functionally, regardless of their physical location on the network.
- You can change VLAN memberships anytime by software configuration without moving the workstations physically or having to move cables from one port to another on the switch.
- With VLAN tagging, network servers or other network resources can be shared among several VLANs without loss of data isolation or security.
- A VLAN can consist of ports limited to a single switch or ports from multiple switches. This allows you to group together network devices that, though physically separated by large distances, will function as if they are a part of the same physical LAN.

The AT-8326GB Fast Ethernet switch supports two types of VLANs:

- Port-based VLANs
- Tagged VLANs

The AT-8326GB Fast Ethernet switch comes configured with one port-based VLAN, called the Default VLAN. All ports on the switch are members of this Default VLAN.

Quality of Service (QoS)

The AT-8326GB Fast Ethernet switch supports the IEEE 802.1p standard and Quality of Service. QoS can be important in network environments where there are time-critical applications, such as voice transmission or video conferencing, that can be adversely affected by packet transfer delays.

Prior to QoS, network traffic was handled in a best-effort manner. File transfer delays did occur, but were mostly transparent to network users. But with the introduction of time-critical applications, packet transfer delays can impact performance. For example, delays in packets carrying voice transmission can result in poor audio quality.

The QoS feature was designed to address this problem. With it, Ethernet frames can be assigned different priorities. The switch uses the priorities when determining which frames to forward first. Frames from end-nodes running time-critical applications can be given a high priority, so that they will be forwarded by the switch ahead of less time-critical frames.

IGMP Snooping

The Internet Group Management Protocol (IGMP) enables routers to create lists of nodes that want to receive multicast packets from a multicast application. The router creates a multicast membership list by periodically sending out queries to the local area networks connected to its ports. A node wanting to become a member of a particular multicast group responds to a query by sending a report. Nodes that join a multicast group are referred to as host nodes.

Once the router has received a request from a host node to join a multicast group, it notes the multicast group that the host node wants to join and the port on the router where the node is located. Any multicast packets belonging to that multicast group are then forwarded by the router out the port. If a particular port on the router has no nodes that want to be members of multicast groups, the router does not send multicast packets out the port. This improves network performance by restricting multicast packets only to router ports where host nodes are located.

The IGMP snooping feature on the AT-8326GB switch enables the unit to monitor the flow of queries from the router and reports from the host nodes to build its own multicast membership lists. It uses the lists to forward multicast packets only to switch ports where there are host nodes that are members of multicast groups. This improves switch performance and network security by further restricting the flow of multicast packets only to those switch ports connected to host nodes.

Without IGMP snooping, the switch would flood all multicast packets out all of its ports, except the port on which it received the packet. Such flooding of packets can negatively impact switch and network performance.

Note

By default, IGMP snooping is disabled on the switch.

Note

The AT-S41 software supports both IGMP version 1 and version 2.

Dynamic Host Configuration Protocol (DHCP)

This application protocol was developed to simplify network management. It is used to automatically assign IP configuration information to the devices on your network, such as an IP address, subnet mask, and, in some instances, a default gateway address.

The AT-8326GB Fast Ethernet Switch supports this protocol and can obtain its IP configuration information from a DHCP server on your network. If you activate this feature, the switch will seek its IP address, subnet mask, and default gateway from a DHCP server residing on your network.

Most DHCP services allow you to specify whether the IP address assignment from the server is to be static or dynamic. If you choose static, the server will always assign the same IP address to the switch when the switch is reset or powered on. If you choose dynamic, the server will assign an unused IP address from its list of potential IP addresses each time the switch is reset or powered on.

Note

The DHCP option is disabled by default on the switch.

Port Monitoring

The port monitoring feature allows you to unobtrusively monitor the traffic being received and transmitted on a port on the switch by having the traffic copied to another switch port. You can connect a network analyzer to the port functioning as the monitoring port to monitor the traffic without impacting network performance or speed.

Port Trunking

Port trunking is an economical way for you to increase the bandwidth between an AT-8326GB Fast Ethernet switch and another network device, such as a server, router, workstation, or another switch. A port trunk is two or more data ports that have been grouped together to increase the bandwidth between a switch and a network node by functioning as one logical path. This increase in bandwidth can prove useful in situations where a single connection between the switch and a node is insufficient to handle the traffic load.

Port trunks are also useful in adding redundancy to the critical devices of your network. If one link of a port trunk fails, the remaining links will continue to provide a connection to the end node.

Despite the software configuration and physical connections, there are no data loops in a port trunk because of load balancing. The port trunk always sends packets from a particular source to a particular destination over the same link within the trunk. A single link is designated for flooding broadcasts and packets of unknown destination.

Below are the guidelines to follow when planning a port trunk:

- ❑ The switch can support up to four port trunks at a time.
- ❑ A port trunk can consist of up to four 10/100 Mbps twisted pair ports or two gigabit ports.
- ❑ The duplex mode, speed, and flow control settings must be the same for all of the ports in a trunk.
- ❑ When cabling a trunk, the order of the connections should be maintained on both nodes. The lowest numbered port in a trunk on the switch should be connected to the lowest numbered port of the trunk on the other device, the next lowest numbered port on the switch should be connected to the next lowest numbered port on the other device, and so on.
- ❑ The ports of a port trunk must be of the same type. For example, they can be all twisted pair ports or all fiber optic ports.
- ❑ For an AT-8326GB switch, you can create a port trunk of the GBIC modules installed in the Port 25 and Port 26 slots, provided that the GBIC modules are of the same type.
- ❑ The ports on the end node must also be configured as a port trunk.

**Caution**

Do not connect the cables of a port trunk to the switch until after you have created the port trunk using the switch's management software. Connecting the cables before the port trunk has been configured will create a data loop in your network topology, and that could adversely affect network performance.

Example of a Port Trunk

Figure 18 shows an example of a port trunk between an AT-8326GB and a network server. The server is connected to the switch with four data links. The links are connected to ports 1 through 4 on the switch.

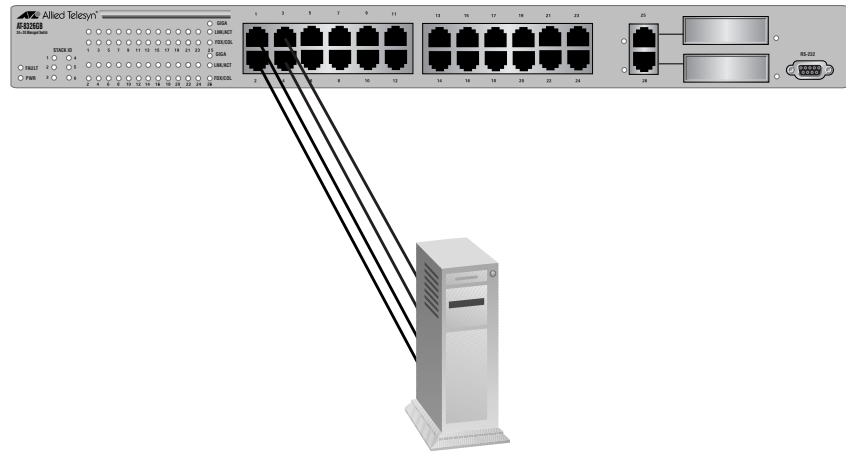

Figure 18 Port Trunk Example 1

You can also use port trunking to increase the bandwidth between switches. The example in Figure 19 shows a port trunk of four data links between two AT-8326GB Fast Ethernet switches.

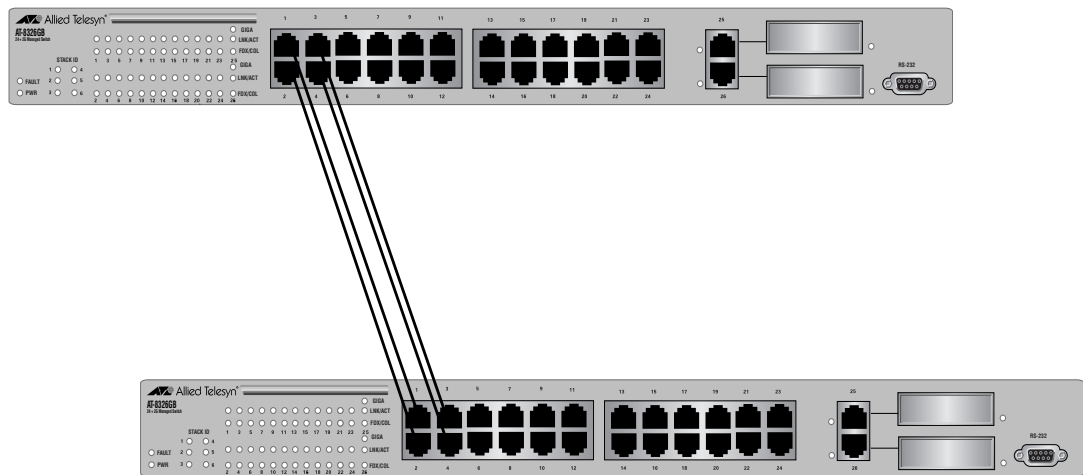

Figure 19 Port Trunk Example 2

Port Security The AT-8326GB Gigabit Ethernet switch has three levels of port security: Normal (default), Limited, and Secure. You can use the port security levels to enhance the security to your network. The security levels are briefly described below. For further information and instructions on activating a security level, refer to the **AT-S41 Management Software User's Guide**.

Normal

This is the default port security setting and indicates that port security has been disabled.

Limited

You use this security level to manually specify the maximum number of dynamic MAC addresses a port on the switch can learn. Once a port has learned its maximum limit of MAC addresses, it will discard any frames that it receives with a source MAC address not already learned and stored in the MAC address table.

This security level can prevent unauthorized individuals from connecting to your network and gaining access to network resources. For example, if an AT-8326GB port is connected to an Ethernet hub with four workstations attached, you can configure the switch port to learn only four MAC addresses. Once those addresses are learned, any one else attempting to connect to the network through the Ethernet hub would be denied access.

Secure

This security level causes the switch to immediately stop learning new dynamic MAC addresses. The switch forwards frames based on the dynamic MAC addresses that it has already learned and any static MAC addresses that the network administrator has entered.

A Few Basics to Ethernet Switching

An Ethernet switch interconnects network devices, such as workstations, printers, routers, and other Ethernet switches, so that they can communicate with each other by sending and receiving Ethernet frames.

MAC Address Table

Every hardware device on your network has a unique MAC address. This address is assigned to the device by the device's manufacturer. For example, when you install a network interface card (NIC) in a computer so that you can connect it to the network, the NIC already has a MAC address assigned to it by its manufacturer.

The AT-8326GB Fast Ethernet switch contains an 8,000 entry MAC address table. The switch uses the table to store the MAC addresses of the network nodes connected to its ports, along with the port number on which each address was learned.

The switch learns the MAC addresses of the end nodes by examining the source address of each packet received on a port. It adds the address and port on which the packet was received to the MAC table if the address had not already been entered in the table. The result is a table that contains all the MAC addresses of the devices that are connected to the switch's ports, and the port number where each address was learned.

When the switch receives a packet, it also examines the destination address and, by referring to its MAC address table, determines the port on which the destination node is connected. It then forwards the packet to the appropriate port and on to the end node. This increases network bandwidth by limiting each packet to the appropriate port where the intended end node is located, freeing the other switch ports for receiving and transmitting data.

If the switch receives a packet with a destination address that is not in the MAC address table, it floods the packet to all the ports on the switch. If the ports have been grouped into virtual LANs, the switch floods the packet only to those ports which belong to the same VLAN as the port on which the packet was received. This prevents packets from being forwarded onto inappropriate LAN segments, increasing network security. When the destination node responds, the switch adds its MAC address and port number to the table.

If the switch receives a packet with a destination address that is on the same port on which the packet was received, it discards the packet without forwarding it on to any port. Since both the source node and the destination node for the packet are located on the same port on the switch, there is no reason for the switch to forward the packet.

Duplex Mode

Duplex mode refers to how an end node receives and transmits data. If an end node can receive or transmit data, but not both simultaneously, the end node is operating in what is referred to as half-duplex mode. If an end node can both receive and transmit data simultaneously, the node is said to be operating in full-duplex mode. Naturally, a node capable of operating in full-duplex can handle data much faster than a node that can only operate in half-duplex mode.

Each port on an AT-8326GB switch can operate in either half- or full-duplex mode. The ports are IEEE 802.3u-compliant and will Auto-Negotiate the duplex mode setting for you. If the end node connected to a port on the switch is capable of full-duplex operation, the switch sets the port to full-duplex. If the end node is capable of only half-duplex, the port is set automatically to half-duplex.

By allowing the switch to configure the duplex mode for each port itself, you will not need to change the setting for a port on the switch should you replace an end node with a node that has a different duplex mode capability. With Auto-Negotiation, the switch will automatically reset the port to a new duplex mode setting for you.

If desired, Auto-Negotiation on the switch ports can be disabled so that you can set the duplex mode manually through the switch's management software.

Store and Forward

These Fast Ethernet switches use store and forward as the method for receiving and transmitting frames. When a Ethernet frame is received on a switch port, the switch does not retransmit the frame out the destination port until it has received the entire frame and stored the frame in a port buffer. It then examines the frame to determine if it is a valid frame. Invalid frames, such as fragments or runts, are discarded by the switch. This insures that only valid frames are transmitted out the switch ports and that damaged frames are not propagated on your network.

Backpressure and Flow Control

In order for an Ethernet switch to maintain the orderly movement of data between the end nodes that are connected to its ports, it may periodically need to signal an end node to stop sending data. This can occur under several circumstances. For example, if two end nodes are operating at different speeds, the switch, while transferring data between the nodes, might need to instruct the faster end node to stop transmitting data to allow the slower end node to catch up. An example of this would be when a server operating at 100 Mbps is sending data to a workstation operating at only 10 Mbps.

How a switch signals an end node to stop transmitting data differs depending on the speed and duplex mode of the end node and switch port. A twisted pair port operating at 100 Mbps port and half-duplex mode stops an end node from transmitting data by forcing a collision. A collision on an Ethernet network occurs when two nodes attempt to transmit data using the same data link at the same time. A collision causes end nodes to stop sending data. When the switch needs to stop a 100 Mbps, half-duplex end node from transmitting data, it forces a collision on the data link, which stops the end node. Once the switch is ready to receive data again, the switch stops forcing collisions. This is referred to as backpressure.

A twisted pair port operating at 100 Mbps and full-duplex mode uses PAUSE frames, as specified in the IEEE 802.3x standard, to stop the transmission of data from an end node. Whenever the switch wants an end node to stop transmitting data, it issues this frame. The frame instructs the end node to cease transmission. The switch continues to issue PAUSE frames until it is ready again to receive data from the end node. This is referred to as flow control.

Network Topologies

This section illustrates several of the network topologies you can create with the AT-8326GB Fast Ethernet switches.

Power Workgroup Topology

The topology shown in Figure 20 is commonly referred to as a power workgroup topology. Each workstation or node is connected directly to a port on an AT-8326GB Fast Ethernet switch, giving each node a dedicated data link to the switch for best performance and reliability. The devices can operate at either 10 Mbps or 100 Mbps.

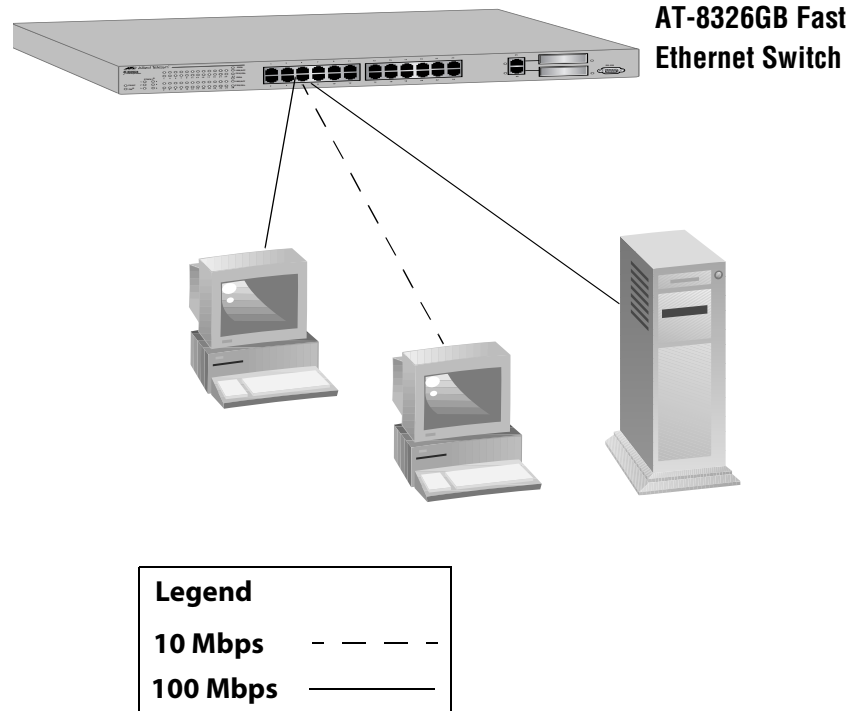

Figure 20 Power Workgroup Topology

Collapsed Backbone - Hub Topology

In the topology illustrated in Figure 21, an AT-8326GB Fast Ethernet switch is used to connect 10/100 Mbps Ethernet hubs. This type of topology is often referred to as a collapsed backbone topology. The switch functions as the focal point for all workgroup hubs in your network by acting as a bridge between the different workgroups. The switch transfers an Ethernet frame from hub to hub only when the destination node for the frame is on a different hub than the node that originated the frame. This reduces the amount of unnecessary data traffic in each workgroup, freeing up bandwidth and improving network performance.

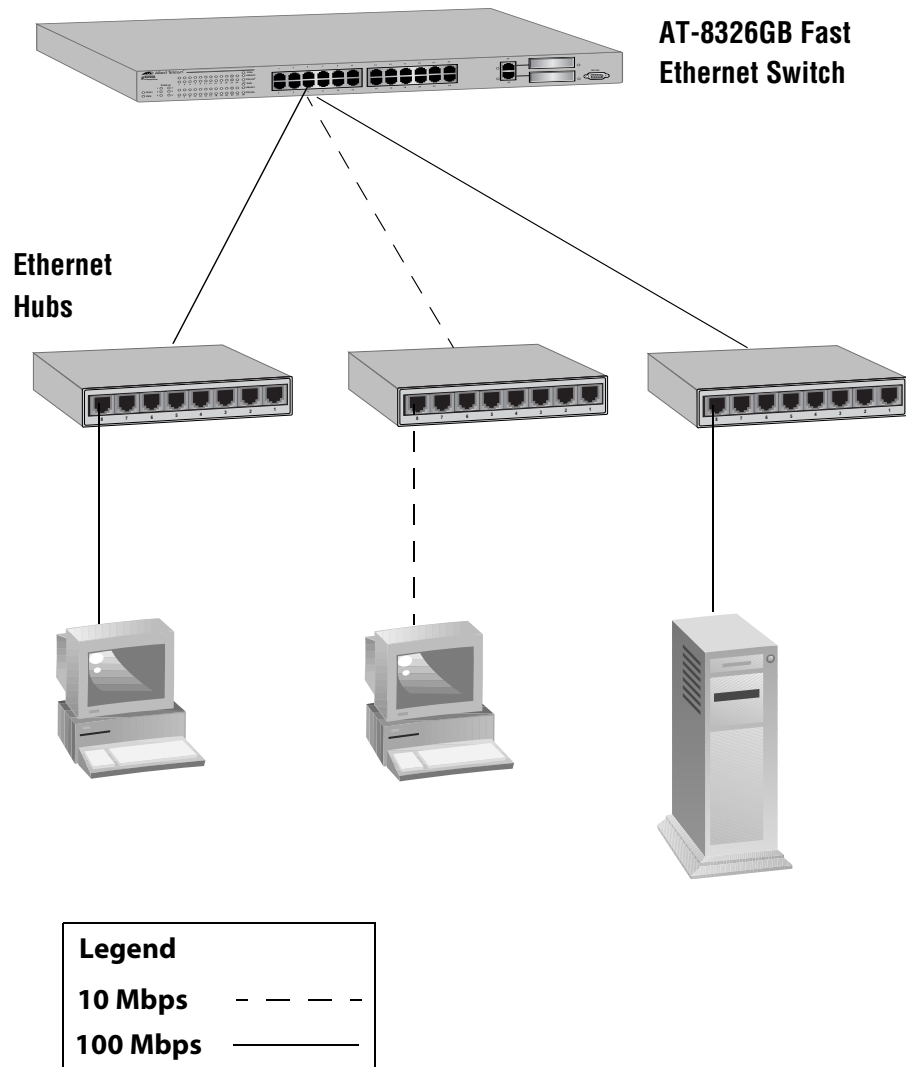

Figure 21 Collapsed Backbone - Hub Topology

Switch Stacking Topology

A switch stack creates a powerful logical switch by allowing two or more individual switches to function as one unit. Switch stacks can simplify network management because you can manage the switches as a unit, rather than individually. The network topology in Figure 22 includes several examples of AT-8326GB switch stacks.

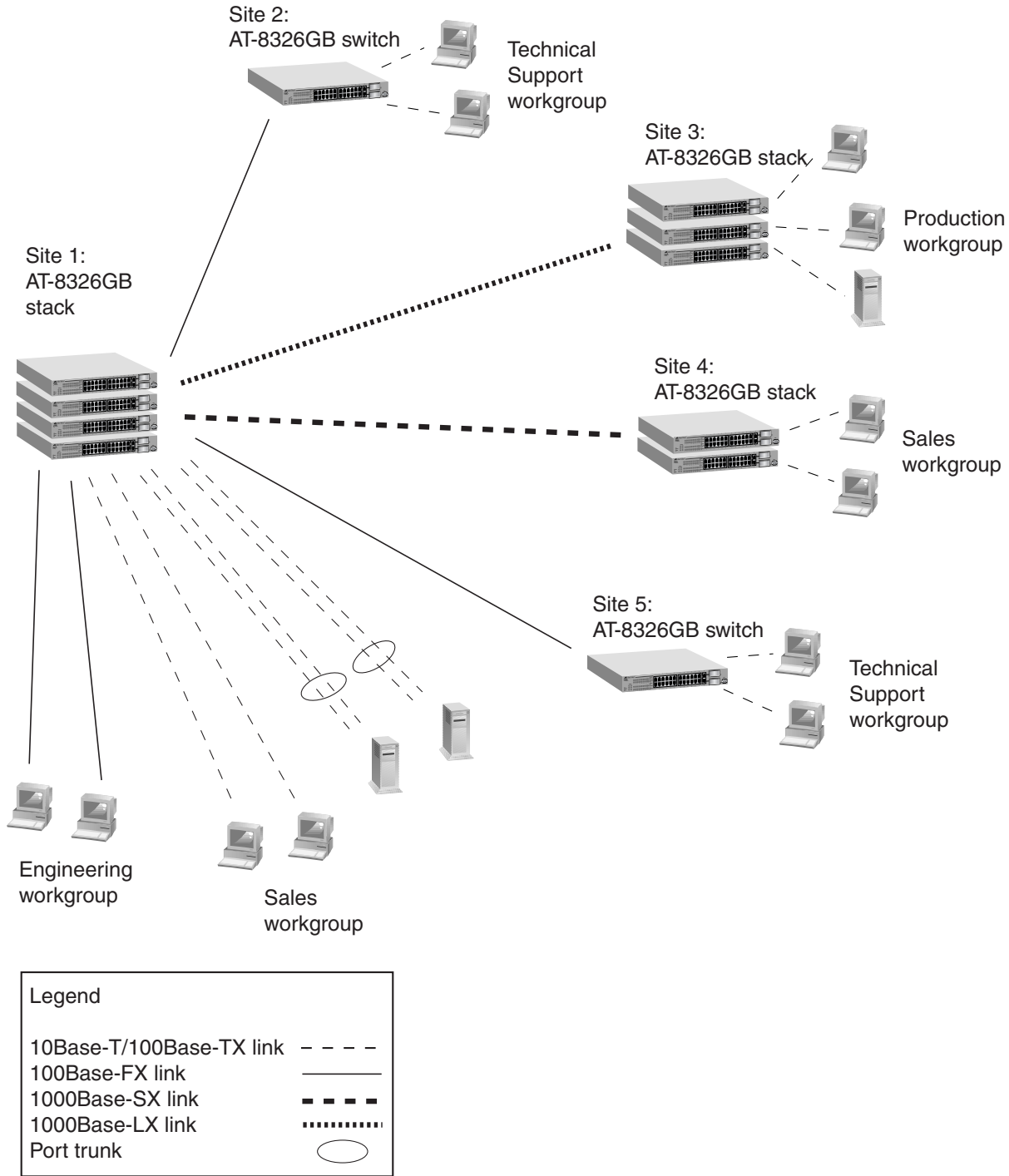

Figure 22 Switch Stacking Topology

Chapter 2

Installation

This chapter contains the installation procedures for the switch. This chapter contains the following sections:

- Installation Safety Precautions
- Selecting a Site for the Switch
- Required Cables
- Unpacking the Switch
- Installing the Switch on a Desktop
- Installing the Switch in a Rack
- Installing a GBIC Module
- Creating a Switch Stack
- Cabling the Switch
- Powering On the Switch
- Starting a Local Management Session
- Warranty Registration

Installation Safety Precautions

Please review the following safety precautions before you begin to install the switch. Refer to **Translated Electrical Safety and Emission Information** on page 71 for translated safety statements in your language. (The laser warnings apply only if you purchased an optional GBIC module for the AT-8326GB switch.)



Laser

Class 1 laser product. *6*



Laser

Do not stare into the laser beam. *7*



Warning

Electric Shock Hazard: To prevent electric shock, do not remove the cover. There are no user-serviceable parts inside. The unit contains hazardous voltages and should only be opened by a trained and qualified technician. *8*



Warning

Lightning Danger: Do not work on this equipment or cables during periods of lightening activity. *9*



Warning

Power cord is used as a disconnection device: To de-energize equipment, disconnect the power cord. *10*



Warning

Electrical-Type Class 1 Equipment: This equipment must be earthed. The power plug must be connected to a properly wired earth ground socket outlet. An improperly wired socket outlet could place hazardous voltages on accessible metal parts. *11*



Caution

Pluggable Equipment: The socket outlet should be installed near the equipment and should be easily accessible. *12*



Caution

Air vents: The air vents must not be blocked on the unit and must have free access to the room's ambient air for cooling. *13*



Caution

Operating Temperature: This product is designed for a maximum ambient temperature of 40°C. *14*



Caution

All Countries: Install this product in accordance with local and national electric codes. *15*

Selecting a Site for the Switch

Observe the following requirements when choosing a site for your switch:

- If you plan to install the switch in an equipment rack, check to be sure that the rack is safely secured and that it will not tip over. Devices in a rack should be installed starting at the bottom, with the heavier devices near the bottom of the rack.
- If you are installing the switch on a table, be sure that the table is level and secure.
- The power outlet for the switch should be located near the unit and should be easily accessible.
- The site should allow for easy access to the ports on the front of the switch. This will make it easy for you to connect and disconnect cables, as well as view the switch's LEDs.
- To allow proper cooling of the switch, air flow around the unit and through its vents on the side and rear should not be restricted.
- Do not place objects on top of the switch.
- Do not expose the switch to moisture or water.
- Make sure that the site is a dust-free environment.
- You should use dedicated power circuits or power conditioners to supply reliable electrical power to the network devices.
- When stacking switches, a common power source such as a power strip is recommended for all of the switches in the stack.

Required Cables

Table 7 contains the specifications of the cables required for the twisted pair ports on the AT-8326GB Fast Ethernet switch.

Table 7 Media Types and Distances

| Speed | Category | Maximum Distance |
|-----------|---|------------------|
| 10 Mbps | Category 3 or better 100-ohm shielded or unshielded, straight-through or crossover twisted pair cable | 100 m (328 ft.) |
| 100 Mbps | Category 5 or Category 5E (Enhanced) 100-ohm shielded or unshielded, straight-through or crossover twisted pair cable | 100 m (328 ft.) |
| 1000 Mbps | Category 5 and Category 5E (Enhanced) 100-ohm shielded or unshielded, straight-through twisted pair cable | 100 m (328 ft.) |

Note

The ports on the AT-8326GB switch are IEEE 802.3ab-compatible and are configured automatically by the switch as MDI or MDI-X when connected to a 10 Mbps or 100 Mbps end node. This allows you to use either a straight-through or cross-over cable.

Note

For cabling specifications for an optional GBIC module, refer to the **GBIC Installation Guide** included with the module.

Unpacking the Switch

To unpack the switch, perform the following procedure:

1. Remove all components from the shipping package and store the packaging material in a safe location.

Note

You must use the original shipping material if you need to return the unit to Allied Telesyn.

2. Place the switch on a level, secure surface.
3. Make sure the following hardware components are included in your switch package. If any item is missing or damaged, contact your Allied Telesyn sales representative for assistance.

- One AT-8326GB Fast Ethernet switch
- Two mounting brackets
- Eight Phillips-head screws
- Four rubber feet
- Power cord (Americas, EC, Australia, and UK only)
- Null modem management cable
- One stacking cable
- Documentation CD
- Warranty card
- Two extra serial number stickers
- Two extra MAC address labels

Installing the Switch on a Desktop

Perform the following procedure to install the switch on a desktop or table. If you would prefer to install the switch in a rack, go to the next procedure:

1. Place the unit upside down on a level, secure surface.
2. Remove the adhesive tabs from the stick-on rubber feet and apply one tab to each corner on the bottom of the switch.
3. Turn the switch over.

Installing the Switch in a Rack

Perform the following procedure to install the switch in a standard 19-inch rack. If you are not installing the switch in a rack, go to the next procedure:

1. Attach a rack-mounting bracket to one side of the switch using four of the screws that came with the switch. See Figure 23.

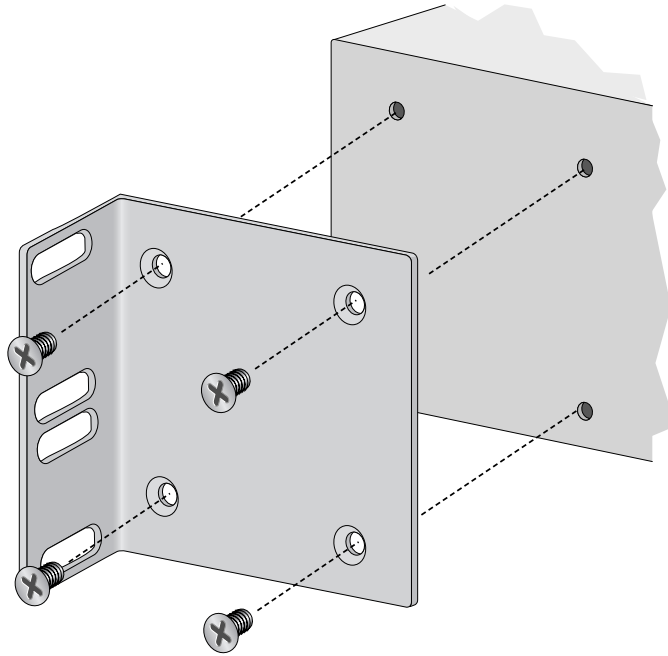

Figure 23 Attaching a Rack-mounting Bracket

2. Install the second rack-mounting bracket on the other side of the switch using the four remaining screws.

3. Mount the switch in a 19-inch rack using standard screws (not provided).

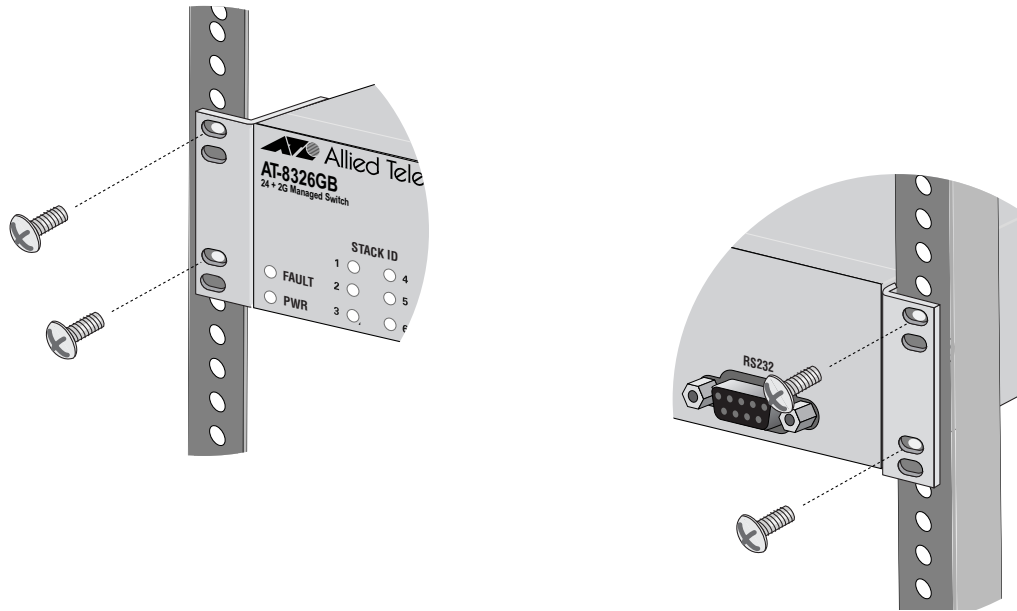

Figure 24 Installing the Switch in a Rack

Installing an Optional GBIC Module

If you purchased an optional GBIC module, perform the following procedure. If you did not purchase an optional module, go to the next procedure.

1. Unpack the GBIC module from its shipping container and store the packaging material in a safe location.

Note

You must use the original shipping material if you need to return the module to Allied Telesyn.

**Warning**

A GBIC module can be damaged by static electricity. Be sure to observe all standard electrostatic discharge (ESD) precautions, such as wearing an antistatic wrist strap, to avoid damaging the module.

2. Check that the GBIC package includes all the items listed below. If any item is missing or damaged, contact your Allied Telesyn sales representative for assistance.
 - One GBIC module
 - Installation Guide
 - Warranty card

- Slide the GBIC module into one of the GBIC slots in the front of the AT-8326GB switch. The GBIC module is completely seated in the slot when it clicks into place.

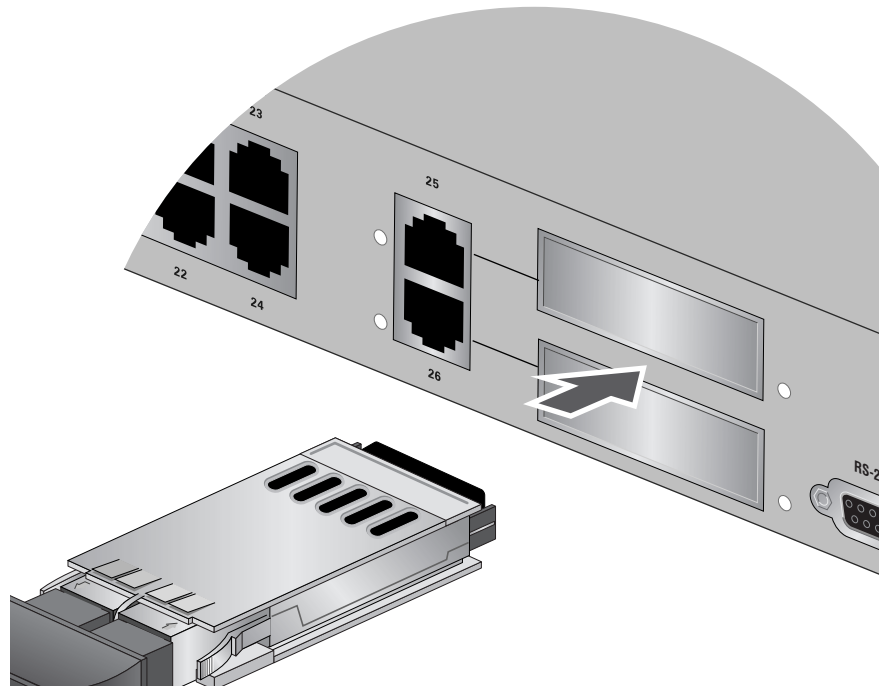

Figure 25 Installing a GBIC Module

- If you purchased two GBIC modules for the switch, repeat this procedure to install the second module.

Note

In order to use a GBIC module in Port 25 or 26, you must configure the port in the management software to operate as a GBIC port and not as a twisted pair port. For instructions, refer to the **AT-S41 Management Software User's Guide**. When you change the port setting in the management software to GBIC, the GBIC connector LED to the right of the GBIC slot will turn green.

Creating a Switch Stack

To create a switch stack, perform the following procedure. If you are not creating a switch stack, go to the next procedure.

An AT-8326GB stack can contain two to six switches. A stack of AT-8326GB switches may be created in a daisy chain configuration only. Star and redundant path stacking configurations are not permitted with the AT-8326GB.

To build a stack of two or more switches, perform the following steps:

1. Select one of the Ethernet switches to be the master switch of the stack. The other switch(es) will be slave switch(es). If the switches have different versions of the AT-S41 management software, select the switch that has the most recent version of the AT-S41 management software as the master switch.

Note

During network operations, the master switch will overwrite the AT-S41 software in the slave switches with its own version of the management software. This occurs even if a slave switch contains a more recent version of the AT-S41 software. For this reason, it is important that the switch you select to be the master switch has the most recent version of the management software.

2. Make sure the switches are powered OFF.
3. Connect an LVDS cable between the STACK OUT port on the back panel of the master switch and the STACK IN port on the back panel of the slave switch. If stacking more than two switches, continue to connect each subsequent slave switch in the same way to create a daisy chain configuration.

Figure 26 illustrates a stack of two switches connected with one LVDS cable between the STACK OUT port on the master switch and the STACK IN port on the slave switch.

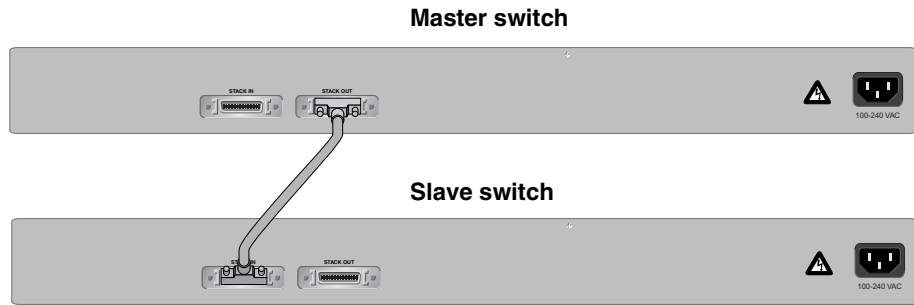

Figure 26 Stack of Two Switches with LVDS Cable

Figure 27 illustrates a stack of six switches.

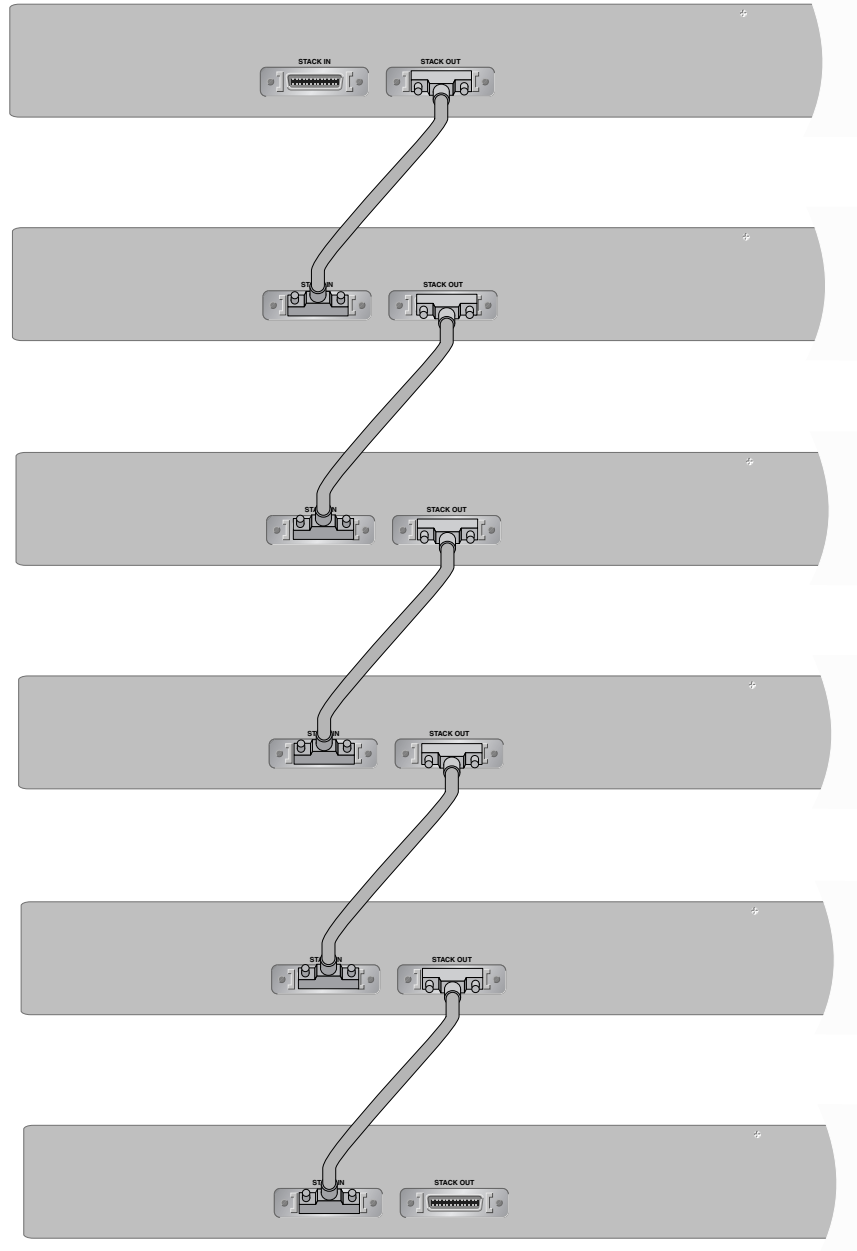

Figure 27 A Stack of Six Switches

Note

Never add or remove an LDVS cable when the switches are powered ON.

Cabling the Switch

Perform the following procedure to connect the data cables to the switch ports. Refer to **Required Cables** on page 45 for cable specifications.

1. Connect the data cables to the RJ-45 ports on the switch, as shown in Figure 28.

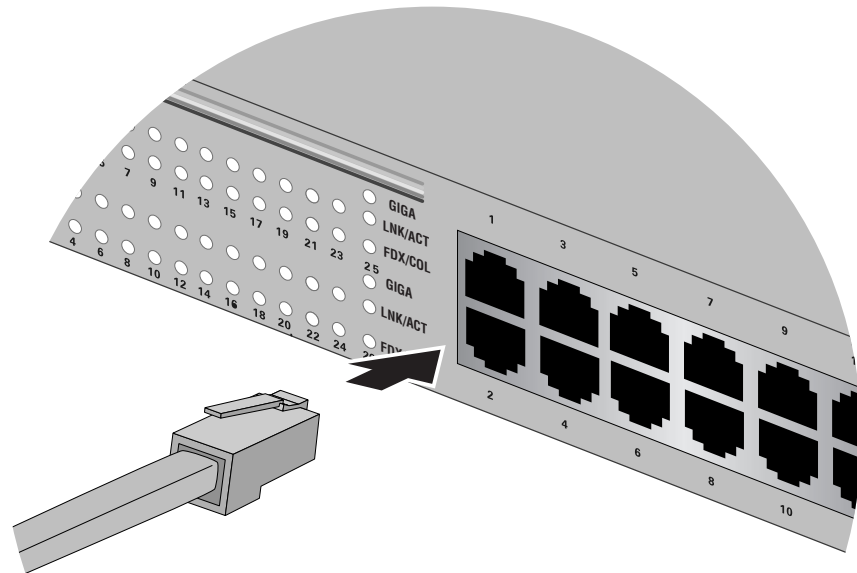

Figure 28 Connecting the Data Cables

When connecting a cable to a port on the switch, observe the following guidelines:

- An RJ-45 connector should fit snugly into the port on the switch. The tab on the connector should lock the connector into place.
- Do not connect a port on the switch to a phone jack. Doing so can damage the switch.
- Since the RJ-45 ports on the switch are auto-MDI/MDI-X, you can use either straight-through or cross-over twisted pair cables to connect the network devices.
- If your network topology will contain a loop where two or more network devices can communicate with each other over more than one data path, do not connect the network cables forming the loop until after you have activated the Spanning Tree Protocol (STP) on the switch. Data loops can adversely affect network performance. For instructions on how to activate STP, refer to the **AT-S41 Management Software User's Guide**.

- ❑ If you are creating a port trunk, do not connect the cables of the trunk to the switch until you have configured the trunk using the switch's management software. Connecting the trunk cables to the switch before you have configured the software will result in a data loop, which can adversely affect network performance. For instructions on how to configure a port trunk, refer to the **AT-S41 Management Software User's Guide**.
2. If you installed an optional GBIC module, remove the dust cover from the GBIC port. Store the dust cover in a safe place so that you can use it to protect the port if you disconnect the fiber cable.

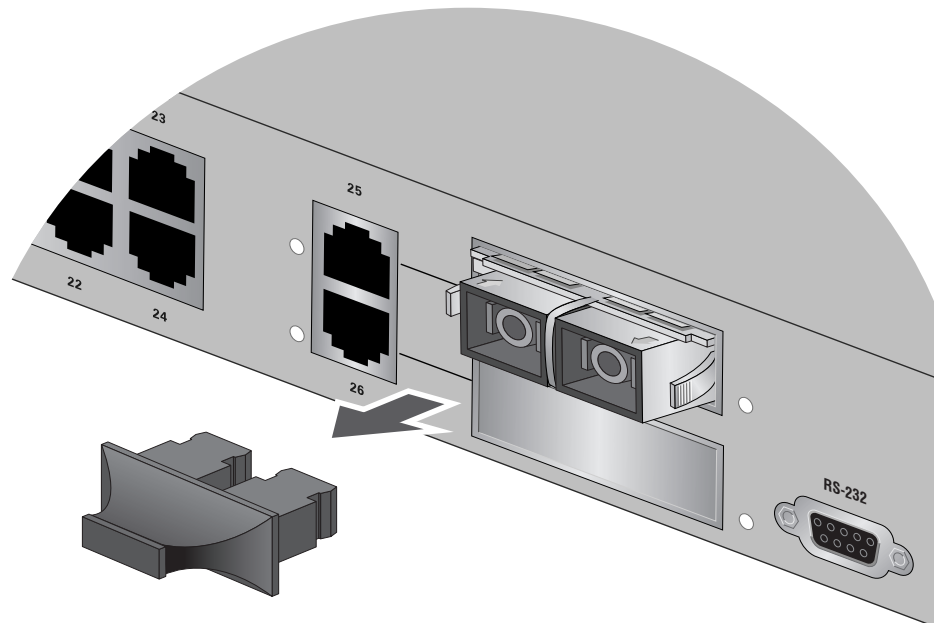

Figure 29 Removing the Dust Cover from a GBIC Module



Caution

Do not remove the dust cover if you do not intend to connect the GBIC cable at this time. Dust contamination can adversely impact the operations of the port.

3. Attach the data cable to the port on the GBIC module.

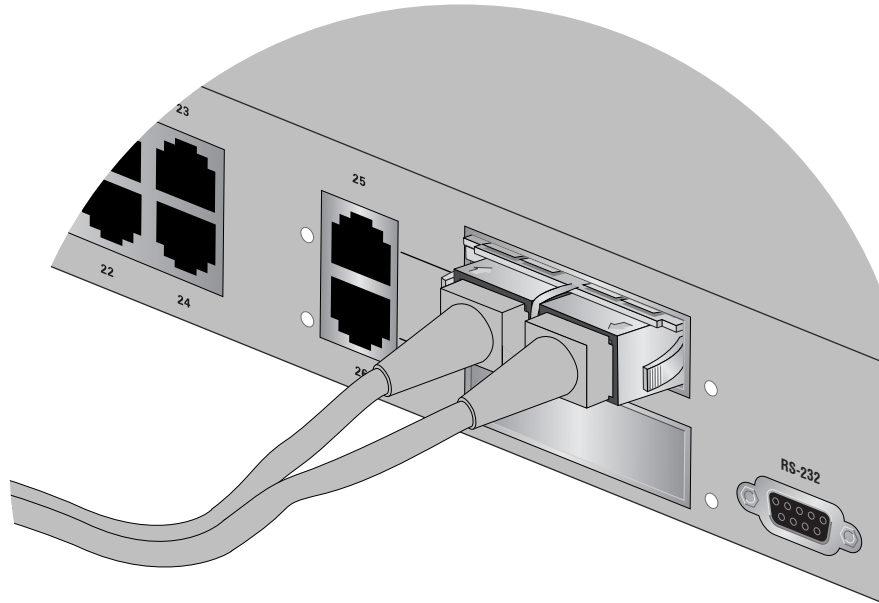

Figure 30 Attaching a Cable to a GBIC Module

When you attach a fiber optic cable to a GBIC module, be sure to observe the following guidelines:

- You should verify that you are using the appropriate type of fiber optic cabling. For GBIC cabling specifications, refer to the **GBIC Installation Guide**.
- You should verify that the operating specifications of the remote fiber optic port are compatible with the GBIC module. For example, you cannot connect a fiber optic GBIC module with a maximum distance of 40 kilometers and an operating wavelength of 1550 nanometers (nm) to a remote fiber optic port with a maximum distance of only 10 kilometers and an operating wavelength of 1310 nm.
- Be sure that the cable connector is firmly locked into place in the port.
- If the GBIC module has a dual SC connector, be sure to connect the receiver fiber port on the module to the transmitter port on the remote end node, and the transmitter fiber port on the GBIC module to the receiver port on the remote node.

Powering On the Switch

1. Apply AC power to the switch by plugging the power cord into the AC power connector on the back panel of the unit and plugging the other end into a wall outlet.

If powering on a switch stack, power on the last slave switch in the stack first and then each slave switch in the daisy chain hierarchy in ascending order, ending with the master switch. To simplify the process, you can connect all of the switches, both master and slaves, to the same power circuit, such as a power strip, and so be able to apply power to all of the switches at the same time.



Warning

The power cord is used as a disconnection device. To de-energize equipment, disconnect the power cord. *EN 10*

As power is applied to the switch, the Fault LED (shown in Figure 31) flashes briefly as the switch loads its operating software. This process takes only a minute or two. After the switch has finished loading its software, the Fault LED will stop flashing and remain OFF.

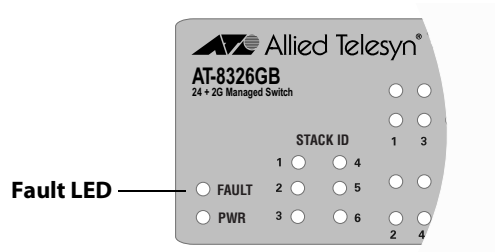

Figure 31 Fault LED

Note

Refer to the section **System LEDs** on page 19 for information on the system LEDs.

The switch is ready for network operations.

Note

If you do not need to change the default parameter settings of the switch, no further installation steps are required. For the default settings, refer to the **AT-S41 Management Software User's Guide**.

Starting a Local Management Session

The procedure in this section explains how to start a local (out-of-band) management session using the RS-232 Terminal Port on the front panel of the switch. You can use a local management session to configure the switch's operating parameters and view performance and error statistics.

To start a local management session, perform the following procedure:

1. Connect one end of the null modem management cable to the RS-232 Terminal Port on the front panel of the master switch, as shown in Figure 32.

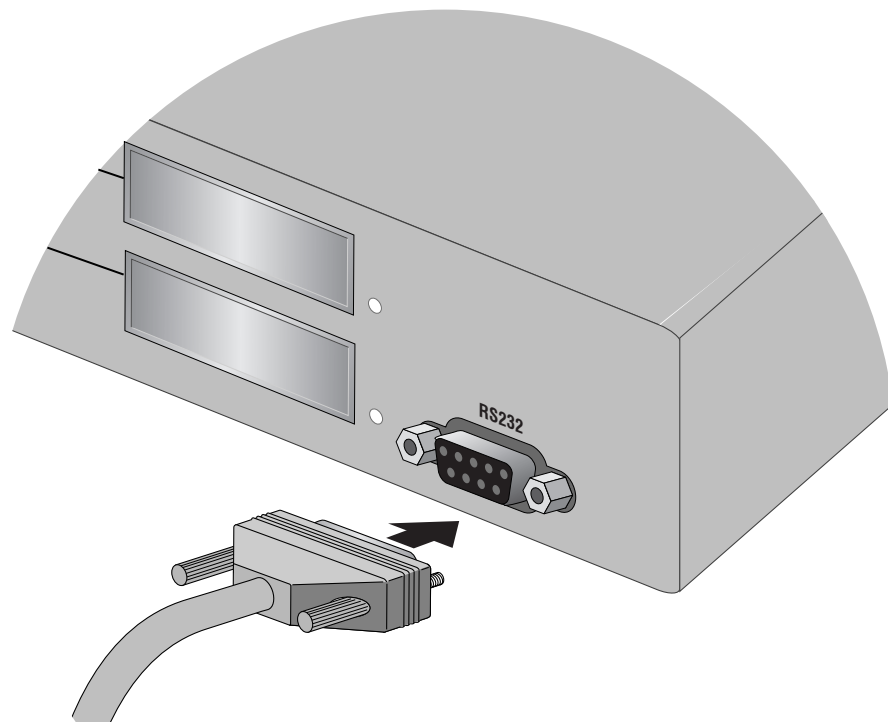

Figure 32 Connecting the Null Modem Management Cable to the RS-232 Terminal Port

Note

You must connect the terminal to the RS-232 port on the master switch to locally manage a switch stack. You cannot locally manage a switch stack through a slave switch.

2. Connect the other end of the cable to an RS-232 port on a terminal or a personal computer with a terminal emulation program.

3. Set the terminal or the terminal emulation program to the following settings:

- Emulation mode: VT100
- Baud rate: 9600
- Data bits: 8
- Parity: None
- Stop bits: 1
- Flow control: None
- Key mode: Terminal keys

Note

These are the default settings for the RS-232 Terminal Port. They are for a DEC VT100 or ANSI terminal or an equivalent terminal emulation program.

When the terminal session starts, it displays the management software's login prompt, shown in Figure 34. Enter the login name and password. The default login name and default password are both "manager." For instructions on how to change the password, refer to the **AT-S41 Management Software User's Guide**.

```

AT-8326GB Management System Version 1.00F
Local - Console
Allied Telesyn International Corp.
Copyright, 2001
=====

Login Menu
Login: manager
Password: _
  
```

Figure 33 AT-S41 Login Prompt - Local Management Session

The switch displays the management software's Main Menu, shown in Figure 34.

```
AT-8326GB Local Management System
Main Menu

[G]eneral Information
[B]asic Switch Configuration...
[A]dvanced Switch Configuration...
Switch [T]ools...
[S]tatistics
[Q]uit

Command>
Enter the character in square brackets to select option
```

Figure 34 AT-S41 Main Menu - Local Management Session

You can now manage the switch using the management interface. For instructions, refer to the **AT-S41 Management Software User's Guide**. This guide is available from the Allied Telesyn web site at www.alliedtelesyn.com.

Warranty Registration

When you have finished installing the switch, register your product by completing the enclosed warranty card and sending it in, or by visiting our web site and completing the on-line registration form.

Chapter 3

Troubleshooting

This chapter contains information on how to troubleshoot the switch in the event a problem occurs.

Note

If after following the instructions in this chapter you are unable to resolve the problem, contact Allied Telesyn Technical Support for assistance. Refer to **Contacting Allied Telesyn** on page 9 for information on how to contact our Technical Support Department.

Check the PWR LED on the front of the switch. If the LED is OFF, indicating that the unit is not receiving power, do the following:

- Make sure that the power cord is securely connected to the power source and to the AC connector on the back panel of the switch.
- Verify that the power outlet has power by connecting another device to it.
- Try connecting the unit to another power source.
- Try using a different power cord.
- Check that the voltage from the power source is within the required levels for your region.

Verify that the LINK LED for each twisted pair port is ON or flashing. If a Link LED is OFF, do the following:

- Verify that the end node connected to the port is powered ON and is operating properly.

- ❑ Check that the twisted pair cable is securely connected to the port on the switch and to the port on the end node.
- ❑ Make sure that the twisted pair cable does not exceed 100 meters (328 feet).
- ❑ Verify that you are using the appropriate category of twisted pair cable: Category 3 or better for 10 Mbps operation, Category 5 and Category 5E for 100/1000 Mbps operation.
- ❑ Make sure that the operating parameters of the port on the switch are compatible with the end node to which the port is connected. This will require using the switch's management software. For instructions, refer to the **AT-S41 Management Software User's Guide**.

If you installed an optional GBIC module, verify that the LINK LED for the port is ON. If the LED is OFF, do the following:

- ❑ Check to make sure that the GBIC module is completely seated in the GBIC slot. It should click into place.
- ❑ Verify that the end node connected to the port is powered ON and is operating properly.
- ❑ Check that the fiber optic cable is securely connected to the port on the switch and to the port on the end node.
- ❑ Make sure that the cable connected to the fiber optic receiver port on the GBIC module is connected to the transmitter port on the remote end node and that the fiber optic transmitter port on the GBIC module is connected to the receiver port on the end node. The GBIC port LED will be illuminated when the Tx and Rx ports are connected properly. If the LINK LED is not illuminated, reverse the cables. Refer to **Gigabit Connector LEDs** on page 23 for more information.
- ❑ Make sure that the fiber optic cable does not exceed the allowed maximum distance. For GBIC maximum distances, refer to the **GBIC Installation Guide**.
- ❑ Verify that you are using the appropriate type of fiber optic cable. For cable specifications, refer to the **GBIC Installation Guide**.
- ❑ Use a fiber optic tester to test the attenuation on the cable to determine if the strength of the fiber optic signal falls below

acceptable limits. For specifications on the transceiver in the GBIC module, refer to the **GBIC Installation Guide**.

- ❑ Check that the operating specifications (for instance, wavelength and maximum operating distance) of the fiber optic port on the remote end node are compatible with the fiber optic port on the GBIC module. For example, you cannot connect a GBIC module with a maximum distance of 40 kilometers and a wavelength of 1550 nanometers (nm) to a remote fiber optic port with an maximum distance of only 10 kilometers and a wavelength of 1310 nm.
- ❑ Make sure you have configured the port in the management software as a GBIC port and not as a twisted pair port. For instructions on how to change this setting, refer to the **AT-S41 Management Software User's Guide**. When you change the port setting in the management software to GBIC, the GBIC connector LED to the right of the GBIC slot will turn green.
- ❑ Verify that the remote fiber optic port is operating at 1000 Mbps and in full-duplex mode. The 1000 Mbps operating speed of a GBIC module is fixed and cannot be changed.

If the FAULT LED is blinking, no action is required. A blinking FAULT LED could indicate that a new version of the management software is being downloaded to the switch or that the switch's configuration is being changed, such as with the creation of a new VLAN. The LED will stop blinking once the switch has completed the download or its reconfiguration.

If the FAULT LED is constantly ON, a problem has occurred in the switch. Do the following:

- ❑ Power OFF the switch by disconnecting the power cord, wait a few moments, and then reconnect the power cord.
- ❑ If the FAULT LED remains ON, try downloading a new version of the switch's management software through the RS-232 Terminal Port on the front panel of the switch. For instructions, refer to the switch's software management guide.

Note

If the FAULT LED remains steady ON, contact Allied Telesyn Technical Support for assistance.

If you are unable to establish a local management session with the switch through the RS-232 Terminal Port on the front panel, do the following:

- Check to be sure that the null modem management cable is securely connected to the RS-232 Terminal Port on the switch and to the RS-232 port on the terminal or personal computer.
- Check to be sure that you are using the null modem management cable included with the switch.
- Check to be sure that the operating parameters on the terminal or the terminal emulation program, if you are using a personal computer, have been set correctly. The default settings for the RS232 Terminal Port can be found in **Starting a Local Management Session** on page 59.
- If you are managing a switch stack, check to be sure that the null modem management cable is connected to the master switch, not a slave switch.

Appendix A

Technical Specifications

Physical Specifications

| | |
|--|--|
| Dimensions | 44 cm x 25.3 cm x 6.4 cm (W x D x H) (17.32 in. x 9.96 in. x 2.5 in.) |
| Weight | 2.7 kg (5.9 lbs) |
| Recommended Minimum Ventilation on All Sides | 5.08 cm (2.0 in.) |

Environmental Specifications

| | |
|--------------------------|-----------------------------------|
| Operating Temperature | 0° C to 40° C (32° F to 104° F) |
| Storage Temperature | -20° C to 70° C (-4° F to 158° F) |
| Operating Humidity | 10% to 90% non-condensing |
| Storage Humidity | 10% to 95% non-condensing |
| Operating Altitude Range | Up to 3,000 m (9,843 ft) |
| Storage Altitude Range | Up to 4,570 m (15,000 ft) |

Power Specifications

| | |
|---------------------------|-------------|
| Maximum Power Consumption | 35 Watts |
| AC Input Voltage | 100-240 VAC |
| Frequency | 50-60 Hz |

Safety and Electromagnetic Emissions Certifications

| | |
|-------------------------|---|
| Safety | UL 1950 (UL/cUL), EN60950 |
| EMI | FCC Class A, EN55022, CE Class A, CISPR22 Class A (VCCI), AS/NZS3548 (C-TICK), EN61000-3-2, EN61000-3-3 |
| Immunity | EN55024 |
| Quality and Reliability | MTBF > 56,549 hrs, MTTR < 1 hr, DOA < 0.5% |

Standards

IEEE 802.3 (10Base-T Ethernet)
 IEEE 802.3u (100Base-TX Ethernet)
 IEEE 802.3z (1000Base-X Gigabit Ethernet)
 IEEE 802.3ab (1000Base-T Twisted Pair Gigabit Ethernet)
 IEEE 802.1d (Spanning Tree)
 IEEE 802.1p (Class of Service)
 IEEE 802.1q (Virtual LAN tagging)
 IEEE 802.3x (Flow Control)
 RFC 1112 (IGMP Snooping Version 1.0)
 RFC 2236 (IGMP Snooping Version 2.0)

SNMP Support

RFC 1213 (MIB II)
 RFC 1493 (Bridge MIB)
 RFC 1757 (4-Group RMON)
 Allied Telesyn Enterprise MIB

Appendix B

Default Switch Settings

This appendix lists the factory default settings for the switch.

| Setting | Default |
|-------------------------------|----------------|
| IP Address | 0.0.0.0 |
| Subnet Mask | 0.0.0.0 |
| Gateway Address | 0.0.0.0 |
| DHCP | Disabled |
| IGMP Snooping | Disabled |
| System Name | None |
| MAC Aging Time | 300 seconds |
| Spanning Tree Protocol | |
| Status | Disabled |
| Bridge Priority | 32768 |
| Bridge Max Age Time | 20 |
| Bridge Hello Time | 2 |
| Bridge Forwarding Delay | 15 |
| Twisted Pair Ports | |
| Status | Enabled |
| Duplex Mode | Auto-Negotiate |
| Speed | Auto-Negotiate |
| Flow Control | Enabled |
| Broadcast Control | Disabled |
| MDI/MDI-X | Auto |
| Security | Normal |
| Port Mirroring | Disabled |
| Port Trunking | Disabled |

| Setting | Default |
|-----------------------------------|--------------------------|
| Ports 25 and 26 | |
| Port Type (GBIC or Twisted Pair) | Twisted Pair |
| VLANs | |
| Port-based and Tagged VLANs | Enabled |
| Default VLAN Name | Default VLAN (all ports) |
| VID | 1 |
| RS-232 Terminal Port | |
| Emulation Mode | VT100 |
| Data Bits | 8 |
| Stop Bits | 1 |
| Parity | None |
| Flow Control | None |
| Data Rate | 9600 bps |
| Key Mode | Terminal |
| Software Management Access | |
| Login Name | manager |
| Login Password | manager |

Appendix C

Translated Electrical Safety and Emission Information

Important: This appendix contains multiple-language translations for the safety statements in this guide.

Wichtig: Dieser Anhang enthält Übersetzungen der in diesem Handbuch enthaltenen Sicherheitshinweise in mehreren Sprachen.

Vigtigt: Dette tillæg indeholder oversættelser i flere sprog af sikkerhedsadvarslerne i denne håndbog.

Belangrijk: Deze appendix bevat vertalingen in meerdere talen van de veiligheidsopmerkingen in deze gids.

Important: Cette annexe contient la traduction en plusieurs langues des instructions de sécurité figurant dans ce guide.

Tärkeää: Tämä liite sisältää tässä oppaassa esiintyvät turvaohjeet usealla kielellä.

Importante: questa appendice contiene traduzioni in più lingue degli avvisi di sicurezza di questa guida.

Viktig: Dette tillegget inneholder oversettelser til flere språk av sikkerhetsinformasjonen i denne veiledningen.

Importante: Este anexo contém traduções em vários idiomas das advertências de segurança neste guia.

Importante: Este apéndice contiene traducciones en múltiples idiomas de los mensajes de seguridad incluidos en esta guía.

Obs! Denna bilaga innehåller flerspråkiga översättningar av säkerhetsmeddelandena i denna handledning.

Standards: This product meets the following safety standards.

U.S. Federal Communications Commission

RADIATED ENERGY

Note: This equipment has been tested and found to comply with the limits for a Class A digital device pursuant to Part 15 of the FCC Rules. These limits are designed to provide reasonable protection against harmful interference when the equipment is operated in a commercial environment. This equipment generates, uses, and can radiate radio frequency energy and, if not installed and used in accordance with this instruction manual, may cause harmful interference to radio communications. Operation of this equipment in a residential area is likely to cause harmful interference in which case the user will be required to correct the interference at his own expense.



Note: Modifications or changes not expressly approved by the manufacturer or the FCC can void your right to operate this equipment.

Canadian Department of Communications

This Class A digital apparatus meets all requirements of the Canadian Interference-Causing Equipment Regulations.

Cet appareil numérique de la classe A respecte toutes les exigences du Règlement sur le matériel brouilleur du Canada.

 1 RFI Emission FCC Class A, EN55022 Class A, CISPR22 Class A (VCCI), AS/NZS3548 (C-TICK), EN61000-3-2, EN61000-3-3

 2  **WARNING:** In a domestic environment this product may cause radio interference in which case the user may be required to take adequate measures.



 3 Immunity EN55024



 4 Electrical Safety UL 1950 (UL/cUL), EN60950



 5  Laser EN60825



SAFETY



 6  **WARNING:** Class 1 Laser product.





 7  **WARNING:** Do not stare into the laser beam.

 8  **ELECTRICAL NOTICES**
WARNING: ELECTRIC SHOCK HAZARD
To prevent ELECTRIC shock, do not remove the cover. No user-serviceable parts inside. This unit contains HAZARDOUS VOLTAGES and should only be opened by a trained and qualified technician. To avoid the possibility of ELECTRIC SHOCK, disconnect electric power to the product before connecting or disconnecting the LAN cables.



 9  **LIGHTNING DANGER**
DANGER: DO NOT WORK on equipment or CABLES during periods of LIGHTNING ACTIVITY.

 10  **CAUTION: POWER CORD IS USED AS A DISCONNECTION DEVICE. TO DE-ENERGIZE EQUIPMENT,** disconnect the power cord.



 11  **ELECTRICAL - TYPE CLASS 1 EQUIPMENT**
THIS EQUIPMENT MUST BE EARTHED. Power plug must be connected to a properly wired earth ground socket outlet. An improperly wired socket outlet could place hazardous voltages on accessible metal parts.

- 12  **PLUGGABLE EQUIPMENT**, the socket outlet shall be installed near the equipment and shall be easily accessible.
- 13  **CAUTION:** Air vents must not be blocked and must have free access to the room ambient air for cooling.
- 14  **OPERATING TEMPERATURE:** This product is designed for a maximum ambient temperature of 40° degrees C.
- 15  **ALL COUNTRIES:** Install product in accordance with local and National Electrical Codes.

Normen: Dieses Produkt erfüllt die Anforderungen der nachfolgenden Normen.

- 1 Hochfrequenzstörung FCC Klasse A, EN55022 Klasse A, CISPR22 Class A (VCCI), AS/NZS3548 (C-TICK), EN61000-3-2, EN61000-3-3
- 2  **WARNUNG:** Bei Verwendung zu Hause kann dieses Produkt Funkstörungen hervorrufen. In diesem Fall müßte der Anwender angemessene Gegenmaßnahmen ergreifen.
- 3 Störsicherheit EN55024
- 4 Elektrische Sicherheit UL 1950 (UL/cUL), EN60950
- 5  Laser EN60825

SICHERHEIT

- 6  **WARNUNG** Laserprodukt der Klasse 1.
- 7  **WARNUNG** Nicht direkt in den Strahl blicken.
- 8  **ACHTUNG: GEFÄHRLICHE SPANNUNG**
Das Gehäuse nicht öffnen. Das Gerät enthält keine vom Benutzer wartbaren Teile. Das Gerät steht unter Hochspannung und darf nur von qualifiziertem technischem Personal geöffnet werden. Vor Anschluß der LAN-Kabel, Gerät vom Netz trennen.
- 9  **GEFAHR DURCH BLITZSCHLAG**
GEFAHR: Keine Arbeiten am Gerät oder an den Kabeln während eines Gewitters ausführen.
- 10  **VORSICHT: DAS NETZKABEL DIENT ZUM TRENNEN DER STROMVERSORGUNG. ZUR TRENNUNG VOM NETZ, KABEL AUS DER STECKDOSE ZIEHEN.**
- 11  **GERÄTE DER KLASSE 1**
DIESE GERÄTE MÜSSEN GEERDET SEIN. Der Netzstecker darf nur mit einer vorschriftsmäßig geerdeten Steckdose verbunden werden. Ein unvorschriftsmäßiger Anschluß kann die Metallteile des Gehäuses unter gefährliche elektrische Spannungen setzen.
- 12  **STECKBARES GERÄT:** Die Anschlußbuchse sollte in der Nähe der Einrichtung angebracht werden und leicht zugänglich sein."
- 13  **VORSICHT**
Die Entlüftungsöffnungen dürfen nicht versperrt sein und müssen zum Kühlen freien Zugang zur Raumluft haben.
- 14  **BETRIEBSTEMPERATUR:** Dieses Produkt wurde für den Betrieb in einer Umgebungstemperatur von nicht mehr als 40° C entworfen.
- 15  **ALLE LÄNDER:** Installation muß örtlichen und nationalen elektrischen Vorschriften entsprechen.

Standarder: Dette produkt tilfredsstillere de følgende standarder.

1 Radiofrekvens forstyrrelsesemission FCC Klasse A, EN55022 Klasse A, CISPR22 Class A (VCCI), AS/NZS3548 (C-TICK), EN61000-3-2, EN61000-3-3

2  **ADVARSEL:** I et hjemligt miljø kunne dette produkt forårsage radio forstyrrelse. Bliver det tilfældet, påkræves brugeren muligvis at tage tilstrækkelige foranstaltninger.

3 Immunitet EN55024

4 Elektrisk sikkerhed UL 1950 (UL/cUL), EN60950

5  Laser EN60825

SIKKERHED

6  **ADVARSEL** Laserprodukt av klasse 1.

7  **ADVARSEL** Stirr ikke på strålen.

8  **ELEKTRISKE FORHOLDSREGLER**
ADVARSEL: RISIKO FOR ELEKTRISK STØD
 For at forebygge ELEKTRISK stød, undlad at åbne apparatet. Der er ingen indre dele, der kan repareres af brugeren. Denne enhed indeholder LIVSFARLIGE STRØMSPÆNDINGER og bør kun åbnes af en uddannet og kvalificeret tekniker. For at undgå risiko for ELEKTRISK STØD, afbrydes den elektriske strøm til produktet, før LAN-kablerne monteres eller afmonteres.

9  **FARE UNDER UVEJR**
FARE: UNDLAD at arbejde på udstyr eller KABLER i perioder med LYNAKTIVITET.

10  **ADVARSEL: DEN STRØMFØRENDE LEDNING BRUGES TIL AT AFBRYDE STRØMMEN.** SKAL STRØMMEN TIL APPARATET AFBRYDES, tages ledningen ud af stikket.

11  **ELEKTRISK - KLASSE 1-UDSTYR**
 DETTE UDSTYR KRÆVER JORDFORBINDELSE. Stikket skal være forbundet med en korrekt installeret jordforbunden stikkontakt. En ukorrekt installeret stikkontakt kan sætte livsfarlig spænding til tilgængelige metaldele.



12  UDSTYR TIL STIKKONTAKT, stikkontakten bør installeres nær ved udstyret og skal være lettilgængelig.

13  **ADVARSEL:** Ventilationsåbninger må ikke blokeres og skal have fri adgang til den omgivende luft i rummet for afkøling.











14  **BETJENINGSTEMPERATUR:** Dette apparat er konstrueret til en omgivende temperatur på maksimum 40 grader C.

15  **ALLE LANDE:** Installation af produktet skal ske i overensstemmelse med lokal og national lovgivning for elektriske installationer.



Eisen: Dit product voldoet aan de volgende eisen.

- | | | |
|---|---|---|
| 1 | RFI Emissie | FCC Klasse A, EN55022 Klasse A, CISPR22 Class A (VCCI), AS/NZS3548 (C-TICK), EN61000-3-2, EN61000-3-3 |
| 2 |  WAARSCHUWING: Binnenshuis kan dit product radiostoring veroorzaken, in welk geval de gebruiker verplicht kan worden om gepaste maatregelen te nemen. | |
| 3 | Immuniteit | EN55024 |
| 4 | Electrische Veiligheid | UL 1950 (UL/cUL), EN60950 |
| 5 |  Laser | EN60825 |











VEILIGHEID

- | | | |
|----|---|--|
| 6 |  WAARSHUWING Klasse-1 laser produkt. | |
| 7 |  WAARCHUWING Neit in de straal staren. | |
| 8 |  WAARSCHUWINGEN MET BETREKKING TOT ELEKTRICITEIT WAARSCHUWING: GEVAAR VOOR ELEKTRISCHE SCHOKKEN Verwijder het deksel niet, teneinde ELEKTRISCHE schokken te voorkomen. Binnenin bevinden zich geen onderdelen die door de gebruiker onderhouden kunnen worden. Dit toestel staat onder GEVAARLIJKE SPANNING en mag alleen worden geopend door een daartoe opgeleide en bevoegde technicus. Om het gevaar op ELEKTRISCHE SCHOKKEN te vermijden, moet u het toestel van de stroombron ontkoppelen alvorens de LAN-kabels te koppelen of ontkoppelen. | |
| 9 |  GEVAAR VOOR BLIKSEMINSLAG GEVAAR: NIET aan toestellen of KABELS WERKEN bij BLIKSEM. | |
| 10 |  WAARSCHUWING: HET TOESTEL WORDT UITGESCHAKELD DOOR DE STROOMKABEL TE ONTKOPPELEN. OM HET TOESTEL STROOMLOOS TE MAKEN: de stroomkabel ontkoppelen. | |
| 11 |  ELEKTRISCHE TOESTELLEN VAN KLASSE 1 DIT TOESTEL MOET GEAARD WORDEN. De stekker moet aangesloten zijn op een juist geaarde contactdoos. Een onjuist geaarde contactdoos kan de metalen onderdelen waarmee de gebruiker eventueel in aanraking komt onder gevaarlijke spanning stellen. | |
| 12 |  AAN TE SLUITEN APPARATUUR, de contactdoos wordt in de nabijheid van de apparatuur geïnstalleerd en is gemakkelijk te bereiken." | |
| 13 |  OPGELET: De ventilatiegaten mogen niet worden gesperd en moeten de omgevingslucht ongehinderd toelaten voor afkoeling. | |
| 14 |  BEDRIJFSTEMPERATUUR: De omgevingstemperatuur voor dit produkt mag niet meer bedragen dan 40 graden Celsius. | |
| 15 |  ALLE LANDEN: het toestel installeren overeenkomstig de lokale en nationale elektrische voorschriften. | |

Normes: ce produit est conforme aux normes de suivantes:

- 1 Emission d'interférences radioélectriques FCC Classe A, EN55022 Classe A, CISPR22 Class A (VCCI), AS/NZS3548 (C-TICK), EN61000-3-2, EN61000-3-3
- 2  **MISE EN GARDE** : dans un environnement domestique, ce produit peut provoquer des interférences radioélectriques. Auquel cas, l'utilisateur devra prendre les mesures adéquates.
- 3 Immunité EN55024
- 4 Sécurité électrique UL 1950 (UL/cUL), EN60950
- 5  Laser EN60825

SÉCURITÉ

- 6  **ATTENTION** Produit laser di classe 1.
- 7  **ATTENTION** Ne pas fixer le faisceau des yeux.
- 8  **INFORMATION SUR LES RISQUES ÉLECTRIQUES**
AVERTISSEMENT: DANGER D'ÉLECTROCUTION
Pour éviter toute ÉLECTROCUTION, ne pas ôter le revêtement protecteur du matériel. Ce matériel ne contient aucun élément réparable par l'utilisateur. Il comprend des TENSIONS DANGEREUSES et ne doit être ouvert que par un technicien dûment qualifié. Pour éviter tout risque d'ÉLECTROCUTION, débrancher le matériel avant de connecter ou de déconnecter les câbles LAN.
- 9  **DANGER DE Foudre**
DANGER: NE PAS MANIER le matériel ou les CÂBLES lors d'activité orageuse.
- 10  **ATTENTION: LE CORDON D'ALIMENTATION SERT DE MISE HORS CIRCUIT. POUR COUPER L'ALIMENTATION DU MATÉRIEL, débrancher le cordon.**
- 11  **ÉQUIPEMENT DE CLASSE 1 ÉLECTRIQUE**
CE MATÉRIEL DOIT ÊTRE MIS A LA TERRE. La prise de courant doit être branchée dans une prise femelle correctement mise à la terre car des tensions dangereuses risqueraient d'atteindre les pièces métalliques accessibles à l'utilisateur.
- 12  **EQUIPEMENT POUR BRANCHEMENT ELECTRIQUE, la prise de sortie doit être placée près de l'équipement et facilement accessible".**
- 13  **ATTENTION: Ne pas bloquer les fentes d'aération, ceci empêcherait l'air ambiant de circuler librement pour le refroidissement.**
- 14  **TEMPÉRATURE DE FONCTIONNEMENT:** Ce matériel est capable de tolérer une température ambiante maximum de ou 40 degrés Celsius.
- 15  **POUR TOUS PAYS:** Installer le matériel conformément aux normes électriques nationales et locales.

Standardit: Tämä tuote on seuraavien standardien mukainen.

1 Radioaaltojen häirintä FCC Luokka A, EN55022 Luokka A, CISPR22 Class A (VCCI), AS/NZS3548 (C-TICK), EN61000-3-2, EN61000-3-3

2  **VAROITUS:** Kotiolosuhteissa tämä laite voi aiheuttaa radioaaltojen häirintää, missä tapauksessa laitteen käyttäjän on mahdollisesti ryhdyttävä tarpeellisiin toimenpiteisiin.

3 Kestävyys EN55024

4 Sähköturvallisuus UL 1950 (UL/cUL), EN60950

5  Laser EN60825

TURVALLISUUS

6  **VAROITUS** Luokan 1 Lasertuote.

7  **VAROITUS** Älä katso säteeseen.

8  **SÄHKÖÖN LIITTYVIÄ HUOMAUTUKSIA**
VAROITUS: SÄHKÖISKUVAARA
 Estääksesi SÄHKÖISKUN älä poista kantta. Sisällä ei ole käyttäjän huollettavissa olevia osia. Tämä laite sisältää VAARALLISIA JÄNNITTEITÄ ja sen voi avata vain koulutettu ja pätevä teknikko. Vältä äläkä SÄHKÖISKUN mahdollisuuden katkaista sähkövirta tuotteeseen ennen kuin liität tai irrotat paikallisverkon (LAN) kaapelit.

9  **SALAMANISKUVAARA**
HENGENVAAARA: ÄLÄ TYÖSKENTELE laitteiden tai KAAPELEIDEN KANSSA SALAMOINNIN AIKANA.

10  **HUOMAUTUS: VIRTATOHTO KÄYTETTÄÄN** VIRRANKATKAISULAITTEENA. VIRTA KATKAISTAAN irrottamalla virtajohto.

11  **SÄHKÖ - TYYPPILUOKAN 1 LAITTEET**
TÄMÄ LAITE TÄYTY MAADOITTAA. Pistoke täytyy liittää kunnollisesti maadoitettuun pistorasiaan. Virheellisesti johdotettu pistorasia voi altistaa metalliosat vaarallisille jännitteille.



12  **PISTORASIAAN KYTKETTÄVÄ LAITE;** pistorasia on asennettava laitteen lähelle ja siihen on oltava esteetön pääsy."

13  **HUOMAUTUS:** Ilmavaihtoreikiä ei pidä tukkia ja niillä täytyy olla vapaa yhteys ympäröivään huoneilmaan, jotta ilmanvaihto tapahtuisi.











14  **KÄYTTÖLÄMPÖTILA:** Tämä tuote on suunniteltu ympäröivän ilman maksimilämpötilalle 40°C.

15  **KAIKKI MAAT:** Asenna tuote paikallisten ja kansallisten sähköturvallisuusmääräysten mukaisesti.



Standard: Questo prodotto è conforme ai seguenti standard.

- 1 Emissione RFI (interferenza di radiofrequenza) FCC Classe A, EN55022 Classe A, CISPR22 Class A (VCCI), AS/NZS3548 (C-TICK), EN61000-3-2, EN61000-3-3
- 2  **AVVERTENZA:** in ambiente domestico questo prodotto potrebbe causare radio interferenza. In questo caso potrebbe richiedersi all'utente di prendere gli adeguati provvedimenti.
- 3 Immunità EN55024
- 4 Sicurezza elettrica UL 1950 (UL/cUL), EN60950
- 5  Laser EN60825

NORME DI SICUREZZA

- 6  **AVVERTENZA** Prodotto laser di Classe 1.
- 7  **AVVERTENZA** Non fissare il raggio con gli occhi.
- 8  **AVVERTENZE ELETTRICHE**
ATTENZIONE: PERICOLO DI SCOSSE ELETTRICHE
 Per evitare SCOSSE ELETTRICHE non asportare il coperchio. Le componenti interne non sono riparabili dall'utente. Questa unità ha TENSIONI PERICOLOSE e va aperta solamente da un tecnico specializzato e qualificato. Per evitare ogni possibilità di SCOSSE ELETTRICHE, interrompere l'alimentazione del dispositivo prima di collegare o staccare i cavi LAN.
- 9  **PERICOLO DI FULMINI**
PERICOLO: NON LAVORARE sul dispositivo o sui CAVI durante PRECIPITAZIONI TEMPORALESCHIE.
- 10  **ATTENZIONE: IL CAVO DI ALIMENTAZIONE È USATO COME DISPOSITIVO DI DISATTIVAZIONE. PER TOGLIERE LA CORRENTE AL DISPOSITIVO** staccare il cavo di alimentazione.
- 11  **ELETTRICITÀ - DISPOSITIVI DI CLASSE 1**
 QUESTO DISPOSITIVO DEVE AVERE LA MESSA A TERRA. La spina deve essere inserita in una presa di corrente specificamente dotata di messa a terra. Una presa non cablata in maniera corretta rischia di scaricare una tensione pericolosa su parti metalliche accessibili.
- 12  **APPARECCHIATURA COLLEGABILE**, la presa va installata vicino all'apparecchio per risultare facilmente accessibile".
- 13  **ATTENZIONE:** le prese d'aria non vanno ostruite e devono consentire il libero ricircolo dell'aria ambiente per il raffreddamento.
- 14  **TEMPERATURA DI FUNZIONAMENTO:** Questo prodotto è concepito per una temperatura ambientale massima di 40 gradi centigradi.
- 15  **TUTTI I PAESI:** installare il prodotto in conformità delle vigenti normative elettriche nazionali.



Sikkerhetsnormer: Dette produktet tilfredsstiller følgende sikkerhetsnormer.

- | | | |
|---|---|---|
| 1 | RFI stråling | FCC Klasse A, EN55022 Klasse A, CISPR22 Class A (VCCI), AS/NZS3548 (C-TICK), EN61000-3-2, EN61000-3-3 |
| 2 |  ADVARSEL: Hvis dette produktet benyttes til privat bruk, kan produktet forårsake radioforstyrrelse. Hvis dette skjer, må brukeren ta de nødvendige forholdsregler. | |
| 3 | Immunitet | EN55024 |
| 4 | Elektrisk sikkerhet | UL 1950 (UL/cUL), EN60950 |
| 5 |  Laser | EN60825 |











SIKKERHET

- | | | |
|----|--|--|
| 6 |  ADVARSEL Laserprodukt av klasse 1. | |
| 7 |  ADVARSEL Stirr ikke på strålen. | |
| 8 |  ELEKTRISITET ADVARSEL: FARE FOR ELEKTRISK SJOKK For å unngå ELEKTRISK sjokk, må dekslet ikke tas av. Det finnes ingen deler som brukeren kan reparere på innsiden. Denne enheten inneholder FARLIGE SPENNINGER, og må kun åpnes av en faglig kvalifisert tekniker. For å unngå ELEKTRISK SJOKK må den elektriske strømmen til produktet være avslått før LAN-kablene til- eller frakobles. | |
| 9 |  FARE FOR LYNNEDSLAG FARE: ARBEID IKKE på utstyr eller KABLER i TORDENVÆR. | |
| 10 |  FORSIKTIG: STRØMLEDNINGEN BRUKES TIL Å FRAKOBLE UTSTYRET. FOR Å DEAKTIVISERE UTSTYRET, må strømforsyningen kobles fra. | |
| 11 |  ELEKTRISK - TYPE 1- KLASSE UTSTYR DETTE UTSTYRET MÅ JORDES. Strømkontakten må være tilkopleet en korrekt jordet kontakt. En kontakt som ikke er korrekt jordet kan føre til farlig spenninger i lett tilgjengelige metalleder. | |
| 12 |  UTSTYR FOR STIKKONTAKT. Stikkontakten skal monteres i nærheten av utstyret og skal være lett tilgjengelig." | |
| 13 |  FORSIKTIG: Lufteventilene må ikke blokkeres, og må ha fri tilgang til luft med romtemperatur for avkjøling. | |
| 14 |  DRIFTSTEMPERATUR: Dette produktet er konstruert for bruk i maksimum romtemperatur på 40 grader celsius. | |
| 15 |  ALLE LAND: Produktet må installeres i samsvar med de lokale og nasjonale elektriske koder. | |



Padrões: Este produto atende aos seguintes padrões.

- | | | |
|-----|--|---|
| 🌀 1 | Emissão de interferência de radiofrequência | FCC Classe A, EN55022 Classe A, CISPR22 Class A (VCCI), AS/NZS3548 (C-TICK), EN61000-3-2, EN61000-3-3 |
| 🌀 2 |  AVISO: Num ambiente doméstico este produto pode causar interferência na radiorrecepção e, neste caso, pode ser necessário que o utente tome as medidas adequadas. | |
| 🌀 3 | Imunidade | EN55024 |
| 🌀 4 | Segurança Eléctrica | UL 1950 (UL/cUL), EN60950 |
| 🌀 5 |  Laser | EN60825 |









SEGURANÇA

- | | | |
|------|---|--|
| 🌀 6 |  AVISO Produto laser de classe 1 | |
| 🌀 7 |  AVISO Não olhe fixamente para o raio. | |
| 🌀 8 |  AVISOS SOBRE CARACTERÍSTICAS ELÉTRICAS ATENÇÃO: PERIGO DE CHOQUE ELÉTRICO Para evitar CHOQUE ELÉTRICO, não retire a tampa. Não contém peças que possam ser consertadas pelo usuário. Este aparelho contém VOLTAGENS PERIGOSAS e só deve ser aberto por um técnico qualificado e treinado. Para evitar a possibilidade de CHOQUE ELÉTRICO, desconecte o aparelho da fonte de energia elétrica antes de conectar e desconectar os cabos da LAN. | |
| 🌀 9 |  PERIGO DE CHOQUE CAUSADO POR RAIOS PERIGO: NÃO TRABALHE no equipamento ou nos CABOS durante períodos suscetíveis a QUEDAS DE RAIOS. | |
| 🌀 10 |  CUIDADO: O CABO DE ALIMENTAÇÃO É UTILIZADO COMO UM DISPOSITIVO DE DESCONEXÃO. PARA DESELETRIFICAR O EQUIPAMENTO, desconecte o cabo de ALIMENTAÇÃO. | |
| 🌀 11 |  ELÉTRICO - EQUIPAMENTOS DO TIPO CLASSE 1 DEVE SER FEITA LIGAÇÃO DE FIO TERRA PARA ESTE EQUIPAMENTO. O plugue de alimentação deve ser conectado a uma tomada com adequada ligação de fio terra. Tomadas sem adequada ligação de fio terra podem transmitir voltagens perigosas a peças metálicas expostas. | |
| 🌀 12 |  EQUIPAMENTO DE LIGAÇÃO, a tomada eléctrica deve estar instalada perto do equipamento e ser de fácil acesso." | |
| 🌀 13 |  CUIDADO: As aberturas de ventilação não devem ser bloqueadas e devem ter acesso livre ao ar ambiente para arrefecimento adequado do aparelho. | |
| 🌀 14 |  TEMPERATURA DE FUNCIONAMENTO: Este produto foi projetado para uma temperatura ambiente máxima de 40 graus centígrados. | |
| 🌀 15 |  TODOS OS PAÍSES: Instale o produto de acordo com as normas nacionais e locais para instalações elétricas. | |



Estándares: Este producto cumple con los siguientes estándares.

- | | | |
|---|---|---|
| 1 | Emisión RFI | FCC Clase A, EN55022 Clase A, CISPR22 Class A (VCCI), AS/NZS3548 (C-TICK), EN61000-3-2, EN61000-3-3 |
| 2 |  ADVERTENCIA: en un entorno doméstico, este producto puede causar radiointerferencias, en cuyo caso, puede requerirse del usuario que tome las medidas que sean convenientes al respecto. | |
| 3 | Inmunidad | EN55024 |
| 4 | Seguridad eléctrica | UL 1950 (UL/cUL), EN60950 |
| 5 |  Laser | EN60825 |











SEGURIDAD

- | | | |
|----|--|--|
| 6 |  ¡ADVERTENCIA! Producto láser Clase 1. | |
| 7 |  ¡ADVERTENCIA! No mirat fijamente el haz. | |
| 8 |  AVISOS ELECTRICOS ADVERTENCIA: PELIGRO DE ELECTROCHOQUE Para evitar un ELECTROCHOQUE, no quite la tapa. No hay ningún componente en el interior al cual puede prestar servicio el usuario. Esta unidad contiene VOLTAJES PELIGROSOS y sólo deberá abrirla un técnico entrenado y calificado. Para evitar la posibilidad de ELECTROCHOQUE desconecte la corriente eléctrica que llega al producto antes de conectar o desconectar los cables LAN. | |
| 9 |  PELIGRO DE RAYOS PELIGRO: NO REALICE NINGUN TIPO DE TRABAJO O CONEXION en los equipos o en LOS CABLES durante TORMENTAS ELECTRICAS. | |
| 10 |  ATENCION: EL CABLE DE ALIMENTACION SE USA COMO UN DISPOSITIVO DE DESCONEXION. PARA DESACTIVAR EL EQUIPO, desconecte el cable de alimentación. | |
| 11 |  ELECTRICO - EQUIPO DEL TIPO CLASE 1 ESTE EQUIPO TIENE QUE TENER CONEXION A TIERRA. El cable tiene que conectarse a un enchufe a tierra debidamente instalado. Un enchufe que no está correctamente instalado podría ocasionar tensiones peligrosas en las partes metálicas que están expuestas. | |
| 12 |  EQUIPO CONECTABLE, el tomacorriente se debe instalar cerca del equipo, en un lugar con acceso fácil". | |
| 13 |  ATENCION: Las aberturas para ventilación no deberán bloquearse y deberán tener acceso libre al aire ambiental de la sala para su enfriamiento. | |
| 14 |  TEMPERATURA REQUERIDA PARA LA OPERACIÓN: Este producto está diseñado para una temperatura ambiental máxima de 40 grados C. | |
| 15 |  PARA TODOS LOS PAÍSES: Monte el producto de acuerdo con los Códigos Eléctricos locales y nacionales. | |

Standarder: Denna produkt uppfyller följande standarder.

- 1 Radiostörning FCC Klass A, EN55022 Klass A, CISPR22 Class A (VCCI), AS/NZS3548 (C-TICK), EN61000-3-2, EN61000-3-3
- 2  **WARNING:** Denna produkt kan ge upphov till radiostörningar i hemmet, vilket kan tvinga användaren till att vidtaga erforderliga åtgärder.
- 3 Immunitet EN55024
- 4 Elsäkerhet UL 1950 (UL/cUL), EN60950
- 5  Laser EN60825

SÄKERHET

- 6  **WARNING!** Laserprodukt av klass 1.
- 7  **WARNING!** Laserstrålning när enheten är öppen.
- 8  **TILLKÄNNAGIVANDEN BETRÄFFANDE ELEKTRICITETSRIK:**
RISK FÖR ELEKTRISK STÖT För att undvika ELEKTRISK stöt, ta ej av locket. Det finns inga delar inuti som behöver underhållas. Denna apparat är under HÖGSPÄNNING och får endast öppnas av en utbildad kvalificerad tekniker. För att undvika ELEKTRISK STÖT, koppla ifrån produktens strömanslutning innan LAN-kablarna ansluts eller kopplas ur.
- 9  **FARA FÖR BLIXTNEDSLAG**
FARA: ARBETA EJ på utrustningen eller kablarna vid ÅSKVÄDER.
- 10  **WARNING:** NÄTKABELN ANVÄNDS SOM STRÖMBRYTARE FÖR ATT KOPPLA FRÅN STRÖMMEN, dra ur nätkabeln.
- 11  ELEKTRISKT - TYP KLASS 1 UTRUSTNING
DENNA UTRUSTNING MÅSTE VARA JORDAD. Nätkabeln måste vara ansluten till ett ordentligt jordat uttag. Ett felaktigt uttag kan göra att närliggande metalldelar utsätts för högspänning. Apparaten skall anslutas till jordat uttag, när den ansluts till ett nätverk.
- 12  UTRUSTNING MED PLUGG. Uttaget skall installeras i utrustningens närhet och vara lättåtkomligt".
- 13  **WARNING:** Luftventilerna får ej blockeras och måste ha fri tillgång till omgivande rumsluft för avsvälvning.
- 14  **DRIFTSTEMPERATUR:** Denna produkt är konstruerad för rumstemperatur ej överstigande 40 grader Celsius.
- 15  **ALLA LÄNDER:** Installera produkten i enlighet med lokala och statliga bestämmelser för elektrisk utrustning.