



Simply connecting the  world

AT-FS238a / 1
AT-FS238b / 1
AT-FS238a / 2
AT-FS238b / 2

Bridging Converters

Installation Guide

Copyright © 2003 Allied Telesyn, Inc.
960 Stewart Drive, Suite B, Sunnyvale, CA 94085, USA

All rights reserved. No part of this publication may be reproduced without prior written permission from Allied Telesyn, Inc.

Ethernet is a registered trademark of Xerox Corporation. All other product names, company names, logos or other designations mentioned herein are trademarks or registered trademarks of their respective owners.

Allied Telesyn, Inc. reserves the right to make changes in specifications and other information contained in this document without prior written notice. The information provided herein is subject to change without notice. In no event shall Allied Telesyn, Inc. be liable for any incidental, special, indirect, or consequential damages whatsoever, including but not limited to lost profits, arising out of or related to this manual or the information contained herein, even if Allied Telesyn, Inc. has been advised of, known, or should have known, the possibility of such damages.

Electrical Safety and Emission Compliance Statement

Standards: This product meets the following standards.

U.S. Federal Communications Commission

Declaration Of Conformity

Manufacturer Name:	Allied Telesyn, Inc.
Manufacturer Address:	960 Stewart Drive, Suite B Sunnyvale, CA 94085, USA
Manufacturer Telephone:	408-730-0950
Declares that the product:	Bridging Converter
Model Numbers:	AT-FS238a/1, AT-FS238b/1, AT-FS238a/2, AT-FS238b/2

This product complies with FCC Part 15B, Class B Limits:

This device complies with part 15 of the FCC Rules. Operation is subject to the following two conditions: (1) This device must not cause harmful interference, and (2) this device must accept any interference received, including interference that may cause undesired operation.

Radiated Energy

Note: This equipment has been tested and found to comply with the limits for a Class B digital device pursuant to Part 15 of FCC Rules. These limits are designed to provide reasonable protection against harmful interference in a residential installation. This equipment generates, uses and can radiate radio frequency energy and, if not installed and used in accordance with instructions, may cause harmful interference to radio or television reception, which can be determined by turning the equipment off and on. The user is encouraged to try to correct the interference by one or more of the following measures:

- Reorient or relocate the receiving antenna.
- Increase the separation between the equipment and the receiver.
- Connect the equipment into an outlet on a circuit different from that to which the receiver is connected.
- Consult the dealer or an experienced radio/TV technician for help.

Changes and modifications not expressly approved by the manufacturer or registrant of this equipment can void your authority to operate this equipment under Federal Communications Commission rules.

Industry Canada

This Class B digital apparatus meets all requirements of the Canadian Interference-Causing Equipment Regulations.

Cet appareil numérique de la classe B respecte toutes les exigences du Règlement sur le matériel brouilleur du Canada.

RFI Emission

FCC Class B, EN55022 Class B,
VCCI Class B, C-TICK  1



Warning: In a domestic environment this product may cause radio interference in which case the user may be required to take adequate measures.  2

Immunity

EN55024  3

Warning: This product requires shielded cables to comply with emission and immunity standards. If it is used with unshielded cables, the user may be required to take measures to correct the interference problem at their own expense.  4

Electrical Safety

EN60950 (TUV), UL60950 (cUL_{us})  5



Laser

EN60825  6

Warning Class 1 Laser product.  7

Warning Do not stare into the Laser beam.  8

At time of installation, the Fiber Optic Lasers comply with FDA Radiation Performance Standard 21CFR Subchapter J, applicable at date of manufacture.

This is a “Class 1 LED Product”.  9

Important: Appendix B contains translated safety statements for installing this equipment. When you see the , go to Appendix B for the translated safety statement in your language.

Wichtig: Anhang B enthält übersetzte Sicherheitshinweise für die Installation dieses Geräts. Wenn Sie  sehen, schlagen Sie in Anhang B den übersetzten Sicherheitshinweis in Ihrer Sprache nach.

Viktigt: Tillæg B indeholder oversatte sikkerhedsadvarsler, der vedrører installation af dette udstyr. Når De ser symbolet , skal De slå op i tillæg B og finde de oversatte sikkerhedsadvarsler i Deres eget sprog.

Belangrijk: Appendix B bevat vertaalde veiligheidsopmerkingen voor het installeren van deze apparatuur. Wanneer u de  ziet, raadpleeg Appendix B voor vertaalde veiligheidsinstructies in uw taal.

Important: L'annexe B contient les instructions de sécurité relatives à l'installation de cet équipement. Lorsque vous voyez le symbole , reportez-vous à l'annexe B pour consulter la traduction de ces instructions dans votre langue.

Tärkeää: Liite B sisältää tämän laitteen asentamiseen liittyvät käännetyt turvaohjeet. Kun näet -symbolin, katso käännettyä turvaohjetta liitteestä B.

Importante: l'Appendice B contiene avvisi di sicurezza tradotti per l'installazione di questa apparecchiatura. Il simbolo , indica di consultare l'Appendice B per l'avviso di sicurezza nella propria lingua.

Viktig: Tillegg B inneholder oversatt sikkerhetsinformasjon for installering av dette utstyret. Når du ser , åpner du til Tillegg B for å finne den oversatte sikkerhetsinformasjonen på ønsket språk.

Importante: O Anexo B contém advertências de segurança traduzidas para instalar este equipamento. Quando vir o símbolo , leia a advertência de segurança traduzida no seu idioma no Anexo B.

Importante: El Apéndice B contiene mensajes de seguridad traducidos para la instalación de este equipo. Cuando vea el símbolo , vaya al Apéndice B para ver el mensaje de seguridad traducido a su idioma.

Obs! Bilaga B innehåller översatta säkerhetsmeddelanden avseende installationen av denna utrustning. När du ser , skall du gå till Bilaga B för att läsa det översatta säkerhetsmeddelandet på ditt språk.

Table of Contents

Electrical Safety and Emission Compliance Statement	iii
Welcome to Allied Telesyn	ix
Where to Find Web-based Guides	ix
Document Conventions	ix
Contacting Allied Telesyn	x
Online Support	x
E-mail and Telephone Support	x
Returning Products	x
For Sales or Corporate Information	x
Chapter 1	
Overview	1
Introduction	2
Location of Components	6
External Power Supply	9
12VDC Power Supply	9
12-50VDC Power Supply	9
Key Features	10
Status LEDs	11
Twisted Pair Port	12
Port Speed	12
Duplex Mode	12
Auto MDI/MDI-X	13
Fiber Optic Port	14
Port Speed	14
Duplex Mode	14
Mode Selection Button	15
Link Test	15
MissingLink	15
Smart MissingLink	16
Bridging Converter Performance	17
DIP Switches	17
MAC Address Table	17
Store and Forward	18

Chapter 2

Installing the Bridging Converter 19
Verifying Package Contents 19
Planning the Installation 20
 Selecting a Site 21
 Reviewing Safety Guidelines 22
Installing the Bridging Converter 23
Connecting a 12VDC Powered Unit 27
Wiring and Connecting a 12-50VDC Powered Unit 28
Warranty Registration 32

Chapter 3

Troubleshooting 33

Appendix A

Technical Specifications 37
Physical 37
Environmental 37
Electrical Rating 37
Agency Certifications 38
Fiber Optic Port Specifications 39
RJ-45 Pinout Assignments 41

Appendix B

Translated Safety and Emission Information 43

Welcome to Allied Telesyn

This guide contains instructions on how to install the AT-FS238a/x and AT-FS238b/x Series Bridging Converters.

Where to Find Web-based Guides

The Allied Telesyn web site at **www.alliedtelesyn.com** offers you an easy way to access the most recent documentation, software, and technical information for all of our products. For product guides, select “Support & Services” from our web site.

Document Conventions

This guide uses the following conventions:

Note

Notes provides additional information.



Caution

Cautions indicate that performing or omitting a specific action may result in equipment damage or loss of data.



Warning

Warnings indicates that performing or omitting a specific action may result in bodily injury.

Contacting Allied Telesyn

This section provides Allied Telesyn contact information for technical support as well as sales or corporate information.

Online Support

You can request technical support online by accessing the Allied Telesyn Knowledge Base from the following web site: **<http://kb.alliedtelesyn.com>**. You can use the Knowledge Base to submit questions to our technical support staff and review answers to previously asked questions.

E-mail and Telephone Support

For Technical Support via e-mail or telephone, refer to the Support & Services section of the Allied Telesyn web site: **<http://www.alliedtelesyn.com>**.

Returning Products

Products for return or repair must first be assigned a Return Materials Authorization (RMA) number. A product sent to Allied Telesyn without a RMA number will be returned to the sender at the sender's expense.

To obtain a RMA number, contact Allied Telesyn's Technical Support at our web site: **<http://www.alliedtelesyn.com>**.

For Sales or Corporate Information

You can contact Allied Telesyn for sales or corporate information at our web site: **<http://www.alliedtelesyn.com>**. To find the contact information for your country, select "Contact Us" then "Worldwide Contacts."

Chapter 1

Overview

The AT-FS238a/x and AT-FS238b/x Series Bridging Converters include the following models:

- AT-FS238a/1
- AT-FS238a/2
- AT-FS238b/1
- AT-FS238b/2

The AT-FS238a/x and AT-FS238b/x Series Bridging Converters are designed to convert Fast Ethernet data between twisted pair cabling and fiber optic cabling. These converters serve the following functions:

- Dividing your network into smaller units.
- Maximizing your existing fiber network by providing full-duplex operation over a single fiber strand.
- Interconnecting network devices that are physical far apart.

The converter's fiber optic port is IEEE 802.3ah-compliant and operates at 100 Mbps, while the twisted pair port operates at 10 Mbps or 100 Mbps. The fiber optic port has a simplex SC connector and an operating distance of 15 kilometers (9.4 miles) or 40 kilometers (24.8 miles), depending on the model. The twisted pair port has an RJ-45 connector with a maximum operating distance of 100 meters (328 feet). Both ports feature half- or full-duplex mode operation.

AT-FS238a/x and AT-FS238b/x Series Bridging Converters can be installed on a desktop or in an AT-MCR12 chassis. These bridging converters are easy to install and do not require software configuration or management.

Introduction

The fiber optic port on the bridging converter offers an important advantage over fiber optic ports commonly found on Fast Ethernet equipment. It can simultaneously transmit and receive Ethernet data for full-duplex operation over a single fiber strand. In comparison, a conventional fiber optic port requires two fiber strands for full-duplex operation.

In a conventional fiber optic installation, each fiber optic strand carries only one data stream at a time and in only one direction, as illustrated in Figure 1.

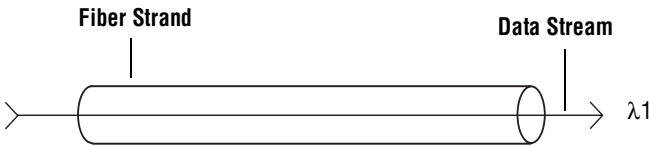

Figure 1 Data Stream on a Single Fiber Strand

The data stream is transmitted at a specific wavelength, typically 850 nanometers (nm), 1310 nm, or 1550 nm. These wavelengths are known for their low attenuation.

Full-duplex operation in a conventional fiber installation involves two separate fiber strands, one for transmitting data and another for receiving data, as illustrated in Figure 2. Both data streams are transmitted at the same wavelength, but since each is on a separate strand, the signals remain separate.

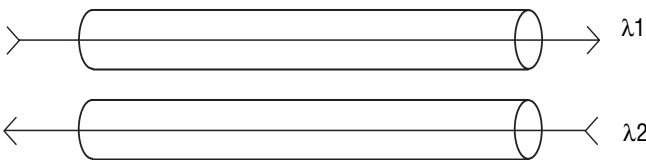

Figure 2 Full-duplex Operation on a Conventional Fiber Optic Installation

The fiber optic port on the bridging converters combines two data streams onto one fiber optic strand. This allows you to use more of the bandwidth inherent in fiber cable and so significantly increase the efficiency of your existing fiber optic backbone network.

The port uses a different wavelength for each data stream. Since each data stream is transmitted at a different wavelength (1310 nm and 1550 nm), the signals remain separate. This maintains data separation and security. Additionally, a converter can receive and transmit data on the same fiber strand. This allows for full-duplex operation with just one strand, as illustrated in Figure 3.

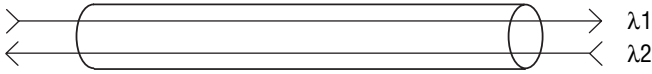

Figure 3 Two Data Streams on a Fiber Strand

The fiber optic port makes these bridging converters extremely useful in situations where a conventional fiber optic backbone network no longer has sufficient bandwidth to handle the data traffic. This problem has become a common occurrence on many networks due to the rapid growth of data traffic from sources such as voice over IP, multimedia applications, video conferencing, and the Internet.

The traditional solution to increasing bandwidth on a fiber optic backbone has been to install additional fiber optic cable. But this can be an extremely costly and time-consuming process. Additionally, conventional fiber optic installations are unable to use the extremely large bandwidth capacity that is inherent in fiber optic cable.

This is illustrated in Figure 4 where one AT-FS238a/1 converter and one AT-FS238b/1 converter are used to interconnect two subnetworks located at different campuses 15 km (9.3 mi) apart. This type of topology is commonly referred to as Back-to-Back. The AT-FS238a/1 converter at Campus 1 sends data at 1310 nm and receives at 1550 nm while the AT-FS238b/1 converter at Campus 2 receives data at 1310 nm and sends at 1550 nm.

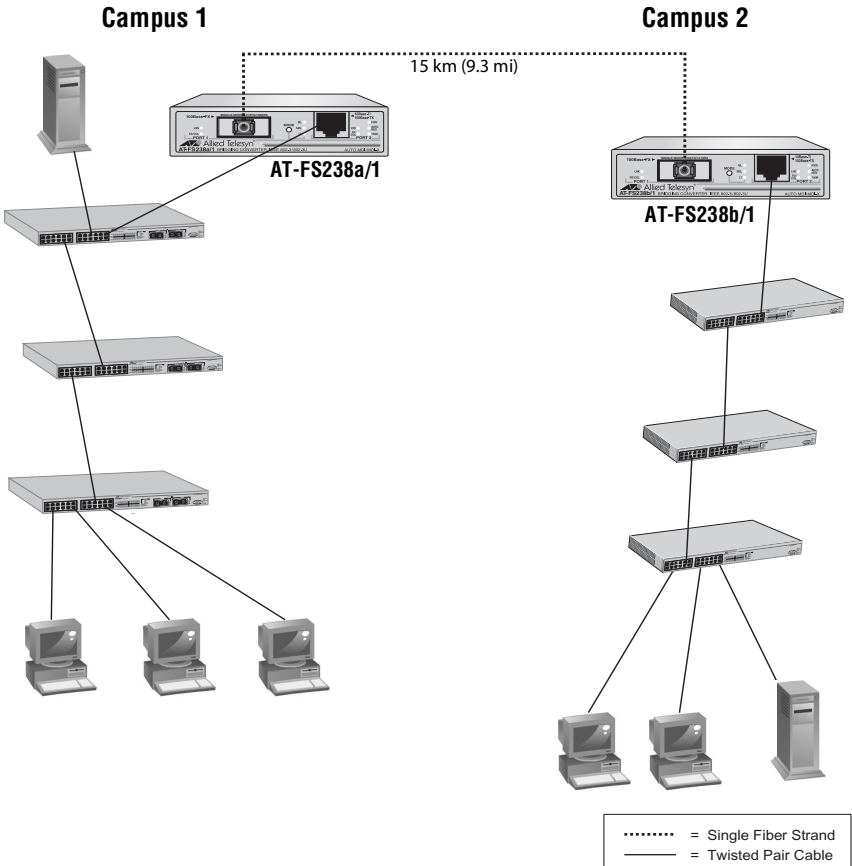

Figure 4 Back-to-Back Network Topology

Since the fiber optic port on the bridging converters is IEEE 802.3ah-compliant, these devices can also be used by voice and data service providers to provide service to the home. This type of topology is referred to as Fiber-to-the-Home. In Figure 5, an IEEE 802.3ah-compliant device at the provider's central office sends data to an AT-FS238a/2 converter located at a home on a single fiber strand. The converter then transmits the data to a router gateway located inside the home via the twisted pair port. The router gateway, in turn, provides communications to a phone, a fax machine, and a computer for Internet access.

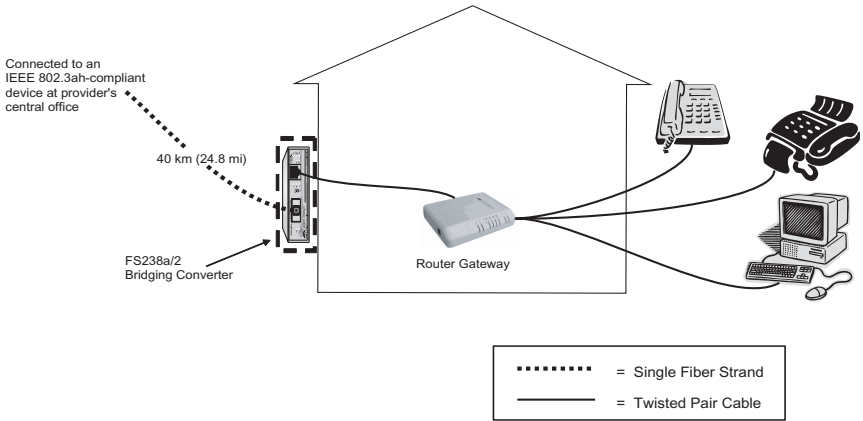

Figure 5 Fiber-to-the-Home Topology

Note

The fiber optic ports on the AT-FS238a/x and AT-FS238b/x Series converters are IEEE 802.3ah-compliant and must be connected to a device that meets the same compliant requirement.

Location of Components

Figure 6 illustrates the front panel of the AT-FS238a/x Series Bridging Converter.

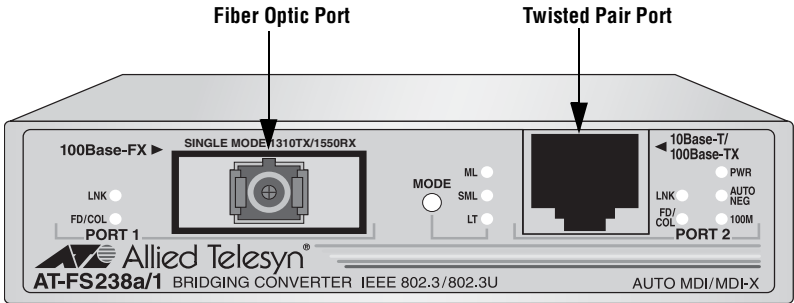

Figure 6 AT-FS238a/x Series Front Panel (AT-FS238a/1 Model)

Figure 7 illustrates the front panel of the AT-FS238b/x Series Bridging Converter.

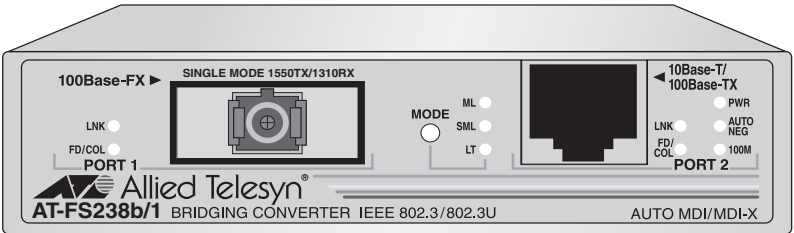

Figure 7 AT-FS238b/x Series Front Panel (AT-FS238b/1 Model)

The back panel of the AT-FS238a/x and AT-FS238b/x Series Bridging Converters features a DC power connector and DIP switches for manually configuring the ports.

Note

The AT-FS238a/x and AT-FS238b/x Bridging Converters are offered with two different DC power connectors: 12VDC and 12-50VDC.

Figure 8 illustrates the back panel of the AT-FS238a/x and AT-FS238b/x Series Bridging Converters with a 12VDC power connector.

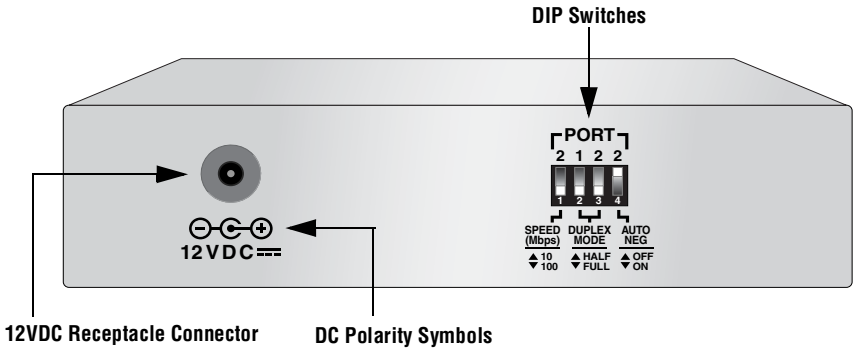

Figure 8 Back Panel of the AT-FS238a/x and AT-FS238b/x Series Bridging Converters (12VDC Power Connector)

Figure 9 illustrates the back panel of the AT-FS238a/x and AT-FS238b/x Series Bridging Converters with a 12-50VDC, 3-prong power connector.

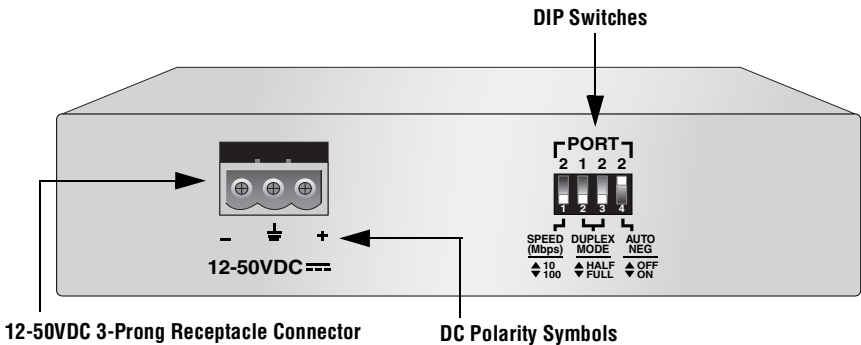

Figure 9 Back Panel of the AT-FS238a/x and AT-FS238b/x Series Bridging Converters (12-50VDC, 3-Prong Power Connector)

Table 1 lists the maximum operating distances for the bridging converters.

Table 1 Maximum Operating Distances

Model	100Base-FX		10Base-T/100Base-TX	
	Connector	Maximum Operating Distance ¹	Connector	Maximum Operating Distance ²
AT-FS238a/1 AT-FS238b/1	Simplex SC	15 km (9.3 mi)	RJ-45	100 m (328 ft)
AT-FS238a/2 AT-FS238b/2	Simplex SC	40 km (24.8 mi)	RJ-45	100 m (328 ft)

1. Maximum distance for 100 Mbps optical datalinks is dependent on the following factors: type of optical fiber, duplex mode of both end-nodes, and maximum optical loss budget for each of the optical fiber at the operating optical wavelength.
2. Maximum distance can only be obtained when the UTP/STP cabling is installed and verified to TIA/EIA 568A Commercial Building Telecommunications Cabling Standard.

External Power Supply

12VDC Power Supply

The 12VDC-version bridging converters come with the AC/DC power adapter illustrated in Figure 10. This is an approved safety compliant AC power adapter for the 100 and 240V AC versions with an unregulated output of 12VDC.



Figure 10 AC/DC Power Adapter for the 12VDC Version Bridging Converter

12-50VDC Power Supply

The 12-50VDC-version bridging converters do not come with a power supply. It must be purchased separately. Approved power supplies include:

- An AT-PWR237 power adapter (12V or 15V output). This power adapter can be ordered separately from your Allied Telesyn sales representative.
- A regulated power supply (SELV power source per IEC 60950) - rated minimum 12-50VDC, 0.5A.

Note

Use only power sources that are UL Listed (QQGQ or EPBU), TUV Licensed, or other Safety Agencies approved, and that are suitable for country of use.

Figure 11 illustrates the power connector included with the 12-50VDC-version bridging converter. This connector is used to wire and connect a 12-50VDC-version bridging converter.

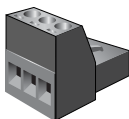

Figure 11 Power Connector for the 12-50VDC Version Bridging Converter

Key Features

The AT-FS238a/x and AT-FS238b/x Series Bridging Converters have the following features:

- LEDs for unit and port status
- Auto MDI/MDI-X
- Mode selection button that toggles between Link Test, MissingLink™, and Smart MissingLink
- DIP switches for configuring the ports
- Half- or full-duplex operation on both ports
- RJ-45 twisted pair connector
- Simplex SC fiber optic connector
- Data packet forwarding and filtering at full wire speed (10 Mbps to 100 Mbps, and 100 Mbps to 100 Mbps)
- Store and forward switching mode
- Automatic address learning and aging
- IEEE 802.3u compliant Auto-Negotiation
- For use on a desktop or in an AT-MCR12 chassis

Status LEDs

Table 2 defines the LEDs for the bridging converters.

Table 2 Status LEDs

LED	Color	Description
PWR	Green	Power is applied to the unit.
AUTO NEG	Green OFF	Auto-Negotiation on the twisted pair port is enabled. Auto-Negotiation on the twisted pair port is disabled.
100M	Green OFF	The twisted pair port is operating at 100 Mbps. The twisted pair port is operating at 10 Mbps.
LNK	Green Blinking	A valid link has been established on the port. Data is being received or transmitted on the port.
FD/COL	Green OFF Blinking	The bridging converter is operating in full-duplex mode. The bridging converter is operating in half-duplex mode. Collisions are detected on the port.
Mode Status		
ML	Green	MissingLink is enabled.
SML	Green	Smart MissingLink is enabled.
LT	Green	Link Test is enabled.

Twisted Pair Port

The AT-FS238a/x and AT-FS238b/x Series Bridging Converters have one 10Base-T/100Base-TX twisted pair port. The twisted pair port features a RJ-45 connector.

Port Speed

The twisted pair port is compliant with the 10Base-T and 100Base-TX standards and is capable of either 10 Mbps or 100 Mbps operation. You can set the port speed manually or, since the port is IEEE 802.3u Auto-Negotiation compliant, you can let the bridging converter set the port speed automatically. With Auto-Negotiation, the speed of the port is set automatically by the bridging converter after it determines the speed of the end-node connected to the port. Auto-Negotiation is designed to ensure that the port on the bridging converter and the end-node are operating at the same speed and that they are communicating at the highest possible common speed of the devices.

Duplex Mode

Duplex mode refers to how an end-node receives and transmits data. If an end-node can receive or transmit data, but not both simultaneously, the end-node is operating in what is referred to as half-duplex mode. If an end-node can both receive and transmit data simultaneously, the end-node is said to be operating in full-duplex mode. Naturally, an end-node capable of operating in full-duplex can handle data much faster than an end-node that can only operate in half-duplex mode.

The twisted pair port on the AT-FS238a/x and AT-FS238b/x Series Bridging Converters can operate in either half-or full-duplex mode. It is IEEE 802.3u-compliant and uses Auto-Negotiation to set the duplex mode setting for you automatically. If desired, Auto-Negotiation can be disabled and you can set the duplex mode manually.

Note

In order for a twisted pair port on the AT-FS238a/x and AT-FS238b/x Series Bridging Converters to successfully Auto-Negotiate its duplex mode with an end-node, the end-node should also be using Auto-Negotiation. Otherwise, a duplex mode mismatch can occur. The twisted pair port, using Auto-Negotiation, will default to half-duplex if it detects that the end-node is not using Auto-Negotiation. This will result in a mismatch if the end-node is operating at a fixed duplex mode of full-duplex.

Auto MDI/MDI-X

An RJ-45 twisted pair port on a 10 Mbps or 100 Mbps Ethernet network device can have one of two possible wiring configurations: MDI or MDI-X. The RJ-45 port on a PC, router, or bridge is typically wired as MDI, while the twisted pair port on a bridging converter or hub is usually MDI-X.

When the twisted pair port on the AT-FS238a/x and AT-FS238b/x Series converters is set to Auto-Negotiation, the port features automatic MDI/MDI-X. The RJ-45 port automatically determines the configuration of the port on the end-node and then configures itself appropriately. This feature allows you to use either a straight-through or crossover cable when connecting an end-node to the twisted pair port.

When the port on the AT-FS238a/x or AT-FS238b/x Series converter is not set to Auto-Negotiation, the port defaults to MDI-X. To connect to an end-node that has the same wiring configuration, such as MDI-X to MDI-X, you would use a crossover twisted pair cable. To connect to an end-node that has different port wiring configuration, such as MDI to MDI-X, you would use a straight-through cable.

Fiber Optic Port

The AT-FS238a/x and AT-FS238b/x Series Bridging Converters have one 100Base-FX fiber optic port. The fiber optic port features a simplex SC connector.

Note

The fiber optic port on the bridging converter must be connected to its companion on another bridging converter (i.e., AT-FS238a/1 to AT-FS238b/1 or AT-FS238a/2 to AT-FS238b/2), or to a fiber optic port that is IEEE 802.3ah-compliant and whose operating specifications are compatible with the fiber optic port on the converter.

Port Speed

The fiber optic port is compliant with the 100Base-FX standard and has a fixed operating speed of 100 Mbps. The port can send and receive on two wavelengths. The wavelengths are:

- AT-FS238a/x - TX=1310 and RX=1550
- AT-FS238b/x - TX=1550 and RX=1310

Duplex Mode

The fiber optic port on the bridging converter can operate in either half or full-duplex mode. You set the duplex mode manually using a DIP switch on the back panel of the unit. The default setting is full-duplex.

If you are connecting the fiber optic port to a companion bridging converter (AT-FS238a/1 to AT-FS238b/1 or AT-FS238a/2 to AT-FS238b/2), you should leave the duplex setting at the default setting of full-duplex for best performance. If you are connecting the fiber optic port on the bridging converter to an IEEE 802.3ah-compliant device, you must determine the duplex mode of the compliant device and set the duplex mode of the fiber optic port on the bridging converter accordingly.

Mode Selection Button

Link Test

The link test is a fast and easy way for you to test the connections between the bridging converter ports and the end-nodes that are connected to the ports. If a network problem occurs, you can perform a link test to determine which port is experiencing a problem, and so be able to focus your troubleshooting efforts on the cable and end-node where the problem resides.

To perform a link test, toggle the Mode Selection button until the LT LED is green. The LNK LEDs for the ports should now be green, indicating that they were able to establish a link with their end-nodes. If a LNK LED is off, the port could not establish a link. Refer to “Troubleshooting” on page 33 for suggestions on how to remedy the problem.

Note

Performing a link test does not interfere with a bridging converter’s ability to pass network traffic.

MissingLink

The MissingLink feature enables the ports on the bridging converter to pass the “Link” status of their connections to each other. When the bridging converter detects a problem on one of the ports, such as the loss of connection to an end-node, the bridging converter shuts down the connection to the other port, thus notifying the end-node that the connection has been lost.

For example, if the twisted pair cable to the 10Base-T/100Base-TX port on the bridging converter were to fail, the unit would respond by dropping the link on the 100Base-FX fiber optic port. In this way, the bridging converter notifies the end-node connected to the fiber optic port that the connection on the twisted pair port has been lost. If the failure had started with the fiber optic cabling, the unit would drop the link to the twisted pair port.

The value to this type of network monitoring and fault notification is that some devices can be configured to take a specific action in the event of the loss of connection on a port. In some cases, the unit can be configured to seek a redundant path to a disconnected end-node or send out a trap to a network management station, and so alert the network administrator of the problem.

Note

MissingLink and Smart MissingLink are disabled when you perform a link test. Consequently, to ensure that MissingLink or Smart MissingLink is enabled on the bridging converter during normal network operations, always set the Mode Selection button so that the ML or SML LED is green.

Smart MissingLink

The Smart MissingLink feature performs exactly the same function as MissingLink with one additional feature. When a link is lost on a port, the LNK LED of the port which still has a valid connection to its end-node starts to blink. This allows you to quickly determine which port still has a valid connection (LNK LED blinking) and which port has lost its connection (LNK LED off).

For example, if the network twisted pair cable to the 10Base-T/100Base-TX port on the bridging converter were to fail, the LNK LED on the 100Base-FX fiber optic port will blink, indicating a failed connection on the twisted pair port. If the failure had started with the fiber optic cabling, the LNK LED on the twisted pair port would blink.

The value to this type of network monitoring and fault notification is so that you can quickly see which port has failed and troubleshoot your network accordingly.

Bridging Converter Performance

The bridging converters perform at:

- ❑ 148,800 pps for 100 Mbps and 14,880 pps for 10 Mbps for full wire speed forwarding and filtering
- ❑ 200 Mbps maximum throughput in 100 Mbps, full-duplex mode
- ❑ 20 Mbps maximum throughput in 10 Mbps, full-duplex mode
- ❑ Storage for up to 2,000 MAC addresses
- ❑ 280 KB (per port) packet buffer
- ❑ Low latency 15.6 μ s (64-byte packet, 100 Mbps full-duplex)

DIP Switches

The DIP switches are used to manually configure the operating characteristics of the ports, such as port speed, duplex mode, and Auto-Negotiation.

For the fiber optic port, you can set the duplex mode to half- or full-duplex.

On the 10Base-T/100Base-TX twisted pair port, you can manually set the speed of the port to either 10 Mbps or 100 Mbps, set the duplex mode to either half- or full-duplex, and enable or disable Auto-Negotiation. Enabling Auto-Negotiation will automatically set the port's speed and duplex mode.

MAC Address Table

Up to 2,000 MAC addresses can be stored in the bridging converter's MAC address table. The bridging converter's self-learning feature will learn all new addresses in real-time after power-up. If the source address of an incoming packet is not found in the MAC address table, the bridging converter will update the table with the new address.

The bridging converter also has an automatic address aging feature that will delete a source address from the table if it has not seen a frame from the end-node with that address within five minutes. This prevents the table from becoming filled with addresses of end-nodes that are no longer active.

The bridging converter forwards all multicast, broadcast, and unlearned unicast packets when the MAC address table has exceeded its storage limit.

Store and Forward

The AT-FS238a/x and AT-FS238b/x Series Bridging Converters support store and forward switching at Fast Ethernet full-wire speed in 100 Mbps, half- or full-duplex mode. Packets entering each port are stored in buffers. Once the full packet is received, the bridging converter will forward or discard the packet, depending on its destination address and error status. This ensures that only error-free packets destined for another segment will be transferred across the bridging converter, reducing network load.

The bridging converter will discard CRC errors, misaligned, runt, and under-sized packets. When the packet has dribble bits at the end, the bridging converter will truncate to octet boundary and check for a good FCS before forwarding.

Chapter 2

Installing the Bridging Converter

This chapter explains how to install the AT-FS238a/x and AT-FS238b/x Series Bridging Converters. These bridging converters can be installed on a desktop or in an AT-MCR12 chassis.

Verifying Package Contents

Make sure the following items are included in your package. If any item is missing or damaged, contact your Allied Telesyn sales representative for assistance.

- One AT-FS238a/x or AT-FS238b/x Series Bridging Converter
- Four protective feet (for desktop use only)
- AC/DC power supply (12VDC model only)
- DC power connector (12-50VDC model only)
- This installation guide
- Warranty card

Note

For information on the power supplies used with the AT-FS238a/x and AT-FS238b/x Series Bridging Converters, refer to “External Power Supply” on page 9.

Planning the Installation

Be sure to observe the following guidelines when planning the installation of your bridging converter.

- ❑ The fiber optic port on the bridging converter must be connected to a companion bridging converter (i.e., AT-FS238a/1 to AT-FS238b/1 or AT-FS238b/1 to AT-FS238b/2), or to a fiber optic port that is IEEE 802.3ah-compliant and whose operating specifications are compatible with the fiber optic port on the converter.
- ❑ The end-node connected to the 10Base-T/100Base-TX twisted pair port can operate at either 10 Mbps or 100 Mbps.
- ❑ The twisted pair cabling must be kept away from sources of electrical noise, such as radios, transmitters, power lines, broadband amplifiers, electrical motor, and fluorescent fixtures.

Table 3 lists the cabling specifications for the twisted pair port.

Table 3 10Base-T/100Base-TX Twisted Pair Cabling Specifications

Operating Mode	Cable Type	Maximum Operating Distance
10Base-T	Shielded or unshielded Category 3 or better	100 m (328 ft)
100Base-TX	Shielded or unshielded Category 5 or better	100 m (328 ft)

Table 4 lists the cabling specifications for the fiber optic port when operating in full-duplex mode. For information on the fiber optic port, refer to “Fiber Optic Port Specifications” on page 39.

Table 4 100Base-FX Fiber Optic Cabling Specifications (Full-duplex)

Model	Cable Type ¹	Maximum Operating Distance ²	Maximum Allowable Loss Budget
AT-FS238a/1	9/125 micron single-mode simplex	15 km (9.3 mi)	6 dB at 1310 nm
AT-FS238b/1	9/125 micron single-mode simplex	15 km (9.3 mi)	6 dB at 1310 nm
AT-FS238a/2	9/125 micron single-mode simplex	40 km (24.8 mi)	16 dB at 1310 nm
AT-FS238b/2	9/125 micron single-mode simplex	40 km (24.8 mi)	16 dB at 1310 nm

1. The fiber optic strand can be non-dispersion-shifted, dispersion-shifted, or non-zero dispersion-shifted single-mode cable.
2. Maximum distance for 100 Mbps optical datalinks is dependent on the following factors: quality of fiber optic, duplex mode of both end-nodes, and maximum optical loss budget for the optical fiber at each operating optical wavelength.

Selecting a Site

Be sure to observe the following guidelines when selecting a site for your bridging converter.

- Select a site that is dust-free, moisture-free, and has easy access the data cables and power cord.
- Use dedicated power circuits or power conditioners to supply reliable power to the device.
- Use one of the power sources described in “External Power Supply” on page 9. For the 12-50VDC version, provide regulated DC power only from a SELV power source per IEC 60950, such as regulated power supplies.

Note

Use only power sources that are UL Listed (QGGQ or EPBU), TUV Licensed or other Safety Agencies approved, and that are suitable for country of use.

Reviewing Safety Guidelines

Please review the following safety guidelines before you begin to install the bridging converter.



Warning

Class 1 laser device. ⚡ 7



Warning

Do not stare into the laser beam. ⚡ 8



Warning

Electric Shock Hazard: To prevent electric shock, do not remove the cover. There are no user-serviceable parts inside. The unit contains hazardous voltages and should only be opened by a trained and qualified technician. ⚡ 10



Warning

Lightning Danger: Do not work on this equipment or cables during periods of lightning activity. ⚡ 11



Caution

Power Cord: The power cord is used as a disconnection device: To de-energize equipment, disconnect the power cord. ⚡ 12



Caution

Pluggable Equipment: The socket outlet should be installed near the equipment and should be easily accessible. ⚡ 13



Caution

Air vents: The air vents must not be blocked on the unit and must have free access to the room ambient air for cooling. ⚡ 14



Caution

Operating Temperature: This product is designed for a maximum ambient temperature of 40°C. ⚡ 15



Caution

All Countries: Install this product in accordance with local and National Electric Codes. ⚡ 16

Installing the Bridging Converter

To install an AT-FS238a/x or AT-FS238b/x Series Bridging Converter, perform the following procedures:

1. Remove all equipment from the package and store the packaging material in a safe place.

Note

Do not remove the dust cover from the fiber optic port until you are ready to connect the fiber optic cable. Dust contamination can adversely impact the operating performance of the port and the bridging converter.

2. Attach the four protective feet (provided) to each corner of the bottom of the unit, as shown in Figure 12.

Note

Do not attach the protective feet if you are installing the bridging converter in an AT-MCR12 chassis.

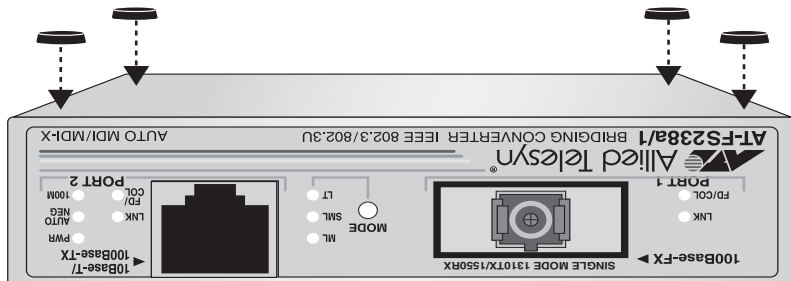

Figure 12 Attaching the Protective Feet

3. Configure the DIP switches. Refer to Figure 8 or Figure 9 on page 7 for the location of the DIP switches and Table 5 on page 24 for the possible settings.

Note

A change to a DIP switch setting does not take effect until after you reset the unit. To reset the unit, power the unit OFF then ON.

Table 5 lists the possible settings of the DIP switches..

Table 5 DIP Switch Settings

DIP Switch Number	Port	Setting	Position	Description
1	2	Speed (Mbps)	Up	The twisted pair port operates at 10 Mbps.
			Down	The twisted pair port operates at 100 Mbps.
2	1	Duplex Mode	Up	The fiber optic port operates in half-duplex mode.
			Down	The fiber optic port operates in full-duplex mode.
3	2	Duplex Mode	Up	The twisted pair port operates in half-duplex mode.
			Down	The twisted pair port operates in full-duplex mode.
4	2	Auto Neg	Up	Auto-Negotiation on the twisted pair port is OFF.
			Down	Auto-Negotiation on the twisted pair port is ON.

When setting the DIP switches, consider the following:

- Setting the Auto Neg DIP switch for the twisted pair port to ON or OFF enables or disables Auto-Negotiation for the port. If you disable Auto-Negotiation, be sure to set the DIP switches for the port's speed and duplex mode to match the speed and duplex mode of the end-node.
- If the end node connected to the twisted pair port is not using Auto-Negotiation and has a fixed duplex mode of full-duplex, you must disable Auto-Negotiation on the twisted pair port and set the speed and duplex mode manually. Otherwise, a duplex mode mismatch will result. For further information on this, refer to "Duplex Mode" on page 12.
- Disabling Auto-Negotiation on the twisted pair port also disables Auto MDI/MDI-X and configures the port as MDI-X.

- ❑ The fiber optic port can be set to half- or full-duplex. If you are connecting the fiber port to a companion bridging converter (i.e., AT-FS238a/1 to AT-FS238b/1 or AT-FS238a/2 to AT-FS238b/2), you should leave the duplex setting at the default setting of full-duplex for best performance. If you are connecting the fiber optic port on the bridging converter to an IEEE 802.3ah-compliant device, you must determine the duplex mode of the compliant device and set the duplex mode of the fiber optic port on the bridging converter accordingly.
4. If you are installing the bridging converter in an AT-MCR12 chassis, download the *AT-MCR12 Chassis Installation Guide* from our web site for instructions on how to install the bridging converter in the chassis, then proceed to Step 7.

Note

A 12-50VDC bridging converter cannot be installed in an AT-MCR12 chassis.

5. Place the bridging converter on a secure, level surface, leaving ample space around the bridging converter for ventilation.
6. Apply power to the bridging converter.

For instructions on how to apply power to a 12VDC version AT-FS238a/x or AT-FS238b/x Series Bridging Converter, refer to “Connecting a 12VDC Powered Unit” on page 27.

For instructions on how to apply power to a 12-50VDC version AT-FS238a/x or AT-FS238b/x Series Bridging Converter, refer to “Wiring and Connecting a 12-50VDC Powered Unit” on page 28.

Note

This step does not apply if you are mounting a 12VDC-version bridging converter in an AT-MCR12 chassis.

7. Remove the dust cover from the fiber optic port and connect the fiber optic cable to the 100Base-FX port.

When attaching a fiber optic cable, be sure to observe the following guidelines:

- ❑ You should verify that you are using the appropriate type of fiber optic cabling. Refer to Table 4 on page 21 for fiber optic cabling specifications.

- Be sure that the cable connector is firmly locked into place in the port.
- The fiber optic port must be connected to a fiber port on a companion bridging converter (i.e., AT-FS238a/1 to AT-FS238b/1 or AT-FS238a/2 to AT-FS238b/2), or to an IEEE 802.3ah-compliant device. Do not connect the fiber optic port to any other type of networking device. If you are connecting it to an IEEE 802.3ah-compliant device, you should verify that the device is compatible with bridging converter's fiber optic port. For fiber optic port specifications, refer to "Fiber Optic Port Specifications" on page 39.

8. Connect the twisted pair cable to the 10Base-T/100Base-TX port.

When connecting a twisted pair cable to a port, observe the following guidelines:

- An RJ-45 connector should fit snugly into the port on the converter. The tab on the connector should lock the connector into place.
- You should check to be sure that you are using the appropriate type of twisted pair cabling. Refer to Table 3 on page 20 for twisted pair cable specifications.
- Since the twisted pair port, when operating in Auto-Negotiation, is Auto MDI/MDI-X, you can use either a straight-through or crossover twisted pair cable to connect any type of network device to a port on the converter. If you disable Auto-Negotiation on the port, the port defaults to MDI-X.

9. Power ON the end-nodes.

10. Verify that the LNK LEDs for both the fiber optic port and the twisted pair port are green. If either LED is OFF, refer to "Troubleshooting" on page 33 for instructions.

Connecting a 12VDC Powered Unit

To apply power to a 12VDC version bridging converter, perform the following steps:

Note

The power adapter is not used if you install the bridging converter in an AT-MCR12 chassis.

1. Plug one end of the DC power cord to the power receptacle connector labelled 12VDC on the back panel of the bridging converter, as shown in Figure 13.

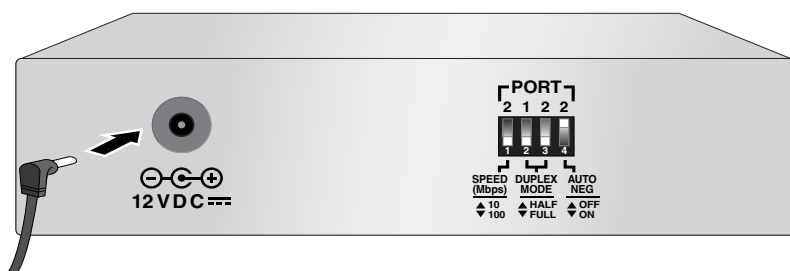

Figure 13 Connecting an 12VDC Powered Unit

2. Plug the AC/DC power adapter to a power outlet. Refer to “Technical Specifications” on page 37 for power requirements.
3. Verify that the PWR LED on the front of the unit is green. If the PWR LED is OFF, refer to “Troubleshooting” on page 33.
4. Perform Step 7 through Step 10 on page 25 to complete the installation.

Wiring and Connecting a 12-50VDC Powered Unit

To wire a 12-50VDC powered unit, perform the following step:

1. Before wiring the bridging converter, review the following Warning statements:



Warning

Only trained and qualified personnel are allowed to install or to replace this equipment.



Warning

For 12-50VDC power connection, install this equipment only in a Restricted Access Area.

2. On the rear side of the chassis is a 3-prong receptacle connector labeled 12-50VDC. Starting from the left side of the terminal block, identify the **negative**, **ground**, and **positive** terminals using either the diagram adjacent to the terminal block or the illustration shown in Figure 14.

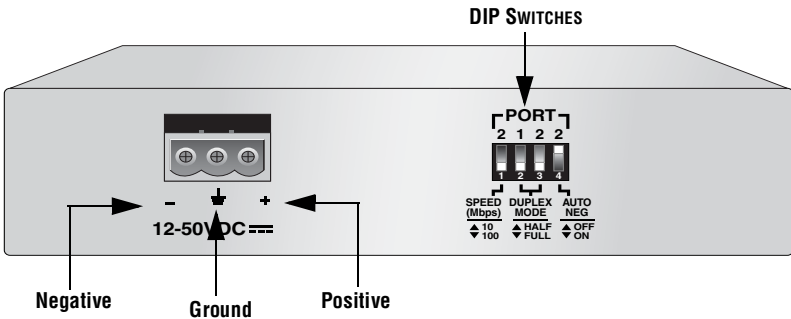

Figure 14 Negative, Ground, and Positive Symbols

**Warning**

The power input must be provided from a SELV power source only, per IEC 60950. Do not connect to a centralized DC battery bank.

3. Plug the power connector to the 12-50VDC receptacle connector in the rear of the converter, as shown in Figure 15.

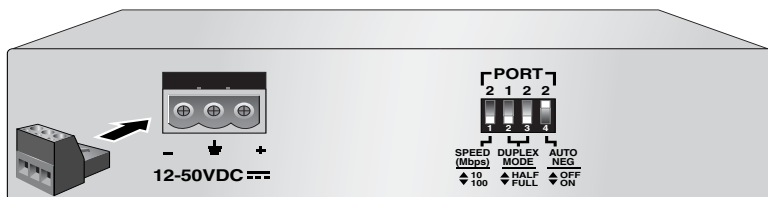

Figure 15 Connecting the Power Connector to the 12-50VDC Version Model

Note

UL recognized wires of 22-gauge minimum should be provided by the installer.

4. With a 22-gauge wire-stripping tool, strip the three wires in the tray cable coming from the DC input power source to $8\text{mm} \pm 1\text{mm}$ ($0.31\text{in.} \pm 0.039\text{in.}$), as shown in Figure 16 on page 29.



Warning

Do not strip more than the recommended amount of wire. Stripping more than the recommended amount can create a safety hazard by leaving exposed wire on the terminal block after installation. 17

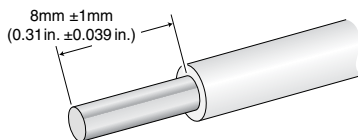

Figure 16 Stripped Wire

5. Connect the **ground** wire to the terminal marked with the ground symbol by inserting the wire into power connector and tightening the connection with a flathead screwdriver, as shown in Figure 17.



Warning

When installing this equipment, always ensure that the frame ground connection is installed first and disconnected last. 18

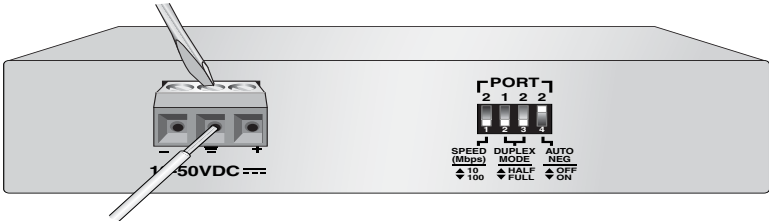

Figure 17 Connecting the Stripped Wire to the 12-50VDC Power Connector

6. Connect the **negative** feed wire to the terminal block marked (-).
7. Connect the **positive** feed wire to the terminal block marked (+).
8. Connect the other end of the wires to the terminal block on the AT-PWR237 power adapter or approved SELV power source per IEC 60950 (rated minimum 12-50VDC, 0.5A).



Figure 18 Connecting the Stripped Wires to the Optional AT-PWR237 Power Adapter

Note

The optional AT-PWR237 module does not have a terminal for the **ground** feed wire. Connect the ground wire from the bridging converter to the nearest chassis ground.

9. Secure the power supply cable in the Restricted Access Area using multiple cable ties to minimize the chance of the connections being disturbed by casual contact with the wiring.

**Warning**

"Safety Hazard"- Check to see if there are any exposed copper strands coming from the installed wires. When this installation is done correctly there should be no exposed copper wire strands extending from the terminal block. Any exposed wiring can conduct harmful levels of electricity to persons touching the wires. ⚡ 19

10. With the wires securely connected to both the input power connector in the rear of the unit and the terminal block on the power adapter, plug the power adapter to the power outlet. (Refer to "Technical Specifications" on page 37 for power requirements.)
11. Verify that the PWR LED on the front of the unit is green. If the PWR LED is OFF, refer to "Troubleshooting" on page 33.
12. Perform Step 7 through Step 10 on page 25 to complete the installation.

Warranty Registration

When you finish installing the product, you should register your product by completing the enclosed warranty card and sending it in.

Chapter 3

Troubleshooting

Follow the guidelines below to test and troubleshoot the installation in the event a problem occurs.

Note

If you change the speed or duplex mode of a port on the bridging converter using the DIP switches, you must power OFF and then power ON the unit to activate the change.

If the PWR LED is OFF, do the following:

- If the bridging converter is installed on a desktop, check to be sure that the power adapter is securely connected to a power outlet and that the power adapter cable is securely connected to the back of the bridging converter.
- If the bridging converter is installed in an AT-MCR12 chassis, check that the unit is fully seated in the slot and the retaining screw is securely fastened.
- Verify that the power outlet has power by connecting another device to it.
- Try using another power adapter.

If the LNK LED for the twisted pair port is OFF, do the following:

- Check that the end-node connected to the port is powered ON and is operating properly.
- Check that the twisted pair cable is securely connected to the twisted pair port on the bridging converter and on the end-node.
- Make sure that the twisted pair cable does not exceed 100 meters (328 feet) and that you are using a Category 3 or better cable for 10Base-T operation or a Category 5 or better cable for 100Base-TX operation.

- ❑ If the twisted pair port is set to Auto-Negotiation, the end-node connected to the port should also be using Auto-Negotiation. If the end-node is not using Auto-Negotiation and has a fixed duplex mode of full-duplex, a duplex mode mismatch will result. To resolve this, you must disable Auto-Negotiation on the port and adjust the speed and duplex setting manually using the DIP switches. For further information on this, refer to “Duplex Mode” on page 12.
- ❑ If you disabled Auto-Negotiation on the port, check to be sure that the port is operating at the same speed and duplex mode as the end-node.
- ❑ If you disabled Auto-Negotiation, the port is configured as MDI-X. A crossover cable will be required if the port on the end-node is also MDI-X.

If the LNK LED for the fiber optic port is OFF, do the following:

- ❑ Verify that the end-node connected to the port is ON and is operating properly.
- ❑ Check that the fiber optic cable is securely connected to the fiber optic port on the bridging converter and on the end-node.
- ❑ Test the attenuation on the fiber cable to ensure that it does not exceed acceptable values.
- ❑ Verify that you are using the appropriate type of fiber optic cable and that you have not exceeded the maximum operating distance. For cable types and maximum operating distances, refer to Table 4 on page 21.
- ❑ If you connected the fiber optic port to another bridging converter, verify that the two bridging converters are of the same series and that there is an “a” unit and a “b” unit. For instance, you cannot connect the fiber optic ports of two AT-FS238a/1 devices together; nor can you connect an AT-FS238a/1 unit and an AT-FS238b/2 together. The AT-FS238a/1 must be teamed with AT-FS238b/1 and the AT-FS238a/2 must be teamed with AT-FS238b/2.
- ❑ If you connected the fiber optic port to an IEEE 802.3ah-compliant device, verify that the device is operating at 100 Mbps and that the operating specifications of its fiber optic port matches that of the fiber optic port on the bridging converter. For fiber optic port specifications, refer to “Fiber Optic Port Specifications” on page 39.

If you are still experiencing problems after testing and troubleshooting the installation, contact Allied Telesyn Technical Support for assistance. Refer to “Contacting Allied Telesyn” on page x or visit our web site at **www.alliedtelesyn.com** for support information.

Appendix A

Technical Specifications

Physical

Dimensions:	W x D x H 10.5 cm x 9.5 cm x 2.5 cm (4.12 in x 3.75 in x 1.0 in)
Weight:	294 g (10.4 oz)

Environmental

Operating Temperature:	0° C to 40° C (32° F to 104° F)
Storage Temperature:	-25° C to 70° C (-13° F to 158° F)
Operating Humidity:	5% to 90% non-condensing
Storage Humidity:	5% to 95% non-condensing
Operating Altitude:	Up to 3,048 meters (10,000 feet)

Electrical Rating

Input Supply Voltage:	12VDC or 12-50VDC
Rated Currents:	0.5A or 0.13A (maximum)
Power Consumption:	6 W (maximum)

Agency Certifications

Safety	Conforms to all standards normally supported by Allied Telesyn products including safety standards UL60950 (cUL _{us}), EN60950, EN60825 (TUV) CE Compliant
Standard	IEEE 802.3, IEEE 802.3u
Immunity	Conforms to EN55024 immunity standard
EMI/RFI	FCC Class B, EN55022 Class B, VCCI Class B, C-TICK

Fiber Optic Port Specifications

Table 6 through Table 9 list the specifications for the fiber optic port.

Table 6 Fiber Optic Transmitter

Model	Fiber Type ¹ - Connector	Fiber Optic Diameter (microns)	Optical Wavelength	Launch Power (dBm) ²		
				Min.	Avg. ³	Max.
AT-FS238a/1	SMF Simplex - SC	9/125	1310 nm	-15.0	-11.0	-8.0
AT-FS238b/1	SMF Simplex - SC	9/125	1550 nm	-15.0	-11.0	-8.0
AT-FS238a/2	SMF Simplex - SC	9/125	1310 nm	-8.0	-5.0	-2.0
AT-FS238b/2	SMF Simplex - SC	9/125	1550 nm	-8.0	-5.0	-2.0

1. SMF = Single-Mode Fiber
2. Launch Power is measured at one meter from the transmitter.
3. Launch Power (Avg.) is power coupled into a single-mode fiber.

Table 7 Fiber Optic Receiver

Model	Fiber Type ¹ - Connector	Fiber Optic Diameter (microns)	Optical Wavelength	Receiver Sensitivity (dBm)		
				Max.	Avg.	Saturation
AT-FS238a/1	SMF Simplex - SC	9/125	1550 nm	-30.0	n/a	-7.5
AT-FS238b/1	SMF Simplex - SC	9/125	1310 nm	-30.0	n/a	-7.5
AT-FS238a/2	SMF Simplex - SC	9/125	1550 nm	-33.0	n/a	-2.0
AT-FS238b/2	SMF Simplex - SC	9/125	1310 nm	-33.0	n/a	-2.0

1. SMF = Single-Mode Fiber

Table 8 Fiber Optic Datalink

Model	Fiber Type¹	Minimum Power/Link Budget	Minimum Operating Distance²	Maximum Operating Distance³
AT-FS238a/1	9/125 SMF Simplex	6.0 dB	0	15 km (9.4 mi)
AT-FS238b/1	9/125 SMF Simplex	6.0 dB	0	15 km (9.4 mi)
AT-FS238a/2	9/125 SMF Simplex	16.0 dB	0	40 km (25 mi)
AT-FS238b/2	9/125 SMF Simplex	16.0 dB	0	40 km (25 mi)

1. SMF = Single-Mode Fiber
2. The recommended minimum range is stated in all cases where the maximum transmitter output power exceeds the receivers saturation level. This is to prevent blinding or burning out of the optical receiver on the far-end node.
3. Distance is calculated based on ideal situations without any other loss factor.

Table 9 Fiber Optic Loss Specification (Benchmark)

Fiber Type¹ - Connector	Fiber Optic Diameter	Optical Wavelength	Typical Loss Factor	Bandwidth
SMF Simplex - SC	9/125 microns	1310 nm	0.40 dB/km	N/A

1. SMF = Single-Mode Fiber

RJ-45 Pinout Assignments

Figure 19 shows the pin assignments of the RJ-45 connector.

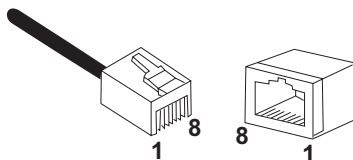

Figure 19 RJ-45 Pin Assignments

Table 10 lists the 10Base-T/100Base-TX connector pins and their signals when the port is operating in either MDI or MDI-X configuration.

Table 10 RJ-45 Pinouts

MDI-X	Signal	MDI	Signal
1	RX+	1	TX+
2	RX-	2	TX-
3	TX+	3	RX+
4	-	4	-
5	-	5	-
6	TX-	6	RX-
7	-	7	-
8	-	8	-

Appendix B

Translated Safety and Emission Information

Important: This appendix contains multiple-language translations for the safety statements in this guide.

Wichtig: Dieser Anhang enthält Übersetzungen der in diesem Handbuch enthaltenen Sicherheitshinweise in mehreren Sprachen.

Vigtigt: Dette tillæg indeholder oversættelser i flere sprog af sikkerhedsadvarselene i denne håndbog.

Belangrijk: Deze appendix bevat vertalingen in meerdere talen van de veiligheidsopmerkingen in deze gids.

Important: Cette annexe contient la traduction en plusieurs langues des instructions de sécurité figurant dans ce guide.

Tärkeää: Tämä liite sisältää tässä oppaassa esiintyvät turvaohjeet usealla kielellä.

Importante: questa appendice contiene traduzioni in più lingue degli avvisi di sicurezza di questa guida.

Viktig: Dette tillegget inneholder oversettelser til flere språk av sikkerhetsinformasjonen i denne veiledningen.

Importante: Este anexo contém traduções em vários idiomas das advertências de segurança neste guia.

Importante: Este apéndice contiene traducciones en múltiples idiomas de los mensajes de seguridad incluidos en esta guía.

Obs! Denna bilaga innehåller flerspråkiga översättningar av säkerhetsmeddelandena i denna handledning.

Standards: This product meets the following standards:

U.S. Federal Communications Commission

Declaration Of Conformity

Manufacturer Name:	Allied Telesyn, Inc.
Manufacturer Address:	960 Stewart Drive, Suite B Sunnyvale, CA 94085 USA
Manufacturer Telephone:	408-730-0950
Declares that the product:	Bridging Converter
Model Numbers:	AT-FS238a/1, AT-FS238b/1 AT-FS238a/2, AT-FS238b/2

This product complies with FCC Part 15B, Class B Limits:

This device complies with part 15 of the FCC Rules. Operation is subject to the following two conditions: (1) This device must not cause harmful interference, and (2) this device must accept any interference received, including interference that may cause undesired operation.

Radiated Energy

Note: This equipment has been tested and found to comply with the limits for a Class B digital device pursuant to Part 15 of FCC Rules. These limits are designed to provide reasonable protection against harmful interference in a residential installation. This equipment generates, uses and can radiate radio frequency energy and, if not installed and used in accordance with instructions, may cause harmful interference to radio or television reception, which can be determined by turning the equipment off and on. The user is encouraged to try to correct the interference by one or more of the following measures:











- Reorient or relocate the receiving antenna.
- Increase the separation between the equipment and the receiver.
- Connect the equipment into an outlet on a circuit different from that to which the receiver is connected.
- Consult the dealer or an experienced radio/TV technician for help.

Changes and modifications not expressly approved by the manufacturer or registrant of this equipment can void your authority to operate this equipment under Federal Communications Commission rules.

Industry Canada

This Class B digital apparatus meets all requirements of the Canadian Interference-Causing Equipment Regulations.

Cet appareil numérique de la classe B respecte toutes les exigences du Règlement sur le matériel brouilleur du Canada.





























- 1 **RFI Emission** FCC Class B, EN55022 Class B, VCCI Class B, C-TICK
- 2  **Warning:** In a domestic environment this product may cause radio interference in which case the user may be required to take adequate measures.
- 3 **Immunity** EN55024
- 4 **Warning:** This product requires shielded cables to comply with emission and immunity standards. If it is used with unshielded cables, the user may be required to take measures to correct the interference problem at their own expense.
- 5 **Electrical Safety** EN60950 (TUV), UL60950 (cUL_{us})
- 6  **Laser Safety** EN60825
- 7 **Warning:** Class 1 Laser product.
- 8 **Warning:** Do not stare into the Laser beam.
At time of installation, the Fiber Optic Lasers comply with FDA Radiation Performance Standard 21CFR Subchapter J, applicable at date of manufacture.
- 9 This is a “Class 1 LED Product”.
- 10  **Electrical Notices**
Warning: ELECTRIC SHOCK HAZARD
To prevent ELECTRIC shock, do not remove the cover. No user-serviceable parts inside. This unit contains HAZARDOUS VOLTAGES and should only be opened by a trained and qualified technician. To avoid the possibility of ELECTRIC SHOCK, disconnect electric power to the product before connecting or disconnecting the LAN cables.
- 11  **Lightning Danger**
Danger: DO NOT WORK on equipment or CABLES during periods of LIGHTNING ACTIVITY.
- 12  **Caution:** The power cord is used as a disconnection device. to de-energize equipment, disconnect the power cord.
- 13  Pluggable equipment, the socket outlet shall be installed near the equipment and shall be easily accessible.
- 14  **Caution:** Air vents must not be blocked and must have free access to the room ambient air for cooling.
- 15  **Operating Temperature:** This product is designed for a maximum ambient temperature of 40 degrees C.
- 16  **All Countries:** Install product in accordance with local and National Electrical Codes.
- 17  **Warning:** Do not strip more than the recommended amount of wire. Stripping more than the recommended amount can create a safety hazard by leaving exposed wire on the terminal block after installation.
- 18  **Warning:** When installing this equipment, always ensure that the frame ground connection is installed first and disconnected last.

19



Caution: “Safety Hazard” Check to see if there are any exposed copper strands coming from the installed wire. When this installation is done correctly there should be no exposed copper wire strands extending from the terminal block. Any exposed wiring can conduct harmful levels of electricity to persons touching the wires.

Normen: Dieses Produkt erfüllt die Anforderungen der nachfolgenden Normen.











-  **1 Hochfrequenzstörung** FCC Klasse B, EN55022 Klasse B, VCCI Klasse B, C-TICK
-   **Warnung:** Bei Verwendung zu Hause kann dieses Produkt Funkstörungen hervorrufen. In diesem Fall müßte der Anwender angemessene Gegenmaßnahmen ergreifen.
-  **3 Störsicherheit** EN55024
-  **4 Achtung:** Für dieses Produkt sind abgeschirmte Kabel erforderlich, damit den Richtlinien für Emission und Interferenzschutz entsprochen wird. Falls das Produkt mit nicht abgeschirmten Kabeln verwendet wird, können weitergehende Maßnahmen für die Korrektur von Interferenzproblemen auf Kosten des Benutzers notwendig werden.
-  **5 Elektrische Sicherheit** EN60950 (TUV), UL60950 (cUL_{us})
-   **Laser Sicherheit** EN60825
-  **7 Warnung:** Laserprodukt der Klasse 1.
-  **8 Warnung:** Nicht direkt in den Strahl blicken.
-  **9** Das ist ein "LED Produkt der Klasse 1"
-   **Achtung:** GEFÄHRLICHE SPANNUNG
Das Gehäuse nicht öffnen. Das Gerät enthält keine vom Benutzer wartbaren Teile. Das Gerät steht unter Hochspannung und darf nur von qualifiziertem technischem Personal geöffnet werden. Vor Anschluß der LAN-Kabel, Gerät vom Netz trennen.
-   **Gefahr Durch Blitzschlag**
Gefahr: Keine Arbeiten am Gerät oder an den Kabeln während eines Gewitters ausführen.
-   **Vorsicht:** Das netzkabel dient zum trennen der stromversorgung. Zur trennung vom netz, kabel aus der steckdose ziehen.
-   **Steckbares Gerät:** Die Anschlußbuchse sollte in der Nähe der Einrichtung angebracht werden und leicht zugänglich sein."
-   **Vorsicht**
Die Entlüftungsöffnungen dürfen nicht versperrt sein und müssen zum Kühlen freien Zugang zur Raumluft haben.
-   **Betriebstemperatur**
Dieses Produkt wurde für den Betrieb in einer Umgebungstemperatur von nicht mehr als 40° C entworfen.
-   **Alle Länder:** Installation muß örtlichen und nationalen elektrischen Vorschriften entsprechen.
-   **Warnung:** Ziehen Sie nicht mehr als die empfohlene Drahtlänge ab. Wird mehr als die empfohlene Länge abisoliert, stellt dies ein Sicherheitsrisiko dar, da auf dem Anschlußklemmblock nach der Installation möglicherweise freiliegende Drähte verbleiben.
-   **Warnung:** Bei der Installation dieser Einrichtung ist stets sicherzustellen, daß der Masseanschluß jeweils zuerst installiert und zuletzt getrennt wird.

19



Vorsicht: "Sicherheitsrisiko" Prüfen Sie, daß aus dem installierten Draht keine freiliegenden Kupferlitzen herausragen. Bei korrekter Installation sollten aus dem Anschlußklemmblock keine freiliegenden Kupferlitzen vorstehen. Freiliegende Kabel führen genug Spannung, um Personen zu gefährden, die diese Drähte berühren.

Standarder: Dette produkt tilfredsstiller de følgende standarder.











- 1 **Radiofrekvens forstyrrelsesemission** FCC Klasse B, EN55022 Klasse B, VCCI Klasse B, C-TICK
- 2  **Advarsel:** I et hjemligt miljø kunne dette produkt forårsage radio forstyrrelse. Bliver det tilfældet, påkræves brugeren muligvis at tage tilstrækkelige foranstaltninger.
- 3 **Immunitet** EN55024
- 4 **Advarsel:** Dette produkt skal bruges med afskærmede kabler for at overholde bestemmelserne vedrørende udstråling og støjimmunitet. Hvis det bruges med uafskærmede kabler, kan det blive påkrævet af brugeren at korrigere interferensproblemer for egen regning.
- 5 **Elektrisk sikkerhed** EN60950 (TUV), UL60950 (cUL_{US})
- 6  **Laser Sikkerhed** EN60825
- 7 **Advarsel:** Laserprodukt av klasse 1.
- 8 **Advarsel:** Stirr ikke på strålen.
- 9 Dette er et "Produkt under Klasse 1 LED"
- 10  **Elektriske Forholdsregler**
Advarsel: RISIKO FOR ELEKTRISK STØD
For at forebygge ELEKTRISK stød, undlad at åbne apparatet. Der er ingen indre dele, der kan repareres af brugeren. Denne enhed indeholder LIVSFARLIGE STRØMSPÆNDINGER og bør kun åbnes af en uddannet og kvalificeret tekniker. For at undgå risiko for ELEKTRISK STØD, afbrydes den elektriske strøm til produktet, før LAN-kablerne monteres eller afmonteres.
- 11  **Fare Under Uvejr**
Fare: UNDLAD at arbejde på udstyr eller KABLER i perioder med LYNAKTIVITET.
- 12  **Waarschuwing:** Het toestel wordt uitgeschakeld door de stroomkabel te ontkoppelen. Om het toestel stroomloos te maken: de stroomkabel ontkoppelen.
- 13  Aan te sluiten apparatuur, de contactdoos wordt in de nabijheid van de apparatuur geïnstalleerd en is gemakkelijk te bereiken."
- 14  **Opgelet:** De ventilatiegaten mogen niet worden gesperd en moeten de omgevingslucht ongehinderd toelaten voor afkoeling
- 15  **Betjeningstemperatur:** Dette apparat er konstrueret til en omgivende temperatur på maksimum 40 grader C.
- 16  **Alle Lande:** Installation af produktet skal ske i overensstemmelse med lokal og national lovgivning for elektriske installationer.
- 17  **Advarsel:** Man bør ikke afisolere mere af ledningerne end anvist, for så kan sådanne blanke ledninger udgøre et faremoment efter montering på klemmerækken.
- 18  **Advarsel:** Ved installering af dette udstyr skal steljord altid forbindes først og aftages sidst.

19



Forsigtig: "Fare" Se omhyggeligt efter om der stikker blanke kobbertråde ud fra klemmeforbindelserne. Ved korrekt montering er det ikke tilfældet. Enhver afisoleret leder kan lede farlig strømstyrke til personer, som kommer til at røre ved dem.

Eisen: Dit product voldoet aan de volgende eisen.











- 1 **RFI Emissie** FCC Klasse B, EN55022 Klasse B, VCCI Klasse B, C-TICK
- 2  **Waarschuwing:** Binnenshuis kan dit product radiostoring veroorzaken, in welk geval de gebruiker verplicht kan worden om gepaste maatregelen te nemen.
- 3 **Immuniteit** EN55024
- 4 **Waarschuwing:** Om te voldoen aan de emissie- en immuniteitsnormen dient dit apparaat te zijn voorzien van afgeschermd kabels. Als het met niet-afgeschermd kabels wordt gebruikt, kan het zijn dat de gebruiker maatregelen moet treffen om interferentieproblemen voor eigen rekening op te lossen.
- 5 **Electrische Veiligheid** EN60950 (TUV), UL60950 (cUL_{us})
- 6  **Laser Veiligheid** EN60825
- 7 **Waarschuwing:** Klasse-1 laser product.
- 8 **Waarschuwing:** Neit in de straal staren.
- 9 Dit is een "Klasse 1 LED-product"
- 10  **Elektriske Forholdsregler**
Advarsel: RISIKO FOR ELEKTRISK STØD For at forebygge ELEKTRISK stød, undlad at åbne apparatet. Der er ingen indre dele, der kan repareres af brugeren. Denne enhed indeholder LIVSFARLIGE STRØMSPÆNDINGER og bør kun åbnes af en uddannet og kvalificeret tekniker. For at undgå risiko for ELEKTRISK STØD, afbrydes den elektriske strøm til produktet, før LAN-kablerne monteres eller afmonteres.
- 11  **Gevaar Voor Blikseminslag**
Gevaar: NIET aan toestellen of KABELS WERKEN bij BLIKSEM.
- 12  **Attention:** Le cordon d'alimentation sert de mise hors circuit. Pour couper l'alimentation du matériel, débrancher le cordon.
- 13  Equipement pour branchement électrique, la prise de sortie doit être placée près de l'équipement et facilement accessible".
- 14  **Attention:** Ne pas bloquer les fentes d'aération, ceci empêcherait l'air ambiant de circuler librement pour le refroidissement
- 15  **Bedrijfstemperatuur:** De omgevingstemperatuur voor dit produkt mag niet meer bedragen dan 40 graden Celsius.
- 16  **Alle Landen:** het toestel installeren overeenkomstig de lokale en nationale elektrische voorschriften.
- 17  **Waarschuwing:** Verwijder niet meer dan de aanbevolen hoeveelheid isolatiemateriaal. Als u meer dan de aanbevolen hoeveelheid verwijdert, kan dit een veiligheidsrisico veroorzaken doordat draden bloot blijven liggen na aansluiting op het blok.
- 18  **Waarschuwing:** Zorg er tijdens installatie van de apparatuur altijd voor dat de aardeaansluiting van het frame als eerste wordt geplaatst en als laatste wordt losgemaakt.



19













Let Op: “Veiligheidsrisico” Controleer of er bij de aangesloten bedrading geen koper blootligt. Als de installatie juist is uitgevoerd, is er bij het aansluitblok geen koperdraad zichtbaar. Blootliggende bedrading kan schadelijke elektriciteitsniveaus geleiden naar personen die met de draden in aanraking komen.

Normes: Ce produit est conforme aux normes de suivantes.

- 1 **Emission d'interférences radioélectriques** FCC Classe B, EN55022 Classe B, VCCI Classe B, C-TICK
- 2  **Mise En Garde:** Dans un environnement domestique, ce produit peut provoquer des interférences radioélectriques. Auquel cas, l'utilisateur devra prendre les mesures adéquates.
- 3 **Immunité** EN55024
- 4 **Avertissement:** Il faut utiliser des câbles blindés pour ce produit afin de respecter les normes d'émission et d'immunité. Si l'utilisateur choisit d'utiliser des câbles non blindés, il sera peut-être contraint de prendre les mesures nécessaires pour corriger les problèmes d'interférences, ainsi que d'assumer le coût correspondant.
- 5 **Sécurité électrique** EN60950 (TUV), UL60950 (cUL_{us})
- 6  **Laser** EN60825
Sécurité
- 7 **Attention:** Produit laser de classe 1.
- 8 **Attention:** Ne pas fixer le faisceau des yeux.
- 9 Ce matériel est un "Produit à diode électroluminescente de Classe 1"
- 10  **Information Sur Les Risques Électriques**
Avertissement: DANGER D'ÉLECTROCUTION
Pour éviter toute ÉLECTROCUTION, ne pas ôter le revêtement protecteur du matériel. Ce matériel ne contient aucun élément réparable par l'utilisateur. Il comprend des TENSIONS DANGEREUSES et ne doit être ouvert que par un technicien dûment qualifié. Pour éviter tout risque d'ÉLECTROCUTION, débrancher le matériel avant de connecter ou de déconnecter les câbles LAN.
- 11  **Danger De Foudre**
Danger: NE PAS MANIER le matériel ou les CÂBLES lors d'activité orageuse.
- 12  **Attention:** Le cordon d'alimentation sert de mise hors circuit. Pour couper l'alimentation du matériel, débrancher le cordon.
- 13  **EQUIPEMENT POUR BRANCHEMENT ELECTRIQUE**, la prise de sortie doit être placée près de l'équipement et facilement accessible".
- 14  **Attention:** Ne pas bloquer les fentes d'aération, ceci empêcherait l'air ambiant de circuler librement pour le refroidissement.
- 15  **Température De Fonctionnement**
Ce matériel est capable de tolérer une température ambiante maximum de 40 degrés Celsius.
- 16  **Pour Tous Pays:** Installer le matériel conformément aux normes électriques nationales et locales.
- 17  **Mise En Garde:** Ne coupez pas une quantité de câble supérieure à celle qui est recommandée. Cela pourrait constituer un risque de sécurité en laissant du câblage à nu sur le bornier après l'installation.

-  **18** **Mise En Garde:** Lors de l'installation de cet équipement, vérifiez toujours que la connexion de terre du châssis est installée en premier et débranchée en dernier.
-  **19** **Attention:** "Risque de sécurité" Vérifiez qu'aucun fil de cuivre dénudé ne sort du câble installé. Lorsque cette installation est effectuée correctement, aucun fil de cuivre ne devrait dépasser du bornier. Tout câblage dénudé peut être conducteur de tensions dangereuses pour les personnes touchant les câbles.

Standardit: Tämä tuote on seuraavien standardien mukainen.



























- 1 **Radioaaltojen häirintä** FCC Luokka B, EN55022 Luokka B, VCCI Luokka B, C-TICK
- 2  **Varoitus:** Kotiolosuhteissa tämä laite voi aiheuttaa radioaaltojen häiröitä, missä tapauksessa laitteen käyttäjän on mahdollisesti ryhdyttävä tarpeellisiin toimenpiteisiin.
- 3 **Kestävyyys** EN55024
- 4 **Varoitus:** Tämä tuote vaatii suojattuja kaapeleita toimiakseen emissio- ja häiriönsetostandardien mukaisesti. Jos tuotetta käytetään ilman suojattuja kaapeleita, käyttäjä voi joutua korjaamaan häirinnän aiheuttaman ongelman omalla kustannuksellaan.
- 5 **Sähköturvallisuus** EN60950 (TUV), UL60950 (cUL_{us})
- 6  **Laser Turvallisuus** EN60825
- 7 **Varoitus:** Luokan 1 Lasertuote.
- 8 **Variotus:** Älä katso säteeseen.
- 9 Tämä on "Ensimmäisen luokan valodiodituote"
- 10  **Sähköön Liittyviä Huomautuksia**
Varoitus: SÄHKÖISKUVAARA Estääksesi SÄHKÖISKUN älä poista kantta. Sisällä ei ole käyttäjän huollettavissa olevia osia. Tämä laite sisältää VAARALLISIA JÄNNITTEITÄ ja sen voi avata vain koulutettu ja pätevä teknikko. Vältä äläkä SÄHKÖISKUN mahdollisuuden katkaise sähkövirta tuotteeseen ennen kuin liität tai irrotat paikallisverkon (LAN) kaapelit.
- 11  **Salamaniskuvaara**
Engenvaara: ÄLÄ TYÖSKENTELE laitteiden tai KAAPELEIDEN KANSSA SALAMOINNIN AIKANA.
- 12  **Huomautus:** VIRTAJOHTOA KÄYTETÄÄN VIRRANKATKAISULAITTEENA. VIRTA KATKAISTAAN irrottamalla virtajohto.
- 13  Pistorasiaan kytkettävä laite; pistorasia on asennettava laitteen lähelle ja siihen on oltava esteetön pääsy."
- 14  **Huomautus:** Ilmavaihtoreikiä ei pidä tukkia ja niillä täytyy olla vapaa yhteys ympäröivään huoneilmaan, jotta ilmanvaihto tapahtuisi.
- 15  **Käyttölämpötila**
Tämä tuote on suunniteltu ympäröivän ilman maksimilämpötilalle 40° C.
- 16  **Kaikki Maat:** Asenna tuote paikallisten ja kansallisten sähköturvallisuusmääräysten mukaisesti.
- 17  **Variotus:** Älä poista johtimesta päällystettyä enempää kuin on suositeltu. Päällysteen poistaminen suositusta pidemmältä matkalta voi aiheuttaa turvallisuusrisikin, sillä riviliittimeen jää asennuksen jälkeen paljaita johtimia.
- 18  **Variotus:** Kun asennat tätä laitetta, varmista aina, että runkomaadoitettu liitin kytketään ensin ja irrotetaan viimeiseksi.



19











Huomio: Turvallisuusriski Tarkista, ettei asennetusta johtimesta näy paljaita kuparisäikeitä. Kun asennus suoritetaan oikein, riviliittimestä ei pitäisi näkyä paljaita kuparijohdinsäikeitä. Paljaat johtimet voivat aiheuttaa sähköiskuvaaran, jos niihin kosketaan.





















Standard: Questo prodotto è conforme ai seguenti standard.

-  **1 Emissione RFI (interferenza di radiofrequenza)** FCC Classe B, EN55022 Classe B, VCCI Classe B, C-TICK
-   **2 Avvertenza:** in ambiente domestico questo prodotto potrebbe causare radio interferenza. In questo caso potrebbe richiedersi all'utente di prendere gli adeguati provvedimenti.
-  **3 Immunità** EN55024
-  **4 Avvertenza:** questo prodotto, se utilizzato con cavi schermati, è conforme alle norme sulle emissioni e sull'immunità. In caso di uso senza cavi schermati, l'utente può dover adottare a proprie spese misure correttive contro le interferenze.
-  **5 Sicurezza elettrica** EN60950 (TUV), UL60950 (cUL_{us})
-   **6 Laser** EN60825
- Norme Di Sicurezza**
-  **7 Avvertenza:** Prodotto laser di Classe 1.
-  **8 Avvertenza:** Non fissare il raggio con gli occhi.
-  **9** Questo è un "Prodotto con LED di Classe 1"
-   **10 Avvertenze Elettriche**
Attenzione: PERICOLO DI SCOSSE ELETTRICHE
 Per evitare SCOSSE ELETTRICHE non asportare il coperchio. Le componenti interne non sono riparabili dall'utente. Questa unità ha TENSIONI PERICOLOSE e va aperta solamente da un tecnico specializzato e qualificato. Per evitare ogni possibilità di SCOSSE ELETTRICHE, interrompere l'alimentazione del dispositivo prima di collegare o staccare i cavi LAN.
-   **11 Pericolo Di Fulmini**
Pericolo: NON LAVORARE sul dispositivo o sui CAVI durante PRECIPITAZIONI TEMPORALESCE.
-   **12 Attenzione:** Il cavo di alimentazione è usato come dispositivo di disattivazione. Per togliere la corrente al dispositivo staccare il cavo di alimentazione.
-   **13** Apparecchiatura collegabile, la presa va installata vicino all'apparecchio per risultare facilmente accessibile".
-   **14 Attenzione:** le prese d'aria non vanno ostruite e devono consentire il libero ricircolo dell'aria ambiente per il raffreddamento.
-   **15 Temperatura Di Funzionamento**
 Questo prodotto è concepito per una temperatura ambientale massima di 40 gradi centigradi.
-   **16 Tutti I Paesi** installare il prodotto in conformità delle vigenti normative elettriche nazionali.
-   **17 Avvertenza:** Per evitare i possibili pericoli associati all'esposizione dei fili sulla morsettiera dopo l'installazione, non rimuovere l'isolamento oltre le misure specificate.

-  **18** **Avvertenza:** Quando si installa questo apparecchio, accertarsi sempre che il collegamento a massa del telaio sia sempre il primo ad essere effettuato e l'ultimo ad essere scollegato.
-  **19** **Attenzione:** "Pericolo!" Controllare che il filo installato non abbia trefoli in rame esposti. Se l'installazione è stata effettuata in modo corretto, non vi deve protrudere dalla morsettiere alcun trefolo in rame esposto. In caso di contatto, un filo esposto può condurre livelli di elettricità pericolosi a quanti lo tocchino.

Sikkerhetsnormer: Dette produktet tilfredsstiller følgende sikkerhetsnormer.

-  **1 RFI stråling** FCC Klasse B, EN55022 Klasse B, VCCI Klasse B, C-TICK
-   **Advarsel:** Hvis dette produktet benyttes til privat bruk, kan produktet forårsake radioforstyrrelse. Hvis dette skjer, må brukeren ta de nødvendige forholdsregler.
-  **3 Immunitet** EN55024
-  **4 Advarsel:** Dette produktet må brukes med vannede kabler for å tilfredsstille emisjons- og fritakelsesstandarder. Dersom produktet brukes med uvernede kabler, må brukeren muligens rette forstyrrelsesproblemene for egen regning.
-  **5 Elektrisk sikkerhet** EN60950 (TUV), UL60950 (cUL_{us})
-   **Laser** EN60825











Sikkerhet
-  **7 Advarsel:** Laserprodukt av klasse 1.
-  **8 Advarsel:** Stirr ikke på strålen.
-  **9** Dette er et "Klasse 1 LED produkt"
-   **10 Elektrisitet**
Advarsel: FARE FOR ELEKTRISK SJOKK
 For å unngå ELEKTRISK sjokk, må dekslet ikke tas av. Det finnes ingen deler som brukeren kan reparere på innsiden. Denne enheten inneholder FARLIGE SPENNINGER, og må kun åpnes av en faglig kvalifisert tekniker. For å unngå ELEKTRISK SJOKK må den elektriske strømmen til produktet være avslått før LAN-kablene til- eller frakobles.
-   **11 Fare For Lynnedslag**
Fare: ARBEID IKKE på utstyr eller KABLER i TORDENVÆR.
-   **12 Forsiktig:** STRØMLEDNINGEN BRUKES TIL Å FRAKOBLE UTSTYRET. FOR Å DEAKTIVISERE UTSTYRET, må strømforsyningen kobles fra.
-   **13** Utstyr for stikkontakt. Stikkontakten skal monteres i nærheten av utstyret og skal være lett tilgjengelig."
-   **14 Forsiktig:** Lufteventilene må ikke blokkeres, og må ha fri tilgang til luft med romtemperatur for avkjøling.
-   **15 Driftstemperatur:** Dette produktet er konstruert for bruk i maksimum romtemperatur på 40 grader celsius.
-   **16 Alle Land:** Produktet må installeres i samsvar med de lokale og nasjonale elektriske koder.
-   **17 Advarsel:** Du skal ikke avisolere mer av ledningen enn det som er anbefalt. Dersom du avisolere mer enn det som er anbefalt, kan dette forårsake en sikkerhetsfare, ettersom det vil finnes uisolert ledning på rekkeklemmen etter montering.
-   **18 Advarsel:** Når du monterer dette utstyret, skal du alltid passe på at forbindelsen til rammejordingen monteres først og koples fra sist.

19



Forsiktig: "Sikkerhetsfare" Kontroller om uisolerte kobbertråder stikker ut av den monterte ledningen. Hvis monteringen er riktig utført, skal det ikke finnes uisolerte kobbertråder som stikker ut fra rekkeklemmen. Uisolerte ledninger kan lede skadelige mengder strøm til personer som berører ledningene.

Padrões: Este produto atende aos seguintes padrões.



- 1 **Emissão De Interferência De Radiofrequência** FCC Classe B, EN55022 Classe B, VCCI Classe B, C-TICK
- 2  **Aviso:** Num ambiente doméstico este produto pode causar interferência na radiorrecepção e, neste caso, pode ser necessário que o utente tome as medidas adequadas.
- 3 **Imunidade** EN55024
- 4 **Advertência:** Este produto requer a utilização de cabos blindados para cumprimento dos standards de limites de emissão e imunidade. Se o produto for utilizado com cabos não blindados, o utilizador poderá necessitar de tomar medidas para correcção de problemas de interferência, por sua própria conta.
- 5 **Segurança Eléctrica** EN60950 (TUV), UL60950 (cUL_{us})
- 6  **Laser** EN60825
Segurança
- 7 **Aviso:** Produto laser de classe 1.
- 8 **Aviso:** Não olhe fixamente para o raio.
- 9 Este é um “Produto Classe 1 LED”
- 10  **Avisos Sobre Características Eléctricas**
Atenção: PERIGO DE CHOQUE ELÉTRICO
Para evitar CHOQUE ELÉTRICO, não retire a tampa. Não contém peças que possam ser consertadas pelo usuário. Este aparelho contém VOLTAGENS PERIGOSAS e só deve ser aberto por um técnico qualificado e treinado. Para evitar a possibilidade de CHOQUE ELÉTRICO, desconecte o aparelho da fonte de energia eléctrica antes de conectar e desconectar os cabos da LAN.
- 11  **Perigo De Choque Causado Por Raio**
Perigo: NÃO TRABALHE no equipamento ou nos CABOS durante períodos suscetíveis a QUEDAS DE RAIOS.
- 12  **Cuidado:** O cabo de alimentação é utilizado como um dispositivo de desconexão. Para deseletrificar o equipamento, desconecte o cabo de alimentação.
- 13  Equipamento de ligação, a tomada eléctrica deve estar instalada perto do equipamento e ser de fácil acesso."
- 14  **Cuidado:** As aberturas de ventilação não devem ser bloqueadas e devem ter acesso livre ao ar ambiente para arrefecimento adequado do aparelho.
- 15  **Temperatura De Funcionamento:** Este produto foi projetado para uma temperatura ambiente máxima de 40 graus centígrados.
- 16  **Todos Os Países:** Instale o produto de acordo com as normas nacionais e locais para instalações eléctricas.
- 17  **Aviso:** Não corte mais fio do que recomendado. Cortar mais do que o recomendado pode ser perigoso, por deixar fio exposto no terminal depois da instalação.
- 18  **Aviso:** Ao ligar este equipamento, instale sempre primeiro a ligação à terra e desligue-a sempre em último.









19



Atenção: “Perigo” Verifique se há algum fio de cobre exposto a sair do fio instalado. Quando esta instalação é feita correctamente não deve haver qualquer fio de cobre exposto a sair do terminal. Qualquer fio exposto pode conduzir níveis perigosos de electricidade para a pessoa que toque nos fios.

Estándares: Este producto cumple con los siguientes estándares.

- 1 **Emisión RFI** FCC Clase B, EN55022 Clase B, VCCI Clase B, C-TICK
- 2  **Advertencia:** en un entorno doméstico, este producto puede causar radiointerferencias, en cuyo caso, puede requerirse del usuario que tome las medidas que sean convenientes al respecto.
- 3 **Inmunidad** EN55024
- 4 **Advertencia:** Este producto exige cables protectores para ajustarse a las normas de emisión e inmunidad. Si se utiliza con cables sin protección, el usuario tendrá que correr con los gastos por las medidas a tomar en caso de problemas de interferencias.
- 5 **Seguridad eléctrica** EN60950 (TUV), UL60950 (cUL_{us})
- 6  **Laser** EN60825









Seguridad
- 7 **Advertencia:** Producto láser Clase 1.
- 8 **Advertencia:** No mirat fijamente el haz.
- 9 Este es un “Producto de diodo luminiscente (LED) Clase 1”
- 10  **Avisos Electricos**
Advertencia: PELIGRO DE ELECTROCHOQUE
 Para evitar un ELECTROCHOQUE, no quite la tapa. No hay ningún componente en el interior al cual puede prestar servicio el usuario. Esta unidad contiene VOLTAJES PELIGROSOS y sólo deberá abrirla un técnico entrenado y calificado. Para evitar la posibilidad de ELECTROCHOQUE desconecte la corriente eléctrica que llega al producto antes de conectar o desconectar los cables LAN.
- 11  **Peligro De Rayos**
Eligi: NO REALICE NINGUN TIPO DE TRABAJO O CONEXION en los equipos o en LOS CABLES durante TORMENTAS ELECTRICAS.
- 12  **Atencion:** EL CABLE DE ALIMENTACION SE USA COMO UN DISPOSITIVO DE DESCONEXION. PARA DESACTIVAR EL EQUIPO, desconecte el cable de alimentación.
- 13  Equipo conectable, el tomacorriente se debe instalar cerca del equipo, en un lugar con acceso fácil”.
- 14  **Atencion:** Las aberturas para ventilación no deberán bloquearse y deberán tener acceso libre al aire ambiental de la sala para su enfriamiento.
- 15  **Temperatura Requerida Para La Operación:** Este producto está diseñado para una temperatura ambiental máxima de 40 grados C.
- 16  **Para Todos Los Países:** Monte el producto de acuerdo con los Códigos Eléctricos locales y nacionales.
- 17  **Advertencia:** No pele el cable más de la cantidad recomendada, ya que si después de instalar el bloque terminal quedan cables pelados, habrá riesgos de seguridad.
- 18  **Advertencia:** Cuando instale dicho equipo, asegúrese siempre de que el bastidor se conecte a tierra primero y se desconecte por último.























19



Cuidado: “Riesgo de seguridad” Cerciórese de que no haya hilos de cobre pelados que salgan del alambre instalado. Cuando dicha instalación se realiza correctamente, los hilos de cobre pelados no deben salir del bloque terminal. Todo alambre pelado puede conducir niveles de electricidad nocivos a la persona que lo toca.

Standarder: Denna produkt uppfyller följande standarder.

-  **1 Radiostörning** FCC Klass B, EN55022 Klass B, VCCI Klass B, C-TICK
-   **2 Varning:** Denna produkt kan ge upphov till radiostörningar i hemmet, vilket kan tvinga användaren till att vidtaga erforderliga åtgärder.
-  **3 Immunitet** EN55024
-  **4 Varning:** Denna produkt kräver skärmade kablar för att uppfylla standardkraven för emission och immunitet. Om den används med oskärmade kablar kan användaren vara tvungen att vidta åtgärder på egen bekostnad för att åtgärda störningsproblemet.
-  **5 Elsäkerhet** EN60950 (TUV), UL60950 (cUL_{US})
-   **6 Laser** EN60825

Säkerhet
-  **7 Varning:** Laserprodukt av klass 1.
-  **8 Varning:** Laserstrålning när enheten är öppen.
-  **9** Detta är en "Klass 1 lysdiodprodukt"
-   **10 tillkännagivanden beträffande elektricitetsrisk:**
RISK FÖR ELEKTRISK STÖTFör att undvika ELEKTRISK stöt, ta ej av locket. Det finns inga delar inuti som behöver underhållas. Denna apparat är under HÖGSPÄNNING och får endast öppnas av en utbildad kvalificerad tekniker. För att undvika ELEKTRISK STÖT, koppla ifrån produktens strömanslutning innan LAN-kablarna ansluts eller kopplas ur.
-   **11 Fara För Blixtnedslag**
Fara: ARBETA EJ på utrustningen eller kablarna vid ÅSKVÄDER.
-   **12 Varning:** Nätkabeln används som strömbrytare för att koppla från strömmen, dra ur nätkabeln.
-   **13** Utrustning med plugg. Uttaget skall installeras i utrustningens närhet och vara lättåtkomligt".
-   **14 Varning:** Luftventilerna får ej blockeras och måste ha fri tillgång till omgivande rumsluft för avsvälning.
-   **15 Driftstemperatur:** Denna produkt är konstruerad för rumstemperatur ej överstigande 40 grader Celsius.
-   **16 Alla Länder:** Installera produkten i enlighet med lokala och statliga bestämmelser för elektrisk utrustning.
-   **17 Varning:** Skala inte av mer isolering än vad som anges ovan. Skalas för mycket isolering av kan fara uppstå om oskyddad tråd vidröras på anslutningsplinten efter anslutningen.
-   **18 Varning:** Vid anslutning av denna utrustning skall man alltid se till att jordtråden ansluts först och lossas sist.
-   **19 Obs Fara:** Kontrollera om små koppartrådar sticker ut ifrån den anslutna tråden. Om anslutningen utförts riktigt sticker inga trådar ut från anslutningsplinten. Oisolerade trådar kan överföra skadlig elektricitet till person som vidrör trådarna.

