

Gigabit Ethernet Switch

AT-GS905



Installation Guide



Simply connecting the  world



Copyright ©2004 Allied Telesyn, Inc.
960 Stewart Drive Suite B, Sunnyvale, CA 94085 USA

All rights reserved. No part of this publication may be reproduced without prior written permission from Allied Telesyn, Inc.

All other product names, company names, logos or other designations mentioned herein are trademarks or registered trademarks of their respective owners.

Allied Telesyn, Inc. reserves the right to make changes in specifications and other information contained in this document without prior written notice. The information provided herein is subject to change without notice. In no event shall Allied Telesyn, Inc. be liable for any incidental, special, indirect, or consequential damages whatsoever, including but not limited to lost profits, arising out of or related to this manual or the information contained herein, even if Allied Telesyn, Inc. has been advised of, known, or should have known, the possibility of such damages.

Electrical Safety and Emission Statement

Standards: This product meets the following standards.

U.S. Federal Communications Commission	
Declaration Of Conformity	
Manufacturer Name:	Allied Telesyn, Inc.
Manufacturer Address:	960 Stewart Drive, Suite B Sunnyvale, CA 94085 USA
Manufacturer Telephone:	408-730-0950
Declares that the product:	Gigabit Ethernet Switch
Model Numbers:	AT-GS905
This product complies with FCC Part 15B, Class B Limits:	
This device complies with part 15 of the FCC Rules. Operation is subject to the following two conditions: (1) This device must not cause harmful interference, and (2) this device must accept any interference received, including interference that may cause undesired operation.	
Radiated Energy	
Note: This equipment has been tested and found to comply with the limits for a Class B digital device pursuant to Part 15 of FCC Rules. These limits are designed to provide reasonable protection against harmful interference in a residential installation. This equipment generates, uses and can radiate radio frequency energy and, if not installed and used in accordance with instructions, may cause harmful interference to radio or television reception, which can be determined by turning the equipment off and on. The user is encouraged to try to correct the interference by one or more of the following measures:	
<ul style="list-style-type: none">- Reorient or relocate the receiving antenna.- Increase the separation between the equipment and the receiver.- Connect the equipment into an outlet on a circuit different from that to which the receiver is connected.- Consult the dealer or an experienced radio/TV technician for help.	
Changes and modifications not expressly approved by the manufacturer or registrant of this equipment can void your authority to operate this equipment under Federal Communications Commission rules.	

Canadian Department of Communications	
This Class B digital apparatus meets all requirements of the Canadian Interference-Causing Equipment Regulations.	
Cet appareil numérique de la classe B respecte toutes les exigences du Règlement sur le matériel brouilleur du Canada.	

RFI Emission FCC Class B, EN55022 Class B, VCCI Class B, C-TICK  **1**





Warning: In a domestic environment this product may cause radio interference in which case the user may be required to take adequate measures.  **2**

Immunity EN55024  **3**

Electrical Safety EN60950 (TUV), UL60950 (cUL_{us}), CE  **4**

Important: Appendix B contains translated safety statements for installing this equipment. When you see the , go to Appendix B for the translated safety statement in your language.

Wichtig: Anhang B enthält übersetzte Sicherheitshinweise für die Installation dieses Geräts. Wenn Sie  sehen, schlagen Sie in Anhang B den übersetzten Sicherheitshinweis in Ihrer Sprache nach.

Viktigt: Tillæg B indeholder oversatte sikkerhedsadvarsler, der vedrører installation af dette udstyr. Når De ser symbolet , skal De slå op i tillæg B og finde de oversatte sikkerhedsadvarsler i Deres eget sprog.

Belangrijk: Appendix B bevat vertaalde veiligheidsopmerkingen voor het installeren van deze apparatuur. Wanneer u de  ziet, raadpleeg Appendix B voor vertaalde veiligheidsinstructies in uw taal.

Important: L'annexe B contient les instructions de sécurité relatives à l'installation de cet équipement. Lorsque vous voyez le symbole , reportez-vous à l'annexe B pour consulter la traduction de ces instructions dans votre langue.

Tärkeää: Liite B sisältää tämän laitteen asentamiseen liittyvät käännetyt turvaohjeet. Kun näet -symbolin, katso käännettyä turvaohjetta liitteestä B.

Importante: L'Appendice B contiene avvisi di sicurezza tradotti per l'installazione di questa apparecchiatura. Il simbolo , indica di consultare l'Appendice B per l'avviso di sicurezza nella propria lingua.

Viktig: Tillegg B inneholder oversatt sikkerhetsinformasjon for installering av dette utstyret. Når du ser , åpner du til Tillegg C for å finne den oversatte sikkerhetsinformasjonen på ønsket språk.

Importante: O Anexo B contém advertências de segurança traduzidas para instalar este equipamento. Quando vir o símbolo , leia a advertência de segurança traduzida no seu idioma no Anexo B.

Importante: El Apéndice B contiene mensajes de seguridad traducidos para la instalación de este equipo. Cuando vea el símbolo , vaya al Apéndice B para ver el mensaje de seguridad traducido a su idioma.

Obs! Bilaga B innehåller översatta säkerhetsmeddelanden avseende installationen av denna utrustning. När du ser , skall du gå till Bilaga B för att läsa det översatta säkerhetsmeddelandet på ditt språk.

Table of Contents

Electrical Safety and Emission Statement	3
Preface	7
How This Guide is Organized	7
Document Conventions	8
Contacting Allied Telesyn	9
Online Support.....	9
Email and Telephone Support.....	9
Returning Products.....	9
For Sales or Corporate Information	9
Chapter 1	
Product Description	10
Features	11
Components	12
Hardware Feature Description	13
Twisted Pair Ports	13
LEDs.....	14
AC Power Connector.....	15
A Few Ethernet Switching Basics	16
MAC Address Table.....	16
Duplex Mode.....	17
Store and Forward.....	17
Backpressure and Flow Control	17
Network Topologies	19
Power Workgroup Topology.....	19
Collapsed Backbone	19
Chapter 2	
Installation	21
Reviewing Safety Precautions	22
Selecting a Site for the Switch	23
Planning the Installation	24
Unpacking the Switch	25
Using the Switch on a Desktop	26
Wall- Mounting the Switch	27
Cabling the Switch	29
Powering On the Switch	30
Warranty Registration	31

Chapter 3	
Troubleshooting	32
Appendix A	
Technical Specifications	34
Physical Specifications	34
Environmental Specifications	34
Power Specifications	34
Safety and Electromagnetic Emissions Certifications	35
Connectors	35
RJ-45 Twisted Pair Port Pinouts	35
Appendix B	
Translated Electrical Safety and Emission Information	37

Preface

This guide contains the hardware installation instructions for the AT-GS905 Gigabit Ethernet Switch.

How This Guide is Organized

This manual contains the following chapters and appendices:

Chapter 1, Product Description, describes the features and components of the switches.

Chapter 2, Installation, contains the installation instructions for the switches.

Chapter 3, Troubleshooting, provides information on how to resolve problems that might occur with the switches.

Appendix A, Technical Specifications, contains the technical specifications for the switches.

Appendix B, Translated Electrical Safety and Emission Information, contains translations of the warnings and cautions in the manual.

Document Conventions

This document uses the following conventions to highlight important information:

Note

Notes provide additional information.



Warning

Warnings inform you that performing or omitting a specific action may result in bodily injury.



Caution

Cautions inform you that performing or omitting a specific action may result in equipment damage or loss of data.

Contacting Allied Telesyn

This section provides Allied Telesyn contact information for technical support as well as sales or corporate information.

Online Support

You can request technical support online by accessing the Allied Telesyn Knowledge Base from the following web site:

<http://kb.alliedtelesyn.com>. You can use the Knowledge Base to submit questions to our technical support staff and review answers to previously asked questions.

Email and Telephone Support

For Technical Support via email or telephone, refer to the Support & Services section of the Allied Telesyn web site:

<http://www.alliedtelesyn.com>.

Returning Products

Products for return or repair must first be assigned a Return Materials Authorization (RMA) number. A product sent to Allied Telesyn without a RMA number will be returned to the sender at the sender's expense.

To obtain a RMA number, contact Allied Telesyn's Technical Support at our web site: **<http://www.alliedtelesyn.com>**.

For Sales or Corporate Information

You can contact Allied Telesyn for sales or corporate information at our web site: **<http://www.alliedtelesyn.com>**. To find the contact information for your country, select "**Contact Us**", then "**Worldwide Contacts**".

Chapter 1

Product Description

The AT-GS905 Gigabit Ethernet switch is an unmanaged, Layer 2 Gigabit Ethernet switch designed to simplify the task of creating or expanding an Ethernet, Fast Ethernet, or Gigabit Ethernet network.

This chapter contains the follows sections:

- ❑ **Features** on page 11
- ❑ **Components** on page 12
- ❑ **Hardware Feature Description** on page 13
- ❑ **A Few Ethernet Switching Basics** on page 16
- ❑ **Network Topologies** on page 19

Features

AT-GS905 Gigabit Ethernet switch features include:

- Five 10/100/1000 Mbps twisted pair ports
- System and port LEDs
- Auto MDI/MDI-X
- Auto-Negotiation (IEEE 802.3u-compliant)
- 10/100 Mbps full or half-duplex, and 1000 Mbps full duplex
- Back pressure and flow control (IEEE 802.3x-compliant)
- Broadcast storm control
- Full wire-speed switching with Head of Line (HOL) blocking prevention
- Support 128K byte packet buffer with the length of packet up to 1522 byte
- Support two-way dynamic address learning for 4K MAC addresses

Components

Figure 1 illustrates the front and back panels of the AT-GS905 switch.

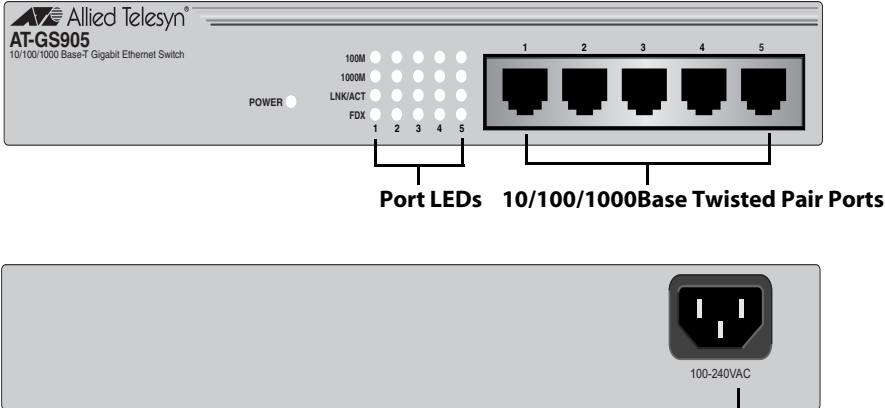

Figure 1 Front and Back Panels

Hardware Feature Description

The following sections describe hardware features of the AT-GS905 Gigabit Ethernet switch:

- System and Port LEDs
- Twisted Pair Ports
- AC Power Connector

Twisted Pair Ports

The AT-GS905 Gigabit Ethernet switch features five twisted pair ports.

Type of Connector

The twisted pair ports feature 8-pin RJ-45 connectors. (For the port pinouts, refer to **RJ-45 Twisted Pair Port Pinouts** on page 35.)

Speed

The ports are 10Base-T, 100Base-TX, and 1000Base-T compliant and are capable of 10 megabits per second (Mbps), 100 Mbps, and 1000 Mbps speeds. The ports are IEEE 802.3u Auto-Negotiation compliant. With Auto-Negotiation, the switch automatically matches the highest possible common speed between each switch port and each end-node. For example, if an end-node is capable of only 10 Mbps, the switch sets the port connected to the end-node to 10 Mbps.

Duplex Mode

Each twisted pair port on the switch can operate in either half- or full duplex mode. The twisted pair ports are IEEE 802.3u-compliant and will Auto-Negotiate the duplex mode setting.

Note

In order for the switch to set the duplex mode for each port correctly, the end-nodes that you connect to the switch ports should also use Auto-Negotiation. Otherwise, a duplex mode mismatch can occur, affecting network performance. For further information, refer to **Duplex Mode** on page 17.

Maximum Distance

Each twisted pair port has a maximum operating distance of 100 m (328 feet).

Type of Cabling

For 10 Mbps operation, Category 3 or better 100 ohm shielded or unshielded twisted pair cabling is required. For 100 or 1000 Mbps operation, Category 5 and Enhanced Category 5 (5E) 100 ohm shielded or unshielded twisted pair cabling is required.

Auto-MDI

All five ports feature auto-MDI. They automatically configure themselves as either MDI or MDI-X. This feature allows you to use either straight-through or crossover twisted pair cables to connect devices to the ports.

LEDs The port LEDs on the front panel of the AT-GS905 switch display port status information. Each port has four LEDs.

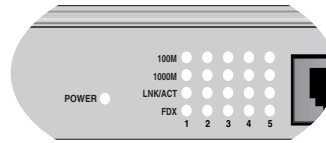

Figure 2 AT-GS905 Switch Port LEDs

Table 1 describes the AT-GS905 Gigabit Ethernet switch port LEDs.

Table 1 AT-GS905 Switch Port LEDs

LED	State	Description
POWER	Green	The switch is powered ON.
	OFF	The switch is powered OFF.
100M 1000M	Green	The port is operating at 100 Mbps.
	Green	The port is operating at 1000 Mbps.
	OFF	When both 100M and 1000M LEDs are OFF, the port is operating at 10 Mbps.
LNK/ACT	Green	A valid link has been established between the port and the end-node.
	Flashing Green	The port is transmitting and/or receiving data packets.
	OFF	There is no link established between the port and the end-node.
FDX	Green	The port is operating in full-duplex mode.
	OFF	The port is operating in half-duplex mode.

**AC Power
Connector**

AT-GS905 Gigabit Ethernet switch has a single AC power supply socket on the back panel, which has an autoswitch AC inputs. Refer to **Technical Specifications** on page 34, for the input voltage range. To power ON or OFF the switch, you connect or disconnect the power cord.

A Few Ethernet Switching Basics

An Ethernet switch interconnects network devices, such as workstations, printers, routers, and other Ethernet switches, so that they can communicate with each other by sending and receiving Ethernet frames.

MAC Address Table

Every hardware device on your network has a unique MAC address. This address is assigned to the device by the device's manufacturer. For example, when you install a Network Interface Card (NIC) in a computer so that you can connect it to the network, the NIC already has a MAC address assigned to it by its manufacturer.

The AT-GS905 Gigabit Ethernet switch can contain up to 4,000 entries on its MAC address table. The switch uses the table to store the MAC addresses of the network end-nodes connected to the ports, along with the port number on which each address was learned.

A switch learns the MAC addresses of the end-nodes by examining the source address of each packet received on a port. It adds the address and port on which the packet was received to the MAC table if the address had not already been entered in the table. The result is a table that contains all the MAC addresses of the devices that are connected to the switch's ports, and the port number where each address was learned.

When the switch receives a packet, it also examines the destination address and, by referring to its MAC address table, determines the port on which the destination end-node is connected. It then forwards the packet to the appropriate port and on to the end-node. This increases network bandwidth by limiting each frame to the appropriate port when the intended end-node is located, freeing the other switch ports for receiving and transmitting data.

If the switch receives a packet with a destination address that is not in the MAC address table, it floods the packet to all the ports on the switch. If the ports have been grouped into virtual LANs, the switch floods the packet only to those ports which belong to the same VLAN as the port on which the packet was received. This prevents packets from being forwarded into inappropriate LAN segments, increasing network security. When the destination end-node responds, the switch adds its MAC address and port number to the table.

If the switch receives a packet with a destination address that is on the same port on which the packet was received, it discards the packet without forwarding it on to any port. Since both the source end-node and the destination end-node for the packet are located on the same port on the switch, there is no reason for the switch to forward the packet.

Duplex Mode

Duplex mode refers to how an end-node receives and transmits data. If an end-node can receive or transmit data, but not both simultaneously, the end-node is operating in what is referred to as half-duplex mode. If an end-node can both receive and transmit data simultaneously, the end-node is said to be operating in full-duplex mode. Naturally, an end-node capable of operating in full-duplex can handle data much faster than an end-node that can only operate in half-duplex mode.

The twisted pair ports on the AT-GS905 switch can operate in half- or full-duplex mode for 10/100 Mbps and full-duplex for 1000 Mbps. They are IEEE 802.3u-compliant and use Auto-Negotiation to set the duplex mode setting for you automatically.

Store and Forward

This Gigabit Ethernet Switch uses store and forward as the method for receiving and transmitting frames. When a Ethernet frame is received on a switch port, the switch does not retransmit the frame out the destination port until it has received the entire frame and stored the frame in a port buffer. It then examines the frame to determine if it is a valid frame. Invalid frames, such as fragments or runts, are discarded by the switch. This insures that only valid frames are transmitted out the switch ports and that damaged frames are not propagated on your network.

Backpressure and Flow Control

To maintain the orderly movement of data between the end-nodes, an Ethernet switch may periodically need to signal an end-node to stop sending data. This can occur under several circumstances. For example, if two end-nodes are operating at different speeds, the switch, while transferring data between the end-nodes, might need to instruct the faster end-node to stop transmitting data to allow the slower end-node to catch up. An example of this would be when a server operating at 100 Mbps is sending data to a workstation operating at only 10 Mbps.

How a switch signals an end-node to stop transmitting data differs depending on the duplex mode of the end-node and switch port. A twisted pair port operating in half-duplex mode stops an end-node from transmitting data by forcing a collision. A collision on an Ethernet network occurs when two end-nodes attempt to transmit data using the same data link at the same time. A collision causes an end-node to stop sending data, wait for a brief period of time, and then retransmit the same data. Once the switch is ready to receive data again, the switch stops forcing collisions. This is referred to as backpressure.

A port operating in full-duplex mode uses PAUSE frames, as specified in the IEEE 802.3x standard, to stop the transmission of data from an end-node. Whenever the switch wants an end-node to stop transmitting data, it issues this frame. The frame instructs the end-node to cease transmission for a period of time specified within the frame. The switch continues to issue PAUSE frames until it is ready again to receive data from the end-node. This is referred to as flow control.

Network Topologies

This section illustrates two network topologies that you can create with the AT-GS905 Gigabit Ethernet switch: a power workgroup and collapsed backbone. Both types of topologies are described below.

Power Workgroup Topology

The topology shown in Figure 3 is commonly referred to as a power workgroup topology. Each workstation or end-node is connected directly to a port on the switch. Each end-node has a dedicated data link to the switch for best performance and reliability. The devices can operate at 10 Mbps, 100 Mbps or 1000 Mbps.

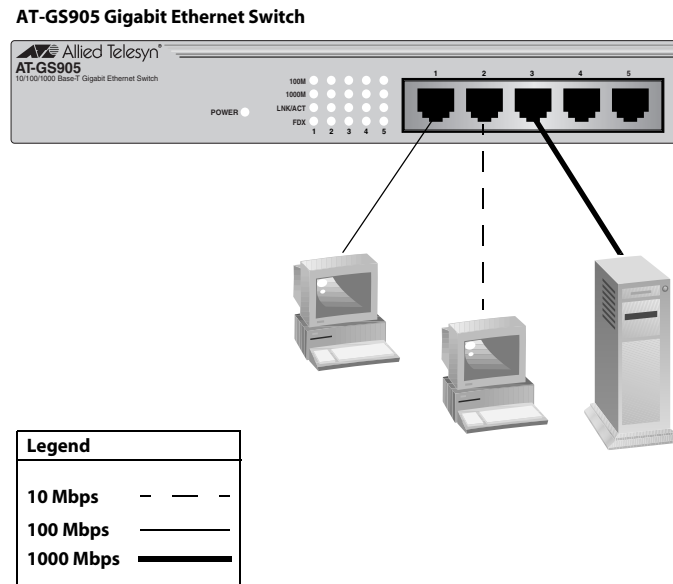

Figure 3 Power Workgroup Topology

Collapsed Backbone

In the topology illustrated in Figure 4, an AT-GS905 switch connects Fast Ethernet switches that have Gigabit Ethernet uplinks. This type of topology is often referred to as a collapsed backbone topology. The switch functions as the focal point of the network and transfers an Ethernet frame between the Fast Ethernet switches only when the

destination end-node for the frame is on a different switch than the end-node that originated the frame. This reduces the amount of unnecessary data traffic in each workgroup, freeing up bandwidth and improving network performance.

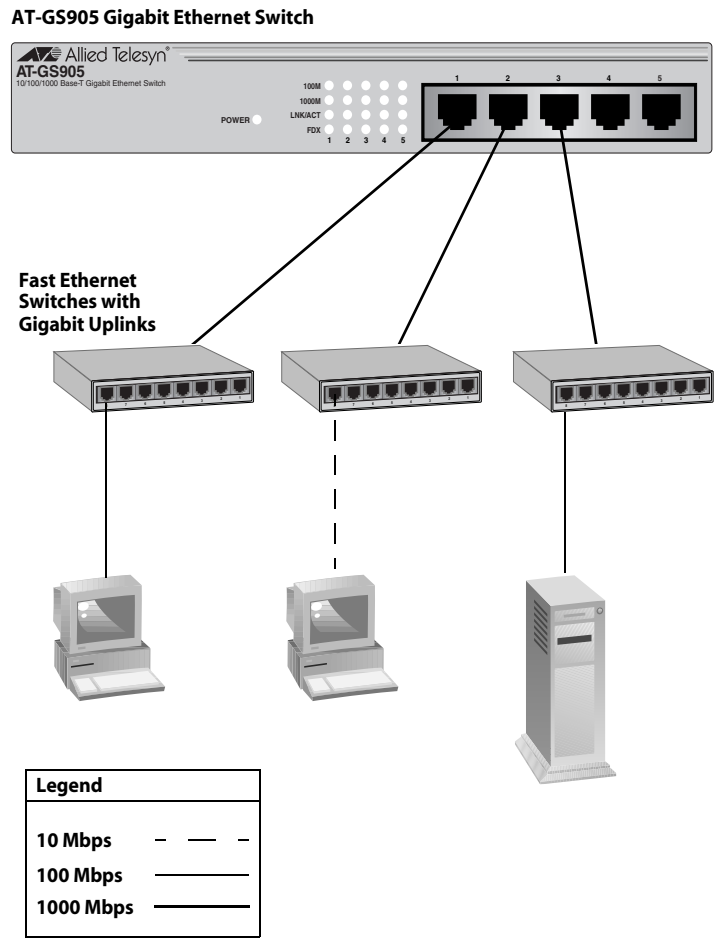

Figure 4 Collapsed Backbone - Hub Topology

Chapter 2

Installation

This chapter contains the following sections:

- ❑ **Reviewing Safety Precautions** on page 22
- ❑ **Selecting a Site for the Switch** on page 23
- ❑ **Planning the Installation** on page 24
- ❑ **Unpacking the Switch** on page 25
- ❑ **Using the Switch on a Desktop** on page 26
- ❑ **Wall- Mounting the Switch** on page 27
- ❑ **Warranty Registration** on page 31

Reviewing Safety Precautions

Please review the following safety precautions before you begin to install the switch or any of its components. Refer to on page 37 for translated safety statements in your language.

**Warning**

Electric Shock Hazard: To prevent electric shock, do not remove the cover. There are no user-serviceable parts inside. The unit contains hazardous voltages and should only be opened by a trained and qualified technician. *↪ 5*

**Warning**

Lightning Danger: Do not work on this equipment or cables during periods of lightning activity. *↪ 6*

**Caution**

Power cord is used as a disconnection device: To de-energize equipment, disconnect the power cord. *↪ 7*

**Warning**

Electrical-Type Class 1 Equipment: This equipment must be earthed. The power plug must be connected to a properly wired earth ground socket outlet. An improperly wired socket outlet could place hazardous voltages on accessible metal parts. *↪ 8*

**Caution**

Pluggable Equipment: The socket outlet should be installed near the equipment and should be easily accessible. *↪ 9*

**Caution**

Air vents: The air vents must not be blocked on the unit and must have free access to the room ambient air for cooling. *↪ 10*

**Caution**

Operating Temperature: This product is designed for a maximum ambient temperature of 40°C. *↪ 11*

**Caution**

All Countries: Install this product in accordance with local and National Electric Codes. *↪ 12*

Selecting a Site for the Switch

Observe the following requirements when choosing a site for your switch:

- If you plan to install the switch in an equipment rack, ensure that the rack is safely secured and that it will not tip over. Devices in a rack should be installed starting at the bottom, with the heavier devices near the bottom of the rack.
- If you are installing the switch on a table, ensure that the table is level and secure.
- The power outlet for the switch should be located near the unit and should be easily accessible.
- The site should provide for easy access to the ports on the front of the switch. This will make it easy for you to connect and disconnect cables, as well as view the switch's LEDs.
- To allow proper cooling of the switch, air flow around the unit and through its vents on the side and rear should not be restricted.
- Do not place objects on top of the switch.
- Do not expose the switch to moisture or water.
- Ensure that the site is a dust-free environment.
- You should use dedicated power circuits or power conditioners to supply reliable electrical power to the network devices.

Planning the Installation

Table 2 contains the cabling specifications for the twisted pair ports.

Table 2 Twisted Pair Cabling and Distances

Speed	Type of Cable	Maximum Operating Distance
10 Mbps	Category 3 or better 100-ohm shielded or unshielded twisted pair cable	100 m (328 ft)
100 Mbps	Category 5 or Category 5E (Enhanced) 100-ohm shielded or unshielded twisted pair cable	100 m (328 ft)
1000 Mbps	Category 5 and Category 5E (Enhanced) 100-ohm shielded or unshielded twisted pair cable	100 m (328 ft)

Note

The twisted pair ports on the switch feature Auto-MDI when operating at either 10 or 100 Mbps. Each port is individually configured as MDI or MDI-X when connected to an end-node. Consequently, you can use either a straight-through or crossover twisted pair cable when connecting any network device to a twisted pair port on the switch. A port operating at 10 or 100 Mbps uses two pairs of twisted pair wiring.

Note

Twisted pair ports operating at 1000 Mbps must use a straight-through cable. A port operating at 1000 Mbps uses four pairs of twisted pair wiring.

Unpacking the Switch

To unpack an AT-GS905 switch, perform the following procedure:

1. Remove all components from the shipping package.

Note

Store the packaging material in a safe location. You must use the original shipping material if you need to return the unit to Allied Telesyn.

2. Place the switch on a level, secure surface.
3. Ensure the following hardware components are included in your switch package. If any item is missing or damaged, contact your Allied Telesyn sales representative for assistance.

- One AT-GS905 Gigabit Ethernet Switch
- External AC/DC power adapter
- Four rubber protective feet
- Two drywall anchors
- Two mounting screws
- This installation guide
- Warranty card

Using the Switch on a Desktop

The AT-GS905 switch can be used on a desktop or mounted onto the wall. To wall-mount the switch, refer to **Wall-Mounting the Switch** on page 27.

To use the switch on a desktop, perform the following procedure:

1. Remove all equipment from the package and store the packaging material in a safe place.
2. Attach the four rubber protective feet (provided) to the bottom of the switch as shown in Figure 5.

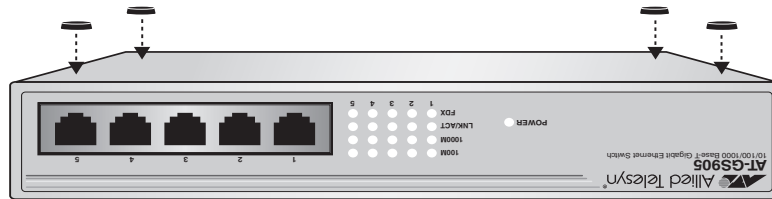

Figure 5 Attaching the Rubber Feet

3. Turn the switch over and place it on a flat, secure surface (such as a desk or table), leaving ample space around the unit for ventilation.

Wall- Mounting the Switch

The AT-GS905 switch can be used on a desktop or mounted onto a wall. To use the switch on a desktop, refer to **Using the Switch on a Desktop** on page 26.

To mount an AT-GS905 switch onto a wall, perform the following procedure:

1. Remove all equipment from the package and store the packaging material in a safe place.
2. Select a wall location for the switch.
3. Mark two hole locations (3-3/8 inches apart) on the wall.
4. At the two marked locations for the holes, pre-drill for the drywall anchors (provided) and drive the screws (provided) through the holes.
5. Align the switch horizontally, as illustrated in Figure 6.

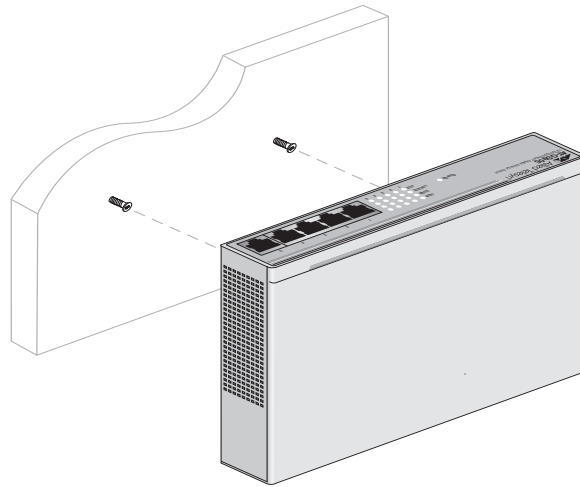

Figure 6 Aligning an AT-GS905 Switch For Wallmount Installation

6. Hang the switch onto the wall using the two keyhole slots located in the bottom of the unit, as illustrated in Figure 7.

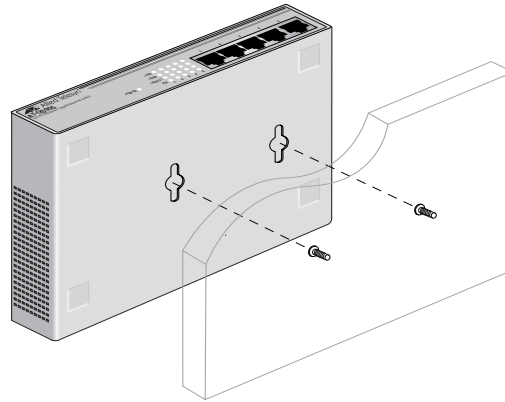

Figure 7 Wallmounting an AT-GS905 Switch

7. Make sure that the switch is securely mounted onto the wall.

Cabling the Switch

To connect to the ports on the AT-GS905 switch, perform the following procedure:

1. Connect the twisted pair data cables to the RJ-45 ports on the switch, as illustrated in Figure 8.

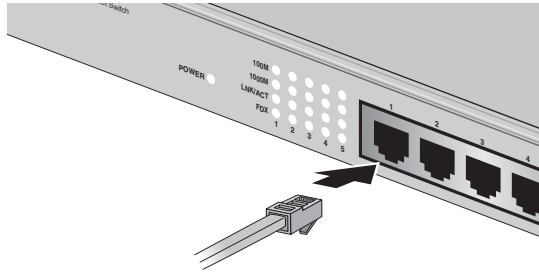

Figure 8 Connecting the Twisted Pair Data Cables

2. Power on the end-nodes. For more information, refer to **Powering On the Switch** on page 30.

When connecting a twisted pair cable to a port, observe the following guidelines:

- An RJ-45 connector should fit snugly into the port on the switch. The tab on the connector should lock the connector into place.
- The ports on the switch are auto-MDI/MDI-X. You can use either a straight-through or crossover twisted pair cable to connect any type of network device to a port on the switch.
- The network should not contain data loops, which can adversely affect network performance. A data loop exists when two or more network devices can communicate with each other over more than one data path.

Powering On the Switch

1. Apply AC power to the switch by plugging the power cord into the AC power connector on the back panel of the unit, as illustrated in Figure 9.

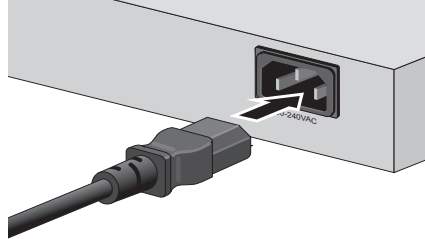

Figure 9 Connecting the AC Power Connector to Switch

2. Plug the other end of the power cord into a wall outlet.



Warning

The power cord is used as a disconnection device. To de-energize equipment, disconnect the power cord. *7*

3. Verify that the POWER LED is green. If the LED is OFF, refer to **Troubleshooting** on page 32.

The switch is ready for network operations.

Warranty Registration

After installing your switch, you can register your product by completing the enclosed warranty card and sending it to Allied Telesyn.

Chapter 3

Troubleshooting

This chapter contains information on how to troubleshoot the switch in the event that a problem occurs.

Note

If you are still unable to resolve the problem after following the instructions in this chapter, contact Allied Telesyn Technical Support for assistance. Refer to **Contacting Allied Telesyn** on page 9.

Check the PWR LED on the front of the switch. If the LED is OFF, indicating that the unit is not receiving power, do the following:

- Ensure that the power cord is securely connected to the power source and to the AC connector on the back panel of the switch.
- Verify that the power outlet has power by connecting another device to it.
- Try connecting the unit to another power source.
- Try using a different power cord.
- Verify that the voltage from the power source is within the required levels for your region.

Verify that the LNK/ACT LED for each port is ON. If a LNK/ACT LED is OFF, do the following:

- Verify that the end-node connected to the port is powered ON and is operating properly.
- Verify that the twisted pair cable is securely connected to the port on the switch and to the port on the end-node.
- Ensure that the twisted pair cable does not exceed 100 meters

(328 feet).

- Verify that you are using the appropriate category of twisted pair cable: Category 3 or better for 10 Mbps operation and Category 5 and Category 5E for 100 and 1000 Mbps operation.

Note

A 1000Base connection can take from five to ten seconds for the link to be established.

Appendix A

Technical Specifications

Physical Specifications

Dimensions:	(H x W x D) 3.5 cm x 20.1 cm x 14.4 cm (1.38 in x 7.93 in x 5.66 in)
Weight:	.97 kg (2.15 lbs)

Environmental Specifications

Operating Temperature:	0° C to 40° C (32° F to 104° F)
Storage Temperature:	-25° C to 70° C (-13° F to 158° F)
Operating Humidity:	5% to 90% non-condensing
Storage Humidity:	5% to 95% non-condensing
Operating Altitude Range:	Up to 10,000 feet (3,048 meters)

Power Specifications

Maximum Power Consumption:	16.5 watts
AC Input Electrical Ratings:	100 ~ 240 VAC, 0.3A
Frequency:	50/60 Hz

Safety and Electromagnetic Emissions Certifications

Safety:	EN60950 (TUV), UL60950 (cUL-us), CE
EMI:	FCC Class B, EN55022 Class B, VCCI Class B, C-TICK
Immunity:	EN55024
Quality and Reliability:	MTBF – 558,000 hours

Connectors

This section lists the connectors and connector pinouts for the AT-GS905 Gigabit Ethernet switch and its components.

RJ-45 Twisted Pair Port Pinouts

Figure 10 illustrates the pin layout to an RJ-45 connector and port.

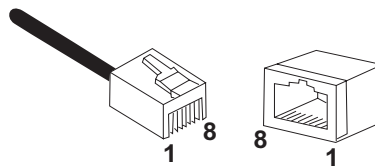

Figure 10 RJ-45 Connector and Port Pin Layout

Table 3 lists the RJ-45 pin signals when a twisted pair port is operating in the MDI configuration.

Table 3 MDI Pin Signals (10Base-T or 100Base-TX)

Pin	Signal
1	TX+
2	TX-
3	RX+
6	RX-

Table 4 lists the RJ-45 port pin signals when a twisted pair port is operating in the MDI-X configuration.

Table 4 MDI-X Pin Signals (10Base-T or 100Base-TX)

Pin	Signal
1	RX+
2	RX-
3	TX+
6	TX-

Table 5 lists the RJ-45 connector pins and their signals when a 1000Base-T port is operating at 1000 Mbps.

Table 5 RJ-45 1000Base-T Connector Pinouts¹

Pin	Pair	Signal
1	1	TX and RX+
2	1	TX and RX-
3	2	TX and RX+
4	3	TX and RX+
5	3	TX and RX-
6	2	TX and RX-
7	4	TX and RX+
8	4	TX and RX-

1. Bi-directional data on each pair.

Appendix B

Translated Electrical Safety and Emission Information

Important: This appendix contains multiple-language translations for the safety statements in this guide.

Wichtig: Dieser Anhang enthält Übersetzungen der in diesem Handbuch enthaltenen Sicherheitshinweise in mehreren Sprachen.

Vigtigt: Dette tillæg indeholder oversættelser i flere sprog af sikkerhedsadvarslerne i denne håndbog.

Belangrijk: Deze appendix bevat vertalingen in meerdere talen van de veiligheidsopmerkingen in deze gids.

Important: Cette annexe contient la traduction en plusieurs langues des instructions de sécurité figurant dans ce guide.

Tärkeää: Tämä liite sisältää tässä oppaassa esiintyvät turvaohjeet usealla kielellä.

Importante: questa appendice contiene traduzioni in più lingue degli avvisi di sicurezza di questa guida.

Viktig: Dette tillegget inneholder oversettelser til flere språk av sikkerhetsinformasjonen i denne veiledningen.

Importante: Este anexo contém traduções em vários idiomas das advertências de segurança neste guia.

Importante: Este apéndice contiene traducciones en múltiples idiomas de los mensajes de seguridad incluidos en esta guía.







Obs! Denna bilaga innehåller flerspråkiga översättningar av säkerhetsmeddelandena i denna handledning.

Standards: This product meets the following standards.

U.S. Federal Communications Commission	
Declaration Of Conformity	
Manufacturer Name:	Allied Telesyn, Inc.
Manufacturer Address:	960 Stewart Drive, Suite B Sunnyvale, CA 94085 USA
Manufacturer Telephone:	408-730-0950
Declares that the product:	Gigabit Ethernet Switch
Model Numbers:	AT-GS905
This product complies with FCC Part 15B, Class B Limits:	
This device complies with part 15 of the FCC Rules. Operation is subject to the following two conditions: (1) This device must not cause harmful interference, and (2) this device must accept any interference received, including interference that may cause undesired operation.	
Radiated Energy	
Note: This equipment has been tested and found to comply with the limits for a Class B digital device pursuant to Part 15 of FCC Rules. These limits are designed to provide reasonable protection against harmful interference in a residential installation. This equipment generates, uses and can radiate radio frequency energy and, if not installed and used in accordance with instructions, may cause harmful interference to radio or television reception, which can be determined by turning the equipment off and on. The user is encouraged to try to correct the interference by one or more of the following measures:	
<ul style="list-style-type: none"> - Reorient or relocate the receiving antenna. - Increase the separation between the equipment and the receiver. - Connect the equipment into an outlet on a circuit different from that to which the receiver is connected. - Consult the dealer or an experienced radio/TV technician for help. 	
Changes and modifications not expressly approved by the manufacturer or registrant of this equipment can void your authority to operate this equipment under Federal Communications Commission rules.	

Canadian Department of Communications	
This Class B digital apparatus meets all requirements of the Canadian Interference-Causing Equipment Regulations.	
Cet appareil numérique de la classe A respecte toutes les exigences du Règlement sur le matériel brouilleur du Canada.	

- | | | |
|---------------|---|--|
| 🌀 1 | RFI Emission | FCC Class B, EN55022 Class B, VCCI Class B, C-TICK |
| 🌀 2 | ⚠️ WARNING: In a domestic environment this product may cause radio interference in which case the user may be required to take adequate measures. | |
| 🌀 3 | Immunity | EN55024 |
| 🌀 4 | Electrical Safety | EN60950 (TUV), UL60950 (cUL-us), CE |
| SAFETY | | |
| 🌀 5 | ⚠️ ELECTRICAL NOTICES
WARNING: ELECTRIC SHOCK HAZARD
To prevent ELECTRIC shock, do not remove the cover. No user-serviceable parts inside. This unit contains HAZARDOUS VOLTAGES and should only be opened by a trained and qualified technician. To avoid the possibility of ELECTRIC SHOCK, disconnect electric power to the product before connecting or disconnecting the LAN cables. | |

- 6  **LIGHTNING DANGER**
DANGER: DO NOT WORK on equipment or CABLES during periods of LIGHTNING ACTIVITY.
- 7  **CAUTION:** POWER CORD IS USED AS A DISCONNECTION DEVICE. TO DE-ENERGIZE EQUIPMENT, disconnect the power cord.
- 8  **ELECTRICAL - TYPE CLASS 1 EQUIPMENT**
THIS EQUIPMENT MUST BE EARTHED. Power plug must be connected to a properly wired earth ground socket outlet. An improperly wired socket outlet could place hazardous voltages on accessible metal parts.
- 9  **PLUGGABLE EQUIPMENT:** The socket outlet shall be installed near the equipment and shall be easily accessible.
- 10  **CAUTION:** Air vents must not be blocked and must have free access to the room ambient air for cooling.
- 11  **OPERATING TEMPERATURE:** This product is designed for a maximum ambient temperature of 40° degrees C.
- 12  **ALL COUNTRIES:** Install product in accordance with local and National Electrical Codes.

Normen: Dieses Produkt erfüllt die Anforderungen der nachfolgenden Normen.

- 1 **Hochfrequenzstörung** FCC Klasse B, EN55022 Klasse B, VCCI Class B, C-TICK
- 2 **⚠️ WARNUNG:** Bei Verwendung zu Hause kann dieses Produkt Funkstörungen hervorrufen. In diesem Fall müßte der Anwender angemessene Gegenmaßnahmen ergreifen.
- 3 **Störsicherheit** EN55024
- 4 **Elektrische Sicherheit** EN60950 (TUV), UL60950 (cUL-us), CE

SICHERHEIT

- 5 **⚠️ ACHTUNG: GEFÄHRLICHE SPANNUNG**
Das Gehäuse nicht öffnen. Das Gerät enthält keine vom Benutzer wartbaren Teile. Das Gerät steht unter Hochspannung und darf nur von qualifiziertem technischem Personal geöffnet werden. Vor Anschluß der LAN-Kabel, Gerät vom Netz trennen.
- 6 **⚠️ GEFAHR DURCH BLITZSCHLAG**
GEFAHR: Keine Arbeiten am Gerät oder an den Kabeln während eines Gewitters ausführen.
- 7 **⚠️ VORSICHT: DAS NETZKABEL DIEN ZUM TRENNEN DER STROMVERSORGUNG. ZUR TRENNUNG VOM NETZ, KABEL AUS DER STECKDOSE ZIEHEN.**
- 8 **⚠️ GERÄTE DER KLASSE 1**
DIESE GERÄTE MÜSSEN GEERDET SEIN. Der Netzstecker darf nur mit einer vorschriftsmäßig geerdeten Steckdose verbunden werden. Ein unvorschriftsmäßiger Anschluß kann die Metallteile des Gehäuses unter gefährliche elektrische Spannungen setzen.
- 9 **⚠️ STECKBARES GERÄT:** Die Anschlußbuchse sollte in der Nähe der Einrichtung angebracht werden und leicht zugänglich sein."
- 10 **⚠️ VORSICHT:** Die Entlüftungsöffnungen dürfen nicht versperrt sein und müssen zum Kühlen freien Zugang zur Raumluft haben.
- 11 **⚠️ BETRIEBSTEMPERATUR:** Dieses Produkt wurde für den Betrieb in einer Umgebungstemperatur von nicht mehr als 40° C entworfen.
- 12 **⚠️ ALLE LÄNDER:** Installation muß örtlichen und nationalen elektrischen Vorschriften entsprechen.

Standarder: Dette produkt tilfredsstiller de følgende standarder.

- ⌘ **1 Radiofrekvens forstyrrelsesemission**

FCC Klasse B, EN55022 Klasse B,
VCCI Class B, C-TICK
- ⌘ **2 ⚠ ADVARSEL:** I et hjemligt miljø kunne dette produkt forårsage radio forstyrrelse. Bliver det tilfældet, påkræves brugeren muligvis at tage tilstrækkelige foranstaltninger.
- ⌘ **3 Immunitet**

EN55024
- ⌘ **4 Elektrisk sikkerhed**

EN60950 (TUV), UL60950 (cUL-us), CE
- SIKKERHED**
- ⌘ **5 ⚠ ELEKTRISKE FORHOLDSREGLER**
ADVARSEL: RISIKO FOR ELEKTRISK STØD
 For at forebygge ELEKTRISK stød, undlad at åbne apparatet. Der er ingen indre dele, der kan repareres af brugeren. Denne enhed indeholder LIVSFARLIGE STRØMSPÆNDINGER og bør kun åbnes af en uddannet og kvalificeret tekniker. For at undgå risiko for ELEKTRISK STØD, afbrydes den elektriske strøm til produktet, før LAN-kablerne monteres eller afmonteres.
- ⌘ **6 ⚠ FARE UNDER UVEJR**
FARE: UNDLAD at arbejde på udstyr eller KABLER i perioder med LYNAKTIVITET.
- ⌘ **7 ⚠ ADVARSEL: DEN STRØMFØRENDE LEDNING BRUGES TIL AT AFBRYDE STRØMMEN.** SKAL STRØMMEN TIL APPARATET AFBRYDES, tages ledningen ud af stikket.
- ⌘ **8 ⚠ ELEKTRISK - KLASSE 1-UDSTYR**
 DETTE UDS TYR KRÆVER JORDFORBINDELSE. Stikket skal være forbundet med en korrekt installeret jordforbunden stikkontakt. En ukorrekt installeret stikkontakt kan sætte livsfarlig spænding til tilgængelige metaldele.
- ⌘ **9 ⚠ UDS TYR TIL STIKKONTAKT:** Stikkontakten bør installeres nær ved udstyret og skal være lettilgængelig.
- ⌘ **10 ⚠ ADVARSEL:** Ventilationsåbninger må ikke blokeres og skal have fri adgang til den omgivende luft i rummet for afkøling.
- ⌘ **11 ⚠ BETJENINGSTEMPERATUR:** Dette apparat er konstrueret til en omgivende temperatur på maksimum 40 grader C.
- ⌘ **12 ⚠ ALLE LANDE:** Installation af produktet skal ske i overensstemmelse med lokal og national lovgivning for elektriske installationer.









Eisen: Dit product voldoet aan de volgende eisen.

- 1 **RFI Emissie** FCC Klasse B, EN55022 Klasse B, VCCI Class B, C-TICK
- 2 **WAARSCHUWING:** Binnenshuis kan dit product radiostoring veroorzaken, in welk geval de gebruiker verplicht kan worden om gepaste maatregelen te nemen.
- 3 **Immuniteit** EN55024
- 4 **Electrische Veiligheid** EN60950 (TUV), UL60950 (cUL-us), CE

VEILIGHEID

- 5 **WAARSCHUWINGEN MET BETREKKING TOT ELEKTRICITEIT**
WAARSCHUWING: GEVAAR VOOR ELEKTRISCHE SCHOKKEN
Verwijder het deksel niet, teneinde ELEKTRISCHE schokken te voorkomen. Binnenin bevinden zich geen onderdelen die door de gebruiker onderhouden kunnen worden. Dit toestel staat onder GEVAARLIJKE SPANNING en mag alleen worden geopend door een daartoe opgeleide en bevoegde technicus. Om het gevaar op ELEKTRISCHE SCHOKKEN te vermijden, moet u het toestel van de stroombron ontkoppelen alvorens de LAN-kabels te koppelen of ontkoppelen.
- 6 **GEVAAR VOOR BLIKSEMINSLAG**
GEVAAR: NIET aan toestellen of KABELS WERKEN bij BLIKSEM.
- 7 **WAARSCHUWING:** HET TOESTEL WORDT UITGESCHAKELD DOOR DE STROOMKABEL TE ONTKOPPELEN. OM HET TOESTEL STROOMLOOS TE MAKEN: de stroomkabel ontkoppelen.
- 8 **ELEKTRISCHE TOESTELLEN VAN KLASSE 1**
DIT TOESTEL MOET GEAARD WORDEN. De stekker moet aangesloten zijn op een juist gearde contactdoos. Een onjuist gearde contactdoos kan de metalen onderdelen waarmee de gebruiker eventueel in aanraking komt onder gevaarlijke spanning stellen.
- 9 **AAN TE SLUITEN APPARATUUR:** De contactdoos wordt in de nabijheid van de apparatuur geïnstalleerd en is gemakkelijk te bereiken."
- 10 **OPGELET:** De ventilatiegaten mogen niet worden gesperd en moeten de omgevingslucht ongehinderd toelaten voor afkoeling.
- 11 **BEDRIJFSTEMPERATUUR:** De omgevingstemperatuur voor dit produkt mag niet meer bedragen dan 40 graden Celsius.
- 12 **ALLE LANDEN:** het toestel installeren overeenkomstig de lokale en nationale elektrische voorschriften.

Normes: ce produit est conforme aux normes de suivantes:

- 🌀 1 **Emission d'interférences radioélectriques**
 FCC Classe B, EN55022 Classe B,
 VCCI Class B, C-TICK
- 🌀 2  **MISE EN GARDE** : dans un environnement domestique, ce produit peut provoquer des interférences radioélectriques. Auquel cas, l'utilisateur devra prendre les mesures adéquates.
- 🌀 3 **Immunité** EN55024
- 🌀 4 **Sécurité électrique** EN60950 (TUV), UL60950 (cUL-us), CE
- SÉCURITÉ**
- 🌀 5  **INFORMATION SUR LES RISQUES ÉLECTRIQUES**
AVERTISSEMENT: DANGER D'ÉLECTROCUTION
 Pour éviter toute ÉLECTROCUTION, ne pas ôter le revêtement protecteur du matériel. Ce matériel ne contient aucun élément réparable par l'utilisateur. Il comprend des TENSIONS DANGEREUSES et ne doit être ouvert que par un technicien dûment qualifié. Pour éviter tout risque d'ÉLECTROCUTION, débrancher le matériel avant de connecter ou de déconnecter les câbles LAN.
- 🌀 6  **DANGER DE FOUDRE**
DANGER: NE PAS MANIER le matériel ou les CÂBLES lors d'activité orageuse.
- 🌀 7  **ATTENTION: LE CORDON D'ALIMENTATION SERT DE MISE HORS CIRCUIT. POUR COUPER L'ALIMENTATION DU MATÉRIEL,** débrancher le cordon.
- 🌀 8  **ÉQUIPEMENT DE CLASSE 1 ÉLECTRIQUE**
 CE MATÉRIEL DOIT ÊTRE MIS A LA TERRE. La prise de courant doit être branchée dans une prise femelle correctement mise à la terre car des tensions dangereuses risqueraient d'atteindre les pièces métalliques accessibles à l'utilisateur.
- 🌀 9  **EQUIPEMENT POUR BRANCHEMENT ELECTRIQUE:** La prise de sortie doit être placée près de l'équipement et facilement accessible".
- 🌀 10  **ATTENTION:** Ne pas bloquer les fentes d'aération, ceci empêcherait l'air ambiant de circuler librement pour le refroidissement.
- 🌀 11  **TEMPÉRATURE DE FONCTIONNEMENT:** Ce matériel est capable de tolérer une température ambiante maximum de ou 40 degrés Celsius.
- 🌀 12  **POUR TOUS PAYS:** Installer le matériel conformément aux normes électriques nationales et locales.

Standardit: Tämä tuote on seuraavien standardien mukainen.

- 1 **Radioaaltojen häirintä** FCC Luokka B, EN55022 Luokka B, VCCI Class B, C-TICK
- 2 **VAROITUS:** Kotiolosuhteissa tämä laite voi aiheuttaa radioaaltojen häirintää, missä tapauksessa laitteen käyttäjän on mahdollisesti ryhdyttävä tarpeellisiin toimenpiteisiin.
- 3 **Kestävyys** EN55024
- 4 **Sähköturvallisuus** EN60950 (TUV), UL60950 (cUL-us), CE









TURVALLISUUS

- 5 **SÄHKÖÖN LIITTYVIÄ HUOMAUTUKSIA**
VAROITUS: SÄHKÖISKUVAARA
Estääksesi SÄHKÖISKUN älä poista kantta. Sisällä ei ole käyttäjän huollettavissa olevia osia. Tämä laite sisältää VAARALLISIA JÄNNITTEITÄ ja sen voi avata vain koulutettu ja pätevä teknikko. Välttääksesi SÄHKÖISKUN mahdollisuuden katkaise sähkövirta tuotteeseen ennen kuin liität tai irrotat paikallisverkon (LAN) kaapelit.
- 6 **SALAMANISKUVAARA**
HENGENVAARA: ÄLÄ TYÖSKENTELE laitteiden tai KAAPELEIDEN KANSSA SALAMOINNIN AIKANA.
- 7 **HUOMAUTUS: VIRTAJOHTOA KÄYTETÄÄN** VIRRANKATKAISULAITTEENA. VIRTA KATKAISTAAN irrottamalla virtajohto.
- 8 **SÄHKÖ - TYYPPILUOKAN 1 LAITTEET**
TÄMÄ LAITE TÄYTY MAADOITTA. Pistoke täytyy liittää kunnollisesti maadoitettuun pistorasiaan. Virheellisesti johdotettu pistorasia voi altistaa metalliosat vaarallisille jännitteille.
- 9 **PISTORASIAAN KYTKETTÄVÄ LAITE:** Pistorasia on asennettava laitteen lähelle ja siihen on oltava esteetön pääsy."
- 10 **HUOMAUTUS:** Ilmavaihtoreikiä ei pidä tukkia ja niillä täytyy olla vapaa yhteys ympäröivään huoneilmaan, jotta ilmanvaihto tapahtuisi.
- 11 **KÄYTTÖLÄMPÖTILA:** Tämä tuote on suunniteltu ympäröivän ilman maksimilämpötilalle 40°C.
- 12 **KAIKKI MAAT:** Asenna tuote paikallisten ja kansallisten sähköturvallisuusmääräysten mukaisesti.

Standard: Questo prodotto è conforme ai seguenti standard.

- 🌀
1 Emissione RFI (interferenza di radiofrequenza)
FCC Classe B, EN55022 Classe B,
VCCI Class B, C-TICK
- 🌀

2 AVVERTENZA: in ambiente domestico questo prodotto potrebbe causare radio interferenza. In questo caso potrebbe richiedersi all'utente di prendere gli adeguati provvedimenti.
- 🌀
3 Immunità EN55024
- 🌀
4 Sicurezza elettrica EN60950 (TUV), UL60950 (cUL-us), CE

NORME DI SICUREZZA

- 🌀

5 AVVERTENZE ELETTRICHE
ATTENZIONE: PERICOLO DI SCOSSE ELETTRICHE
 Per evitare SCOSSE ELETTRICHE non asportare il coperchio. Le componenti interne non sono riparabili dall'utente. Questa unità ha TENSIONI PERICOLOSE e va aperta solamente da un tecnico specializzato e qualificato. Per evitare ogni possibilità di SCOSSE ELETTRICHE, interrompere l'alimentazione del dispositivo prima di collegare o staccare i cavi LAN.
- 🌀

6 PERICOLO DI FULMINI
PERICOLO: NON LAVORARE sul dispositivo o sui CAVI durante PRECIPITAZIONI TEMPORALESCHES.
- 🌀

7 ATTENZIONE: IL CAVO DI ALIMENTAZIONE È USATO COME DISPOSITIVO DI DISATTIVAZIONE. PER TOGLIERE LA CORRENTE AL DISPOSITIVO staccare il cavo di alimentazione.
- 🌀

8 ELETTICITÀ - DISPOSITIVI DI CLASSE 1
 QUESTO DISPOSITIVO DEVE AVERE LA MESSA A TERRA. La spina deve essere inserita in una presa di corrente specificamente dotata di messa a terra. Una presa non cablata in maniera corretta rischia di scaricare una tensione pericolosa su parti metalliche accessibili.
- 🌀

9 APPARECCHIATURA COLLEGABILE: La presa va installata vicino all'apparecchio per risultare facilmente accessibile".
- 🌀

10 ATTENZIONE: le prese d'aria non vanno ostruite e devono consentire il libero ricircolo dell'aria ambiente per il raffreddamento.
- 🌀

11 TEMPERATURA DI FUNZIONAMENTO: Questo prodotto è concepito per una temperatura ambientale massima di 40 gradi centigradi.
- 🌀

12 TUTTI I PAESI: Installare il prodotto in conformità delle vigenti normative elettriche nazionali.

Sikkerhetsnormer: Dette produktet tilfredsstiller følgende sikkerhetsnormer.

- 1 **RFI stråling** FCC Klasse B, EN55022 Klasse B, VCCI Class B, C-TICK
- 2 **ADVARSEL:** Hvis dette produktet benyttes til privat bruk, kan produktet forårsake radioforstyrrelse. Hvis dette skjer, må brukeren ta de nødvendige forholdsregler.
- 3 **Immunitet** EN55024
- 4 **Elektrisk sikkerhet** EN60950 (TUV), UL60950 (cUL-us), CE

SIKKERHET

- 5 **ELEKTRISITET**
ADVARSEL: FARE FOR ELEKTRISK SJOKK
For å unngå ELEKTRISK sjokk, må dekslet ikke tas av. Det finnes ingen deler som brukeren kan reparere på innsiden. Denne enheten inneholder FARLIGE SPENNINGER, og må kun åpnes av en faglig kvalifisert tekniker. For å unngå ELEKTRISK SJOKK må den elektriske strømmen til produktet være avslått før LAN-kablene til- eller frakobles.
- 6 **FARE FOR LYNNEDSLAG**
FARE: ARBEID IKKE på utstyr eller KABLER i TORDENVÆR.
- 7 **FORSIKTIG: STRØMLEDNINGEN BRUKES TIL Å FRAKOBLE UTSTYRET. FOR Å DEAKTIVISERE UTSTYRET, må strømforsyningen kobles fra.**
- 8 **ELEKTRISK - TYPE 1- KLASSE UTSTYR**
DETTE UTSTYRET MÅ JORDES. Strømkontakten må være tilkopleet en korrekt jordet kontakt. En kontakt som ikke er korrekt jordet kan føre til farlig spenninger i lett tilgjengelige metalleder.
- 9 **UTSTYR FOR STIKKONTAKT:** Stikkontakten skal monteres i nærheten av utstyret og skal være lett tilgjengelig."
- 10 **FORSIKTIG:** Lufteventilene må ikke blokkeres, og må ha fri tilgang til luft med romtemperatur for avkjøling.
- 11 **DRIFTSTEMPERATUR:** Dette produktet er konstruert for bruk i maksimum romtemperatur på 40 grader celsius.
- 12 **ALLE LAND:** Produktet må installeres i samsvar med de lokale og nasjonale elektriske koder.

Padrões: Este produto atende aos seguintes padrões.

- 🌀
1 Emissão de interferência de radiofrequência
FCC Classe B, EN55022 Classe B,
VCCI Class B, C-TICK
- 🌀
⚠️
2 AVISO: Num ambiente doméstico este produto pode causar interferência na radiorrecepção e, neste caso, pode ser necessário que o utente tome as medidas adequadas.
- 🌀
3 Imunidade EN55024
- 🌀
4 Segurança Eléctrica EN60950 (TUV), UL60950 (UL-US), CE

SEGURANÇA

- 🌀
⚠️
5 AVISOS SOBRE CARACTERÍSTICAS ELÉTRICAS
ATENÇÃO: PERIGO DE CHOQUE ELÉTRICO
 Para evitar CHOQUE ELÉTRICO, não retire a tampa. Não contém peças que possam ser consertadas pelo usuário. Este aparelho contém VOLTAGENS PERIGOSAS e só deve ser aberto por um técnico qualificado e treinado. Para evitar a possibilidade de CHOQUE ELÉTRICO, desconecte o aparelho da fonte de energia elétrica antes de conectar e desconectar os cabos da LAN.
- 🌀
⚠️
6 PERIGO DE CHOQUE CAUSADO POR RAIOS
PERIGO: NÃO TRABALHE no equipamento ou nos CABOS durante períodos suscetíveis a QUEDAS DE RAIOS.
- 🌀
⚠️
7 CUIDADO: O CABO DE ALIMENTAÇÃO É UTILIZADO COMO UM DISPOSITIVO DE DESCONEXÃO. PARA DESELETRIFICAR O EQUIPAMENTO, desconecte o cabo de ALIMENTAÇÃO.
- 🌀
⚠️
8 ELÉTRICO - EQUIPAMENTOS DO TIPO CLASSE 1
 DEVE SER FEITA LIGAÇÃO DE FIO TERRA PARA ESTE EQUIPAMENTO. O plugue de alimentação deve ser conectado a uma tomada com adequada ligação de fio terra. Tomadas sem adequada ligação de fio terra podem transmitir voltagens perigosas a peças metálicas expostas.
- 🌀
⚠️
9 EQUIPAMENTO DE LIGAÇÃO: A tomada eléctrica deve estar instalada perto do equipamento e ser de fácil acesso."
- 🌀
⚠️
10 CUIDADO: As aberturas de ventilação não devem ser bloqueadas e devem ter acesso livre ao ar ambiente para arrefecimento adequado do aparelho.
- 🌀
⚠️
11 TEMPERATURA DE FUNCIONAMENTO: Este produto foi projetado para uma temperatura ambiente máxima de 40 graus centígrados.
- 🌀
⚠️
12 TODOS OS PAÍSES: Instale o produto de acordo com as normas nacionais e locais para instalações eléctricas.

Estándares: Este producto cumple con los siguientes estándares.

- 1 **Emisión RFI** FCC Clase B, EN55022 Clase B, VCCI Class B, C-TICK
- 2 **ADVERTENCIA:** en un entorno doméstico, este producto puede causar radiointerferencias, en cuyo caso, puede requerirse del usuario que tome las medidas que sean convenientes al respecto.
- 3 **Inmunidad** EN55024
- 4 **Seguridad eléctrica** EN60950 (TUV), UL60950 (cUL-us), CE









SEGURIDAD

- 5 **AVISOS ELECTRICOS**
ADVERTENCIA: PELIGRO DE ELECTROCHOQUE
Para evitar un ELECTROCHOQUE, no quite la tapa. No hay ningún componente en el interior al cual puede prestar servicio el usuario. Esta unidad contiene VOLTAJES PELIGROSOS y sólo deberá abrirla un técnico entrenado y calificado. Para evitar la posibilidad de ELECTROCHOQUE desconecte la corriente eléctrica que llega al producto antes de conectar o desconectar los cables LAN.
- 6 **PELIGRO DE RAYOS**
PELIGRO: NO REALICE NINGUN TIPO DE TRABAJO O CONEXION en los equipos o en LOS CABLES durante TORMENTAS ELECTRICAS.
- 7 **ATENCION: EL CABLE DE ALIMENTACION SE USA COMO UN DISPOSITIVO DE DESCONEXION.** PARA DESACTIVAR EL EQUIPO, desconecte el cable de alimentación.
- 8 **ELECTRICO - EQUIPO DEL TIPO CLASE 1**
ESTE EQUIPO TIENE QUE TENER CONEXION A TIERRA. El cable tiene que conectarse a un enchufe a tierra debidamente instalado. Un enchufe que no está correctamente instalado podría ocasionar tensiones peligrosas en las partes metálicas que están expuestas.
- 9 **EQUIPO CONECTABLE:** El tomacorriente se debe instalar cerca del equipo, en un lugar con acceso fácil".
- 10 **ATENCION:** Las aberturas para ventilación no deberán bloquearse y deberán tener acceso libre al aire ambiental de la sala para su enfriamiento.
- 11 **TEMPERATURA REQUERIDA PARA LA OPERACIÓN:** Este producto está diseñado para una temperatura ambiental máxima de 40 grados C.
- 12 **PARA TODOS LOS PAÍSES:** Monte el producto de acuerdo con los Códigos Eléctricos locales y nacionales.

Standarder: Denna produkt uppfyller följande standarder.

- ☞ 1 **Radiostörning** FCC Klass B, EN55022 Klass B, VCCI Class B, C-TICK
- ☞ 2  **VARNING:** Denna produkt kan ge upphov till radiostörningar i hemmet, vilket kan tvinga användaren till att vidtaga erforderliga åtgärder.
- ☞ 3 **Immunitet** EN55024
- ☞ 4 **Elsäkerhet** EN60950 (TUV), UL60950 (cUL_{us}), CE

SÄKERHET

- ☞ 5  **TILLKÄNNAGIVANDEN BETRÄFFANDE ELEKTRICITETSRIK:**
RISK FÖR ELEKTRISK STÖT För att undvika ELEKTRISK stöt, ta ej av locket. Det finns inga delar inuti som behöver underhållas. Denna apparat är under HÖGSPÄNNING och får endast öppnas av en utbildad kvalificerad tekniker. För att undvika ELEKTRISK STÖT, koppla ifrån produktens strömanslutning innan LAN-kablarna ansluts eller kopplas ur.
- ☞ 6  **FARA FÖR BLIXTNEDSLAG**
FARA: ARBETA EJ på utrustningen eller kablarna vid ÅSKVÄDER.
- ☞ 7  **VARNING: NÄTKABELN ANVÄNDS SOM STRÖMBRYTARE FÖR ATT KOPPLA FRÅN STRÖMMEN,** dra ur nätkabeln.
- ☞ 8  **ELEKTRISKT - TYP KLASS 1 UTRUSTNING**
DENNA UTRUSTNING MÅSTE VARA JORDAD. Nätkabeln måste vara ansluten till ett ordentligt jordat uttag. Ett felaktigt uttag kan göra att närliggande metalldelar utsätts för högspänning. Apparaten skall anslutas till jordat uttag, när den ansluts till ett nätverk.
- ☞ 9  **UTRUSTNING MED PLUGG:** Uttaget skall installeras i utrustningens närhet och vara lättåtkomligt".
- ☞ 10  **VARNING:** Luftventilerna får ej blockeras och måste ha fri tillgång till omgivande rumsluft för avsvälning.
- ☞ 11  **DRIFTSTEMPERATUR:** Denna produkt är konstruerad för rumstemperatur ej överstigande 40 grader Celsius.
- ☞ 12  **ALLA LÄNDER:** Installera produkten i enlighet med lokala och statliga bestämmelser för elektrisk utrustning.