

Gigabit Ethernet Switch

AT-GS924GB



Installation Guide



Simply connecting the  world



Copyright © 2003 Allied Telesyn, Inc.
960 Stewart Drive Suite B, Sunnyvale, CA 94085 USA

All rights reserved. No part of this publication may be reproduced without prior written permission from Allied Telesyn, Inc.

All other product names, company names, logos or other designations mentioned herein are trademarks or registered trademarks of their respective owners.

Allied Telesyn, Inc. reserves the right to make changes in specifications and other information contained in this document without prior written notice. The information provided herein is subject to change without notice. In no event shall Allied Telesyn, Inc. be liable for any incidental, special, indirect, or consequential damages whatsoever, including but not limited to lost profits, arising out of or related to this manual or the information contained herein, even if Allied Telesyn, Inc. has been advised of, known, or should have known, the possibility of such damages.

Electrical Safety and Emission Statement

Standards: This product meets the following standards.

U.S. Federal Communications Commission

RADIATED ENERGY

Note: This equipment has been tested and found to comply with the limits for a Class A digital device pursuant to Part 15 of the FCC Rules. These limits are designed to provide reasonable protection against harmful interference when the equipment is operated in a commercial environment. This equipment generates, uses, and can radiate radio frequency energy and, if not installed and used in accordance with this instruction manual, may cause harmful interference to radio communications. Operation of this equipment in a residential area is likely to cause harmful interference in which case the user will be required to correct the interference at his own expense.

Note: Modifications or changes not expressly approved by the manufacturer or the FCC can void your right to operate this equipment.

Canadian Department of Communications

This Class A digital apparatus meets all requirements of the Canadian Interference-Causing Equipment Regulations.

Cet appareil numérique de la classe A respecte toutes les exigences du Règlement sur le matériel brouilleur du Canada.

RFI Emission

FCC Class A, EN55022 Class A, VCCI Class A, C-TICK, EN61000-3-2, EN61000-3-3  1



Warning: In a domestic environment this product may cause radio interference in which case the user may be required to take adequate measures.  2

Immunity

EN55024  3

Electrical Safety

UL 1950 (UL/cUL), EN60950 (TUV)  4





Laser

EN60825  5

Important: Appendix C contains translated safety statements for installing this equipment. When you see the , go to Appendix C for the translated safety statement in your language.

Wichtig: Anhang C enthält übersetzte Sicherheitshinweise für die Installation dieses Geräts. Wenn Sie  sehen, schlagen Sie in Anhang C den übersetzten Sicherheitshinweis in Ihrer Sprache nach.

Viktig: Tillæg C indeholder oversatte sikkerhedsadvarsler, der vedrører installation af dette udstyr. Når De ser symbolet , skal De slå op i tillæg C og finde de oversatte sikkerhedsadvarsler i Deres eget sprog.

Belangrijk: Appendix C bevat vertaalde veiligheidsopmerkingen voor het installeren van deze apparatuur. Wanneer u de  ziet, raadpleeg Appendix C voor vertaalde veiligheidsinstructies in uw taal.

Important: L'annexe C contient les instructions de sécurité relatives à l'installation de cet équipement. Lorsque vous voyez le symbole , reportez-vous à l'annexe C pour consulter la traduction de ces instructions dans votre langue.

Tärkeää: Liite C sisältää tämän laitteen asentamiseen liittyvät käännetyt turvaohjeet. Kun näet -symbolin, katso käännettyä turvaohjetta liitteestä C.

Importante: L'Appendice C contiene avvisi di sicurezza tradotti per l'installazione di questa apparecchiatura. Il simbolo , indica di consultare l'Appendice C per l'avviso di sicurezza nella propria lingua.

Viktig: Tillegg C inneholder oversatt sikkerhetsinformasjon for installering av dette utstyret. Når du ser , åpner du til Tillegg C for å finne den oversatte sikkerhetsinformasjonen på ønsket språk.

Importante: O Anexo C contém advertências de segurança traduzidas para instalar este equipamento. Quando vir o símbolo , leia a advertência de segurança traduzida no seu idioma no Anexo C.

Importante: El Apéndice C contiene mensajes de seguridad traducidos para la instalación de este equipo. Cuando vea el símbolo , vaya al Apéndice C para ver el mensaje de seguridad traducido a su idioma.

Obs! Bilaga C innehåller översatta säkerhetsmeddelanden avseende installationen av denna utrustning. När du ser , skall du gå till Bilaga C för att läsa det översatta säkerhetsmeddelandet på ditt språk.

Table of Contents

Preface	vii
How This Guide is Organized	vii
Document Conventions	viii
Where to Find Current Product Documentation	ix
Contacting Allied Telesyn Technical Support	x
Online Support.....	x
Telephone Support.....	x
Management Software Updates	xi
For Sales or Corporate Information	xii
Chapter 1	
Product Description	1
Features	2
Components	3
Hardware Feature Description	4
Twisted Pair Ports.....	4
Gigabit Interface Converter (GBIC) Expansion Slots.....	5
LEDs.....	6
AC Power Connector.....	6
A Few Ethernet Switching Basics	7
MAC Address Table.....	7
Duplex Mode.....	8
Store and Forward.....	8
Backpressure and Flow Control	9
Network Topologies	10
Power Workgroup Topology.....	10
Collapsed Backbone	11
Chapter 2	
Installation	13
Reviewing Safety Precautions	14
Selecting a Site for the Switch	15
Planning the Installation	16
Unpacking the Switch	17
Installing the Switch in a Rack	18
Attaching the Rubber Feet	18
Installing an Optional GBIC Module	19
Cabling and Powering ON the Switch	21
Warranty Registration	25

Chapter 3	
Troubleshooting	27
Appendix A	
Technical Specifications	31
Physical Specifications	31
Environmental Specifications	32
Power Specifications	33
Safety and Electromagnetic Emissions Certifications	34
Connectors	35
RJ-45 Twisted Pair Port Pinouts	35
SC Connector.....	36
Appendix B	
Translated Electrical Safety and Emission Information	37

Preface

This guide contains the hardware installation instructions for the AT-GS924GB Gigabit Ethernet Switch

How This Guide is Organized

This manual contains the following chapters and appendices:

Chapter 1, **Product Description**, describes the features and components of the switches.

Chapter 2, **Installation**, contains the installation instructions for the switches.

Chapter 3, **Troubleshooting**, provides information on how to resolve problems that might occur with the switches.

Appendix A, Technical Specifications, contains the technical specifications for the switches.

Appendix B, Translated Electrical Safety and Emission Information, contains translations of the warnings and cautions in the manual.

Document Conventions

This document uses the following conventions to highlight important information:

Note

Notes provide additional information.



Warning

Warnings inform you that performing or omitting a specific action may result in bodily injury.



Caution

Cautions inform you that performing or omitting a specific action may result in equipment damage or loss of data.

Where to Find Current Product Documentation

The installation and user guides for all Allied Telesyn products are available in Portable Document Format (PDF) from the Allied Telesyn web site at **www.alliedtelesyn.com**. You can view the documents online or download them onto a local workstation or server.

Contacting Allied Telesyn Technical Support

You can contact Allied Telesyn technical support online or by telephone.

Online Support

You can request technical support online by accessing the Knowledge Base from our web site at <http://kb.alliedtelesyn.com>. You can use the Knowledge Base to submit questions to our technical support staff and review answers to previously asked questions.

Telephone Support

For Technical Support by telephone, contact Allied Telesyn at one of the following locations:

Americas

United States, Canada, Mexico,
Central America, South America
Tel: 1 (800) 428-4835

Asia

Singapore, Taiwan, Thailand,
Malaysia, Indonesia, Korea,
Philippines, China,
India, Hong Kong
Tel: (+65) 3815-612

Australia

Australia, New Zealand
Tel: 1 (800) 000-880

Europe

Tel: 00 800 287 877 678

France

France, Belgium, Luxembourg, The
Netherlands, Middle East, Africa
Tel: (+33) 1-60-92-15-25

Germany

Germany, Switzerland, Austria,
Eastern Europe
Tel: (+49) 81 1999370

Italy

Italy, Spain, Portugal, Greece,
Turkey, Israel
Tel: (+39) 02-41-30-41

Japan

Tel: (+81) 3-3443-5640

United Kingdom

United Kingdom, Denmark, Norway,
Sweden, Finland, Iceland
Tel: (+44) 1-235-442560

Management Software Updates

Allied Telesyn periodically updates the management software programs for managed products. You can obtain a new version of a management software program from our web site at **www.alliedtelesyn.com** or our FTP server at **ftp.alliedtelesyn.com**. To use the FTP server, enter **anonymous** for the user name when you log in and your e-mail address for the password.

For Sales or Corporate Information

You can contact Allied Telesyn for sales or corporate information at the location listed below:

Allied Telesyn, Inc.

19800 North Creek Parkway, Suite 200

Bothell, WA 98011

Tel: 1 (425) 487-8880

Fax: 1 (425) 489-9191

Chapter 1

Product Description

The AT-GS924GB is an unmanaged, Layer 2 Gigabit Ethernet switch designed to simplify the task of creating or expanding an Ethernet, Fast Ethernet, or Gigabit Ethernet network.

The sections in this chapter are as follows:

- ❑ **Features** on page 2
- ❑ **Components** on page 3
- ❑ **Hardware Feature Description** on page 4
- ❑ **A Few Ethernet Switching Basics** on page 7
- ❑ **Network Topologies** on page 10

Features

AT-GS924GB Gigabit Ethernet switch features include:

- 24 10/100/1000 Mbps twisted pair ports
- 2 GBIC expansion slots
- Visual diagnostic LEDs
- Auto-negotiation (IEEE 802.3u-compliant)
- Backpressure and flow control (IEEE 802.3x-compliant)
- Store and forward packet handling
- MAC address table capable of storing up to 32K entries with automatic aging

Components

Figure 1 illustrates the front panel of the AT-GS924GB switch.

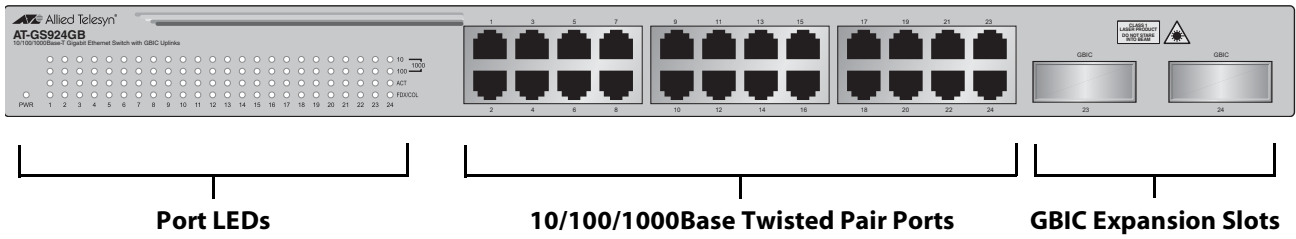

Figure 1 Front Panel of the AT-GS924GB switch

Figure 2 illustrates the back panel of the AT-GS924GB switch.

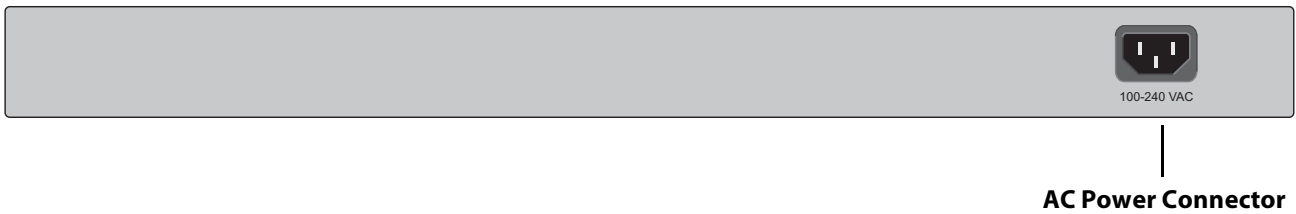

Figure 2 Back Panel of the AT-GS924GB switch

Hardware Feature Description

The following sections describe hardware features of the AT-GS924GB Gigabit Ethernet switch:

- Twisted Pair Ports
- Gigabit Interface Converter (GBIC) Expansion Slots
- System and Port LEDs
- AC Power Connector

Twisted Pair Ports

The AT-GS924GB features 24 twisted pair ports.

Type of Connector

The twisted pair ports feature 8-pin, RJ-45 connectors. (For the port pinouts, refer to **RJ-45 Twisted Pair Port Pinouts** on page 35.

Speed

The ports are 10Base-T, 100Base-TX, and 1000Base-T compliant and are capable of 10 megabits per second (Mbps), 100 Mbps, and 1000 Mbps speeds. The ports are IEEE 802.3u Auto-negotiation compliant. With Auto-negotiation, the switch automatically matches the highest possible common speed between each switch port and each end-node. For example, if an end-node is capable of only 10 Mbps, the switch sets the port connected to the end-node to 10 Mbps.

Duplex Mode

Each twisted pair port on the switch can operate in either half- or full duplex mode. The twisted pair ports are IEEE 802.3u-compliant and will Auto-Negotiate the duplex mode setting.

Note

In order for the switch to set the duplex mode for each port correctly, the end-nodes that you connect to the switch ports should also use Auto-Negotiation. Otherwise, a duplex mode mismatch can occur, affecting network performance. For further information, refer to **Duplex Mode** on page 8.

Maximum Distance

Each twisted pair port has a maximum operating distance of 100 meters (328 feet).

Type of Cabling

For 10 Mbps operation, Category 3 or better 100 ohm shielded or unshielded twisted pair cabling is required. For 100 or 1000 Mbps operation, Category 5 and Enhanced Category 5 (5E) 100 ohm shielded or unshielded twisted pair cabling is required.

Auto-MDI

For port speeds of 10 or 100 Mbps, the ports are auto-MDI. They automatically configure themselves as either MDI or MDI-X. This feature allows you to use either straight-through or crossover twisted pair cables to connect devices to the ports. For port speeds of 1000 Mbps, you must use a straight through twisted pair cable.

**Gigabit
Interface
Converter
(GBIC)
Expansion Slots**

The AT-GS924GB Gigabit Ethernet Switch has two Gigabit Interface Converter (GBIC) expansion slots on the front panel that correspond to Ports 23 and 24 respectively. Each slot can accommodate one optional fiber optic GBIC Ethernet module.

Note

If a GBIC module is installed in expansion slot Port 23 or 24, the corresponding twisted pair Port 23 or 24 cannot be used.

A GBIC module is a fast and easy way to add an 1000 Mbps fiber optic port to a Gigabit Ethernet switch. GBIC modules can be used to extend the distance of your network, build a high-speed backbone network between switches, or connect additional nodes to the network, such as high-speed servers.

Figure 3 shows an example of a fiber optic GBIC module.

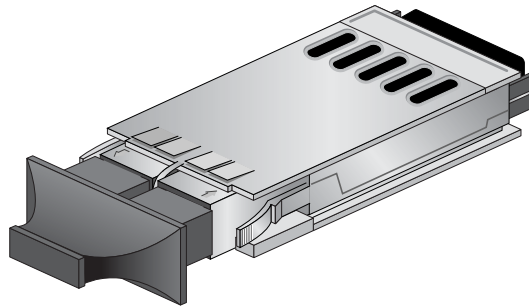

Figure 3 GBIC Module

Note

For a list of the Allied Telesyn GBIC modules supported by the AT-GS924GB Gigabit Ethernet Switch, contact your Allied Telesyn sales representative.

LEDs The port LEDs on the front panel display port status information. Each port has four LEDs.

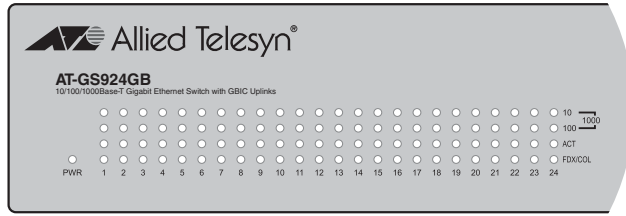

Figure 4 LEDs

Table 1 below describes the AT-GS924GB port LEDs.

Table 1 Port LED Descriptions

LED	State	Description
10	Green	Indicates that the port is operating at 10 Mbps.
100	Green	Indicates that the port is operating at 100 Mbps.
10 and 100	Green	Indicates that the port is operating at 1000 Mbps.
ACT	OFF	Indicates that there is no activity on the port.
	Flashing Green	Indicates that the port is transmitting and/or receiving data packets.
FDX	OFF	Indicates that the port is operating in half-duplex mode.
	Green	Indicates that the port is operating in full-duplex mode.

AC Power Connector The AT-GS924GB switch has a single AC power supply socket on the back panel with auto-switch AC inputs. Refer to **Technical Specifications** on page 31, for the input voltage range. To power ON or OFF the switch, you connect or disconnect the power cord.

A Few Ethernet Switching Basics

An Ethernet switch interconnects network devices, such as workstations, printers, routers, and other Ethernet switches, so that they can communicate with each other by sending and receiving Ethernet frames.

MAC Address Table

Every hardware device on your network has a unique MAC address. This address is assigned to the device by the device's manufacturer. For example, when you install a Network Interface Card (NIC) in a computer so that you can connect it to the network, the NIC already has a MAC address assigned to it by its manufacturer.

The AT-GS924GB Gigabit Ethernet switch can contain up to 32K entries on its MAC address table. The switch uses the table to store the MAC addresses of the network nodes connected to the ports, along with the port number on which each address was learned.

A switch learns the MAC addresses of the end-nodes by examining the source address of each packet received on a port. It adds the address and port on which the packet was received to the MAC table if the address had not already been entered in the table. The result is a table that contains all the MAC addresses of the devices that are connected to the switch's ports, and the port number where each address was learned.

When the switch receives a packet, it also examines the destination address and, by referring to its MAC address table, determines the port on which the destination node is connected. It then forwards the packet to the appropriate port and on to the end-node. This increases network bandwidth by limiting each frame to the appropriate port when the intended end-node is located, freeing the other switch ports for receiving and transmitting data.

If the switch receives a packet with a destination address that is not in the MAC address table, it floods the packet to all the ports on the switch. If the ports have been grouped into virtual LANs, the switch floods the packet only to those ports which belong to the same VLAN as the port on which the packet was received. This prevents packets from being forwarded into inappropriate LAN segments, increasing network security. When the destination node responds, the switch adds its MAC address and port number to the table.

If the switch receives a packet with a destination address that is on the same port on which the packet was received, it discards the packet without forwarding it on to any port. Since both the source node and the destination node for the packet are located on the same port on the switch, there is no reason for the switch to forward the packet.

Duplex Mode

Duplex mode refers to how an end-node receives and transmits data. If an end-node can receive or transmit data, but not both simultaneously, the end-node is operating in what is referred to as half-duplex mode. If an end-node can both receive and transmit data simultaneously, the end-node is said to be operating in full-duplex mode. Naturally, an end-node capable of operating in full-duplex can handle data much faster than an end-node that can only operate in half-duplex mode.

The twisted pair ports on the AT-GS924GB switch can operate in either half-or full-duplex mode. They are IEEE 802.3u-compliant and use Auto-Negotiation to set the duplex mode setting for you automatically.

For Auto-Negotiation to operate properly on the AT-GS924GB switch, the end-nodes connected to the switch should also use Auto-Negotiation. If an end-node does not have this feature and has a fixed duplex mode of full-duplex, the result will be a duplex mode mismatch between the end-node and a switch port. A port on the AT-GS924GB switch connected to an end-node with a fixed duplex mode of full-duplex will operate at only half-duplex. This results in the end node using full-duplex and the switch port using half-duplex. This can produce network performance problems. Should you encounter this situation, you must configure the port on the end-node to use Auto-Negotiation or, if it lacks that feature, to half-duplex.

Store and Forward

This Gigabit Ethernet Switch uses store and forward as the method for receiving and transmitting frames. When a Ethernet frame is received on a switch port, the switch does not retransmit the frame out the destination port until it has received the entire frame and stored the frame in a port buffer. It then examines the frame to determine if it is a valid frame. Invalid frames, such as fragments or runts, are discarded by the switch. This ensures that only valid frames are transmitted out the switch ports and that damaged frames are not propagated on your network.

Backpressure and Flow Control

To maintain the orderly movement of data between the end-nodes, an Ethernet switch may periodically need to signal an end-node to stop sending data. This can occur under several circumstances. For example, if two end-nodes are operating at different speeds, the switch, while transferring data between the end-nodes, might need to instruct the faster end-node to stop transmitting data to allow the slower end-node to catch up. An example of this would be when a server operating at 100 Mbps is sending data to a workstation operating at only 10 Mbps.

How a switch signals an end-node to stop transmitting data differs depending on the speed and duplex mode of the end-node and switch port. A twisted pair port operating at 100 Mbps port and half-duplex mode stops an end-node from transmitting data by forcing a collision. A collision on an Ethernet network occurs when two nodes attempt to transmit data using the same data link at the same time. A collision causes end-nodes to stop sending data. When the switch needs to stop a 100 Mbps, half-duplex end-node from transmitting data, it forces a collision on the data link, which stops the end-node. Once the switch is ready to receive data again, the switch stops forcing collisions. This is referred to as backpressure.

A port operating at 100 Mbps and full-duplex mode uses PAUSE frames, as specified in the IEEE 802.3x standard, to stop the transmission of data from an end-node. Whenever the switch wants an end-node to stop transmitting data, it issues this frame. The frame instructs the end-node to cease transmission. The switch continues to issue PAUSE frames until it is ready again to receive data from the end-node. This is referred to as flow control.

Network Topologies

This section illustrates several of the network topologies that you can create with the AT-GS924GB Gigabit Ethernet switch.

Power Workgroup Topology

The topology shown in Figure 5 is commonly referred to as a power workgroup topology. Each workstation or node is connected directly to a port on the switch. Each node has a dedicated data link to the switch for best performance and reliability. The devices can operate at 10 Mbps, 100 Mbps or 1000 Mbps.

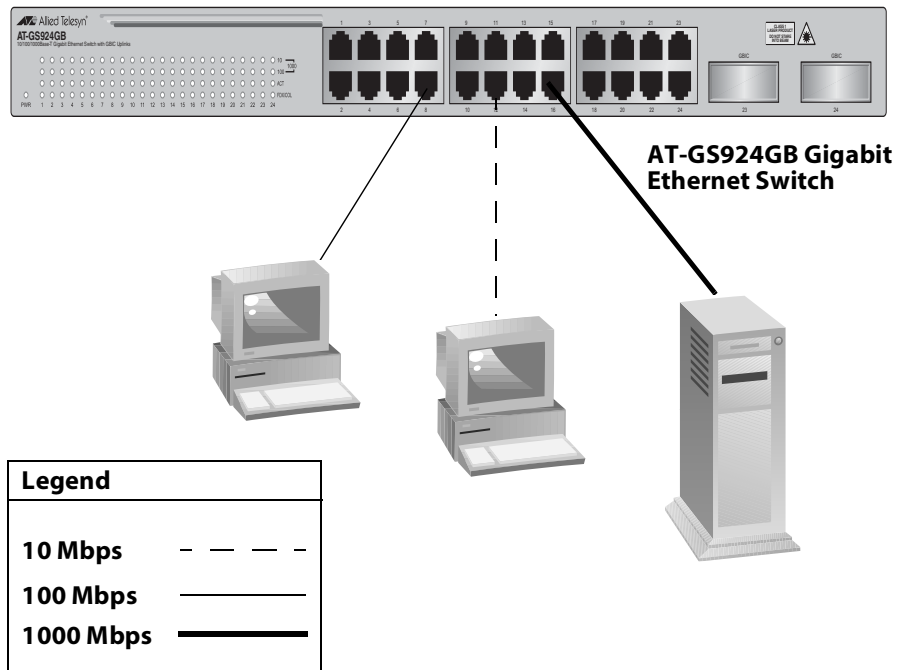

Figure 5 Power Workgroup Topology

Collapsed Backbone

In the topology illustrated in Figure 6, an AT-GS924GB connects Fast Ethernet switches that have Gigabit Ethernet uplinks. This type of topology is often referred to as a collapsed backbone topology. The switch functions as the focal point of the network and transfers an Ethernet frame between the Fast Ethernet switches only when the destination node for the frame is on a different switch than the node that originated the frame. This reduces the amount of unnecessary data traffic in each workgroup, freeing up bandwidth and improving network performance.

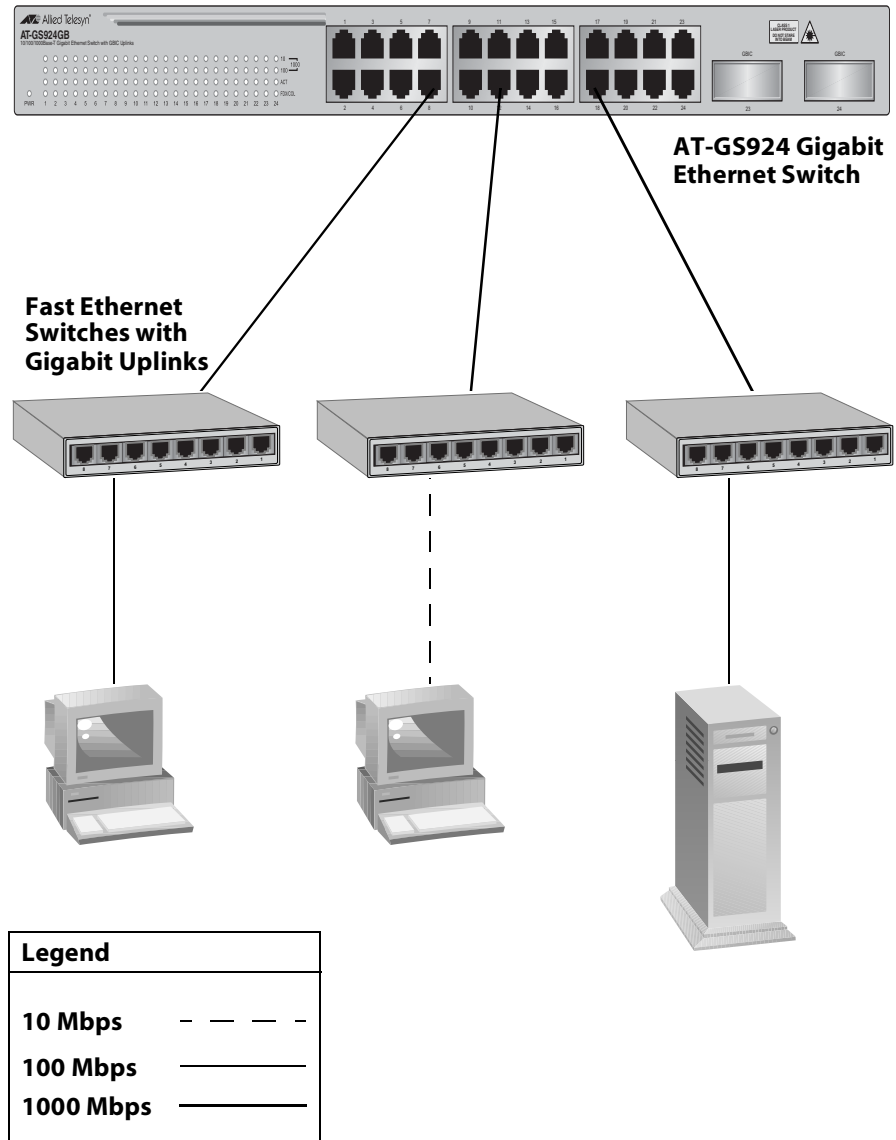

Figure 6 Collapsed Backbone - Hub Topology

Chapter 2

Installation

This chapter contains installation procedures for the AT-GS924GB Gigabit Ethernet switch. The chapter contains the following sections:

- ❑ **Reviewing Safety Precautions** on page 14
- ❑ **Selecting a Site for the Switch** on page 15
- ❑ **Planning the Installation** on page 16
- ❑ **Unpacking the Switch** on page 17
- ❑ **Installing the Switch in a Rack** on page 18
- ❑ **Attaching the Rubber Feet** on page 18
- ❑ **Installing an Optional GBIC Module** on page 19
- ❑ **Cabling and Powering ON the Switch** on page 21
- ❑ **Warranty Registration** on page 25

Reviewing Safety Precautions

Please review the following safety precautions before you begin to install the switch or any of its components. Refer to **Translated Electrical Safety and Emission Information** on page 37 for translated safety statements in your language. (The laser warnings apply if you install an optional fiber optic GBIC module.)

**Laser**

Class 1 laser product. 6 6

**Laser**

Do not stare into the laser beam. 7 7

**Warning**

Electric Shock Hazard: To prevent electric shock, do not remove the cover. There are no user-serviceable parts inside. The unit contains hazardous voltages and should only be opened by a trained and qualified technician. 8 8

**Warning**

Lightning Danger: Do not work on this equipment or cables during periods of lightning activity. 9 9

**Warning**

Power cord is used as a disconnection device: To de-energize equipment, disconnect the power cord. 10 10

**Warning**

Electrical-Type Class 1 Equipment: This equipment must be earthed. The power plug must be connected to a properly wired earth ground socket outlet. An improperly wired socket outlet could place hazardous voltages on accessible metal parts. 11 11

**Caution**

Pluggable Equipment: The socket outlet should be installed near the equipment and should be easily accessible. 12 12

**Caution**

Air vents: The air vents must not be blocked on the unit and must have free access to the room ambient air for cooling. 13 13

**Caution**

Operating Temperature: This product is designed for a maximum ambient temperature of 40°C. 14 14

**Caution**

All Countries: Install this product in accordance with local and National Electric Codes. 15 15

Selecting a Site for the Switch

Observe the following requirements when choosing a site for your switch:

- If you plan to install the switch in an equipment rack, ensure that the rack is safely secured and that it will not tip over. Devices in a rack should be installed starting at the bottom, with the heavier devices near the bottom of the rack.
- If you are installing the switch on a table, ensure that the table is level and secure.
- The power outlet for the switch should be located near the unit and should be easily accessible.
- The site should provide for easy access to the ports on the front of the switch. This will make it easy for you to connect and disconnect cables, as well as view the switch's LEDs.
- To allow proper cooling of the switch, air flow around the unit and through its vents on the side and rear should not be restricted.
- Do not place objects on top of the switch.
- Do not expose the switch to moisture or water.
- Ensure that the site is a dust-free environment.
- You should use dedicated power circuits or power conditioners to supply reliable electrical power to the network devices.

Planning the Installation

Table 2 contains the cabling specifications for the twisted pair ports.

Table 2 Twisted Pair Cabling and Distances

Speed	Type of Cable	Maximum Operating Distance
10 Mbps	Category 3 or better 100-ohm shielded or unshielded twisted pair cable	100 m (328 ft)
100 Mbps	Category 5 or Category 5E (Enhanced) 100-ohm shielded or unshielded twisted pair cable	100 m (328 ft)
1000 Mbps	Category 5 and Category 5E (Enhanced) 100-ohm shielded or unshielded twisted pair cable	100 m (328 ft)

Note

The twisted pair ports on the switch feature auto-MDI when operating at either 10 or 100 Mbps. Each port is individually configured as MDI or MDI-X when connected to an end-node. Consequently, you can use either a straight-through or crossover twisted pair cable when connecting any network device to a twisted pair port on the switch. A port operating at 10 or 100 Mbps uses two pairs of twisted pair wiring.

Note

Twisted pair ports operating at 1000 Mbps must use a straight-through cable. A port operating at 1000 Mbps uses four pairs of twisted pair wiring.

Note

For cabling information for an optional GBIC module, refer to the installation guide included with the module.

Unpacking the Switch

To unpack the switch, perform the following procedure:

1. Remove all components from the shipping package.

Note

Store the packaging material in a safe location. You must use the original shipping material if you need to return the unit to Allied Telesyn.

2. Place the switch on a level, secure surface.
3. Ensure the following hardware components are included in your switch package. If any item is missing or damaged, contact your Allied Telesyn sales representative for assistance.

- One AT-GS924GB Gigabit Ethernet switch
- Two mounting brackets
- Six bracketmounting screws
- Four rackmounting screws
- Four rubber feet
- Power cord (Americas, EC, Australia, and UK only)
- Installation Guide
- Warranty card

Installing the Switch in a Rack

Perform the following procedure to install the switch in a standard 19-inch rack. If you are not installing the switch in a rack, go to the next procedure:

1. Attach a bracket to one side of the switch using the bracketmounting screws that came with the switch. See Figure 7.

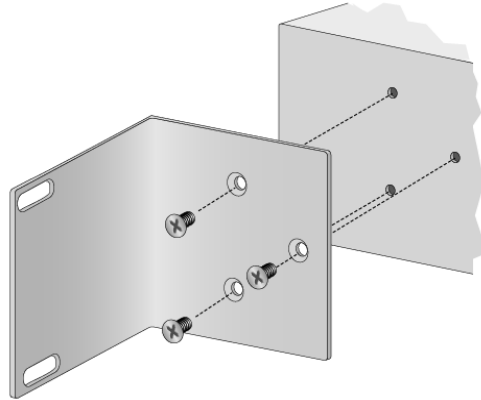

Figure 7 Attaching Rackmounting Brackets

2. Install the second rackmounting bracket on the other side of the switch using the remaining bracketmounting screws.
3. Mount the switch in the 19-inch rack using the four rackmounting screws.

Attaching the Rubber Feet

To use the switch as a desktop unit, perform the following procedure to attach the rubber feet to the bottom of the switch:

1. Place the unit upside down on a level, secure surface.
2. Attach the four rubber feet to the bottom of the switch.

Installing an Optional GBIC Module

To install an optional GBIC module, perform the following procedure:

1. Unpack the GBIC module from its shipping container and store the packaging material in a safe location.

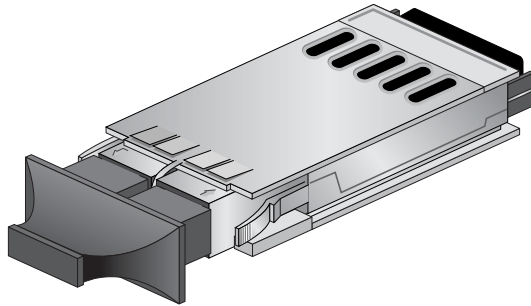

Figure 8 GBIC Module

Note

You must use the original shipping material if you need to return the module to Allied Telesyn.

**Warning**

A GBIC module can be damaged by static electricity. Ensure that you observe all standard electrostatic discharge (ESD) precautions, such as wearing an antistatic wrist strap, to avoid damaging the module.

2. Check that the GBIC package includes all the items listed below. If any item is missing or damaged, contact your Allied Telesyn sales representative for assistance.

- One GBIC module
- Installation guide
- Warranty card

Note

For fiber optic cabling specifications for the module, refer to the Installation Guide included with the module.

3. Follow these guidelines to ensure the performance of your GBIC:

- GBICs are static sensitive. To prevent Electrostatic Discharge Damage (ESD), follow your normal board and component handling procedures.

- ❑ GBICs are dust sensitive. When the GBIC is stored or when a fiber-optic cable is not plugged in, always keep plugs in the GBIC optical bores.
- ❑ The most common source of contaminants in the optical bores is debris picked up on the ferrules of the optical connectors. Use an alcohol swab or wipe to clean the ferrules of the optical connector.

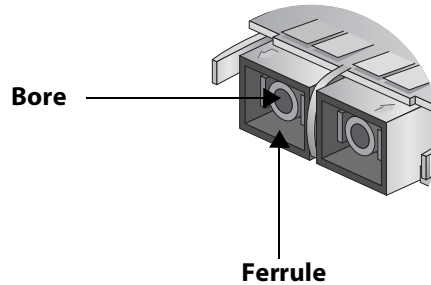

Figure 9 Optical Bore and Ferrule of GBIC Module

Note

Unnecessary removal and insertion of a GBIC could lead to premature failure.

4. Slide the GBIC module into an expansion slot on the switch. The GBIC module is completely seated in the slot when it clicks into place.

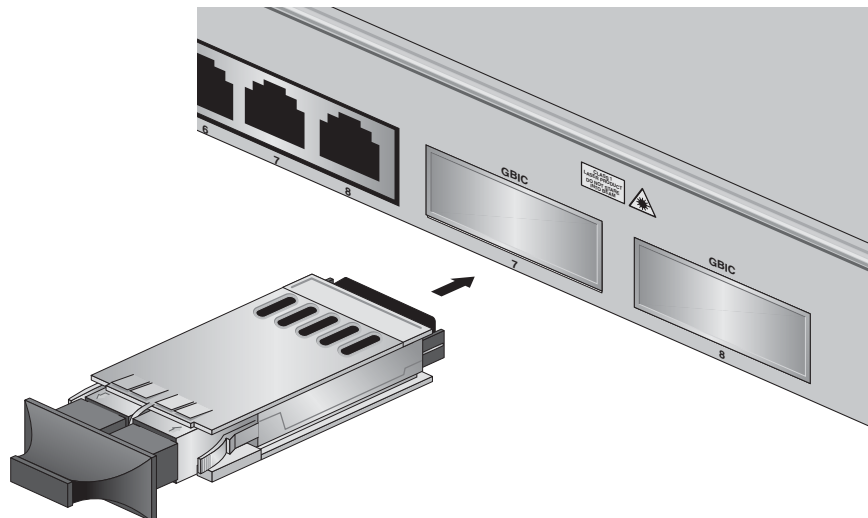

Figure 10 Installing a GBIC Module

5. If you purchased two GBIC modules for the switch, repeat this procedure to install the second module.

Cabling and Powering ON the Switch

Perform the following procedure to connect the data cables to the switch ports and to apply power to the switch.

1. Connect the twisted pair data cables to the RJ-45 ports on the switch, as shown in Figure 11.

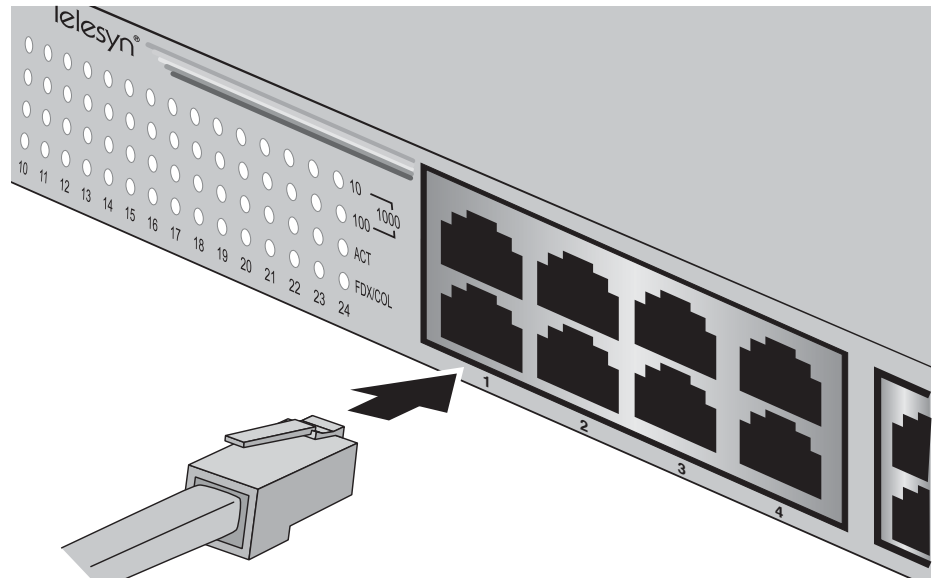

Figure 11 Connecting the Twisted Pair Data Cables

When connecting a twisted pair cable to a port, observe the following guidelines:

- An RJ-45 connector should fit snugly into the port on the switch. The tab on the connector should lock the connector into place.
- The ports on the switch are auto-MDI/MDI-X when operating at 10 or 100 Mbps. You can use either a straight-through or crossover twisted pair cable to connect any type of network device to a port on the switch when operating at either 10 or 100 Mbps.
- For ports operating at 1000 Mbps, use a straight-through cable.
- The network should not contain data loops, which can adversely affect network performance. A data loop exists when two or more network devices can communicate with each other over more than one data path.

2. If you installed optional fiber optic GBIC modules, remove the dust covers from the ports.

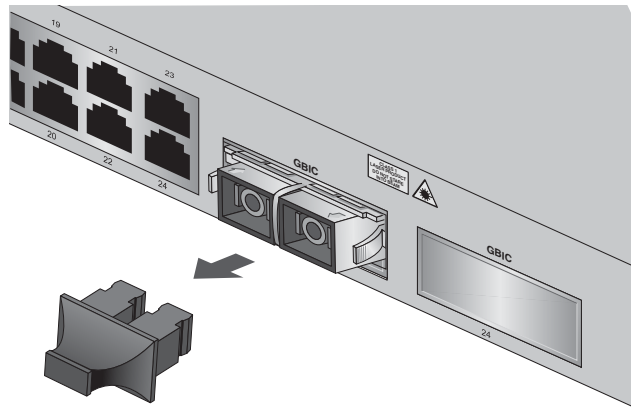

Figure 12 Removing the Dust Covers from the Fiber Optic Ports



Caution

Do not remove the dust covers if you do not intend to connect the fiber optic cables at this time. Dust contamination can adversely impact the operations of the ports.

3. Attach the fiber optic data cables to the fiber optic ports.

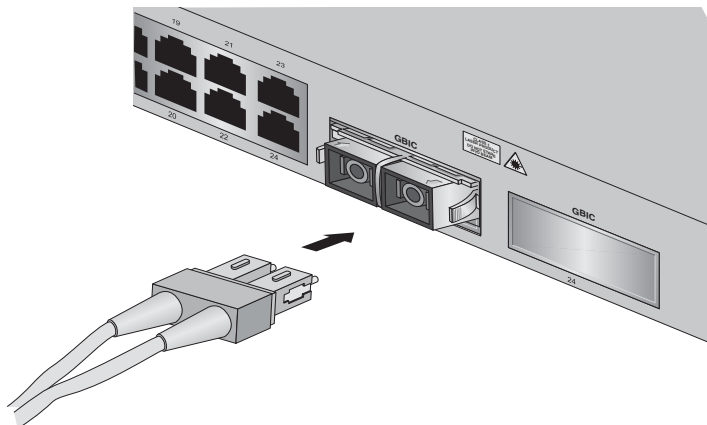

Figure 13 Attaching a Fiber Optic Cable

When attaching a fiber optic cable, observe the following guidelines:

- ❑ Ensure that the cable connector is firmly locked into place in the port.
 - ❑ With a dual SC connector, ensure to connect the receiver fiber port to the transmitter port on the remote end-node, and the transmitter fiber port to the receiver port on the remote node.
 - ❑ Ensure that you are using the appropriate type of fiber optic cabling by referring to the installation guide included with the module.
 - ❑ Ensure that the operating specifications of the switch's fiber optic port are compatible with the fiber optic port on the remote end-node. For example, you cannot connect a fiber optic port with a maximum distance of 2 kilometers (1.24 miles) and an operating wavelength of 1310 nm to another fiber optic port that has a maximum distance of 40 kilometers (24.8 miles) and an operating wavelength of 1550 nm.
 - ❑ The network should not contain data loops, which can adversely affect network performance. A data loop exists when two or more network devices can communicate with each other over more than one data path.
4. Apply AC power to the switch by plugging the power cord into the AC power connector on the back panel of the unit and plugging the other end into a wall outlet.

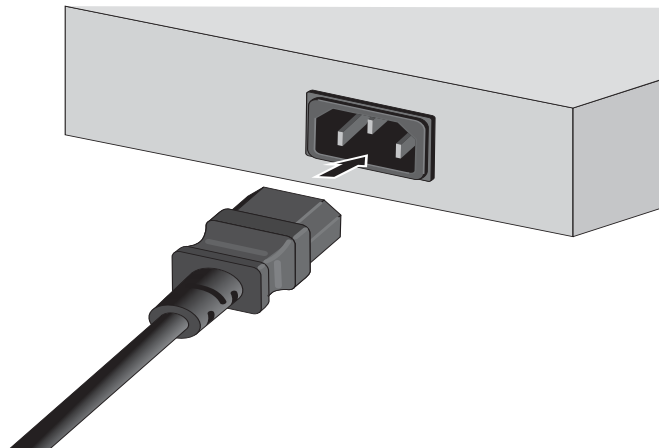

Figure 14 Connecting the AC Power Connector to Switch



Warning

The power cord is used as a disconnection device. To de-energize equipment, disconnect the power cord. *See* 10

Note

For information on the system LEDs, refer to **LEDs** on page 6.

The switch is ready for network operations.

Warranty Registration

After installing your switch, you can register your product by completing the enclosed warranty card and sending it to Allied Telesyn.

Chapter 3

Troubleshooting

This chapter contains information on how to troubleshoot the switch in the event that a problem occurs.

Note

If you are still unable to resolve the problem after following the instructions in this chapter, contact Allied Telesyn Technical Support for assistance. Refer to **Contacting Allied Telesyn Technical Support** on page x.

Check the PWR LED on the front of the switch. If the LED is OFF, indicating that the unit is not receiving power, do the following:

- Ensure that the power cord is securely connected to the power source and to the AC connector on the back panel of the switch.
- Verify that the power outlet has power by connecting another device to it.
- Try connecting the unit to another power source.
- Try using a different power cord.
- Verify that the voltage from the power source is within the required levels for your region.

For twisted pair ports, verify that the ACT LED for each port is ON. If a ACT LED is OFF, do the following:

- Verify that the end-node connected to the port is powered ON and is operating properly.
- Verify that the twisted pair cable is securely connected to the port on the switch and to the port on the end-node.
- Ensure that the twisted pair cable does not exceed 100 meters (328 feet).
- Verify that you are using the appropriate category of twisted pair cable: Category 3 or better for 10 Mbps operation and Category 5 and Category 5E for 100 and 1000 Mbps operation.

Note

A 1000Base connection can take from five to ten seconds for the link to be established.

- If either twisted pair Port 23 or 24 is not working properly, verify that a GBIC module is not installed in the corresponding expansion Port 23 or 24. If expansion Ports 23 and 24 are currently being used, then the corresponding twisted pair Port 23 or 24 cannot be used.

For a fiber optic port on an optional GBIC module, verify that the ACT LED for the port is ON. If the ACT LED is OFF, do the following:

- Verify that the GBIC module is completely inserted into the expansion slot on the front of the switch.
- Verify that the end-node connected to the port is powered ON and is operating properly.
- Verify that the fiber optic cable is securely connected to the port on the switch and to the port on the end-node.
- If the fiber optic port has a dual SC connector, verify that the receiver fiber port is connected to the transmitter port on the remote end-node, and that the transmitter fiber port is connected to the receiver port on the remote node.
- Ensure that you are using the appropriate type of fiber optic cable and that the cable length does not exceed the allowed maximum distance. Refer to the GBIC Installation Guide.

- ❑ Use a fiber optic tester to test the attenuation on the cable to determine if the strength of the fiber optic signal falls below acceptable limits.
- ❑ Check that the operating specifications (for instance, wavelength and maximum operating distance) of the fiber optic port on the remote end-node are compatible with the fiber optic port on the switch. For example, you cannot connect a fiber optic port with a maximum distance of 40 kilometers (24.8 miles) and an operating wavelength of 1550 nm to a remote fiber optic port with an maximum distance of only 2 kilometers (1.24 miles) and a wavelength of 1310 nm.
- ❑ Ensure that the fiber optic ports on the switch and on the end-node are operating at the same speed and duplex mode.

Note

A 1000Base connection can take from five to ten seconds for the link to be established.

Appendix A

Technical Specifications

Physical Specifications

Dimensions:	(H x W x D) 4.4 cm x 43.2 cm x 25.0 cm (1.7 in x 17 in x 9.8 in)
Weight:	5.25 kg (11.60 lbs)
Recommended Minimum Ventilation on All Sides:	10 cm (4.0 in)

Environmental Specifications

Operating Temperature:	0° C to 40° C (32° F to 104° F)
Storage Temperature:	-25° C to 70° C (-13° F to 158° F)
Operating Humidity:	5% to 90% non-condensing
Storage Humidity:	5% to 95% non-condensing
Operating Altitude Range:	Up to 3,000 m (9,843 ft)

Power Specifications

Maximum Power Consumption:	46 watts
AC Input Electrical Ratings:	100~240V AC, 2A
Frequency:	50~60 Hz

Safety and Electromagnetic Emissions Certifications

Safety:	UL 1950 (UL/cUL), EN60950 (TUV), EN60825
EMI:	FCC Class A, EN55022 Class A, VCCI Class A, C-TICK, EN61000-3-2, EN61000-3-3
Immunity:	EN55024
Reliability	<p>MTBF – 26,000 hours, system (includes PCBA at 114,000 hours, fan module at 50,000 hours and power module at 99,000 hours)</p> <p>The MTBF was predicted using Telcordia SR-332 parts count method for a ground benign environment at 30°C.</p> <p>MTTR – ½ hour for replacement unit on site; 24 hours for advance replacement shipment</p> <p>DOA Rate < 0.1% for out of box (failure within 24 hours) < 2.7% for early life (failure within 30 days)</p>

Connectors

This section lists the connectors and connector pinouts for the AT-GS924GB Gigabit Ethernet switch and its components.

RJ-45 Twisted Pair Port Pinouts

Figure 15 illustrates the pin layout to an RJ-45 connector and port.

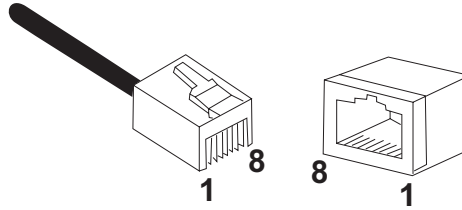

Figure 15 RJ-45 Connector and Port Pin Layout

Table 3 lists the RJ-45 pin signals when a twisted pair port is operating in the MDI configuration.

Table 3 MDI Pin Signals (10Base-T or 100Base-TX)

Pin	Signal
1	TX+
2	TX-
3	RX+
6	RX-

Table 4 lists the RJ-45 port pin signals when a twisted pair port is operating in the MDI-X configuration.

Table 4 MDI-X Pin Signals (10Base-T or 100Base-TX)

Pin	Signal
1	RX+
2	RX-
3	TX+
6	TX-

Table 5 lists the RJ-45 connector pins and their signals when a 1000Base-T port is operating at 1000 Mbps.

Table 5 RJ-45 1000Base-T Connector Pinouts¹

Pin	Pair	Signal
1	1	TX and RX+
2	1	TX and RX-
3	2	TX and RX+
4	3	TX and RX+
5	3	TX and RX-
6	2	TX and RX-
7	4	TX and RX+
8	4	TX and RX-

1. Bi-directional data on each pair.

SC Connector

The AT-GS924GB Gigabit Ethernet switch uses an SE connector. The SC connector (shown in Figure 16) is used to connect optional GBIC modules.

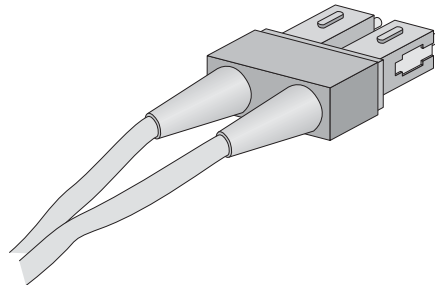

Figure 16 SC Connector

Appendix B

Translated Electrical Safety and Emission Information

Important: This appendix contains multiple-language translations for the safety statements in this guide.

Wichtig: Dieser Anhang enthält Übersetzungen der in diesem Handbuch enthaltenen Sicherheitshinweise in mehreren Sprachen.

Vigtigt: Dette tillæg indeholder oversættelser i flere sprog af sikkerhedsadvarslerne i denne håndbog.

Belangrijk: Deze appendix bevat vertalingen in meerdere talen van de veiligheidsopmerkingen in deze gids.

Important: Cette annexe contient la traduction en plusieurs langues des instructions de sécurité figurant dans ce guide.

Tärkeää: Tämä liite sisältää tässä oppaassa esiintyvät turvaohjeet usealla kielellä.

Importante: questa appendice contiene traduzioni in più lingue degli avvisi di sicurezza di questa guida.

Viktig: Dette tillegget inneholder oversettelser til flere språk av sikkerhetsinformasjonen i denne veiledningen.

Importante: Este anexo contém traduções em vários idiomas das advertências de segurança neste guia.







Importante: Este apéndice contiene traducciones en múltiples idiomas de los mensajes de seguridad incluidos en esta guía.

Obs! Denna bilaga innehåller flerspråkiga översättningar av säkerhetsmeddelandena i denna handledning.













Standards: This product meets the following safety standards.





U.S. Federal Communications Commission	
RADIATED ENERGY	
<p>Note: This equipment has been tested and found to comply with the limits for a Class A digital device pursuant to Part 15 of the FCC Rules. These limits are designed to provide reasonable protection against harmful interference when the equipment is operated in a commercial environment. This equipment generates, uses, and can radiate radio frequency energy and, if not installed and used in accordance with this instruction manual, may cause harmful interference to radio communications. Operation of this equipment in a residential area is likely to cause harmful interference in which case the user will be required to correct the interference at his own expense.</p> <p>Note: Modifications or changes not expressly approved by the manufacturer or the FCC can void your right to operate this equipment.</p>	

Canadian Department of Communications	
<p>This Class A digital apparatus meets all requirements of the Canadian Interference-Causing Equipment Regulations.</p> <p>Cet appareil numérique de la classe A respecte toutes les exigences du Règlement sur le matériel brouilleur du Canada.</p>	



- | | | |
|---|---|--|
|  | 1 RFI Emission | FCC Class A, EN55022 Class A, VCCI Class A, C-TICK, EN61000-3-2, EN61000-3-3 |
|  |  2 WARNING: In a domestic environment this product may cause radio interference in which case the user may be required to take adequate measures. | |
|  | 3 Immunity | EN55024 |
|  | 4 Electrical Safety | UL 1950 (UL/cUL), EN60950 (TUV) |
|  |  5 Laser | EN60825 |

SAFETY









- | | | |
|---|---|--|
|  |  6 WARNING: Class 1 Laser product. | |
|  |  7 WARNING: Do not stare into the laser beam. | |
|  |  8 ELECTRICAL NOTICES
WARNING: ELECTRIC SHOCK HAZARD
To prevent ELECTRIC shock, do not remove the cover. No user-serviceable parts inside. This unit contains HAZARDOUS VOLTAGES and should only be opened by a trained and qualified technician. To avoid the possibility of ELECTRIC SHOCK, disconnect electric power to the product before connecting or disconnecting the LAN cables. | |
|  |  9 LIGHTNING DANGER
DANGER: DO NOT WORK on equipment or CABLES during periods of LIGHTNING ACTIVITY. | |
|  |  10 CAUTION: POWER CORD IS USED AS A DISCONNECTION DEVICE. TO DE-ENERGIZE EQUIPMENT, disconnect the power cord. | |
|  |  11 ELECTRICAL - TYPE CLASS 1 EQUIPMENT
THIS EQUIPMENT MUST BE EARTHED. Power plug must be connected to a properly wired earth ground socket outlet. An improperly wired socket outlet could place hazardous voltages on accessible metal parts. | |

- 12  **PLUGGABLE EQUIPMENT**, the socket outlet shall be installed near the equipment and shall be easily accessible.
- 13  **CAUTION:** Air vents must not be blocked and must have free access to the room ambient air for cooling.
- 14  **OPERATING TEMPERATURE:** This product is designed for a maximum ambient temperature of 40° degrees C.
- 15  **ALL COUNTRIES:** Install product in accordance with local and National Electrical Codes.

Normen: Dieses Produkt erfüllt die Anforderungen der nachfolgenden Normen.





- 1 Hochfrequenzstörung FCC Klasse A, EN55022 Klasse A, VCCI Class A, C-TICK, EN61000-3-2, EN61000-3-3
- 2  **WARNUNG:** Bei Verwendung zu Hause kann dieses Produkt Funkstörungen hervorrufen. In diesem Fall müßte der Anwender angemessene Gegenmaßnahmen ergreifen.
- 3 Störsicherheit EN55024
- 4 Elektrische Sicherheit UL 1950 (UL/cUL), EN60950 (TUV)
- 5  Laser EN60825

SICHERHEIT











- 6  **WARNUNG** Laserprodukt der Klasse 1.
- 7  **WARNUNG** Nicht direkt in den Strahl blicken.
- 8  **ACHTUNG: GEFÄHRLICHE SPANNUNG**
Das Gehäuse nicht öffnen. Das Gerät enthält keine vom Benutzer wartbaren Teile. Das Gerät steht unter Hochspannung und darf nur von qualifiziertem technischem Personal geöffnet werden. Vor Anschluß der LAN-Kabel, Gerät vom Netz trennen.
- 9  **GEFAHR DURCH BLITZSCHLAG**
GEFAHR: Keine Arbeiten am Gerät oder an den Kabeln während eines Gewitters ausführen.
- 10  **VORSICHT:** DAS NETZKABEL DIENT ZUM TRENNEN DER STROMVERSORGUNG. ZUR TRENNUNG VOM NETZ, KABEL AUS DER STECKDOSE ZIEHEN.
- 11  **GERÄTE DER KLASSE 1**
DIESE GERÄTE MÜSSEN GEERDET SEIN. Der Netzstecker darf nur mit einer vorschriftsmäßig geerdeten Steckdose verbunden werden. Ein unvorschriftsmäßiger Anschluß kann die Metallteile des Gehäuses unter gefährliche elektrische Spannungen setzen.
- 12  **STECKBARES GERÄT:** Die Anschlußbuchse sollte in der Nähe der Einrichtung angebracht werden und leicht zugänglich sein."
- 13  **VORSICHT**
Die Entlüftungsöffnungen dürfen nicht versperrt sein und müssen zum Kühlen freien Zugang zur Raumluft haben.
- 14  **BETRIEBSTEMPERATUR:** Dieses Produkt wurde für den Betrieb in einer Umgebungstemperatur von nicht mehr als 40° C entworfen.

- 15  **ALLE LÄNDER:** Installation muß örtlichen und nationalen elektrischen Vorschriften entsprechen.



Standarder: Dette produkt tilfredsstillter de følgende standarder.

- 1  Radiofrekvens forstyrrelsesemission FCC Klasse A, EN55022 Klasse A, VCCI Class A, C-TICK, EN61000-3-2, EN61000-3-3
- 2  **ADVARSEL:** I et hjemligt miljø kunne dette produkt forårsage radio forstyrrelse. Bliver det tilfældet, påkræves brugeren muligvis at tage tilstrækkelige foranstaltninger.
- 3  Immunitet EN55024
- 4  Elektrisk sikkerhed UL 1950 (UL/cUL), EN60950 (TUV)
- 5  Laser EN60825











SIKKERHED

- 6  **ADVARSEL** Laserprodukt av klasse 1.
- 7  **ADVARSEL** Stirr ikke på strålen.
- 8  **ELEKTRISKE FORHOLDSREGLER**
ADVARSEL: RISIKO FOR ELEKTRISK STØD
 For at forebygge ELEKTRISK stød, undlad at åbne apparatet. Der er ingen indre dele, der kan repareres af brugeren. Denne enhed indeholder LIVSFARLIGE STRØMSPÆNDINGER og bør kun åbnes af en uddannet og kvalificeret tekniker. For at undgå risiko for ELEKTRISK STØD, afbrydes den elektriske strøm til produktet, før LAN-kablerne monteres eller afmonteres.
- 9  **FARE UNDER UVEJR**
FARE: UNDLAD at arbejde på udstyr eller KABLER i perioder med LYNAKTIVITET.
- 10  **ADVARSEL: DEN STRØMFØRENDE LEDNING BRUGES TIL AT AFBRYDE STRØMMEN.** SKAL STRØMMEN TIL APPARATET AFBRYDES, tages ledningen ud af stikket.
- 11  **ELEKTRISK - KLASSE 1-UDSTYR**
 DETTE Udstyr KRÆVER JORDFORBINDELSE. Stikket skal være forbundet med en korrekt installeret jordforbunden stikkontakt. En ukorrekt installeret stikkontakt kan sætte livsfarlig spænding til tilgængelige metaldele.
- 12  **UDSTYR TIL STIKKONTAKT**, stikkontakten bør installeres nær ved udstyret og skal være lettilgængelig.
- 13  **ADVARSEL:** Ventilationsåbninger må ikke blokeres og skal have fri adgang til den omgivende luft i rummet for afkøling.
- 14  **BETJENINGSTEMPERATUR:** Dette apparat er konstrueret til en omgivende temperatur på maksimum 40 grader C.
- 15  **ALLE LANDE:** Installation af produktet skal ske i overensstemmelse med lokal og national lovgivning for elektriske installationer.



Eisen: Dit product voldoet aan de volgende eisen.

- | | | |
|---|---|--|
| 1 | RFI Emissie | FCC Klasse A, EN55022 Klasse A, VCCI Class A, C-TICK, EN61000-3-2, EN61000-3-3 |
| 2 |  WAARSCHUWING: Binnenshuis kan dit product radiostoring veroorzaken, in welk geval de gebruiker verplicht kan worden om gepaste maatregelen te nemen. | |
| 3 | Immunititeit | EN55024 |
| 4 | Electrische Veiligheid | UL 1950 (UL/cUL), EN60950 (TUV) |
| 5 |  Laser | EN60825 |











VEILIGHEID

- | | | |
|----|---|--|
| 6 |  WAARSCHUWING Klasse-1 laser produkt. | |
| 7 |  WAARSCHUWING Niet in de straal staren. | |
| 8 |  WAARSCHUWINGEN MET BETREKKING TOT ELEKTRICITEIT
WAARSCHUWING: GEVAAR VOOR ELEKTRISCHE SCHOKKEN
Verwijder het deksel niet, teneinde ELEKTRISCHE schokken te voorkomen. Binnenin bevinden zich geen onderdelen die door de gebruiker onderhouden kunnen worden. Dit toestel staat onder GEVAARLIJKE SPANNING en mag alleen worden geopend door een daartoe opgeleide en bevoegde technicus. Om het gevaar op ELEKTRISCHE SCHOKKEN te vermijden, moet u het toestel van de stroombron ontkoppelen alvorens de LAN-kabels te koppelen of ontkoppelen. | |
| 9 |  GEVAAR VOOR BLIKSEMINSLAG
GEVAAR: NIET aan toestellen of KABELS WERKEN bij BLIKSEM. | |
| 10 |  WAARSCHUWING: HET TOESTEL WORDT UITGESCHAKELD DOOR DE STROOMKABEL TE ONTKOPPELEN. OM HET TOESTEL STROOMLOOS TE MAKEN: de stroomkabel ontkoppelen. | |
| 11 |  ELEKTRISCHE TOESTELLEN VAN KLASSE 1
DIT TOESTEL MOET GEAARD WORDEN. De stekker moet aangesloten zijn op een juist geaarde contactdoos. Een onjuist geaarde contactdoos kan de metalen onderdelen waarmee de gebruiker eventueel in aanraking komt onder gevaarlijke spanning stellen. | |
| 12 |  AAN TE SLUITEN APPARATUUR , de contactdoos wordt in de nabijheid van de apparatuur geïnstalleerd en is gemakkelijk te bereiken." | |
| 13 |  OPGELET: De ventilatiegaten mogen niet worden gesperd en moeten de omgevingslucht ongehinderd toelaten voor afkoeling. | |
| 14 |  BEDRIJFSTEMPERATUUR: De omgevingstemperatuur voor dit produkt mag niet meer bedragen dan 40 graden Celsius. | |
| 15 |  ALLE LANDEN: het toestel installeren overeenkomstig de lokale en nationale elektrische voorschriften. | |



Normes: ce produit est conforme aux normes de suivantes:

- 1 Emission d'interférences radioélectriques FCC Classe A, EN55022 Classe A, VCCI Class A, C-TICK, EN61000-3-2, EN61000-3-3
- 2  **MISE EN GARDE** : dans un environnement domestique, ce produit peut provoquer des interférences radioélectriques. Auquel cas, l'utilisateur devra prendre les mesures adéquates.
- 3 Immunité EN55024
- 4 Sécurité électrique UL 1950 (UL/cUL), EN60950 (TUV)
- 5  Laser EN60825











SÉCURITÉ

- 6  **ATTENTION** Produit laser di classe 1.
- 7  **ATTENTION** Ne pas fixer le faisceau des yeux.
- 8  **INFORMATION SUR LES RISQUES ÉLECTRIQUES**
AVERTISSEMENT: DANGER D'ÉLECTROCUTION
 Pour éviter toute ÉLECTROCUTION, ne pas ôter le revêtement protecteur du matériel. Ce matériel ne contient aucun élément réparable par l'utilisateur. Il comprend des TENSIONS DANGEREUSES et ne doit être ouvert que par un technicien dûment qualifié. Pour éviter tout risque d'ÉLECTROCUTION, débrancher le matériel avant de connecter ou de déconnecter les câbles LAN.
- 9  **DANGER DE Foudre**
DANGER: NE PAS MANIER le matériel ou les CÂBLES lors d'activité orageuse.
- 10  **ATTENTION: LE CORDON D'ALIMENTATION SERT DE MISE HORS CIRCUIT. POUR COUPER L'ALIMENTATION DU MATÉRIEL,** débrancher le cordon.
- 11  **ÉQUIPEMENT DE CLASSE 1 ÉLECTRIQUE**
CE MATÉRIEL DOIT ÊTRE MIS A LA TERRE. La prise de courant doit être branchée dans une prise femelle correctement mise à la terre car des tensions dangereuses risqueraient d'atteindre les pièces métalliques accessibles à l'utilisateur.
- 12  **EQUIPEMENT POUR BRANCHEMENT ELECTRIQUE,** la prise de sortie doit être placée près de l'équipement et facilement accessible".
- 13  **ATTENTION: Ne pas bloquer les fentes d'aération,** ceci empêcherait l'air ambiant de circuler librement pour le refroidissement.
- 14  **TEMPÉRATURE DE FONCTIONNEMENT:** Ce matériel est capable de tolérer une température ambiante maximum de ou 40 degrés Celsius.
- 15  **POUR TOUS PAYS:** Installer le matériel conformément aux normes électriques nationales et locales.



Standardit: Tämä tuote on seuraavien standardien mukainen.

- | | | |
|-----|--|--|
| 🔊 1 | Radioaaltojen häirintä | FCC Luokka A, EN55022 Luokka A, VCCI Class A, C-TICK, EN61000-3-2, EN61000-3-3 |
| 🔊 2 |  VAROITUS: Kotiolosuhteissa tämä laite voi aiheuttaa radioaaltojen häiröitä, missä tapauksessa laitteen käyttäjän on mahdollisesti ryhdyttävä tarpeellisiin toimenpiteisiin. | |
| 🔊 3 | Kestävyys | EN55024 |
| 🔊 4 | Sähköturvallisuus | UL 1950 (UL/cUL), EN60950 (TUV) |
| 🔊 5 |  Laser | EN60825 |











TURVALLISUUS

- | | | |
|------|--|--|
| 🔊 6 |  VAROITUS Luokan 1 Lasertuote. | |
| 🔊 7 |  VAROITUS Älä katso säteeseen. | |
| 🔊 8 |  SÄHKÖÖN LIITTYVIÄ HUOMAUTUKSIA
VAROITUS: SÄHKÖISKUVAARA
Estääksesi SÄHKÖISKUN älä poista kantta. Sisällä ei ole käyttäjän huollettavissa olevia osia. Tämä laite sisältää VAARALLISIA JÄNNITTEITÄ ja sen voi avata vain koulutettu ja pätevä teknikko. Vältä äläkätkä SÄHKÖISKUN mahdollisuuden katkaista sähkövirta tuotteeseen ennen kuin liität tai irrotat paikallisverkon (LAN) kaapelit. | |
| 🔊 9 |  SALAMANISKUVAARA
HENGENVAARA: ÄLÄ TYÖSKENTELE laitteiden tai KAAPELEIDEN KANSSA SALAMOINNIN AIKANA. | |
| 🔊 10 |  HUOMAUTUS: VIRTALOHTOA KÄYTETÄÄN VIRRANKATKAISULAITTEENA. VIRTA KATKAISTAAN irrottamalla virtajohto. | |
| 🔊 11 |  SÄHKÖ - TYYPPILUOKAN 1 LAITTEET
TÄMÄ LAITE TÄYTY MAADOITTA. Pistoke täytyy liittää kunnollisesti maadoitettuun pistorasiaan. Virheellisesti johdotettu pistorasia voi altistaa metalliosat vaarallisille jännitteille. | |
| 🔊 12 |  PISTORASIAAN KYTKETTÄVÄ LAITE; pistorasia on asennettava laitteen lähelle ja siihen on oltava esteetön pääsy." | |
| 🔊 13 |  HUOMAUTUS: Ilmavaihtoreikiä ei pidä tukkia ja niillä täytyy olla vapaa yhteys ympäröivään huoneilmaan, jotta ilmanvaihto tapahtuisi. | |
| 🔊 14 |  KÄYTTÖLÄMPÖTILA: Tämä tuote on suunniteltu ympäröivän ilman maksimilämpötilalle 40°C. | |
| 🔊 15 |  KAIKKI MAAT: Asenna tuote paikallisten ja kansallisten sähköturvallisuusmääräysten mukaisesti. | |



Standard: Questo prodotto è conforme ai seguenti standard.

- 🌀 1 Emissione RFI (interferenza di radiofrequenza) FCC Classe A, EN55022 Classe A, VCCI Class A, C-TICK, EN61000-3-2, EN61000-3-3
- 🌀 2  **AVVERTENZA:** in ambiente domestico questo prodotto potrebbe causare radio interferenza. In questo caso potrebbe richiedersi all'utente di prendere gli adeguati provvedimenti.
- 🌀 3 Immunità EN55024
- 🌀 4 Sicurezza elettrica UL 1950 (UL/cUL), EN60950 (TUV)
- 🌀 5  Laser EN60825











NORME DI SICUREZZA

- 🌀 6  **AVVERTENZA** Prodotto laser di Classe 1.
- 🌀 7  **AVVERTENZA** Non fissare il raggio con gli occhi.
- 🌀 8  **AVVERTENZE ELETTRICHE**
ATTENZIONE: PERICOLO DI SCOSSE ELETTRICHE
 Per evitare SCOSSE ELETTRICHE non asportare il coperchio. Le componenti interne non sono riparabili dall'utente. Questa unità ha TENSIONI PERICOLOSE e va aperta solamente da un tecnico specializzato e qualificato. Per evitare ogni possibilità di SCOSSE ELETTRICHE, interrompere l'alimentazione del dispositivo prima di collegare o staccare i cavi LAN.
- 🌀 9  **PERICOLO DI FULMINI**
PERICOLO: NON LAVORARE sul dispositivo o sui CAVI durante PRECIPITAZIONI TEMPORALESCHESCHE.
- 🌀 10  **ATTENZIONE: IL CAVO DI ALIMENTAZIONE È USATO COME DISPOSITIVO DI DISATTIVAZIONE. PER TOGLIERE LA CORRENTE AL DISPOSITIVO** staccare il cavo di alimentazione.
- 🌀 11  **ELETTRICITÀ - DISPOSITIVI DI CLASSE 1**
QUESTO DISPOSITIVO DEVE AVERE LA MESSA A TERRA. La spina deve essere inserita in una presa di corrente specificamente dotata di messa a terra. Una presa non cablata in maniera corretta rischia di scaricare una tensione pericolosa su parti metalliche accessibili.
- 🌀 12  **APPARECCHIATURA COLLEGABILE, la presa va installata vicino all'apparecchio per risultare facilmente accessibile".**
- 🌀 13  **ATTENZIONE:** le prese d'aria non vanno ostruite e devono consentire il libero ricircolo dell'aria ambiente per il raffreddamento.
- 🌀 14  **TEMPERATURA DI FUNZIONAMENTO:** Questo prodotto è concepito per una temperatura ambientale massima di 40 gradi centigradi.
- 🌀 15  **TUTTI I PAESI:** installare il prodotto in conformità delle vigenti normative elettriche nazionali.







Sikkerhetsnormer: Dette produktet tilfredsstiller følgende sikkerhetsnormer.

- | | | |
|-----|---|--|
| ☞ 1 | RFI stråling | FCC Klasse A, EN55022 Klasse A, VCCI Class A, C-TICK, EN61000-3-2, EN61000-3-3 |
| ☞ 2 |  ADVARSEL: Hvis dette produktet benyttes til privat bruk, kan produktet forårsake radioforstyrrelse. Hvis dette skjer, må brukeren ta de nødvendige forholdsregler. | |
| ☞ 3 | Immunitet | EN55024 |
| ☞ 4 | Elektrisk sikkerhet | UL 1950 (UL/cUL), EN60950 (TUV) |
| ☞ 5 |  Laser | EN60825 |





















SIKKERHET

- | | | |
|------|--|--|
| ☞ 6 |  ADVARSEL Laserprodukt av klasse 1. | |
| ☞ 7 |  ADVARSEL Stirr ikke på strålen. | |
| ☞ 8 |  ELEKTRISITET
ADVARSEL: FARE FOR ELEKTRISK SJOKK
For å unngå ELEKTRISK sjokk, må dekslet ikke tas av. Det finnes ingen deler som brukeren kan reparere på innsiden. Denne enheten inneholder FARLIGE SPENNINGER, og må kun åpnes av en faglig kvalifisert tekniker. For å unngå ELEKTRISK SJOKK må den elektriske strømmen til produktet være avslått før LAN-kablene til- eller frakobles. | |
| ☞ 9 |  FARE FOR LYNNEDSLAG
FARE: ARBEID IKKE på utstyr eller KABLER i TORDENVÆR. | |
| ☞ 10 |  FORSIKTIG: STRØMLEDNINGEN BRUKES TIL Å FRAKOBLE UTSTYRET. FOR Å DEAKTIVISERE UTSTYRET, må strømforsyningen kobles fra. | |
| ☞ 11 |  ELEKTRISK - TYPE 1- KLASSE UTSTYR
DETTE UTSTYRET MÅ JORDES. Strømkontakten må være tilkopleet en korrekt jordet kontakt. En kontakt som ikke er korrekt jordet kan føre til farlig spenninger i lett tilgjengelige metalleder. | |
| ☞ 12 |  UTSTYR FOR STIKKONTAKT. Stikkontakten skal monteres i nærheten av utstyret og skal være lett tilgjengelig." | |
| ☞ 13 |  FORSIKTIG: Lufteventilene må ikke blokkeres, og må ha fri tilgang til luft med romtemperatur for avkjøling. | |
| ☞ 14 |  DRIFTSTEMPERATUR: Dette produktet er konstruert for bruk i maksimum romtemperatur på 40 grader celsius. | |
| ☞ 15 |  ALLE LAND: Produktet må installeres i samsvar med de lokale og nasjonale elektriske koder. | |



Padrões: Este produto atende aos seguintes padrões.

-  **1** Emissão de interferência de radiofrequência FCC Classe A, EN55022 Classe A, VCCI Class A, C-TICK, EN61000-3-2, EN61000-3-3
-  **2**  **AVISO:** Num ambiente doméstico este produto pode causar interferência na radiorrecepção e, neste caso, pode ser necessário que o utente tome as medidas adequadas.
-  **3** Imunidade EN55024
-  **4** Segurança Eléctrica UL 1950 (UL/cUL), EN60950 (TUV)
-  **5**  Laser EN60825











SEGURANÇA

-  **6**  **AVISO** Produto laser de classe 1
-  **7**  **AVISO** Não olhe fixamente para o raio.
-  **8**  **AVISOS SOBRE CARACTERÍSTICAS ELÉTRICAS**
ATENÇÃO: PERIGO DE CHOQUE ELÉTRICO
 Para evitar CHOQUE ELÉTRICO, não retire a tampa. Não contém peças que possam ser consertadas pelo usuário. Este aparelho contém VOLTAGENS PERIGOSAS e só deve ser aberto por um técnico qualificado e treinado. Para evitar a possibilidade de CHOQUE ELÉTRICO, desconecte o aparelho da fonte de energia elétrica antes de conectar e desconectar os cabos da LAN.
-  **9**  **PERIGO DE CHOQUE CAUSADO POR RAI**
PERIGO: NÃO TRABALHE no equipamento ou nos CABOS durante períodos suscetíveis a QUEDAS DE RAI.
-  **10**  **CUIDADO: O CABO DE ALIMENTAÇÃO É UTILIZADO COMO UM DISPOSITIVO DE DESCONEXÃO. PARA DESELETRIFICAR O EQUIPAMENTO,** desconecte o cabo de ALIMENTAÇÃO.
-  **11**  **ELÉTRICO - EQUIPAMENTOS DO TIPO CLASSE 1**
DEVE SER FEITA LIGAÇÃO DE FIO TERRA PARA ESTE EQUIPAMENTO. O plugue de alimentação deve ser conectado a uma tomada com adequada ligação de fio terra. Tomadas sem adequada ligação de fio terra podem transmitir voltagens perigosas a peças metálicas expostas.
-  **12**  **EQUIPAMENTO DE LIGAÇÃO,** a tomada eléctrica deve estar instalada perto do equipamento e ser de fácil acesso."
-  **13**  **CUIDADO:** As aberturas de ventilação não devem ser bloqueadas e devem ter acesso livre ao ar ambiente para arrefecimento adequado do aparelho.
-  **14**  **TEMPERATURA DE FUNCIONAMENTO:** Este produto foi projetado para uma temperatura ambiente máxima de 40 graus centígrados.
-  **15**  **TODOS OS PAÍSES:** Instale o produto de acordo com as normas nacionais e locais para instalações eléctricas.



Estándares: Este producto cumple con los siguientes estándares.

- | | | |
|---|---|--|
| 1 | Emisión RFI | FCC Clase A, EN55022 Clase A, VCCI Class A, C-TICK, EN61000-3-2, EN61000-3-3 |
| 2 |  ADVERTENCIA: en un entorno doméstico, este producto puede causar radiointerferencias, en cuyo caso, puede requerirse del usuario que tome las medidas que sean convenientes al respecto. | |
| 3 | Inmunidad | EN55024 |
| 4 | Seguridad eléctrica | UL 1950 (UL/cUL), EN60950 (TUV) |
| 5 |  Laser | EN60825 |











SEGURIDAD

- | | | |
|----|--|--|
| 6 |  ¡ADVERTENCIA! Producto láser Clase 1. | |
| 7 |  ¡ADVERTENCIA! No mirat fijamente el haz. | |
| 8 |  AVISOS ELECTRICOS
ADVERTENCIA: PELIGRO DE ELECTROCHOQUE
Para evitar un ELECTROCHOQUE, no quite la tapa. No hay ningún componente en el interior al cual puede prestar servicio el usuario. Esta unidad contiene VOLTAJES PELIGROSOS y sólo deberá abrirla un técnico entrenado y calificado. Para evitar la posibilidad de ELECTROCHOQUE desconecte la corriente eléctrica que llega al producto antes de conectar o desconectar los cables LAN. | |
| 9 |  PELIGRO DE RAYOS
PELIGRO: NO REALICE NINGUN TIPO DE TRABAJO O CONEXION en los equipos o en LOS CABLES durante TORMENTAS ELECTRICAS. | |
| 10 |  ATENCION: EL CABLE DE ALIMENTACION SE USA COMO UN DISPOSITIVO DE DESCONEXION. PARA DESACTIVAR EL EQUIPO, desconecte el cable de alimentación. | |
| 11 |  ELECTRICO - EQUIPO DEL TIPO CLASE 1
ESTE EQUIPO TIENE QUE TENER CONEXION A TIERRA. El cable tiene que conectarse a un enchufe a tierra debidamente instalado. Un enchufe que no está correctamente instalado podría ocasionar tensiones peligrosas en las partes metálicas que están expuestas. | |
| 12 |  EQUIPO CONECTABLE, el tomacorriente se debe instalar cerca del equipo, en un lugar con acceso fácil". | |
| 13 |  ATENCION: Las aberturas para ventilación no deberán bloquearse y deberán tener acceso libre al aire ambiental de la sala para su enfriamiento. | |
| 14 |  TEMPERATURA REQUERIDA PARA LA OPERACIÓN: Este producto está diseñado para una temperatura ambiental máxima de 40 grados C. | |
| 15 |  PARA TODOS LOS PAÍSES: Monte el producto de acuerdo con los Códigos Eléctricos locales y nacionales. | |

Standarder: Denna produkt uppfyller följande standarder.

- | | | |
|---|---|--|
| 1 | Radiostörning | FCC Klass A, EN55022 Klass A, VCCI Class A, C-TICK, EN61000-3-2, EN61000-3-3 |
| 2 |  WARNING: Denna produkt kan ge upphov till radiostörningar i hemmet, vilket kan tvinga användaren till att vidtaga erforderliga åtgärder. | |
| 3 | Immunitet | EN55024 |
| 4 | Elsäkerhet | UL 1950 (UL/cUL), EN60950 (TUV) |
| 5 |  Laser | EN60825 |

SÄKERHET

- | | | |
|----|--|--|
| 6 |  WARNING! Laserprodukt av klass 1. | |
| 7 |  WARNING! Laserstrålning när enheten är öppen. | |
| 8 |  TILLKÄNNAGIVANDEN BETRÄFFANDE ELEKTRICITETSRIK:
RISK FÖR ELEKTRISK STÖT För att undvika ELEKTRISK stöt, ta ej av locket. Det finns inga delar inuti som behöver underhållas. Denna apparat är under HÖGSPÄNNING och får endast öppnas av en utbildad kvalificerad tekniker. För att undvika ELEKTRISK STÖT, koppla ifrån produktens strömanslutning innan LAN-kablarna ansluts eller kopplas ur. | |
| 9 |  FARA FÖR BLIXTNEDSLAG
FARA: ARBETA EJ på utrustningen eller kablarna vid ÅSKVÄDER. | |
| 10 |  WARNING: NÄTKABELN ANVÄNDS SOM STRÖMBRYTARE FÖR ATT KOPPLA FRÅN STRÖMMEN, dra ur nätkabeln. | |
| 11 |  ELEKTRISKT - TYP KLASS 1 UTRUSTNING
DENNA UTRUSTNING MÅSTE VARA JORDAD. Nätkabeln måste vara ansluten till ett ordentligt jordat uttag. Ett felaktigt uttag kan göra att närliggande metalldelar utsätts för högspänning. Apparaten skall anslutas till jordat uttag, när den ansluts till ett nätverk. | |
| 12 |  UTRUSTNING MED PLUGG. Uttaget skall installeras i utrustningens närhet och vara lättåtkomligt". | |
| 13 |  WARNING: Luftventilerna får ej blockeras och måste ha fri tillgång till omgivande rumsluft för avsvälvning. | |
| 14 |  DRIFTSTEMPERATUR: Denna produkt är konstruerad för rumstemperatur ej överstigande 40 grader Celsius. | |
| 15 |  ALLA LÄNDER: Installera produkten i enlighet med lokala och statliga bestämmelser för elektrisk utrustning. | |