

# CentreCOM<sup>®</sup> GS970M Series

## MANAGED GIGABIT ETHERNET SWITCH

**GS970M/10**

**GS970M/10PS**

**GS970M/18**

**GS970M/18PS**

**GS970M/28**

**GS970M/28PS**



# Command Reference for AlliedWare Plus™ Version 5.5.0-0.x

# Acknowledgments

This product includes software developed by the University of California, Berkeley and its contributors.

Copyright ©1982, 1986, 1990, 1991, 1993 The Regents of the University of California.

All rights reserved.

This product includes software developed by the OpenSSL Project for use in the OpenSSL Toolkit. For information about this see [www.openssl.org/](http://www.openssl.org/)

Copyright ©1998-2008 The OpenSSL Project. All rights reserved.

This product includes software licensed under v2 and v3 of the GNU General Public License, available from: [www.gnu.org/licenses/gpl2.html](http://www.gnu.org/licenses/gpl2.html) and [www.gnu.org/licenses/gpl.html](http://www.gnu.org/licenses/gpl.html) respectively.

Source code for all GPL licensed software in this product can be obtained from the Allied Telesis GPL Code Download Center at: [www.alliedtelesis.com/support/](http://www.alliedtelesis.com/support/)

Allied Telesis is committed to meeting the requirements of the open source licenses including the GNU General Public License (GPL) and will make all required source code available.

If you would like a copy of the GPL source code contained in Allied Telesis products, please send us a request by registered mail including a check for US\$15 to cover production and shipping costs and a CD with the GPL code will be mailed to you.

**GPL Code Request**  
**Allied Telesis Labs (Ltd)**  
**PO Box 8011**  
**Christchurch**  
**New Zealand**

Allied Telesis, AlliedWare Plus, Allied Telesis Management Framework, EPSRing, SwitchBlade, VCStack, and VCStack Plus are trademarks or registered trademarks in the United States and elsewhere of Allied Telesis, Inc.

Microsoft and Internet Explorer are registered trademarks of Microsoft Corporation. All other product names, company names, logos or other designations mentioned herein may be trademarks or registered trademarks of their respective owners.

© 2020 Allied Telesis, Inc.

All rights reserved. No part of this publication may be reproduced without prior written permission from Allied Telesis, Inc.

Allied Telesis, Inc. reserves the right to make changes in specifications and other information contained in this document without prior written notice. The information provided herein is subject to change without notice. In no event shall Allied Telesis, Inc. be liable for any incidental, special, indirect, or consequential damages whatsoever, including but not limited to lost profits, arising out of or related to this manual or the information contained herein, even if Allied Telesis, Inc. has been advised of, known, or should have known, the possibility of such damages.

---

# Contents

<b>PART 1:</b>	<b>Setup and Troubleshooting</b>	<b>.68</b>
<b>Chapter 1:</b>	<b>CLI Navigation Commands</b>	<b>.69</b>
	Introduction	.69
	configure terminal	.70
	disable (Privileged Exec mode)	.71
	do	.72
	enable (Privileged Exec mode)	.73
	end	.75
	exit	.76
	help	.77
	logout	.78
	show history	.79
<b>Chapter 2:</b>	<b>File and Configuration Management Commands</b>	<b>.80</b>
	Introduction	.80
	autoboot enable	.83
	boot config-file	.84
	boot config-file backup	.86
	boot system	.87
	boot system backup	.89
	cd	.90
	copy (filename)	.91
	copy current-software	.93
	copy debug	.94
	copy running-config	.95
	copy startup-config	.96
	copy zmodem	.97
	create autoboot	.98
	delete	.99
	delete debug	100
	dir	101
	edit	103
	edit (filename)	104

erase factory-default . . . . .	105
erase startup-config . . . . .	106
ip tftp source-interface . . . . .	107
ipv6 tftp source-interface . . . . .	108
mkdir . . . . .	109
move . . . . .	110
move debug . . . . .	111
pwd . . . . .	112
rmdir . . . . .	113
show autoboot . . . . .	114
show boot . . . . .	115
show file . . . . .	117
show file systems . . . . .	118
show running-config . . . . .	120
show running-config interface . . . . .	123
show startup-config . . . . .	125
show version . . . . .	126
unmount . . . . .	127
write file . . . . .	128
write memory . . . . .	129
write terminal . . . . .	130

**Chapter 3: User Access Commands . . . . . 131**

Introduction . . . . .	131
aaa authentication enable default local . . . . .	133
aaa local authentication attempts lockout-time . . . . .	134
aaa local authentication attempts max-fail . . . . .	135
aaa login fail-delay . . . . .	136
clear aaa local user lockout . . . . .	137
clear line console . . . . .	138
clear line vty . . . . .	139
enable password . . . . .	140
enable secret . . . . .	143
exec-timeout . . . . .	146
flowcontrol hardware (asyn/console) . . . . .	148
length (asyn) . . . . .	150
line . . . . .	151
privilege level . . . . .	153
security-password history . . . . .	154
security-password forced-change . . . . .	155
security-password lifetime . . . . .	156
security-password min-lifetime-enforce . . . . .	157
security-password minimum-categories . . . . .	158
security-password minimum-length . . . . .	159
security-password reject-expired-pwd . . . . .	160
security-password warning . . . . .	161
service advanced-vty . . . . .	162
service password-encryption . . . . .	163
service telnet . . . . .	164
service terminal-length (deleted) . . . . .	165
show aaa local user locked . . . . .	166
show privilege . . . . .	167
show security-password configuration . . . . .	168

	show security-password user . . . . .	169
	show telnet . . . . .	170
	show users . . . . .	171
	telnet . . . . .	172
	telnet server . . . . .	173
	terminal length . . . . .	174
	terminal resize . . . . .	175
	username . . . . .	176
<b>Chapter 4:</b>	<b>Feature Licensing Commands . . . . .</b>	<b>178</b>
	Introduction . . . . .	178
	license . . . . .	179
	show license . . . . .	181
	show license brief . . . . .	183
<b>Chapter 5:</b>	<b>Subscription Licensing Commands . . . . .</b>	<b>185</b>
	Introduction . . . . .	185
	license update (filename) . . . . .	186
	license update online . . . . .	187
	show license external . . . . .	188
<b>Chapter 6:</b>	<b>GUI Commands . . . . .</b>	<b>189</b>
	Introduction . . . . .	189
	atmf topology-gui enable . . . . .	190
	gui-timeout . . . . .	191
	http port . . . . .	192
	http secure-port . . . . .	193
	log event-host . . . . .	194
	service http . . . . .	195
	show http . . . . .	196
<b>Chapter 7:</b>	<b>System Configuration and Monitoring Commands . . . . .</b>	<b>197</b>
	Introduction . . . . .	197
	banner exec . . . . .	199
	banner login (system) . . . . .	201
	banner motd . . . . .	203
	clock set . . . . .	205
	clock summer-time date . . . . .	206
	clock summer-time recurring . . . . .	208
	clock timezone . . . . .	210
	debug core-file . . . . .	211
	ecofriendly led . . . . .	212
	findme . . . . .	213
	hostname . . . . .	215
	max-fib-routes . . . . .	217
	max-static-routes . . . . .	218
	no debug all . . . . .	219
	reboot . . . . .	221
	reload . . . . .	222
	show clock . . . . .	223
	show cpu . . . . .	225
	show cpu history . . . . .	228

show debugging	230
show ecofriendly	231
show interface memory	232
show memory	234
show memory allocations	236
show memory history	238
show memory pools	239
show memory shared	240
show process	241
show reboot history	243
show router-id	244
show system	245
show system environment	246
show system interrupts	247
show system mac	248
show system serialnumber	249
show tech-support	250
speed (asyn)	252
system territory (deprecated)	254
terminal monitor	255
undebg all	256

**Chapter 8: Pluggables and Cabling Commands . . . . . 257**

Introduction	257
clear fiber-monitoring interface	258
clear test cable-diagnostics tdr	259
debug fiber-monitoring	260
fiber-monitoring action	262
fiber-monitoring baseline	264
fiber-monitoring enable	266
fiber-monitoring interval	267
fiber-monitoring sensitivity	268
show system fiber-monitoring	270
show system pluggable	273
show system pluggable detail	275
show system pluggable diagnostics	278
show test cable-diagnostics tdr	280
test cable-diagnostics tdr interface	281

**Chapter 9: Logging Commands . . . . . 282**

Introduction	282
clear exception log	284
clear log	285
clear log buffered	286
clear log external	287
clear log permanent	288
copy buffered-log	289
copy permanent-log	290
default log buffered	291
default log console	292
default log email	293
default log external	294

---

default log host . . . . .	295
default log monitor . . . . .	296
default log permanent . . . . .	297
log buffered . . . . .	298
log buffered (filter) . . . . .	299
log buffered exclude . . . . .	302
log buffered size . . . . .	305
log console . . . . .	306
log console (filter) . . . . .	307
log console exclude . . . . .	310
log email . . . . .	313
log email (filter) . . . . .	314
log email exclude . . . . .	317
log email time . . . . .	320
log external . . . . .	322
log external (filter) . . . . .	324
log external exclude . . . . .	327
log external rotate . . . . .	330
log external size . . . . .	332
log facility . . . . .	333
log host . . . . .	335
log host (filter) . . . . .	337
log host exclude . . . . .	340
log host source . . . . .	343
log host startup-delay . . . . .	344
log host time . . . . .	346
log monitor (filter) . . . . .	348
log monitor exclude . . . . .	351
log permanent . . . . .	354
log permanent (filter) . . . . .	355
log permanent exclude . . . . .	358
log permanent size . . . . .	361
log-rate-limit nsm . . . . .	362
log trustpoint . . . . .	363
show counter log . . . . .	364
show exception log . . . . .	365
show log . . . . .	366
show log config . . . . .	368
show log external . . . . .	370
show log permanent . . . . .	371
show running-config log . . . . .	372
unmount . . . . .	373
<b>Chapter 10: Scripting Commands . . . . .</b>	<b>374</b>
Introduction . . . . .	374
activate . . . . .	375
echo . . . . .	376
wait . . . . .	377
<b>Chapter 11: Interface Commands . . . . .</b>	<b>378</b>
Introduction . . . . .	378
description (interface) . . . . .	379

---

	interface (to configure) . . . . .	380
	mru . . . . .	382
	mtu . . . . .	383
	service statistics interfaces counter . . . . .	384
	show interface . . . . .	385
	show interface brief . . . . .	388
	show interface memory . . . . .	389
	show interface status . . . . .	391
	shutdown . . . . .	393
<b>Chapter 12:</b>	<b>Port Mirroring and Remote Mirroring Commands . . . . .</b>	<b>394</b>
	Introduction . . . . .	394
	mirror interface . . . . .	395
	remote-mirror interface . . . . .	397
	show mirror . . . . .	399
	show mirror interface . . . . .	400
	show remote-mirror . . . . .	401
	switchport remote-mirror-egress . . . . .	403
	vlan mode remote-mirror-vlan . . . . .	404
<b>PART 2:</b>	<b>Interfaces and Layer 2 . . . . .</b>	<b>406</b>
<b>Chapter 13:</b>	<b>Switching Commands . . . . .</b>	<b>407</b>
	Introduction . . . . .	407
	backpressure . . . . .	409
	clear loop-protection counters . . . . .	411
	clear mac address-table dynamic . . . . .	412
	clear mac address-table static . . . . .	414
	clear port counter . . . . .	415
	clear port-security intrusion . . . . .	416
	debug loopprot . . . . .	419
	debug platform packet . . . . .	420
	duplex . . . . .	422
	flowcontrol (switch port) . . . . .	423
	linkflap action . . . . .	425
	loop-protection loop-detect . . . . .	426
	loop-protection action . . . . .	427
	loop-protection action-delay-time . . . . .	428
	loop-protection timeout . . . . .	429
	mac address-table acquire . . . . .	430
	mac address-table ageing-time . . . . .	431
	mac address-table logging . . . . .	432
	mac address-table static . . . . .	433
	mac address-table thrash-limit . . . . .	434
	platform l3-vlan-hashing-algorithm . . . . .	435
	platform load-balancing . . . . .	436
	platform mac-vlan-hashing-algorithm . . . . .	437
	platform multicast-ratelimit . . . . .	438
	platform stop-unreg-mc-flooding . . . . .	439
	polarity . . . . .	441
	show debugging loopprot . . . . .	442
	show debugging platform packet . . . . .	443



show flowcontrol interface . . . . .	444
show interface err-disabled . . . . .	445
show interface switchport . . . . .	446
show loop-protection . . . . .	447
show mac address-table . . . . .	449
show mac address-table thrash-limit . . . . .	451
show platform . . . . .	452
show platform classifier statistics utilization brief . . . . .	455
show platform port . . . . .	457
show port-security interface . . . . .	459
show port-security intrusion . . . . .	460
show storm-control . . . . .	461
speed . . . . .	462
storm-control level . . . . .	464
switchport port-security . . . . .	465
switchport port-security aging . . . . .	466
switchport port-security maximum . . . . .	467
switchport port-security violation . . . . .	468
thrash-limiting . . . . .	469
undebg loopprot . . . . .	471
undebg platform packet . . . . .	472

**Chapter 14: VLAN Commands . . . . . 473**

Introduction . . . . .	473
port-vlan-forwarding-priority . . . . .	475
private-vlan . . . . .	478
private-vlan association . . . . .	479
show port-vlan-forwarding-priority . . . . .	480
show vlan . . . . .	481
show vlan access-map . . . . .	482
show vlan filter . . . . .	483
show vlan private-vlan . . . . .	484
switchport access vlan . . . . .	485
switchport mode access . . . . .	486
switchport mode private-vlan . . . . .	487
switchport mode private-vlan trunk promiscuous . . . . .	488
switchport mode private-vlan trunk secondary . . . . .	490
switchport mode trunk . . . . .	492
switchport private-vlan host-association . . . . .	493
switchport private-vlan mapping . . . . .	494
switchport trunk allowed vlan . . . . .	495
switchport trunk native vlan . . . . .	498
switchport voice dscp . . . . .	499
switchport voice vlan . . . . .	500
switchport voice vlan priority . . . . .	502
vlan . . . . .	503
vlan access-map . . . . .	505
vlan database . . . . .	506
vlan filter . . . . .	507

**Chapter 15: Spanning Tree Commands . . . . . 508**

Introduction . . . . .	508
------------------------	-----

clear spanning-tree statistics . . . . .	510
clear spanning-tree detected protocols (RSTP and MSTP) . . . . .	511
debug mstp (RSTP and STP) . . . . .	512
instance priority (MSTP) . . . . .	516
instance vlan (MSTP) . . . . .	518
region (MSTP) . . . . .	520
revision (MSTP) . . . . .	521
show debugging mstp . . . . .	522
show spanning-tree . . . . .	523
show spanning-tree brief . . . . .	526
show spanning-tree mst . . . . .	527
show spanning-tree mst config . . . . .	528
show spanning-tree mst detail . . . . .	529
show spanning-tree mst detail interface . . . . .	531
show spanning-tree mst instance . . . . .	533
show spanning-tree mst instance interface . . . . .	534
show spanning-tree mst interface . . . . .	535
show spanning-tree statistics . . . . .	536
show spanning-tree statistics instance . . . . .	538
show spanning-tree statistics instance interface . . . . .	539
show spanning-tree statistics interface . . . . .	541
show spanning-tree vlan range-index . . . . .	543
spanning-tree autoedge (RSTP and MSTP) . . . . .	544
spanning-tree bpdu . . . . .	545
spanning-tree cisco-interoperability (MSTP) . . . . .	547
spanning-tree edgeport (RSTP and MSTP) . . . . .	548
spanning-tree enable . . . . .	549
spanning-tree errdisable-timeout enable . . . . .	551
spanning-tree errdisable-timeout interval . . . . .	552
spanning-tree force-version . . . . .	553
spanning-tree forward-time . . . . .	554
spanning-tree guard root . . . . .	555
spanning-tree hello-time . . . . .	556
spanning-tree link-type . . . . .	557
spanning-tree max-age . . . . .	558
spanning-tree max-hops (MSTP) . . . . .	559
spanning-tree mode . . . . .	560
spanning-tree mst configuration . . . . .	561
spanning-tree mst instance . . . . .	562
spanning-tree mst instance path-cost . . . . .	563
spanning-tree mst instance priority . . . . .	565
spanning-tree mst instance restricted-role . . . . .	566
spanning-tree mst instance restricted-tcn . . . . .	568
spanning-tree path-cost . . . . .	569
spanning-tree portfast (STP) . . . . .	570
spanning-tree portfast bpdu-filter . . . . .	572
spanning-tree portfast bpdu-guard . . . . .	574
spanning-tree priority (bridge priority) . . . . .	576
spanning-tree priority (port priority) . . . . .	577
spanning-tree restricted-role . . . . .	578
spanning-tree restricted-tcn . . . . .	579
spanning-tree transmit-holdcount . . . . .	580
undebg mstp . . . . .	581

<b>Chapter 16:</b>	<b>Unidirectional Link Detection (UDLD) Commands . . . . .</b>	<b>582</b>
	Introduction . . . . .	582
	debug udld . . . . .	583
	show debugging udld . . . . .	584
	show udld . . . . .	585
	show udld neighbors . . . . .	586
	show udld port . . . . .	587
	udld aggressive-mode . . . . .	588
	udld enable . . . . .	589
	udld port . . . . .	590
	udld port aggressive-mode . . . . .	591
	udld port disable . . . . .	592
	udld reset . . . . .	593
	udld time disable-period . . . . .	594
	udld time message-interval . . . . .	595
	undebug udld . . . . .	596
<b>Chapter 17:</b>	<b>Link Aggregation Commands . . . . .</b>	<b>597</b>
	Introduction . . . . .	597
	channel-group . . . . .	599
	clear lacp counters . . . . .	601
	debug lacp . . . . .	602
	lacp global-passive-mode enable . . . . .	603
	lacp port-priority . . . . .	604
	lacp system-priority . . . . .	605
	lacp timeout . . . . .	606
	platform load-balancing . . . . .	608
	show debugging lacp . . . . .	609
	show diagnostic channel-group . . . . .	610
	show etherchannel . . . . .	612
	show etherchannel detail . . . . .	613
	show etherchannel summary . . . . .	614
	show lacp sys-id . . . . .	615
	show lacp-counter . . . . .	616
	show port etherchannel . . . . .	617
	show static-channel-group . . . . .	618
	static-channel-group . . . . .	619
	undebug lacp . . . . .	621
<b>Chapter 18:</b>	<b>Power over Ethernet Commands . . . . .</b>	<b>622</b>
	Introduction . . . . .	622
	clear power-inline counters interface . . . . .	624
	debug power-inline . . . . .	625
	power-inline allow-legacy . . . . .	627
	power-inline description . . . . .	628
	power-inline enable . . . . .	629
	power-inline max . . . . .	630
	power-inline priority . . . . .	632
	power-inline usage-threshold . . . . .	634
	service power-inline . . . . .	635
	show debugging power-inline . . . . .	636
	show power-inline . . . . .	637

	show power-inline counters . . . . .	640
	show power-inline interface . . . . .	642
	show power-inline interface detail . . . . .	645
<b>PART 3:</b>	<b>Layer 3 Switching . . . . .</b>	<b>648</b>
<b>Chapter 19:</b>	<b>IP Addressing and Protocol Commands . . . . .</b>	<b>649</b>
	Introduction . . . . .	649
	arp-aging-timeout . . . . .	651
	arp-mac-disparity . . . . .	652
	arp . . . . .	655
	arp log . . . . .	657
	arp opportunistic-nd . . . . .	660
	arp-reply-bc-dmac . . . . .	661
	clear arp-cache . . . . .	662
	debug ip packet interface . . . . .	663
	ip address (IP Addressing and Protocol) . . . . .	665
	ip gratuitous-arp-link . . . . .	667
	ip redirects . . . . .	669
	ip tcp synack-retries . . . . .	670
	ip unreachable . . . . .	671
	ping . . . . .	673
	show arp . . . . .	674
	show debugging ip packet . . . . .	675
	show ip flooding-nexthops . . . . .	676
	show ip interface . . . . .	677
	show ip sockets . . . . .	678
	show ip traffic . . . . .	681
	tcpdump . . . . .	683
	traceroute . . . . .	684
	undebug ip packet interface . . . . .	685
<b>Chapter 20:</b>	<b>Domain Name Service (DNS) Commands . . . . .</b>	<b>686</b>
	Introduction . . . . .	686
	ip domain-list . . . . .	687
	ip domain-lookup . . . . .	688
	ip domain-name . . . . .	689
	ip name-server . . . . .	690
	ip name-server preferred-order . . . . .	692
	show hosts . . . . .	693
	show ip domain-list . . . . .	694
	show ip domain-name . . . . .	695
	show ip name-server . . . . .	696
<b>Chapter 21:</b>	<b>IPv6 Commands . . . . .</b>	<b>697</b>
	Introduction . . . . .	697
	clear ipv6 neighbors . . . . .	699
	ipv6 address . . . . .	700
	ipv6 address autoconfig . . . . .	702
	ipv6 address suffix . . . . .	704
	ipv6 enable . . . . .	705
	ipv6 eui64-linklocal . . . . .	707

ipv6 forwarding . . . . .	708
ipv6 nd accept-ra-pinfo . . . . .	709
ipv6 nd current-hoplimit . . . . .	710
ipv6 nd managed-config-flag . . . . .	711
ipv6 nd minimum-ra-interval . . . . .	712
ipv6 nd other-config-flag . . . . .	713
ipv6 nd prefix . . . . .	714
ipv6 nd ra-interval . . . . .	716
ipv6 nd ra-lifetime . . . . .	717
ipv6 nd rguard . . . . .	718
ipv6 nd reachable-time . . . . .	720
ipv6 nd retransmission-time . . . . .	721
ipv6 nd suppress-ra . . . . .	722
ipv6 neighbor . . . . .	723
ipv6 opportunistic-nd . . . . .	724
ipv6 route . . . . .	725
ipv6 unreachable . . . . .	726
optimistic-nd . . . . .	727
ping ipv6 . . . . .	728
show ipv6 forwarding . . . . .	730
show ipv6 interface brief . . . . .	731
show ipv6 neighbors . . . . .	732
show ipv6 route . . . . .	733
show ipv6 route summary . . . . .	735
traceroute ipv6 . . . . .	736

**Chapter 22: Routing Commands . . . . . 737**

Introduction . . . . .	737
ip route . . . . .	738
ipv6 route . . . . .	740
max-fib-routes . . . . .	741
max-static-routes . . . . .	742
show ip route . . . . .	743
show ip route database . . . . .	745
show ip route summary . . . . .	746
show ipv6 route . . . . .	747
show ipv6 route summary . . . . .	749

**Chapter 23: RIP Commands . . . . . 750**

Introduction . . . . .	750
accept-lifetime . . . . .	752
alliedware-behavior . . . . .	754
cisco-metric-behavior (RIP) . . . . .	756
clear ip rip route . . . . .	757
debug rip . . . . .	758
default-information originate (RIP) . . . . .	759
default-metric (RIP) . . . . .	760
distance (RIP) . . . . .	761
distribute-list (RIP) . . . . .	762
fullupdate (RIP) . . . . .	763
ip summary-address rip . . . . .	764
ip rip authentication key-chain . . . . .	765

ip rip authentication mode . . . . .	767
ip rip authentication string . . . . .	770
ip rip receive-packet . . . . .	772
ip rip receive version . . . . .	773
ip rip send-packet . . . . .	774
ip rip send version . . . . .	775
ip rip send version 1-compatible . . . . .	777
ip rip split-horizon . . . . .	779
key . . . . .	780
key chain . . . . .	781
key-string . . . . .	782
maximum-prefix . . . . .	783
neighbor (RIP) . . . . .	784
network (RIP) . . . . .	785
offset-list (RIP) . . . . .	786
passive-interface (RIP) . . . . .	787
rcv-buffer-size (RIP) . . . . .	788
redistribute (RIP) . . . . .	789
restart rip graceful . . . . .	790
rip restart grace-period . . . . .	791
route (RIP) . . . . .	792
router rip . . . . .	793
send-lifetime . . . . .	794
show debugging rip . . . . .	796
show ip protocols rip . . . . .	797
show ip rip . . . . .	798
show ip rip database . . . . .	799
show ip rip interface . . . . .	800
timers (RIP) . . . . .	801
undebg rip . . . . .	802
version (RIP) . . . . .	803

**PART 4: Multicast Applications . . . . . 804**

**Chapter 24: IGMP and IGMP Snooping Commands . . . . . 805**

Introduction . . . . .	805
clear ip igmp . . . . .	807
clear ip igmp group . . . . .	808
clear ip igmp interface . . . . .	809
debug igmp . . . . .	810
ip igmp . . . . .	811
ip igmp access-group . . . . .	812
ip igmp flood specific-query . . . . .	813
ip igmp immediate-leave . . . . .	814
ip igmp last-member-query-count . . . . .	815
ip igmp last-member-query-interval . . . . .	816
ip igmp limit . . . . .	817
ip igmp maximum-groups . . . . .	818
ip igmp querier-timeout . . . . .	820
ip igmp query-holdtime . . . . .	821
ip igmp query-interval . . . . .	823
ip igmp query-max-response-time . . . . .	825

	ip igmp ra-option . . . . .	827
	ip igmp robustness-variable . . . . .	828
	ip igmp snooping . . . . .	829
	ip igmp snooping fast-leave . . . . .	830
	ip igmp snooping mrouter . . . . .	831
	ip igmp snooping querier . . . . .	832
	ip igmp snooping report-suppression . . . . .	833
	ip igmp snooping routermode . . . . .	834
	ip igmp snooping source-timeout . . . . .	836
	ip igmp snooping tcn query solicit . . . . .	837
	ip igmp source-address-check . . . . .	839
	ip igmp static-group . . . . .	840
	ip igmp startup-query-count . . . . .	842
	ip igmp startup-query-interval . . . . .	843
	ip igmp trusted . . . . .	844
	ip igmp version . . . . .	845
	show debugging igmp . . . . .	846
	show ip igmp groups . . . . .	847
	show ip igmp interface . . . . .	849
	show ip igmp snooping mrouter . . . . .	851
	show ip igmp snooping routermode . . . . .	852
	show ip igmp snooping source-timeout . . . . .	853
	show ip igmp snooping statistics . . . . .	854
	undebg igmp . . . . .	856
<b>Chapter 25:</b>	<b>MLD Snooping Commands . . . . .</b>	<b>857</b>
	Introduction . . . . .	857
	clear ipv6 mld . . . . .	858
	clear ipv6 mld group . . . . .	859
	clear ipv6 mld interface . . . . .	860
	debug mld . . . . .	861
	ipv6 mld immediate-leave . . . . .	862
	ipv6 mld limit . . . . .	863
	ipv6 mld snooping . . . . .	865
	ipv6 mld snooping fast-leave . . . . .	867
	ipv6 mld snooping mrouter . . . . .	868
	ipv6 mld snooping querier . . . . .	870
	ipv6 mld snooping report-suppression . . . . .	871
	ipv6 mld static-group . . . . .	873
	show debugging mld . . . . .	875
	show ipv6 mld groups . . . . .	876
	show ipv6 mld interface . . . . .	877
	show ipv6 mld snooping mrouter . . . . .	878
	show ipv6 mld snooping statistics . . . . .	879
<b>PART 5:</b>	<b>Access and Security . . . . .</b>	<b>880</b>
<b>Chapter 26:</b>	<b>IPv4 Hardware Access Control List (ACL) Commands . . . . .</b>	<b>881</b>
	Introduction . . . . .	881
	access-group . . . . .	884
	access-list (numbered hardware ACL for ICMP) . . . . .	886
	access-list (numbered hardware ACL for IP packets) . . . . .	890

	access-list (numbered hardware ACL for IP protocols) . . . . .	893
	access-list (numbered hardware ACL for MAC addresses) . . . . .	898
	access-list (numbered hardware ACL for TCP or UDP) . . . . .	901
	access-list hardware (named hardware ACL) . . . . .	905
	(named hardware ACL entry for ICMP) . . . . .	907
	(named hardware ACL entry for IP packets) . . . . .	911
	(named hardware ACL entry for IP protocols) . . . . .	915
	(named hardware ACL entry for MAC addresses) . . . . .	920
	(named hardware ACL entry for TCP or UDP) . . . . .	923
	commit (IPv4) . . . . .	927
	show access-group . . . . .	928
	show access-list (IPv4 Hardware ACLs) . . . . .	929
	show interface access-group . . . . .	931
<b>Chapter 27:</b>	<b>IPv4 Software Access Control List (ACL) Commands . . . . .</b>	<b>932</b>
	Introduction . . . . .	932
	access-list extended (named) . . . . .	935
	access-list (extended numbered) . . . . .	943
	(access-list extended ICMP filter) . . . . .	946
	(access-list extended IP filter) . . . . .	948
	(access-list extended IP protocol filter) . . . . .	951
	(access-list extended TCP UDP filter) . . . . .	955
	access-list standard (named) . . . . .	957
	access-list (standard numbered) . . . . .	959
	(access-list standard named filter) . . . . .	961
	(access-list standard numbered filter) . . . . .	963
	dos . . . . .	965
	maximum-access-list . . . . .	968
	show access-list (IPv4 Software ACLs) . . . . .	969
	show dos interface . . . . .	971
	show ip access-list . . . . .	974
	vt access-class (numbered) . . . . .	975
<b>Chapter 28:</b>	<b>IPv6 Software Access Control List (ACL) Commands . . . . .</b>	<b>976</b>
	Introduction . . . . .	976
	ipv6 access-list standard (named) . . . . .	978
	(ipv6 access-list standard filter) . . . . .	980
	show ipv6 access-list (IPv6 Software ACLs) . . . . .	982
	vt ipv6 access-class (named) . . . . .	983
<b>Chapter 29:</b>	<b>QoS Commands . . . . .</b>	<b>984</b>
	Introduction . . . . .	984
	class . . . . .	986
	class-map . . . . .	987
	clear mls qos interface policer-counters . . . . .	988
	default-action . . . . .	989
	description (QoS policy-map) . . . . .	990
	egress-rate-limit . . . . .	991
	egress-rate-limit overhead . . . . .	992
	match access-group . . . . .	993
	match cos . . . . .	995
	match dscp . . . . .	996



match eth-format protocol . . . . .	997
match ip-precedence . . . . .	1000
match mac-type . . . . .	1001
match tcp-flags . . . . .	1002
match vlan . . . . .	1003
mls qos cos . . . . .	1004
mls qos enable . . . . .	1005
mls qos map cos-queue . . . . .	1006
mls qos map premark-dscp . . . . .	1007
no police . . . . .	1009
police single-rate action . . . . .	1010
police twin-rate action . . . . .	1012
policy-map . . . . .	1014
priority-queue . . . . .	1015
remark-map . . . . .	1016
remark new-cos . . . . .	1018
service-policy input . . . . .	1020
show class-map . . . . .	1021
show mls qos . . . . .	1022
show mls qos interface . . . . .	1023
show mls qos interface policer-counters . . . . .	1026
show mls qos interface queue-counters . . . . .	1027
show mls qos interface storm-status . . . . .	1028
show mls qos maps cos-queue . . . . .	1029
show mls qos maps premark-dscp . . . . .	1030
show platform classifier statistics utilization brief . . . . .	1031
show policy-map . . . . .	1033
storm-action . . . . .	1034
storm-downtime . . . . .	1035
storm-protection . . . . .	1036
storm-rate . . . . .	1037
storm-window . . . . .	1038
trust dscp . . . . .	1039
wrr-queue disable queues . . . . .	1040
wrr-queue egress-rate-limit queues . . . . .	1041
wrr-queue weight queues . . . . .	1042

**Chapter 30: 802.1X Commands . . . . . 1043**

Introduction . . . . .	1043
dot1x accounting . . . . .	1045
dot1x authentication . . . . .	1046
debug dot1x . . . . .	1047
dot1x control-direction . . . . .	1048
dot1x eap . . . . .	1050
dot1x eapol-version . . . . .	1051
dot1x initialize interface . . . . .	1052
dot1x initialize supplicant . . . . .	1053
dot1x keytransmit . . . . .	1054
dot1x max-auth-fail . . . . .	1055
dot1x max-reauth-req . . . . .	1057
dot1x port-control . . . . .	1059
dot1x timeout tx-period . . . . .	1061
show debugging dot1x . . . . .	1063

show dot1x . . . . .	1064
show dot1x diagnostics . . . . .	1067
show dot1x interface . . . . .	1069
show dot1x sessionstatistics . . . . .	1071
show dot1x statistics interface . . . . .	1072
show dot1x supplicant . . . . .	1073
show dot1x supplicant interface . . . . .	1075
undebg dot1x . . . . .	1077

**Chapter 31: Authentication Commands . . . . . 1078**

Introduction . . . . .	1078
auth auth-fail vlan . . . . .	1081
auth critical . . . . .	1083
auth dynamic-vlan-creation . . . . .	1084
auth guest-vlan . . . . .	1087
auth guest-vlan forward . . . . .	1089
auth host-mode . . . . .	1091
auth log . . . . .	1093
auth max-supplicant . . . . .	1095
auth multi-vlan-session . . . . .	1097
auth profile (global) . . . . .	1098
auth profile (interface) . . . . .	1099
auth reauthentication . . . . .	1100
auth roaming disconnected . . . . .	1101
auth roaming enable . . . . .	1103
auth supplicant-ip . . . . .	1105
auth supplicant-mac . . . . .	1107
auth timeout connect-timeout . . . . .	1110
auth timeout quiet-period . . . . .	1111
auth timeout reauth-period . . . . .	1112
auth timeout server-timeout . . . . .	1114
auth timeout supp-timeout . . . . .	1116
auth two-step enable . . . . .	1117
auth-mac accounting . . . . .	1120
auth-mac authentication . . . . .	1121
auth-mac enable . . . . .	1122
auth-mac method . . . . .	1124
auth-mac password . . . . .	1126
auth-mac reauth-relearning . . . . .	1127
auth-mac static . . . . .	1128
auth-mac username . . . . .	1129
auth-web accounting . . . . .	1130
auth-web authentication . . . . .	1131
auth-web enable . . . . .	1132
auth-web forward . . . . .	1134
auth-web max-auth-fail . . . . .	1137
auth-web method . . . . .	1139
auth-web-server blocking-mode . . . . .	1140
auth-web-server dhcp ipaddress . . . . .	1141
auth-web-server dhcp lease . . . . .	1142
auth-web-server dhcp-wpad-option . . . . .	1143
auth-web-server host-name . . . . .	1144
auth-web-server intercept-port . . . . .	1145

auth-web-server ipaddress . . . . .	1146
auth-web-server page language . . . . .	1147
auth-web-server login-url . . . . .	1148
auth-web-server page logo . . . . .	1149
auth-web-server page sub-title . . . . .	1150
auth-web-server page success-message . . . . .	1151
auth-web-server page title . . . . .	1152
auth-web-server page welcome-message . . . . .	1153
auth-web-server ping-poll enable . . . . .	1154
auth-web-server ping-poll failcount . . . . .	1155
auth-web-server ping-poll interval . . . . .	1156
auth-web-server ping-poll reauth-timer-refresh . . . . .	1157
auth-web-server ping-poll timeout . . . . .	1158
auth-web-server port . . . . .	1159
auth-web-server redirect-delay-time . . . . .	1160
auth-web-server redirect-url . . . . .	1161
auth-web-server session-keep . . . . .	1162
auth-web-server ssl . . . . .	1163
auth-web-server ssl intercept-port . . . . .	1164
copy proxy-autoconfig-file . . . . .	1165
copy web-auth-https-file . . . . .	1166
description (auth-profile) . . . . .	1167
erase proxy-autoconfig-file . . . . .	1168
erase web-auth-https-file . . . . .	1169
platform l3-vlan-hashing-algorithm . . . . .	1170
platform mac-vlan-hashing-algorithm . . . . .	1171
show auth . . . . .	1172
show auth diagnostics . . . . .	1174
show auth interface . . . . .	1176
show auth sessionstatistics . . . . .	1178
show auth statistics interface . . . . .	1179
show auth supplicant . . . . .	1180
show auth supplicant interface . . . . .	1183
show auth two-step supplicant brief . . . . .	1184
show auth-web-server . . . . .	1186
show auth-web-server page . . . . .	1187
show proxy-autoconfig-file . . . . .	1188

**Chapter 32: AAA Commands . . . . . 1189**

Introduction . . . . .	1189
aaa accounting auth-mac . . . . .	1191
aaa accounting auth-web . . . . .	1193
aaa accounting commands . . . . .	1195
aaa accounting dot1x . . . . .	1197
aaa accounting login . . . . .	1199
aaa accounting update . . . . .	1202
aaa authentication auth-mac . . . . .	1204
aaa authentication auth-web . . . . .	1206
aaa authentication dot1x . . . . .	1208
aaa authentication enable default group tacacs+ . . . . .	1210
aaa authentication enable default local . . . . .	1212
aaa authentication login . . . . .	1213
aaa authorization commands . . . . .	1215

aaa authorization config-commands . . . . .	1217
aaa group server . . . . .	1218
aaa local authentication attempts lockout-time . . . . .	1220
aaa local authentication attempts max-fail . . . . .	1221
aaa login fail-delay . . . . .	1222
accounting login . . . . .	1223
authorization commands . . . . .	1224
clear aaa local user lockout . . . . .	1226
debug aaa . . . . .	1227
login authentication . . . . .	1228
proxy-port . . . . .	1229
radius-secure-proxy aaa . . . . .	1230
server (radsecproxy-aaa) . . . . .	1231
server mutual-authentication . . . . .	1233
server name-check . . . . .	1234
server trustpoint . . . . .	1235
show aaa local user locked . . . . .	1237
show aaa server group . . . . .	1238
show debugging aaa . . . . .	1239
show radius server group . . . . .	1240
undebug aaa . . . . .	1242

**Chapter 33: RADIUS Commands . . . . . 1243**

Introduction . . . . .	1243
auth radius send nas-identifier . . . . .	1244
auth radius send service-type . . . . .	1245
deadtime (RADIUS server group) . . . . .	1246
debug radius . . . . .	1247
ip radius source-interface . . . . .	1248
radius-server deadtime . . . . .	1249
radius-server host . . . . .	1250
radius-server key . . . . .	1253
radius-server retransmit . . . . .	1254
radius-server timeout . . . . .	1256
server (server group) . . . . .	1258
show debugging radius . . . . .	1260
show radius . . . . .	1261
show radius statistics . . . . .	1264
undebug radius . . . . .	1265

**Chapter 34: Local RADIUS Server Commands . . . . . 1266**

Introduction . . . . .	1266
attribute . . . . .	1268
authentication . . . . .	1271
client (radsecproxy-srv) . . . . .	1272
client mutual-authentication . . . . .	1274
client name-check . . . . .	1275
client trustpoint . . . . .	1276
clear radius local-server statistics . . . . .	1277
copy fdb-radius-users (to file) . . . . .	1278
copy local-radius-user-db (from file) . . . . .	1280
copy local-radius-user-db (to file) . . . . .	1281

crypto pki enroll local (deleted) . . . . .	1282
crypto pki enroll local local-radius-all-users (deleted) . . . . .	1283
crypto pki enroll local user (deleted) . . . . .	1284
crypto pki export local pem (deleted) . . . . .	1285
crypto pki export local pkcs12 (deleted) . . . . .	1286
crypto pki trustpoint local (deleted) . . . . .	1287
debug crypto pki (deleted) . . . . .	1288
domain-style . . . . .	1289
egress-vlan-id . . . . .	1290
egress-vlan-name . . . . .	1292
group . . . . .	1294
nas . . . . .	1295
radius-secure-proxy local-server . . . . .	1296
radius-server local . . . . .	1297
server auth-port . . . . .	1298
server enable . . . . .	1299
show radius local-server group . . . . .	1300
show radius local-server nas . . . . .	1301
show radius local-server statistics . . . . .	1302
show radius local-server user . . . . .	1303
user (RADIUS server) . . . . .	1305
vlan (RADIUS server) . . . . .	1307

**Chapter 35: Public Key Infrastructure Commands . . . . . 1308**

Introduction . . . . .	1308
crypto key generate rsa . . . . .	1309
crypto key zeroize . . . . .	1310
crypto pki authenticate . . . . .	1311
crypto pki enroll . . . . .	1312
crypto pki enroll user . . . . .	1313
crypto pki export pem . . . . .	1315
crypto pki export pkcs12 . . . . .	1316
crypto pki import pem . . . . .	1318
crypto pki import pkcs12 . . . . .	1320
crypto pki trustpoint . . . . .	1321
enrollment (ca-trustpoint) . . . . .	1322
fingerprint (ca-trustpoint) . . . . .	1323
no crypto pki certificate . . . . .	1325
rsa-keypair (ca-trustpoint) . . . . .	1326
show crypto key mypubkey rsa . . . . .	1327
show crypto pki certificates . . . . .	1328
show crypto pki enrollment user . . . . .	1330
show crypto pki trustpoint . . . . .	1331
subject-name (ca-trustpoint) . . . . .	1332

**Chapter 36: TACACS+ Commands . . . . . 1334**

Introduction . . . . .	1334
authorization commands . . . . .	1335
aaa authorization commands . . . . .	1337
aaa authorization config-commands . . . . .	1339
ip tacacs source-interface . . . . .	1340
show tacacs+ . . . . .	1341

	tacacs-server host . . . . .	1343
	tacacs-server key . . . . .	1345
	tacacs-server timeout . . . . .	1346
<b>Chapter 37:</b>	<b>DHCP Snooping Commands . . . . .</b>	<b>1347</b>
	Introduction . . . . .	1347
	arp security . . . . .	1349
	arp security drop link-local-arps . . . . .	1350
	arp security violation . . . . .	1351
	clear arp security statistics . . . . .	1353
	clear ip dhcp snooping binding . . . . .	1354
	clear ip dhcp snooping statistics . . . . .	1355
	debug arp security . . . . .	1356
	debug ip dhcp snooping . . . . .	1357
	ip dhcp snooping . . . . .	1358
	ip dhcp snooping agent-option . . . . .	1360
	ip dhcp snooping agent-option allow-untrusted . . . . .	1361
	ip dhcp snooping agent-option circuit-id vlantriple . . . . .	1362
	ip dhcp snooping agent-option remote-id . . . . .	1363
	ip dhcp snooping binding . . . . .	1364
	ip dhcp snooping database . . . . .	1365
	ip dhcp snooping delete-by-client . . . . .	1366
	ip dhcp snooping delete-by-linkdown . . . . .	1367
	ip dhcp snooping max-bindings . . . . .	1368
	ip dhcp snooping trust . . . . .	1369
	ip dhcp snooping verify mac-address . . . . .	1370
	ip dhcp snooping violation . . . . .	1371
	ip source binding . . . . .	1372
	service dhcp-snooping . . . . .	1374
	show arp security . . . . .	1376
	show arp security interface . . . . .	1377
	show arp security statistics . . . . .	1379
	show debugging arp security . . . . .	1381
	show debugging ip dhcp snooping . . . . .	1382
	show ip dhcp snooping . . . . .	1383
	show ip dhcp snooping acl . . . . .	1384
	show ip dhcp snooping agent-option . . . . .	1387
	show ip dhcp snooping binding . . . . .	1389
	show ip dhcp snooping interface . . . . .	1391
	show ip dhcp snooping statistics . . . . .	1393
	show ip source binding . . . . .	1396
<b>PART 6:</b>	<b>Network Availability . . . . .</b>	<b>1397</b>
<b>Chapter 38:</b>	<b>Ethernet Protection Switched Ring (EPSRing™) Commands . . . . .</b>	<b>1398</b>
	Introduction . . . . .	1398
	debug epsr . . . . .	1400
	epsr . . . . .	1401
	epsr configuration . . . . .	1403
	epsr datavlan . . . . .	1404
	epsr enhancedrecovery enable . . . . .	1405
	epsr flush-type . . . . .	1406

epsr mode master controlvlan primary port . . . . .	1408
epsr mode transit controlvlan . . . . .	1409
epsr priority . . . . .	1410
epsr state . . . . .	1411
epsr topology-change . . . . .	1412
epsr trap . . . . .	1413
show debugging epsr . . . . .	1414
show epsr . . . . .	1415
show epsr common segments . . . . .	1419
show epsr config-check . . . . .	1420
show epsr <epsr-instance> . . . . .	1421
show epsr <epsr-instance> counters . . . . .	1422
show epsr counters . . . . .	1423
show epsr summary . . . . .	1424
undebg epsr . . . . .	1425

**PART 7: Network Management . . . . . 1426**

**Chapter 39: Allied Telesis Management Framework™ (AMF) Commands . . . . . 1427**

Introduction . . . . .	1427
application-proxy ip-filter . . . . .	1432
application-proxy quarantine-vlan . . . . .	1433
application-proxy redirect-url . . . . .	1434
application-proxy threat-protection . . . . .	1435
application-proxy threat-protection send-summary . . . . .	1436
application-proxy whitelist enable . . . . .	1437
application-proxy whitelist server . . . . .	1438
area-link . . . . .	1440
atmf area . . . . .	1442
atmf area password . . . . .	1444
atmf authorize . . . . .	1446
atmf authorize provision . . . . .	1448
atmf backup . . . . .	1450
atmf backup area-masters delete . . . . .	1451
atmf backup area-masters enable . . . . .	1452
atmf backup area-masters now . . . . .	1453
atmf backup area-masters synchronize . . . . .	1454
atmf backup bandwidth . . . . .	1455
atmf backup delete . . . . .	1456
atmf backup enable . . . . .	1457
atmf backup guests delete . . . . .	1458
atmf backup guests enable . . . . .	1459
atmf backup guests now . . . . .	1460
atmf backup guests synchronize . . . . .	1461
atmf backup now . . . . .	1462
atmf backup redundancy enable . . . . .	1464
atmf backup server . . . . .	1465
atmf backup stop . . . . .	1467
atmf backup synchronize . . . . .	1468
atmf cleanup . . . . .	1469
atmf container . . . . .	1470
atmf container login . . . . .	1471

---

atmf controller . . . . .	1472
atmf distribute firmware . . . . .	1473
atmf domain vlan . . . . .	1475
atmf enable . . . . .	1478
atmf group (membership) . . . . .	1479
atmf guest-class . . . . .	1481
atmf log-verbose . . . . .	1483
atmf management subnet . . . . .	1484
atmf management vlan . . . . .	1487
atmf master . . . . .	1489
atmf mtu . . . . .	1490
atmf network-name . . . . .	1491
atmf provision (interface) . . . . .	1492
atmf provision node . . . . .	1493
atmf reboot-rolling . . . . .	1495
atmf recover . . . . .	1499
atmf recover guest . . . . .	1501
atmf recover led-off . . . . .	1502
atmf recovery-server . . . . .	1503
atmf remote-login . . . . .	1505
atmf restricted-login . . . . .	1507
atmf secure-mode . . . . .	1509
atmf secure-mode certificate expire . . . . .	1511
atmf secure-mode certificate expiry . . . . .	1512
atmf secure-mode certificate renew . . . . .	1513
atmf secure-mode enable-all . . . . .	1514
atmf select-area . . . . .	1516
atmf topology-gui enable . . . . .	1517
atmf trustpoint . . . . .	1518
atmf virtual-crosslink . . . . .	1520
atmf virtual-link . . . . .	1522
atmf virtual-link protection . . . . .	1525
atmf working-set . . . . .	1527
bridge-group . . . . .	1529
clear application-proxy threat-protection . . . . .	1530
clear atmf links . . . . .	1531
clear atmf links virtual . . . . .	1532
clear atmf links statistics . . . . .	1533
clear atmf recovery-file . . . . .	1534
clear atmf secure-mode certificates . . . . .	1535
clear atmf secure-mode statistics . . . . .	1536
clone (amf-provision) . . . . .	1537
configure boot config (amf-provision) . . . . .	1539
configure boot system (amf-provision) . . . . .	1541
copy (amf-provision) . . . . .	1543
create (amf-provision) . . . . .	1544
debug atmf . . . . .	1546
debug atmf packet . . . . .	1548
delete (amf-provision) . . . . .	1551
discovery . . . . .	1553
description (amf-container) . . . . .	1555
erase factory-default . . . . .	1556
http-enable . . . . .	1557



---

identity (amf-provision) . . . . .	1559
license-cert (amf-provision) . . . . .	1561
locate (amf-provision) . . . . .	1563
log event-host . . . . .	1565
modeltype . . . . .	1566
service atmf-application-proxy . . . . .	1567
show application-proxy threat-protection . . . . .	1568
show application-proxy whitelist interface . . . . .	1570
show application-proxy whitelist server . . . . .	1572
show application-proxy whitelist supplicant . . . . .	1573
show atmf . . . . .	1575
show atmf area . . . . .	1579
show atmf area guests . . . . .	1582
show atmf area guests-detail . . . . .	1584
show atmf area nodes . . . . .	1586
show atmf area nodes-detail . . . . .	1588
show atmf area summary . . . . .	1590
show atmf authorization . . . . .	1591
show atmf backup . . . . .	1594
show atmf backup area . . . . .	1598
show atmf backup guest . . . . .	1600
show atmf container . . . . .	1602
show atmf detail . . . . .	1605
show atmf group . . . . .	1607
show atmf group members . . . . .	1609
show atmf guests . . . . .	1611
show atmf guests detail . . . . .	1613
show atmf links . . . . .	1616
show atmf links detail . . . . .	1618
show atmf links guest . . . . .	1627
show atmf links guest detail . . . . .	1629
show atmf links statistics . . . . .	1633
show atmf nodes . . . . .	1636
show atmf provision nodes . . . . .	1638
show atmf recovery-file . . . . .	1640
show atmf secure-mode . . . . .	1641
show atmf secure-mode audit . . . . .	1643
show atmf secure-mode audit link . . . . .	1644
show atmf secure-mode certificates . . . . .	1645
show atmf secure-mode sa . . . . .	1648
show atmf secure-mode statistics . . . . .	1651
show atmf tech . . . . .	1653
show atmf virtual-links . . . . .	1656
show atmf working-set . . . . .	1658
show debugging atmf . . . . .	1659
show debugging atmf packet . . . . .	1660
show running-config atmf . . . . .	1661
state . . . . .	1662
switchport atmf-agentlink . . . . .	1664
switchport atmf-arealink remote-area . . . . .	1665
switchport atmf-crosslink . . . . .	1667
switchport atmf-guestlink . . . . .	1669
switchport atmf-link . . . . .	1671

	type atmf node . . . . .	1672
	undebbug atmf . . . . .	1675
	username . . . . .	1676
<b>Chapter 40:</b>	<b>Management Stacking Commands . . . . .</b>	<b>1678</b>
	Introduction . . . . .	1678
	mstack command-node . . . . .	1679
	mstack enable . . . . .	1680
	mstack remote-login . . . . .	1681
	show mstack nodes . . . . .	1683
	switchport mstack-link . . . . .	1684
<b>Chapter 41:</b>	<b>Dynamic Host Configuration Protocol (DHCP) Commands . . . . .</b>	<b>1685</b>
	Introduction . . . . .	1685
	ip address dhcp . . . . .	1686
	ip dhcp-client default-route distance . . . . .	1688
	ip dhcp-client request vendor-identifying-specific . . . . .	1690
	ip dhcp-client vendor-identifying-class . . . . .	1691
	show counter dhcp-client . . . . .	1692
	show dhcp lease . . . . .	1693
<b>Chapter 42:</b>	<b>NTP Commands . . . . .</b>	<b>1694</b>
	Introduction . . . . .	1694
	ntp access-group (deprecated) . . . . .	1695
	ntp authenticate . . . . .	1696
	ntp authentication-key . . . . .	1697
	ntp broadcastdelay . . . . .	1698
	ntp discard . . . . .	1699
	ntp peer . . . . .	1700
	ntp rate-limit . . . . .	1702
	ntp restrict . . . . .	1703
	ntp server . . . . .	1705
	ntp source . . . . .	1707
	ntp trusted-key (deprecated) . . . . .	1709
	show counter ntp (deprecated) . . . . .	1710
	show ntp associations . . . . .	1711
	show ntp counters . . . . .	1713
	show ntp counters associations . . . . .	1714
	show ntp status . . . . .	1715
<b>Chapter 43:</b>	<b>SNMP Commands . . . . .</b>	<b>1716</b>
	Introduction . . . . .	1716
	alias (interface) . . . . .	1718
	debug snmp . . . . .	1719
	show counter snmp-server . . . . .	1720
	show debugging snmp . . . . .	1724
	show running-config snmp . . . . .	1725
	show snmp-server . . . . .	1726
	show snmp-server community . . . . .	1727
	show snmp-server group . . . . .	1728
	show snmp-server user . . . . .	1729
	show snmp-server view . . . . .	1730

snmp trap link-status	1731
snmp trap link-status suppress	1732
snmp-server	1734
snmp-server community	1736
snmp-server contact	1737
snmp-server enable trap	1738
snmp-server engineID local	1740
snmp-server engineID local reset	1742
snmp-server group	1743
snmp-server host	1745
snmp-server legacy-ifadminstatus	1747
snmp-server location	1748
snmp-server source-interface	1749
snmp-server startup-trap-delay	1750
snmp-server user	1751
snmp-server view	1754
undebug snmp	1755

**Chapter 44: LLDP Commands . . . . . 1756**

Introduction	1756
clear lldp statistics	1758
clear lldp table	1759
debug lldp	1760
lldp faststart-count	1762
lldp holdtime-multiplier	1763
lldp management-address	1764
lldp med-notifications	1765
lldp med-tlv-select	1766
lldp non-strict-med-tlv-order-check	1769
lldp notification-interval	1770
lldp notifications	1771
lldp port-number-type	1772
lldp reinit	1773
lldp run	1774
lldp timer	1775
lldp tlv-select	1776
lldp transmit receive	1778
lldp tx-delay	1779
location civic-location configuration	1780
location civic-location identifier	1784
location civic-location-id	1785
location coord-location configuration	1786
location coord-location identifier	1788
location coord-location-id	1789
location elin-location	1791
location elin-location-id	1792
show debugging lldp	1793
show lldp	1795
show lldp interface	1797
show lldp local-info	1799
show lldp neighbors	1804
show lldp neighbors detail	1806
show lldp statistics	1810

---

	show lldp statistics interface . . . . .	1812
	show location . . . . .	1814
<b>Chapter 45:</b>	<b>Mail (SMTP) Commands . . . . .</b>	<b>1816</b>
	Introduction . . . . .	1816
	debug mail . . . . .	1817
	delete mail . . . . .	1818
	mail . . . . .	1819
	mail from . . . . .	1821
	mail smtpserver . . . . .	1822
	mail smtpserver authentication . . . . .	1823
	mail smtpserver port . . . . .	1825
	show counter mail . . . . .	1827
	show mail . . . . .	1828
	undebg mail . . . . .	1829
<b>Chapter 46:</b>	<b>RMON Commands . . . . .</b>	<b>1830</b>
	Introduction . . . . .	1830
	rmon alarm . . . . .	1831
	rmon collection history . . . . .	1833
	rmon collection stats . . . . .	1834
	rmon event . . . . .	1835
	show rmon alarm . . . . .	1836
	show rmon event . . . . .	1837
	show rmon history . . . . .	1839
	show rmon statistics . . . . .	1841
<b>Chapter 47:</b>	<b>Secure Shell (SSH) Commands . . . . .</b>	<b>1843</b>
	Introduction . . . . .	1843
	banner login (SSH) . . . . .	1845
	clear ssh . . . . .	1846
	crypto key destroy hostkey . . . . .	1847
	crypto key destroy userkey . . . . .	1848
	crypto key generate hostkey . . . . .	1849
	crypto key generate userkey . . . . .	1851
	crypto key pubkey-chain knownhosts . . . . .	1852
	crypto key pubkey-chain userkey . . . . .	1854
	debug ssh client . . . . .	1856
	debug ssh server . . . . .	1857
	service ssh . . . . .	1858
	show banner login . . . . .	1860
	show crypto key hostkey . . . . .	1861
	show crypto key pubkey-chain knownhosts . . . . .	1863
	show crypto key pubkey-chain userkey . . . . .	1864
	show crypto key userkey . . . . .	1865
	show running-config ssh . . . . .	1866
	show ssh . . . . .	1868
	show ssh client . . . . .	1870
	show ssh server . . . . .	1871
	show ssh server allow-users . . . . .	1873
	show ssh server deny-users . . . . .	1874
	ssh . . . . .	1875

---

ssh client . . . . .	1877
ssh server . . . . .	1879
ssh server allow-users . . . . .	1881
ssh server authentication . . . . .	1883
ssh server deny-users . . . . .	1885
ssh server max-auth-tries . . . . .	1887
ssh server resolve-host . . . . .	1888
ssh server scp . . . . .	1889
ssh server sftp . . . . .	1890
undebg ssh client . . . . .	1891
undebg ssh server . . . . .	1892

**Chapter 48: Trigger Commands . . . . . 1893**

Introduction . . . . .	1893
active (trigger) . . . . .	1895
day . . . . .	1896
debug trigger . . . . .	1898
description (trigger) . . . . .	1899
repeat . . . . .	1900
script . . . . .	1901
show debugging trigger . . . . .	1903
show running-config trigger . . . . .	1904
show trigger . . . . .	1905
test . . . . .	1910
time (trigger) . . . . .	1911
trap . . . . .	1913
trigger . . . . .	1914
trigger activate . . . . .	1915
type atmf node . . . . .	1916
type card . . . . .	1919
type cpu . . . . .	1920
type interface . . . . .	1921
type linkmon-probe . . . . .	1922
type log . . . . .	1924
type memory . . . . .	1925
type periodic . . . . .	1926
type ping-poll . . . . .	1927
type reboot . . . . .	1928
type time . . . . .	1929
undebg trigger . . . . .	1930

**Chapter 49: Ping-Polling Commands . . . . . 1931**

Introduction . . . . .	1931
active (ping-polling) . . . . .	1933
clear ping-poll . . . . .	1934
critical-interval . . . . .	1935
debug ping-poll . . . . .	1936
description (ping-polling) . . . . .	1937
fail-count . . . . .	1938
ip (ping-polling) . . . . .	1939
length (ping-poll data) . . . . .	1940
normal-interval . . . . .	1941

---

ping-poll . . . . .	1942
sample-size . . . . .	1943
show counter ping-poll . . . . .	1945
show ping-poll . . . . .	1947
source-ip . . . . .	1951
timeout (ping polling) . . . . .	1953
up-count . . . . .	1954
undebug ping-poll . . . . .	1955

<b>Chapter 50:</b>	<b>sFlow Commands . . . . .</b>	<b>1956</b>
	Introduction . . . . .	1956
	debug sflow . . . . .	1957
	debug sflow agent . . . . .	1958
	sflow agent . . . . .	1959
	sflow collector . . . . .	1961
	sflow collector max-datagram-size . . . . .	1963
	sflow enable . . . . .	1964
	sflow max-header-size . . . . .	1965
	sflow polling-interval . . . . .	1967
	sflow sampling-rate . . . . .	1968
	show debugging sflow . . . . .	1969
	show running-config sflow . . . . .	1971
	show sflow . . . . .	1972
	show sflow interface . . . . .	1974
	undebug sflow . . . . .	1975

# List of Commands

(access-list extended ICMP filter) .....	946
(access-list extended IP filter).....	948
(access-list extended IP protocol filter).....	951
(access-list extended TCP UDP filter).....	955
(access-list standard named filter) .....	961
(access-list standard numbered filter).....	963
(ipv6 access-list standard filter).....	980
(named hardware ACL entry for ICMP) .....	907
(named hardware ACL entry for IP packets) .....	911
(named hardware ACL entry for IP protocols) .....	915
(named hardware ACL entry for MAC addresses) .....	920
(named hardware ACL entry for TCP or UDP).....	923
aaa accounting auth-mac .....	1191
aaa accounting auth-web .....	1193
aaa accounting commands.....	1195
aaa accounting dot1x.....	1197
aaa accounting login.....	1199
aaa accounting update.....	1202
aaa authentication auth-mac.....	1204
aaa authentication auth-web.....	1206
aaa authentication dot1x .....	1208
aaa authentication enable default group tacacs+ .....	1210
aaa authentication enable default local.....	1212
aaa authentication enable default local.....	133
aaa authentication login .....	1213

---

aaa authorization commands .....	1215
aaa authorization commands .....	1337
aaa authorization config-commands .....	1217
aaa authorization config-commands .....	1339
aaa group server.....	1218
aaa local authentication attempts lockout-time.....	1220
aaa local authentication attempts lockout-time.....	134
aaa local authentication attempts max-fail .....	1221
aaa local authentication attempts max-fail .....	135
aaa login fail-delay.....	1222
aaa login fail-delay.....	136
accept-lifetime .....	752
access-group .....	884
access-list (extended numbered).....	943
access-list (numbered hardware ACL for ICMP) .....	886
access-list (numbered hardware ACL for IP packets).....	890
access-list (numbered hardware ACL for IP protocols).....	893
access-list (numbered hardware ACL for MAC addresses) .....	898
access-list (numbered hardware ACL for TCP or UDP) .....	901
access-list (standard numbered).....	959
access-list extended (named) .....	935
access-list hardware (named hardware ACL).....	905
access-list standard (named) .....	957
accounting login .....	1223
activate .....	375
active (ping-polling) .....	1933
active (trigger).....	1895
alias (interface) .....	1718
alliedware-behavior .....	754
application-proxy ip-filter.....	1432
application-proxy quarantine-vlan .....	1433
application-proxy redirect-url .....	1434
application-proxy threat-protection send-summary.....	1436
application-proxy threat-protection.....	1435
application-proxy whitelist enable .....	1437



---

application-proxy whitelist server .....	1438
area-link.....	1440
arp log .....	657
arp opportunistic-nd.....	660
arp security drop link-local-arps.....	1350
arp security violation .....	1351
arp security.....	1349
arp.....	655
arp-aging-timeout.....	651
arp-mac-disparity.....	652
arp-reply-bc-dmac.....	661
atmf area password.....	1444
atmf area.....	1442
atmf authorize provision .....	1448
atmf authorize.....	1446
atmf backup area-masters delete.....	1451
atmf backup area-masters enable .....	1452
atmf backup area-masters now.....	1453
atmf backup area-masters synchronize .....	1454
atmf backup bandwidth .....	1455
atmf backup delete .....	1456
atmf backup enable .....	1457
atmf backup guests delete .....	1458
atmf backup guests enable .....	1459
atmf backup guests now.....	1460
atmf backup guests synchronize .....	1461
atmf backup now.....	1462
atmf backup redundancy enable .....	1464
atmf backup server .....	1465
atmf backup stop.....	1467
atmf backup synchronize .....	1468
atmf backup.....	1450
atmf cleanup .....	1469
atmf container login .....	1471
atmf container.....	1470

---

atmf controller .....	1472
atmf distribute firmware .....	1473
atmf domain vlan.....	1475
atmf enable .....	1478
atmf group (membership) .....	1479
atmf guest-class .....	1481
atmf log-verbose .....	1483
atmf management subnet .....	1484
atmf management vlan.....	1487
atmf master .....	1489
atmf mtu.....	1490
atmf network-name .....	1491
atmf provision (interface) .....	1492
atmf provision node .....	1493
atmf reboot-rolling .....	1495
atmf recover guest.....	1501
atmf recover led-off.....	1502
atmf recover.....	1499
atmf recovery-server.....	1503
atmf remote-login .....	1505
atmf restricted-login.....	1507
atmf secure-mode certificate expire .....	1511
atmf secure-mode certificate expiry .....	1512
atmf secure-mode certificate renew .....	1513
atmf secure-mode enable-all.....	1514
atmf secure-mode .....	1509
atmf select-area .....	1516
atmf topology-gui enable.....	1517
atmf topology-gui enable.....	190
atmf trustpoint .....	1518
atmf virtual-crosslink .....	1520
atmf virtual-link protection .....	1525
atmf virtual-link .....	1522
atmf working-set .....	1527
attribute .....	1268

---

auth auth-fail vlan .....	1081
auth critical.....	1083
auth dynamic-vlan-creation.....	1084
auth guest-vlan forward .....	1089
auth guest-vlan.....	1087
auth host-mode .....	1091
auth log.....	1093
auth max-supplicant.....	1095
auth multi-vlan-session .....	1097
auth profile (global).....	1098
auth profile (interface) .....	1099
auth radius send nas-identifier .....	1244
auth radius send service-type .....	1245
auth reauthentication.....	1100
auth roaming disconnected.....	1101
auth roaming enable .....	1103
auth supplicant-ip .....	1105
auth supplicant-mac.....	1107
auth timeout connect-timeout.....	1110
auth timeout quiet-period .....	1111
auth timeout reauth-period.....	1112
auth timeout server-timeout .....	1114
auth timeout supp-timeout .....	1116
auth two-step enable .....	1117
authentication.....	1271
auth-mac accounting .....	1120
auth-mac authentication.....	1121
auth-mac enable .....	1122
auth-mac method .....	1124
auth-mac password.....	1126
auth-mac reauth-relearning.....	1127
auth-mac static .....	1128
auth-mac username .....	1129
authorization commands .....	1224
authorization commands .....	1335

---

auth-web accounting .....	1130
auth-web authentication .....	1131
auth-web enable .....	1132
auth-web forward .....	1134
auth-web max-auth-fail .....	1137
auth-web method .....	1139
auth-web-server blocking-mode .....	1140
auth-web-server dhcp ipaddress .....	1141
auth-web-server dhcp lease .....	1142
auth-web-server dhcp-wpad-option .....	1143
auth-web-server host-name .....	1144
auth-web-server intercept-port .....	1145
auth-web-server ipaddress .....	1146
auth-web-server login-url .....	1148
auth-web-server page language .....	1147
auth-web-server page logo .....	1149
auth-web-server page sub-title .....	1150
auth-web-server page success-message .....	1151
auth-web-server page title .....	1152
auth-web-server page welcome-message .....	1153
auth-web-server ping-poll enable .....	1154
auth-web-server ping-poll failcount .....	1155
auth-web-server ping-poll interval .....	1156
auth-web-server ping-poll reauth-timer-refresh .....	1157
auth-web-server ping-poll timeout .....	1158
auth-web-server port .....	1159
auth-web-server redirect-delay-time .....	1160
auth-web-server redirect-url .....	1161
auth-web-server session-keep .....	1162
auth-web-server ssl intercept-port .....	1164
auth-web-server ssl .....	1163
autoboot enable .....	83
backpressure .....	409
banner exec .....	199
banner login (SSH) .....	1845

---

banner login (system).....	201
banner motd .....	203
boot config-file backup .....	86
boot config-file .....	84
boot system backup .....	89
boot system .....	87
bridge-group.....	1529
cd.....	90
channel-group .....	599
cisco-metric-behavior (RIP).....	756
class.....	986
class-map .....	987
clear aaa local user lockout.....	1226
clear aaa local user lockout.....	137
clear application-proxy threat-protection.....	1530
clear arp security statistics .....	1353
clear arp-cache .....	662
clear atmf links statistics .....	1533
clear atmf links virtual .....	1532
clear atmf links .....	1531
clear atmf recovery-file .....	1534
clear atmf secure-mode certificates .....	1535
clear atmf secure-mode statistics.....	1536
clear exception log .....	284
clear fiber-monitoring interface .....	258
clear ip dhcp snooping binding .....	1354
clear ip dhcp snooping statistics .....	1355
clear ip igmp group.....	808
clear ip igmp interface .....	809
clear ip igmp .....	807
clear ip rip route .....	757
clear ipv6 mld group.....	859
clear ipv6 mld interface .....	860
clear ipv6 mld .....	858
clear ipv6 neighbors .....	699

---

clear lacp counters.....	601
clear line console .....	138
clear line vty.....	139
clear lldp statistics .....	1758
clear lldp table.....	1759
clear log buffered.....	286
clear log external .....	287
clear log permanent .....	288
clear log.....	285
clear loop-protection counters .....	411
clear mac address-table dynamic.....	412
clear mac address-table static .....	414
clear mls qos interface policer-counters .....	988
clear ping-poll.....	1934
clear port counter .....	415
clear port-security intrusion.....	416
clear power-inline counters interface.....	624
clear radius local-server statistics.....	1277
clear spanning-tree detected protocols (RSTP and MSTP) .....	511
clear spanning-tree statistics.....	510
clear ssh.....	1846
clear test cable-diagnostics tdr.....	259
client (radsecproxy-srv) .....	1272
client mutual-authentication.....	1274
client name-check.....	1275
client trustpoint .....	1276
clock set.....	205
clock summer-time date .....	206
clock summer-time recurring .....	208
clock timezone .....	210
clone (amf-provision) .....	1537
commit (IPv4) .....	927
configure boot config (amf-provision).....	1539
configure boot system (amf-provision) .....	1541
configure terminal.....	70

---

copy (amf-provision).....	1543
copy (filename).....	91
copy buffered-log .....	289
copy current-software .....	93
copy debug .....	94
copy fdb-radius-users (to file) .....	1278
copy local-radius-user-db (from file).....	1280
copy local-radius-user-db (to file) .....	1281
copy permanent-log .....	290
copy proxy-autoconfig-file.....	1165
copy running-config .....	95
copy startup-config.....	96
copy web-auth-https-file.....	1166
copy zmodem .....	97
create (amf-provision) .....	1544
create autoboot .....	98
critical-interval .....	1935
crypto key destroy hostkey.....	1847
crypto key destroy userkey.....	1848
crypto key generate hostkey .....	1849
crypto key generate rsa .....	1309
crypto key generate userkey .....	1851
crypto key pubkey-chain knownhosts .....	1852
crypto key pubkey-chain userkey.....	1854
crypto key zeroize .....	1310
crypto pki authenticate .....	1311
crypto pki enroll local (deleted) .....	1282
crypto pki enroll local local-radius-all-users (deleted) .....	1283
crypto pki enroll local user (deleted).....	1284
crypto pki enroll user .....	1313
crypto pki enroll .....	1312
crypto pki export local pem (deleted) .....	1285
crypto pki export local pkcs12 (deleted) .....	1286
crypto pki export pem .....	1315
crypto pki export pkcs12.....	1316

---

crypto pki import pem .....	1318
crypto pki import pkcs12 .....	1320
crypto pki trustpoint local (deleted) .....	1287
crypto pki trustpoint .....	1321
day .....	1896
deadtime (RADIUS server group) .....	1246
debug aaa .....	1227
debug arp security .....	1356
debug atmf packet .....	1548
debug atmf .....	1546
debug core-file .....	211
debug crypto pki (deleted) .....	1288
debug dot1x .....	1047
debug epsr .....	1400
debug fiber-monitoring .....	260
debug igmp .....	810
debug ip dhcp snooping .....	1357
debug ip packet interface .....	663
debug lacp .....	602
debug lldp .....	1760
debug loopprot .....	419
debug mail .....	1817
debug mld .....	861
debug mstp (RSTP and STP) .....	512
debug ping-poll .....	1936
debug platform packet .....	420
debug power-inline .....	625
debug radius .....	1247
debug rip .....	758
debug sflow agent .....	1958
debug sflow .....	1957
debug snmp .....	1719
debug ssh client .....	1856
debug ssh server .....	1857
debug trigger .....	1898



---

debug uddl.....	583
default log buffered .....	291
default log console .....	292
default log email .....	293
default log external.....	294
default log host.....	295
default log monitor.....	296
default log permanent.....	297
default-action .....	989
default-information originate (RIP) .....	759
default-metric (RIP) .....	760
delete (amf-provision) .....	1551
delete debug.....	100
delete mail .....	1818
delete .....	99
description (amf-container) .....	1555
description (auth-profile) .....	1167
description (interface) .....	379
description (ping-polling).....	1937
description (QoS policy-map) .....	990
description (trigger) .....	1899
dir.....	101
disable (Privileged Exec mode).....	71
discovery.....	1553
distance (RIP).....	761
distribute-list (RIP).....	762
do.....	72
domain-style .....	1289
dos.....	965
dot1x accounting.....	1045
dot1x authentication .....	1046
dot1x control-direction .....	1048
dot1x eap .....	1050
dot1x eapol-version .....	1051
dot1x initialize interface .....	1052

---

dot1x initialize supplicant.....	1053
dot1x keytransmit .....	1054
dot1x max-auth-fail.....	1055
dot1x max-reauth-req .....	1057
dot1x port-control.....	1059
dot1x timeout tx-period .....	1061
duplex .....	422
echo .....	376
ecofriendly led .....	212
edit (filename).....	104
edit .....	103
egress-rate-limit overhead .....	992
egress-rate-limit .....	991
egress-vlan-id .....	1290
egress-vlan-name.....	1292
enable (Privileged Exec mode) .....	73
enable password .....	140
enable secret.....	143
end .....	75
enrollment (ca-trustpoint) .....	1322
epsr configuration.....	1403
epsr datavlan.....	1404
epsr enhancedrecovery enable.....	1405
epsr flush-type .....	1406
epsr mode master controlvlan primary port .....	1408
epsr mode transit controlvlan .....	1409
epsr priority .....	1410
epsr state.....	1411
epsr topology-change .....	1412
epsr trap .....	1413
epsr .....	1401
erase factory-default.....	105
erase factory-default.....	1556
erase proxy-autoconfig-file .....	1168
erase startup-config .....	106

---

erase web-auth-https-file .....	1169
exec-timeout .....	146
exit .....	76
fail-count .....	1938
fiber-monitoring action .....	262
fiber-monitoring baseline .....	264
fiber-monitoring enable .....	266
fiber-monitoring interval .....	267
fiber-monitoring sensitivity .....	268
findme .....	213
fingerprint (ca-trustpoint) .....	1323
flowcontrol (switch port) .....	423
flowcontrol hardware (asyn/console) .....	148
fullupdate (RIP) .....	763
group .....	1294
gui-timeout .....	191
help .....	77
hostname .....	215
http port .....	192
http secure-port .....	193
http-enable .....	1557
identity (amf-provision) .....	1559
instance priority (MSTP) .....	516
instance vlan (MSTP) .....	518
interface (to configure) .....	380
ip (ping-polling) .....	1939
ip address (IP Addressing and Protocol) .....	665
ip address dhcp .....	1686
ip dhcp snooping agent-option allow-untrusted .....	1361
ip dhcp snooping agent-option circuit-id vlantriplet .....	1362
ip dhcp snooping agent-option remote-id .....	1363
ip dhcp snooping agent-option .....	1360
ip dhcp snooping binding .....	1364
ip dhcp snooping database .....	1365
ip dhcp snooping delete-by-client .....	1366

---

ip dhcp snooping delete-by-linkdown.....	1367
ip dhcp snooping max-bindings .....	1368
ip dhcp snooping trust.....	1369
ip dhcp snooping verify mac-address.....	1370
ip dhcp snooping violation.....	1371
ip dhcp snooping.....	1358
ip dhcp-client default-route distance.....	1688
ip dhcp-client request vendor-identifying-specific.....	1690
ip dhcp-client vendor-identifying-class.....	1691
ip domain-list.....	687
ip domain-lookup .....	688
ip domain-name.....	689
ip gratuitous-arp-link .....	667
ip igmp access-group.....	812
ip igmp flood specific-query .....	813
ip igmp immediate-leave .....	814
ip igmp last-member-query-count .....	815
ip igmp last-member-query-interval.....	816
ip igmp limit.....	817
ip igmp maximum-groups .....	818
ip igmp querier-timeout .....	820
ip igmp query-holdtime .....	821
ip igmp query-interval .....	823
ip igmp query-max-response-time .....	825
ip igmp ra-option.....	827
ip igmp robustness-variable .....	828
ip igmp snooping fast-leave.....	830
ip igmp snooping mrouter.....	831
ip igmp snooping querier.....	832
ip igmp snooping report-suppression .....	833
ip igmp snooping routermode .....	834
ip igmp snooping source-timeout.....	836
ip igmp snooping tcn query solicit .....	837
ip igmp snooping.....	829
ip igmp source-address-check .....	839

---

ip igmp startup-query-count .....	842
ip igmp startup-query-interval .....	843
ip igmp static-group .....	840
ip igmp trusted .....	844
ip igmp version .....	845
ip igmp .....	811
ip name-server preferred-order .....	692
ip name-server .....	690
ip radius source-interface .....	1248
ip redirects .....	669
ip rip authentication key-chain .....	765
ip rip authentication mode .....	767
ip rip authentication string .....	770
ip rip receive version .....	773
ip rip receive-packet .....	772
ip rip send version 1-compatible .....	777
ip rip send version .....	775
ip rip send-packet .....	774
ip rip split-horizon .....	779
ip route .....	738
ip source binding .....	1372
ip summary-address rip .....	764
ip tacacs source-interface .....	1340
ip tcp synack-retries .....	670
ip tftp source-interface .....	107
ip unreachable .....	671
ipv6 access-list standard (named) .....	978
ipv6 address autoconfig .....	702
ipv6 address suffix .....	704
ipv6 address .....	700
ipv6 enable .....	705
ipv6 eui64-linklocal .....	707
ipv6 forwarding .....	708
ipv6 mld immediate-leave .....	862
ipv6 mld limit .....	863

---

ipv6 mld snooping fast-leave .....	867
ipv6 mld snooping mrouter .....	868
ipv6 mld snooping querier .....	870
ipv6 mld snooping report-suppression .....	871
ipv6 mld snooping .....	865
ipv6 mld static-group .....	873
ipv6 nd accept-ra-pinfo .....	709
ipv6 nd current-hoplimit .....	710
ipv6 nd managed-config-flag .....	711
ipv6 nd minimum-ra-interval .....	712
ipv6 nd other-config-flag .....	713
ipv6 nd prefix .....	714
ipv6 nd rguard .....	718
ipv6 nd ra-interval .....	716
ipv6 nd ra-lifetime .....	717
ipv6 nd reachable-time .....	720
ipv6 nd retransmission-time .....	721
ipv6 nd suppress-ra .....	722
ipv6 neighbor .....	723
ipv6 opportunistic-nd .....	724
ipv6 route .....	725
ipv6 route .....	740
ipv6 tftp source-interface .....	108
ipv6 unreachable .....	726
key chain .....	781
key .....	780
key-string .....	782
lACP global-passive-mode enable .....	603
lACP port-priority .....	604
lACP system-priority .....	605
lACP timeout .....	606
length (asyn) .....	150
length (ping-poll data) .....	1940
license update (filename) .....	186
license update online .....	187

---

license .....	179
license-cert (amf-provision) .....	1561
line.....	151
linkflap action .....	425
lldp faststart-count .....	1762
lldp holdtime-multiplier .....	1763
lldp management-address .....	1764
lldp med-notifications .....	1765
lldp med-tlv-select.....	1766
lldp non-strict-med-tlv-order-check .....	1769
lldp notification-interval .....	1770
lldp notifications .....	1771
lldp port-number-type.....	1772
lldp reinit.....	1773
lldp run .....	1774
lldp timer.....	1775
lldp tlv-select.....	1776
lldp transmit receive .....	1778
lldp tx-delay .....	1779
locate (amf-provision) .....	1563
location civic-location configuration .....	1780
location civic-location identifier .....	1784
location civic-location-id .....	1785
location coord-location configuration .....	1786
location coord-location identifier .....	1788
location coord-location-id .....	1789
location elin-location .....	1791
location elin-location-id.....	1792
log buffered (filter) .....	299
log buffered exclude.....	302
log buffered size.....	305
log buffered .....	298
log console (filter) .....	307
log console exclude .....	310
log console.....	306

---

log email (filter).....	314
log email exclude.....	317
log email time.....	320
log email.....	313
log event-host.....	1565
log event-host.....	194
log external (filter).....	324
log external exclude.....	327
log external rotate.....	330
log external size.....	332
log external.....	322
log facility.....	333
log host (filter).....	337
log host exclude.....	340
log host source.....	343
log host startup-delay.....	344
log host time.....	346
log host.....	335
log monitor (filter).....	348
log monitor exclude.....	351
log permanent (filter).....	355
log permanent exclude.....	358
log permanent size.....	361
log permanent.....	354
log trustpoint.....	363
login authentication.....	1228
logout.....	78
log-rate-limit nsm.....	362
loop-protection action.....	427
loop-protection action-delay-time.....	428
loop-protection loop-detect.....	426
loop-protection timeout.....	429
mac address-table acquire.....	430
mac address-table ageing-time.....	431
mac address-table logging.....	432



---

mac address-table static .....	433
mac address-table thrash-limit .....	434
mail from.....	1821
mail smtpserver authentication .....	1823
mail smtpserver port.....	1825
mail smtpserver .....	1822
mail .....	1819
match access-group .....	993
match cos .....	995
match dscp.....	996
match eth-format protocol.....	997
match ip-precedence .....	1000
match mac-type .....	1001
match tcp-flags.....	1002
match vlan .....	1003
max-fib-routes.....	217
max-fib-routes.....	741
maximum-access-list .....	968
maximum-prefix.....	783
max-static-routes.....	218
max-static-routes.....	742
mirror interface.....	395
mkdir .....	109
mls qos cos.....	1004
mls qos enable .....	1005
mls qos map cos-queue.....	1006
mls qos map premark-dscp .....	1007
modeltype .....	1566
move debug.....	111
move.....	110
mru .....	382
mstack command-node.....	1679
mstack enable.....	1680
mstack remote-login.....	1681
mtu .....	383

---

nas .....	1295
neighbor (RIP) .....	784
network (RIP) .....	785
no crypto pki certificate .....	1325
no debug all .....	219
no police .....	1009
normal-interval .....	1941
ntp access-group (deprecated) .....	1695
ntp authenticate .....	1696
ntp authentication-key .....	1697
ntp broadcastdelay .....	1698
ntp discard .....	1699
ntp peer .....	1700
ntp rate-limit .....	1702
ntp restrict .....	1703
ntp server .....	1705
ntp source .....	1707
ntp trusted-key (deprecated) .....	1709
offset-list (RIP) .....	786
optimistic-nd .....	727
passive-interface (RIP) .....	787
ping ipv6 .....	728
ping .....	673
ping-poll .....	1942
platform l3-vlan-hashing-algorithm .....	1170
platform l3-vlan-hashing-algorithm .....	435
platform load-balancing .....	436
platform load-balancing .....	608
platform mac-vlan-hashing-algorithm .....	1171
platform mac-vlan-hashing-algorithm .....	437
platform multicast-ratelimit .....	438
platform stop-unreg-mc-flooding .....	439
polarity .....	441
police single-rate action .....	1010
police twin-rate action .....	1012

---

policy-map .....	1014
port-vlan-forwarding-priority .....	475
power-inline allow-legacy.....	627
power-inline description.....	628
power-inline enable .....	629
power-inline max.....	630
power-inline priority.....	632
power-inline usage-threshold.....	634
priority-queue.....	1015
private-vlan association.....	479
private-vlan .....	478
privilege level .....	153
proxy-port.....	1229
pwd.....	112
radius-secure-proxy aaa.....	1230
radius-secure-proxy local-server.....	1296
radius-server deadtime .....	1249
radius-server host .....	1250
radius-server key .....	1253
radius-server local .....	1297
radius-server retransmit.....	1254
radius-server timeout.....	1256
reboot .....	221
recv-buffer-size (RIP).....	788
redistribute (RIP).....	789
region (MSTP) .....	520
reload.....	222
remark new-cos .....	1018
remark-map.....	1016
remote-mirror interface.....	397
repeat.....	1900
restart rip graceful .....	790
revision (MSTP) .....	521
rip restart grace-period .....	791
rmdir.....	113

---

rmon alarm.....	1831
rmon collection history .....	1833
rmon collection stats .....	1834
rmon event.....	1835
route (RIP).....	792
router rip.....	793
rsa-keypair (ca-trustpoint) .....	1326
sample-size.....	1943
script.....	1901
security-password forced-change .....	155
security-password history.....	154
security-password lifetime .....	156
security-password minimum-categories.....	158
security-password minimum-length.....	159
security-password min-lifetime-enforce .....	157
security-password reject-expired-pwd.....	160
security-password warning .....	161
send-lifetime .....	794
server (radsecproxy-aaa) .....	1231
server (server group).....	1258
server auth-port .....	1298
server enable.....	1299
server mutual-authentication .....	1233
server name-check .....	1234
server trustpoint.....	1235
service advanced-vty .....	162
service atmf-application-proxy.....	1567
service dhcp-snooping.....	1374
service http.....	195
service password-encryption.....	163
service power-inline .....	635
service ssh.....	1858
service statistics interfaces counter.....	384
service telnet.....	164
service terminal-length (deleted).....	165

---

service-policy input.....	1020
sflow agent.....	1959
sflow collector max-datagram-size .....	1963
sflow collector.....	1961
sflow enable.....	1964
sflow max-header-size .....	1965
sflow polling-interval .....	1967
sflow sampling-rate.....	1968
show aaa local user locked.....	1237
show aaa local user locked.....	166
show aaa server group.....	1238
show access-group .....	928
show access-list (IPv4 Hardware ACLs).....	929
show access-list (IPv4 Software ACLs).....	969
show application-proxy threat-protection .....	1568
show application-proxy whitelist interface.....	1570
show application-proxy whitelist server .....	1572
show application-proxy whitelist supplicant.....	1573
show arp security interface.....	1377
show arp security statistics.....	1379
show arp security.....	1376
show arp .....	674
show atmf area guests .....	1582
show atmf area guests-detail.....	1584
show atmf area nodes .....	1586
show atmf area nodes-detail .....	1588
show atmf area summary .....	1590
show atmf area .....	1579
show atmf authorization .....	1591
show atmf backup area .....	1598
show atmf backup guest.....	1600
show atmf backup.....	1594
show atmf container.....	1602
show atmf detail.....	1605
show atmf group members .....	1609

---

show atmf group .....	1607
show atmf guests detail.....	1613
show atmf guests.....	1611
show atmf links detail.....	1618
show atmf links guest detail.....	1629
show atmf links guest.....	1627
show atmf links statistics.....	1633
show atmf links.....	1616
show atmf nodes .....	1636
show atmf provision nodes .....	1638
show atmf recovery-file.....	1640
show atmf secure-mode audit link .....	1644
show atmf secure-mode audit .....	1643
show atmf secure-mode certificates.....	1645
show atmf secure-mode sa.....	1648
show atmf secure-mode statistics .....	1651
show atmf secure-mode .....	1641
show atmf tech.....	1653
show atmf virtual-links.....	1656
show atmf working-set .....	1658
show atmf.....	1575
show auth diagnostics.....	1174
show auth interface.....	1176
show auth sessionstatistics.....	1178
show auth statistics interface .....	1179
show auth supplicant interface.....	1183
show auth supplicant.....	1180
show auth two-step supplicant brief .....	1184
show auth.....	1172
show auth-web-server page .....	1187
show auth-web-server .....	1186
show autoboot .....	114
show banner login.....	1860
show boot.....	115
show class-map .....	1021

---

show clock .....	223
show counter dhcp-client .....	1692
show counter log .....	364
show counter mail .....	1827
show counter ntp (deprecated) .....	1710
show counter ping-poll .....	1945
show counter snmp-server .....	1720
show cpu history .....	228
show cpu .....	225
show crypto key hostkey .....	1861
show crypto key mypubkey rsa .....	1327
show crypto key pubkey-chain knownhosts .....	1863
show crypto key pubkey-chain userkey .....	1864
show crypto key userkey .....	1865
show crypto pki certificates .....	1328
show crypto pki enrollment user .....	1330
show crypto pki trustpoint .....	1331
show debugging aaa .....	1239
show debugging arp security .....	1381
show debugging atmf packet .....	1660
show debugging atmf .....	1659
show debugging dot1x .....	1063
show debugging epsr .....	1414
show debugging igmp .....	846
show debugging ip dhcp snooping .....	1382
show debugging ip packet .....	675
show debugging lacp .....	609
show debugging lldp .....	1793
show debugging loopprot .....	442
show debugging mld .....	875
show debugging mstp .....	522
show debugging platform packet .....	443
show debugging power-inline .....	636
show debugging radius .....	1260
show debugging rip .....	796

---

show debugging sflow .....	1969
show debugging snmp .....	1724
show debugging trigger .....	1903
show debugging udd .....	584
show debugging .....	230
show dhcp lease .....	1693
show diagnostic channel-group .....	610
show dos interface .....	971
show dot1x diagnostics .....	1067
show dot1x interface .....	1069
show dot1x sessionstatistics .....	1071
show dot1x statistics interface .....	1072
show dot1x supplicant interface .....	1075
show dot1x supplicant .....	1073
show dot1x .....	1064
show ecofriendly .....	231
show epsr <epsr-instance> counters .....	1422
show epsr <epsr-instance> .....	1421
show epsr common segments .....	1419
show epsr config-check .....	1420
show epsr counters .....	1423
show epsr summary .....	1424
show epsr .....	1415
show etherchannel detail .....	613
show etherchannel summary .....	614
show etherchannel .....	612
show exception log .....	365
show file systems .....	118
show file .....	117
show flowcontrol interface .....	444
show history .....	79
show hosts .....	693
show http .....	196
show interface access-group .....	931
show interface brief .....	388



---

show interface err-disabled .....	445
show interface memory.....	232
show interface memory.....	389
show interface status .....	391
show interface switchport .....	446
show interface.....	385
show ip access-list .....	974
show ip dhcp snooping acl.....	1384
show ip dhcp snooping agent-option .....	1387
show ip dhcp snooping binding.....	1389
show ip dhcp snooping interface.....	1391
show ip dhcp snooping statistics.....	1393
show ip dhcp snooping.....	1383
show ip domain-list.....	694
show ip domain-name.....	695
show ip flooding-nexthops .....	676
show ip igmp groups .....	847
show ip igmp interface .....	849
show ip igmp snooping mrouter .....	851
show ip igmp snooping routermode .....	852
show ip igmp snooping source-timeout.....	853
show ip igmp snooping statistics.....	854
show ip interface .....	677
show ip name-server.....	696
show ip protocols rip .....	797
show ip rip database.....	799
show ip rip interface .....	800
show ip rip .....	798
show ip route database.....	745
show ip route summary.....	746
show ip route.....	743
show ip sockets.....	678
show ip source binding.....	1396
show ip traffic .....	681
show ipv6 access-list (IPv6 Software ACLs).....	982

---

show ipv6 forwarding.....	730
show ipv6 interface brief.....	731
show ipv6 mld groups.....	876
show ipv6 mld interface.....	877
show ipv6 mld snooping mrouter.....	878
show ipv6 mld snooping statistics.....	879
show ipv6 neighbors.....	732
show ipv6 route summary.....	735
show ipv6 route summary.....	749
show ipv6 route.....	733
show ipv6 route.....	747
show lacp sys-id.....	615
show lacp-counter.....	616
show license brief.....	183
show license external.....	188
show license.....	181
show lldp interface.....	1797
show lldp local-info.....	1799
show lldp neighbors detail.....	1806
show lldp neighbors.....	1804
show lldp statistics interface.....	1812
show lldp statistics.....	1810
show lldp.....	1795
show location.....	1814
show log config.....	368
show log external.....	370
show log permanent.....	371
show log.....	366
show loop-protection.....	447
show mac address-table thrash-limit.....	451
show mac address-table.....	449
show mail.....	1828
show memory allocations.....	236
show memory history.....	238
show memory pools.....	239

---

show memory shared.....	240
show memory.....	234
show mirror interface.....	400
show mirror.....	399
show mls qos interface policer-counters.....	1026
show mls qos interface queue-counters.....	1027
show mls qos interface storm-status.....	1028
show mls qos interface.....	1023
show mls qos maps cos-queue.....	1029
show mls qos maps premark-dscp.....	1030
show mls qos.....	1022
show mstack nodes.....	1683
show ntp associations.....	1711
show ntp counters associations.....	1714
show ntp counters.....	1713
show ntp status.....	1715
show ping-poll.....	1947
show platform classifier statistics utilization brief.....	1031
show platform classifier statistics utilization brief.....	455
show platform port.....	457
show platform.....	452
show policy-map.....	1033
show port etherchannel.....	617
show port-security interface.....	459
show port-security intrusion.....	460
show port-vlan-forwarding-priority.....	480
show power-inline counters.....	640
show power-inline interface detail.....	645
show power-inline interface.....	642
show power-inline.....	637
show privilege.....	167
show process.....	241
show proxy-autoconfig-file.....	1188
show radius local-server group.....	1300
show radius local-server nas.....	1301

---

show radius local-server statistics .....	1302
show radius local-server user .....	1303
show radius server group .....	1240
show radius statistics .....	1264
show radius .....	1261
show reboot history .....	243
show remote-mirror .....	401
show rmon alarm .....	1836
show rmon event .....	1837
show rmon history .....	1839
show rmon statistics .....	1841
show router-id .....	244
show running-config atmf .....	1661
show running-config interface .....	123
show running-config log .....	372
show running-config sflow .....	1971
show running-config snmp .....	1725
show running-config ssh .....	1866
show running-config trigger .....	1904
show running-config .....	120
show security-password configuration .....	168
show security-password user .....	169
show sflow interface .....	1974
show sflow .....	1972
show snmp-server community .....	1727
show snmp-server group .....	1728
show snmp-server user .....	1729
show snmp-server view .....	1730
show snmp-server .....	1726
show spanning-tree brief .....	526
show spanning-tree mst config .....	528
show spanning-tree mst detail interface .....	531
show spanning-tree mst detail .....	529
show spanning-tree mst instance interface .....	534
show spanning-tree mst instance .....	533

---

show spanning-tree mst interface .....	535
show spanning-tree mst .....	527
show spanning-tree statistics instance interface .....	539
show spanning-tree statistics instance .....	538
show spanning-tree statistics interface .....	541
show spanning-tree statistics .....	536
show spanning-tree vlan range-index .....	543
show spanning-tree .....	523
show ssh client .....	1870
show ssh server allow-users .....	1873
show ssh server deny-users .....	1874
show ssh server .....	1871
show ssh .....	1868
show startup-config .....	125
show static-channel-group .....	618
show storm-control .....	461
show system environment .....	246
show system fiber-monitoring .....	270
show system interrupts .....	247
show system mac .....	248
show system pluggable detail .....	275
show system pluggable diagnostics .....	278
show system pluggable .....	273
show system serialnumber .....	249
show system .....	245
show tacacs+ .....	1341
show tech-support .....	250
show telnet .....	170
show test cable-diagnostics tdr .....	280
show trigger .....	1905
show udld neighbors .....	586
show udld port .....	587
show udld .....	585
show users .....	171
show version .....	126

---

show vlan access-map .....	482
show vlan filter .....	483
show vlan private-vlan .....	484
show vlan .....	481
shutdown .....	393
snmp trap link-status suppress .....	1732
snmp trap link-status .....	1731
snmp-server community .....	1736
snmp-server contact .....	1737
snmp-server enable trap .....	1738
snmp-server engineID local reset .....	1742
snmp-server engineID local .....	1740
snmp-server group .....	1743
snmp-server host .....	1745
snmp-server legacy-ifadminstatus .....	1747
snmp-server location .....	1748
snmp-server source-interface .....	1749
snmp-server startup-trap-delay .....	1750
snmp-server user .....	1751
snmp-server view .....	1754
snmp-server .....	1734
source-ip .....	1951
spanning-tree autoedge (RSTP and MSTP) .....	544
spanning-tree bpdu .....	545
spanning-tree cisco-interoperability (MSTP) .....	547
spanning-tree edgeport (RSTP and MSTP) .....	548
spanning-tree enable .....	549
spanning-tree errdisable-timeout enable .....	551
spanning-tree errdisable-timeout interval .....	552
spanning-tree force-version .....	553
spanning-tree forward-time .....	554
spanning-tree guard root .....	555
spanning-tree hello-time .....	556
spanning-tree link-type .....	557
spanning-tree max-age .....	558

---

spanning-tree max-hops (MSTP) .....	559
spanning-tree mode .....	560
spanning-tree mst configuration .....	561
spanning-tree mst instance path-cost .....	563
spanning-tree mst instance priority .....	565
spanning-tree mst instance restricted-role .....	566
spanning-tree mst instance restricted-tcn .....	568
spanning-tree mst instance .....	562
spanning-tree path-cost .....	569
spanning-tree portfast (STP) .....	570
spanning-tree portfast bpdu-filter .....	572
spanning-tree portfast bpdu-guard .....	574
spanning-tree priority (bridge priority) .....	576
spanning-tree priority (port priority) .....	577
spanning-tree restricted-role .....	578
spanning-tree restricted-tcn .....	579
spanning-tree transmit-holdcount .....	580
speed (asyn) .....	252
speed .....	462
ssh client .....	1877
ssh server allow-users .....	1881
ssh server authentication .....	1883
ssh server deny-users .....	1885
ssh server max-auth-tries .....	1887
ssh server resolve-host .....	1888
ssh server scp .....	1889
ssh server sftp .....	1890
ssh server .....	1879
ssh .....	1875
state .....	1662
static-channel-group .....	619
storm-action .....	1034
storm-control level .....	464
storm-downtime .....	1035
storm-protection .....	1036

---

storm-rate.....	1037
storm-window.....	1038
subject-name (ca-trustpoint).....	1332
switchport access vlan.....	485
switchport atmf-agentlink.....	1664
switchport atmf-arealink remote-area.....	1665
switchport atmf-crosslink.....	1667
switchport atmf-guestlink.....	1669
switchport atmf-link.....	1671
switchport mode access.....	486
switchport mode private-vlan trunk promiscuous.....	488
switchport mode private-vlan trunk secondary.....	490
switchport mode private-vlan.....	487
switchport mode trunk.....	492
switchport mstack-link.....	1684
switchport port-security aging.....	466
switchport port-security maximum.....	467
switchport port-security violation.....	468
switchport port-security.....	465
switchport private-vlan host-association.....	493
switchport private-vlan mapping.....	494
switchport remote-mirror-egress.....	403
switchport trunk allowed vlan.....	495
switchport trunk native vlan.....	498
switchport voice dscp.....	499
switchport voice vlan priority.....	502
switchport voice vlan.....	500
system territory (deprecated).....	254
tacacs-server host.....	1343
tacacs-server key.....	1345
tacacs-server timeout.....	1346
tcpdump.....	683
telnet server.....	173
telnet.....	172
terminal length.....	174



---

terminal monitor .....	255
terminal resize.....	175
test cable-diagnostics tdr interface.....	281
test .....	1910
thrash-limiting .....	469
time (trigger).....	1911
timeout (ping polling) .....	1953
timers (RIP) .....	801
traceroute ipv6 .....	736
traceroute.....	684
trap .....	1913
trigger activate .....	1915
trigger .....	1914
trust dscp .....	1039
type atmf node .....	1672
type atmf node .....	1916
type card.....	1919
type cpu .....	1920
type interface .....	1921
type linkmon-probe .....	1922
type log .....	1924
type memory.....	1925
type periodic .....	1926
type ping-poll .....	1927
type reboot .....	1928
type time.....	1929
udld aggressive-mode .....	588
udld enable .....	589
udld port aggressive-mode .....	591
udld port disable .....	592
udld port.....	590
udld reset .....	593
udld time disable-period.....	594
udld time message-interval .....	595
undebg aaa .....	1242

---

undebg all	256
undebg atmf	1675
undebg dot1x	1077
undebg epsr	1425
undebg igmp	856
undebg ip packet interface	685
undebg lacp	621
undebg loopprot	471
undebg mail	1829
undebg mstp	581
undebg ping-poll	1955
undebg platform packet	472
undebg radius	1265
undebg rip	802
undebg sflow	1975
undebg snmp	1755
undebg ssh client	1891
undebg ssh server	1892
undebg trigger	1930
undebg udld	596
unmount	127
unmount	373
up-count	1954
user (RADIUS server)	1305
username	1676
username	176
version (RIP)	803
vlan (RADIUS server)	1307
vlan access-map	505
vlan database	506
vlan filter	507
vlan mode remote-mirror-vlan	404
vlan	503
vty access-class (numbered)	975
vty ipv6 access-class (named)	983

---

wait .....	377
write file.....	128
write memory .....	129
write terminal .....	130
wrr-queue disable queues .....	1040
wrr-queue egress-rate-limit queues .....	1041
wrr-queue weight queues.....	1042

# Part 1: Setup and Troubleshooting

# 1

# CLI Navigation Commands

## Introduction

**Overview** This chapter provides an alphabetical reference for the commands used to navigate between different modes. This chapter also provides a reference for the help and show commands used to help navigate within the CLI.

- Command List**
- “[configure terminal](#)” on page 70
  - “[disable \(Privileged Exec mode\)](#)” on page 71
  - “[do](#)” on page 72
  - “[enable \(Privileged Exec mode\)](#)” on page 73
  - “[end](#)” on page 75
  - “[exit](#)” on page 76
  - “[help](#)” on page 77
  - “[logout](#)” on page 78
  - “[show history](#)” on page 79

# configure terminal

**Overview** This command enters the Global Configuration command mode.

**Syntax** `configure terminal`

**Mode** Privileged Exec

**Example** To enter the Global Configuration command mode (note the change in the command prompt), enter the command:

```
awplus# configure terminal  
awplus(config)#
```

# disable (Privileged Exec mode)

**Overview** This command exits the Privileged Exec mode, returning the prompt to the User Exec mode. To end a session, use the [exit](#) command.

**Syntax** `disable`

**Mode** Privileged Exec

**Example** To exit the Privileged Exec mode, enter the command:

```
awplus# disable
awplus>
```

**Related commands**

- [enable \(Privileged Exec mode\)](#)
- [end](#)
- [exit](#)

# do

**Overview** This command lets you to run User Exec and Privileged Exec mode commands when you are in any configuration mode.

**Syntax** `do <command>`

Parameter	Description
<code>&lt;command&gt;</code>	Specify the command and its parameters.

**Mode** Any configuration mode

**Example**  
`awplus# configure terminal`  
`awplus(config)# do ping 192.0.2.23`



# enable (Privileged Exec mode)

**Overview** This command enters the Privileged Exec mode and optionally changes the privilege level for a session. If a privilege level is not specified then the maximum privilege level (15) is applied to the session. If the optional privilege level is omitted then only users with the maximum privilege level can access Privileged Exec mode without providing the password as specified by the [enable password](#) or [enable secret](#) commands. If no password is specified then only users with the maximum privilege level set with the [username](#) command can assess Privileged Exec mode.

**Syntax** `enable [<privilege-level>]`

Parameter	Description
<code>&lt;privilege - level&gt;</code>	Specify the privilege level for a CLI session in the range <1-15>, where 15 is the maximum privilege level, 7 is the intermediate privilege level and 1 is the minimum privilege level. The privilege level for a user must match or exceed the privilege level set for the CLI session for the user to access Privileged Exec mode. Privilege level for a user is configured by <a href="#">username</a> .

**Mode** User Exec

**Usage notes** Many commands are available from the Privileged Exec mode that configure operating parameters for the device, so you should apply password protection to the Privileged Exec mode to prevent unauthorized use. Passwords can be encrypted but then cannot be recovered. Note that non-encrypted passwords are shown in plain text in configurations.

The [username](#) command sets the privilege level for the user. After login, users are given access to privilege level 1. Users access higher privilege levels with the [enable \(Privileged Exec mode\)](#) command. If the privilege level specified is higher than the users configured privilege level specified by the [username](#) command, then the user is prompted for the password for that level.

Note that a separate password can be configured for each privilege level using the [enable password](#) and the [enable secret](#) commands from the Global Configuration mode. The [service password-encryption](#) command encrypts passwords configured by the [enable password](#) and the [enable secret](#) commands, so passwords are not shown in plain text in configurations.

**Example** The following example shows the use of the **enable** command to enter the Privileged Exec mode (note the change in the command prompt).

```
awplus> enable  
awplus#
```

The following example shows the **enable** command enabling access the Privileged Exec mode for users with a privilege level of 7 or greater. Users with a privilege level of 7 or greater do not need to enter a password to access Privileged Exec mode. Users with a privilege level 6 or less need to enter a password to access

Privilege Exec mode. Use the [enable password](#) command or the [enable secret](#) commands to set the password to enable access to Privileged Exec mode.

```
awplus> enable 7
```

```
awplus#
```

**Related  
commands**

[disable \(Privileged Exec mode\)](#)

[enable password](#)

[enable secret](#)

[exit](#)

[service password-encryption](#)

[username](#)

# end

**Overview** This command returns the prompt to the Privileged Exec command mode from any other advanced command mode.

**Syntax** end

**Mode** All advanced command modes, including Global Configuration and Interface Configuration modes.

**Example** The following example shows the use of the **end** command to return to the Privileged Exec mode directly from Interface mode.

```
awplus# configure terminal
awplus(config)# interface vlan2
awplus(config-if)# end
awplus#
```

**Related commands**

- disable (Privileged Exec mode)
- enable (Privileged Exec mode)
- exit

# exit

**Overview** This command exits the current mode, and returns the prompt to the mode at the previous level. When used in User Exec mode, the **exit** command terminates the session.

**Syntax** `exit`

**Mode** All command modes, including Global Configuration and Interface Configuration modes.

**Example** The following example shows the use of the **exit** command to exit Interface mode, and return to Configure mode.

```
awplus# configure terminal
awplus(config)# interface vlan2
awplus(config-if)# exit
awplus(config)#
```

**Related commands**

- [disable \(Privileged Exec mode\)](#)
- [enable \(Privileged Exec mode\)](#)
- [end](#)

# help

**Overview** This command displays a description of the AlliedWare Plus™ OS help system.

**Syntax** help

**Mode** All command modes

**Example** To display a description on how to use the system help, use the command:

```
awplus# help
```

**Output** Figure 1-1: Example output from the **help** command

```
When you need help at the command line, press '?'.

If nothing matches, the help list will be empty. Delete
characters until entering a '?' shows the available options.

Enter '?' after a complete parameter to show remaining valid
command parameters (e.g. 'show ?').

Enter '?' after part of a parameter to show parameters that
complete the typed letters (e.g. 'show ip?').
```

# logout

**Overview** This command exits the User Exec or Privileged Exec modes and ends the session.

**Syntax** `logout`

**Mode** User Exec and Privileged Exec

**Example** To exit the User Exec mode, use the command:

```
awplus# logout
```

# show history

**Overview** This command lists the commands entered in the current session. The history buffer is cleared automatically upon reboot.

The output lists all command line entries, including commands that returned an error.

For information on filtering and saving command output, see the [“Getting Started with AlliedWare Plus” Feature Overview and Configuration Guide](#).

**Syntax** `show history`

**Mode** User Exec and Privileged Exec

**Example** To display the commands entered during the current session, use the command:

```
awplus# show history
```

**Output** Figure 1-2: Example output from the **show history** command

```
1 en
2 show ru
3 conf t
4 route-map er deny 3
5 exit
6 ex
7 di
```

# 2

# File and Configuration Management Commands

## Introduction

**Overview** This chapter provides an alphabetical reference of AlliedWare Plus™ OS file and configuration management commands.

**Filename Syntax and Keyword Usage** Many of the commands in this chapter use the placeholder “filename” to represent the name and location of the file that you want to act on. The following table explains the syntax of the filename for each different type of file location.

When you copy a file...	Use this syntax:	Example:
Copying in local flash memory	<code>flash:[/][&lt;directory&gt;/]&lt;filename&gt;</code>	To specify a file in the configs directory in flash: <code>flash:configs/example.cfg</code>
Copying to or from an SD (or SDHC) card	<code>card:[/][&lt;directory&gt;/]&lt;filename&gt;</code>	To specify a file in the top-level directory of the SD card: <code>card:example.cfg</code>
Copying with HTTP	<code>http://[[&lt;username&gt;:&lt;password&gt;]@]{&lt;hostname&gt; &lt;host-ip&gt;}[/&lt;filepath&gt;]/&lt;filename&gt;</code>	To specify a file in the configs directory on the server: <code>http://www.company.com/configs/example.cfg</code>
Copying with TFTP	<code>tftp://[[&lt;location&gt;]/&lt;directory&gt;] /&lt;filename&gt;</code>	To specify a file in the top-level directory of the server: <code>tftp://172.1.1.1/example.cfg</code>
Copying with SCP	<code>scp://&lt;username&gt;@&lt;location&gt;[/&lt;directory&gt;] /&lt;filename&gt;</code>	To specify a file in the configs directory on the server, logging on as user “bob”: e.g. <code>scp://bob@10.10.0.12/configs/example.cfg</code>
Copying with SFTP	<code>sftp://[[&lt;location&gt;] /&lt;directory&gt;] /&lt;filename&gt;</code>	To specify a file in the top-level directory of the server: <code>sftp://10.0.0.5/example.cfg</code>



**Valid characters** The filename and path can include characters from up to four categories. The categories are:

- 1) uppercase letters: A to Z
- 2) lowercase letters: a to z
- 3) digits: 0 to 9
- 4) special symbols: most printable ASCII characters not included in the previous three categories, including the following characters:
  - -
  - /
  - .
  - \_
  - @
  - "
  - '
    - \*
  - :
  - ~
  - ?

Do not use spaces, parentheses or the + symbol within filenames. Use hyphens or underscores instead.

### Syntax for directory listings

A leading slash (/) indicates the root of the current filesystem location.

In commands where you need to specify the local filesystem's flash base directory, you may use **flash** or **flash:** or **flash:/**. For example, these commands are all the same:

- `dir flash`
- `dir flash:`
- `dir flash:/`

Similarly, you can specify the SD (or SDHC) card base directory with **card** or **card:** or **card:/**

You cannot name a directory or subdirectory **flash**, **nvs**, **usb**, **card**, **tftp**, **scp**, **sftp** or **http**. These keywords are reserved for tab completion when using various file commands.

### Command List

- ["autoboot enable"](#) on page 83
- ["boot config-file"](#) on page 84
- ["boot config-file backup"](#) on page 86
- ["boot system"](#) on page 87

- [“boot system backup”](#) on page 89
- [“cd”](#) on page 90
- [“copy \(filename\)”](#) on page 91
- [“copy current-software”](#) on page 93
- [“copy debug”](#) on page 94
- [“copy running-config”](#) on page 95
- [“copy startup-config”](#) on page 96
- [“copy zmodem”](#) on page 97
- [“create autoboot”](#) on page 98
- [“delete”](#) on page 99
- [“delete debug”](#) on page 100
- [“dir”](#) on page 101
- [“edit”](#) on page 103
- [“edit \(filename\)”](#) on page 104
- [“erase factory-default”](#) on page 105
- [“erase startup-config”](#) on page 106
- [“ip tftp source-interface”](#) on page 107
- [“ipv6 tftp source-interface”](#) on page 108
- [“mkdir”](#) on page 109
- [“move”](#) on page 110
- [“move debug”](#) on page 111
- [“pwd”](#) on page 112
- [“rmdir”](#) on page 113
- [“show autoboot”](#) on page 114
- [“show boot”](#) on page 115
- [“show file”](#) on page 117
- [“show file systems”](#) on page 118
- [“show running-config”](#) on page 120
- [“show running-config interface”](#) on page 123
- [“show startup-config”](#) on page 125
- [“show version”](#) on page 126
- [“unmount”](#) on page 127
- [“write file”](#) on page 128
- [“write memory”](#) on page 129
- [“write terminal”](#) on page 130

# autoboot enable

**Overview** This command enables the device to restore a release file and/or a configuration file from an SD card.

When the Autoboot feature is enabled, the device looks for a special file called `autoboot.txt` on the external media. If this file exists, the device will check the key and values in the file and recover the device with a new release file and/or configuration file from the external media. An example of a valid `autoboot.txt` file is shown in the following figure.

Figure 2-1: Example `autoboot.txt` file

```
[AlliedWare Plus]
Copy_from_external_media_enabled=yes
Boot_Release=GS970-5.5.0-0.1.rel
Boot_Config=network1.cfg
```

Use the **no** variant of this command to disable the Autoboot feature.

**Syntax** `autoboot enable`  
`no autoboot enable`

**Default** The Autoboot feature operates the first time the device is powered up in the field, after which the feature is disabled by default.

**Mode** Global Configuration

**Example** To enable the Autoboot feature, use the command:

```
awplus# configure terminal
awplus(config)# autoboot enable
```

**Related commands** [create autoboot](#)  
[show autoboot](#)  
[show boot](#)

# boot config-file

**Overview** Use this command to set the configuration file to use during the next boot cycle. Use the **no** variant of this command to remove the configuration file.

**Syntax** boot config-file <filepath-filename>  
no boot config-file

Parameter	Description
<filepath-filename>	Filepath and name of a configuration file. The specified configuration file must exist in the specified filesystem. Valid configuration files must have a <b>.cfg</b> extension.

**Mode** Global Configuration

**Usage notes** You can only specify that the configuration file is on an SD card if there is a backup configuration file already specified in Flash. If you attempt to set the configuration file on an SD card and a backup configuration file is not specified in Flash, the following error message is displayed:

```
% Backup configuration files must be stored in the flash  
filesystem
```

In addition, you can only specify that the configuration file is on an SD card if the card is writable.

For an explanation of the configuration fallback order, see the [File Management Feature Overview and Configuration Guide](#).

**Examples** To run the configuration file "branch.cfg" the next time the device boots up, when "branch.cfg" is stored on the device's Flash filesystem, use the commands:

```
awplus# configure terminal  
awplus(config)# boot config-file flash:/branch.cfg
```

To stop running the configuration file "branch.cfg" when the device boots up, when "branch.cfg" is stored on the device's Flash filesystem, use the commands:

```
awplus# configure terminal  
awplus(config)# no boot config-file flash:/branch.cfg
```

To run the configuration file "branch.cfg" the next time the device boots up, when "branch.cfg" is stored on an SD card, use the commands:

```
awplus# configure terminal  
awplus(config)# boot config-file card:/branch.cfg
```

To stop running the configuration file “branch.cfg” when the device boots up, when “branch.cfg” is stored on an SD card, use the commands:

```
awplus# configure terminal
awplus(config)# no boot config-file card:/branch.cfg
```

**Related commands**

- boot config-file backup
- boot system
- boot system backup
- show boot

# boot config-file backup

**Overview** Use this command to set a backup configuration file to use if the main configuration file cannot be accessed.

Use the **no** variant of this command to remove the backup configuration file.

**Syntax** `boot config-file backup <filepath-filename>`  
`no boot config-file backup`

Parameter	Description
<code>&lt;filepath-filename&gt;</code>	Filepath and name of a backup configuration file. Backup configuration files must be in the Flash filesystem. Valid backup configuration files must have a <b>.cfg</b> extension.
<code>backup</code>	The specified file is a backup configuration file.

**Mode** Global Configuration

**Usage notes** For an explanation of the configuration fallback order, see the [File Management Feature Overview and Configuration Guide](#).

**Examples** To set the configuration file `backup.cfg` as the backup to the main configuration file, use the commands:

```
awplus# configure terminal
awplus(config)# boot config-file backup flash:/backup.cfg
```

To remove the configuration file `backup.cfg` as the backup to the main configuration file, use the commands:

```
awplus# configure terminal
awplus(config)# no boot config-file backup flash:/backup.cfg
```

**Related commands**

- [boot config-file](#)
- [boot system](#)
- [boot system backup](#)
- [show boot](#)

# boot system

**Overview** Use this command to set the release file to load during the next boot cycle.

Use the **no** variant of this command to stop specifying a primary release file to boot from. If the device boots up with no release file set, it will use autoboot or the backup release file if either of those are configured, or you can use the boot menu to select a release file source. To access the boot menu, type Ctrl-B at bootup.

**Syntax** `boot system <filepath-filename>`  
`no boot system`

Parameter	Description
<code>&lt;filepath-filename&gt;</code>	Filepath and name of a release file. The specified release file must exist and must be stored in the root directory of the specified filesystem. Valid release files must have a <b>.rel</b> extension.

**Mode** Global Configuration

**Usage notes** You can only specify that the release file is on an SD card if there is a backup release file already specified in flash. If you attempt to set the release file on an SD card and a backup release file is not specified in flash, the following error message is displayed:

```
A backup boot image must be set before setting a current boot image on card
```

In addition, you can only specify that the configuration file is on an SD card if the card is writable.

**Examples** To boot up with the release file GS970-5.5.0-0.1.rel the next time the device boots up, when the release file is stored on the device's flash filesystem, use the commands:

```
awplus# configure terminal  
awplus(config)# boot system flash:/GS970-5.5.0-0.1.rel
```

To run the release file GS970-5.5.0-0.1.rel the next time the device boots up, when the release file is stored on an SD card, use the commands:

```
awplus# configure terminal  
awplus(config)# boot system card:/GS970-5.5.0-0.1.rel
```

**Related commands**

- boot config-file
- boot config-file backup
- boot system backup
- show boot



# boot system backup

**Overview** Use this command to set a backup release file to load if the main release file cannot be loaded.

Use the **no** variant of this command to stop specifying a backup release file.

**Syntax** `boot system backup <filepath-filename>`  
`no boot system backup`

Parameter	Description
<code>&lt;filepath-filename&gt;</code>	Filepath and name of a backup release file. Backup release files must be in the Flash filesystem. Valid release files must have a <b>.rel</b> extension.
<code>backup</code>	The specified file is a backup release file.

**Mode** Global Configuration

**Examples** To specify the file GS970-5.4.9-2.1.rel as the backup to the main release file, use the commands:

```
awplus# configure terminal  
awplus(config)# boot system backup flash:/GS970-5.4.9-2.1.rel
```

To stop specifying a backup to the main release file, use the commands:

```
awplus# configure terminal  
awplus(config)# no boot system backup
```

**Related commands** [boot config-file](#)  
[boot config-file backup](#)  
[boot system](#)  
[show boot](#)

# cd

**Overview** This command changes the current working directory.

**Syntax** `cd <directory-name>`

Parameter	Description
<code>&lt;directory-name&gt;</code>	Name and path of the directory.

**Mode** Privileged Exec

**Example** To change to the directory called `images`, use the command:

```
awplus# cd images
```

**Related commands**

- `dir`
- `pwd`
- `show file systems`

# copy (filename)

**Overview** This command copies a file. This allows you to:

- copy files from your device to a remote device
- copy files from a remote device to your device
- copy files stored on Flash memory to or from a different memory type, such as an SD card
- create two copies of the same file on your device

**Syntax** `copy [force] <source-name> <destination-name>`

Parameter	Description
<code>force</code>	This parameter forces the copy command to overwrite the destination file, if it already exists, without prompting the user for confirmation.
<code>&lt;source-name&gt;</code>	The filename and path of the source file. See <a href="#">Introduction</a> on page 80 for valid syntax.
<code>&lt;destination-name&gt;</code>	The filename and path for the destination file. See <a href="#">Introduction</a> on page 80 for valid syntax.

**Mode** Privileged Exec

**Examples** To use TFTP to copy the file "bob.key" into the current directory from the remote server at 10.0.0.1, use the command:

```
awplus# copy tftp://10.0.0.1/bob.key bob.key
```

To use SFTP to copy the file "new.cfg" into the current directory from a remote server at 10.0.1.2, use the command:

```
awplus# copy sftp://10.0.1.2/new.cfg bob.key
```

To use SCP with the username "beth" to copy the file old.cfg into the directory config\_files on a remote server that is listening on TCP port 2000, use the command:

```
awplus# copy scp://beth@serv:2000/config_files/old.cfg old.cfg
```

To copy the file "newconfig.cfg" onto your device's Flash from an SD (or SDHC) Card, use the command:

```
awplus# copy card:/newconfig.cfg flash:/newconfig.cfg
```

To copy the file "newconfig.cfg" to an SD (or SDHC) Card from your device's Flash, use the command:

```
awplus# copy flash:/newconfig.cfg card:/newconfig.cfg
```

To copy the file "config.cfg" into the current directory from an SD (or SDHC) Card, and rename it to "configtest.cfg", use the command:

```
awplus# copy card:/config.cfg configtest.cfg
```

To copy the file "config.cfg" into the current directory from a remote file server, and rename it to "configtest.cfg", use the command:

```
awplus# copy fserver:/config.cfg configtest.cfg
```

On an AMF network, to copy the device GUI file from the AMF master to the Flash memory of 'node\_1', use the command:

```
master# copy awplus-gui_549_13.gui node_1.atmf/flash:
```

**Related  
commands**

[copy zmodem](#)

[copy buffered-log](#)

[copy permanent-log](#)

[edit \(filename\)](#)

[show file systems](#)

# copy current-software

**Overview** This command copies the AlliedWare Plus™ OS software that the device has booted from, to a destination file. Specify whether the destination is Flash or card when saving the software to the local filesystem.

**Syntax** `copy current-software <destination-name>`

Parameter	Description
<code>&lt;destination-name&gt;</code>	The filename and path where you would like the current running-release saved. This command creates a file if no file exists with the specified filename. If a file already exists, then the CLI prompts you before overwriting the file. See <a href="#">Introduction</a> on page 80 for valid syntax.

**Mode** Privileged Exec

**Example** To copy the current software as installed in the working directory with the file name `my-release.rel`, use the command:

```
awplus# copy current-software my-release.rel
```

**Related commands** [boot system backup](#)  
[show boot](#)

# copy debug

**Overview** This command copies a specified debug file to a destination file.

**Syntax** `copy debug {<destination-name>|card|debug|flash|scp|tftp}`  
`{<source-name>|card|debug|flash|scp|tftp}`

Parameter	Description
<code>&lt;destination-name&gt;</code>	The filename and path where you would like the debug output saved. See <a href="#">Introduction</a> on page 80 for valid syntax.
<code>&lt;source-name&gt;</code>	The filename and path where the debug output originates. See the <a href="#">Introduction</a> to this chapter for valid syntax.

**Mode** Privileged Exec

**Example** To copy debug output to a file on flash called “my-debug”, use the following command:

```
awplus# copy debug flash:my-debug
```

To copy debug output to an SD (or SDHC) card with a filename “my-debug”, use the following command:

```
awplus# copy debug card:my-debug
```

**Output** Figure 2-2: CLI prompt after entering the **copy debug** command

```
Enter source file name []:
```

**Related commands** [delete debug](#)  
[move debug](#)

# copy running-config

**Overview** This command copies the running-config to a destination file, or copies a source file into the running-config. Commands entered in the running-config do not survive a device reboot unless they are saved in a configuration file.

**Syntax** `copy <source-name> running-config`  
`copy running-config [<destination-name>]`  
`copy running-config startup-config`

Parameter	Description
<code>&lt;source-name&gt;</code>	The filename and path of a configuration file. This must be a valid configuration file with a <b>.cfg</b> filename extension. Specify this when you want the script in the file to become the new running-config. See <a href="#">Introduction</a> on page 80 for valid syntax.
<code>&lt;destination-name&gt;</code>	The filename and path where you would like the current running-config saved. This command creates a file if no file exists with the specified filename. If a file already exists, then the CLI prompts you before overwriting the file. See <a href="#">Introduction</a> on page 80 for valid syntax. If you do not specify a file name, the device saves the running-config to a file called default.cfg.
<code>startup-config</code>	Copies the running-config into the file set as the current startup-config file.

**Mode** Privileged Exec

**Examples** To copy the `running-config` into the `startup-config`, use the command:

```
awplus# copy running-config startup-config
```

To copy the file `layer3.cfg` into the `running-config`, use the command:

```
awplus# copy layer3.cfg running-config
```

To use SCP to copy the `running-config` as `current.cfg` to the remote server listening on TCP port 2000, use the command:

```
awplus# copy running-config  
scp://user@server:2000/config_files/current.cfg
```

**Related commands** [copy startup-config](#)  
[write file](#)  
[write memory](#)

# copy startup-config

**Overview** This command copies the startup-config script into a destination file, or alternatively copies a configuration script from a source file into the startup-config file. Specify whether the destination is Flash or card when loading from the local filesystem.

**Syntax** `copy <source-name> startup-config`  
`copy startup-config <destination-name>`

Parameter	Description
<code>&lt;source-name&gt;</code>	The filename and path of a configuration file. This must be a valid configuration file with a <b>.cfg</b> filename extension. Specify this to copy the script in the file into the startup-config file. Note that this does not make the copied file the new startup file, so any further changes made in the configuration file are not added to the startup-config file unless you reuse this command. See <a href="#">Introduction</a> on page 80 for valid syntax.
<code>&lt;destination-name&gt;</code>	The destination and filename that you are saving the startup-config as. This command creates a file if no file exists with the specified filename. If a file already exists, then the CLI prompts you before overwriting the file. See <a href="#">Introduction</a> on page 80 for valid syntax.

**Mode** Privileged Exec

**Examples** To copy the file `Layer3.cfg` to the `startup-config`, use the command:

```
awplus# copy Layer3.cfg startup-config
```

To copy the `startup-config` as the file `oldconfig.cfg` in the current directory, use the command:

```
awplus# copy startup-config oldconfig.cfg
```

**Related commands** [copy running-config](#)



# copy zmodem

**Overview** This command allows you to copy files using ZMODEM using Minicom. ZMODEM works over a serial connection and does not need any interfaces configured to do a file transfer.

**Syntax** `copy <source-name> zmodem`  
`copy zmodem`

Parameter	Description
<code>&lt;source-name&gt;</code>	The filename and path of the source file. See <a href="#">Introduction</a> on page 80 for valid syntax.

**Mode** Privileged Exec

**Example** To copy the local file `asuka.key` using ZMODEM, use the command:

```
awplus# copy asuka.key zmodem
```

**Related commands** [copy \(filename\)](#)  
[show file systems](#)

# create autoboot

**Overview** Use this command to create an autoboot.txt file on an external storage device. This command will automatically ensure that the keys and values that are expected in this file are correct. After the file is created the **create autoboot** command will copy the current release and configuration files across to the external storage device. The external storage device is then available to restore a release file and/or a configuration file to the device.

**Syntax** `create autoboot card`

**Mode** Privileged Exec

**Example** To create an autoboot.txt file on an SD card, use the command:

```
awplus# create autoboot card
```

**Related commands**

- [autoboot enable](#)
- [show autoboot](#)
- [show boot](#)

# delete

**Overview** This command deletes files or directories.

**Syntax** `delete [force] [recursive] <filename>`

Parameter	Description
<code>force</code>	Ignore nonexistent filenames and never prompt before deletion.
<code>recursive</code>	Remove the contents of directories recursively.
<code>&lt;filename&gt;</code>	The filename and path of the file to delete. See <a href="#">Introduction</a> on page 80 for valid syntax.

**Mode** Privileged Exec

**Examples** To delete the file `temp.cfg` from the current directory, use the command:

```
awplus# delete temp.cfg
```

To delete the read-only file `one.cfg` from the current directory, use the command:

```
awplus# delete force one.cfg
```

To delete the directory `old_configs`, which is not empty, use the command:

```
awplus# delete recursive old_configs
```

To delete the directory `new_configs`, which is not empty, without prompting if any read-only files are being deleted, use the command:

```
awplus# delete force recursive new_configs
```

**Related commands** [erase startup-config](#)  
[rmdir](#)

# delete debug

**Overview** Use this command to delete a specified debug output file.

**Syntax** delete debug <source-name>

Parameter	Description
<source-name>	The filename and path where the debug output originates. See <a href="#">Introduction</a> on page 80 for valid URL syntax.

**Mode** Privileged Exec

**Example** To delete debug output, use the following command:

```
awplus# delete debug
```

**Output** Figure 2-3: CLI prompt after entering the **delete debug** command

```
Enter source file name []:
```

**Related commands** [copy debug](#)  
[move debug](#)

# dir

**Overview** This command lists the files on a filesystem. If you don't specify a directory or file, then this command lists the files in the current directory.

**Syntax** `dir [all] [recursive] [sort [reverse] [name|size|time]] [<filename> | card | debug | flash | nvs]`

Parameter	Description
all	List all files.
recursive	List the contents of directories recursively.
sort	Sort directory listing.
reverse	Sort using reverse order.
name	Sort by name.
size	Sort by size.
time	Sort by modification time (default).
<i>&lt;filename&gt;</i>	The name of the directory or file. If you don't specify a directory or file, then this command lists the files in the current directory.
card	SD (or SDHC) card root directory
debug	Debug root directory
flash	Flash memory root directory
nvs	NVS memory root directory

**Mode** Privileged Exec

**Examples** To list the files in the current working directory, use the command:

```
awplus# dir
```

To list the non-hidden files in the root of the Flash filesystem, use the command:

```
awplus# dir flash
```

To list all the files in the root of the Flash filesystem, use the command:

```
awplus# dir all flash:
```

To list recursively the files in the Flash filesystem, use the command:

```
awplus# dir recursive flash:
```

To list the files in alphabetical order, use the command:

```
awplus# dir sort name
```

To list the files by size, smallest to largest, use the command:

```
awplus# dir sort reverse size
```

To sort the files by modification time, oldest to newest, use the command:

```
awplus# dir sort reverse time
```

**Output** Figure 2-4: Example output from the **dir** command

```
awplus#dir
 630 -rw- May 19 2016 23:36:31 example.cfg
23652123 -rw- May 17 2016 03:41:18
 149 -rw- Feb 9 2016 00:40:35 exception.log
```

**Related commands** [cd](#)  
[pwd](#)

# edit

**Overview** This command opens a text file in the AlliedWare Plus™ text editor. Once opened you can use the editor to alter to the file.

If a filename is specified and it already exists, then the editor opens it in the text editor.

If no filename is specified, the editor prompts you for one when you exit it.

Before starting the editor make sure your terminal, terminal emulation program, or Telnet client is 100% compatible with a VT100 terminal. The editor uses VT100 control sequences to display text on the terminal.

For more information about using the editor, including control sequences, see the [File Management Feature Overview and Configuration Guide](#).

**Syntax** `edit [<filename>]`

Parameter	Description
<code>&lt;filename&gt;</code>	Name of a file in the local Flash filesystem.

**Mode** Privileged Exec

**Examples** To create and edit a new text file, use the command:

```
awplus# edit
```

To edit the existing configuration file `myconfig.cfg` stored on your device's Flash memory, use the command:

```
awplus# edit myconfig.cfg
```

**Related commands** [edit \(filename\)](#)  
[show file](#)

# edit (filename)

**Overview** This command opens a remote text file as read-only in the AlliedWare Plus™ text editor.

Before starting the editor make sure your terminal, terminal emulation program, or Telnet client is 100% compatible with a VT100 terminal. The editor uses VT100 control sequences to display text on the terminal.

**Syntax** `edit <filename>`

Parameter	Description
<code>&lt;filename&gt;</code>	The filename and path of the remote file. See <a href="#">Introduction</a> on page 80 for valid syntax.

**Mode** Privileged Exec

**Example** To view the file `bob.key` stored in the security directory of a TFTP server, use the command:

```
awplus# edit tftp://security/bob.key
```

**Related commands**

- [copy \(filename\)](#)
- [edit](#)
- [show file](#)



# erase factory-default

**Overview** This command erases all data from Flash **except** the following:

- the boot release file (a .rel file) and its release setting file
- all license files
- the latest GUI release file

The device is then rebooted and returned to its factory default condition. The device can then be used for AMF automatic node recovery.

**Syntax** `erase factory-default`

**Mode** Privileged Exec.

**Usage notes** This command is an alias to the [atmf cleanup](#) command.

**Example** To erase data, use the command:

```
Node_1# erase factory-default
```

```
This command will erase all NVS, all flash contents except for  
the boot release, a GUI resource file, and any license files,  
and then reboot the switch. Continue? (y/n):y
```

**Related commands** [atmf cleanup](#)

# erase startup-config

**Overview** This command deletes the file that is set as the startup-config file, which is the configuration file that the system runs when it boots up.

At the next restart, the device loads the default configuration file, default.cfg. If default.cfg no longer exists, then the device loads with the factory default configuration. This provides a mechanism for you to return the device to the factory default settings.

**Syntax** `erase startup-config`

**Mode** Privileged Exec

**Example** To delete the file currently set as the startup-config, use the command:

```
awplus# erase startup-config
```

**Related commands**

- [boot config-file backup](#)
- [copy running-config](#)
- [copy startup-config](#)
- [show boot](#)

# ip tftp source-interface

**Overview** Use this command to manually specify the IP address that all TFTP requests originate from. This is useful in network configurations where TFTP servers only accept requests from certain devices, or where the server cannot dynamically determine the source of the request.

Use the **no** variant of this command to stop specifying a source.

**Syntax** `ip tftp source-interface [<interface>|<ip-add>]`  
`no ip tftp source-interface`

Parameter	Description
<interface>	The VLAN that TFTP requests originate from. The device will use the IP address of this interface as its source IP address.
<ip-add>	The IP address that TFTP requests originate from, in dotted decimal format

**Default** There is no default source specified.

**Mode** Global Configuration

**Usage** This command is helpful in network configurations where TFTP traffic needs to traverse point-to-point links or subnets within your network, and you do not want to propagate those point-to-point links through your routing tables.

In those circumstances, the TFTP server cannot dynamically determine the source of the TFTP request, and therefore cannot send the requested data to the correct device. Specifying a source interface or address enables the TFTP server to send the data correctly.

**Example** To specify that TFTP requests originate from the IP address 192.0.2.1, use the following commands:

```
awplus# configure terminal
awplus(config)# ip tftp source-interface 192.0.2.1
```

**Related commands** [copy \(filename\)](#)

# ipv6 tftp source-interface

**Overview** Use this command to manually specify the IPv6 address that all TFTP requests originate from. This is useful in network configurations where TFTP servers only accept requests from certain devices, or where the server cannot dynamically determine the source of the request.

Use the **no** variant of this command to stop specifying a source.

**Syntax** `ipv6 tftp source-interface [<interface>|<ipv6-add>]`  
`no ipv6 tftp source-interface`

Parameter	Description
<interface>	The VLAN that TFTP requests originate from. The device will use the IPv6 address of this interface as its source IPv6 address.
<ipv6-add>	The IPv6 address that TFTP requests originate from, in the format x:x::x, for example, 2001:db8::8a2e:7334.

**Default** There is no default source specified.

**Mode** Global Configuration

**Usage** This command is helpful in network configurations where TFTP traffic needs to traverse point-to-point links or subnets within your network, and you do not want to propagate those point-to-point links through your routing tables.

In those circumstances, the TFTP server cannot dynamically determine the source of the TFTP request, and therefore cannot send the requested data to the correct device. Specifying a source interface or address enables the TFTP server to send the data correctly.

**Example** To specify that TFTP requests originate from the IPv6 address 2001:db8::8a2e:7334, use the following commands:

```
awplus# configure terminal  
awplus(config)# ipv6 tftp source-interface 2001:db8::8a2e:7334
```

**Related commands** [copy \(filename\)](#)

# mkdir

**Overview** This command makes a new directory.

**Syntax** `mkdir <name>`

Parameter	Description
<code>&lt;name&gt;</code>	The name and path of the directory that you are creating.

**Mode** Privileged Exec

**Usage** You cannot name a directory or subdirectory **flash**, **nvs**, **usb**, **card**, **tftp**, **scp**, **sftp** or **http**. These keywords are reserved for tab completion when using various file commands.

**Example** To make a new directory called `images` in the current directory, use the command:

```
awplus# mkdir images
```

**Related commands** `cd`  
`dir`  
`pwd`

# move

**Overview** This command renames or moves a file.

**Syntax** `move <source-name> <destination-name>`

Parameter	Description
<code>&lt;source-name&gt;</code>	The filename and path of the source file. See <a href="#">Introduction</a> on page 80 for valid syntax.
<code>&lt;destination-name&gt;</code>	The filename and path of the destination file. See <a href="#">Introduction</a> on page 80 for valid syntax.

**Mode** Privileged Exec

**Examples** To rename the file `temp.cfg` to `startup.cfg`, use the command:

```
awplus# move temp.cfg startup.cfg
```

To move the file `temp.cfg` from the root of the Flash filesystem to the directory `myconfigs`, use the command:

```
awplus# move temp.cfg myconfigs/temp.cfg
```

**Related commands** [delete](#)  
[edit](#)

[show file](#)

[show file systems](#)

# move debug

**Overview** This command moves a specified debug file to a destination debug file.

**Syntax** `move debug {<destination-name>|card|debug|flash}`

Parameter	Description
<code>&lt;destination-name&gt;</code>	The filename and path where you would like the debug output moved to. See <a href="#">Introduction</a> on page 80 for valid syntax.

**Mode** Privileged Exec

**Example** To move debug output into Flash memory with a filename “my-debug”, use the following command:

```
awplus# move debug flash:my-debug
```

To move debug output onto an SD (or SDHC) card with a filename “my-debug”, use the following command:

```
awplus# move debug card:my-debug
```

**Output** Figure 2-5: CLI prompt after entering the **move debug** command

```
Enter source file name []:
```

**Related commands** [copy debug](#)  
[delete debug](#)

# pwd

**Overview** This command prints the current working directory.

**Syntax** `pwd`

**Mode** Privileged Exec

**Example** To print the current working directory, use the command:

```
awplus# pwd
```

**Related  
commands** `cd`



# rmdir

**Overview** This command removes a directory. This command only works on empty directories, unless you specify the optional **force** keyword.

**Syntax** `rmdir [force] <name>`

Parameter	Description
<code>force</code>	Optional keyword that allows you to delete directories that are not empty and contain files or subdirectories.
<code>&lt;name&gt;</code>	The name and path of the directory.

**Mode** Privileged Exec

**Examples** To remove the directory “images” from the top level of the Flash filesystem, use the command:

```
awplus# rmdir flash:/images
```

To create a directory called “level1” containing a subdirectory called “level2”, and then force the removal of both directories, use the commands:

```
awplus# mkdir level1  
awplus# mkdir level1/level2  
awplus# rmdir force level1
```

**Related commands**

- [cd](#)
- [dir](#)
- [mkdir](#)
- [pwd](#)

# show autoboot

**Overview** This command displays the Autoboot configuration and status.

**Syntax** show autoboot

**Mode** Privileged Exec

**Example** To show the Autoboot configuration and status, use the command:

```
awplus# show autoboot
```

**Output** Figure 2-6: Example output from the **show autoboot** command

```
awplus#show autoboot
Autoboot configuration
-----
Autoboot status                : enabled
SD Card file autoboot.txt exists : yes

Restore information on SD card
Autoboot enable in autoboot.txt : yes
Restore release file           : GS970-5.5.0-0.1.rel (file exists)
Restore configuration file      : network_1.cfg (file exists)
```

Figure 2-7: Example output from the **show autoboot** command when an external media source is not present

```
awplus#show autoboot
Autoboot configuration
-----
Autoboot status                : enabled
External media source          : SD card not found.
```

**Related commands**

- [autoboot enable](#)
- [create autoboot](#)
- [show boot](#)

# show boot

**Overview** This command displays the current boot configuration. We recommend that the currently running release is set as the current boot image.

**Syntax** show boot

**Mode** Privileged Exec

**Example** To show the current boot configuration, use the command:

```
awplus# show boot
```

**Output** Figure 2-8: Example output from **show boot** when the current boot config is on an SD card

```
awplus#show boot
Boot configuration
-----
Current software   : GS970-5.5.0-0.1.rel
Current boot image : card:/GS970-5.5.0-0.1.rel
Backup boot image  : flash:/GS970-5.4.9-2.1.rel
Default boot config: flash:/default.cfg
Current boot config: card:/my.cfg (file exists)
Backup boot config: flash:/backup.cfg (file not found)
Autoboot status    : enabled
```

Table 2-1: Parameters in the output from **show boot**

Parameter	Description
Current software	The current software release that the device is using.
Current boot image	The boot image currently configured for use during the next boot cycle.
Backup boot image	The boot image to use during the next boot cycle if the device cannot load the main image.
Default boot config	The default startup configuration file. The device loads this configuration script if no file is set as the startup-config file.
Current boot config	The configuration file currently configured as the startup-config file. The device loads this configuration file during the next boot cycle if this file exists.

Table 2-1: Parameters in the output from **show boot** (cont.)

Parameter	Description
Backup boot config	The configuration file to use during the next boot cycle if the main configuration file cannot be loaded.
Autoboot status	The status of the Autoboot feature; either enabled or disabled.

**Related  
commands**

[autoboot enable](#)  
[boot config-file backup](#)  
[boot system backup](#)  
[show autoboot](#)

# show file

**Overview** This command displays the contents of a specified file.

**Syntax** `show file <filename>`

Parameter	Description
<code>&lt;filename&gt;</code>	Name of a file on the local Flash filesystem, or name and directory path of a file.

**Mode** Privileged Exec

**Example** To display the contents of the file `oldconfig.cfg`, which is in the current directory, use the command:

```
awplus# show file oldconfig.cfg
```

**Related commands**

- [edit](#)
- [edit \(filename\)](#)
- [show file systems](#)

# show file systems

**Overview** This command lists the filesystems and their utilization information where appropriate.

**Syntax** show file systems

**Mode** Privileged Exec

**Examples** To display the filesystems, use the command:

```
awplus# show file systems
```

**Output** Figure 2-9: Example output from the **show file systems** command

```
awplus#show file systems
```

Size(b)	Free(b)	Type	Flags	Prefixes	S/D/V	Lcl/Ntwk	Avail
61.9M	41.5M	flash	rw	flash:	static	local	Y
-	-	system	rw	system:	virtual	local	-
10.0M	9.9M	debug	rw	debug:	static	local	Y
-	-	fserver	rw	fserver:	dynamic	network	N
-	-	tftp	rw	tftp:	-	network	-
-	-	scp	rw	scp:	-	network	-
-	-	sftp	ro	sftp:	-	network	-
-	-	http	ro	http:	-	network	-
-	-	rsync	rw	rsync:	-	network	-

**Table 3:** Parameters in the output of the **show file systems** command

Parameter	Description
Size (B)	The total memory available to this filesystem. The units are given after the value and are M for Megabytes or k for kilobytes.
Free (B)	The total memory free within this filesystem. The units are given after the value and are M for Megabytes or k for kilobytes.
Type	The memory type used for this filesystem, such as: flash system sdcard tftp scp sftp http.
Flags	The file setting options: rw (read write), ro (read only).

**Table 3:** Parameters in the output of the **show file systems** command (cont.)

Parameter	Description
Prefixes	The prefixes used when entering commands to access the filesystems, such as: flash system card tftp scp sftp http.
S/V/D	The memory type: static, virtual, dynamic.
Lcl / Ntwk	Whether the memory is located locally or via a network connection.
Avail	Whether the memory is accessible: Y (yes), N (no), - (not applicable)

**Related commands**

- [edit](#)
- [edit \(filename\)](#)
- [show file](#)

# show running-config

**Overview** This command displays the current configuration of your device. Its output includes all non-default configuration. The default settings are not displayed.

**NOTE:** You can control the output by entering `|` or `>` at the end of the command:

- To display only lines that contain a particular word, enter:  
`| include <word>`
- To start the display at the first line that contains a particular word, enter:  
`| begin <word>`
- To save the output to a file, enter:  
`> <filename>`

**Syntax** `show running-config [full|<feature>]`

Parameter	Description
full	Display the running-config for all features. This is the default setting, so it is the same as entering <b>show running-config</b> .
<feature>	Display only the configuration for a single feature. The features available depend on your device and will be some of the following list:
access-list	ACL configuration
antivirus	Antivirus configuration
application	Application configuration
as-path	Autonomous system path filter configuration
as-path access-list	Configuration of ACLs for AS path filtering
atmf	Allied Telesis Management Framework configuration
bgp	Border Gateway Protocol (BGP) configuration
community-list	Community-list configuration
crypto	Security-specific configuration
dhcp	DHCP configuration
dpi	Deep Packet Inspection configuration
entity	Entity configuration
firewall	Firewall configuration
interface	Interface configuration. See <a href="#">show running-config interface</a> for further options.



Parameter	Description
ip	Internet Protocol (IP) configuration
ip pim dense-mode	PIM-DM configuration
ip pim sparse-mode	PIM-SM configuration
ip route	IP static route configuration
ip-reputation	IP Reputation configuration
ips	IPS configuration
ipsec	Internet Protocol Security (IPsec) configuration
ipv6	Internet Protocol version 6 (IPv6) configuration
ipv6 access-list	IPv6 ACL configuration
ipv6 mroute	IPv6 multicast route configuration
ipv6 prefix-list	IPv6 prefix list configuration
ipv6 route	IPv6 static route configuration
isakmp	Internet Security Association Key Management Protocol (ISAKMP) configuration
key chain	Authentication key management configuration
l2tp-profile	L2TP tunnel profile configuration
lldp	LLDP configuration
log	Logging utility configuration
malware-protection	Malware protection configuration
nat	Network Address Translation configuration
power-inline	Power over Ethernet (PoE) configuration
policy-based-routing	Policy-based routing (PBR) configuration
pppoe-ac	PPPoE access concentrator configuration
prefix-list	Prefix-list configuration
route-map	Route-map configuration
router	Router configuration
router-id	Configuration of the router identifier for this system
security-password	Strong password security configuration
snmp	SNMP configuration
ssh	Secure Shell configuration

Parameter	Description
switch	Switch configuration
web-control	Web Control configuration

**Mode** Privileged Exec and Global Configuration

**Example** To display the current configuration of your device, use the command:

```
awplus# show running-config
```

**Output** Figure 2-10: Example output from **show running-config**

```
awplus#show running-config
!
service password-encryption
!
no banner motd
!
username manager privilege 15 password 8 $1$bJoVec4D$JwOJGPr7YqoExA0GVasdE0
!
no service ssh
!
service telnet
!
service http
!
no clock timezone
...
line con 0
line vty 0 4
!
end
```

**Related commands** [copy running-config](#)  
[show running-config interface](#)

# show running-config interface

**Overview** This command displays the current configuration of one or more interfaces on the device.

You can optionally limit the command output to display only information for a given protocol or feature. The features available depend on your device and will be a subset of the features listed in the table below.

**Syntax** `show running-config interface [<interface-list>] [dot1x|ip igmp|ip multicast|ip pim dense-mode|ip pim sparse-mode|ipv6 rip|lacp|mstp|ospf|rip|rstp|stp]`

Parameter	Description
<interface-list>	The interfaces or ports to display information about. An interface-list can be: <ul style="list-style-type: none"><li>• a VLAN (e.g. vlan2)</li><li>• a switchport (e.g. port1.0.4)</li><li>• a static channel group (e.g. sa2)</li><li>• a dynamic (LACP) channel group (e.g. po2)</li><li>• the loopback interface (lo)</li><li>• a continuous range of interfaces separated by a hyphen (e.g. vlan10-20)</li><li>• a comma-separated list (e.g. vlan1,vlan10-20). Do not mix interface types in a list.</li></ul> The specified interfaces must exist.
dot1x	Displays running configuration for 802.1X port authentication for the specified interfaces.
lacp	Displays running configuration for LACP (Link Aggregation Control Protocol) for the specified interfaces.
ip igmp	Displays running configuration for IGMP (Internet Group Management Protocol) for the specified interfaces.
ip multicast	Displays running configuration for general multicast settings for the specified interfaces.
ip pim sparse-mode	Displays running configuration for PIM-SM (Protocol Independent Multicast - Sparse Mode) for the specified interfaces.
ip pim dense-mode	Displays running configuration for PIM-DM (Protocol Independent Multicasting - Dense Mode) for the specified interfaces.
mstp	Displays running configuration for MSTP (Multiple Spanning Tree Protocol) for the specified interfaces.
ospf	Displays running configuration for OSPF (Open Shortest Path First) for the specified interfaces.

Parameter	Description
rip	Displays running configuration for RIP (Routing Information Protocol) for the specified interfaces.
ipv6 rip	Displays running configuration for RIPng (RIP for IPv6) for the specified interfaces.
rstp	Displays running configuration for RSTP (Rapid Spanning Tree Protocol) for the specified interfaces.
stp	Displays running configuration for STP (Spanning Tree Protocol) for the specified interfaces.

**Mode** Privileged Exec and Global Configuration

**Default** Displays information for all protocols on all interfaces

**Examples** To display the current running configuration of your device for ports 1 to 4, use the command:

```
awplus# show running-config interface port1.0.1-port1.0.4
```

To display the current running configuration of a device for vlan2, use the command:

```
awplus# show running-config interface vlan2
```

**Output** Figure 2-11: Example output from **show running-config interface** for a switchport

```
awplus#show running-config interface port1.0.2
!
interface port1.0.2
 switchport
 switchport mode access
!
```

**Related commands** [copy running-config](#)  
[show running-config](#)

# show startup-config

**Overview** This command displays the contents of the start-up configuration file, which is the file that the device runs on start-up.

For information on filtering and saving command output, see the [“Getting Started with AlliedWare Plus” Feature Overview and Configuration Guide](#).

**Syntax** `show startup-config`

**Mode** Privileged Exec

**Example** To display the contents of the current start-up configuration file, use the command:

```
awplus# show startup-config
```

**Output** Figure 2-12: Example output from the **show startup-config** command

```
awplus#show startup-config
!
service password-encryption
!
no banner motd
!
username manager privilege 15 password 8 $1$bJoVec4D$JwOJGPr7YqoExA0GVasdE0
!
no service ssh
!
service telnet
!
service http
!
no clock timezone

...

line con 0
line vty 0 4
!
end
```

**Related commands**

- [boot config-file backup](#)
- [copy running-config](#)
- [copy startup-config](#)
- [erase startup-config](#)
- [show boot](#)

# show version

**Overview** This command displays the version number and copyright details of the current AlliedWare Plus™ OS your device is running.

**Syntax** `show version`

**Mode** User Exec and Privileged Exec

**Example** To display the version details of your currently installed software, use the command:

```
awplus# show version
```

**Related commands** [boot system backup](#)  
[show boot](#)

# unmount

**Overview** Use this command to unmount an external storage device. We recommend you unmount storage devices before removing them, to avoid file corruption. This is especially important if files may be automatically written to the storage device, such as external log files or AMF backup files.

**Syntax** `unmount card`

Parameter	Description
card	Unmount the SD card.

**Mode** Privileged Exec

**Example** To unmount an SD card and safely remove it from the device, use the command:

```
awplus# unmount card
```

**Related commands**

- [clear log external](#)
- [log external](#)
- [show file systems](#)
- [show log config](#)
- [show log external](#)

**Command changes** Version 5.4.7-1.1: command added

# write file

**Overview** This command copies the running-config into the file that is set as the current startup-config file. This command is a synonym of the **write memory** and **copy running-config startup-config** commands.

**Syntax** write [file]

**Mode** Privileged Exec

**Example** To write configuration data to the start-up configuration file, use the command:

```
awplus# write file
```

**Related commands**

- [copy running-config](#)
- [write memory](#)
- [show running-config](#)



# write memory

**Overview** This command copies the running-config into the file that is set as the current startup-config file. This command is a synonym of the **write file** and **copy running-config startup-config** commands.

**Syntax** write [memory]

**Mode** Privileged Exec

**Example** To write configuration data to the start-up configuration file, use the command:

```
awplus# write memory
```

**Related commands**

- [copy running-config](#)
- [write file](#)
- [show running-config](#)

# write terminal

**Overview** This command displays the current configuration of the device. This command is a synonym of the [show running-config](#) command.

**Syntax** `write terminal`

**Mode** Privileged Exec

**Example** To display the current configuration of your device, use the command:

```
awplus# write terminal
```

**Related commands** [show running-config](#)

# 3

# User Access Commands

## Introduction

**Overview** This chapter provides an alphabetical reference of commands used to configure user access.

- Command List**
- [“aaa authentication enable default local”](#) on page 133
  - [“aaa local authentication attempts lockout-time”](#) on page 134
  - [“aaa local authentication attempts max-fail”](#) on page 135
  - [“aaa login fail-delay”](#) on page 136
  - [“clear aaa local user lockout”](#) on page 137
  - [“clear line console”](#) on page 138
  - [“clear line vty”](#) on page 139
  - [“enable password”](#) on page 140
  - [“enable secret”](#) on page 143
  - [“exec-timeout”](#) on page 146
  - [“flowcontrol hardware \(asyn/console\)”](#) on page 148
  - [“length \(asyn\)”](#) on page 150
  - [“line”](#) on page 151
  - [“privilege level”](#) on page 153
  - [“security-password history”](#) on page 154
  - [“security-password forced-change”](#) on page 155
  - [“security-password lifetime”](#) on page 156
  - [“security-password min-lifetime-enforce”](#) on page 157
  - [“security-password minimum-categories”](#) on page 158
  - [“security-password minimum-length”](#) on page 159

- ["security-password reject-expired-pwd"](#) on page 160
- ["security-password warning"](#) on page 161
- ["service advanced-vty"](#) on page 162
- ["service password-encryption"](#) on page 163
- ["service telnet"](#) on page 164
- ["service terminal-length \(deleted\)"](#) on page 165
- ["show aaa local user locked"](#) on page 166
- ["show privilege"](#) on page 167
- ["show security-password configuration"](#) on page 168
- ["show security-password user"](#) on page 169
- ["show telnet"](#) on page 170
- ["show users"](#) on page 171
- ["telnet"](#) on page 172
- ["telnet server"](#) on page 173
- ["terminal length"](#) on page 174
- ["terminal resize"](#) on page 175
- ["username"](#) on page 176

# aaa authentication enable default local

**Overview** This command enables local privilege level authentication.  
Use the **no** variant of this command to disable local privilege level authentication.

**Syntax** `aaa authentication enable default local`  
`no aaa authentication enable default`

**Default** Local privilege level authentication is enabled by default.

**Mode** Global Configuration

**Usage notes** The privilege level configured for a particular user in the local user database is the privilege threshold above which the user is prompted for an [enable \(Privileged Exec mode\)](#) command.

**Examples** To enable local privilege level authentication, use the following commands:

```
awplus# configure terminal
awplus(config)# aaa authentication enable default local
```

To disable local privilege level authentication, use the following commands:

```
awplus# configure terminal
awplus(config)# no aaa authentication enable default
```

**Related commands** [aaa authentication login](#)  
[enable \(Privileged Exec mode\)](#)  
[enable password](#)  
[enable secret](#)

# aaa local authentication attempts lockout-time

**Overview** This command configures the duration of the user lockout period.

Use the **no** variant of this command to restore the duration of the user lockout period to its default of 300 seconds (5 minutes).

**Syntax** `aaa local authentication attempts lockout-time <lockout-time>`  
`no aaa local authentication attempts lockout-time`

Parameter	Description
<code>&lt;lockout-time&gt;</code>	<code>&lt;0-10000&gt;</code> . Time in seconds to lockout the user.

**Mode** Global Configuration

**Default** The default for the lockout-time is 300 seconds (5 minutes).

**Usage notes** While locked out all attempts to login with the locked account will fail. The lockout can be manually cleared by another privileged account using the [clear aaa local user lockout](#) command.

**Examples** To configure the lockout period to 10 minutes (600 seconds), use the commands:

```
awplus# configure terminal
awplus(config)# aaa local authentication attempts lockout-time
600
```

To restore the default lockout period of 5 minutes (300 seconds), use the commands:

```
awplus# configure terminal
awplus(config)# no aaa local authentication attempts
lockout-time
```

**Related commands** [aaa local authentication attempts max-fail](#)

# aaa local authentication attempts max-fail

**Overview** This command configures the maximum number of failed login attempts before a user account is locked out. Every time a login attempt fails the failed login counter is incremented.

Use the **no** variant of this command to restore the maximum number of failed login attempts to the default setting (five failed login attempts).

**Syntax** `aaa local authentication attempts max-fail <failed-logins>`  
`no aaa local authentication attempts max-fail`

Parameter	Description
<code>&lt;failed-logins&gt;</code>	<code>&lt;1-32&gt;</code> . Number of login failures allowed before locking out a user.

**Mode** Global Configuration

**Default** The default for the maximum number of failed login attempts is five failed login attempts.

**Usage** When the failed login counter reaches the limit configured by this command that user account is locked out for a specified duration configured by the [aaa local authentication attempts lockout-time](#) command.

When a successful login occurs the failed login counter is reset to 0. When a user account is locked out all attempts to login using that user account will fail.

**Examples** To configure the number of login failures that will lock out a user account to two login attempts, use the commands:

```
awplus# configure terminal
awplus(config)# aaa local authentication attempts max-fail 2
```

To restore the number of login failures that will lock out a user account to the default number of login attempts (five login attempts), use the commands:

```
awplus# configure terminal
awplus(config)# no aaa local authentication attempts max-fail
```

**Related commands** [aaa local authentication attempts lockout-time](#)  
[clear aaa local user lockout](#)

# aaa login fail-delay

**Overview** Use this command to configure the minimum time period between failed login attempts. This setting applies to login attempts via the console, SSH and Telnet. Use the **no** variant of this command to reset the minimum time period to its default value.

**Syntax** `aaa login fail-delay <1-10>`  
`no aaa login fail-delay`

Parameter	Description
<1-10>	The minimum number of seconds required between login attempts

**Default** 1 second

**Mode** Global configuration

**Example** To apply a delay of at least 5 seconds between login attempts, use the following commands:

```
awplus# configure terminal
awplus(config)# aaa login fail-delay 5
```

**Related commands** [aaa authentication login](#)  
[aaa local authentication attempts lockout-time](#)  
[clear aaa local user lockout](#)



# clear aaa local user lockout

**Overview** Use this command to clear the lockout on a specific user account or all user accounts.

**Syntax** `clear aaa local user lockout {username <username>|all}`

Parameter	Description
username	Clear lockout for the specified user.
<username>	Specifies the user account.
all	Clear lockout for all user accounts.

**Mode** Privileged Exec

**Examples** To unlock the user account 'bob' use the following command:

```
awplus# clear aaa local user lockout username bob
```

To unlock all user accounts use the following command:

```
awplus# clear aaa local user lockout all
```

**Related commands** [aaa local authentication attempts lockout-time](#)

# clear line console

**Overview** This command resets a console line. If a terminal session exists on the line then the terminal session is terminated. If console line settings have changed then the new settings are applied.

**Syntax** `clear line console 0`

**Mode** Privileged Exec

**Example** To reset the console line (asyn), use the command:

```
awplus# clear line console 0
```

```
awplus# % The new settings for console line 0 have been applied
```

**Related commands**

- [clear line vty](#)
- [flowcontrol hardware \(asyn/console\)](#)
- [line](#)
- [show users](#)

# clear line vty

**Overview** This command resets a VTY line. If a session exists on the line then it is closed.

**Syntax** `clear line vty <0-32>`

Parameter	Description
<0-32>	Line number

**Mode** Privileged Exec

**Example** To reset the first VTY line, use the command:

```
awplus# clear line vty 1
```

**Related commands**

- [privilege level](#)
- [line](#)
- [show telnet](#)
- [show users](#)

# enable password

**Overview** To set a local password to control access to various privilege levels, use the `enable password` Global Configuration command. Use the `enable password` command to modify or create a password to be used, and use the `no enable password` command to remove the password.

Note that the `enable secret` command is an alias for the `enable password` command, and the `no enable secret` command is an alias for the `no enable password` command. Issuing a `no enable password` command removes a password configured with the `enable secret` command. The `enable password` command is shown in the running and startup configurations. Note that if the `enable secret` command is entered then `enable password` is shown in the configuration.

**Syntax** `enable password [<plain>|8 <hidden>|level <1-15> 8 <hidden>]`  
`no enable password [level <1-15>]`

Parameter	Description
<code>&lt;plain&gt;</code>	Specifies the unencrypted password.
8	Specifies a hidden password will follow.
<code>&lt;hidden&gt;</code>	Specifies the hidden encrypted password. Use an encrypted password for better security where a password crosses the network or is stored on a TFTP server.
level	Privilege level <1-15>. Level for which the password applies. You can specify up to 16 privilege levels, using numbers 1 through 15. Level 1 is normal EXEC-mode user privileges for User Exec mode. If this argument is not specified in the command or the <b>no</b> variant of the command, the privilege level defaults to 15 (enable mode privileges) for Privileged Exec mode. A privilege level of 7 can be set for intermediate CLI security.

**Default** The privilege level for enable password is level 15 by default. Previously the default was level 1.

**Mode** Global Configuration

**Usage notes** This command enables the Network Administrator to set a password for entering the Privileged Exec mode when using the `enable (Privileged Exec mode)` command. There are three methods to enable a password. In the examples below, for each method, note that the configuration is different and the configuration file output is different, but the password string to be used to enter the Privileged Exec mode with the **enable** command is the same (**mypasswd**).

A user can now have an intermediate CLI security level set with this command for privilege level 7 to access all the show commands in Privileged Exec mode and all the commands in User Exec mode, but not any configuration commands in Privileged Exec mode.

Note that the `enable password` command is an alias for the `enable secret` command and one password per privilege level is allowed using these commands. Do not assign one password to a privilege level with `enable password` and another password to a privilege level with `enable secret`. Use `enable password` or `enable secret` commands. Do not use both on the same level.

### Using plain passwords

The plain password is a clear text string that appears in the configuration file as configured.

```
awplus# configure terminal
awplus(config)# enable password mypasswd
awplus(config)# end
```

This results in the following show output:

```
awplus#show run
Current configuration:
hostname awplus
enable password mypasswd
!
interface lo
```

### Using encrypted passwords

You can configure an encrypted password using the `service password-encryption` command. First, use the `enable password` command to specify the string that you want to use as a password (**myspasswd**). Then, use the `service password-encryption` command to encrypt the specified string (**myspasswd**). The advantage of using an encrypted password is that the configuration file does not show **myspasswd**, it will only show the encrypted string **fU7zHzuutY2SA**.

```
awplus# configure terminal
awplus(config)# enable password mypasswd
awplus(config)# service password-encryption
awplus(config)# end
```

This results in the following show output:

```
awplus#show run
Current configuration:
hostname awplus
enable password 8 fU7zHzuutY2SA
service password-encryption
!
interface lo
```

### Using hidden passwords

You can configure an encrypted password using the **HIDDEN** parameter (**8**) with the `enable password` command. Use this method if you already know the encrypted string corresponding to the plain text string that you want to use as a password. It is not required to use the `service password-encryption` command for

this method. The output in the configuration file will show only the encrypted string, and not the text string.

```
awplus# configure terminal
awplus(config)# enable password 8 fU7zHzuutY2SA
awplus(config)# end
```

This results in the following show output:

```
awplus#show run
Current configuration:
hostname awplus
enable password 8 fU7zHzuutY2SA
!
interface lo
```

**Related  
commands**

[enable \(Privileged Exec mode\)](#)  
[enable secret](#)  
[service password-encryption](#)  
[privilege level](#)  
[show privilege](#)  
[username](#)  
[show running-config](#)

# enable secret

**Overview** To set a local password to control access to various privilege levels, use the **enable secret** Global Configuration command. Use the **enable secret** command to modify or create a password to be used, and use the **no enable secret** command to remove the password.

Note that the **enable secret** command is an alias for the **enable password** command, and the **no enable secret** command is an alias for the **no enable password** command. Issuing a **no enable password** command removes a password configured with the **enable secret** command. The **enable password** command is shown in the running and startup configurations. Note that if the **enable secret** command is entered then **enable password** is shown in the configuration

**Syntax** `enable secret [<plain>|8 <hidden>|level <0-15> 8 <hidden>]`  
`no enable secret [level <1-15>]`

Parameter	Description
<plain>	Specifies the unencrypted password.
8	Specifies a hidden password will follow.
<hidden>	Specifies the hidden encrypted password. Use an encrypted password for better security where a password crosses the network or is stored on a TFTP server.
level	Privilege level <1-15>. Level for which the password applies. You can specify up to 16 privilege levels, using numbers 1 through 15. Level 1 is normal EXEC-mode user privileges for User Exec mode. If this argument is not specified in the command or the <b>no</b> variant of the command, the privilege level defaults to 15 (enable mode privileges) for Privileged Exec mode. A privilege level of 7 can be set for intermediate CLI security.

**Default** The privilege level for enable secret is level 15 by default.

**Mode** Global Configuration

**Usage notes** This command enables the Network Administrator to set a password for entering the Privileged Exec mode when using the **enable (Privileged Exec mode)** command. There are three methods to enable a password. In the examples below, for each method, note that the configuration is different and the configuration file output is different, but the password string to be used to enter the Privileged Exec mode with the **enable** command is the same (**mypasswd**).

A user can have an intermediate CLI security level set with this command for privilege level 7 to access all the show commands in Privileged Exec mode and all the commands in User Exec mode, but not any configuration commands in Privileged Exec mode.

Note that the `enable secret` command is an alias for the `enable password` command and one password per privilege level is allowed using these commands. Do not assign one password to a privilege level with `enable password` and another password to a privilege level with `enable secret`. Use `enable password` or `enable secret` commands. Do not use both on the same level.

### Using plain passwords

The plain password is a clear text string that appears in the configuration file as configured.

```
awplus# configure terminal
awplus(config)# enable secret mypasswd
awplus(config)# end
```

This results in the following show output:

```
awplus#show run
Current configuration:
hostname awplus
enable password mypasswd
!
interface lo
```

### Using encrypted passwords

Configure an encrypted password using the `service password-encryption` command. First, use the `enable password` command to specify the string that you want to use as a password (**mypasswd**). Then, use the `service password-encryption` command to encrypt the specified string (**mypasswd**). The advantage of using an encrypted password is that the configuration file does not show **mypasswd**, it will only show the encrypted string **fU7zHzuutY2SA**.

```
awplus# configure terminal
awplus(config)# enable secret mypasswd
awplus(config)# service password-encryption
awplus(config)# end
```

This results in the following show output:

```
awplus#show run
Current configuration:
hostname awplus
enable password 8 fU7zHzuutY2SA
service password-encryption
!
interface lo
```

### Using hidden passwords

Configure an encrypted password using the **HIDDEN** parameter (**8**) with the `enable password` command. Use this method if you already know the encrypted string corresponding to the plain text string that you want to use as a password. It is not required to use the `service password-encryption` command for this method.



The output in the configuration file will show only the encrypted string, and not the text string:

```
awplus# configure terminal
awplus(config)# enable secret 8 fU7zHzuutY2SA
awplus(config)# end
```

This results in the following show output:

```
awplus#show run
Current configuration:
hostname awplus
enable password 8 fU7zHzuutY2SA
!
interface lo
```

**Related  
commands**

[enable \(Privileged Exec mode\)](#)  
[enable secret](#)  
[service password-encryption](#)  
[privilege level](#)  
[show privilege](#)  
[username](#)  
[show running-config](#)

# exec-timeout

**Overview** This command sets the interval your device waits for user input from either a console or VTY connection. Once the timeout interval is reached, the connection is dropped. This command sets the time limit when the console or VTY connection automatically logs off after no activity.

The **no** variant of this command removes a specified timeout and resets to the default timeout (10 minutes).

**Syntax** `exec-timeout {<minutes>} [<seconds>]`  
`no exec-timeout`

Parameter	Description
<minutes>	<0-35791> Required integer timeout value in minutes
<seconds>	<0-2147483> Optional integer timeout value in seconds

**Default** The default for the **exec-timeout** command is 10 minutes and 0 seconds (**exec-timeout 10 0**).

**Mode** Line Configuration

**Usage notes** This command is used set the time the telnet session waits for an idle VTY session, before it times out. An **exec-timeout 0 0** setting will cause the telnet session to wait indefinitely. The command **exec-timeout 0 0** is useful while configuring a device, but reduces device security.

If no input is detected during the interval then the current connection resumes. If no connections exist then the terminal returns to an idle state and disconnects incoming sessions.

**Examples** To set VTY connections to timeout after 2 minutes, 30 seconds if there is no response from the user, use the following commands:

```
awplus# configure terminal
awplus(config)# line vty 0 32
awplus(config-line)# exec-timeout 2 30
```

To reset the console connection to the default timeout of 10 minutes 0 seconds if there is no response from the user, use the following commands:

```
awplus# configure terminal
awplus(config)# line console 0
awplus(config-line)# no exec-timeout
```

**Validation Commands** `show running-config`

**Related  
commands** [line](#)  
[service telnet](#)

# flowcontrol hardware (asyn/console)

**Overview** Use this command to enable RTS/CTS (Ready To Send/Clear To Send) hardware flow control on a terminal console line (asyn port) between the DTE (Data Terminal Equipment) and the DCE (Data Communications Equipment).

**Syntax** `flowcontrol hardware`  
`no flowcontrol hardware`

**Mode** Line Configuration

**Default** Hardware flow control is disabled by default.

**Usage notes** Hardware flow control makes use of the RTS and CTS control signals between the DTE and DCE where the rate of transmitted data is faster than the rate of received data. Flow control is a technique for ensuring that a transmitting entity does not overwhelm a receiving entity with data. When the buffers on the receiving device are full, a message is sent to the sending device to suspend the transmission until the data in the buffers has been processed.

Hardware flow control can be configured on terminal console lines (e.g. asyn0). For Reverse Telnet connections, hardware flow control must be configured to match on both the Access Server and the Remote Device. For terminal console sessions, hardware flow control must be configured to match on both the DTE and the DCE. Settings are saved in the running configuration. Changes are applied after reboot, clear line console, or after closing the session.

Use **show running-config** and **show startup-config** commands to view hardware flow control settings that take effect after reboot for a terminal console line. See the **show running-config** command output:

```
awplus#show running-config
!
line con 1
  speed 9600
  mode out 2001
  flowcontrol hardware
!
```

Note that line configuration commands do not take effect immediately. Line configuration commands take effect after one of the following commands or events:

- issuing a [clear line console](#) command
- issuing a [reboot](#) command
- logging out of the current session

**Examples** To enable hardware flow control on terminal console line asyn0, use the commands:

```
awplus# configure terminal
awplus(config)# line console 0
awplus(config-line)# flowcontrol hardware
```

To disable hardware flow control on terminal console line asyn0, use the commands:

```
awplus# configure terminal
awplus(config)# line console 0
awplus(config-line)# no flowcontrol hardware
```

**Related commands**

- [clear line console](#)
- [show running-config](#)
- [speed \(asyn\)](#)

# length (asyn)

**Overview** Use this command to specify the number of rows of output that the device will display before pausing, for the console or VTY line that you are configuring.

The **no** variant of this command restores the length of a line (terminal session) attached to a console port or to a VTY to its default length of 22 rows.

**Syntax** length <0-512>  
no length

Parameter	Description
<0-512>	Number of lines on screen. Specify 0 for no pausing.

**Mode** Line Configuration

**Default** The length of a terminal session is 22 rows. The **no length** command restores the default.

**Usage notes** If the output from a command is longer than the length of the line the output will be paused and the ‘-More-’ prompt allows you to move to the next screen full of data.

A length of 0 will turn off pausing and data will be displayed to the console as long as there is data to display.

**Examples** To set the terminal session length on the console to 10 rows, use the command:

```
awplus# configure terminal
awplus(config)# line console 0
awplus(config-line)# length 10
```

To reset the terminal session length on the console to the default (22 rows), use the command:

```
awplus# configure terminal
awplus(config)# line console 0
awplus(config-line)# no length
```

To display output to the console continuously, use the command:

```
awplus# configure terminal
awplus(config)# line console 0
awplus(config-line)# length 0
```

**Related commands** [terminal resize](#)  
[terminal length](#)

# line

**Overview** Use this command to enter line configuration mode for the specified VTYS or the console. The command prompt changes to show that the device is in Line Configuration mode.

**Syntax** `line vty <first-line> [<last-line>]`  
`line console 0`

Parameter	Description
<code>&lt;first-line&gt;</code>	<code>&lt;0-32&gt;</code> Specify the first line number.
<code>&lt;last-line&gt;</code>	<code>&lt;0-32&gt;</code> Specify the last line number.
<code>console</code>	The console terminal line(s) for local access.
<code>vty</code>	Virtual terminal for remote console access.

**Mode** Global Configuration

**Usage notes** This command puts you into Line Configuration mode. Once in Line Configuration mode, you can configure console and virtual terminal settings, including setting [speed \(asyn\)](#), [length \(asyn\)](#), [privilege level](#), and authentication ([login authentication](#)) or accounting ([accounting login](#)) method lists.

To change the console (asyn) port speed, use this **line** command to enter Line Configuration mode before using the [speed \(asyn\)](#) command. Set the console speed (Baud rate) to match the transmission rate of the device connected to the console (asyn) port on your device.

Note that line configuration commands do not take effect immediately. Line configuration commands take effect after one of the following commands or events:

- issuing a [clear line console](#) command
- issuing a [reboot](#) command
- logging out of the current session

**Examples** To enter Line Configuration mode in order to configure all VTYS, use the commands:

```
awplus# configure terminal
awplus(config)# line vty 0 32
awplus(config-line)#
```

To enter Line Configuration mode to configure the console (asyn 0) port terminal line, use the commands:

```
awplus# configure terminal
awplus(config)# line console 0
awplus(config-line)#
```

**Related  
commands**

- accounting login
- clear line console
- clear line vty
- flowcontrol hardware (asyn/console)
- length (asyn)
- login authentication
- privilege level
- speed (asyn)



# privilege level

**Overview** This command sets a privilege level for VTY or console connections. The configured privilege level from this command overrides a specific user's initial privilege level at the console login.

**Syntax** `privilege level <1-15>`

**Mode** Line Configuration

**Usage notes** You can set an intermediate CLI security level for a console user with this command by applying privilege level 7 to access all show commands in Privileged Exec and all User Exec commands. However, intermediate CLI security will not show configuration commands in Privileged Exec.

**Examples** To set the console connection to have the maximum privilege level, use the following commands:

```
awplus# configure terminal
awplus(config)# line console 0
awplus(config-line)# privilege level 15
```

To set all VTY connections to have the minimum privilege level, use the following commands:

```
awplus# configure terminal
awplus(config)# line vty 0 5
awplus(config-line)# privilege level 1
```

To set all VTY connections to have an intermediate CLI security level, to access all show commands, use the following commands:

```
awplus# configure terminal
awplus(config)# line vty 0 5
awplus(config-line)# privilege level 7
```

**Related commands**

- [enable password](#)
- [line](#)
- [show privilege](#)
- [username](#)

# security-password history

**Overview** This command specifies the number of previous passwords that are unable to be reused. A new password is invalid if it matches a password retained in the password history.

The **no** variant of the command disables this feature.

**Syntax** security-password history <0-15>  
no security-password history

Parameter	Description
<0-15>	The allowable range of previous passwords to match against. A value of 0 will disable the history functionality and is equivalent to the <b>no security-password history</b> command. If the history functionality is disabled, all users' password history is reset and all password history is lost.

**Default** The default history value is 0, which will disable the history functionality.

**Mode** Global Configuration

**Examples** To restrict reuse of the three most recent passwords, use the command:

```
awplus# configure terminal  
awplus(config)# security-password history 3
```

To allow the reuse of recent passwords, use the command:

```
awplus# configure terminal  
awplus(config)# no security-password history
```

**Related commands**

- [security-password forced-change](#)
- [security-password lifetime](#)
- [security-password min-lifetime-enforce](#)
- [security-password minimum-categories](#)
- [security-password minimum-length](#)
- [security-password reject-expired-pwd](#)
- [security-password warning](#)
- [show running-config security-password](#)
- [show security-password configuration](#)
- [show security-password user](#)

# security-password forced-change

**Overview** This command specifies whether or not a user is forced to change an expired password at the next login. If this feature is enabled, users whose passwords have expired are forced to change to a password that must comply with the current password security rules at the next login.

Note that to use this command, the lifetime feature must be enabled with the [security-password lifetime](#) command and the reject-expired-pwd feature must be disabled with the [security-password reject-expired-pwd](#) command.

The **no** variant of the command disables this feature.

**Syntax** `security-password forced-change`  
`no security-password forced-change`

**Default** The forced-change feature is disabled by default.

**Mode** Global Configuration

**Example** To force a user to change their expired password at the next login, use the command:

```
awplus# configure terminal
awplus(config)# security-password forced-change
```

**Related commands**

- [security-password history](#)
- [security-password lifetime](#)
- [security-password min-lifetime-enforce](#)
- [security-password minimum-categories](#)
- [security-password minimum-length](#)
- [security-password reject-expired-pwd](#)
- [security-password warning](#)
- [show running-config security-password](#)
- [show security-password configuration](#)
- [show security-password user](#)

# security-password lifetime

**Overview** This command enables password expiry by specifying a password lifetime in days.

Note that when the password lifetime feature is disabled, it also disables the [security-password forced-change](#) command and the [security-password warning](#) command.

The **no** variant of the command disables this feature.

**Syntax** `security-password lifetime <0-1000>`  
`no security-password lifetime`

Parameter	Description
<code>&lt;0-1000&gt;</code>	Password lifetime specified in days. A value of 0 will disable lifetime functionality and the password will never expire. This is equivalent to the <b>no security-password lifetime</b> command.

**Default** The default password lifetime is 0, which will disable the lifetime functionality.

**Mode** Global Configuration

**Example** To configure the password lifetime to 10 days, use the command:

```
awplus# configure terminal
awplus(config)# security-password lifetime 10
```

**Related commands**

- [security-password forced-change](#)
- [security-password history](#)
- [security-password min-lifetime-enforce](#)
- [security-password minimum-categories](#)
- [security-password minimum-length](#)
- [security-password reject-expired-pwd](#)
- [security-password warning](#)
- [show running-config security-password](#)
- [show security-password configuration](#)
- [show security-password user](#)

# security-password min-lifetime-enforce

**Overview** Use this command to configure a minimum number of days before a password can be changed by a user. With this feature enabled, once a user sets the password, the user cannot change it again until the minimum lifetime has passed.

Use the **no** variant of this command to remove the minimum lifetime.

**Syntax** `security-password min-lifetime-enforce <0-1000>`  
`no security-password min-lifetime-enforce`

Parameter	Description
<code>&lt;0-1000&gt;</code>	The minimum number of days before a password can be changed

**Default** By default, no minimum lifetime is enforced.

**Mode** Global Configuration

**Usage notes** The minimum lifetime is helpful in conjunction with a security policy that prevents people from re-using old passwords. For example, if you do not allow people to re-use any of their last 5 passwords, a person can bypass that restriction by changing their password 5 times in quick succession and then re-setting it to their previous password. The minimum lifetime prevents that by preventing people from changing their password in quick succession.

**Example** To force users to wait at least 2 days between changing passwords, use the command:

```
awplus(config)# security-password min-lifetime-enforce 2
```

**Related commands**

- [security-password forced-change](#)
- [security-password history](#)
- [security-password lifetime](#)
- [security-password minimum-categories](#)
- [security-password minimum-length](#)
- [security-password reject-expired-pwd](#)
- [security-password warning](#)
- [show running-config security-password](#)
- [show security-password configuration](#)
- [show security-password user](#)

**Command changes** Version 5.4.7-0.2: command added

# security-password minimum-categories

**Overview** This command specifies the minimum number of categories that the password must contain in order to be considered valid. The password categories are:

- uppercase letters: A to Z
- lowercase letters: a to z
- digits: 0 to 9
- special symbols: all printable ASCII characters not included in the previous three categories. The question mark (?) cannot be used as it is reserved for help functionality.

Note that to ensure password security, the minimum number of categories should align with the lifetime selected, i.e. the fewer categories specified the shorter the lifetime specified.

**Syntax** `security-password minimum-categories <1-4>`

Parameter	Description
<1-4>	Number of categories the password must satisfy, in the range 1 to 4.

**Default** The default number of categories that the password must satisfy is 1.

**Mode** Global Configuration

**Example** To configure the required minimum number of character categories to be 3, use the command:

```
awplus# configure terminal
awplus(config)# security-password minimum-categories 3
```

**Related commands**

- [security-password forced-change](#)
- [security-password history](#)
- [security-password lifetime](#)
- [security-password min-lifetime-enforce](#)
- [security-password minimum-length](#)
- [security-password reject-expired-pwd](#)
- [security-password warning](#)
- [show running-config security-password](#)
- [show security-password configuration](#)
- [show security-password user](#)

# security-password minimum-length

**Overview** This command specifies the minimum allowable password length. This value is checked against when there is a password change or a user account is created.

**Syntax** `security-password minimum-length <1-23>`

Parameter	Description
<code>&lt;1-23&gt;</code>	Minimum password length in the range from 1 to 23.

**Default** The default minimum password length is 1.

**Mode** Global Configuration

**Example** To configure the required minimum password length as 8, use the command:

```
awplus# configure terminal
awplus(config)# security-password minimum-length 8
```

**Related commands**

- [security-password forced-change](#)
- [security-password history](#)
- [security-password lifetime](#)
- [security-password min-lifetime-enforce](#)
- [security-password minimum-categories](#)
- [security-password reject-expired-pwd](#)
- [security-password warning](#)
- [show running-config security-password](#)
- [show security-password configuration](#)
- [show security-password user](#)

# security-password reject-expired-pwd

**Overview** This command specifies whether or not a user is allowed to login with an expired password. Users with expired passwords are rejected at login if this functionality is enabled. Users then have to contact the Network Administrator to change their password.

**CAUTION:** *Once all users' passwords are expired you are unable to login to the device again if the security-password reject-expired-pwd command has been executed. You will have to reboot the device with a default configuration file, or load an earlier software version that does not have the security password feature.*

*We recommend you never have the command line "security-password reject-expired-pwd" in a default config file.*

Note that when the reject-expired-pwd functionality is disabled and a user logs on with an expired password, if the forced-change feature is enabled with [security-password forced-change](#) command, a user may have to change the password during login depending on the password lifetime specified by the [security-password lifetime](#) command.

The **no** variant of the command disables this feature.

**Syntax** security-password reject-expired-pwd  
no security-password reject-expired-pwd

**Default** The reject-expired-pwd feature is disabled by default.

**Mode** Global Configuration

**Example** To configure the system to reject users with an expired password, use the command:

```
awplus# configure terminal
awplus(config)# security-password reject-expired-pwd
```

**Related commands**

- [security-password forced-change](#)
- [security-password history](#)
- [security-password lifetime](#)
- [security-password min-lifetime-enforce](#)
- [security-password minimum-categories](#)
- [security-password minimum-length](#)
- [security-password warning](#)
- [show running-config security-password](#)
- [show security-password configuration](#)
- [show security-password user](#)



# security-password warning

**Overview** This command specifies the number of days before the password expires that the user will receive a warning message specifying the remaining lifetime of the password.

Note that the warning period cannot be set unless the lifetime feature is enabled with the [security-password lifetime](#) command.

The **no** variant of the command disables this feature.

**Syntax** `security-password warning <0-1000>`  
`no security-password warning`

Parameter	Description
<code>&lt;0-1000&gt;</code>	Warning period in the range from 0 to 1000 days. A value 0 disables the warning functionality and no warning message is displayed for expiring passwords. This is equivalent to the <b>no security-password warning</b> command. The warning period must be less than, or equal to, the password lifetime set with the <a href="#">security-password lifetime</a> command.

**Default** The default warning period is 0, which disables warning functionality.

**Mode** Global Configuration

**Example** To configure a warning period of three days, use the command:

```
awplus# configure terminal
awplus(config)# security-password warning 3
```

**Related commands**

- [security-password forced-change](#)
- [security-password history](#)
- [security-password lifetime](#)
- [security-password min-lifetime-enforce](#)
- [security-password minimum-categories](#)
- [security-password minimum-length](#)
- [security-password reject-expired-pwd](#)
- [show running-config security-password](#)
- [show security-password configuration](#)
- [show security-password user](#)

# service advanced-vty

**Overview** This command enables the advanced-vty help feature. This allows you to use TAB completion for commands. Where multiple options are possible, the help feature displays the possible options.

The **no service advanced-vty** command disables the advanced-vty help feature.

**Syntax** service advanced-vty  
no service advanced-vty

**Default** The advanced-vty help feature is enabled by default.

**Mode** Global Configuration

**Examples** To disable the advanced-vty help feature, use the command:

```
awplus# configure terminal  
awplus(config)# no service advanced-vty
```

To re-enable the advanced-vty help feature after it has been disabled, use the following commands:

```
awplus# configure terminal  
awplus(config)# service advanced-vty
```

# service password-encryption

**Overview** Use this command to enable password encryption. This is enabled by default. When password encryption is enabled, the device displays passwords in the running config in encrypted form instead of in plain text.

Use the **no service password-encryption** command to stop the device from displaying newly-entered passwords in encrypted form. This does not change the display of existing passwords.

**Syntax** `service password-encryption`  
`no service password-encryption`

**Mode** Global Configuration

**Example** `awplus# configure terminal`  
`awplus(config)# service password-encryption`

**Validation Commands** `show running-config`

**Related commands** `enable password`

# service telnet

**Overview** Use this command to enable the telnet server. The server is enabled by default. Enabling the telnet server starts the device listening for incoming telnet sessions on the configured port.

The server listens on port 23, unless you have changed the port by using the [privilege level](#) command.

Use the **no** variant of this command to disable the telnet server. Disabling the telnet server will stop the device listening for new incoming telnet sessions. However, existing telnet sessions will still be active.

**Syntax** `service telnet [ip|ipv6]`  
`no service telnet [ip|ipv6]`

**Default** The IPv4 and IPv6 telnet servers are enabled by default.  
The configured telnet port is TCP port 23 by default.

**Mode** Global Configuration

**Examples** To enable both the IPv4 and IPv6 telnet servers, use the following commands:

```
awplus# configure terminal
awplus(config)# service telnet
```

To enable the IPv6 telnet server only, use the following commands:

```
awplus# configure terminal
awplus(config)# service telnet ipv6
```

To disable both the IPv4 and IPv6 telnet servers, use the following commands:

```
awplus# configure terminal
awplus(config)# no service telnet
```

To disable the IPv6 telnet server only, use the following commands:

```
awplus# configure terminal
awplus(config)# no service telnet ipv6
```

**Related commands**

- [clear line vty](#)
- [show telnet](#)
- [telnet server](#)

# service terminal-length (deleted)

**Overview** This command has been deleted in Software Version 5.4.5-0.1 and later.

# show aaa local user locked

**Overview** This command displays the current number of failed attempts, last failure time and location against each user account attempting to log into the device.

Note that once the lockout count has been manually cleared by another privileged account using the [clear aaa local user lockout](#) command or a locked account successfully logs into the system after waiting for the lockout time, this command will display nothing for that particular account.

**Syntax** show aaa local user locked

**Mode** User Exec and Privileged Exec

**Example** To display the current failed attempts for local users, use the command:

```
awplus# show aaa local user locked
```

**Output** Figure 3-1: Example output from the **show aaa local user locked** command

```
awplus# show aaa local user locked
Login          Failures Latest failure      From
bob            3      05/23/14 16:21:37    ttyS0
manager        5      05/23/14 16:31:44    192.168.1.200
```

**Related commands**

- [aaa local authentication attempts lockout-time](#)
- [aaa local authentication attempts max-fail](#)
- [clear aaa local user lockout](#)

# show privilege

**Overview** This command displays the current user privilege level, which can be any privilege level in the range <1-15>. Privilege levels <1-6> allow limited user access (all User Exec commands), privilege levels <7-14> allow restricted user access (all User Exec commands plus Privileged Exec show commands). Privilege level 15 gives full user access to all Privileged Exec commands.

**Syntax** `show privilege`

**Mode** User Exec and Privileged Exec

**Usage notes** A user can have an intermediate CLI security level set with this command for privilege levels <7-14> to access all show commands in Privileged Exec mode and all commands in User Exec mode, but no configuration commands in Privileged Exec mode.

**Example** To show the current privilege level of the user, use the command:

```
awplus# show privilege
```

**Output** Figure 3-2: Example output from the **show privilege** command

```
awplus#show privilege
Current privilege level is 15
awplus#disable
awplus>show privilege
Current privilege level is 1
```

**Related commands** [privilege level](#)

# show security-password configuration

**Overview** This command displays the configuration settings for the various security password rules.

**Syntax** show security-password configuration

**Mode** Privileged Exec

**Example** To display the current security-password rule configuration settings, use the command:

```
awplus# show security-password configuration
```

**Output** Figure 3-3: Example output from the **show security-password configuration** command

```
Security Password Configuration
Minimum password length ..... 8
Minimum password character categories to match ..... 3
Number of previously used passwords to restrict..... 4
Password lifetime ..... 30 day(s)
  Warning period before password expires ..... 3 day(s)
Reject expired password at login ..... Disabled
  Force changing expired password at login ..... Enabled
```

- Related commands**
- [security-password forced-change](#)
  - [security-password history](#)
  - [security-password lifetime](#)
  - [security-password min-lifetime-enforce](#)
  - [security-password minimum-categories](#)
  - [security-password minimum-length](#)
  - [security-password reject-expired-pwd](#)
  - [security-password warning](#)
  - [show security-password user](#)



# show security-password user

**Overview** This command displays user account and password information for all users.

**Syntax** `show security-password user`

**Mode** Privileged Exec

**Example** To display the system users' remaining lifetime or last password change, use the command:

```
awplus# show security-password user
```

**Output** Figure 3-4: Example output from the **show security-password** user command

User account and password information			
UserName	Privilege	Last-PWD-Change	Remaining-lifetime
manager	15	4625 day(s) ago	No Expiry
bob15	15	0 day(s) ago	30 days
ted7	7	0 day(s) ago	No Expiry
mike1	1	0 day(s) ago	No Expiry

- Related commands**
- [security-password forced-change](#)
  - [security-password history](#)
  - [security-password lifetime](#)
  - [security-password min-lifetime-enforce](#)
  - [security-password minimum-categories](#)
  - [security-password minimum-length](#)
  - [security-password reject-expired-pwd](#)
  - [security-password warning](#)
  - [show security-password configuration](#)

# show telnet

**Overview** This command shows the Telnet server settings.

**Syntax** show telnet

**Mode** User Exec and Privileged Exec

**Example** To show the Telnet server settings, use the command:

```
awplus# show telnet
```

**Output** Figure 3-5: Example output from the **show telnet** command

```
Telnet Server Configuration
-----
Telnet server           : Enabled
Protocol                : IPv4, IPv6
Port                    : 23
```

**Related commands**

- [clear line vty](#)
- [service telnet](#)
- [show users](#)
- [telnet server](#)

# show users

**Overview** This command shows information about the users who are currently logged into the device.

**Syntax** `show users`

**Mode** User Exec and Privileged Exec

**Example** To show the users currently connected to the device, use the command:

```
awplus# show users
```

**Output** Figure 3-6: Example output from the **show users** command

Line	User	Host(s)	Idle	Location	Priv	Idletime	Timeout
con 0	manager	idle	00:00:00	ttyS0	15	10	N/A
vtty 0	bob	idle	00:00:03	172.16.11.3	1	0	5

**Table 1:** Parameters in the output of the **show users** command

Parameter	Description
Line	Console port user is connected to.
User	Login name of user.
Host(s)	Status of the host the user is connected to.
Idle	How long the host has been idle.
Location	URL location of user.
Priv	The privilege level in the range 1 to 15, with 15 being the highest.
Idletime	The time interval the device waits for user input from either a console or VTY connection.
Timeout	The time interval before a server is considered unreachable.

# telnet

**Overview** Use this command to open a telnet session to a remote device.

**Syntax** `telnet {<hostname>|[ip] <ipv4-addr>|[ipv6] <ipv6-addr>}  
[<port>]`

Parameter	Description
<code>&lt;hostname&gt;</code>	The host name of the remote system.
<code>ip</code>	Keyword used to specify the IPv4 address or host name of a remote system.
<code>&lt;ipv4-addr&gt;</code>	An IPv4 address of the remote system.
<code>ipv6</code>	Keyword used to specify the IPv6 address of a remote system
<code>&lt;ipv6-addr&gt;</code>	Placeholder for an IPv6 address in the format <code>x:x::x:x</code> , for example, <code>2001:db8::8a2e:7334</code>
<code>&lt;port&gt;</code>	Specify a TCP port number (well known ports are in the range 1-1023, registered ports are 1024-49151, and private ports are 49152-65535).

**Mode** User Exec and Privileged Exec

**Examples** To connect to TCP port 2602 on the device at 10.2.2.2, use the command:

```
awplus# telnet 10.2.2.2 2602
```

To connect to the telnet server `host.example`, use the command:

```
awplus# telnet host.example
```

To connect to the telnet server `host.example` on TCP port 100, use the command:

```
awplus# telnet host.example 100
```

# telnet server

**Overview** This command enables the telnet server on the specified TCP port. If the server is already enabled then it will be restarted on the new port. Changing the port number does not affect the port used by existing sessions.

**Syntax** `telnet server {<1-65535>|default}`

Parameter	Description
<1-65535>	The TCP port to listen on.
default	Use the default TCP port number 23.

**Mode** Global Configuration

**Example** To enable the telnet server on TCP port 2323, use the following commands:

```
awplus# configure terminal
awplus(config)# telnet server 2323
```

**Related commands** [show telnet](#)

# terminal length

**Overview** Use the **terminal length** command to specify the number of rows of output that the device will display before pausing, for the currently-active terminal only.

Use the **terminal no length** command to remove the length specified by this command. The default length will apply unless you have changed the length for some or all lines by using the [length \(asyn\)](#) command.

**Syntax** `terminal length <length>`  
`terminal no length [<length>]`

Parameter	Description
<code>&lt;length&gt;</code>	<code>&lt;0-512&gt;</code> Number of rows that the device will display on the currently-active terminal before pausing.

**Mode** User Exec and Privileged Exec

**Examples** The following example sets the number of lines to 15:

```
awplus# terminal length 15
```

The following example removes terminal length set previously:

```
awplus# terminal no length
```

**Related commands** [terminal resize](#)  
[length \(asyn\)](#)

# terminal resize

**Overview** Use this command to automatically adjust the number of rows of output on the console, which the device will display before pausing, to the number of rows configured on the user's terminal.

**Syntax** `terminal resize`

**Mode** User Exec and Privileged Exec

**Usage notes** When the user's terminal size is changed, then a remote session via SSH or TELNET adjusts the terminal size automatically. However, this cannot normally be done automatically for a serial or console port. This command automatically adjusts the terminal size for a serial or console port.

**Examples** The following example automatically adjusts the number of rows shown on the console:

```
awplus# terminal resize
```

**Related commands** [length \(asyn\)](#)  
[terminal length](#)

# username

**Overview** This command creates or modifies a user to assign a privilege level and a password.

**NOTE:** *The default username privilege level of 1 is not shown in running-config output. Any username privilege level that has been modified from the default is shown.*

**Syntax**

```
username <name> privilege <1-15> [password [8] <password>]  
username <name> password [8] <password>  
no username <name>
```

Parameter	Description
<name>	The login name for the user. Do not use punctuation marks such as single quotes ('), double quotes ("), or colons (:) with the user login name.
privilege	The user's privilege level. Use the privilege levels to set the access rights for each user.  <1-15> A privilege level: either 1-14 (limited access) or 15 (full access). A user with privilege level 1-14 can only access higher privilege levels if an <a href="#">enable password</a> has been configured for the level the user tries to access and the user enters that password. A user at privilege level 1 can access the majority of show commands. A user at privilege level 7 can access the majority of show commands including platform show commands. Privilege Level 15 (to access the Privileged Exec command mode) is required to access configuration commands as well as show commands in Privileged Exec.
password	A password that the user must enter when logging in.  8 Specifies that you are entering a password as a string that has already been encrypted, instead of entering a plain-text password. The running-config displays the new password as an encrypted string even if password encryption is turned off. Note that the user enters the plain-text version of the password when logging in.
	<password> The user's password. The password can be up to 32 characters in length and include characters from up to four categories. The password categories are: <ul style="list-style-type: none"><li>• uppercase letters: A to Z</li><li>• lowercase letters: a to z</li><li>• digits: 0 to 9</li><li>• special symbols: all printable ASCII characters not included in the previous three categories. The question mark ? cannot be used as it is reserved for help functionality.</li></ul>

**Mode** Global Configuration

**Default** The privilege level is 1 by default. Note the default is not shown in running-config output.



**Usage notes** An intermediate CLI security level (privilege level 7 to privilege level 14) allows a CLI user access to the majority of show commands, including the platform show commands that are available at privilege level 1 to privilege level 6. Note that some show commands, such as **show running-configuration** and **show startup-configuration**, are only available at privilege level 15.

**Examples** To create the user "bob" with a privilege level of 15, for all show commands including show running-configuration and show startup-configuration and to access configuration commands in Privileged Exec command mode, and the password "bobs\_secret", use the commands:

```
awplus# configure terminal
awplus(config)# username bob privilege 15 password bobs_secret
```

To create a user "junior\_admin" with a privilege level of 7, which will have intermediate CLI security level access for most show commands, and the password "show\_only", use the commands:

```
awplus# configure terminal
awplus(config)# username junior_admin privilege 7 password
show_only
```

**Related commands** [enable password](#)  
[security-password minimum-categories](#)  
[security-password minimum-length](#)

# 4

# Feature Licensing Commands

## Introduction

**Overview** This chapter provides an alphabetical reference for each of the Feature Licensing commands. Feature Licensing enables you to use advanced features such as Layer 3 routing.

To see which Feature Licenses are available for your device, see the [AlliedWare Plus Datasheet](#).

Allied Telesis Management Framework (AMF) requires a Subscription License. For information about Subscription Licensing commands, see the Subscription Licensing Commands chapter.

For step-by-step instructions about how to license AlliedWare Plus devices, see the [Licensing Feature Overview and Configuration\\_Guide](#).

- Command List**
- [“license”](#) on page 179
  - [“show license”](#) on page 181
  - [“show license brief”](#) on page 183

# license

**Overview** This command activates the licensed software feature set on a device.

Use the **no** variant of this command to deactivate the licensed software feature set on a device.

For feature licenses, contact your authorized distributor or reseller. If a license key expires or is incorrect so the license key is invalid, then some software features will be unavailable.

**NOTE:** See the AlliedWare Plus™ datasheet for a list of current feature licenses available by product. Purchase licenses from your authorized dealer or reseller.

In a live network, only install feature licenses during scheduled maintenance.

**Syntax** license <label> <key>  
no license <label>

Parameter	Description
<label>	A name for the feature license. To determine names already in use, use the <a href="#">show license</a> command. This can be the default name supplied for the feature, or a renamed feature name.
<key>	The encrypted license key to enable a set of software features.

**Mode** Privileged Exec

**Usage notes** You can change the license label using this command to make it specific to you when you initially add a license. Once a license is added, any change to the license label first requires removal of the license before adding a license again with a new license label.

The default feature license labels are issued along with encrypted license keys by e-mail for you to apply using this command to activate features. You can change default feature license labels, but they must be 15 characters or less.

For example, you may want to change the label of the premium license to “premium-license”. You can check your new license label by using the [show license](#) command.

If you add a feature license you will be prompted at the console that the feature needs to restart. Restarting of individual protocols in this manner could result in the loss of network traffic. Only install licenses in scheduled maintenance periods for devices in a live environment.

**Examples** To activate the license called “Premium” that has the key 12345678ABCDE123456789ABCDE, use the command:

```
awplus# license Premium 12345678ABCDE123456789ABCDE
```

To deactivate the license called "Premium", use the command:

```
awplus# no license Premium
```

**Related  
commands** [show license](#)

# show license

**Overview** This command displays information about a specific software feature license, or all enabled software feature licenses on the device.

**Syntax** `show license [feature] [<label>|index <index-number>]`

Parameter	Description
feature	Only display license information for any applied feature licenses.
<label>	The license name to show information about. This can be used instead of the index number to identify a specific license.
index <index-number>	The index number of the license to show information about. This can be used instead of the license name to identify a specific license.

**Mode** User Exec and Privileged Exec

**Examples** To display full information about all enabled licenses, use the command:

```
awplus# show license
```

To display full information about the licenses with index number 1, use the command:

```
awplus# show license index 1
```

**Output** Figure 4-1: Example output from **show license**

```
awplus#show license
Board region: Global
Software Licenses
-----
Index                : 1
License name         : Base License
Customer name        : Base License
Quantity of licenses : 1
Type of license      : Full
License issue date   : 20-Mar-2019
License expiry date  : N/A
Features included    : IPv6Basic, LAG-FULL, MLDSnoop, RADIUS-100, ...
```

Table 4-1: Parameters in the output of **show license**

Parameter	Description
Board region	Name of the region for the Base License features.
Index	Index identifying entry. The index is assigned automatically by the software. It is not configured.

Table 4-1: Parameters in the output of **show license** (cont.)

Parameter	Description
License name	Name of the license key bundle (case-sensitive).
Customer name	Customer name.
Quantity of licenses	Quantity of licensed installations.
Type of license	Full or Trial.
License issue date	Date the license was generated.
License expiry date	Expiry date for trial license.
Features included	List of features included in the feature license.

**Related commands** [license](#)  
[show license brief](#)

# show license brief

**Overview** This command displays information about a specific software feature license, or all enabled software feature licenses on the device.

**Syntax** `show license brief`  
`show license [feature] [<label>|index <index-number>] brief`

Parameter	Description
feature	Only display license information for any applied feature licenses.
<label>	The license name to show information about. This can be used instead of the index number to identify a specific license.
index <index-number>	The index number of the license to show information about. This can be used instead of the license name to identify a specific license.
brief	Displays a brief summary of license information.

**Mode** User Exec and Privileged Exec

**Examples** To display a brief summary of information about all licenses, use the command:

```
awplus# show license brief
```

**Output** Figure 4-2: Example output from **show license brief**

```
awplus#show license brief
Board region: Global
Software Licenses
-----
Index License name      Quantity  Customer name
      Type              Version   Period
-----
1     Base License      1         Base License
      Full              N/A      N/A

Current enabled features for displayed licenses:
IPv6Basic, LAG-FULL, MLDSnoop ...
```

Table 4-2: Parameters in the output of **show license brief**

Parameter	Description
Board region	Name of the region for the Base License features.
Index	Index identifying entry. The index is assigned automatically by the software. It is not configured.

Table 4-2: Parameters in the output of **show license brief** (cont.)

Parameter	Description
License name	Name of the license key bundle (case-sensitive).
Quantity	Quantity of licensed installations.
Customer name	Customer name.
Type	Full or Trial.
Period	Expiry date for trial license.
Current enabled features for displayed licenses	List of features included in the license.

**Related commands** [license](#)  
[show license](#)



# 5

# Subscription Licensing Commands

## Introduction

**Overview** This chapter provides an alphabetical reference for each of the Subscription Licensing commands.

For step-by-step instructions about how to license AlliedWare Plus devices, see the [Licensing Feature Overview and Configuration Guide](#).

- Command List**
- “[license update \(filename\)](#)” on page 186
  - “[license update online](#)” on page 187
  - “[show license external](#)” on page 188

# license update (filename)

**Overview** Use this command to load a license, after you have manually copied the license file onto the device.

Only use this command if you cannot directly access the [Allied Telesis Download Center](#) from this device. Otherwise, use the command [license update online](#) instead.

**Syntax** `license update <filename>`

Parameter	Description
<code>&lt;filename&gt;</code>	Name and path of the license file on the device.

**Mode** Privileged Exec

**Usage notes** You can download subscription licenses from the [Allied Telesis Download Center](#), in order to copy them onto the device.

**Examples** To load a license onto a device from a file called "license\_file.bin" that is stored at the top level of Flash memory, use the following command:

```
awplus#license update license_file.bin
```

**Related commands** [license update online](#)  
[show license external](#)

**Command changes** Version 5.4.6-2.1: usage changed by introduction of [license update online](#)

# license update online

**Overview** Use this command to add or update subscription licenses from the [Allied Telesis Download Center](#), to subscribe to features such as OpenFlow.

When you enter this command, the device will:

- 1) Connect to the Download Center
- 2) Check if new or changed licenses are available for the device, keyed to the device's serial number
- 3) For each such license it finds, download and install the license.

**Syntax** `license update online`

**Default** AlliedWare Plus devices do not automatically connect to the Download Center and check whether licenses are available. They only check when you run the **license update online** command.

**Mode** User Exec/Privileged Exec

**Usage notes** **Verifying the update**

The update process normally takes approximately 5 seconds.

If the console does not respond for 10 or more seconds after typing the command, a network, routing or firewall configuration error is probably preventing the connection from establishing. If this happens, you can abort the command by pressing Ctrl-C, or wait for the command to time out after 30 seconds.

If the connection to the Download Centers fails and times out, an error message will be generated on the CLI to indicate the problem. If you abort the command, no error message is displayed.

If the update is successful, the device will produce log messages to say which features have had their licensing state updated (activated, deactivated, number of items changed, or expiry date changed). If the command completes successfully but there are no licenses available for the device, or no change in the licenses already on the device, no log messages will be produced.

You should also use the [show license external](#) command to confirm which licenses are active on the device after the update has been applied.

**Example** To add a subscription license, use the command:

```
awplus# license update online
```

**Related commands** [show license external](#)

**Command changes** Version 5.4.6-2.1: command added

# show license external

**Overview** Use this command to show information about subscription (external) licenses.

**Syntax** show license external

**Mode** Privileged Exec

**Examples** To show information about what subscription features the device is licensed for, use the following command:

```
awplus#show license external
```

**Output** Figure 5-1: Example output from **show license external**

```
awplus#show license external

Features with installed entitlements:

OpenFlow

    Currently licensed:           Yes

    Start date:                  19 Sep 2016 00:00
    Expiry date:                  19 Sep 2017 23:59
```

**Related commands** [license update online](#)

# 6

# GUI Commands

## Introduction

**Overview** This chapter provides an alphabetical reference of commands used to configure the GUI.

For more information, see [Getting Started with the Device GUI on Switches](#).

- Command List**
- [“atmf topology-gui enable”](#) on page 190
  - [“gui-timeout”](#) on page 191
  - [“http port”](#) on page 192
  - [“http secure-port”](#) on page 193
  - [“log event-host”](#) on page 194
  - [“service http”](#) on page 195
  - [“show http”](#) on page 196

# atmf topology-gui enable

**Overview** Use this command to enable the operation of Vista Manager EX on the Master device.

Vista Manager EX delivers state-of-the-art monitoring and management for your Autonomous Management Framework™ (AMF) network, by automatically creating a complete topology map of switches, firewalls and wireless access points (APs). An expanded view includes third-party devices such as security cameras.

Use the **no** variant of this command to disable operation of Vista Manager EX.

**Syntax** atmf topology-gui enable  
no atmf topology-gui enable

**Default** Disabled by default on AMF Master and member nodes. Enabled by default on Controllers.

**Mode** Global Configuration mode

**Usage notes** To use Vista Manager EX, you must also enable the HTTP service on all AMF nodes, including all AMF masters and controllers. The HTTP service is enabled by default on AlliedWare Plus switches and disabled by default on AR-Series firewalls. To enable it, use the commands:

```
Node1# configure terminal  
Node1(config)# service http
```

On one master in each AMF area in your network, you also need to configure the master to send event notifications to Vista Manager EX. To do this, use the commands:

```
Node1# configure terminal  
Node1(config)# log event-host <ip-address> atmf-topology-event
```

**Example** To enable Vista Manager EX on Node1, use the following commands:

```
Node1# configure terminal  
Node1(config)# atmf topology-gui enable
```

To disable Vista Manager EX on Node1, use the following commands:

```
Node1# configure terminal  
Node1(config)# no atmf topology-gui enable
```

**Related commands** [atmf enable](#)  
[gui-timeout](#)  
[log event-host](#)  
[service http](#)

# gui-timeout

**Overview** Use this command to configure an idle timeout period for a GUI session. The time can be set in minutes and/or seconds.

Use the **no** variant of this command to disable the GUI session idle timeout.

**Syntax** `gui-timeout <minutes> [<seconds>]`  
`no gui-timeout`

Parameter	Description
<code>&lt;minutes&gt;</code>	Specifies the idle time in minutes from 0 through 35791
<code>&lt;seconds&gt;</code>	Specifies the idle time in seconds from 0 through 2147483

**Default** Disabled

**Mode** Global Configuration

**Usage notes** The GUI uses the configured timeout period (set in either minutes and/or seconds) to determine when a GUI session should be closed. Once the GUI timeout has expired, you will need to login to reactivate your session.

To enter seconds only, enter 0 for minutes, followed by a space, and then enter the seconds.

If the GUI timeout is disabled, a GUI session will remain active until you terminate it. No idle time will be configured.

The same timeout period will apply to all GUI sessions logged into a specific device.

**Examples** Use this command to configure the GUI timeout period for 3 minutes and 30 seconds for a GUI session.

```
awplus# gui-timeout 3 30
```

Use this command to configure the GUI timeout period for 0 minutes and 61 seconds for a GUI session.

```
awplus# gui-timeout 0 61
```

Use this command to disable the GUI timeout period.

```
awplus# no gui-timeout
```

**Output** Figure 6-1: Example output from **gui-timeout**

```
awplus#configure terminal
awplus(config)#gui-timeout 3 30
The new gui-timeout settings [3 min 30 sec] will apply to new sessions only
```

**Related commands** [show running-config](#)

# http port

**Overview** Use this command to change the HTTP port used to access the web-based device GUI, or to disable HTTP management.

Use the **no** variant of this command to return to using the default port, which is 80.

**Syntax** `http port {<1-65535>|none}`  
`no http port`

Parameter	Description
<1-65535>	The HTTP port number
none	Disable HTTP management. You may want to do this if you need to use port 80 for a different service or you do not need to use HTTP at all.

**Default** The default port for accessing the GUI is port 80.

**Mode** Global Configuration

**Usage notes** Do not configure the HTTP port to be the same as the HTTPS port.  
Note that the device will redirect from HTTP to HTTPS unless you have disabled HTTPS access, which we do not recommend doing.

**Example** To set the port to 8080, use the commands:

```
awplus# configure terminal  
awplus(config)# http port 8080
```

To return to using the default port of 80, use the commands:

```
awplus# configure terminal  
awplus(config)# no http port
```

To stop users from accessing the GUI via HTTP, use the commands:

```
awplus# configure terminal  
awplus(config)# http port none
```

**Related commands** [http secure-port](#)  
[service http](#)  
[show http](#)

**Command changes** Version 5.4.7-2.4: command added on AR-Series devices  
Version 5.4.8-0.2: command added on AlliedWare Plus switches



# http secure-port

**Overview** Use this command to change the HTTPS port used to access the web-based device GUI, or to disable HTTPS management.

Use the **no** variant of this command to return to using the default port, which is 443.

**Syntax** `http secure-port {<1-65535>|none}`  
`no http secure-port`

Parameter	Description
<1-65535>	The HTTPS port number
none	Disable HTTPS management. Do not do this if you want to use Vista Manager EX or the GUI.

**Default** The default port for accessing the GUI is port 443.

**Mode** Global Configuration

**Usage notes** Do not configure the HTTPS port to be the same as the HTTP port.

Note that if you are using Vista Manager EX and need to change the HTTPS port, you must use certificate-based authorization in Vista Manager EX. See the [Vista Manager EX Installation and User Guide](#) for instructions.

**Example** To set the port to 8443, use the commands:

```
awplus# configure terminal
awplus(config)# http secure-port 8443
```

To return to using the default port of 443, use the commands:

```
awplus# configure terminal
awplus(config)# no http secure-port
```

To stop users from accessing the GUI via HTTPS, use the commands:

```
awplus# configure terminal
awplus(config)# http secure-port none
```

**Related commands** [http port](#)  
[service http](#)  
[show http](#)

**Command changes** Version 5.4.7-1.1: command added on AR-Series devices  
Version 5.4.7-2.4: **none** parameter added

Version 5.4.8-0.2: command added on AlliedWare Plus switches

# log event-host

**Overview** Use this command to set up an external host to log AMF topology events through Vista Manager. This command is run on the Master device.

Use the **no** variant of this command to disable log events through Vista Manager.

**Syntax** `log event-host [<ipv4-addr>|<ipv6-addr>] atmf-topology-event`  
`no log event-host [<ipv4-addr>|<ipv6-addr>] atmf-topology-event`

Parameter	Description
<code>&lt;ipv4-addr&gt;</code>	ipv4 address of the event host
<code>&lt;ipv6-addr&gt;</code>	ipv6 address of the event host

**Default** Log events are disabled by default.

**Mode** Global Configuration

**Usage notes** Event hosts are set so syslog sends the messages out as they come.

Note that there is a difference between log event and log host messages:

- Log event messages are sent out as they come by syslog
- Log host messages are set to wait for a number of messages (20) to send them out together for traffic optimization.

**Example** To enable Node 1 to log event messages from host IP address 192.0.2.31, use the following commands:

```
Node1# configure terminal
```

```
Node1(config)# log event-host 192.0.2.31 atmf-topology-event
```

To disable Node 1 to log event messages from host IP address 192.0.2.31, use the following commands:

```
Node1# configure terminal
```

```
Node1(config)# no log event-host 192.0.2.31 atmf-topology-event
```

**Related commands** [atmf topology-gui enable](#)

# service http

**Overview** Use this command to enable the HTTP (Hypertext Transfer Protocol) service. This service is required to support Vista Manager EX™ and the device GUI. Use the **no** variant of this command to disable the HTTP feature.

**Syntax** `service http`  
`no service http`

**Default** Enabled

**Mode** Global Configuration

**Example** To enable the HTTP service, use the following commands:

```
awplus# configure terminal  
awplus(config)# service http
```

To disable the HTTP service, use the following commands:

```
awplus# configure terminal  
awplus(config)# no service http
```

**Related commands** [http port](#)  
[http secure-port](#)  
[show http](#)

# show http

**Overview** This command shows the HTTP server settings.

**Syntax** show http

**Mode** User Exec and Privileged Exec

**Example** To show the HTTP server settings, use the command:

```
awplus# show http
```

**Output** Figure 6-2: Example output from the **show http** command

```
awplus#show http
HTTP Server Configuration
-----
HTTP server           : Enabled
Port                  : 80
```

**Related commands** [clear line vty](#)  
[service http](#)

# 7

# System Configuration and Monitoring Commands

## Introduction

**Overview** This chapter provides an alphabetical reference of commands for configuring and monitoring the system.

- Command List**
- “[banner exec](#)” on page 199
  - “[banner login \(system\)](#)” on page 201
  - “[banner motd](#)” on page 203
  - “[clock set](#)” on page 205
  - “[clock summer-time date](#)” on page 206
  - “[clock summer-time recurring](#)” on page 208
  - “[clock timezone](#)” on page 210
  - “[debug core-file](#)” on page 211
  - “[ecofriendly led](#)” on page 212
  - “[findme](#)” on page 213
  - “[hostname](#)” on page 215
  - “[max-fib-routes](#)” on page 217
  - “[max-static-routes](#)” on page 218
  - “[no debug all](#)” on page 219
  - “[reboot](#)” on page 221
  - “[reload](#)” on page 222
  - “[show clock](#)” on page 223
  - “[show cpu](#)” on page 225
  - “[show cpu history](#)” on page 228
  - “[show debugging](#)” on page 230

- “show ecofriendly” on page 231
- “show interface memory” on page 232
- “show memory” on page 234
- “show memory allocations” on page 236
- “show memory history” on page 238
- “show memory pools” on page 239
- “show memory shared” on page 240
- “show process” on page 241
- “show reboot history” on page 243
- “show router-id” on page 244
- “show system” on page 245
- “show system environment” on page 246
- “show system interrupts” on page 247
- “show system mac” on page 248
- “show system serialnumber” on page 249
- “show tech-support” on page 250
- “speed (asyn)” on page 252
- “system territory (deprecated)” on page 254
- “terminal monitor” on page 255
- “undebug all” on page 256

# banner exec

**Overview** This command configures the User Exec mode banner that is displayed on the console after you login. The **banner exec default** command restores the User Exec banner to the default banner. Use the **no banner exec** command to disable the User Exec banner and remove the default User Exec banner.

**Syntax** banner exec <banner-text>  
banner exec default  
no banner exec

**Default** By default, the AlliedWare Plus™ version and build date is displayed at console login, such as:

```
AlliedWare Plus (TM) 5.5.0 04/05/20 12:00:00
```

**Mode** Global Configuration

**Examples** To configure a User Exec mode banner after login (in this example, to tell people to use the **enable** command to move to Privileged Exec mode), enter the following commands:

```
awplus#configure terminal
awplus(config)#banner exec Use enable to move to Priv Exec mode
awplus(config)#exit
awplus#exit

awplus login: manager
Password:

Use enable to move to Priv Exec mode

awplus>
```

To restore the default User Exec mode banner after login, enter the following commands:

```
awplus#configure terminal
awplus(config)#banner exec default
awplus(config)#exit
awplus#exit

awplus login: manager
Password:

AlliedWare Plus (TM) 5.5.0 04/05/20 12:00:00

awplus>
```

To remove the User Exec mode banner after login, enter the following commands:

```
awplus#configure terminal
awplus(config)#no banner exec
awplus(config)#exit
awplus#exit

awplus login: manager
Password:

awplus>
```

**Related commands**

- [banner login \(system\)](#)
- [banner motd](#)



## banner login (system)

**Overview** This command configures the login banner that is displayed on the console when you login. The login banner is displayed on all connected terminals. The login banner is displayed after the MOTD (Message-of-the-Day) banner and before the login username and password prompts.

Use the **no banner login** command to disable the login banner.

**Syntax** banner login  
no banner login

**Default** By default, no login banner is displayed at console login.

**Mode** Global Configuration

**Examples** To configure a login banner of “Authorized users only” to be displayed when you login, enter the following commands:

```
awplus#configure terminal
awplus(config)#banner login
Type CNTL/D to finish.

Authorized users only

awplus(config)#exit
awplus#exit

Authorized users only

awplus login: manager
Password:

AlliedWare Plus (TM) 5.5.0 04/05/20 12:00:00

awplus>
```

To remove the login banner, enter the following commands:

```
awplus#configure terminal
awplus(config)#no banner login
awplus(config)#exit
awplus#exit

awplus login: manager
Password:

AlliedWare Plus (TM) 5.5.0 04/05/20 12:00:00

awplus>
```

**Related  
commands** [banner exec](#)  
[banner motd](#)

# banner motd

**Overview** Use this command to create or edit the text MotD (Message-of-the-Day) banner displayed before login. The MotD banner is displayed on all connected terminals. The MotD banner is useful for sending messages that affect all network users, for example, any imminent system shutdowns.

Use the **no** variant of this command to delete the MotD banner.

**Syntax** banner motd <motd-text>  
no banner motd

Parameter	Description
<motd-text>	The text to appear in the Message of the Day banner.

**Default** By default, the device displays the AlliedWare Plus™ OS version and build date when you login.

**Mode** Global Configuration

**Examples** To configure a MotD banner of "System shutdown at 6pm today" to be displayed when you log in, enter the following commands:

```
awplus>enable
awplus#configure terminal
Enter configuration commands, one per line. End with CNTL/Z.
awplus(config)#banner motd System shutdown at 6pm today
awplus(config)#exit
awplus#exit

System shutdown at 6pm today
awplus login: manager
Password:

AlliedWare Plus (TM) 5.5.0 04/05/20 12:00:00

awplus>
```

To delete the login banner, enter the following commands:

```
awplus>enable
awplus#configure terminal
Enter configuration commands, one per line.  End with CNTL/Z.
awplus(config)#no banner motd
awplus(config)#exit
awplus#exit

awplus login: manager
Password:

AlliedWare Plus (TM) 5.5.0 04/05/20 12:00:00

awplus>
```

**Related commands**

- [banner exec](#)
- [banner login \(system\)](#)

# clock set

**Overview** This command sets the time and date for the system clock.

**Syntax** `clock set <hh:mm:ss> <day> <month> <year>`

Parameter	Description
<hh:mm:ss>	Local time in 24-hour format
<day>	Day of the current month, from 1 to 31
<month>	The first three letters of the current month
<year>	Current year, from 2000 to 2035

**Mode** Privileged Exec

**Usage notes** Configure the timezone before setting the local time. Otherwise, when you change the timezone, the device applies the new offset to the local time.

**NOTE:** *If Network Time Protocol (NTP) is enabled, then you cannot change the time or date using this command. NTP maintains the clock automatically using an external time source. If you wish to manually alter the time or date, you must first disable NTP.*

**Example** To set the time and date on your system to 2pm on the 2nd of October 2016, use the command:

```
awplus# clock set 14:00:00 2 oct 2016
```

**Related commands** [clock timezone](#)

# clock summer-time date

**Overview** This command defines the start and end of summertime for a specific year only, and specifies summertime's offset value to Standard Time for that year.

The **no** variant of this command removes the device's summertime setting. This clears both specific summertime dates and recurring dates (set with the [clock summer-time recurring](#) command).

By default, the device has no summertime definitions set.

**Syntax**

```
clock summer-time <timezone-name> date <start-day>
<start-month> <start-year> <start-time> <end-day> <end-month>
<end-year> <end-time> <1-180>

no clock summer-time
```

Parameter	Description
<timezone-name>	A description of the summertime zone, up to 6 characters long.
date	Specifies that this is a date-based summertime setting for just the specified year.
<start-day>	Day that the summertime starts, from 1 to 31.
<start-month>	First three letters of the name of the month that the summertime starts.
<start-year>	Year that summertime starts, from 2000 to 2035.
<start-time>	Time of the day that summertime starts, in the 24-hour time format HH:MM.
<end-day>	Day that summertime ends, from 1 to 31.
<end-month>	First three letters of the name of the month that the summertime ends.
<end-year>	Year that summertime ends, from 2000 to 2035.
<end-time>	Time of the day that summertime ends, in the 24-hour time format HH:MM.
<1-180>	The offset in minutes.

**Mode** Global Configuration

**Examples** To set a summertime definition for New Zealand using NZST (UTC+12:00) as the standard time, and NZDT (UTC+13:00) as summertime, with the summertime set to begin on the 25th of September 2016 and end on the 2nd of April 2017:

```
awplus(config)# clock summer-time NZDT date 25 sep 2:00 2016 2
apr 2:00 2017 60
```

To remove any summertime settings on the system, use the command:

```
awplus(config)# no clock summer-time
```

**Related commands** [clock summer-time recurring](#)  
[clock timezone](#)

# clock summer-time recurring

**Overview** This command defines the start and end of summertime for every year, and specifies summertime's offset value to Standard Time.

The **no** variant of this command removes the device's summertime setting. This clears both specific summertime dates (set with the [clock summer-time date](#) command) and recurring dates.

By default, the device has no summertime definitions set.

**Syntax** `clock summer-time <timezone-name> recurring <start-week> <start-day> <start-month> <start-time> <end-week> <end-day> <end-month> <end-time> <1-180>`

`no clock summer-time`

Parameter	Description
<code>&lt;timezone-name&gt;</code>	A description of the summertime zone, up to 6 characters long.
<code>recurring</code>	Specifies that this summertime setting applies every year from now on.
<code>&lt;start-week&gt;</code>	Week of the month when summertime starts, in the range 1-5. The value 5 indicates the last week that has the specified day in it for the specified month. For example, to start summertime on the last Sunday of the month, enter 5 for <code>&lt;start-week&gt;</code> and sun for <code>&lt;start-day&gt;</code> .
<code>&lt;start-day&gt;</code>	Day of the week when summertime starts. Valid values are mon, tue, wed, thu, fri, sat or sun.
<code>&lt;start-month&gt;</code>	First three letters of the name of the month that summertime starts.
<code>&lt;start-time&gt;</code>	Time of the day that summertime starts, in the 24-hour time format HH:MM.
<code>&lt;end-week&gt;</code>	Week of the month when summertime ends, in the range 1-5. The value 5 indicates the last week that has the specified day in it for the specified month. For example, to end summertime on the last Sunday of the month, enter 5 for <code>&lt;end-week&gt;</code> and sun for <code>&lt;end-day&gt;</code> .
<code>&lt;end-day&gt;</code>	Day of the week when summertime ends. Valid values are mon, tue, wed, thu, fri, sat or sun.
<code>&lt;end-month&gt;</code>	First three letters of the name of the month that summertime ends.
<code>&lt;end-time&gt;</code>	Time of the day that summertime ends, in the 24-hour time format HH:MM.
<code>&lt;1-180&gt;</code>	The offset in minutes.



**Mode** Global Configuration

**Examples** To set a summertime definition for New Zealand using NZST (UTC+12:00) as the standard time, and NZDT (UTC+13:00) as summertime, with summertime set to start on the last Sunday in September, and end on the 1st Sunday in April, use the command:

```
awplus(config)# clock summer-time NZDT recurring 5 sun sep 2:00  
1 sun apr 2:00 60
```

To remove any summertime settings on the system, use the command:

```
awplus(config)# no clock summer-time
```

**Related commands** [clock summer-time date](#)  
[clock timezone](#)

# clock timezone

**Overview** This command defines the device's clock timezone. The timezone is set as a offset to the UTC.

The **no** variant of this command resets the system time to UTC.

By default, the system time is set to UTC.

**Syntax** `clock timezone <timezone-name> {minus|plus}`  
`[<0-13>|<0-12>:<00-59>]`

`no clock timezone`

Parameter	Description
<code>&lt;timezone-name&gt;</code>	A description of the timezone, up to 6 characters long.
<code>minusorplus</code>	The direction of offset from UTC. The <b>minus</b> option indicates that the timezone is behind UTC. The <b>plus</b> option indicates that the timezone is ahead of UTC.
<code>&lt;0-13&gt;</code>	The offset in hours or from UTC.
<code>&lt;0-12&gt;:&lt;00-59&gt;</code>	The offset in hours or from UTC.

**Mode** Global Configuration

**Usage notes** Configure the timezone before setting the local time. Otherwise, when you change the timezone, the device applies the new offset to the local time.

**Examples** To set the timezone to New Zealand Standard Time with an offset from UTC of +12 hours, use the command:

```
awplus(config)# clock timezone NZST plus 12
```

To set the timezone to Indian Standard Time with an offset from UTC of +5:30 hours, use the command:

```
awplus(config)# clock timezone IST plus 5:30
```

To set the timezone back to UTC with no offsets, use the command:

```
awplus(config)# no clock timezone
```

**Related commands**

[clock set](#)

[clock summer-time date](#)

[clock summer-time recurring](#)

# debug core-file

**Overview** Use this command to enable the generation of crash core files.

Use the **no** variant of this command to disable the generation of crash core files.

**Syntax** `debug core-file`  
`no debug core-file`

**Default** Enabled.

**Mode** Global Configuration

**Usage notes** Core files may contain raw memory content. This may not be acceptable in a security certified network. Use the **no debug core-file** command to prevent such core files from being generated.

**Example** To prevent the generation of core files, use the commands:

```
awplus# configure terminal
awplus(config)# no debug core-file
```

**Related commands** [show system](#)

**Command changes** Version 5.4.9-1.0: command added

# ecofriendly led

**Overview** Use this command to enable the eco-friendly LED (Light Emitting Diode) feature, which turns off power to the port LEDs.

You can also use the front-panel eco-switch button to enable or disable the eco-friendly feature. Using this button overrides the configuration set with the **ecofriendly led** command.

Use the **no** variant of this command to disable the eco-friendly LED feature.

**Syntax** `ecofriendly led`  
`no ecofriendly led`

**Default** The eco-friendly LED feature is disabled by default.

**Mode** Global Configuration

**Usage notes** When the eco-friendly LED feature is enabled, a change in port status will not affect the display of the associated LED. When the eco-friendly LED feature is disabled and power is returned to port LEDs, the LEDs will correctly show the current state of the ports.

For an example of how to configure a trigger to turn off power to port LEDs, see the [Triggers Feature Overview and Configuration Guide](#).

**Examples** To enable the eco-friendly LED feature which turns off power to all port LEDs, use the following commands:

```
awplus# configure terminal
awplus(config)# ecofriendly led
```

To disable the eco-friendly LED feature, use the following command:

```
awplus# configure terminal
awplus(config)# no ecofriendly led
```

**Related commands** [show ecofriendly](#)

# findme

**Overview** Use this command to physically locate a specific device from a group of similar devices. Activating the command causes a selected number of port LEDs to alternately flash green then amber (if that device has amber LEDs) at a rate of 1 Hz.

Use the **no** variant of this command to deactivate the Find Me feature prior to the timeout expiring.

**Syntax** `findme [interface <port-list>] [timeout <duration>]`  
`no findme`

Parameter	Description
<code>interface &lt;port-list&gt;</code>	The ports to flash. The port list can be: <ul style="list-style-type: none"><li>• a switch port, e.g. port1.0.4</li><li>• a continuous range of ports separated by a hyphen, e.g. port1.0.1-1.0.4</li><li>• a comma-separated list of ports and port ranges, e.g. port1.0.1,port1.0.5-1.0.6.</li></ul>
<code>timeout &lt;duration&gt;</code>	How long the LEDs flash, in seconds, in the range 5 to 3600 seconds.

**Default** By default all port LEDs flash for 60 seconds.

**Mode** Privileged Exec

**Usage notes** Running the **findme** command causes the device's port LEDs to flash. An optional **timeout** parameter specifies the flash behavior duration. Normal LED behavior is restored automatically after either the default time, or a specified time has elapsed, or a **no findme** command is used. You can specify which interface or interfaces are flashed with the optional **interface** parameter.

**Example** To activate the Find Me feature for the default duration (60 seconds) on all ports, use the following command:

```
awplus# findme
```

To activate the Find Me feature for 120 seconds on all ports, use the following command:

```
awplus# findme timeout 120
```

To activate the Find Me feature for the default duration (60 seconds) on switch port interfaces port1.0.2 through port1.0.4, use the following command:

```
awplus# findme interface port1.0.2-1.0.4
```

In the example above, ports 2 to 4 will flash 4 times and then all ports will flash twice. Each alternate flash will be amber (if that device has amber LEDs). This pattern will repeat until **timeout** (default or set) or **no findme** commands are used.

To deactivate the Find Me feature, use the following command:

```
awplus# no findme
```

# hostname

**Overview** This command sets the name applied to the device as shown at the prompt. The hostname is:

- displayed in the output of the `show system` command
- displayed in the CLI prompt so you know which device you are configuring
- stored in the MIB object sysName

Use the **no** variant of this command to revert the hostname setting to its default. For devices that are not part of an AMF network, the default is "awplus".

**Syntax** `hostname <hostname>`  
`no hostname [<hostname>]`

Parameter	Description
<code>&lt;hostname&gt;</code>	Specifies the name given to a specific device. This is also referred to as the Node name in AMF output screens.

**Default** awplus

**Mode** Global Configuration

**Usage notes** Within an AMF network, any device without a user-defined hostname will automatically be assigned a name based on its MAC address.

To efficiently manage your network using AMF, we strongly advise that you devise a naming convention for your network devices and apply an appropriate hostname to each device.

The name must also follow the rules for ARPANET host names. The name must start with a letter, end with a letter or digit, and use only letters, digits, and hyphens. Refer to RFC 1035.

**Example** To set the system name to HQ-Sales, use the command:

```
awplus# configure terminal
awplus(config)# hostname HQ-Sales
```

This changes the prompt to:

```
HQ-Sales(config)#
```

To revert to the default hostname awplus, use the command:

```
HQ-Sales(config)# no hostname
```

This changes the prompt to:

```
awplus(config)#
```

**NOTE:** When AMF is configured, running the **no hostname** command will apply a hostname that is based on the MAC address of the device node, for example, **node\_0000\_5e00\_5301**.

**Related commands** [show system](#)



# max-fib-routes

**Overview** This command enables you to control the maximum number of FIB routes configured. It operates by providing parameters that enable you to configure preset maximums and warning message thresholds.

**NOTE:** For static routes use the *max-static-routes* command.

Use the **no** variant of this command to set the maximum number of FIB routes to the default of 4294967294 FIB routes.

**Syntax** `max-fib-routes <1-4294967294> [<1-100>|warning-only]`  
`no max-fib-routes`

Parameter	Description
<code>max-fib-routes</code>	This is the maximum number of routes that can be stored in the device's Forwarding Information dataBase. In practice, other practical system limits would prevent this maximum being reached.
<code>&lt;1-4294967294&gt;</code>	The allowable configurable range for setting the maximum number of FIB-routes.
<code>&lt;1-100&gt;</code>	This parameter enables you to optionally apply a percentage value. This percentage will be based on the maximum number of FIB routes you have specified. This will cause a warning message to appear when your routes reach your specified percentage value. Routes can continue to be added until your configured maximum value is reached.
<code>warning-only</code>	This parameter enables you to optionally apply a warning message. If you set this option a warning message will appear if your maximum configured value is reached. Routes can continue to be added until your device reaches either the maximum capacity value of 4294967294, or a practical system limit.

**Default** The default number of FIB routes is the maximum number of FIB routes (4294967294).

**Mode** Global Configuration

**Examples** To set the maximum number of dynamic routes to 2000 and warning threshold of 75%, use the following commands:

```
awplus# config terminal
awplus(config)# max-fib-routes 2000 75
```

# max-static-routes

**Overview** Use this command to set the maximum number of static routes, excluding FIB (Forwarding Information Base) routes.

**NOTE:** For FIB routes use the [max-fib-routes](#) command.

Use the **no** variant of this command to set the maximum number of static routes to the default of 1000 static routes.

**Syntax** `max-static-routes <1-1000>`  
`no max-static-routes`

**Default** The default number of static routes is the maximum number of static routes (1000).

**Mode** Global Configuration

**Example** To reset the maximum number of static routes to the default maximum, use the command:

```
awplus# configure terminal
awplus(config)# no max-static-routes
```

**NOTE:** Static routes are applied before adding routes to the RIB (Routing Information Base). Therefore, rejected static routes will not appear in the running config.

**Related commands** [max-fib-routes](#)

# no debug all

**Overview** This command disables the debugging facility for all features on your device. This stops the device from generating any diagnostic debugging messages.

You can optionally disable the debugging facility for only the given protocol or feature. The features available depend on your device and will be a subset of the features listed in the Syntax section below.

**Syntax** `no debug all [bgp|ipv6|dot1x|nsm|ospf|pim dense-mode|pim sparse-mode|rip|vrrp]`

Parameter	Description
bgp	Turns off all debugging for BGP (Border Gateway Protocol).
dot1x	Turns off all debugging for IEEE 802.1X port-based network access- control.
ipv6	Turns off all debugging for IPv6 (Internet Protocol version 6).
nsm	Turns off all debugging for the NSM (Network Services Module).
ospf	Turns off all debugging for OSPF (Open Shortest Path First).
pim dense-mode	Turns off all debugging for PIM (Protocol Independent Multicast) Dense Mode.
pim sparse-mode	Turns off all debugging for PIM (Protocol Independent Multicast) Sparse Mode.
rip	Turns off all debugging for RIP (Routing Information Protocol).
vrrp	Turns off all debugging for VRRP (Virtual Router Redundancy Protocol).

**Default** The debugging facility is disabled by default.

**Mode** Global Configuration and Privileged Exec

**Example** To disable debugging for all features, use the command:

```
awplus# no debug all
```

To disable all 802.1X debugging, use the command:

```
awplus# no debug all dot1x
```

To disable all IPv6 debugging, use the command:

```
awplus# no debug all ipv6
```

To disable all NSM debugging, use the command:

```
awplus# no debug all nsm
```

To disable all RIP debugging, use the command:

```
awplus# no debug all rip
```

**Related  
commands** [undebug all](#)

**Command  
changes** Version 5.4.7-1.1: RIP parameter added

# reboot

**Overview** This command halts the device and performs a cold restart (also known as reload). It displays a confirmation request before restarting.

**Syntax** `reboot`  
`reload`

**Mode** Privileged Exec

**Usage notes** The **reboot** and **reload** commands perform the same action.

**Examples** To restart the device, use the command:

```
awplus# reboot
reboot system? (y/n): y
```

# reload

**Overview** This command performs the same function as the [reboot](#) command.

# show clock

**Overview** This command displays the system's current configured local time and date. It also displays other clock related information such as timezone and summertime configuration.

**Syntax** show clock

**Mode** User Exec and Privileged Exec

**Example** To display the system's current local time, use the command:

```
awplus# show clock
```

**Output** Figure 7-1: Example output from the **show clock** command for a device using New Zealand time

```
Local Time: Mon, 17 Oct 2016 13:56:06 +1200
UTC Time: Mon, 17 Oct 2016 01:56:06 +0000
Timezone: NZST
Timezone Offset: +12:00
Summer time zone: NZDT
Summer time starts: Last Sunday in September at 02:00:00
Summer time ends: First Sunday in April at 02:00:00
Summer time offset: 60 mins
Summer time recurring: Yes
```

**Table 1:** Parameters in the output of the **show clock** command

Parameter	Description
Local Time	Current local time.
UTC Time	Current UTC time.
Timezone	The current configured timezone name.
Timezone Offset	Number of hours offset to UTC.
Summer time zone	The current configured summertime zone name.
Summer time starts	Date and time set as the start of summer time.
Summer time ends	Date and time set as the end of summer time.
Summer time offset	Number of minutes that summer time is offset from the system's timezone.
Summer time recurring	Whether the device will apply the summer time settings every year or only once.

**Related commands**

- [clock set](#)
- [clock summer-time date](#)
- [clock summer-time recurring](#)
- [clock timezone](#)



# show cpu

**Overview** This command displays a list of running processes with their CPU utilization.

For information on filtering and saving command output, see the [“Getting Started with AlliedWare Plus” Feature Overview and Configuration Guide](#).

**Syntax** `show cpu [sort {thrds|pri|sleep|runtime}]`

Parameter	Description
sort	Changes the sorting order using the following fields. If you do not specify a field, then the list is sorted by percentage CPU utilization.
thrds	Sort by the number of threads.
pri	Sort by the process priority.
sleep	Sort by the average time sleeping.
runtime	Sort by the runtime of the process.

**Mode** User Exec and Privileged Exec

**Examples** To show the CPU utilization of current processes, sorting them by the number of threads the processes are using, use the command:

```
awplus# show cpu sort thrds
```

**Output** Figure 7-2: Example output from **show cpu**

```

CPU averages:
 1 second: 12%, 20 seconds: 2%, 60 seconds: 2%
System load averages:
 1 minute: 0.03, 5 minutes: 0.02, 15 minutes: 0.00
Current CPU load:
 userspace: 6%, kernel: 4%, interrupts: 1% iowaits: 0%

user processes
=====
 pid name          thrds  cpu%   pri state sleep% runtime
1544 hostd          1    2.8    20  run    0    120
1166 exfx           17    1.8    20  sleep  0   3846
1284 aisexec        44    0.9    -2  sleep  0   2606
   1 init            1    0.0    20  sleep  0    120
9772 sh              1    0.0    20  sleep  0     0
9773 corerotate     1    0.0    20  sleep  0     0
  853 syslog-ng      1    0.0    20  sleep  0    356
  859 klogd           1    0.0    20  sleep  0     1
  910 inetd            1    0.0    20  sleep  0     3
  920 portmap         1    0.0    20  sleep  0     0
  931 crond            1    0.0    20  sleep  0     1
1090 openhpid        11    0.0    20  sleep  0    233
1111 hpilogd          1    0.0    20  sleep  0     0
1240 hsl              1    0.0    20  sleep  0     79
1453 authd            1    0.0    20  sleep  0     85
...

```

**Table 2:** Parameters in the output of the **show cpu** command

Parameter	Description
CPU averages	Average CPU utilization for the periods stated.
System load averages	The average number of processes waiting for CPU time for the periods stated.
Current CPU load	Current CPU utilization specified by load types.
pid	Identifier number of the process.
name	A shortened name for the process
thrds	Number of threads in the process.
cpu%	Percentage of CPU utilization that this process is consuming.
pri	Process priority state.
state	Process state; one of "run", "sleep", "zombie", and "dead".

**Table 2:** Parameters in the output of the **show cpu** command (cont.)

Parameter	Description
sleep%	Percentage of time that the process is in the sleep state.
runtime	The time that the process has been running for, measured in jiffies. A jiffy is the duration of one tick of the system timer interrupt.

**Related commands**

- [show memory](#)
- [show memory allocations](#)
- [show memory history](#)
- [show memory pools](#)
- [show process](#)

# show cpu history

**Overview** This command prints a graph showing the historical CPU utilization. For information on filtering and saving command output, see the [“Getting Started with AlliedWare Plus” Feature Overview and Configuration Guide](#).

**Syntax** `show cpu history`

**Mode** User Exec and Privileged Exec

**Usage notes** This command’s output displays three graphs of the percentage CPU utilization:

- per second for the last minute, then
- per minute for the last hour, then
- per 30 minutes for the last 30 hours.

**Examples** To display a graph showing the historical CPU utilization of the device, use the command:

```
awplus# show cpu history
```

**Output** Figure 7-3: Example output from the **show cpu history** command

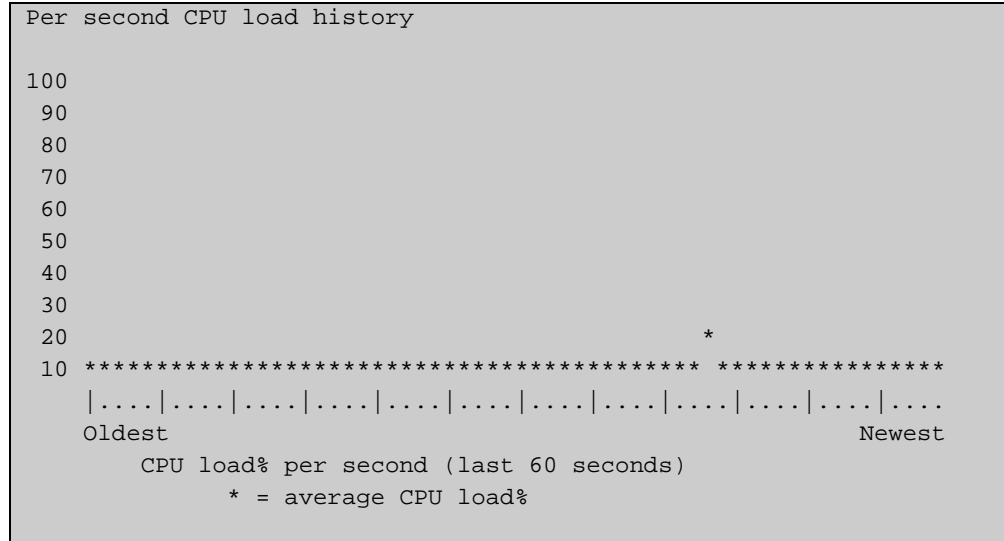

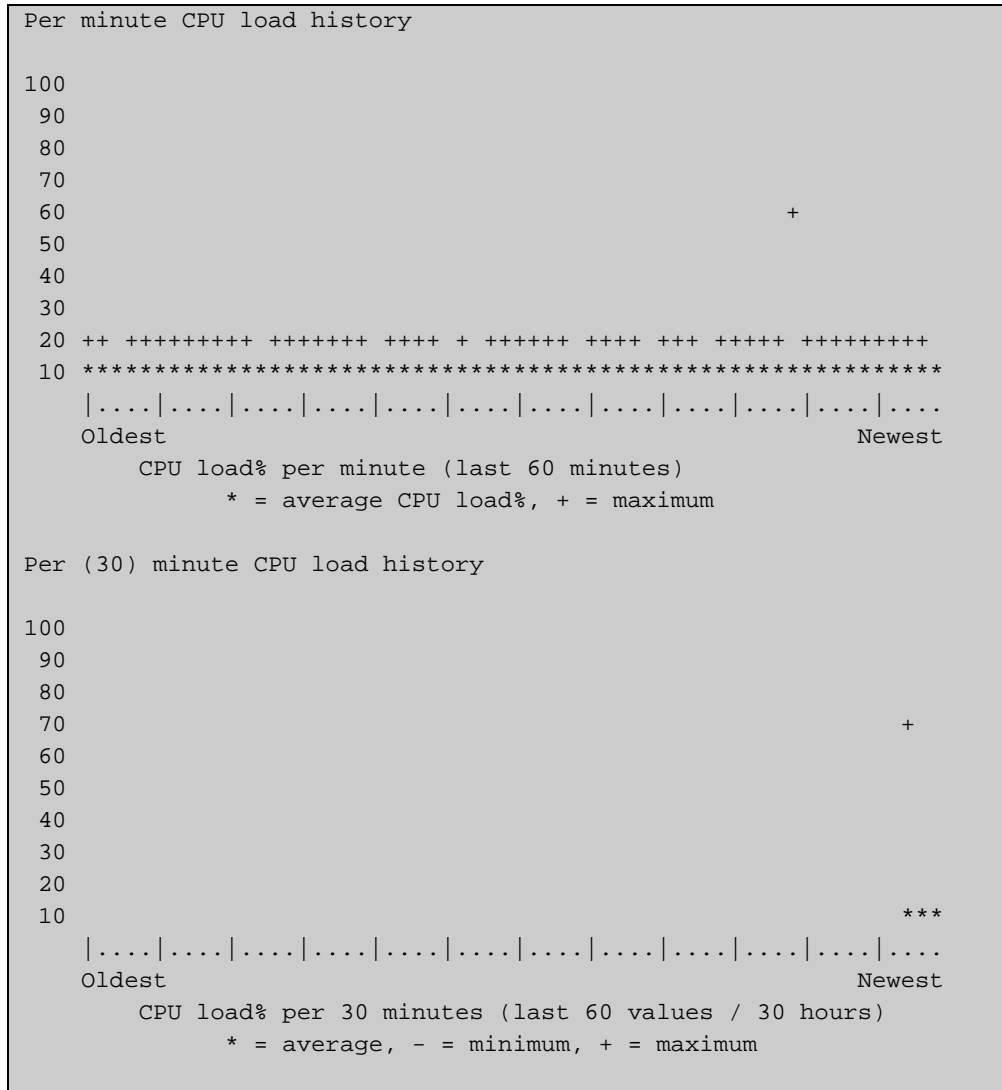

- Related commands**
- [show memory](#)
  - [show memory allocations](#)
  - [show memory pools](#)
  - [show process](#)

# show debugging

**Overview** This command displays all debugging options in alphabetical order, indicating whether debugging is enabled or disabled for each feature.

For information on filtering and saving command output, see the [“Getting Started with AlliedWare Plus” Feature Overview and Configuration Guide](#).

**Syntax** show debugging

**Mode** User Exec and Privileged Exec

**Example** To find out what debugging is enabled, use the command:

```
awplus# show debugging
```

**Output** Figure 7-4: Example output from the **show debugging** command

```
awplus#show debugging
AAA debugging status:
  Authentication debugging is off
  Accounting debugging is off

% DHCP Snooping service is disabled

802.1X debugging status:

EPSR debugging status:
  EPSR Info debugging is off
  EPSR Message debugging is off
  EPSR Packet debugging is off
  EPSR State debugging is off

IGMP Debugging status:
  IGMP Decoder debugging is off
  IGMP Encoder debugging is off
...
```

# show ecofriendly

**Overview** This command displays the switch's eco-friendly configuration status. The `ecofriendly led` configuration status are shown in the `show ecofriendly` output.

**Syntax** `show ecofriendly`

**Mode** Privileged Exec and Global Configuration

**Example** To display the switch's eco-friendly configuration status, use the following command:

```
awplus# show ecofriendly
```

**Output** Figure 7-5: Example output from the `show ecofriendly` command

```
awplus#show ecofriendly
Front panel port LEDs          normal

Energy efficient ethernet
Port      Name          Configured  Status
port1.0.1 Port 1         off         -
port1.0.2          off         off
port1.0.3          off         -
port1.0.4 Port 4         off         -
port1.0.5          off         -
...
```

**Table 3:** Parameters in the output of the `show ecofriendly` command

Parameter	Description
normal	The eco-friendly LED feature is disabled and port LEDs show the current state of the ports. This is the default setting.
off	The eco-friendly LED feature is enabled and power to the port LEDs is disabled.
Port	Displays the port number as assigned by the switch.
Name	Displays the port name if a name is configured for a port number.
Configured	Because LPI is not supported, this entry always shows "off" or a dash (-).
Status	Because LPI is not supported, this entry always shows "off" or a dash (-).

# show interface memory

**Overview** This command displays the shared memory used by either all interfaces, or the specified interface or interfaces. The output is useful for diagnostic purposes by Allied Telesis authorized service personnel.

For information on filtering and saving command output, see the [“Getting Started with AlliedWare Plus” Feature Overview and Configuration Guide](#).

**Syntax** `show interface memory`  
`show interface <port-list> memory`

Parameter	Description
<code>&lt;port-list&gt;</code>	Display information about only the specified port or ports. The port list can be: <ul style="list-style-type: none"><li>• a switchport (e.g. port1.0.4)</li><li>• a static channel group (e.g. sa2)</li><li>• a dynamic (LACP) channel group (e.g. po2)</li><li>• a continuous range of ports separated by a hyphen (e.g. port1.0.1-1.0.4)</li><li>• a comma-separated list (e.g. port1.0.1,port1.0.3-1.0.4). Do not mix port types in the same list.</li></ul>

**Mode** User Exec and Privileged Exec

**Example** To display the shared memory used by all interfaces, use the command:

```
awplus# show interface memory
```

To display the shared memory used by port1.0.1 and port1.0.3 to port1.0.4, use the command:

```
awplus# show interface port1.0.1,port1.0.3-port1.0.4 memory
```

**Output** Figure 7-6: Example output from the **show interface memory** command

```
awplus#show interface memory
Vlan blocking state shared memory usage
-----
Interface    shmid      Bytes Used  natch  Status
port1.0.1    491535     512         1      1
port1.0.2    393228     512         1      1
port1.0.3    557073     512         1      1
...
lo           425997     512         1      1
po1          1179684    512         1      1
po2          1212453    512         1      1
sa3          1245222    512         1      1
```



Figure 7-7: Example output from **show interface <port-list> memory** for a list of interfaces

```
awplus#show interface port1.0.1,port1.0.3-port1.0.4 memory
Vlan blocking state shared memory usage
-----
Interface      shmid      Bytes Used  natch      Status
port1.0.1      589842     512         1          1
port1.0.3      688149     512         1          1
port1.0.4      327690     512         1          1
```

**Related  
commands**

- [show interface brief](#)
- [show interface status](#)
- [show interface switchport](#)

# show memory

**Overview** This command displays the memory used by each process that is currently running. For information on filtering and saving command output, see the [“Getting Started with AlliedWare Plus” Feature Overview and Configuration Guide](#).

**Syntax** `show memory [sort {size|peak|stk}]`

Parameter	Description
sort	Changes the sorting order for the list of processes. If you do not specify this, then the list is sorted by percentage memory utilization.
size	Sort by the amount of memory the process is currently using.
peak	Sort by the amount of memory the process is currently using.
stk	Sort by the stack size of the process.

**Mode** User Exec and Privileged Exec

**Example** To display the memory used by the current running processes, use the command:  
`awplus# show memory`

**Output** Figure 7-8: Example output from **show memory**

```
awplus#show memory sort stk

RAM total: 124384 kB; free: 64236 kB; buffers: 15888 kB

user processes
=====
 pid name          mem%  size(kB)  peak(kB)  data(kB)  stk(kB)  virt(kB)
 490 openhpid      1.5    1988     7480     1308     528     6704
 578 hsl           7.1   8940    29312     5148     312    21052
18986 imish        1.3    1660    13668     3876     172    13668
18931 imish        3.6    4548    13668     3876     172    13668
 576 imi           4.6    5772    14532     4428     144    14532
 572 nsm           4.9    6128    15092     4480     140    15092
 574 hostd        1.6    2048     8116     1876     140     8116
 586 cntrd        2.5    3168    12140     3288     140    12136
 606 sflowd       2.8    3564    12336     3408     140    12336
 610 authd        3.0    3808    12604     3472     140    12604
 616 mstpd        3.1    3856    12652     3480     140    12652
...
```

**Table 4:** Parameters in the output of the **show memory** command

Parameter	Description
RAM total	Total amount of RAM memory free.
free	Available memory size.
buffers	Memory allocated kernel buffers.
pid	Identifier number for the process.
name	Short name used to describe the process.
mem%	Percentage of memory utilization the process is currently using.
size	Amount of memory currently used by the process.
peak	Greatest amount of memory ever used by the process.
data	Amount of memory used for data.
stk	The stack size.

**Related commands**

- [show memory allocations](#)
- [show memory history](#)
- [show memory pools](#)
- [show memory shared](#)

# show memory allocations

**Overview** This command displays the memory allocations used by processes. For information on filtering and saving command output, see the [“Getting Started with AlliedWare Plus” Feature Overview and Configuration Guide](#).

**Syntax** show memory allocations [<process>]

Parameter	Description
<process>	Displays the memory allocation used by the specified process.

**Mode** User Exec and Privileged Exec

**Example** To display the memory allocations used by all processes on your device, use the command:

```
awplus# show memory allocations
```

**Output** Figure 7-9: Example output from the **show memory allocations** command

```
awplus#show memory allocations
Memory allocations for imi
-----

Current 15093760 (peak 15093760)

Statically allocated memory:
- binary/exe           : 1675264
- libraries            : 8916992
- bss/global data     : 2985984
- stack                : 139264

Dynamically allocated memory (heap):
- total allocated      : 1351680
- in use               : 1282440
- non-mmapped         : 1351680
- maximum total allocated : 1351680
- total free space    : 69240
- releasable          : 68968
- space in freed fastbins : 16

Context
      filename:line   allocated   freed
+          lib.c:749     484
.
.
.
```

**Related commands**

- show memory
- show memory history
- show memory pools
- show memory shared
- show tech-support

# show memory history

**Overview** This command prints a graph showing the historical memory usage. For information on filtering and saving command output, see the [“Getting Started with AlliedWare Plus” Feature Overview and Configuration Guide](#).

**Syntax** `show memory history`

**Mode** User Exec and Privileged Exec

**Usage notes** This command’s output displays three graphs of the percentage memory utilization:

- per second for the last minute, then
- per minute for the last hour, then
- per 30 minutes for the last 30 hours.

**Examples** To show a graph displaying the historical memory usage, use the command:

```
awplus# show memory history
```

**Output** Figure 7-10: Example output from the **show memory history** command

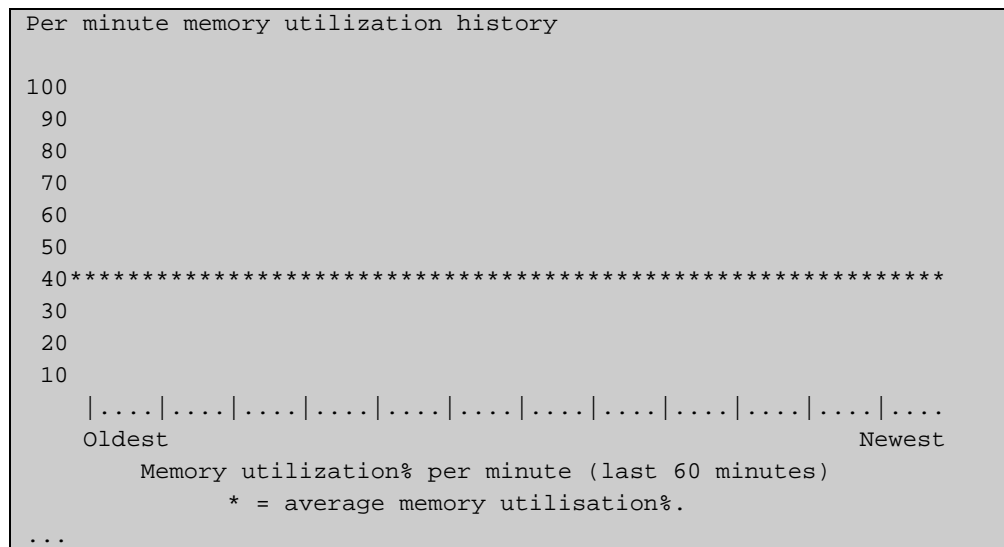

- Related commands**
- [show memory allocations](#)
  - [show memory pools](#)
  - [show memory shared](#)
  - [show tech-support](#)

# show memory pools

**Overview** This command shows the memory pools used by processes.

For information on filtering and saving command output, see the [“Getting Started with AlliedWare Plus” Feature Overview and Configuration Guide](#).

**Syntax** `show memory pools [<process>]`

Parameter	Description
<code>&lt;process&gt;</code>	Displays the memory pools used by the specified process.

**Mode** User Exec and Privileged Exec

**Example** To show the memory pools used by processes, use the command:

```
awplus# show memory pools
```

**Output** Figure 7-11: Example output from the **show memory pools** command

```
awplus#show memory pools
Memory pools for imi
-----

Current 15290368 (peak 15290368)

Statically allocated memory:
- binary/exe           :    1675264
- libraries            :    8916992
- bss/global data     :    2985984
- stack                :    139264

Dynamically allocated memory (heap):
- total allocated      :    1548288
- in use               :    1479816
- non-mmapped          :    1548288
- maximum total allocated :    1548288
- total free space     :     68472
- releasable           :     68200
- space in freed fastbins :      16
.
.
.
```

**Related commands**

- [show memory allocations](#)
- [show memory history](#)
- [show tech-support](#)

# show memory shared

**Overview** This command displays shared memory allocation information. The output is useful for diagnostic purposes by Allied Telesis authorized service personnel.

For information on filtering and saving command output, see the [“Getting Started with AlliedWare Plus” Feature Overview and Configuration Guide](#).

**Syntax** `show memory shared`

**Mode** User Exec and Privileged Exec

**Example** To display information about the shared memory allocation used on the device, use the command:

```
awplus# show memory shared
```

**Output** Figure 7-12: Example output from the **show memory shared** command

```
awplus#show memory shared
Shared Memory Status
-----
Segment allocated   = 39
Pages allocated     = 39
Pages resident      = 11

Shared Memory Limits
-----
Maximum number of segments           = 4096
Maximum segment size (kbytes)        = 32768
Maximum total shared memory (pages)  = 2097152
Minimum segment size (bytes)         = 1
```

**Related commands**

- [show memory allocations](#)
- [show memory history](#)
- [show memory](#)



# show process

**Overview** This command lists a summary of the current running processes.

For information on filtering and saving command output, see the [“Getting Started with AlliedWare Plus” Feature Overview and Configuration Guide](#).

**Syntax** `show process [sort {cpu|mem}]`

Parameter	Description
sort	Changes the sorting order for the list of processes.
cpu	Sorts the list by the percentage of CPU utilization.
mem	Sorts the list by the percentage of memory utilization.

**Mode** User Exec and Privileged Exec

**Usage notes** This command displays a snapshot of currently-running processes. If you want to see CPU or memory utilization history instead, use the commands [show cpu history](#) or [show memory history](#).

**Example** To display a summary of the current running processes, use the command:

```
awplus# show process
```

**Output** Figure 7-13: Example output from the **show process** command

```
CPU averages:
 1 second: 8%, 20 seconds: 5%, 60 seconds: 5%
System load averages:
 1 minute: 0.04, 5 minutes: 0.08, 15 minutes: 0.12
Current CPU load:
 userspace: 9%, kernel: 9%, interrupts: 0% iowaits: 0%
RAM total: 514920 kB; free: 382600 kB; buffers: 16368 kB

user processes
=====
pid name      thrds  cpu%  mem%  pri  state  sleep%
962 pss        12    0     6    25  sleep    5
1  init         1     0     0    25  sleep    0
797 syslog-ng   1     0     0    16  sleep   88
...
kernel threads
=====
pid name      cpu%  pri  state  sleep%
71  aio/0      0    20  sleep  0
3   events/0   0    10  sleep  98
...
```

**Table 5:** Parameters in the output from the **show process** command

Parameter	Description
CPU averages	Average CPU utilization for the periods stated.
System load averages	The average number of processes waiting for CPU time for the periods stated.
Current CPU load	Current CPU utilization specified by load types
RAM total	Total memory size.
free	Available memory.
buffers	Memory allocated to kernel buffers.
pid	Identifier for the process.
name	Short name to describe the process.
thrds	Number of threads in the process.
cpu%	Percentage of CPU utilization that this process is consuming.
mem%	Percentage of memory utilization that this process is consuming.
pri	Process priority.
state	Process state; one of "run", "sleep", "stop", "zombie", or "dead".
sleep%	Percentage of time the process is in the sleep state.

**Related commands** [show cpu](#)  
[show cpu history](#)

# show reboot history

**Overview** Use this command to display the device's reboot history.

**Syntax** show reboot history

**Mode** User Exec and Privileged Exec

**Example** To show the reboot history, use the command:

```
awplus# show reboot history
```

**Output** Figure 7-14: Example output from the **show reboot history** command

```
awplus#show reboot history
<date>      <time>      <type>      <description>
-----
2016-10-10  01:42:04  Expected    User Request
2016-10-10  01:35:31  Expected    User Request
2016-10-10  01:16:25  Unexpected  Rebooting due to critical process (network/nsm)
failure!
2016-10-10  01:11:04  Unexpected  Rebooting due to critical process (network/nsm)
failure!
2016-10-09  19:56:16  Expected    User Request
2016-10-09  19:51:20  Expected    User Request
```

**Table 6:** Parameters in the output from the **show reboot history** command

Parameter	Description
Unexpected	A non-intended reboot.
Expected	A planned or user-triggered reboot.
User request	User initiated reboot via the CLI.

**Related commands** [show tech-support](#)

# show router-id

**Overview** Use this command to show the Router ID of the current system.

**Syntax** `show router-id`

**Mode** User Exec and Privileged Exec

**Example** To display the Router ID of the current system, use the command:

```
awplus# show router-id
```

**Output** Figure 7-15: Example output from the **show router-id** command

```
awplus>show router-id  
Router ID: 10.55.0.2 (automatic)
```

# show system

**Overview** This command displays general system information about the device, including the hardware, memory usage, and software version. It also displays location and contact details when these have been set.

For information on filtering and saving command output, see the [“Getting Started with AlliedWare Plus” Feature Overview and Configuration Guide](#).

**Syntax** `show system`

**Mode** User Exec and Privileged Exec

**Example** To display configuration information, use the command:

```
awplus# show system
```

**Output** Figure 7-16: Example output from **show system**

```
System Status                               Thu May 18 11:45:24 2017
-----
Board      ID  Bay      Board Name                Rev  Serial number
-----
Base      537          AT-GS970M/18             A-0  G27ZFPA06P
-----
RAM:  Total: 511248 kB Free: 402392 kB
Flash: 61.9MB Used: 27.4MB Available: 34.5MB
-----
Environment Status : Normal
Uptime              : 0 days 00:04:24
Bootloader version  : 3.2.1

Current software    : GS970-5.4.7-0.1.rel
Software version    : 5.4.7-0.1
Build date          : Thu Mar 23 21:28:38 UTC 2017

Current boot config: flash:/default.cfg (file exists)

System Name
awplus
System Contact

System Location
```

**Related commands** [show system environment](#)

# show system environment

**Overview** This command displays the current environmental status of your device and any attached PSU, XEM, or other expansion option. The environmental status covers information about temperatures, fans, and voltage.

For information on filtering and saving command output, see the [“Getting Started with AlliedWare Plus” Feature Overview and Configuration Guide](#).

**Syntax** `show system environment`

**Mode** User Exec and Privileged Exec

**Example** To display the system’s environmental status, use the command:

```
awplus# show system environment
```

**Output** Figure 7-17: Example output from **show system environment**

```
awplus#show system environment
Environment Monitoring Status

Overall Status: Normal

Resource ID: 1 Name: AT-GS970M/18
ID Sensor (Units) Reading Low Limit High Limit Status
1 Fan: Fan 1 (Rpm) 3924 2700 - Ok
2 Voltage: 2.5V (Volts) 2.508 2.339 2.859 Ok
3 Voltage: 1.0V (Volts) 1.006 0.896 1.099 Ok
4 Voltage: 3.3V (Volts) 3.338 3.028 3.545 Ok
5 Voltage: 1.5V (Volts) 1.538 1.335 1.649 Ok
6 Voltage: 12.0V (Volts) 11.813 10.767 13.166 Ok
7 Temp: System (Degrees C) 49 -11 73 Ok
```

**Related commands** [show system](#)

# show system interrupts

**Overview** Use this command to display the number of interrupts for each IRQ (Interrupt Request) used to interrupt input lines on a PIC (Programmable Interrupt Controller) on your device.

For information on filtering and saving command output, see the [“Getting Started with AlliedWare Plus” Feature Overview and Configuration Guide](#).

**Syntax** `show system interrupts`

**Mode** User Exec and Privileged Exec

**Example** To display information about the number of interrupts for each IRQ in your device, use the command:

```
awplus# show system interrupts
```

**Output** Figure 7-18: Example output from the **show system interrupts** command

```
awplus#show system interrupts
      CPU0
27:1387835593      GIC Disabled  1  iproc_gtimer
29:           0      GIC Disabled  1  twd
62:           0      GIC Enabled   0  IDM
63:           0      GIC Enabled   0  IDM
64:           0      GIC Enabled   0  IDM
65:           0      GIC Enabled   0  IDM
66:           0      GIC Enabled   0  IDM
67:           0      GIC Enabled   0  IDM
68:           0      GIC Enabled   0  IDM
69:           0      GIC Enabled   0  IDM
70:           0      GIC Enabled   0  IDM
```

**Related commands** [show system environment](#)

# show system mac

**Overview** This command displays the physical MAC address of the device.

**Syntax** `show system mac`

**Mode** User Exec and Privileged Exec

**Example** To display the physical MAC address enter the following command:

```
awplus# show system mac
```

**Output** Figure 7-19: Example output from the **show system mac** command

```
awplus#show system mac  
eccd.6d9d.4eed (system)
```



# show system serialnumber

**Overview** This command shows the serial number information for the device.  
For information on filtering and saving command output, see the [“Getting Started with AlliedWare Plus” Feature Overview and Configuration Guide](#).

**Syntax** `show system serialnumber`

**Mode** User Exec and Privileged Exec

**Example** To display the serial number information for the device, use the command:

```
awplus# show system serialnumber
```

**Output** Figure 7-20: Example output from the **show system serial number** command

```
awplus#show system serialnumber  
45AX5300X
```

# show tech-support

**Overview** This command generates system and debugging information for the device and saves it to a file.

This command is useful for collecting a large amount of information so that it can then be analyzed for troubleshooting purposes. The output of this command can be provided to technical support staff when reporting a problem.

You can optionally limit the command output to display only information for a given protocol or feature. The features available depend on your device and will be a subset of the features listed in the table below.

**Syntax** `show tech-support`  
{[all|atmf|auth|bgp|card|dhcpcsn|epsr|firewall|igmp|ip|ipv6|mld|openflow|ospf|ospf6|pim|rip|ripng|stack|stp|system|tacacs+|update]} [outfile <filename>]

Parameter	Description
all	Display full information
atmf	Display ATMF-specific information
auth	Display authentication-related information
bgp	Display BGP-related information
card	Display Chassis Card specific information
dhcpcsn	Display DHCP Snooping specific information
epsr	Display EPSR specific information
firewall	Display firewall specific information
igmp	Display IGMP specific information
ip	Display IP specific information
ipv6	Display IPv6 specific information
mld	Display MLD specific information
openflow	Display information related to OpenFlow
ospf	Display OSPF related information
ospf6	Display OSPF6 specific information
pim	Display PIM related information
rip	RIP related information
ripng	Display RIPNG specific information
stack	Display stacking device information
stp	Display STP specific information
system	Display general system information

Parameter	Description
tacacs+	Display TACACS+ information
update	Display resource update specific information
	Output modifier
>	Output redirection
>>	Output redirection (append)
outfile	Output file name
<filename>	Specifies a name for the output file. If no name is specified, this file will be saved as: tech-support.txt.gz.

**Default** Captures **all** information for the device.

By default the output is saved to the file 'tech-support.txt.gz' in the current directory. If this file already exists in the current directory then a new file is generated with the time stamp appended to the file name, for example 'tech-support20161009.txt.gz', so the previous file is retained.

**Usage notes** The command generates a large amount of output, which is saved to a file in compressed format. The output file name can be specified by outfile option. If the output file already exists, a new file name is generated with the current time stamp. If the output filename does not end with ".gz", then ".gz" is appended to the filename. Since output files may be too large for Flash on the device we recommend saving files to external memory or a TFTP server whenever possible to avoid device lockup. This method is not likely to be appropriate when running the working set option of AMF across a range of physically separated devices.

**Mode** Privileged Exec

**Examples** To produce the output needed by technical support staff, use the command:

```
awplus# show tech-support
```

# speed (asyn)

**Overview** This command changes the console speed from the device. Note that a change in console speed is applied for subsequent console sessions. Exit the current session to enable the console speed change using the [clear line console](#) command.

**Syntax** `speed <console-speed-in-bps>`

Parameter	Description
<code>&lt;console-speed-in-bps&gt;</code>	Console speed Baud rate in bps (bits per second).
	1200            1200 Baud
	2400            2400 Baud
	9600            9600 Baud
	19200           19200 Baud
	38400           38400 Baud
	57600           57600 Baud
	115200          115200 Baud

**Default** The default console speed baud rate is 9600 bps.

**Mode** Line Configuration

**Usage notes** This command is used to change the console (asyn) port speed. Set the console speed to match the transmission rate of the device connected to the console (asyn) port on your device.

**Example** To set the terminal console (asyn0) port speed from the device to 57600 bps, then exit the session, use the commands:

```
awplus# configure terminal
awplus(config)# line console 0
awplus(config-line)# speed 57600
awplus(config-line)# exit
awplus(config)# exit
awplus# exit
```

Then log in again to enable the change:

```
awplus login:
Password:
awplus>
```

**Related commands**

- clear line console
- line
- show running-config
- show startup-config
- speed

# system territory (deprecated)

**Overview** This command has been deprecated in Software Version 5.4.4-0.1 and later. It now has no effect.

It is no longer useful to specify a system territory, so there is no alternative command.

# terminal monitor

**Overview** Use this command to display debugging output on a terminal.

To display the cursor after a line of debugging output, press the Enter key.

Use the command **terminal no monitor** or **no terminal monitor** to stop displaying debugging output on the terminal. Alternatively, you can use the timeout option to stop displaying debugging output on the terminal after a set time.

**Syntax** terminal monitor [<1-60>]  
terminal no monitor  
no terminal monitor

Parameter	Description
<1-60>	Set a timeout between 1 and 60 seconds for terminal output.

**Default** Disabled

**Mode** User Exec and Privileged Exec

**Examples** To display debugging output on a terminal, enter the command:

```
awplus# terminal monitor
```

To display debugging on the terminal for 60 seconds, enter the command:

```
awplus# terminal monitor 60
```

To stop displaying debugging output on the terminal, use the command:

```
awplus# no terminal monitor
```

**Related commands** All debug commands

**Command changes** Version 5.4.8-0.2: **no terminal monitor** added as an alias for **terminal no monitor**

# undebug all

**Overview** This command applies the functionality of the [no debug all](#) command.



# 8

# Pluggables and Cabling Commands

## Introduction

**Overview** This chapter provides an alphabetical reference of commands used to configure and monitor Pluggables and Cabling, including:

- Cable Fault Locator for finding faults in copper cabling
- Optical Digital Diagnostic Monitoring (DDM) to help find fiber issues when links go down
- Active Fiber Monitoring for detecting changes in optical power received over fiber cables.

For more information, see the [Pluggables and Cabling Feature Overview and Configuration Guide](#).

- Command List**
- “clear fiber-monitoring interface” on page 258
  - “clear test cable-diagnostics tdr” on page 259
  - “debug fiber-monitoring” on page 260
  - “fiber-monitoring action” on page 262
  - “fiber-monitoring baseline” on page 264
  - “fiber-monitoring enable” on page 266
  - “fiber-monitoring interval” on page 267
  - “fiber-monitoring sensitivity” on page 268
  - “show system fiber-monitoring” on page 270
  - “show system pluggable” on page 273
  - “show system pluggable detail” on page 275
  - “show system pluggable diagnostics” on page 278
  - “show test cable-diagnostics tdr” on page 280
  - “test cable-diagnostics tdr interface” on page 281

# clear fiber-monitoring interface

**Overview** Use this command to clear the Active Fiber Monitoring state of a port. It clears the alarm, baseline and history and starts monitoring from the beginning. It does not change the configuration.

**Syntax** `clear fiber-monitoring interface <port>`

Parameter	Description
<code>&lt;port&gt;</code>	The name of the port to reset Active Fiber Monitoring on.

**Default** n/a

**Mode** Privileged Exec

**Usage notes** Normally, you do not need to clear the Active Fiber Monitoring state of a port. If the issue resolves itself and the monitored optical power returns to the baseline, the alarm clears automatically.

However, you may need to clear the Active Fiber Monitoring state if the optical power level reduces for a known reason, causing the port to be stuck in the alarm state. In this situation, the alarm will not clear automatically, because Active Fiber Monitoring does not update the baseline when the port is in the alarm state, for security reasons.

**Example** To clear the Active Fiber Monitoring state for interface port1.0.17, use the command:

```
awplus# clear fiber-monitoring interface port1.0.17
```

**Related commands** [show system fiber-monitoring](#)

**Command changes** Version 5.4.8-0.2: command added

# clear test cable-diagnostics tdr

**Overview** Use this command to clear the results of the last cable test that was run.

**Syntax** `clear test cable-diagnostics tdr`

**Mode** Privileged Exec

**Examples** To clear the results of a previous cable-diagnostics test use the following commands:

```
awplus# clear test cable-diagnostics tdr
```

**Related commands** [show test cable-diagnostics tdr](#)  
[test cable-diagnostics tdr interface](#)

# debug fiber-monitoring

**Overview** Use this command to enable debugging of active fiber monitoring on the specified ports.

Use the **no** variant of this command to disable debugging on all ports or the specified ports.

**Syntax** `debug fiber-monitoring interface <port-list>`  
`no debug fiber-monitoring [interface <port-list>]`

Parameter	Description
<code>&lt;port-list&gt;</code>	The list of fiber ports to enable or disable debugging for, as a single port, a comma separated list or a hyphenated range.

**Default** Debugging of active fiber monitoring is disabled by default.

**Mode** User Exec/Privileged Exec

**Usage** While debugging is enabled by this command for a port, all the optical power readings for the port are sent to the console.

**Example** To enable debugging messages for active fiber monitoring of port1.0.17 to be sent to the console, use the commands:

```
awplus# debug fiber-monitoring interface port1.0.17  
awplus# terminal monitor
```

To disable debugging messages for active fiber monitoring on port1.0.17, use the command:

```
awplus# no debug fiber-monitoring interface port1.0.17
```

To disable all debugging messages for active fiber monitoring, use the command:

```
awplus# no debug fiber-monitoring
```

**Output** Figure 8-1: Example output from **debug fiber-monitoring**

```
awplus#debug fiber-monitoring interface port1.0.17
awplus#terminal monitor
% Warning: Console logging enabled
awplus#01:42:50 awplus Pluggable[522]: Fiber-monitor port2.0.1: Channel:1
Reading:1748 Baseline:1708 Threshold:1356
01:42:52 awplus Pluggable[522]: Fiber-monitor port2.0.1: Channel:1 Reading:1717
Baseline:1709 Threshold:1357
01:42:54 awplus Pluggable[522]: Fiber-monitor port2.0.1: Channel:1 Reading:1780
Baseline:1709 Threshold:1357
01:42:56 awplus Pluggable[522]: Fiber-monitor port2.0.1: Channel:1 Reading:1685
Baseline:1710 Threshold:1358
01:42:58 awplus Pluggable[522]: Fiber-monitor port2.0.1: Channel:1 Reading:1701
Baseline:1710 Threshold:1358
01:43:01 awplus Pluggable[522]: Fiber-monitor port2.0.1: Channel:1 Reading:1733
Baseline:1709 Threshold:1357
```

**Related commands** [show system fiber-monitoring](#)

# fiber-monitoring action

**Overview** Use this command to specify an action to be taken if the optical power received on the port changes from the baseline by the amount specified in the **fiber-monitoring sensitivity** command.

Use the **no** variant of this command to remove the specified action or all actions from the port.

**Syntax** fiber-monitoring action [trap] [shutdown] [continuous]  
no fiber-monitoring action [trap|shutdown]

Parameter	Description
trap	Send an SNMP notification.
shutdown	Shutdown the port.
continuous	Make the action or actions happen continuously (every polling interval) while the sensor is in the alarm state. Otherwise, the action only happens when the alarm is triggered or cleared.

**Default** By default a log message is generated, but no additional action is performed.

**Mode** Interface Configuration mode for a fiber port.

**Usage** If fiber monitoring is enabled and this command is not used to set an action, a change in received power on a fiber port only generates a log message.

**Example** To set the device to send an SNMP trap when port1.0.17 or port1.0.18 receive reduced power and when that reduced-power alarm is cleared, use the commands:

```
awplus(config)# interface port1.0.17-port1.0.18  
awplus(config-if)# fiber-monitoring action trap
```

To set the device to send an SNMP trap when port1.0.17 or port1.0.18 receive reduced power, and every polling interval after that until the alarm is cleared, use the commands:

```
awplus(config)# interface port1.0.17-port1.0.18  
awplus(config-if)# fiber-monitoring action trap continuous
```

To set the device to send an SNMP trap and to shut down the port when port1.0.17 or port1.0.18 receive reduced power, use the commands:

```
awplus(config)# interface port1.0.17-port1.0.18  
awplus(config-if)# fiber-monitoring action trap shutdown
```

To set the device to stop shutting down the port if port1.0.17 or port1.0.18 receive reduced power, use the commands:

```
awplus(config)# interface port1.0.17-port1.0.18  
awplus(config-if)# no fiber-monitoring action shutdown
```

If the device is set to send an SNMP trap for those ports, it will continue to do so.

To set the device not to perform any action when it receives reduced power on port1.0.17 or port1.0.18, except sending a log message, use the commands:

```
awplus(config)# interface port1.0.17-port1.0.18  
awplus(config-if)# no fiber-monitoring action
```

**Related  
commands**

[fiber-monitoring sensitivity](#)  
[show system fiber-monitoring](#)

**Command  
changes**

Version 5.4.8-0.2: **continuous** parameter added

# fiber-monitoring baseline

**Overview** Use this command to configure how the baseline value for comparison is calculated for active fiber monitoring on the port.

Note that alarm generation will not commence until the link has been up for a full averaging period.

Use the **no** variant of this command to set the fiber-monitoring baseline to its default value.

**Syntax** fiber-monitoring baseline average <12-150> [interval <2-86400>]  
fiber-monitoring baseline fixed <1-65535>  
no fiber-monitoring baseline

Parameter	Description
average <12-150>	Set the baseline optical power received to be based on the moving average of the specified number of most recent (non-zero) values. Default is to use this setting and 12 values.
interval <2-86400>	Optionally, specify the optical power polling interval for determining the baseline, in seconds. By default, the baseline polling interval is the same as the monitoring polling interval, which is 5 seconds by default. If specified, this baseline interval should be larger than the monitoring interval. Even if you specify a baseline interval, Active Fiber Monitoring will use the monitoring interval to calculate the initial baseline average. This means the first x baseline readings will be taken at the monitoring interval, where x is the number of readings specified in the <b>average</b> parameter. See Usage below for more information.
fixed <1-65535>	Set the baseline to a fixed level of received optical power in 0.0001mW. Not recommended—see Usage below.

**Default** The default is a moving average of the last 12 values, taken at the same interval as the monitoring interval. The monitoring interval is set using the **fiber-monitoring interval** command. If the monitoring interval is set to its default of 5 seconds, the **fiber-monitoring baseline** default will be the average over the last minute.

**Mode** Interface Configuration for a fiber port

**Usage notes** There are two ways to configure the baseline. The first is to choose a number of readings to average. This is the default and recommended method. The second is to set a fixed value in units of x0.0001mW.

If a fixed value is required, the easiest way to choose a value is to enable fiber monitoring on the port and use the **show system fiber-monitoring** command to see what readings you can expect.



**CAUTION:** *We do not recommend setting a fixed value because gradual change over time caused by temperature fluctuations, etc. could lead to unnecessary alarms.*

If you use the averaging method, you can optionally specify how often Active Fiber Monitoring polls the cable to determine the baseline. This allows Active Fiber Monitoring to update the baseline less often than it polls the device for monitoring.

In order to prevent the theoretical possibility of slow clamping, you can set the baseline interval to a large value, so that the baseline average is only updated with the current reading (for example) once per day or once per hour.

As fiber attenuation can be affected by ambient temperature, take care if changing the baseline interval in environments with large daily temperature fluctuations.

**Example** To set the baseline optical power to a moving average of the last 30 monitoring readings on port1.0.17 and port1.0.18, use the command:

```
awplus(config)# interface port1.0.17-port1.0.18
awplus(config-if)# fiber-monitoring baseline average 30
```

To calculate the baseline based on 12 values taken 24 hours (86400 seconds) apart, instead of using the monitoring interval, use the command:

```
awplus(config)# interface port1.0.17-port1.0.18
awplus(config-if)# fiber-monitoring baseline average 12
interval 86400
```

To set the baseline to its default, averaging the last 12 readings, use the command:

```
awplus(config)# interface port1.0.17-port1.0.18
awplus(config-if)# no fiber-monitoring baseline
```

**Related commands** [fiber-monitoring interval](#)  
[fiber-monitoring sensitivity](#)

**Command changes** Version 5.4.8-0.2: **interval** parameter added

# fiber-monitoring enable

**Overview** Use this command to enable active fiber monitoring on a fiber port. If the port can support fiber monitoring but does not have the correct SFP or fiber type installed, the configuration will be saved, and monitoring will commence when a supported SFP is inserted. Disabling and re-enabling fiber monitoring on a port resets the baseline calculation.

Use the **no** variants of this command to disable active fiber monitoring on the interface, or to remove all the configuration and state for the ports, respectively.

**Syntax** `fiber-monitoring enable`  
`no fiber-monitoring enable`  
`no fiber-monitoring`

**Default** Active fiber monitoring is disabled by default.

**Mode** Interface Configuration mode for a fiber port

**Examples** To enable active fiber monitoring on port1.0.17 and port1.0.18, use the commands:

```
awplus(config)# interface port1.0.17-port1.0.18  
awplus(config-if)# fiber-monitoring enable
```

To disable fiber monitoring on the ports, use the commands:

```
awplus(config)# interface port1.0.17-port1.0.18  
awplus(config-if)# no fiber-monitoring enable
```

To remove all fiber-monitoring configuration and state for the ports, use the commands:

```
awplus(config)# interface port1.0.17-port1.0.18  
awplus(config-if)# no fiber-monitoring
```

**Related commands** [fiber-monitoring action](#)  
[fiber-monitoring sensitivity](#)  
[show system fiber-monitoring](#)

# fiber-monitoring interval

**Overview** Use this command to configure the fiber monitoring polling interval in seconds for the port. The optical power will be read every <interval> seconds and compared against the calculated threshold values to see if a log message or other action is required.

Use the **no** variant of this command to reset the polling interval to the default (5 seconds).

**Syntax** fiber-monitoring interval <2-60>  
no fiber-monitoring interval

Parameter	Description
<2-60>	Optical power polling interval in seconds.

**Default** The interval is set to 5 seconds by default.

**Mode** Interface configuration mode for a fiber port.

**Example** To set the fiber monitoring polling interval for port1.0.17 to 30 seconds, use the commands:

```
awplus(config)# interface port1.0.17  
awplus(config-if)# fiber-monitoring interval 30
```

To reset the fiber monitoring polling interval back to the default (5s), use the commands:

```
awplus(config)# interface port1.0.17  
awplus(config-if)# no fiber-monitoring interval
```

**Related commands** [fiber-monitoring baseline](#)  
[show system fiber-monitoring](#)

# fiber-monitoring sensitivity

**Overview** Use this command to configure the sensitivity of the alarm thresholds on the port for active fiber monitoring.

Use the **no** variant of this command to reset the sensitivity to the default.

**Syntax** `fiber-monitoring sensitivity (low|medium|high|highest|fixed <25-65535>)|relative <0.01-10.0>`  
`no fiber-monitoring sensitivity`

Parameter	Description
low	Low sensitivity (+/-2 dB)
medium	Medium sensitivity (1 dB) (default)
high	High sensitivity (the greater of 0.5 dB and 0.0025 mW)
highest	The highest sensitivity available: 0.0025mW
fixed<25-65535>	Fixed sensitivity at the specified level in 0.0001 mW.
relative <0.01-10.0>	Relative sensitivity at the specified level in dB.

**Default** The default is medium sensitivity.

**Mode** User Exec/Privileged Exec

**Usage** A log message is generated and configured actions are taken if the received optical power drops below the baseline value by the sensitivity configured with this command.

The sensitivity can be configured to one of four pre-defined levels in decibels or to a fixed absolute delta in units of 0.0001mW. The alarm thresholds can be seen in the **show system fiber-monitoring** output. The maximum absolute sensitivity configurable is 0.0025 mW. Note that 0.0025 mW equates to a reduction of approximately 1dB at the maximum attenuation of an AT-SPLX10/1.

**Example** To set the fiber monitoring sensitivity for port1.0.17 to a relative sensitivity of 0.1 dB, use the commands:

```
awplus(config)# interface port1.0.17
awplus(config-if)# fiber-monitoring sensitivity relative 0.1
```

To reset the fiber monitoring sensitivity to the default (medium), use the commands:

```
awplus(config)# interface port1.0.17
awplus(config-if)# no fiber-monitoring sensitivity
```

**Related commands** [fiber-monitoring action](#)  
[fiber-monitoring baseline](#)

`show system fiber-monitoring`

# show system fiber-monitoring

**Overview** Use this command to display settings and current status for Active Fiber Monitoring.

**Syntax** show system fiber-monitoring

**Mode** User Exec and Privileged Exec

**Example** To display configuration and status for active fiber monitoring on ports, use the command:

```
awplus# show system fiber-monitoring
```

**Output** Figure 8-2: Example output from **show system fiber-monitoring**

```
awplus#show sys fiber-monitoring
Fiber Monitoring Status
  Reading units 0.0001mW

Interface port1.0.17
Status:          enabled
Supported:       Supported pluggable
Debugging:       disabled
Interval:        2 seconds
Sensitivity:     1.00dB
Baseline type:   average of last 35 values greater than 50
Status:
  Baseline value: 496
  Alarm threshold: 393
  Alarm:          no
  Last 12 Readings: 498 498 498 498 498 498 498 498 498 498 498 498
  Minimum reading: 486
  Maximum reading: 498

Interface port1.0.18
Status:          enabled
Supported:       Supported pluggable
Debugging:       disabled
Interval:        2 seconds
Sensitivity:     1.00dB
Baseline type:   average of last 30 values greater than 50
Status:
  Baseline value: 0
  Alarm threshold: 0
  Alarm:          no
  Last 12 Readings: 0 0 0 0 0 0 0 0 0 0 0 0
  Minimum reading: 0
  Maximum reading: 0
```

Table 8-1: Parameters in the output from **show system fiber-monitoring**

Parameter	Description
Reading units	The units for optical power readings in the rest of the display, e.g. 0.0001mW.
Status	Whether active fiber monitoring is enabled or disabled for this port.
Supported	Whether the pluggable inserted in this port supports active fiber monitoring.
Debugging	Whether debugging of active fiber monitoring is enabled or disabled for this port.
Interval	The configured interval between readings of optical power on this port.
Sensitivity	The configured sensitivity threshold for optical power changes on this port.
Baseline type	How the baseline optical power level is calculated: either the average of the specified number of previous readings or a specified fixed value in 0.0001mW.
Status	Current values for the following parameters.
Baseline value	The baseline value, calculated according to the configured baseline method, in 0.0001mW.
Alarm threshold	The current threshold for a change in optical power, calculated according to the configured sensitivity method, that will result in action.
Alarm	Whether the optical power at the most recent reading fallen below the threshold.
Last 12 readings	The last 12 optical power values measured, in 0.0001mW, with oldest value first.
Minimum reading	The lowest optical power reading since the fiber pluggable was last inserted, or since active fiber monitoring was last enabled on the port.
Maximum reading	The highest optical power reading since the fiber pluggable was last inserted, or since active fiber monitoring was last enabled on the port.

**Related commands**

- [debug fiber-monitoring](#)
- [fiber-monitoring action](#)
- [fiber-monitoring baseline](#)
- [fiber-monitoring enable](#)

fiber-monitoring interval

fiber-monitoring sensitivity



# show system pluggable

**Overview** This command displays **brief** pluggable transceiver information showing the pluggable type, the pluggable serial number, and the pluggable port on the device. Different types of pluggable transceivers are supported in different models of device. See your Allied Telesis dealer for more information about the models of pluggables that your device supports.

**Syntax** `show system pluggable [<port-list>]`

Parameter	Description
<port-list>	The ports to display information about. The port list can be: <ul style="list-style-type: none"><li>• a switch port (e.g. port1.0.17)</li><li>• a continuous range of ports separated by a hyphen (e.g. portport1.0.17-port1.0.18)</li><li>• a comma-separated list of ports and port ranges (e.g. port1.0.17,port1.0.18)</li></ul>

**Mode** User Exec and Privileged Exec

**Example** To display brief information about all installed pluggable transceivers, use the command:

```
awplus# show system pluggable
```

**Output** Figure 8-3: Example output from **show system pluggable**

```
awplus#show system pluggable
System Pluggable Information

Port      Vendor      Device      Serial Number  Datecode Type
-----
port1.0.17  ATI        AT-SPSX    A03240R151300867  15032801  1000BASE-SX
port1.0.18  ATI        AT-SPSX    A03240R111800076  15032801  1000BASE-SX
-----
```

**Table 9:** Parameters in the output from the **show system pluggable** command

Parameter	Description
Port	Specifies the port number for the installed pluggable transceiver.
Vendor	Specifies the vendor's name for the installed pluggable transceiver.
Device	Specifies the device name for the installed pluggable transceiver.

**Table 9:** Parameters in the output from the **show system pluggable** command

Parameter	Description
Serial Number	Specifies the serial number for the installed pluggable transceiver.
Datecode	Specifies the manufacturing datecode for the installed pluggable transceiver. Checking the manufacturing datecode with the vendor may be useful when determining Laser Diode aging issues. For more information, see "Troubleshooting Fiber and Pluggable Issues" in the "Pluggables and Cabling" <a href="#">Feature Overview and Configuration Guide</a> .
Type	Specifies the device type for the installed pluggable transceiver.

- Related commands**
- [show system environment](#)
  - [show system pluggable detail](#)
  - [show system pluggable diagnostics](#)

# show system pluggable detail

**Overview** This command displays detailed pluggable transceiver information showing the pluggable type, the pluggable serial number, and the pluggable port on the device. Different types of pluggable transceivers are supported in different models of device. See your Allied Telesis dealer for more information about the models of pluggables that your device supports.

For information on filtering and saving command output, see the [“Getting Started with AlliedWare Plus” Feature Overview and Configuration Guide](#).

**Syntax** `show system pluggable [<port-list>] detail`

Parameter	Description
<code>&lt;port-list&gt;</code>	The ports to display information about. The port list can be: <ul style="list-style-type: none"><li>• a switch port (e.g. port1.0.17)</li><li>• a continuous range of ports separated by a hyphen (e.g. portport1.0.17-port1.0.18)</li><li>• a comma-separated list of ports and port ranges (e.g. port1.0.17,port1.0.18)</li></ul>

**Mode** User Exec and Privileged Exec

**Usage notes** In addition to the information about pluggable transceivers displayed using the `show system pluggable` command (port, manufacturer, serial number, manufacturing datecode, and type information), the **show system pluggable detail** command displays the following information:

- **SFP Laser Wavelength:** Specifies the laser wavelength of the installed pluggable transceiver
- **Single mode Fiber:** Specifies the link length supported by the pluggable transceiver using single mode fiber
- **OM1 (62.5µ m) Fiber:** Specifies the link length, in meters (m) or kilometers (km) supported by the pluggable transceiver using 62.5 micron multi-mode fiber.
- **OM2 (50µ m) Fiber:** Specifies the link length (in meters or kilometers) supported by the pluggable transceiver using 50 micron multi-mode fiber.
- **Diagnostic Calibration:** Specifies whether the pluggable transceiver supports DDM or DOM Internal or External Calibration.
  - **Internal** is displayed if the pluggable transceiver supports DDM or DOM Internal Calibration.
  - **External** is displayed if the pluggable transceiver supports DDM or DOM External Calibration.
  - a dash (-) is displayed if neither Internal Calibration or External Calibration is supported.

- **Power Monitoring:** Displays the received power measurement type, which can be either **OMA**(Optical Module Amplitude) or **Avg**(Average Power) measured in  $\mu$ W.

**NOTE:** For parameters that are not supported or not specified, a hyphen is displayed instead.

**Example** To display detailed information about the pluggable transceivers installed in a particular port on the device, use a command like:

```
awplus# show system pluggable port1.0.17 detail
```

To display detailed information about all the pluggable transceivers installed on the device, use the command:

```
awplus# show system pluggable detail
```

**Output** Figure 8-4: Example output from **show system pluggable detail** for a port

```
awplus#show system pluggable port1.0.17 detail
System Pluggable Information Detail
port1.0.17
=====
Vendor Name:                ATI
Device Name:                AT-SPSX
Device Revision:            A
Device Type:                1000BASE-SX
Serial Number:              A02420N0607J0023
Manufacturing Datecode:    060704
SFP Laser Wavelength:     850nm
Link Length Supported
  Single Mode Fiber :      -
  OM1 (62.5um) Fiber:     150m
  OM2 (50um) Fiber :      300m
  OM3 (50um) Fiber :      -
Diagnostic Calibration:     External
Power Monitoring:          Average
```

Table 8-1: Parameters in the output from **show system pluggable detail**

Parameter	Description
Port	Specifies the port the pluggable transceiver is installed in.
Vendor Name	Specifies the vendor’s name for the installed pluggable transceiver.
Device Name	Specifies the device name for the installed pluggable transceiver.
Device Revision	Specifies the hardware revision code for the pluggable transceiver. This may be useful for troubleshooting because different devices may support different pluggable transceiver revisions.

Table 8-1: Parameters in the output from **show system pluggable detail** (cont.)

Parameter	Description
Device Type	Specifies the device type for the installed pluggable transceiver.
Serial Number	Specifies the serial number for the installed pluggable transceiver.
Manufacturing Datecode	Specifies the manufacturing datecode for the installed pluggable transceiver. Checking the manufacturing datecode with the vendor may be useful when determining Laser Diode aging issues. For more information, see "Troubleshooting Fiber and Pluggable Issues" in the "Pluggables and Cabling" <a href="#">Feature Overview and Configuration Guide</a> .
SFP Laser Wavelength	Specifies the laser wavelength of the installed pluggable transceiver.
Single Mode Fiber	Specifies the link length supported by the pluggable transceiver using single mode fiber.
OM1 (62.5um) Fiber	Specifies the link length (in $\mu\text{m}$ - micron) supported by the pluggable transceiver using 62.5 micron multi-mode fiber.
OM2 (50um) Fiber	Specifies the link length (in $\mu\text{m}$ - micron) supported by the pluggable transceiver using 50 micron multi-mode fiber.
Diagnostic Calibration	Specifies whether the pluggable transceiver supports DDM or DOM Internal or External Calibration: <b>Internal</b> is displayed if the pluggable transceiver supports DDM or DOM Internal Calibration. <b>External</b> is displayed if the pluggable transceiver supports DDM or DOM External Calibration. - is displayed if neither Internal Calibration or External Calibration is supported.
Power Monitoring	Displays the received power measurement type, which can be either <b>OMA</b> (Optical Module Amplitude) or <b>Avg</b> (Average Power) measured in $\mu\text{W}$ .

**Related commands**

- [show system environment](#)
- [show system pluggable](#)
- [show system pluggable diagnostics](#)

# show system pluggable diagnostics

**Overview** This command displays diagnostic information about pluggable transceivers that support Digital Diagnostic Monitoring (DDM).

Different types of pluggable transceivers are supported in different models of device. See your device's Datasheet for more information about the models of pluggables that your device supports.

For information on filtering and saving command output, see the ["Getting Started with AlliedWare Plus" Feature Overview and Configuration Guide](#).

**Syntax** `show system pluggable [<port-list>] diagnostics`

Parameter	Description
<code>&lt;port-list&gt;</code>	The ports to display information about. The port list can be: <ul style="list-style-type: none"><li>• a switch port (e.g. port1.0.17)</li><li>• a continuous range of ports separated by a hyphen (e.g. portport1.0.17-port1.0.18)</li><li>• a comma-separated list of ports and port ranges (e.g. port1.0.17,port1.0.18)</li></ul>

**Mode** User Exec and Privileged Exec

**Usage notes** Diagnostic monitoring features allow you to monitor real-time parameters of the pluggable transceiver, such as optical output power, optical input power, temperature, laser bias current, and transceiver supply voltage. Additionally, RX LOS (Loss of Signal) is shown when the received optical level is below a preset threshold. Monitor these parameters to check on the health of all transceivers, selected transceivers or a specific transceiver installed in a device.

**Examples** To display detailed information about all pluggable transceivers installed on a standalone device, use the command:

```
awplus# show system pluggable diagnostics
```

**Output** Figure 8-5: Example output from the **show system pluggable diagnostics** command on a device

```
awplus#show system pluggable diagnostics

System Pluggable Information Diagnostics

port1.0.17          Status          Alarms          Warnings
                   Reading      Alarm           Max      Min      Warning      Max      Min
Temp: (Degrees C)  44.871      -      100.00  -40.00      -      95.000  -30.00
Vcc: (Volts)       3.3043      -      3.4650  3.1350      -      3.4000  3.2000
Tx Bias: (mA)      3.468       -      13.264  0.000       -      10.264  0.264
Tx Power: (mW)     0.2376      -      0.7943  0.0562      -      0.6310  0.0708
Rx Power: (mW)     0.2104      -      1.0000  0.0126      -      0.7943  0.0200
Rx LOS:           Rx Up

...
```

**Table 9:** Parameters in the output from the **show system pluggables diagnostics** command

Parameter	Description
Temp (Degrees C)	Shows the temperature inside the transceiver.
Vcc (Volts)	Shows voltage supplied to the transceiver.
Tx Bias (mA)	Shows current to the Laser Diode in the transceiver.
Tx Power (mW)	Shows the amount of light transmitted from the transceiver.
Rx Power (mW)	Shows the amount of light received in the transceiver.
Rx LOS	Rx Loss of Signal. This indicates whether: <ul style="list-style-type: none"> <li>light is being received (Rx Up) and therefore the link is up, or</li> <li>light is not being received (Rx Down) and therefore the link is down</li> </ul>

- Related commands**
- [show system environment](#)
  - [show system pluggable](#)
  - [show system pluggable detail](#)

# show test cable-diagnostics tdr

**Overview** Use this command to display the results of the last cable-diagnostics test that was run using the TDR (Time Domain Reflectometer) on a fixed copper cable port.

The displayed status of the cable can be either:

- OK
- Open
- Short (within-pair)
- Short (across-pair)
- Error

**Syntax** `show test cable-diagnostics tdr`

**Mode** Privileged Exec

**Examples** To show the results of a cable-diagnostics test use the following command:

```
awplus# show test cable-diagnostics tdr
```

**Output** Figure 8-6: Example output from the **show test cable-diagnostics tdr** command

Port	Pair	Length	Status
1.0.1	A	-	OK
	B	-	OK
	C	-	OK
	D	-	OK

**Related commands** [clear test cable-diagnostics tdr](#)  
[test cable-diagnostics tdr interface](#)



# test cable-diagnostics tdr interface

**Overview** Use this command to apply the Cable Fault Locator's cable-diagnostics tests to twisted pair data cables for a selected port. The tests will detect either correct, short circuit, or open, circuit terminations. For more information on running the CFL, see the [Pluggables and Cabling Feature Overview and Configuration Guide](#).

The test can take several seconds to complete. See the related show command to display the test results.

A new test can only be started if no other test is in progress. CFL cannot run on a port that is currently supplying power via PoE.

The displayed status of the cable can be either, OK, Short (within-pair), or Open. The "Open" or "Short" status is accompanied with the distance from the source port to the incorrect termination.

**Syntax** test cable-diagnostics tdr interface <interface>

Parameter	Description
cable-diagnostics	The cable diagnostic tests.
tdr	Time Domain Reflectometry.
interface	Selects the interface to test.
<interface>	Interface number of the port to be tested, e.g. port1.0.2.

**Mode** Privileged Exec

**Example** To run a cable test on the cable inserted into port1.0.1 use the following command:

```
awplus# test cable-diagnostics tdr interface port1.0.1
```

You will receive the following message:

```
Link will go down while test is in progress. Continue? (y/n): y  
Select y to continue.
```

```
awplus# y
```

You will then receive the following message:

```
Test started. This will take several seconds to complete. Use  
"show test cable-diagnostics tdr" to print results.
```

**Related commands** [clear test cable-diagnostics tdr](#)  
[show test cable-diagnostics tdr](#)

# 9

# Logging Commands

## Introduction

**Overview** This chapter provides an alphabetical reference of commands used to configure logging. See the [Logging Feature Overview and Configuration Guide](#) for more information about the different types of log and how to filter log messages.

- Command List**
- [“clear exception log”](#) on page 284
  - [“clear log”](#) on page 285
  - [“clear log buffered”](#) on page 286
  - [“clear log external”](#) on page 287
  - [“clear log permanent”](#) on page 288
  - [“copy buffered-log”](#) on page 289
  - [“copy permanent-log”](#) on page 290
  - [“default log buffered”](#) on page 291
  - [“default log console”](#) on page 292
  - [“default log email”](#) on page 293
  - [“default log external”](#) on page 294
  - [“default log host”](#) on page 295
  - [“default log monitor”](#) on page 296
  - [“default log permanent”](#) on page 297
  - [“log buffered”](#) on page 298
  - [“log buffered \(filter\)”](#) on page 299
  - [“log buffered exclude”](#) on page 302
  - [“log buffered size”](#) on page 305
  - [“log console”](#) on page 306

- [“log console \(filter\)”](#) on page 307
- [“log console exclude”](#) on page 310
- [“log email”](#) on page 313
- [“log email \(filter\)”](#) on page 314
- [“log email exclude”](#) on page 317
- [“log email time”](#) on page 320
- [“log external”](#) on page 322
- [“log external \(filter\)”](#) on page 324
- [“log external exclude”](#) on page 327
- [“log external rotate”](#) on page 330
- [“log external size”](#) on page 332
- [“log facility”](#) on page 333
- [“log host”](#) on page 335
- [“log host \(filter\)”](#) on page 337
- [“log host exclude”](#) on page 340
- [“log host source”](#) on page 343
- [“log host startup-delay”](#) on page 344
- [“log host time”](#) on page 346
- [“log monitor \(filter\)”](#) on page 348
- [“log monitor exclude”](#) on page 351
- [“log permanent”](#) on page 354
- [“log permanent \(filter\)”](#) on page 355
- [“log permanent exclude”](#) on page 358
- [“log permanent size”](#) on page 361
- [“log-rate-limit nsm”](#) on page 362
- [“log trustpoint”](#) on page 363
- [“show counter log”](#) on page 364
- [“show exception log”](#) on page 365
- [“show log”](#) on page 366
- [“show log config”](#) on page 368
- [“show log external”](#) on page 370
- [“show log permanent”](#) on page 371
- [“show running-config log”](#) on page 372
- [“unmount”](#) on page 373

# clear exception log

**Overview** This command resets the contents of the exception log, but does not remove the associated core files.

**Syntax** `clear exception log`

**Mode** Privileged Exec

**Example** `awplus# clear exception log`

# clear log

**Overview** This command removes the contents of the buffered and permanent logs.

**Syntax** `clear log`

**Mode** Privileged Exec

**Example** To delete the contents of the buffered and permanent log use the command:

```
awplus# clear log
```

**Related commands**

- [clear log buffered](#)
- [clear log permanent](#)
- [show log](#)

# clear log buffered

**Overview** This command removes the contents of the buffered log.

**Syntax** `clear log buffered`

**Mode** Privileged Exec

**Example** To delete the contents of the buffered log use the following commands:

```
awplus# clear log buffered
```

**Related commands**

- [default log buffered](#)
- [log buffered](#)
- [log buffered \(filter\)](#)
- [log buffered size](#)
- [log buffered exclude](#)
- [show log](#)
- [show log config](#)

# clear log external

**Overview** Use this command to delete the external log file from the SD card it is stored on. If the external log is rotating between multiple files, this command deletes all those files, not just the most recent one.

**Syntax** `clear log external`

**Mode** Privileged Exec

**Example** To delete the external log file, use the command:

```
awplus# clear log external
```

**Related commands**

- [default log external](#)
- [log external](#)
- [log external \(filter\)](#)
- [log external exclude](#)
- [log external rotate](#)
- [log external size](#)
- [show log config](#)
- [show log external](#)
- [unmount](#)

**Command changes** Version 5.4.7-1.1: command added

# clear log permanent

**Overview** This command removes the contents of the permanent log.

**Syntax** `clear log permanent`

**Mode** Privileged Exec

**Example** To delete the contents of the permanent log use the following commands:

```
awplus# clear log permanent
```

**Related commands**

- [default log permanent](#)
- [log permanent](#)
- [log permanent \(filter\)](#)
- [log permanent exclude](#)
- [log permanent size](#)
- [show log config](#)
- [show log permanent](#)



# copy buffered-log

**Overview** Use this command to copy the buffered log to an internal or external destination.

**Syntax** `copy buffered-log <destination-name>`

Parameter	Description
<code>&lt;destination-name&gt;</code>	The filename and path for the destination file. See <a href="#">Introduction</a> on page 80 for valid syntax.

**Mode** Privileged Exec

**Example** To copy the buffered log file into a folder in Flash named "buffered-log" and name the file "buffered-log.log", use the command:

```
awplus# copy buffered-log flash:/buffered-log/buffered-log.log
```

To copy the buffered log file onto an SD card and name the file "buffered-log.log", use the command:

```
awplus# copy buffered-log card:/buffered-log.log
```

**Related commands**

- [log buffered](#)
- [show file systems](#)
- [show log](#)

**Command changes** Version 5.4.7-1.1: command added

# copy permanent-log

**Overview** Use this command to copy the permanent log to an internal or external destination.

**Syntax** `copy permanent-log <destination-name>`

Parameter	Description
<code>&lt;destination-name&gt;</code>	The filename and path for the destination file. See <a href="#">Introduction</a> on page 80 for valid syntax.

**Mode** Privileged Exec

**Example** To copy the permanent log file into a folder in Flash named “perm-log” and name the file “permanent-log.log”, use the command:

```
awplus# copy permanent-log flash:/perm-log/permanent-log.log
```

To copy the permanent log file onto an SD card and name the file “permanent-log.log”, use the command:

```
awplus# copy permanent-log card:/permanent-log.log
```

**Related commands**

- [log permanent](#)
- [show file systems](#)
- [show log permanent](#)

**Command changes** Version 5.4.7-1.1: command added

# default log buffered

**Overview** This command restores the default settings for the buffered log stored in RAM. By default the size of the buffered log is 50 kB and it accepts messages with the severity level of “warnings” and above.

**Syntax** `default log buffered`

**Default** The buffered log is enabled by default.

**Mode** Global Configuration

**Example** To restore the buffered log to its default settings use the following commands:

```
awplus# configure terminal
awplus(config)# default log buffered
```

**Related commands**

- [clear log buffered](#)
- [log buffered](#)
- [log buffered \(filter\)](#)
- [log buffered size](#)
- [log buffered exclude](#)
- [show log](#)
- [show log config](#)

# default log console

**Overview** This command restores the default settings for log messages sent to the terminal when a `log console` command is issued. By default all messages are sent to the console when a **log console** command is issued.

**Syntax** `default log console`

**Mode** Global Configuration

**Example** To restore the log console to its default settings use the following commands:

```
awplus# configure terminal
awplus(config)# default log console
```

**Related commands**

- `log console`
- `log console (filter)`
- `log console exclude`
- `show log config`

# default log email

**Overview** This command restores the default settings for log messages sent to an email address. By default no filters are defined for email addresses. Filters must be defined before messages will be sent. This command also restores the remote syslog server time offset value to local (no offset).

**Syntax** `default log email <email-address>`

Parameter	Description
<code>&lt;email-address&gt;</code>	The email address to send log messages to

**Mode** Global Configuration

**Example** To restore the default settings for log messages sent to the email address `admin@alliedtelesis.com` use the following commands:

```
awplus# configure terminal
awplus(config)# default log email admin@alliedtelesis.com
```

**Related commands**

- [log email](#)
- [log email \(filter\)](#)
- [log email exclude](#)
- [log email time](#)
- [show log config](#)

# default log external

**Overview** Use this command to restore the default settings for the external log. By default, the size of the external log is 50 kB, it rotates through 1 additional file, and it accepts messages with a severity level of notices and above.

Note that this command does not clear the configured filename for the external log.

**Syntax** `default log external`

**Mode** Global Configuration

**Example** To restore the default settings for the external log, use the commands:

```
awplus# configure terminal
awplus(config)# default log external
```

**Related commands**

- [clear log external](#)
- [log external](#)
- [log external \(filter\)](#)
- [log external exclude](#)
- [log external rotate](#)
- [log external size](#)
- [show log config](#)
- [show log external](#)
- [unmount](#)

**Command changes** Version 5.4.7-1.1: command added

# default log host

**Overview** This command restores the default settings for log sent to a remote syslog server. By default no filters are defined for remote syslog servers. Filters must be defined before messages will be sent. This command also restores the remote syslog server time offset value to local (no offset).

**Syntax** `default log host <ip-addr>`

Parameter	Description
<code>&lt;ip-addr&gt;</code>	The IP address of a remote syslog server

**Mode** Global Configuration

**Example** To restore the default settings for messages sent to the remote syslog server with IP address 10.32.16.21 use the following commands:

```
awplus# configure terminal
awplus(config)# default log host 10.32.16.21
```

**Related commands**

- [log host](#)
- [log host \(filter\)](#)
- [log host exclude](#)
- [log host source](#)
- [log host time](#)
- [show log config](#)

# default log monitor

**Overview** This command restores the default settings for log messages sent to the terminal when a [terminal monitor](#) command is used.

**Syntax** `default log monitor`

**Default** All messages are sent to the terminal when a [terminal monitor](#) command is used.

**Mode** Global Configuration

**Example** To restore the log monitor to its default settings use the following commands:

```
awplus# configure terminal
awplus(config)# default log monitor
```

**Related commands**

- [log monitor \(filter\)](#)
- [log monitor exclude](#)
- [show log config](#)
- [terminal monitor](#)



# default log permanent

**Overview** This command restores the default settings for the permanent log stored in Flash. By default, the size of the permanent log is 50 kB and it accepts messages with the severity level of warnings and above.

**Syntax** `default log permanent`

**Default** The permanent log is enabled by default.

**Mode** Global Configuration

**Example** To restore the permanent log to its default settings use the following commands:

```
awplus# configure terminal
awplus(config)# default log permanent
```

**Related commands**

- [clear log permanent](#)
- [log permanent](#)
- [log permanent \(filter\)](#)
- [log permanent exclude](#)
- [log permanent size](#)
- [show log config](#)
- [show log permanent](#)

# log buffered

**Overview** This command configures the device to store log messages in RAM. Messages stored in RAM are not retained on the device over a restart. Once the buffered log reaches its configured maximum allowable size old messages will be deleted to make way for new ones.

**Syntax** `log buffered`  
`no log buffered`

**Default** The buffered log is configured by default.

**Mode** Global Configuration

**Examples** To configured the device to store log messages in RAM use the following commands:

```
awplus# configure terminal
awplus(config)# log buffered
```

To configure the device to not store log messages in a RAM buffer use the following commands:

```
awplus# configure terminal
awplus(config)# no log buffered
```

**Related commands**

- [clear log buffered](#)
- [copy buffered-log](#)
- [default log buffered](#)
- [log buffered \(filter\)](#)
- [log buffered size](#)
- [log buffered exclude](#)
- [show log](#)
- [show log config](#)

# log buffered (filter)

**Overview** Use this command to create a filter to select messages to be sent to the buffered log. Selection can be based on the priority/ severity of the message, the program that generated the message, the logging facility used, a sub-string within the message or a combination of some or all of these.

The **no** variant of this command removes the corresponding filter, so that the specified messages are no longer sent to the buffered log.

**Syntax** `log buffered [level <level>] [program <program-name>] [facility <facility>] [msgtext <text-string>]`  
`no log buffered [level <level>] [program <program-name>] [facility <facility>] [msgtext <text-string>]`

Parameter	Description
level	Filter messages to the buffered log by severity level.
<level>	The minimum severity of message to send to the buffered log. The level can be specified as one of the following numbers or level names, where 0 is the highest severity and 7 is the lowest severity:
0   emergencies	System is unusable
1   alerts	Action must be taken immediately
2   critical	Critical conditions
3   errors	Error conditions
4   warnings	Warning conditions
5   notices	Normal, but significant, conditions
6   informational	Informational messages
7   debugging	Debug-level messages
program	Filter messages to the buffered log by program. Include messages from a specified program in the buffered log.
<program-name>	The name of a program to log messages from. You can enter either one of the following predefined program names (depending on your device model), or another program name that you find in the log output. The pre-defined names are not case sensitive but other program names from the log output are.
rip	Routing Information Protocol (RIP)
ripng	Routing Information Protocol - next generation (RIPng)
ospf	Open Shortest Path First (OSPF)
ospfv3	Open Shortest Path First (OSPF) version 3 (OSPFv3)
bgp	Border Gateway Protocol (BGP)
rsvp	Resource Reservation Protocol (RSVP)
pim-dm	Protocol Independent Multicast - Dense Mode (PIM-DM)

Parameter	Description
<code>pim-sm</code>	Protocol Independent Multicast - Sparse Mode (PIM-SM)
<code>pim-smv6</code>	PIM-SM version 6 (PIM-SMv6)
<code>dot1x</code>	IEEE 802.1X Port-Based Access Control
<code>lacp</code>	Link Aggregation Control Protocol (LACP)
<code>stp</code>	Spanning Tree Protocol (STP)
<code>rstp</code>	Rapid Spanning Tree Protocol (RSTP)
<code>mstp</code>	Multiple Spanning Tree Protocol (MSTP)
<code>imi</code>	Integrated Management Interface (IMI)
<code>imish</code>	Integrated Management Interface Shell (IMISH)
<code>epsr</code>	Ethernet Protection Switched Rings (EPSR)
<code>irdp</code>	ICMP Router Discovery Protocol (IRDP)
<code>rmon</code>	Remote Monitoring
<code>loopprot</code>	Loop Protection
<code>poe</code>	Power-inline (Power over Ethernet)
<code>dhcpsn</code>	DHCP snooping (DHCP SN)
<code>facility</code>	Filter messages to the buffered log by syslog facility.
<code>&lt;facility&gt;</code>	Specify one of the following syslog facilities to include messages from in the buffered log:
<code>kern</code>	Kernel messages
<code>user</code>	Random user-level messages
<code>mail</code>	Mail system
<code>daemon</code>	System daemons
<code>auth</code>	Security/authorization messages
<code>syslog</code>	Messages generated internally by syslogd
<code>lpr</code>	Line printer subsystem
<code>news</code>	Network news subsystem
<code>uucp</code>	UUCP subsystem
<code>cron</code>	Clock daemon
<code>authpriv</code>	Security/authorization messages (private)
<code>ftp</code>	FTP daemon
<code>msgtext</code>	Select messages containing a certain text string.
<code>&lt;text-string&gt;</code>	A text string to match (maximum 128 characters). This is case sensitive, and must be the last text on the command line.

**Default** By default the buffered log has a filter to select messages whose severity level is “notices (5)” or higher. This filter may be removed using the **no** variant of this command.

**Mode** Global Configuration

**Examples** To add a filter to send all messages generated by EPSR that have a severity of **notices** or higher to the buffered log, use the following commands:

```
awplus# configure terminal
awplus(config)# log buffered level notices program epsr
```

To add a filter to send all messages containing the text “Bridging initialization” to the buffered log, use the following commands:

```
awplus# configure terminal
awplus(config)# log buffered msgtext Bridging initialization
```

To remove a filter that sends all messages generated by EPSR that have a severity of **notices** or higher to the buffered log, use the following commands:

```
awplus# configure terminal
awplus(config)# no log buffered level notices program epsr
```

To remove a filter that sends all messages containing the text “Bridging initialization” to the buffered log, use the following commands:

```
awplus# configure terminal
awplus(config)# no log buffered msgtext Bridging initialization
```

**Related commands**

- [clear log buffered](#)
- [default log buffered](#)
- [log buffered](#)
- [log buffered size](#)
- [log buffered exclude](#)
- [show log](#)
- [show log config](#)

# log buffered exclude

**Overview** Use this command to exclude specified log messages from the buffered log. You can exclude messages on the basis of:

- the priority/severity of the message
- the program that generated the message
- the logging facility used
- a sub-string within the message, or
- a combination of some or all of these.

Use the **no** variant of this command to stop excluding the specified messages.

**Syntax** `log buffered exclude [level <level>] [program <program-name>] [facility <facility>] [msgtext <text-string>]`  
`no log buffered exclude [level <level>] [program <program-name>] [facility <facility>] [msgtext <text-string>]`

Parameter	Description
level	Exclude messages of the specified severity level.
<level>	The severity level to exclude. The level can be specified as one of the following numbers or level names, where 0 is the highest severity and 7 is the lowest severity:
0   emergencies	System is unusable
1   alerts	Action must be taken immediately
2   critical	Critical conditions
3   errors	Error conditions
4   warnings	Warning conditions
5   notices	Normal, but significant, conditions
6   informational	Informational messages
7   debugging	Debug-level messages
program	Exclude messages from a specified program.
<program-name>	The name of a program. You can enter either one of the following predefined program names (depending on your device model), or another program name that you find in the log output. The pre-defined names are not case sensitive but other program names from the log output are.
rip	Routing Information Protocol (RIP)
ripng	Routing Information Protocol - next generation (RIPng)
ospf	Open Shortest Path First (OSPF)
ospfv3	Open Shortest Path First (OSPF) version 3 (OSPFv3)
bgp	Border Gateway Protocol (BGP)

Parameter	Description
<code>rsvp</code>	Resource Reservation Protocol (RSVP)
<code>pim-dm</code>	Protocol Independent Multicast - Dense Mode (PIM-DM)
<code>pim-sm</code>	Protocol Independent Multicast - Sparse Mode (PIM-SM)
<code>pim-smv6</code>	PIM-SM version 6 (PIM-SMv6)
<code>dot1x</code>	IEEE 802.1X Port-Based Access Control
<code>lacp</code>	Link Aggregation Control Protocol (LACP)
<code>stp</code>	Spanning Tree Protocol (STP)
<code>rstp</code>	Rapid Spanning Tree Protocol (RSTP)
<code>mstp</code>	Multiple Spanning Tree Protocol (MSTP)
<code>imi</code>	Integrated Management Interface (IMI)
<code>imish</code>	Integrated Management Interface Shell (IMISH)
<code>epsr</code>	Ethernet Protection Switched Rings (EPSR)
<code>irdp</code>	ICMP Router Discovery Protocol (IRDP)
<code>rmon</code>	Remote Monitoring
<code>loopprot</code>	Loop Protection
<code>poe</code>	Power-inline (Power over Ethernet)
<code>dhcpsn</code>	DHCP snooping (DHCP SN)
<code>facility</code>	Exclude messages from a syslog facility.
<code>&lt;facility&gt;</code>	Specify one of the following syslog facilities to exclude messages from:
<code>kern</code>	Kernel messages
<code>user</code>	Random user-level messages
<code>mail</code>	Mail system
<code>daemon</code>	System daemons
<code>auth</code>	Security/authorization messages
<code>syslog</code>	Messages generated internally by syslogd
<code>lpr</code>	Line printer subsystem
<code>news</code>	Network news subsystem
<code>uucp</code>	UUCP subsystem
<code>cron</code>	Clock daemon
<code>authpriv</code>	Security/authorization messages (private)
<code>ftp</code>	FTP daemon
<code>msgtext</code>	Exclude messages containing a certain text string.
<code>&lt;text-string&gt;</code>	A text string to match (maximum 128 characters). This is case sensitive, and must be the last text on the command line.

**Default** No log messages are excluded

**Mode** Global configuration

**Example** To remove messages that contain the string “example of irrelevant message”, use the following commands:

```
awplus# configure terminal
awplus(config)# log buffered exclude msgtext example of
irrelevant message
```

**Related commands**

- clear log buffered
- default log buffered
- log buffered
- log buffered (filter)
- log buffered size
- show log
- show log config



# log buffered size

**Overview** This command configures the amount of memory that the buffered log is permitted to use. Once this memory allocation has been filled old messages will be deleted to make room for new messages.

Use the **no** variant of this command to return to the default.

**Syntax** `log buffered size <50-250>`  
`no log buffered size`

Parameter	Description
<50-250>	Size of the RAM log in kilobytes

**Default** 50 kilobytes

**Mode** Global Configuration

**Example** To allow the buffered log to use up to 100 kilobytes of RAM, use the commands:

```
awplus# configure terminal
awplus(config)# log buffered size 100
```

To return to the default value, use the commands:

```
awplus# configure terminal
awplus(config)# no log buffered size
```

**Related commands**

- [clear log buffered](#)
- [copy buffered-log](#)
- [default log buffered](#)
- [log buffered](#)
- [log buffered \(filter\)](#)
- [log buffered exclude](#)
- [show log](#)
- [show log config](#)

# log console

**Overview** This command configures the device to send log messages to consoles. The console log is configured by default to send messages to the device's main console port.

Use the **no** variant of this command to configure the device not to send log messages to consoles.

**Syntax** `log console`  
`no log console`

**Mode** Global Configuration

**Examples** To configure the device to send log messages use the following commands:

```
awplus# configure terminal
awplus(config)# log console
```

To configure the device not to send log messages in all consoles use the following commands:

```
awplus# configure terminal
awplus(config)# no log console
```

**Related commands** [default log console](#)  
[log console \(filter\)](#)  
[log console exclude](#)  
[show log config](#)

# log console (filter)

**Overview** This command creates a filter to select messages to be sent to all consoles when the **log console** command is given. Selection can be based on the priority/severity of the message, the program that generated the message, the logging facility used, a sub-string within the message or a combination of some or all of these.

**Syntax** `log console [level <level>] [program <program-name>] [facility <facility>] [msgtext <text-string>]`  
`no log console [level <level>] [program <program-name>] [facility <facility>] [msgtext <text-string>]`

Parameter	Description
level	Filter messages by severity level.
<level>	The minimum severity of message to send. The level can be specified as one of the following numbers or level names, where 0 is the highest severity and 7 is the lowest severity:
0   emergencies	System is unusable
1   alerts	Action must be taken immediately
2   critical	Critical conditions
3   errors	Error conditions
4   warnings	Warning conditions
5   notices	Normal, but significant, conditions
6   informational	Informational messages
7   debugging	Debug-level messages
program	Filter messages by program. Include messages from a specified program.
<program-name>	The name of a program to log messages from. You can enter either one of the following predefined program names (depending on your device model), or another program name that you find in the log output. The pre-defined names are not case sensitive but other program names from the log output are.
rip	Routing Information Protocol (RIP)
ripng	Routing Information Protocol - next generation (RIPng)
ospf	Open Shortest Path First (OSPF)
ospfv3	Open Shortest Path First (OSPF) version 3 (OSPFv3)
bgp	Border Gateway Protocol (BGP)
rsvp	Resource Reservation Protocol (RSVP)
pim-dm	Protocol Independent Multicast - Dense Mode (PIM-DM)
pim-sm	Protocol Independent Multicast - Sparse Mode (PIM-SM)
pim-smv6	PIM-SM version 6 (PIM-SMv6)

Parameter	Description
dot1x	IEEE 802.1X Port-Based Access Control
lacp	Link Aggregation Control Protocol (LACP)
stp	Spanning Tree Protocol (STP)
rstp	Rapid Spanning Tree Protocol (RSTP)
mstp	Multiple Spanning Tree Protocol (MSTP)
imi	Integrated Management Interface (IMI)
imish	Integrated Management Interface Shell (IMISH)
epsr	Ethernet Protection Switched Rings (EPSR)
irdp	ICMP Router Discovery Protocol (IRDP)
rmon	Remote Monitoring
loopprot	Loop Protection
poe	Power-inline (Power over Ethernet)
dhcpcsn	DHCP snooping (DHPCPSN)
facility	Filter messages by syslog facility.
<facility>	Specify one of the following syslog facilities to include messages from:
kern	Kernel messages
user	Random user-level messages
mail	Mail system
daemon	System daemons
auth	Security/authorization messages
syslog	Messages generated internally by syslogd
lpr	Line printer subsystem
news	Network news subsystem
uucp	UUCP subsystem
cron	Clock daemon
authpriv	Security/authorization messages (private)
ftp	FTP daemon
msgtext	Select messages containing a certain text string.
<text-string>	A text string to match (maximum 128 characters). This is case sensitive, and must be the last text on the command line.

**Default** By default the console log has a filter to select messages whose severity level is **critical** or higher. This filter may be removed using the **no** variant of this command. This filter may be removed and replaced by filters that are more selective.

**Mode** Global Configuration

**Examples** To create a filter to send all messages containing the text "Bridging initialization" to console instances where the **log console** command has been entered, use the following commands:

```
awplus# configure terminal
awplus(config)# log console msgtext "Bridging initialization"
```

To remove a filter that sends all messages generated by EPSR that have a severity of **notices** or higher to consoles, use the following commands:

```
awplus# configure terminal
awplus(config)# no log console level notices program epsr
```

To remove a default filter that includes sending **critical**, **alert** and **emergency** level messages to the console, use the following commands:

```
awplus# configure terminal
awplus(config)# no log console level critical
```

**Related commands**

- [default log console](#)
- [log console](#)
- [log console exclude](#)
- [show log config](#)

# log console exclude

**Overview** Use this command to prevent specified log messages from being sent to the console, when console logging is turned on. You can exclude messages on the basis of:

- the priority/severity of the message
- the program that generated the message
- the logging facility used
- a sub-string within the message, or
- a combination of some or all of these.

Use the **no** variant of this command to stop excluding the specified messages.

**Syntax** `log console exclude [level <level>] [program <program-name>] [facility <facility>] [msgtext <text-string>]`  
`no log console exclude [level <level>] [program <program-name>] [facility <facility>] [msgtext <text-string>]`

Parameter	Description
level	Exclude messages of the specified severity level.
<level>	The severity level to exclude. The level can be specified as one of the following numbers or level names, where 0 is the highest severity and 7 is the lowest severity:
0   emergencies	System is unusable
1   alerts	Action must be taken immediately
2   critical	Critical conditions
3   errors	Error conditions
4   warnings	Warning conditions
5   notices	Normal, but significant, conditions
6   informational	Informational messages
7   debugging	Debug-level messages
program	Exclude messages from a specified program.
<program-name>	The name of a program. You can enter either one of the following predefined program names (depending on your device model), or another program name that you find in the log output. The pre-defined names are not case sensitive but other program names from the log output are.
rip	Routing Information Protocol (RIP)
ripng	Routing Information Protocol - next generation (RIPng)
ospf	Open Shortest Path First (OSPF)
ospfv3	Open Shortest Path First (OSPF) version 3 (OSPFv3)

Parameter	Description
bgp	Border Gateway Protocol (BGP)
rsvp	Resource Reservation Protocol (RSVP)
pim-dm	Protocol Independent Multicast - Dense Mode (PIM-DM)
pim-sm	Protocol Independent Multicast - Sparse Mode (PIM-SM)
pim-smv6	PIM-SM version 6 (PIM-SMv6)
dot1x	IEEE 802.1X Port-Based Access Control
lacp	Link Aggregation Control Protocol (LACP)
stp	Spanning Tree Protocol (STP)
rstp	Rapid Spanning Tree Protocol (RSTP)
mstp	Multiple Spanning Tree Protocol (MSTP)
imi	Integrated Management Interface (IMI)
imish	Integrated Management Interface Shell (IMISH)
epsr	Ethernet Protection Switched Rings (EPSR)
irdp	ICMP Router Discovery Protocol (IRDP)
rmon	Remote Monitoring
loopprot	Loop Protection
poe	Power-inline (Power over Ethernet)
dhcpsn	DHCP snooping (DHCP SN)
facility	Exclude messages from a syslog facility.
<facility>	Specify one of the following syslog facilities to exclude messages from:
kern	Kernel messages
user	Random user-level messages
mail	Mail system
daemon	System daemons
auth	Security/authorization messages
syslog	Messages generated internally by syslogd
lpr	Line printer subsystem
news	Network news subsystem
uucp	UUCP subsystem
cron	Clock daemon
authpriv	Security/authorization messages (private)
ftp	FTP daemon

Parameter	Description
msgtext	Exclude messages containing a certain text string.
<text-string>	A text string to match (maximum 128 characters). This is case sensitive, and must be the last text on the command line.

**Default** No log messages are excluded

**Mode** Global configuration

**Example** To remove messages that contain the string “example of irrelevant message”, use the following commands:

```
awplus# configure terminal
awplus(config)# log console exclude msgtext example of
irrelevant message
```

**Related commands**

- [default log console](#)
- [log console](#)
- [log console \(filter\)](#)
- [show log config](#)



# log email

**Overview** This command configures the device to send log messages to an email address. The email address is specified in this command.

**Syntax** `log email <email-address>`

Parameter	Description
<code>&lt;email-address&gt;</code>	The email address to send log messages to

**Default** By default no filters are defined for email log targets. Filters must be defined before messages will be sent.

**Mode** Global Configuration

**Example** To have log messages emailed to the email address `admin@alliedtelesis.com` use the following commands:

```
awplus# configure terminal
awplus(config)# log email admin@alliedtelesis.com
```

**Related commands**

- [default log email](#)
- [log email \(filter\)](#)
- [log email exclude](#)
- [log email time](#)
- [show log config](#)

# log email (filter)

**Overview** This command creates a filter to select messages to be sent to an email address. Selection can be based on the priority/ severity of the message, the program that generated the message, the logging facility used, a sub-string within the message or a combination of some or all of these.

The **no** variant of this command configures the device to no longer send log messages to a specified email address. All configuration relating to this log target will be removed.

**Syntax** `log email <email-address> [level <level>] [program <program-name>] [facility <facility>] [msgtext <text-string>]`  
`no log email <email-address> [level <level>] [program <program-name>] [facility <facility>] [msgtext <text-string>]`

Parameter	Description
<code>&lt;email-address&gt;</code>	The email address to send logging messages to
<code>level</code>	Filter messages by severity level.
<code>&lt;level&gt;</code>	The minimum severity of message to send. The level can be specified as one of the following numbers or level names, where 0 is the highest severity and 7 is the lowest severity:
0	emergencies System is unusable
1	alerts Action must be taken immediately
2	critical Critical conditions
3	errors Error conditions
4	warnings Warning conditions
5	notices Normal, but significant, conditions
6	informational Informational messages
7	debugging Debug-level messages
<code>program</code>	Filter messages by program. Include messages from a specified program.
<code>&lt;program-name&gt;</code>	The name of a program to log messages from. You can enter either one of the following predefined program names (depending on your device model), or another program name that you find in the log output. The pre-defined names are not case sensitive but other program names from the log output are.
rip	Routing Information Protocol (RIP)
ripng	Routing Information Protocol - next generation (RIPng)
ospf	Open Shortest Path First (OSPF)
ospfv3	Open Shortest Path First (OSPF) version 3 (OSPFv3)
bgp	Border Gateway Protocol (BGP)

Parameter	Description
rsvp	Resource Reservation Protocol (RSVP)
pim-dm	Protocol Independent Multicast - Dense Mode (PIM-DM)
pim-sm	Protocol Independent Multicast - Sparse Mode (PIM-SM)
pim-smv6	PIM-SM version 6 (PIM-SMv6)
dot1x	IEEE 802.1X Port-Based Access Control
lacp	Link Aggregation Control Protocol (LACP)
stp	Spanning Tree Protocol (STP)
rstp	Rapid Spanning Tree Protocol (RSTP)
mstp	Multiple Spanning Tree Protocol (MSTP)
imi	Integrated Management Interface (IMI)
imish	Integrated Management Interface Shell (IMISH)
epsr	Ethernet Protection Switched Rings (EPSR)
irdp	ICMP Router Discovery Protocol (IRDP)
rmon	Remote Monitoring
loopprot	Loop Protection
poe	Power-inline (Power over Ethernet)
dhcpcsn	DHCP snooping (DHPCPSN)
facility	Filter messages by syslog facility.
<facility>	Specify one of the following syslog facilities to include messages from:
kern	Kernel messages
user	Random user-level messages
mail	Mail system
daemon	System daemons
auth	Security/authorization messages
syslog	Messages generated internally by syslogd
lpr	Line printer subsystem
news	Network news subsystem
uucp	UUCP subsystem
cron	Clock daemon
authpriv	Security/authorization messages (private)
ftp	FTP daemon
msgtext	Select messages containing a certain text string.
<text-string>	A text string to match (maximum 128 characters). This is case sensitive, and must be the last text on the command line.

**Mode** Global Configuration

**Examples** To create a filter to send all messages generated by EPSR that have a severity of **notices** or higher to the email address admin@homebase.com, use the following commands:

```
awplus# configure terminal
awplus(config)# log email admin@homebase.com level notices
program epsr
```

To create a filter to send all messages containing the text "Bridging initialization", to the email address admin@homebase.com, use the following commands:

```
awplus# configure terminal
awplus(config)# log email admin@homebase.com msgtext "Bridging
initialization"
```

To create a filter to send messages with a severity level of **informational** and above to the email address admin@alliedtelesis.com, use the following commands:

```
awplus# configure terminal
awplus(config)# log email admin@alliedtelesis.com level
informational
```

To stop the device emailing log messages emailed to the email address admin@alliedtelesis.com, use the following commands:

```
awplus# configure terminal
awplus(config)# no log email admin@homebase.com
```

To remove a filter that sends all messages generated by EPSR that have a severity of **notices** or higher to the email address admin@homebase.com, use the following commands:

```
awplus# configure terminal
awplus(config)# no log email admin@homebase.com level notices
program epsr
```

To remove a filter that sends messages with a severity level of **informational** and above to the email address admin@alliedtelesis.com, use the following commands:

```
awplus# configure terminal
awplus(config)# no log email admin@alliedtelesis.com level
informational
```

**Related commands**

- [default log email](#)
- [log email](#)
- [log email exclude](#)
- [log email time](#)
- [show log config](#)

# log email exclude

**Overview** Use this command to prevent specified log messages from being emailed, when the device is configured to send log messages to an email address. You can exclude messages on the basis of:

- the priority/severity of the message
- the program that generated the message
- the logging facility used
- a sub-string within the message, or
- a combination of some or all of these.

Use the **no** variant of this command to stop excluding the specified messages.

**Syntax** `log email exclude [level <level>] [program <program-name>]  
[facility <facility>] [msgtext <text-string>]`  
`no log email exclude [level <level>] [program <program-name>]  
[facility <facility>] [msgtext <text-string>]`

Parameter	Description
level	Exclude messages of the specified severity level.
<level>	The severity level to exclude. The level can be specified as one of the following numbers or level names, where 0 is the highest severity and 7 is the lowest severity:
0   emergencies	System is unusable
1   alerts	Action must be taken immediately
2   critical	Critical conditions
3   errors	Error conditions
4   warnings	Warning conditions
5   notices	Normal, but significant, conditions
6   informational	Informational messages
7   debugging	Debug-level messages
program	Exclude messages from a specified program.
<program-name>	The name of a program. You can enter either one of the following predefined program names (depending on your device model), or another program name that you find in the log output. The pre-defined names are not case sensitive but other program names from the log output are.
rip	Routing Information Protocol (RIP)
ripng	Routing Information Protocol - next generation (RIPng)
ospf	Open Shortest Path First (OSPF)
ospfv3	Open Shortest Path First (OSPF) version 3 (OSPFv3)

Parameter	Description
bgp	Border Gateway Protocol (BGP)
rsvp	Resource Reservation Protocol (RSVP)
pim-dm	Protocol Independent Multicast - Dense Mode (PIM-DM)
pim-sm	Protocol Independent Multicast - Sparse Mode (PIM-SM)
pim-smv6	PIM-SM version 6 (PIM-SMv6)
dot1x	IEEE 802.1X Port-Based Access Control
lacp	Link Aggregation Control Protocol (LACP)
stp	Spanning Tree Protocol (STP)
rstp	Rapid Spanning Tree Protocol (RSTP)
mstp	Multiple Spanning Tree Protocol (MSTP)
imi	Integrated Management Interface (IMI)
imish	Integrated Management Interface Shell (IMISH)
epsr	Ethernet Protection Switched Rings (EPSR)
irdp	ICMP Router Discovery Protocol (IRDP)
rmon	Remote Monitoring
loopprot	Loop Protection
poe	Power-inline (Power over Ethernet)
dhcpsn	DHCP snooping (DHCP SN)
facility	Exclude messages from a syslog facility.
<facility>	Specify one of the following syslog facilities to exclude messages from:
kern	Kernel messages
user	Random user-level messages
mail	Mail system
daemon	System daemons
auth	Security/authorization messages
syslog	Messages generated internally by syslogd
lpr	Line printer subsystem
news	Network news subsystem
uucp	UUCP subsystem
cron	Clock daemon
authpriv	Security/authorization messages (private)
ftp	FTP daemon

Parameter	Description
msgtext	Exclude messages containing a certain text string.
<text-string>	A text string to match (maximum 128 characters). This is case sensitive, and must be the last text on the command line.

**Default** No log messages are excluded

**Mode** Global configuration

**Example** To remove messages that contain the string “example of irrelevant message”, use the following commands:

```
awplus# configure terminal
awplus(config)# log email exclude msgtext example of irrelevant
message
```

**Related commands**

- [default log email](#)
- [log email](#)
- [log email \(filter\)](#)
- [log email time](#)
- [show log config](#)

# log email time

**Overview** This command configures the time used in messages sent to an email address. If the syslog server is in a different time zone to your device then the time offset can be configured using either the **utc-offset** parameter option keyword or the **local-offset** parameter option keyword, where **utc-offset** is the time difference from UTC (Universal Time, Coordinated) and **local-offset** is the difference from local time.

**Syntax** `log email <email-address> time {local|local-offset|utc-offset {plus|minus}<0-24>}`

Parameter	Description
<email-address>	The email address to send log messages to
time	Specify the time difference between the email recipient and the device you are configuring.
local	The device is in the same time zone as the email recipient
local-offset	The device is in a different time zone to the email recipient. Use the <b>plus</b> or <b>minus</b> keywords and specify the difference (offset) from local time of the device to the email recipient in hours.
utc-offset	The device is in a different time zone to the email recipient. Use the <b>plus</b> or <b>minus</b> keywords and specify the difference (offset) from UTC time of the device to the email recipient in hours.
plus	Negative offset (difference) from the device to the email recipient.
minus	Positive offset (difference) from the device to the email recipient.
<0-24>	World Time zone offset in hours

**Default** The default is **local** time.

**Mode** Global Configuration

**Usage notes** Use the **local** option if the email recipient is in the same time zone as this device. Messages will display the time as on the local device when the message was generated.

Use the **offset** option if the email recipient is in a different time zone to this device. Specify the time offset of the email recipient in hours. Messages will display the time they were generated on this device but converted to the time zone of the email recipient.



**Examples** To send messages to the email address `test@home.com` in the same time zone as the device's local time zone, use the following commands:

```
awplus# configure terminal
awplus(config)# log email admin@base.com time local 0
```

To send messages to the email address `admin@base.com` with the time information converted to the time zone of the email recipient, which is 3 hours ahead of the device's local time zone, use the following commands:

```
awplus# configure terminal
awplus(config)# log email admin@base.com time local-offset plus
3
```

To send messages to the email address `user@remote.com` with the time information converted to the time zone of the email recipient, which is 3 hours behind the device's UTC time zone, use the following commands:

```
awplus# configure terminal
awplus(config)# log email user@remote.com time utc-offset minus
3
```

**Related commands**

- [default log email](#)
- [log email](#)
- [log email \(filter\)](#)
- [log email exclude](#)
- [show log config](#)

# log external

**Overview** Use this command to enable external logging. External logging sends syslog messages to a file on an SD card.

If the file does not already exist on the storage device, it (and any specified subdirectory) will be automatically created. If the file already exists, messages are appended to it.

Use the **no** variant of this command to disable external logging.

**Syntax** `log external <filename>`  
`no log external`

Parameter	Description
<code>&lt;filename&gt;</code>	The file and optionally directory path to store the log messages in. See <a href="#">Introduction</a> on page 80 for valid syntax.

**Default** External logging is disabled by default.

**Mode** Global Configuration

**Usage notes** We strongly recommend using ext3 or ext4 as the file system on the external storage device. These file systems have a lower risk of file corruption occurring if the switch or firewall loses power.

You should also unmount the storage device before removing it from the switch or firewall, to avoid corrupting the log file. To unmount the device, use the **unmount** command.

**Example** To save messages to a file called "messages.log" in a directory called "log" on an SD card, use the command:

```
awplus# configure terminal
awplus(config)# log external card:/log/messages.log
```

**Related commands**

- [clear log external](#)
- [default log external](#)
- [log external \(filter\)](#)
- [log external exclude](#)
- [log external rotate](#)
- [log external size](#)
- [show log config](#)
- [show log external](#)
- [unmount](#)

**Command changes** Version 5.4.7-1.1: command added

# log external (filter)

**Overview** Use this command to create a filter to select messages to be sent to the external log. You can include messages based on:

- the priority/severity of the message
- the program that generated the message
- the logging facility used
- a sub-string within the message, or
- a combination of some or all of these.

The **no** variant of this command removes the corresponding filter, so that the specified messages are no longer sent to the external log.

**Syntax** `log external [level <level>] [program <program-name>] [facility <facility>] [msgtext <text-string>]`  
`no log external [level <level>] [program <program-name>] [facility <facility>] [msgtext <text-string>]`

Parameter	Description
level	Filter messages to the external log by severity level.
<level>	The minimum severity of message to send to the external log. The level can be specified as one of the following numbers or level names, where 0 is the highest severity and 7 is the lowest severity:
0   emergencies	System is unusable
1   alerts	Action must be taken immediately
2   critical	Critical conditions
3   errors	Error conditions
4   warnings	Warning conditions
5   notices	Normal, but significant, conditions
6   informational	Informational messages
7   debugging	Debug-level messages
program	Filter messages to the external log by program. Include messages from a specified program in the external log.
<program-name>	The name of a program to log messages from. You can enter either one of the following predefined program names (depending on your device model), or another program name that you find in the log output. The pre-defined names are not case sensitive but other program names from the log output are.
rip	Routing Information Protocol (RIP)
ripng	Routing Information Protocol - next generation (RIPng)
ospf	Open Shortest Path First (OSPF)

Parameter	Description
ospfv3	Open Shortest Path First (OSPF) version 3 (OSPFv3)
bgp	Border Gateway Protocol (BGP)
rsvp	Resource Reservation Protocol (RSVP)
pim-dm	Protocol Independent Multicast - Dense Mode (PIM-DM)
pim-sm	Protocol Independent Multicast - Sparse Mode (PIM-SM)
pim-smv6	PIM-SM version 6 (PIM-SMv6)
dot1x	IEEE 802.1X Port-Based Access Control
lacp	Link Aggregation Control Protocol (LACP)
stp	Spanning Tree Protocol (STP)
rstp	Rapid Spanning Tree Protocol (RSTP)
mstp	Multiple Spanning Tree Protocol (MSTP)
imi	Integrated Management Interface (IMI)
imish	Integrated Management Interface Shell (IMISH)
epsr	Ethernet Protection Switched Rings (EPSR)
irdp	ICMP Router Discovery Protocol (IRDP)
rmon	Remote Monitoring
loopprot	Loop Protection
poe	Power-inline (Power over Ethernet)
dhcpcsn	DHCP snooping (DHPCPSN)
facility	Filter messages to the external log by syslog facility.
<facility>	Specify one of the following syslog facilities to include messages from in the log:
kern	Kernel messages
user	Random user-level messages
mail	Mail system
daemon	System daemons
auth	Security/authorization messages
syslog	Messages generated internally by syslogd
lpr	Line printer subsystem
news	Network news subsystem
uucp	UUCP subsystem
cron	Clock daemon
authpriv	Security/authorization messages (private)
ftp	FTP daemon

Parameter	Description
msgtext	Select messages containing a certain text string.
<text-string>	A text string to match (maximum 128 characters). This is case sensitive, and must be the last text on the command line.

**Default** By default the external log has a filter to select messages whose severity level is “notices (5)” or higher. This filter may be removed using the **no** variant of this command.

**Mode** Global Configuration

**Examples** To add a filter to send all messages generated by EPSR that have a severity of **notices** or higher to the external log, use the following commands:

```
awplus# configure terminal
awplus(config)# log external level notices program epsr
```

To add a filter to send all messages containing the text “Bridging initialization” to the external log, use the following commands:

```
awplus# configure terminal
awplus(config)# log external msgtext Bridging initialization
```

To remove a filter that sends all messages generated by EPSR that have a severity of **notices** or higher to the external log, use the following commands:

```
awplus# configure terminal
awplus(config)# no log external level notices program epsr
```

To remove a filter that sends all messages containing the text “Bridging initialization” to the external log, use the following commands:

```
awplus# configure terminal
awplus(config)# no log external msgtext Bridging initialization
```

**Related commands**

- [clear log external](#)
- [default log external](#)
- [log external](#)
- [log external exclude](#)
- [log external rotate](#)
- [log external size](#)
- [show log config](#)
- [show log external](#)
- [unmount](#)

**Command changes** Version 5.4.7-1.1: command added

# log external exclude

**Overview** Use this command to exclude specified log messages from the external log. You can exclude messages on the basis of:

- the priority/severity of the message
- the program that generated the message
- the logging facility used
- a sub-string within the message, or
- a combination of some or all of these.

Use the **no** variant of this command to stop excluding the specified messages.

**Syntax** `log external exclude [level <level>] [program <program-name>] [facility <facility>] [msgtext <text-string>]`  
`no log external exclude [level <level>] [program <program-name>] [facility <facility>] [msgtext <text-string>]`

Parameter	Description
level	Exclude messages of the specified severity level.
<level>	The severity level to exclude. The level can be specified as one of the following numbers or level names, where 0 is the highest severity and 7 is the lowest severity:
0   emergencies	System is unusable
1   alerts	Action must be taken immediately
2   critical	Critical conditions
3   errors	Error conditions
4   warnings	Warning conditions
5   notices	Normal, but significant, conditions
6   informational	Informational messages
7   debugging	Debug-level messages
program	Exclude messages from a specified program.
<program-name>	The name of a program. You can enter either one of the following predefined program names (depending on your device model), or another program name that you find in the log output. The pre-defined names are not case sensitive but other program names from the log output are.
rip	Routing Information Protocol (RIP)
ripng	Routing Information Protocol - next generation (RIPng)
ospf	Open Shortest Path First (OSPF)
ospfv3	Open Shortest Path First (OSPF) version 3 (OSPFv3)
bgp	Border Gateway Protocol (BGP)

Parameter	Description
rsvp	Resource Reservation Protocol (RSVP)
pim-dm	Protocol Independent Multicast - Dense Mode (PIM-DM)
pim-sm	Protocol Independent Multicast - Sparse Mode (PIM-SM)
pim-smv6	PIM-SM version 6 (PIM-SMv6)
dot1x	IEEE 802.1X Port-Based Access Control
lacp	Link Aggregation Control Protocol (LACP)
stp	Spanning Tree Protocol (STP)
rstp	Rapid Spanning Tree Protocol (RSTP)
mstp	Multiple Spanning Tree Protocol (MSTP)
imi	Integrated Management Interface (IMI)
imish	Integrated Management Interface Shell (IMISH)
epsr	Ethernet Protection Switched Rings (EPSR)
irdp	ICMP Router Discovery Protocol (IRDP)
rmon	Remote Monitoring
loopprot	Loop Protection
poe	Power-inline (Power over Ethernet)
dhcpsn	DHCP snooping (DHCP SN)
facility	Exclude messages from a syslog facility.
<facility>	Specify one of the following syslog facilities to exclude messages from:
kern	Kernel messages
user	Random user-level messages
mail	Mail system
daemon	System daemons
auth	Security/authorization messages
syslog	Messages generated internally by syslogd
lpr	Line printer subsystem
news	Network news subsystem
uucp	UUCP subsystem
cron	Clock daemon
authpriv	Security/authorization messages (private)
ftp	FTP daemon
msgtext	Exclude messages containing a certain text string.
<text-string>	A text string to match (maximum 128 characters). This is case sensitive, and must be the last text on the command line.



**Default** No log messages are excluded

**Mode** Global Configuration

**Example** To remove messages that contain the string “example of irrelevant message”, use the following commands:

```
awplus# configure terminal
awplus(config)# log external exclude msgtext example of
irrelevant message
```

**Related  
commands** [clear log external](#)  
[default log external](#)

[log external](#)

[log external \(filter\)](#)

[log external rotate](#)

[log external size](#)

[show log config](#)

[show log external](#)

[unmount](#)

**Command  
changes** Version 5.4.7-1.1: command added

# log external rotate

**Overview** Use this command to configure the number of files that the external log can rotate through.

Use the **no** variant of this command to return to the default.

**Syntax** `log external rotate <0-255>`  
`no log external rotate`

Parameter	Description
<code>&lt;0-255&gt;</code>	The number of additional files to rotate through. Note that the device rotates between the initial file and the number of additional files specified by this value - see the Usage section below.

**Default** The default is 1, which rotates between the initial file and 1 additional file (for example, rotates between `messages.log` and `messages.log.1`)

**Mode** Global Configuration

**Usage notes** The device rotates between the initial file and the number of additional files specified by this command. For example, the diagram below shows how setting rotate to 2 makes the device rotate through 3 files.

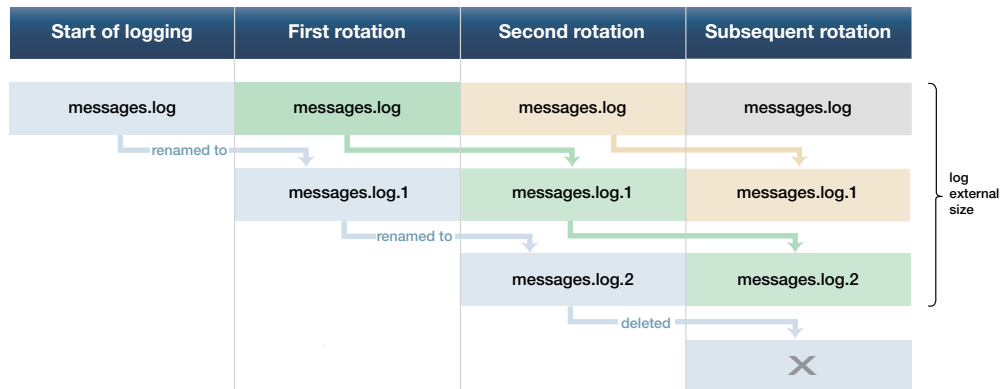

Note that if you set rotate to 0, and the external log file becomes full, then the device deletes the full log file and creates a new (empty) file of the same name to save messages into. For this reason, we recommend setting rotate to at least 1.

**Example** To set the rotation value to 2, and therefore rotate between 3 files, use the commands:

```
awplus# configure terminal
awplus(config)# log external rotate 2
```

**Related commands** [clear log external](#)

default log external  
log external  
log external (filter)  
log external exclude  
log external size  
show log config  
show log external  
unmount

**Command changes** Version 5.4.7-1.1: command added

# log external size

**Overview** Use this command to configure the total amount of size that the external log is permitted to use, in kilobytes. The maximum possible depends on the storage device's file system.

Note that if you are rotating between multiple files, this is the maximum size of all files, not of each individual file. For example, if you are rotating between 2 files (**log external rotate 1**), each file will have a maximum size of 25 kBytes by default.

Use the **no** variant of this command to return to the default size.

**Syntax** `log external size [<50-4194304>]`  
`no log external size`

Parameter	Description
<50-4194304>	The total amount of size that the external log is permitted to use, in kilobytes.

**Default** 50 kBytes

**Mode** Global Configuration

**Example** To configure a total log size of 100 kBytes, use the commands:

```
awplus# configure terminal
awplus(config)# log external size 100
```

**Related commands**

- [clear log external](#)
- [default log external](#)
- [log external](#)
- [log external \(filter\)](#)
- [log external exclude](#)
- [log external rotate](#)
- [log external size](#)
- [show log config](#)
- [show log external](#)
- [unmount](#)

**Command changes** Version 5.4.7-1.1: command added

# log facility

**Overview** Use this command to assign a facility to all log messages generated on this device. This facility overrides any facility that is automatically generated as part of the log message.

Use the **no** variant of this command to remove the configured facility.

**Syntax** `log facility {kern|user|mail|daemon|auth|syslog|lpr|news|uucp|cron|authpriv|ftp|local0|local1|local2|local3|local4|local5|local6|local7}`

`no log facility`

**Default** None. The outgoing syslog facility depends on the log message.

**Mode** Global Configuration

**Usage notes** Specifying different facilities for log messages generated on different devices can allow messages from multiple devices sent to a common server to be distinguished from each other.

Ordinarily, the facility values generated in log messages have meanings as shown in the following table. Using this command will override these meanings, and the new meanings will depend on the use you put them to.

Table 9-1: Ordinary meanings of the facility parameter in log messages

Facility	Description
kern	Kernel messages
user	User-level messages
mail	Mail system
daemon	System daemons
auth	Security/authorization messages
syslog	Messages generated internally by the syslog daemon
lpr	Line printer subsystem
news	Network news subsystem
uucp	UNIX-to-UNIX Copy Program subsystem
cron	Clock daemon
authpriv	Security/authorization (private) messages

Table 9-1: Ordinary meanings of the facility parameter in log messages (cont.)

Facility	Description
ftp	FTP daemon
local<0..7>	The facility labels above have specific meanings, while the local facility labels are intended to be put to local use. In AlliedWare Plus, some of these local facility labels are used in log messages. In particular, local5 is assigned to log messages generated by UTM Firewall security features.

**Example** To specify a facility of local6, use the following commands:

```
awplus# configure terminal
awplus(config)# log facility local6
```

**Related commands** [show log config](#)

# log host

**Overview** This command configures the device to send log messages to a remote syslog server via UDP port 514. The IP address of the remote server must be specified. By default no filters are defined for remote syslog servers. Filters must be defined before messages will be sent.

Use the **no** variant of this command to stop sending log messages to the remote syslog server.

**Syntax**

```
log host <ipv4-addr> [secure]
log host <ipv6-addr>
no log host <ipv4-addr>|<ipv6-addr>
```

Parameter	Description
<ipv4-addr>	Specify the source IPv4 address, in dotted decimal notation (A.B.C.D).
<ipv6-addr>	Specify the source IPv6 address, in X::X::X notation.
secure	Optional value to create a secure log destination. This option is only valid for IPv4 hosts.

**Mode** Global Configuration

**Usage notes** Use the optional **secure** parameter to configure a secure IPv4 syslog host. For secure hosts, syslog over TLS is used to encrypt the logs. The certificate received from the remote log server must have an issuer chain that terminates with the root CA certificate for any of the trustpoints that are associated with the application.

The remote server may also request that a certificate is transmitted from the local device. In this situation the first trustpoint added to the syslog application will be transmitted to the remote server.

For detailed information about securing syslog, see the [PKI Feature Overview\\_and Configuration\\_Guide](#).

**Examples** To configure the device to send log messages to a remote secure syslog server with IP address 10.32.16.99, use the following commands:

```
awplus# configure terminal
awplus(config)# log host 10.32.16.99 secure
```

To stop the device from sending log messages to the remote syslog server with IP address 10.32.16.99, use the following commands:

```
awplus# configure terminal
awplus(config)# no log host 10.32.16.99
```

**Related commands**

- [default log host](#)
- [log host \(filter\)](#)

log host exclude  
log host source  
log host startup-delay  
log host time  
log trustpoint  
show log config



# log host (filter)

**Overview** This command creates a filter to select messages to be sent to a remote syslog server. Selection can be based on the priority/severity of the message, the program that generated the message, the logging facility used, a substring within the message or a combination of some or all of these.

The **no** variant of this command configures the device to no longer send log messages to a remote syslog server. The IP address of the syslog server must be specified. All configuration relating to this log target will be removed.

**Syntax** `log host <ip-addr> [level <level>] [program <program-name>] [facility <facility>] [msgtext <text-string>]`  
`no log host <ip-addr> [level <level>] [program <program-name>] [facility <facility>] [msgtext <text-string>]`

Parameter	Description
<code>&lt;ip-addr&gt;</code>	The IP address of a remote syslog server.
<code>level</code>	Filter messages by severity level.
<code>&lt;level&gt;</code>	The minimum severity of message to send. The level can be specified as one of the following numbers or level names, where 0 is the highest severity and 7 is the lowest severity:
0   emergencies	System is unusable
1   alerts	Action must be taken immediately
2   critical	Critical conditions
3   errors	Error conditions
4   warnings	Warning conditions
5   notices	Normal, but significant, conditions
6   informational	Informational messages
7   debugging	Debug-level messages
<code>program</code>	Filter messages by program. Include messages from a specified program.
<code>&lt;program-name&gt;</code>	The name of a program to log messages from. You can enter either one of the following predefined program names (depending on your device model), or another program name that you find in the log output. The pre-defined names are not case sensitive but other program names from the log output are.
rip	Routing Information Protocol (RIP)
ripng	Routing Information Protocol - next generation (RIPng)
ospf	Open Shortest Path First (OSPF)
ospfv3	Open Shortest Path First (OSPF) version 3 (OSPFv3)
bgp	Border Gateway Protocol (BGP)
rsvp	Resource Reservation Protocol (RSVP)

Parameter	Description
pim-dm	Protocol Independent Multicast - Dense Mode (PIM-DM)
pim-sm	Protocol Independent Multicast - Sparse Mode (PIM-SM)
pim-smv6	PIM-SM version 6 (PIM-SMv6)
dot1x	IEEE 802.1X Port-Based Access Control
lacp	Link Aggregation Control Protocol (LACP)
stp	Spanning Tree Protocol (STP)
rstp	Rapid Spanning Tree Protocol (RSTP)
mstp	Multiple Spanning Tree Protocol (MSTP)
imi	Integrated Management Interface (IMI)
imish	Integrated Management Interface Shell (IMISH)
epsr	Ethernet Protection Switched Rings (EPSR)
irdp	ICMP Router Discovery Protocol (IRDP)
rmon	Remote Monitoring
loopprot	Loop Protection
poe	Power-inline (Power over Ethernet)
dhcpcsn	DHCP snooping (DHPCPSN)
facility	Filter messages by syslog facility.
<facility>	Specify one of the following syslog facilities to include messages from:
kern	Kernel messages
user	Random user-level messages
mail	Mail system
daemon	System daemons
auth	Security/authorization messages
syslog	Messages generated internally by syslogd
lpr	Line printer subsystem
news	Network news subsystem
uucp	UUCP subsystem
cron	Clock daemon
authpriv	Security/authorization messages (private)
ftp	FTP daemon
msgtext	Select messages containing a certain text string.
<text-string>	A text string to match (maximum 128 characters). This is case sensitive, and must be the last text on the command line.

**Mode** Global Configuration

**Examples** To create a filter to send all messages generated by EPSR that have a severity of **notices** or higher to a remote syslog server with IP address 10.32.16.21, use the following commands:

```
awplus# configure terminal
awplus(config)# log host 10.32.16.21 level notices program epsr
```

To create a filter to send all messages containing the text "Bridging initialization", to a remote syslog server with IP address 10.32.16.21, use the following commands:

```
awplus# configure terminal
awplus(config)# log host 10.32.16.21 msgtext "Bridging
initialization"
```

To create a filter to send messages with a severity level of **informational** and above to the syslog server with IP address 10.32.16.21, use the following commands:

```
awplus# configure terminal
awplus(config)# log host 10.32.16.21 level informational
```

To remove a filter that sends all messages generated by EPSR that have a severity of **notices** or higher to a remote syslog server with IP address 10.32.16.21, use the following commands:

```
awplus# configure terminal
awplus(config)# no log host 10.32.16.21 level notices program
epsr
```

To remove a filter that sends all messages containing the text "Bridging initialization", to a remote syslog server with IP address 10.32.16.21, use the following commands:

```
awplus# configure terminal
awplus(config)# no log host 10.32.16.21 msgtext "Bridging
initialization"
```

To remove a filter that sends messages with a severity level of **informational** and above to the syslog server with IP address 10.32.16.21, use the following commands:

```
awplusawplus# configure terminal
awplus(config)# no log host 10.32.16.21 level informational
```

**Related commands**

- [default log host](#)
- [log host](#)
- [log host exclude](#)
- [log host source](#)
- [log host time](#)
- [show log config](#)

# log host exclude

**Overview** Use this command to prevent specified log messages from being sent to the remote syslog server, when `log host` is enabled. You can exclude messages on the basis of:

- the priority/severity of the message
- the program that generated the message
- the logging facility used
- a sub-string within the message, or
- a combination of some or all of these.

Use the **no** variant of this command to stop excluding the specified messages.

**Syntax** `log host exclude [level <level>] [program <program-name>] [facility <facility>] [msgtext <text-string>]`  
`no log host exclude [level <level>] [program <program-name>] [facility <facility>] [msgtext <text-string>]`

Parameter	Description
level	Exclude messages of the specified severity level.
<level>	The severity level to exclude. The level can be specified as one of the following numbers or level names, where 0 is the highest severity and 7 is the lowest severity:
0   emergencies	System is unusable
1   alerts	Action must be taken immediately
2   critical	Critical conditions
3   errors	Error conditions
4   warnings	Warning conditions
5   notices	Normal, but significant, conditions
6   informational	Informational messages
7   debugging	Debug-level messages
program	Exclude messages from a specified program.
<program-name>	The name of a program. You can enter either one of the following predefined program names (depending on your device model), or another program name that you find in the log output. The pre-defined names are not case sensitive but other program names from the log output are.
rip	Routing Information Protocol (RIP)
ripng	Routing Information Protocol - next generation (RIPng)
ospf	Open Shortest Path First (OSPF)
ospfv3	Open Shortest Path First (OSPF) version 3 (OSPFv3)

Parameter	Description
bgp	Border Gateway Protocol (BGP)
rsvp	Resource Reservation Protocol (RSVP)
pim-dm	Protocol Independent Multicast - Dense Mode (PIM-DM)
pim-sm	Protocol Independent Multicast - Sparse Mode (PIM-SM)
pim-smv6	PIM-SM version 6 (PIM-SMv6)
dot1x	IEEE 802.1X Port-Based Access Control
lacp	Link Aggregation Control Protocol (LACP)
stp	Spanning Tree Protocol (STP)
rstp	Rapid Spanning Tree Protocol (RSTP)
mstp	Multiple Spanning Tree Protocol (MSTP)
imi	Integrated Management Interface (IMI)
imish	Integrated Management Interface Shell (IMISH)
epsr	Ethernet Protection Switched Rings (EPSR)
irdp	ICMP Router Discovery Protocol (IRDP)
rmon	Remote Monitoring
loopprot	Loop Protection
poe	Power-inline (Power over Ethernet)
dhcpsn	DHCP snooping (DHCP SN)
facility	Exclude messages from a syslog facility.
<facility>	Specify one of the following syslog facilities to exclude messages from:
kern	Kernel messages
user	Random user-level messages
mail	Mail system
daemon	System daemons
auth	Security/authorization messages
syslog	Messages generated internally by syslogd
lpr	Line printer subsystem
news	Network news subsystem
uucp	UUCP subsystem
cron	Clock daemon
authpriv	Security/authorization messages (private)
ftp	FTP daemon

Parameter	Description
msgtext	Exclude messages containing a certain text string.
<text-string>	A text string to match (maximum 128 characters). This is case sensitive, and must be the last text on the command line.

**Default** No log messages are excluded

**Mode** Global configuration

**Example** To remove messages that contain the string “example of irrelevant message”, use the following commands:

```
awplus# configure terminal
awplus(config)# log host exclude msgtext example of irrelevant
message
```

**Related commands**

- default log host
- log host
- log host (filter)
- log host source
- log host time
- show log config

# log host source

**Overview** Use this command to specify a source interface or IP address for the device to send syslog messages from. You can specify any one of an interface name, an IPv4 address or an IPv6 address.

This is useful if the device can reach the syslog server via multiple interfaces or addresses and you want to control which interface/address the device uses.

Note that AlliedWare Plus does not support source interface settings on secure log hosts (which are hosts configured using "log host <ip-address> secure").

Use the **no** variant of this command to stop specifying a source interface or address.

**Syntax** `log host source {<interface-name>|<ipv4-addr>|<ipv6-addr>}`  
`no log host source`

Parameter	Description
<interface-name>	Specify the source interface name. You can enter a VLAN, eth interface or loopback interface.
<ipv4-addr>	Specify the source IPv4 address, in dotted decimal notation (A.B.C.D).
<ipv6-addr>	Specify the source IPv6 address, in X:X::X:X notation.

**Default** None (no source is configured)

**Mode** Global Configuration

**Example** To send syslog messages from 192.168.1.1, use the commands:

```
awplus# configure terminal
awplus(config)# log host source 192.168.1.1
```

**Related commands**

- [default log host](#)
- [log host](#)
- [log host \(filter\)](#)
- [log host exclude](#)
- [log host time](#)
- [show log config](#)

# log host startup-delay

**Overview** Use this command to set the delay between the device booting up and it attempting to connect to remote log hosts. This is to allow time for network connectivity to the remote host to be established. During this period, the device buffers log messages and sends them once it has connected to the remote host.

The startup delay begins when the message "syslog-ng starting up" appears in the log.

If the default startup delay is not long enough for the boot and configuration process to complete and the links to come up, you may see logging failure messages on startup. In these cases, you can use the command to increase the startup delay.

Use the **no** variant of this command to return to the default delay values.

**Syntax** `log host startup-delay [delay <1-600>] [messages <1-5000>]`  
`no log host startup-delay`

Parameter	Description
<code>delay &lt;1-600&gt;</code>	The time, in seconds, from when syslog starts before the device attempts to filter and transmit the buffered messages to remote hosts.
<code>messages &lt;1-5000&gt;</code>	The maximum number of messages that the device will buffer during the delay period.

**Default** By default the system will buffer up to 2000 messages and wait 120 seconds from when syslog starts before attempting to filter and transmit the buffered messages to remote hosts.

**Mode** Global Configuration

**Example** To increase the delay to 180 seconds, use the commands:

```
awplus# configure terminal
awplus(config)# log host startup-delay delay 180
```

**Related commands**

- [default log host](#)
- [log host \(filter\)](#)
- [log host exclude](#)
- [log host source](#)
- [log host time](#)
- [log trustpoint](#)
- [show log config](#)



**Command changes** Version 5.4.8-0.2: defaults changed

# log host time

**Overview** This command configures the time used in messages sent to a remote syslog server. If the syslog server is in a different time zone to your device then the time offset can be configured using either the **utc-offset** parameter option keyword or the **local-offset** parameter option keyword, where **utc-offset** is the time difference from UTC (Universal Time, Coordinated) and **local-offset** is the difference from local time.

**Syntax** `log host <email-address> time {local|local-offset|utc-offset {plus|minus} <0-24>}`

Parameter	Description
<email-address>	The email address to send log messages to
time	Specify the time difference between the email recipient and the device you are configuring.
local	The device is in the same time zone as the email recipient
local-offset	The device is in a different time zone to the email recipient. Use the <b>plus</b> or <b>minus</b> keywords and specify the difference (offset) from local time of the device to the email recipient in hours.
utc-offset	The device is in a different time zone to the email recipient. Use the <b>plus</b> or <b>minus</b> keywords and specify the difference (offset) from UTC time of the device to the email recipient in hours.
plus	Negative offset (difference) from the device to the syslog server.
minus	Positive offset (difference) from the device to the syslog server.
<0-24>	World Time zone offset in hours

**Default** The default is **local** time.

**Mode** Global Configuration

**Usage notes** Use the **local** option if the remote syslog server is in the same time zone as the device. Messages will display the time as on the local device when the message was generated.

Use the **offset** option if the email recipient is in a different time zone to this device. Specify the time offset of the remote syslog server in hours. Messages will display the time they were generated on this device but converted to the time zone of the remote syslog server.

**Examples** To send messages to the remote syslog server with the IP address 10.32.16.21 in the same time zone as the device's local time zone, use the following commands:

```
awplus# configure terminal
awplus(config)# log host 10.32.16.21 time local 0
```

To send messages to the remote syslog server with the IP address 10.32.16.12 with the time information converted to the time zone of the remote syslog server, which is 3 hours ahead of the device's local time zone, use the following commands:

```
awplus# configure terminal
awplus(config)# log host 10.32.16.12 time local-offset plus 3
```

To send messages to the remote syslog server with the IP address 10.32.16.02 with the time information converted to the time zone of the email recipient, which is 3 hours behind the device's UTC time zone, use the following commands:

```
awplus# configure terminal
awplus(config)# log host 10.32.16.02 time utc-offset minus 3
```

**Related  
commands**

[default log host](#)

[log host](#)

[log host \(filter\)](#)

[log host exclude](#)

[log host source](#)

[show log config](#)

# log monitor (filter)

**Overview** This command creates a filter to select messages to be sent to the terminal when the **terminal monitor** command is given. Selection can be based on the priority/severity of the message, the program that generated the message, the logging facility used, a sub-string within the message or a combination of some or all of these.

**Syntax** `log monitor [level <level>] [program <program-name>] [facility <facility>] [msgtext <text-string>]`  
`no log monitor [level <level>] [program <program-name>] [facility <facility>] [msgtext <text-string>]`

Parameter	Description
level	Filter messages by severity level.
<level>	The minimum severity of message to send. The level can be specified as one of the following numbers or level names, where 0 is the highest severity and 7 is the lowest severity:
0   emergencies	System is unusable
1   alerts	Action must be taken immediately
2   critical	Critical conditions
3   errors	Error conditions
4   warnings	Warning conditions
5   notices	Normal, but significant, conditions
6   informational	Informational messages
7   debugging	Debug-level messages
program	Filter messages by program. Include messages from a specified program.
<program-name>	The name of a program to log messages from. You can enter either one of the following predefined program names (depending on your device model), or another program name that you find in the log output. The pre-defined names are not case sensitive but other program names from the log output are.
rip	Routing Information Protocol (RIP)
ripng	Routing Information Protocol - next generation (RIPng)
ospf	Open Shortest Path First (OSPF)
ospfv3	Open Shortest Path First (OSPF) version 3 (OSPFv3)
bgp	Border Gateway Protocol (BGP)
rsvp	Resource Reservation Protocol (RSVP)
pim-dm	Protocol Independent Multicast - Dense Mode (PIM-DM)
pim-sm	Protocol Independent Multicast - Sparse Mode (PIM-SM)
pim-smv6	PIM-SM version 6 (PIM-SMv6)

Parameter	Description
dot1x	IEEE 802.1X Port-Based Access Control
lacp	Link Aggregation Control Protocol (LACP)
stp	Spanning Tree Protocol (STP)
rstp	Rapid Spanning Tree Protocol (RSTP)
mstp	Multiple Spanning Tree Protocol (MSTP)
imi	Integrated Management Interface (IMI)
imish	Integrated Management Interface Shell (IMISH)
epsr	Ethernet Protection Switched Rings (EPSR)
irdp	ICMP Router Discovery Protocol (IRDP)
rmon	Remote Monitoring
loopprot	Loop Protection
poe	Power-inline (Power over Ethernet)
dhcpcsn	DHCP snooping (DHPCPSN)
facility	Filter messages by syslog facility.
<facility>	Specify one of the following syslog facilities to include messages from:
kern	Kernel messages
user	Random user-level messages
mail	Mail system
daemon	System daemons
auth	Security/authorization messages
syslog	Messages generated internally by syslogd
lpr	Line printer subsystem
news	Network news subsystem
uucp	UUCP subsystem
cron	Clock daemon
authpriv	Security/authorization messages (private)
ftp	FTP daemon
msgtext	Select messages containing a certain text string.
<text-string>	A text string to match (maximum 128 characters). This is case sensitive, and must be the last text on the command line.

**Default** By default there is a filter to select all messages. This filter may be removed and replaced by filters that are more selective.

**Mode** Global Configuration

**Examples** To create a filter to send all messages that are generated by authentication and have a severity of **info** or higher to terminal instances where the terminal monitor command has been given, use the following commands:

```
awplus# configure terminal
awplus(config)# log monitor level info program auth
```

To remove a filter that sends all messages generated by EPSR that have a severity of **notices** or higher to the terminal, use the following commands:

```
awplus# configure terminal
awplus(config)# no log monitor level notices program epsr
```

To remove a default filter that includes sending everything to the terminal, use the following commands:

```
awplus# configure terminal
awplus(config)# no log monitor level debugging
```

**Related commands**

- [default log monitor](#)
- [log monitor exclude](#)
- [show log config](#)
- [terminal monitor](#)

# log monitor exclude

**Overview** Use this command to prevent specified log messages from being displayed on a terminal, when **terminal monitor** is enabled. You can exclude messages on the basis of:

- the priority/severity of the message
- the program that generated the message
- the logging facility used
- a sub-string within the message, or
- a combination of some or all of these.

Use the **no** variant of this command to stop excluding the specified messages.

**Syntax** `log console exclude [level <level>] [program <program-name>]  
[facility <facility>] [msgtext <text-string>]`  
`no log console exclude [level <level>] [program <program-name>]  
[facility <facility>] [msgtext <text-string>]`

Parameter	Description
level	Exclude messages of the specified severity level.
<level>	The severity level to exclude. The level can be specified as one of the following numbers or level names, where 0 is the highest severity and 7 is the lowest severity:
0   emergencies	System is unusable
1   alerts	Action must be taken immediately
2   critical	Critical conditions
3   errors	Error conditions
4   warnings	Warning conditions
5   notices	Normal, but significant, conditions
6   informational	Informational messages
7   debugging	Debug-level messages
program	Exclude messages from a specified program.
<program-name>	The name of a program. You can enter either one of the following predefined program names (depending on your device model), or another program name that you find in the log output. The pre-defined names are not case sensitive but other program names from the log output are.
rip	Routing Information Protocol (RIP)
ripng	Routing Information Protocol - next generation (RIPng)
ospf	Open Shortest Path First (OSPF)
ospfv3	Open Shortest Path First (OSPF) version 3 (OSPFv3)

Parameter	Description
bgp	Border Gateway Protocol (BGP)
rsvp	Resource Reservation Protocol (RSVP)
pim-dm	Protocol Independent Multicast - Dense Mode (PIM-DM)
pim-sm	Protocol Independent Multicast - Sparse Mode (PIM-SM)
pim-smv6	PIM-SM version 6 (PIM-SMv6)
dot1x	IEEE 802.1X Port-Based Access Control
lacp	Link Aggregation Control Protocol (LACP)
stp	Spanning Tree Protocol (STP)
rstp	Rapid Spanning Tree Protocol (RSTP)
mstp	Multiple Spanning Tree Protocol (MSTP)
imi	Integrated Management Interface (IMI)
imish	Integrated Management Interface Shell (IMISH)
epsr	Ethernet Protection Switched Rings (EPSR)
irdp	ICMP Router Discovery Protocol (IRDP)
rmon	Remote Monitoring
loopprot	Loop Protection
poe	Power-inline (Power over Ethernet)
dhcpsn	DHCP snooping (DHCP SN)
facility	Exclude messages from a syslog facility.
<facility>	Specify one of the following syslog facilities to exclude messages from:
kern	Kernel messages
user	Random user-level messages
mail	Mail system
daemon	System daemons
auth	Security/authorization messages
syslog	Messages generated internally by syslogd
lpr	Line printer subsystem
news	Network news subsystem
uucp	UUCP subsystem
cron	Clock daemon
authpriv	Security/authorization messages (private)
ftp	FTP daemon



Parameter	Description
msgtext	Exclude messages containing a certain text string.
<text-string>	A text string to match (maximum 128 characters). This is case sensitive, and must be the last text on the command line.

**Default** No log messages are excluded

**Mode** Global configuration

**Example** To remove messages that contain the string “example of irrelevant message”, use the following commands:

```
awplus# configure terminal
awplus(config)# log monitor exclude msgtext example of
irrelevant message
```

**Related commands**

- default log monitor
- log monitor (filter)
- show log config
- terminal monitor

# log permanent

**Overview** This command configures the device to send permanent log messages to Flash memory on the device. The content of the permanent log is retained over a reboot. Once the permanent log reaches its configured maximum allowable size old messages will be deleted to make way for new messages.

The **no** variant of this command configures the device not to send any messages to the permanent log. Log messages will not be retained over a restart.

**Syntax** log permanent  
no log permanent

**Mode** Global Configuration

**Examples** To enable permanent logging use the following commands:

```
awplus# configure terminal
awplus(config)# log permanent
```

To disable permanent logging use the following commands:

```
awplus# configure terminal
awplus(config)# no log permanent
```

**Related commands**

- clear log permanent
- copy permanent-log
- default log permanent
- log permanent (filter)
- log permanent exclude
- log permanent size
- show log config
- show log permanent

# log permanent (filter)

**Overview** This command creates a filter to select messages to be sent to the permanent log. Selection can be based on the priority/ severity of the message, the program that generated the message, the logging facility used, a sub-string within the message or a combination of some or all of these.

The **no** variant of this command removes the corresponding filter, so that the specified messages are no longer sent to the permanent log.

**Syntax** `log permanent [level <level>] [program <program-name>]  
[facility <facility>] [msgtext <text-string>]`  
`no log permanent [level <level>] [program <program-name>]  
[facility <facility>] [msgtext <text-string>]`

Parameter	Description
level	Filter messages sent to the permanent log by severity level.
<level>	The minimum severity of message to send. The level can be specified as one of the following numbers or level names, where 0 is the highest severity and 7 is the lowest severity:
0   emergencies	System is unusable
1   alerts	Action must be taken immediately
2   critical	Critical conditions
3   errors	Error conditions
4   warnings	Warning conditions
5   notices	Normal, but significant, conditions
6   informational	Informational messages
7   debugging	Debug-level messages
program	Filter messages by program. Include messages from a specified program.
<program-name>	The name of a program to log messages from. You can enter either one of the following predefined program names (depending on your device model), or another program name that you find in the log output. The pre-defined names are not case sensitive but other program names from the log output are.
rip	Routing Information Protocol (RIP)
ripng	Routing Information Protocol - next generation (RIPng)
ospf	Open Shortest Path First (OSPF)
ospfv3	Open Shortest Path First (OSPF) version 3 (OSPFv3)
bgp	Border Gateway Protocol (BGP)
rsvp	Resource Reservation Protocol (RSVP)
pim-dm	Protocol Independent Multicast - Dense Mode (PIM-DM)
pim-sm	Protocol Independent Multicast - Sparse Mode (PIM-SM)

Parameter	Description
<code>pim-smv6</code>	PIM-SM version 6 (PIM-SMv6)
<code>dot1x</code>	IEEE 802.1X Port-Based Access Control
<code>lacp</code>	Link Aggregation Control Protocol (LACP)
<code>stp</code>	Spanning Tree Protocol (STP)
<code>rstp</code>	Rapid Spanning Tree Protocol (RSTP)
<code>mstp</code>	Multiple Spanning Tree Protocol (MSTP)
<code>imi</code>	Integrated Management Interface (IMI)
<code>imish</code>	Integrated Management Interface Shell (IMISH)
<code>epsr</code>	Ethernet Protection Switched Rings (EPSR)
<code>irdp</code>	ICMP Router Discovery Protocol (IRDP)
<code>rmon</code>	Remote Monitoring
<code>loopprot</code>	Loop Protection
<code>poe</code>	Power-inline (Power over Ethernet)
<code>dhcpcsn</code>	DHCP snooping (DHPCPSN)
<code>facility</code>	Filter messages by syslog facility.
<code>&lt;facility&gt;</code>	Specify one of the following syslog facilities to include messages from:
<code>kern</code>	Kernel messages
<code>user</code>	Random user-level messages
<code>mail</code>	Mail system
<code>daemon</code>	System daemons
<code>auth</code>	Security/authorization messages
<code>syslog</code>	Messages generated internally by syslogd
<code>lpr</code>	Line printer subsystem
<code>news</code>	Network news subsystem
<code>uucp</code>	UUCP subsystem
<code>cron</code>	Clock daemon
<code>authpriv</code>	Security/authorization messages (private)
<code>ftp</code>	FTP daemon
<code>msgtext</code>	Select messages containing a certain text string.
<code>&lt;text-string&gt;</code>	A text string to match (maximum 128 characters). This is case sensitive, and must be the last text on the command line.

**Default** By default the buffered log has a filter to select messages whose severity level is `notices` (5) or higher. This filter may be removed using the **no** variant of this command.

**Mode** Global Configuration

**Examples** To create a filter to send all messages generated by EPSR that have a severity of notices or higher to the permanent log use the following commands:

```
awplus# configure terminal
awplus(config)# log permanent level notices program epsr
```

To create a filter to send all messages containing the text "Bridging initialization", to the permanent log use the following commands:

```
awplus# configure terminal
awplus(config)# log permanent msgtext Bridging initialization
```

**Related commands**

- clear log permanent
- default log permanent
- log permanent
- log permanent exclude
- log permanent size
- show log config
- show log permanent

# log permanent exclude

**Overview** Use this command to prevent specified log messages from being sent to the permanent log. You can exclude messages on the basis of:

- the priority/severity of the message
- the program that generated the message
- the logging facility used
- a sub-string within the message, or
- a combination of some or all of these.

Use the **no** variant of this command to stop excluding the specified messages.

**Syntax** `log permanent exclude [level <level>] [program <program-name>] [facility <facility>] [msgtext <text-string>]`  
`no log permanent exclude [level <level>] [program <program-name>] [facility <facility>] [msgtext <text-string>]`

Parameter	Description
level	Exclude messages of the specified severity level.
<level>	The severity level to exclude. The level can be specified as one of the following numbers or level names, where 0 is the highest severity and 7 is the lowest severity:
0   emergencies	System is unusable
1   alerts	Action must be taken immediately
2   critical	Critical conditions
3   errors	Error conditions
4   warnings	Warning conditions
5   notices	Normal, but significant, conditions
6   informational	Informational messages
7   debugging	Debug-level messages
program	Exclude messages from a specified program.
<program-name>	The name of a program. You can enter either one of the following predefined program names (depending on your device model), or another program name that you find in the log output. The pre-defined names are not case sensitive but other program names from the log output are.
rip	Routing Information Protocol (RIP)
ripng	Routing Information Protocol - next generation (RIPng)
ospf	Open Shortest Path First (OSPF)
ospfv3	Open Shortest Path First (OSPF) version 3 (OSPFv3)
bgp	Border Gateway Protocol (BGP)

Parameter	Description
rsvp	Resource Reservation Protocol (RSVP)
pim-dm	Protocol Independent Multicast - Dense Mode (PIM-DM)
pim-sm	Protocol Independent Multicast - Sparse Mode (PIM-SM)
pim-smv6	PIM-SM version 6 (PIM-SMv6)
dot1x	IEEE 802.1X Port-Based Access Control
lacp	Link Aggregation Control Protocol (LACP)
stp	Spanning Tree Protocol (STP)
rstp	Rapid Spanning Tree Protocol (RSTP)
mstp	Multiple Spanning Tree Protocol (MSTP)
imi	Integrated Management Interface (IMI)
imish	Integrated Management Interface Shell (IMISH)
epsr	Ethernet Protection Switched Rings (EPSR)
irdp	ICMP Router Discovery Protocol (IRDP)
rmon	Remote Monitoring
loopprot	Loop Protection
poe	Power-inline (Power over Ethernet)
dhcpsn	DHCP snooping (DHCP SN)
facility	Exclude messages from a syslog facility.
<facility>	Specify one of the following syslog facilities to exclude messages from:
kern	Kernel messages
user	Random user-level messages
mail	Mail system
daemon	System daemons
auth	Security/authorization messages
syslog	Messages generated internally by syslogd
lpr	Line printer subsystem
news	Network news subsystem
uucp	UUCP subsystem
cron	Clock daemon
authpriv	Security/authorization messages (private)
ftp	FTP daemon
msgtext	Exclude messages containing a certain text string.
<text-string>	A text string to match (maximum 128 characters). This is case sensitive, and must be the last text on the command line.

**Default** No log messages are excluded

**Mode** Global configuration

**Example** To remove messages that contain the string “example of irrelevant message”, use the following commands:

```
awplus# configure terminal
awplus(config)# log permanent exclude msgtext example of
irrelevant message
```

**Related commands**

- clear log permanent
- default log permanent
- log permanent
- log permanent (filter)
- log permanent size
- show log config
- show log permanent



# log permanent size

**Overview** This command configures the amount of memory that the permanent log is permitted to use. Once this memory allocation has been filled old messages will be deleted to make room for new messages.

Use the **no** variant of this command to return to the default.

**Syntax** `log permanent size <50-250>`  
`no log permanent size`

Parameter	Description
<50-250>	Size of the permanent log in kilobytes

**Default** 50 kilobytes

**Mode** Global Configuration

**Example** To allow the permanent log to use up to 100 kilobytes of flash, use the commands:

```
awplus# configure terminal
awplus(config)# log permanent size 100
```

To return to the default value, use the commands:

```
awplus# configure terminal
awplus(config)# no log permanent size
```

**Related commands**

- [clear log permanent](#)
- [copy permanent-log](#)
- [default log permanent](#)
- [log permanent](#)
- [log permanent \(filter\)](#)
- [log permanent exclude](#)
- [show log config](#)
- [show log permanent](#)

# log-rate-limit nsm

**Overview** This command limits the number of log messages generated by the device for a given interval.

Use the **no** variant of this command to revert to the default number of log messages generated by the device of up to 200 log messages per second.

**Syntax** `log-rate-limit nsm messages <message-limit> interval <time-interval>`  
`no log-rate-limit nsm`

Parameter	Description
<code>&lt;message-limit&gt;</code>	<code>&lt;1-65535&gt;</code> The number of log messages generated by the device.
<code>&lt;time-interval&gt;</code>	<code>&lt;0-65535&gt;</code> The time period for log message generation in 1/100 seconds. If an interval of 0 is specified then no log message rate limiting is applied.

**Default** By default, the device will allow 200 log messages to be generated per second.

**Mode** Global Configuration

**Usage notes** This log rate limiting feature constrains the rate that log messages are generated by the device. This makes sure that the device does not run out of memory from generating a lot of log messages in extreme circumstances, such as if a packet storm occurs.

Note that if within the given time interval, the number of log messages exceeds the limit, then any excess log messages are discarded. At the end of the time interval, a single log message is generated indicating that log messages were discarded due to the log rate limit being exceeded.

If you expect that there will be a lot of discarded log messages due to log rate limiting, then we recommend setting the time interval to no less than 100, which means that there would only be one log message, indicating excessive log messages have been discarded.

**Examples** To limit the device to generate up to 300 log messages per second, use the following commands:

```
awplus# configure terminal
awplus(config)# log-rate-limit nsm messages 300 interval 100
```

To return the device the default setting, to generate up to 200 log messages per second, use the following commands:

```
awplus# configure terminal
awplus(config)# no log-rate-limit nsm
```

# log trustpoint

**Overview** This command adds one or more trustpoints to be used with the syslog application. Multiple trustpoints may be specified, or the command may be executed multiple times, to add multiple trustpoints to the application.

The **no** version of this command removes one or more trustpoints from the list of trustpoints associated with the application.

**Syntax** `log trustpoint [<trustpoint-list>]`  
`no log trustpoint [<trustpoint-list>]`

Parameter	Description
<code>&lt;trustpoint-list&gt;</code>	Specify one or more trustpoints to be added or deleted.

**Default** No trustpoints are created by default.

**Mode** Global Configuration

**Usage notes** The device certificate associated with first trustpoint added to the application will be transmitted to remote servers. The certificate received from the remote server must have an issuer chain that terminates with the root CA certificate for any of the trustpoints that are associated with the application.

If no trustpoints are specified in the command, the trustpoint list will be unchanged.

If **no log trustpoint** is issued without specifying any trustpoints, then all trustpoints will be disassociated from the application.

**Example** You can add multiple trustpoints by executing the command multiple times:

```
awplus# configure terminal
awplus(config)# log trustpoint trustpoint_1
awplus(config)# log trustpoint trustpoint_2
```

Alternatively, add multiple trustpoints with a single command:

```
awplus(config)# log trustpoint trustpoint_2 trustpoint_3
```

Disassociate all trustpoints from the syslog application using the command:

```
awplus(config)# log trustpoint trustpoint_2 trustpoint_3
```

**Related commands** [log host](#)  
[show log config](#)

# show counter log

**Overview** This command displays log counter information.

**Syntax** show counter log

**Mode** User Exec and Privileged Exec

**Example** To display the log counter information, use the command:

```
awplus# show counter log
```

**Output** Figure 9-1: Example output from the **show counter log** command

```
Log counters
Total Received      ..... 2328
Total Received P0   ..... 0
Total Received P1   ..... 0
Total Received P2   ..... 1
Total Received P3   ..... 9
Total Received P4   ..... 32
Total Received P5   ..... 312
Total Received P6   ..... 1602
Total Received P7   ..... 372
```

**Table 10:** Parameters in output of the **show counter log** command

Parameter	Description
Total Received	Total number of messages received by the log
Total Received P0	Total number of Priority 0 (Emergency) messages received
Total Received P1	Total number of Priority 1 (Alert) messages received
Total Received P2	Total number of Priority 2 (Critical) messages received
Total Received P3	Total number of Priority 3 (Error) messages received
Total Received P4	Total number of Priority 4 (Warning) messages received
Total Received P5	Total number of Priority 5 (Notice) messages received
Total Received P6	Total number of Priority 6 (Info) messages received
Total Received P7	Total number of Priority 7 (Debug) messages received

**Related commands** [show log config](#)

# show exception log

**Overview** This command displays the contents of the exception log.

**Syntax** show exception log

**Mode** User Exec and Privileged Exec

**Example** To display the exception log, use the command:

```
awplus# show exception log
```

**Output** Figure 9-2: Example output from the **show exception log** command on a device

```
awplus#show exception log

<date> <time> <facility>.<severity> <program[<pid>]: <message>
-----
2019 Sep 29 06:07:24 local7.debug awplus corehandler : Process imi (PID:775) signal
5, core dumped to /flash/imi-example-5.4.9-1.4-1-1569737243-775.tgz
-----
```

**Output** Figure 9-3: Example output from the **show exception log** command on a device that has never had an exception occur

```
awplus#show exception log

<date> <time> <facility>.<severity> <program[<pid>]: <message>
-----
None
-----
awplus#
```

# show log

**Overview** This command displays the contents of the buffered log.  
For information on filtering and saving command output, see the [“Getting Started with AlliedWare\\_Plus” Feature Overview and Configuration Guide](#).

**Syntax** `show log [tail [<10-250>]]`

Parameter	Description
tail	Display only the latest log entries.
<10-250>	Specify the number of log entries to display.

**Default** By default the entire contents of the buffered log is displayed.

**Mode** User Exec, Privileged Exec and Global Configuration

**Usage notes** If the optional **tail** parameter is specified, only the latest 10 messages in the buffered log are displayed. A numerical value can be specified after the **tail** parameter to select how many of the latest messages should be displayed.

The **show log** command is only available to users at privilege level 7 and above. To set a user’s privilege level, use the command:

```
awplus(config)# username <name> privilege <1-15>
```

**Examples** To display the contents of the buffered log use the command:

```
awplus# show log
```

To display the 10 latest entries in the buffered log use the command:

```
awplus# show log tail 10
```

**Output** Figure 9-4: Example output from **show log**

```
awplus#show log

<date> <time> <facility>.<severity> <program[<pid>]>: <message>
-----
2019 May 29 07:55:22 kern.notice awplus kernel: Linux version 2.6.32.12-at1 (mak
er@awpmaker03-dl) (gcc version 4.3.3 (Gentoo 4.3.3-r3 pl.2, pie-10.1.5) ) #1 Wed
Dec 8 11:53:40 NZDT 2010
2019 May 29 07:55:22 kern.warning awplus kernel: No pci config register base in
dev tree, using default
2019 May 29 07:55:23 kern.notice awplus kernel: Kernel command line: console=tty
S0,9600 releasefile= ramdisk=14688 bootversion=1.1.0-rc12 loglevel=1
extraflash=00000000
2019 May 29 07:55:25 kern.notice awplus kernel: RAMDISK: squashfs filesystem fou
nd at block 0
2019 May 29 07:55:28 kern.warning awplus kernel: ipifwd: module license 'Proprie
tary' taints kernel.
...
```

- Related commands**
- [clear log buffered](#)
  - [copy buffered-log](#)
  - [default log buffered](#)
  - [log buffered](#)
  - [log buffered \(filter\)](#)
  - [log buffered size](#)
  - [log buffered exclude](#)
  - [show log config](#)

# show log config

**Overview** This command displays information about the logging system. This includes the configuration of the various log destinations, such as buffered, permanent, syslog servers (hosts) and email addresses. This also displays the latest status information for each log destination.

**Syntax** `show log config`

**Mode** User Exec, Privileged Exec and Global Configuration

**Example** To display the logging configuration use the command:

```
awplus# show log config
```

**Output** Figure 9-5: Example output from **show log config**

```
Facility: default
PKI trustpoints: example_trustpoint

Buffered log:
Status ..... enabled
Maximum size ... 100kb
Filters:
*1 Level ..... notices
  Program ..... any
  Facility ..... any
  Message text . any
  2 Level ..... informational
  Program ..... auth
  Facility ..... daemon
  Message text . any
  Statistics .... 1327 messages received, 821 accepted by filter (2016 Oct 11
10:36:16)
Permanent log:
Status ..... enabled
Maximum size ... 60kb
Filters:
 1 Level ..... error
  Program ..... any
  Facility ..... any
  Message text . any
*2 Level ..... warnings
  Program ..... dhcp
  Facility ..... any
  Message text . "pool exhausted"
  Statistics .... 1327 messages received, 12 accepted by filter (2016 Oct 11
10:36:16)
```



```
Host 10.32.16.21:
  Time offset .... +2:00
  Offset type .... UTC
  Source ..... -
  Secured ..... enabled
  Filters:
  1 Level ..... critical
    Program ..... any
    Facility ..... any
    Message text . any
  Statistics ..... 1327 messages received, 1 accepted by filter (2016 Oct 11
10:36:16)
Email admin@alliedtelesis.com:
  Time offset .... +0:00
  Offset type .... Local
  Filters:
  1 Level ..... emergencies
    Program ..... any
    Facility ..... any
    Message text . any
  Statistics ..... 1327 messages received, 0 accepted by filter (2016 Oct 11
10:36:16)
...
```

In the above example the '\*' next to filter 1 in the buffered log configuration indicates that this is the default filter. The permanent log has had its default filter removed, so none of the filters are marked with '\*'.

**NOTE:** Terminal log and console log cannot be set at the same time. If console logging is enabled then the terminal logging is turned off.

- Related commands**
- [show counter log](#)
  - [show log](#)
  - [show log permanent](#)

# show log external

**Overview** Use this command to display the contents of the external log, which is stored on an SD card.

**Syntax** `show log external [tail [<10-250>]]`

Parameter	Description
tail	Display only the latest log entries.
<10-250>	Specify the number of log entries to display.

**Mode** Global Configuration

Privileged Exec

User Exec

**Usage notes** If the optional **tail** parameter is specified, only the latest 10 messages in the permanent log are displayed. A numerical value can be specified after the **tail** parameter to change how many of the latest messages should be displayed.

**Example** To display the last 5 entries in the external log, use the command:

```
awplus# show log external tail 5
```

**Related commands**

- [clear log external](#)
- [default log external](#)
- [log external](#)
- [log external \(filter\)](#)
- [log external exclude](#)
- [log external rotate](#)
- [log external size](#)
- [show log config](#)
- [unmount](#)

**Command changes** Version 5.4.7-1.1: command added

# show log permanent

**Overview** This command displays the contents of the permanent log.

**Syntax** show log permanent [tail [<10-250>]]

Parameter	Description
tail	Display only the latest log entries.
<10-250>	Specify the number of log entries to display.

**Usage notes** If the optional **tail** parameter is specified only, the latest 10 messages in the permanent log are displayed. A numerical value can be specified after the **tail** parameter to change how many of the latest messages should be displayed.

**Mode** User Exec, Privileged Exec and Global Configuration

**Example** To display the permanent log, use the command:

```
awplus# show log permanent
```

**Output** Figure 9-6: Example output from **show log permanent**

```
awplus#show log permanent

<date> <time> <facility>.<severity> <program[<pid>]>: <message>
-----
2014 Jun 10 09:30:09 syslog.notice syslog-ng[67]: syslog-ng starting up;
version='\2.0rc3\'
2014 Jun 10 09:30:09 auth.warning portmap[106]: user rpc not found, reverting to
user bin
2014 Jun 10 09:30:09 cron.notice crond[116]: crond 2.3.2 dillon, started, log
level 8
2014 Jun 10 09:30:14 daemon.err snmpd[181]: /flash/.configs/snmpd.conf: line 20:
Error: bad SUBTREE object
2014 Jun 10 09:30:14 user.info HSL[192]: HSL: INFO: Registering port port1.0.1
```

- Related commands**
- [clear log permanent](#)
  - [copy permanent-log](#)
  - [default log permanent](#)
  - [log permanent](#)
  - [log permanent \(filter\)](#)
  - [log permanent exclude](#)
  - [log permanent size](#)
  - [show log config](#)

# show running-config log

**Overview** This command displays the current running configuration of the Log utility.

**Syntax** `show running-config log`

**Mode** Privileged Exec and Global Configuration

**Example** To display the current configuration of the log utility, use the command:

```
awplus# show running-config log
```

**Related commands** [show log](#)  
[show log config](#)

# unmount

**Overview** Use this command to unmount an external storage device. We recommend you unmount storage devices before removing them, to avoid file corruption. This is especially important if files may be automatically written to the storage device, such as external log files or AMF backup files.

**Syntax** `unmount card`

Parameter	Description
card	Unmount the SD card.

**Mode** Privileged Exec

**Example** To unmount an SD card and safely remove it from the device, use the command:

```
awplus# unmount card
```

**Related commands**

- [clear log external](#)
- [log external](#)
- [show file systems](#)
- [show log config](#)
- [show log external](#)

**Command changes** Version 5.4.7-1.1: command added

# 10

# Scripting Commands

## Introduction

**Overview** This chapter provides commands used for command scripts.

- Command List**
- [“activate”](#) on page 375
  - [“echo”](#) on page 376
  - [“wait”](#) on page 377

# activate

**Overview** This command activates a script file.

**Syntax** activate [background] <script>

Parameter	Description
background	Activate a script to run in the background. A process that is running in the background will operate as a separate task, and will not interrupt foreground processing. Generally, we recommend running short, interactive scripts in the foreground and longer scripts in the background. The default is to run the script in the foreground.
<script>	The file name of the script to activate. The script is a command script consisting of commands documented in this software reference. Note that you must use either a <b>.scp</b> or a <b>.sh</b> filename extension for a valid script text file, as described below in the usage section for this command.

**Mode** Privileged Exec

**Usage notes** When a script is activated, the privilege level is set to 1 enabling User Exec commands to run in the script. If you need to run Privileged Exec commands in your script you need to add an [enable \(Privileged Exec mode\)](#) command to the start of your script. If you need to run Global Configuration commands in your script you need to add a [configure terminal](#) command after the **enable** command at the start of your script.

The **activate** command executes the script in a new shell. A [terminal length](#) shell command, such as **terminal length 0** may also be required to disable a delay that would pause the display.

A script must be a text file with a filename extension of either **.sh** or **.scp** only for the AlliedWare Plus™ CLI to activate the script file. The **.sh** filename extension indicates the file is an ASH script, and the **.scp** filename extension indicates the file is an AlliedWare Plus™ script.

**Examples** To activate a command script to run as a background process, use the command:

```
awplus# activate background test.scp
```

**Related commands**

- [configure terminal](#)
- [echo](#)
- [enable \(Privileged Exec mode\)](#)
- [wait](#)

# echo

**Overview** This command echoes a string to the terminal, followed by a blank line.

**Syntax** `echo <line>`

Parameter	Description
<code>&lt;line&gt;</code>	The string to echo

**Mode** User Exec and Privileged Exec

**Usage** This command may be useful in CLI scripts, to make the script print user-visible comments.

**Example** To echo the string `Hello World` to the console, use the command:

```
awplus# echo Hello World
```

## Output

```
Hello World
```

**Related commands** [activate](#)  
[wait](#)



# wait

**Overview** This command pauses execution of the active script for the specified period of time.

**Syntax** `wait <delay>`

Parameter	Description
<code>&lt;delay&gt;</code>	<code>&lt;1-65335&gt;</code> Specify the time delay in seconds

**Default** No wait delay is specified by default.

**Mode** Privileged Exec (when executed from a script not directly from the command line)

**Usage notes** Use this command to pause script execution in an **.scp** (AlliedWare Plus™ script) or an **.sh** (ASH script) file executed by the [activate](#) command. The script must contain an **enable** command, because the **wait** command is only executed in the Privileged Exec mode.

**Example** See an **.scp** script file extract below that will show port counters for interface port1.0.2 over a 10 second interval:

```
enable

show interface port1.0.2

wait 10

show interface port1.0.2
```

**Related commands**

- [activate](#)
- [echo](#)
- [enable \(Privileged Exec mode\)](#)

# 11

# Interface Commands

## Introduction

**Overview** This chapter provides an alphabetical reference of commands used to configure and display interfaces.

- Command List**
- “[description \(interface\)](#)” on page 379
  - “[interface \(to configure\)](#)” on page 380
  - “[mru](#)” on page 382
  - “[mtu](#)” on page 383
  - “[service statistics interfaces counter](#)” on page 384
  - “[show interface](#)” on page 385
  - “[show interface brief](#)” on page 388
  - “[show interface memory](#)” on page 389
  - “[show interface status](#)” on page 391
  - “[shutdown](#)” on page 393

# description (interface)

**Overview** Use this command to add a description to a specific port or interface.

**Syntax** `description <description>`

Parameter	Description
<code>&lt;description&gt;</code>	Text describing the specific interface. Descriptions can contain any printable ASCII characters (ASCII 32-126).

**Mode** Interface Configuration

**Example** The following example uses this command to describe the device that a switch port is connected to.

```
awplus# configure terminal
awplus(config)# interface port1.0.2
awplus(config-if)# description Boardroom PC
```

**Command changes** Version 5.4.7-1.1: valid character set changed to printable ASCII characters

# interface (to configure)

**Overview** Use this command to select one or more interfaces to configure.

**Syntax** `interface <interface-list>`

Parameter	Description
<code>&lt;interface-list&gt;</code>	<p>The interfaces to configure. An interface-list can be:</p> <ul style="list-style-type: none"><li>• a VLAN (e.g. vlan2)</li><li>• a switchport (e.g. port1.0.4)</li><li>• a static channel group (e.g. sa2)</li><li>• a dynamic (LACP) channel group (e.g. po2)</li><li>• the loopback interface (lo)</li><li>• a continuous range of interfaces separated by a hyphen (e.g. vlan10-20)</li><li>• a comma-separated list (e.g. vlan1,vlan10-20). Do not mix interface types in a list.</li></ul> <p>The specified interfaces must exist.</p>

**Usage notes** A local loopback interface is one that is always available for higher layer protocols to use and advertise to the network. Although a local loopback interface is assigned an IP address, it does not have the usual requirement of connecting to a lower layer physical entity. This lack of physical attachment creates the perception of a local loopback interface always being accessible via the network.

Local loopback interfaces can be utilized by a number of protocols for various purposes. They can be used to improve access to the device and also increase its reliability, security, scalability and protection. In addition, local loopback interfaces can add flexibility and simplify management, information gathering and filtering.

**Mode** Global Configuration

**Example** The following example shows how to enter Interface mode to configure vlan1. Note how the prompt changes.

```
awplus# configure terminal
awplus(config)# interface vlan1
awplus(config-if)#
```

The following example shows how to enter Interface mode to configure the local loopback interface.

```
awplus# configure terminal
awplus(config)# interface lo
awplus(config-if)#
```

**Related commands** ip address (IP Addressing and Protocol)  
show interface  
show interface brief

# mru

**Overview** Use this command to set the Maximum Receive Unit (MRU) size for switch ports, where MRU is the maximum frame size (excluding headers) that switch ports can receive. For more information, see the [Switching Feature Overview and Configuration Guide](#).

Use the **no** variant of this command to remove a previously specified Maximum Receive Unit (MRU) size for switch ports, and restore the default MRU size (1500 bytes) for switch ports.

**NOTE:** The MRU sizes specify the payload only. For an IEEE 802.1q frame, provision is made (internally) for the following additional components:

- Source and Destination addresses
- EtherType field
- Priority and VLAN tag fields
- FCS

These additional components increase the frame size internally by 22 bytes. For example, the default frame size is 1522 bytes, including headers.

**Syntax** `mru <mru-size>`  
`no mru`

Parameter	Description
<code>&lt;mru-size&gt;</code>	68-16335. This value specifies the Maximum Receive Unit (MRU) size in bytes, where 1500 bytes is the default Ethernet MRU size for an interface.

**Default** The default MRU size is 1500 bytes for switch ports.

**Mode** Interface Configuration for switch ports.

**Examples** To configure an MRU of 16335 bytes on port1.0.2, use the commands:

```
awplus# configure terminal
awplus(config)# interface port1.0.2
awplus(config-if)# mru 16335
```

To restore the MRU default size of 1500 bytes on port1.0.2, use the commands:

```
awplus# configure terminal
awplus(config)# interface port1.0.2
awplus(config-if)# no mru
```

**Related commands** [show interface](#)

# mtu

**Overview** Use this command to set the Maximum Transmission Unit (MTU) size for interfaces, where MTU is the maximum packet size that interfaces can transmit. The MTU size setting is applied to both IPv4 and IPv6 packet transmission.

Use the **no** variant of this command to remove a previously specified Maximum Transmission Unit (MTU) size, and restore the default MTU size. For example the VLAN interface default is 1500 bytes.

**Syntax** `mtu <68-1582>`  
`no mtu`

**Default** The default MTU size, for example 1500 bytes for VLAN interfaces.

**Mode** Interface Configuration

**Usage notes** If a device receives an IPv4 packet for Layer 3 switching to another interface with an MTU size smaller than the packet size, and if the packet has the **'don't fragment'** bit set, then the device will send an ICMP **'destination unreachable'** (3) packet type and a **'fragmentation needed and DF set'** (4) code back to the source. For IPv6 packets bigger than the MTU size of the transmitting interface, an ICMP **'packet too big'** (ICMP type 2 code 0) message is sent to the source.

Note that [show interface](#) output will only show MTU size for VLAN interfaces.

**Examples** To configure an MTU size of 1500 bytes on vlan2, use the commands:

```
awplus# configure terminal
awplus(config)# interface vlan2
awplus(config-if)# mtu 1500
```

To restore the MTU size to the default MTU size of 1500 bytes on vlan2, use the commands:

```
awplus# configure terminal
awplus(config)# interface vlan2
awplus(config-if)# no mtu
```

**Related commands** [show interface](#)

# service statistics interfaces counter

- Overview** Use this command to enable the interface statistics counter.  
Use the **no** variant of this command to disable the interface statistics counter.
- Syntax** `service statistics interfaces counter`  
`no service statistics interfaces counter`
- Default** The interface statistics counter is enabled by default.
- Mode** Global Configuration
- Example** To enable the interface statistics counter, use the following commands:  
`awplus# configure terminal`  
`awplus(config)# service statistics interfaces counter`  
To disable the interface statistics counter, use the following commands:  
`awplus# configure terminal`  
`awplus(config)# no service statistics interfaces counter`
- Command changes** Version 5.4.7-2.1: command added



# show interface

**Overview** Use this command to display interface configuration and status.

For information on filtering and saving command output, see the [“Getting Started with AlliedWare Plus” Feature Overview and Configuration Guide](#).

**Syntax** `show interface [<interface-list>]`

Parameter	Description
<code>&lt;interface-list&gt;</code>	The interfaces or ports to display. An interface-list can be: <ul style="list-style-type: none"><li>• a VLAN (e.g. vlan2)</li><li>• a switchport (e.g. port1.0.4)</li><li>• a static channel group (e.g. sa2)</li><li>• a dynamic (LACP) channel group (e.g. po2)</li><li>• the loopback interface (lo)</li><li>• a continuous range of interfaces separated by a hyphen (e.g. vlan10-20)</li><li>• a comma-separated list (e.g. vlan1,vlan10-20). Do not mix interface types in a list.</li></ul> The specified interfaces must exist.

**Mode** User Exec and Privileged Exec

**Usage notes** Note that the output displayed with this command will show MTU (Maximum Transmission Unit) size for VLAN interfaces, and MRU (Maximum Received Unit) size for switch ports.

**Example** To display configuration and status information for all interfaces, use the command:

```
awplus# show interface
```

Figure 11-1: Example output from the **show interface** command

```
awplus#show interface
Interface port1.0.1
  Scope: both
  Link is UP, administrative state is UP
  Thrash-limiting
    Status Not Detected, Action learn-disable, Timeout 1(s)
  Hardware is Ethernet, address is 00c0.ffee.0401
  index 5001 metric 1 mru 1500
  current duplex full, current speed 1000, current polarity mdix
  configured duplex auto, configured speed auto, configured polarity auto
  <UP,BROADCAST,RUNNING,MULTICAST>
  SNMP link-status traps: Disabled
  input packets 2901115, bytes 212107158, dropped 0, multicast packets 1250912
  output packets 317532, bytes 29171173, multicast packets 3, broadcast packets 3
  input average rate : 30 seconds 5.09 Kbps, 5 minutes 3.72 Kbps
  output average rate: 30 seconds 1.36 Kbps, 5 minutes 477 bps
  input peak rate 152.06 Kbps at 2018/04/10 15:56:53
  output peak rate 6.78 Mbps at 2018/04/10 15:56:53
  Time since last state change: 7 days 03:06:10
  ...
```

To display configuration and status information for the loopback interface lo, use the command:

```
awplus# show interface lo
```

Figure 11-2: Example output from the **show interface lo** command

```
awplus#show interface lo
Interface lo
  Scope: both
  Link is UP, administrative state is UP
  Hardware is Loopback
  index 1 metric 1
  <UP,LOOPBACK,RUNNING>
  SNMP link-status traps: Disabled
  Router Advertisement is disabled
  Router Advertisement default routes are accepted
  Router Advertisement prefix info is accepted
  Time since last state change: 8 days 00:01:09
```

To display configuration and status information for interface vlan1, use the command:

```
awplus# show interface vlan1
```

Figure 11-3: Example output from the **show interface vlan1** command

```
awplus#show interface vlan1
Interface vlan1
  Link is UP, administrative state is UP
  Hardware is VLAN, address is 0000.cd38.026c
  IPv4 address 192.168.1.1/24 broadcast 192.168.1.255
  index 301 metric 1 mtu 1500
  arp ageing timeout 300
  <UP,BROADCAST,RUNNING,MULTICAST>
  VRF Binding: Not bound
  SNMP link-status traps: Disabled
  Router Advertisement is disabled
  Router Advertisement default routes are accepted
  Router Advertisement prefix info is accepted
  input packets 0, bytes 0, dropped 0, multicast packets 0
  output packets 9, bytes 612, multicast packets 0, broadcast packets 0
  input average rate : 30 seconds 0 bps, 5 minutes 0 bps
  output average rate: 30 seconds 0 bps, 5 minutes 0 bps
  output peak rate 140 bps at 2018/04/10 16:40:56
  Time since last state change: 8 days 19:09:19
```

**Related commands** [mru](#)  
[mtu](#)

[show interface brief](#)

**Command changes** Version 5.4.7-2.1: average rate and peak rate added to output

# show interface brief

**Overview** Use this command to display brief interface, configuration, and status information, including provisioning information.

For information on filtering and saving command output, see the [“Getting Started with AlliedWare Plus” Feature Overview and Configuration Guide](#).

**Syntax** `show interface brief`

**Mode** User Exec and Privileged Exec

**Output** Figure 11-4: Example output from **show interface brief**

```
awplus#show int brief
Interface          Status           Protocol
port1.0.1         admin up        down
port1.0.2         admin up        down
port1.0.3         admin up        down
port1.0.4         admin up        down
port1.0.5         admin up        down
port1.0.6         admin up        running
lo                 admin up        running
vlan1             admin up        down
vlan2             admin up        down
```

Table 11-1: Parameters in the output of **show interface brief**

Parameter	Description
Interface	The name or type of interface.
Status	The administrative state. This can be either <b>admin up</b> or <b>admin down</b> .
Protocol	The link state. This can be either <b>down</b> , <b>running</b> , or <b>provisioned</b> .

**Related commands** [show interface](#)  
[show interface memory](#)

# show interface memory

**Overview** This command displays the shared memory used by either all interfaces, or the specified interface or interfaces. The output is useful for diagnostic purposes by Allied Telesis authorized service personnel.

For information on filtering and saving command output, see the [“Getting Started with AlliedWare Plus” Feature Overview and Configuration Guide](#).

**Syntax** `show interface memory`  
`show interface <port-list> memory`

Parameter	Description
<code>&lt;port-list&gt;</code>	Display information about only the specified port or ports. The port list can be: <ul style="list-style-type: none"><li>• a switchport (e.g. port1.0.4)</li><li>• a static channel group (e.g. sa2)</li><li>• a dynamic (LACP) channel group (e.g. po2)</li><li>• a continuous range of ports separated by a hyphen (e.g. port1.0.1-1.0.4)</li><li>• a comma-separated list (e.g. port1.0.1,port1.0.3-1.0.4). Do not mix port types in the same list.</li></ul>

**Mode** User Exec and Privileged Exec

**Example** To display the shared memory used by all interfaces, use the command:

```
awplus# show interface memory
```

To display the shared memory used by port1.0.1 and port1.0.3 to port1.0.4, use the command:

```
awplus# show interface port1.0.1,port1.0.3-port1.0.4 memory
```

**Output** Figure 11-5: Example output from the **show interface memory** command

```
awplus#show interface memory
Vlan blocking state shared memory usage
-----
Interface    shmid      Bytes Used  natch  Status
port1.0.1    491535     512         1      1
port1.0.2    393228     512         1      1
port1.0.3    557073     512         1      1
...
lo           425997     512         1      1
po1         1179684     512         1      1
po2         1212453     512         1      1
sa3         1245222     512         1      1
```

Figure 11-6: Example output from **show interface <port-list> memory** for a list of interfaces

```
awplus#show interface port1.0.1,port1.0.3-port1.0.4 memory
Vlan blocking state shared memory usage
-----
Interface      shmid      Bytes Used  natch      Status
port1.0.1      589842     512         1          1
port1.0.3      688149     512         1          1
port1.0.4      327690     512         1          1
```

**Related  
commands**

- [show interface brief](#)
- [show interface status](#)
- [show interface switchport](#)

# show interface status

**Overview** Use this command to display the status of the specified interface or interfaces. Note that when no interface or interfaces are specified then the status of all interfaces on the device are shown.

**Syntax** `show interface [<port-list>] status`

Parameter	Description
<code>&lt;port-list&gt;</code>	The ports to display information about. The port list can be: <ul style="list-style-type: none"><li>• a switchport (e.g. port1.0.4)</li><li>• a static channel group (e.g. sa2)</li><li>• a dynamic (LACP) channel group (e.g. po2)</li><li>• a continuous range of ports separated by a hyphen (e.g. port1.0.1-1.0.4)</li><li>• a comma-separated list (e.g. port1.0.1,port1.0.3-1.0.4). Do not mix port types in the same list.</li></ul>

**Examples** To display the status of port1.0.1 to port1.0.3, use the commands:

```
awplus# show interface port1.0.1-port1.0.3 status
```

**Table 12:** Example output from the `show interface <port-list> status` command

```
awplus#show interface port1.0.1-port1.0.3 status
```

Port	Name	Status	Vlan	Duplex	Speed	Type
port1.0.1		notconnect	1	auto	auto	1000BASE-T
port1.0.2		notconnect	1	auto	auto	1000BASE-T
port1.0.3		notconnect	1	auto	auto	1000BASE-T

To display the status of all ports, use the commands:

```
awplus# show interface status
```

**Table 13:** Example output from the `show interface status` command

```
awplus#show interface status
```

Port	Name	Status	Vlan	Duplex	Speed	Type
port1.0.1	Trunk_Net	connected	trunk	a-full	a-1000	1000BaseTX
port1.0.2	Access_Net1	connected	1	full	1000	1000BaseTX
port1.0.3	Access_Net1	disabled	1	auto	auto	1000BaseTX
...						

**Table 14:** Parameters in the output from the **show interface status** command

Parameter	Description
Port	Name/Type of the interface.
Name	Description of the interface.
Status	The administrative and operational status of the interface; one of: <ul style="list-style-type: none"> <li>disabled: the interface is administratively down.</li> <li>connect: the interface is operationally up.</li> <li>notconnect: the interface is operationally down.</li> </ul>
Vlan	VLAN type or VLAN IDs associated with the port: <ul style="list-style-type: none"> <li>When the VLAN mode is trunk, it displays <b>trunk</b> (it does not display the VLAN IDs).</li> <li>When the VLAN mode is access, it displays the VLAN ID.</li> <li>When the VLAN mode is private promiscuous, it displays the primary VLAN ID if it has one, and <b>promiscuous</b> if it does not have a VLAN ID.</li> <li>When the VLAN mode is private host, it displays the primary and secondary VLAN IDs.</li> <li>When the port is an Eth port, it displays <b>none</b>: there is no VLAN associated with it.</li> <li>When the VLAN is dynamically assigned, it displays the current dynamically assigned VLAN ID (not the access VLAN ID), or <b>dynamic</b> if it has multiple VLANs dynamically assigned.</li> </ul>
Duplex	The actual duplex mode of the interface, preceded by <b>a-</b> if it has autonegotiated this duplex mode. If the port is disabled or not connected, it displays the configured duplex setting.
Speed	The actual link speed of the interface, preceded by <b>a-</b> if it has autonegotiated this speed. If the port is disabled or not connected, it displays the configured speed setting.
Type	The type of interface, e.g. 1000BaseTX. For SFP bays, it displays <b>Unknown</b> if it does not recognize the type of SFP installed, or <b>Not present</b> if an SFP is not installed or is faulty.

**Related commands** [show interface](#)  
[show interface memory](#)



# shutdown

**Overview** This command shuts down the selected interface. This administratively disables the link and takes the link down at the physical (electrical) layer.

Use the **no** variant of this command to disable this function and therefore to bring the link back up again.

**Syntax** shutdown  
no shutdown

**Mode** Interface Configuration

**Usage notes** If you shutdown an aggregator, the device shows the admin status of the aggregator and its component ports as “admin down”. While the aggregator is down, the device accepts **shutdown** and **no shutdown** commands on component ports, but these have no effect on port status. Ports will not come up again while the aggregator is down.

**Example** To shut down port1.0.1, use the commands:

```
awplus# configure terminal
awplus(config)# interface port1.0.1
awplus(config-if)# shutdown
```

To bring up port1.0.1, use the commands:

```
awplus# configure terminal
awplus(config)# interface port1.0.1
awplus(config-if)# no shutdown
```

To shut down vlan2, use the commands:

```
awplus# configure terminal
awplus(config)# interface vlan2
awplus(config-if)# shutdown
```

To bring up vlan2, use the commands:

```
awplus# configure terminal
awplus(config)# interface vlan2
awplus(config-if)# no shutdown
```

# 12

# Port Mirroring and Remote Mirroring Commands

## Introduction

**Overview** This chapter provides an alphabetical reference of commands used to configure Port Mirroring and Remote Mirroring (also known as RSPAN).

For more information, see the [Mirroring Feature Overview and Configuration Guide](#).

- Command List**
- ["mirror interface"](#) on page 395
  - ["remote-mirror interface"](#) on page 397
  - ["show mirror"](#) on page 399
  - ["show mirror interface"](#) on page 400
  - ["show remote-mirror"](#) on page 401
  - ["switchport remote-mirror-egress"](#) on page 403
  - ["vlan mode remote-mirror-vlan"](#) on page 404

# mirror interface

**Overview** Use this command to define a mirror port and mirrored (monitored) ports and direction of traffic to be mirrored. The port for which you enter interface mode will be the mirror port.

The destination port is removed from all VLANs, and no longer participates in other switching.

Use the **no** variant of this command to disable port mirroring by the destination port on the specified source port.

Use the **none** variant of this command when using copy-to-mirror ACL and QoS commands.

**Syntax**

```
mirror interface <source-port-list> direction
{both|receive|transmit}

mirror interface none

no mirror interface <source-port-list>

no mirror interface none
```

Parameter	Description
<source-port-list>	The source switch ports to mirror. A port-list can be: <ul style="list-style-type: none"> <li>a port (e.g. port1.0.2)</li> <li>a continuous range of ports separated by a hyphen, e.g. port1.0.1-port1.0.3</li> <li>a comma-separated list of ports and port ranges, e.g. port1.0.1,port1.0.2-port1.0.4</li> </ul> The source port list cannot include dynamic or static channel groups (link aggregators).
direction	Specifies whether to mirror traffic that the source port receives, transmits, or both.
both	Mirroring traffic both received and transmitted by the source port.
receive	Mirroring traffic received by the source port.
transmit	Mirroring traffic transmitted by the source port.
none	Specify this parameter for use with the <b>copy-to-mirror</b> parameter of: <ul style="list-style-type: none"> <li>the ACL (Access Control List) <b>access-list</b> and <b>ipv6 access-list</b> commands or</li> <li>the QoS (Quality of Service) <b>default action</b> command.</li> </ul> The <b>none</b> parameter lets you specify the destination port (the analyzer port) for the traffic without specifying a source mirror port.

**Mode** Interface Configuration

**Usage notes** Use this command to send traffic to another device connected to the mirror port for monitoring.

For more information, see the [Mirroring Feature Overview and Configuration Guide](#).

A mirror port cannot be associated with a VLAN. If a switch port is configured to be a mirror port, it is automatically removed from any VLAN it was associated with.

This command can only be applied to a single mirror (destination) port, not to a range of ports, nor to a static or dynamic channel group. Do not apply multiple interfaces with an interface command before issuing the mirror interface command. One interface may have multiple mirror interfaces.

Access control lists can be used to mirror a subset of traffic from the mirrored port by using the copy-to-mirror parameter in hardware ACL commands.

**Example** To mirror traffic received and transmitted on port1.0.1 to destination port1.0.2, use the commands:

```
awplus# configure terminal
awplus(config)# interface port1.0.2
awplus(config-if)# mirror interface port1.0.1 direction both
```

To enable use with the [access-list \(numbered hardware ACL for IP packets\)](#) ACL and [default-action](#) QoS commands to destination port1.0.1 without specifying a source port, use the commands:

```
awplus# configure terminal
awplus(config)# interface port1.0.1
awplus(config-if)# mirror interface none
```

To mirror all received or transmitted TCP traffic to analyzer port1.0.1, use the sample configuration snippet below:

```
awplus#show running-config

mls qos enable
access-list 3000 copy-to-mirror tcp any any
access-group 3000
!
interface port1.0.1
 mirror interface none
```

**Related commands**

[access-list \(numbered hardware ACL for IP packets\)](#)

[access-list \(numbered hardware ACL for MAC addresses\)](#)

[default-action](#)

# remote-mirror interface

**Overview** Use this command on the source device to specify the source port whose traffic is to be remote-mirrored (monitored), and the remote mirroring VLAN ID these mirrored frames will be tagged with when they egress from the source device. The port for which Interface Configuration mode is entered is the port via which the mirrored traffic egresses the source device towards the remote destination device.

Use the **no** variant of this command to disable remote mirroring of the specified mirrored port by the egress (destination) port on the source device.

**Syntax**

```
remote-mirror interface <port-list> direction  
{both|receive|transmit} vlan <2-4090> [priority <0-7>]  
remote-mirror interface none vlan <2-4090> [priority <0-7>]  
no remote-mirror interface <port-list> [direction  
{receive|transmit}]  
no remote-mirror interface none
```

Parameter	Description
<port-list>	The ports from which to mirror traffic. A port-list can be: <ul style="list-style-type: none"><li>• a port (e.g. port1.0.1)</li><li>• a continuous range of ports separated by a hyphen, e.g. port1.0.1-port1.0.4</li><li>• a comma-separated list of ports and port ranges, e.g. port1.0.1,port1.0.3-port1.0.4</li></ul>
direction	Specifies whether to mirror traffic that the source port receives, transmits, or both.
both	Mirroring traffic both received and transmitted by the source port.
receive	Mirroring traffic received by the source port.
transmit	Mirroring traffic transmitted by the source port.
2-4090	The VLAN ID of the remote mirroring VLAN that this mirrored traffic is to be tagged with at the egress port on the source device.
priority	The 802.1p priority tag to apply to mirrored packets.

**Default** No ports are set to be remote mirrored by default.

**Mode** Interface Configuration

**Usage notes** To prevent unwanted processing of mirrored traffic, we recommend configuring remote monitoring on the receiving device before configuring it on the source device.

This command can only be used to configure a single egress port on the source device, not a range of egress ports. Do not use the **interface** command with multiple interfaces before using this **remote-mirror interface** command. One egress (destination) port on the source device can transmit mirrored frames from up to four remote mirrored (source) ports.

The egress port on the source device can be associated with other VLANs in addition to the remote mirror VLAN, so it can function as an uplink for traffic from multiple VLANs. This command does not change the VLAN associations of the mirrored ports.

Only one port on the device can be configured as either a mirror port for port mirroring (**mirror interface** command) or as an egress port on the source device for remote mirroring (**remote-mirror interface** command).

All mirrored ports on a single device must use the same remote mirror VLAN and priority.

Access control lists can be used to mirror a subset of traffic from the mirrored port by using the copy-to-mirror parameter in hardware ACL commands.

**Example** To configure the source device to send all the traffic that it receives on remote-mirrored port port1.0.2 out egress port port1.0.1 tagged with remote mirroring VLAN ID 2, use the commands:

```
awplus# configure terminal
awplus(config)# interface port1.0.1
awplus(config-if)# remote-mirror interface port1.0.2 direction
receive vlan 2
```

To stop port1.0.1 remote-mirroring traffic received on mirrored port port1.0.2, use the commands:

```
awplus# configure terminal
awplus(config)# interface port1.0.1
awplus(config-if)# no remote-mirror interface port1.0.2
direction receive
```

**Related commands**

[access-list \(numbered hardware ACL for IP packets\)](#)  
[access-list \(numbered hardware ACL for MAC addresses\)](#)  
[default-action](#)  
[mirror interface](#)  
[remote-mirror interface](#)  
[show remote-mirror](#)  
[switchport remote-mirror-egress](#)  
[vlan mode remote-mirror-vlan](#)

# show mirror

**Overview** Use this command to display the status of all mirrored ports.

**Syntax** `show mirror`

**Mode** User Exec and Privileged Exec

**Example** To display the status of all mirrored ports, use the following command:

```
awplus# show mirror
```

**Output** Figure 12-1: Example output from the **show mirror** command

```
Mirror Test Port Name: port1.0.1  
Mirror option: Enabled  
Mirror direction: both  
Monitored Port Name: port1.0.2
```

# show mirror interface

**Overview** Use this command to display port mirroring configuration for a mirrored (monitored) switch port.

**Syntax** `show mirror interface <port>`

Parameter	Description
<code>&lt;port&gt;</code>	The monitored switch port to display information about.

**Mode** User Exec, Privileged Exec and Interface Configuration

**Example** To display port mirroring configuration for port1.0.2, use the following commands:

```
awplus# configure terminal
awplus(config)# interface port1.0.2
awplus(config-if)# show mirror interface port1.0.2
```

**Output** Figure 12-2: Example output from the **show mirror interface** command

```
Mirror Test Port Name: port1.0.1
Mirror option: Enabled
Mirror direction: both
Monitored Port Name: port1.0.2
```



# show remote-mirror

**Overview** Use this command to display information for remote-mirroring.

**Syntax** show remote-mirror

**Mode** User Exec

**Example** To display information about remote mirroring, use the command:

```
awplus# show remote-mirror
```

**Output** Figure 12-3: Example output from **show remote-mirror**

```
awplus#show remote-mirror
Remote mirror information:
Remote mirror destination:
  Port: port1.0.3
  VLAN: 259
  User priority: 0

Monitored ports:
  port1.0.1
  direction: both

Remote mirror egress ports:

Remote mirror VLANs:
  VLAN 259
```

Table 12-1: Parameters in the output from **show remote-mirror**

Parameter	Description
Remote mirror destination	On the source device, this displays information about: <ul style="list-style-type: none"><li>the egress port for the mirrored traffic on the source device</li><li>the remote mirroring VLAN ID this traffic is tagged with on egress</li><li>the user priority this traffic is tagged with on egress</li></ul>
Monitored ports	On the source device, this displays: <ul style="list-style-type: none"><li>the ports being mirrored (monitored)</li><li>the direction—whether both received traffic, transmitted traffic or both are mirrored</li><li>'none (via ACL)' if it is configured with the command <b>remote-mirror interface none</b> to allow ACLs to select the traffic to be mirrored</li></ul>

Table 12-1: Parameters in the output from **show remote-mirror** (cont.)

Parameter	Description
Remote mirror egress ports	On the destination device, this displays : <ul style="list-style-type: none"><li>• the remote mirror egress ports</li><li>• the remote mirror VLANs they are associated with</li></ul>
Remote mirror VLANs	On source, destination and intermediate devices, this displays a list of any VLANs configured in remote mirror VLAN mode. To see a list of the ports associated with these VLANs, use the command <b>show vlan brief</b> .

**Related commands**

- [remote-mirror interface](#)
- [switchport remote-mirror-egress](#)
- [vlan mode remote-mirror-vlan](#)

# switchport remote-mirror-egress

**Overview** Use this command on the device receiving remote mirrored traffic to set the remote mirroring egress port for the specified remote mirroring VLAN. This port removes the remote mirror VLAN tagging before transmitting the mirrored traffic. Ingress traffic on this port is disabled.

Use the **no** variant of this command to reset the port to no longer function as a remote mirror egress port.

**Syntax** `switchport remote-mirror-egress vlan <vlan-id>`  
`no switchport remote-mirror-egress`

Parameter	Description
<code>&lt;vlan-id&gt;</code>	The port will transmit the mirrored traffic it receives from this remote mirror VLAN.

**Default** There is no remote mirror egress port by default.

**Mode** Interface Configuration for a switch port

**Usage notes** To prevent unwanted processing of mirrored traffic, we recommend configuring remote monitoring on the receiving device before configuring it on the source device.

This command would typically be used for the port that transmits the remote-mirrored traffic to a device that will analyze it. The port effectively functions as an access port in the remote mirror VLAN, with the added feature of not allowing ingress traffic on the port.

**Example** To set port1.0.2 on the destination device as the remote mirror egress port for mirrored traffic that is tagged with VLAN ID 2, use the commands:

```
awplus# configure terminal
awplus(config)# interface port1.0.2
awplus(config-if)# switchport remote-mirror-egress vlan 2
```

To unset port1.0.2 as a remote mirror egress port, use the commands:

```
awplus# configure terminal
awplus(config)# interface port1.0.2
awplus(config-if)# no switchport remote-mirror-egress
```

**Related commands** [remote-mirror interface](#)  
[show remote-mirror](#)  
[vlan mode remote-mirror-vlan](#)

# vlan mode remote-mirror-vlan

**Overview** Use this command to create a single VLAN or a range of VLANs in remote mirror mode to be used for remote mirroring.

Use the **no** variant of this command to remove the remote mirror VLAN from the VLAN database and its configurations.

**Syntax** `vlan [<vid>|<vid-range>] mode remote-mirror-vlan`  
`no vlan [<vid>|<vid-range>]`

Parameter	Description
<vid>	The VLAN ID of the remote mirroring VLAN to be created.
<vid-range>	The range of VLAN IDs for the remote mirroring VLANs to be created.

**Default** There is no remote mirror VLAN by default.

**Mode** VLAN Configuration

**Usage notes** This remote mirror VLAN needs to be configured on the remote mirroring source device, the destination (receiving) device, and any devices in between that are to forward the mirrored traffic. We recommend configuring this on the receiving device and intermediate devices before configuring the source device.

The remote mirror VLAN operates in a special mode— all traffic on the remote mirror VLAN is flooded, and no learning or CPU processing is done for packets in the VLAN. BPDU packets (link-local packets used to control features like spanning tree or AMF) are dropped on remote mirror VLANs.

Disabling the remote-mirroring VLAN on the source switch does not prevent the mirrored packets from being sent with the remote-mirror VLAN tag. To stop the mirroring, the command **no remote-mirror interface** must be used.

**Example** To create a VLAN with VLAN ID 3 in remote mirror VLAN mode, use the commands:

```
awplus# configure terminal
awplus(config)# vlan database
awplus(config-vlan)# vlan 3 mode remote-mirror-vlan
```

To remove the remote mirror VLAN with ID 3, use the commands:

```
awplus# configure terminal
awplus(config)# vlan database
awplus(config-vlan)# no vlan 3
```

**Related commands** [remote-mirror interface](#)  
[show remote-mirror](#)

`switchport remote-mirror-egress`

# Part 2: Interfaces and Layer 2

# 13

# Switching Commands

## Introduction

**Overview** This chapter provides an alphabetical reference of commands used to configure switching.

For more information, see the [Switching Feature Overview and Configuration Guide](#).

- Command List**
- “backpressure” on page 409
  - “clear loop-protection counters” on page 411
  - “clear mac address-table dynamic” on page 412
  - “clear mac address-table static” on page 414
  - “clear port counter” on page 415
  - “clear port-security intrusion” on page 416
  - “debug looppot” on page 419
  - “debug platform packet” on page 420
  - “duplex” on page 422
  - “flowcontrol (switch port)” on page 423
  - “linkflap action” on page 425
  - “loop-protection loop-detect” on page 426
  - “loop-protection action” on page 427
  - “loop-protection action-delay-time” on page 428
  - “loop-protection timeout” on page 429
  - “mac address-table acquire” on page 430
  - “mac address-table ageing-time” on page 431
  - “mac address-table logging” on page 432

- [“mac address-table static”](#) on page 433
- [“mac address-table thrash-limit”](#) on page 434
- [“platform l3-vlan-hashing-algorithm”](#) on page 435
- [“platform load-balancing”](#) on page 436
- [“platform mac-vlan-hashing-algorithm”](#) on page 437
- [“platform multicast-ratelimit”](#) on page 438
- [“platform stop-unreg-mc-flooding”](#) on page 439
- [“polarity”](#) on page 441
- [“show debugging loopprot”](#) on page 442
- [“show debugging platform packet”](#) on page 443
- [“show flowcontrol interface”](#) on page 444
- [“show interface err-disabled”](#) on page 445
- [“show interface switchport”](#) on page 446
- [“show loop-protection”](#) on page 447
- [“show mac address-table”](#) on page 449
- [“show mac address-table thrash-limit”](#) on page 451
- [“show platform”](#) on page 452
- [“show platform classifier statistics utilization brief”](#) on page 455
- [“show platform port”](#) on page 457
- [“show port-security interface”](#) on page 459
- [“show port-security intrusion”](#) on page 460
- [“show storm-control”](#) on page 461
- [“speed”](#) on page 462
- [“storm-control level”](#) on page 464
- [“switchport port-security”](#) on page 465
- [“switchport port-security aging”](#) on page 466
- [“switchport port-security maximum”](#) on page 467
- [“switchport port-security violation”](#) on page 468
- [“thrash-limiting”](#) on page 469
- [“undebg loopprot”](#) on page 471
- [“undebg platform packet”](#) on page 472



# backpressure

**Overview** This command provides a method of applying flow control to ports running in half duplex mode. The setting will only apply when the link is in the half-duplex state.

You can disable backpressure on an interface using the **off** parameter or the **no** variant of this command.

**Syntax** `backpressure {on|off}`  
`no backpressure`

Parameters	Description
on	Enables half-duplex flow control.
off	Disables half-duplex flow control.

**Default** Backpressure is turned off by default. You can determine whether an interface has backpressure enabled by viewing the running-config output; **backpressure on** is shown for interfaces if this feature is enabled.

**Mode** Interface Configuration

**Usage notes** The backpressure feature enables half duplex Ethernet ports to control traffic flow during congestion by preventing further packets arriving. Back pressure utilizes a pre-802.3x mechanism in order to apply Ethernet flow control to switch ports that are configured in the half duplex mode.

The flow control applied by the [flowcontrol \(switch port\)](#) command operates only on full-duplex links, whereas back pressure operates only on half-duplex links.

If a port has insufficient capacity to receive further frames, the device will simulate a collision by transmitting a CSMA/CD jamming signal from this port until the buffer empties. The jamming signal causes the sending device to stop transmitting and wait a random period of time, before retransmitting its data, thus providing time for the buffer to clear. Although this command is only valid for switch ports operating in half-duplex mode the remote device (the one sending the data) can be operating in the full duplex mode.

To see the currently-negotiated duplex mode for ports whose links are up, use the command [show interface](#). To see the configured duplex mode (when different from the default), use the command [show running-config](#).

**Examples** To enable back pressure flow control on interfaces `port1.0.1-port1.0.2` enter the following commands:

```
awplus# configure terminal
awplus(config)# interface port1.0.1-port1.0.2
awplus(config-if)# backpressure on
```

To disable back pressure flow control on interface `port1.0.2` enter the following commands:

```
awplus# configure terminal
awplus(config)# interface port1.0.2
awplus(config-if)# backpressure off
```

**Validation  
Commands** `show running-config`  
`show interface`

**Related  
commands** `duplex`

# clear loop-protection counters

**Overview** Use this command to clear the counters for the Loop Protection counters.

**Syntax** `clear loop-protection [interface <port-list>] counters`

Parameters	Description
interface	The interface whose counters are to be cleared.
<port-list>	A port, a port range, or an aggregated link.

**Mode** Privileged Exec

**Examples** To clear the counter information for all interfaces:

```
awplus# clear loop-protection counters
```

To clear the counter information for a single port:

```
awplus# clear loop-protection interface port1.0.1 counters
```

# clear mac address-table dynamic

**Overview** Use this command to clear the filtering database of all entries learned for a selected MAC address, an MSTP instance, a switch port interface or a VLAN interface.

**Syntax** `clear mac address-table dynamic`  
`[address <mac-address>|interface <port> [instance <inst>]]|`  
`vlan <vid>]`

Parameter	Description
<code>address</code> <code>&lt;mac-address&gt;</code>	Specify a MAC (Media Access Control) address to be cleared from the filtering database, in the format HHHH.HHHH.HHHH.
<code>interface &lt;port&gt;</code>	Specify a switch port to be cleared from the filtering database. The port can be: <ul style="list-style-type: none"><li>• a switchport (e.g. port1.0.4)</li><li>• a static channel group (e.g. sa2)</li><li>• a dynamic (LACP) channel group (e.g. po2)</li></ul>
<code>instance &lt;inst&gt;</code>	Specify an MSTP (Multiple Spanning Tree) instance in the range 1 to 63 to be cleared from the filtering database.
<code>vlan &lt;vid&gt;</code>	Specify a VID (VLAN ID) in the range 1 to 4094 to be cleared from the filtering database.

**Mode** Privileged Exec

**Usage notes** Use this command with options to clear the filtering database of all entries learned for a given MAC address, interface or VLAN. Use this command without options to clear any learned entries.

Use the optional **instance** parameter to clear the filtering database entries associated with a specified MSTP instance. Note that you must first specify a switch port interface before you can specify an MSTP instance.

Compare this usage and operation with the [clear mac address-table static](#) command. Note that an MSTP instance cannot be specified with the command **clear mac address-table static**.

**Examples** This example shows how to clear all dynamically learned filtering database entries.

```
awplus# clear mac address-table dynamic
```

This example shows how to clear all dynamically learned filtering database entries when learned through device operation for the MAC address 0000.5E00.5302.

```
awplus# clear mac address-table dynamic address 0000.5E00.5302
```

This example shows how to clear all dynamically learned filtering database entries when learned through device operation for a given MSTP instance 1 on switch port interface port1.0.3.

```
awplus# clear mac address-table dynamic interface port1.0.3  
instance 1
```

**Related commands**

- [clear mac address-table static](#)
- [show mac address-table](#)

# clear mac address-table static

**Overview** Use this command to clear the filtering database of all statically configured entries for a selected MAC address, interface, or VLAN.

**Syntax** `clear mac address-table static [address <mac-address>|interface <port>|vlan <vid>]`

Parameter	Description
address <mac-address>	Specify a MAC (Media Access Control) address to be cleared from the filtering database, in the format HHHH.HHHH.HHHH.
interface <port>	Specify the port from which statically configured entries are to be cleared. The port can be <ul style="list-style-type: none"><li>• a switchport (e.g. port1.0.4)</li><li>• a static channel group (e.g. sa2)</li><li>• a dynamic (LACP) channel group (e.g. po2)</li></ul>
vlan <vid>	Specify a VID (VLAN ID) in the range 1 to 4094 to be cleared from the filtering database.

**Mode** Privileged Exec

**Usage notes** Use this command with options to clear the filtering database of all entries made from the CLI for a given MAC address, interface or VLAN. Use this command without options to clear any entries made from the CLI.

Compare this usage with [clear mac address-table dynamic](#) command.

**Examples** This example shows how to clear all filtering database entries configured through the CLI.

```
awplus# clear mac address-table static
```

This example shows how to clear all filtering database entries for a specific interface configured through the CLI.

```
awplus# clear mac address-table static interface port1.0.3
```

This example shows how to clear filtering database entries configured through the CLI for the MAC address 0000.5E00.5302.

```
awplus# clear mac address-table static address 0000.5E00.5302
```

**Related commands**

- [clear mac address-table dynamic](#)
- [mac address-table static](#)
- [show mac address-table](#)

# clear port counter

**Overview** Use this command to clear the packet counters of the port.

**Syntax** `clear port counter [<port>]`

Parameter	Description
<code>&lt;port&gt;</code>	The port number or range

**Mode** Privileged Exec

**Example** To clear the packet counter for port1.0.1, use the command:

```
awplus# clear port counter port1.0.1
```

**Related commands** [show platform port](#)

# clear port-security intrusion

**Overview** Use this command to clear the history of the port-security intrusion list on all ports, or an individual port. If a port is not specified, the intrusion lists of all ports are cleared. This command does not clear any MAC addresses the device has already learned on the ports. If you want to clear MAC addresses on a switch port from the filtering database, you can use the [clear mac address-table dynamic](#) command or the [clear mac address-table static](#) command.

**Syntax** `clear port-security intrusion [interface <port>]`

Parameter	Description
<port>	Specify the switch port from which the history of violated address entries will be cleared. The port can be a single switch port, (e.g. port1.0.4), a static channel group (e.g. sa2), or a dynamic (LACP) channel group (e.g. po2).

**Mode** Privileged Exec

**Examples** To see the port-security status on port1.0.2, use the following command:

```
awplus# show port-security interface port1.0.2
```

Table 13-1: Example output from **show port-security interface**

```
awplus#show port-security interface port1.0.2
Port Security configuration
-----
Security Enabled : YES
Port Status : ENABLED
Violation Mode : TRAP
Aging : OFF
Maximum MAC Addresses : 1
Total MAC Addresses : 1
Lock Status : LOCKED
Security Violation Count : 1
Last Violation Source Address : 801f.0200.19da
```

To see the intrusion list on port1.0.2, use the following command:

```
awplus# show port-security intrusion interface port1.0.2
```



Table 13-2: Example output from **show port-security intrusion**

```
awplus#show port-security intrusion interface port1.0.2
Port Security Intrusion List
-----
Interface: port1.0.2      - 1 intrusion(s) detected
801f.0200.19da
```

To clear the history of port-security intrusion list on port1.0.2, use the following command:

```
awplus# clear port-security intrusion interface port1.0.2
```

To see the port-security status on port1.0.2, use the following command:

```
awplus# show port-security interface port1.0.2
```

Table 13-3: Example output from **show port-security interface**

```
awplus#show port-security interface port1.0.2
Port Security configuration
-----
Security Enabled : YES
Port Status : ENABLED
Violation Mode : TRAP
Aging : OFF
Maximum MAC Addresses : 1
Total MAC Addresses : 1
Lock Status : LOCKED
Security Violation Count : 0
Last Violation Source Address : None
```

**NOTE:** Note that the port status is still locked while the history of port violation is cleared from the database.

To see the intrusion list on port1.0.2, use the following command:

```
awplus# show port-security intrusion interface port1.0.2
```

Table 13-4: Example output from **show port-security intrusion**

```
awplus#show port-security intrusion interface port1.0.2
Port Security Intrusion List
-----
Interface: port1.0.2      - no intrusions detected
```

**Related commands**

- show port-security interface
- show port-security intrusion
- switchport port-security
- switchport port-security aging
- switchport port-security maximum
- switchport port-security violation

# debug loopprot

**Overview** This command enables Loop Protection debugging.  
The **no** variant of this command disables Loop Protection debugging.

**Syntax** `debug loopprot {info|msg|pkt|state|nsm|all}`  
`no debug loopprot {info|msg|pkt|state|nsm|all}`

Parameter	Description
info	General Loop Protection information.
msg	Received and transmitted Loop Detection Frames (LDFs).
pkt	Echo raw ASCII display of received and transmitted LDF packets to the console.
state	Loop Protection states transitions.
nsm	Network Service Module information.
all	All debugging information.

**Mode** Privileged Exec and Global Configuration

**Example** To enable debug for all state transitions, use the command:

```
awplus# debug loopprot state
```

**Related commands** [show debugging loopprot](#)  
[undebug loopprot](#)

# debug platform packet

**Overview** This command enables platform to CPU level packet debug functionality on the device.

Use the **no** variant of this command to disable platform to CPU level packet debug. If the result means both send and receive packet debug are disabled, then any active timeout will be canceled.

**Syntax** debug platform packet [recv] [send] [sflow] [timeout <timeout>]  
[vlan <vid>|all]  
no debug platform packet [recv] [send]

Parameter	Description
recv	Debug packets received.
send	Debug packets sent.
sflow	Debug sFlow packets.
timeout <timeout>	Stop debug after a specified time. Specify the time in seconds.
vlan <vid>	Specify a VID (VLAN ID) in the range 1 to 4094 to limit debug to that VLAN.
all	Debug all VLANs (default setting).

**Default** A 5 minute timeout is configured by default if no other timeout duration is specified.

**Mode** Privileged Exec and Global Configuration

**Usage notes** This command can be used to trace packets sent and received by the CPU. If a timeout is not specified, then a default 5 minute timeout will be applied.

If a timeout of 0 is specified, packet debug will be generated until the **no** variant of this command is used or another timeout value is specified. The timeout value applies to both send and receive debug and is updated whenever the **debug platform packet** command is used.

**Examples** To enable both receive and send packet debug for the default timeout of 5 minutes, enter:

```
awplus# debug platform packet
```

To enable receive packet debug for 10 seconds, enter:

```
awplus# debug platform packet recv timeout 10
```

To enable packet debug for sFlow packets only for the default timeout of 5 minutes, enter:

```
awplus# debug platform packet sflow
```

To enable send packet debug with no timeout, enter:

```
awplus# debug platform packet send timeout 0
```

To enable VLAN packet debug for VLAN 1 with a timeout duration of 3 minutes, enter:

```
awplus# debug platform packet vlan 1 timeout 150
```

To disable receive packet debug, enter:

```
awplus# no debug platform packet recv
```

**Related commands**

- [show debugging platform packet](#)
- [undebug platform packet](#)

# duplex

**Overview** This command changes the duplex mode for the specified port.

To see the currently-negotiated duplex mode for ports whose links are up, use the command [show interface](#). To see the configured duplex mode (when different from the default), use the command [show running-config](#).

**Syntax** duplex {auto|full|half}

Parameter	Description
auto	Auto-negotiate duplex mode.
full	Operate in full duplex mode only.
half	Operate in half duplex mode only.

**Default** By default, ports auto-negotiate duplex mode (except for 100Base-FX ports which do not support auto-negotiation, so default to full duplex mode).

**Mode** Interface Configuration

**Usage notes** Switch ports in a static or dynamic (LACP) channel group must have the same port speed and be in full duplex mode. Once switch ports have been aggregated into a channel group, you can set the duplex mode of all the switch ports in the channel group by applying this command to the channel group.

**Examples** To specify full duplex for port1.0.4, enter the following commands:

```
awplus# configure terminal
awplus(config)# interface port1.0.4
awplus(config-if)# duplex full
```

To specify half duplex for port1.0.4, enter the following commands:

```
awplus# configure terminal
awplus(config)# interface port1.0.4
awplus(config-if)# duplex half
```

To auto-negotiate duplex mode for port1.0.4, enter the following commands:

```
awplus# configure terminal
awplus(config)# interface port1.0.4
awplus(config-if)# duplex auto
```

**Related commands** [polarity](#)  
[speed](#)  
[show interface](#)

# flowcontrol (switch port)

**Overview** Use this command to enable flow control, and configure the flow control mode for the switch port.

Use the **no** variant of this command to disable flow control for the specified switch port.

**Syntax** `flowcontrol {send|receive} {off|on}`  
`no flowcontrol`

Parameter	Description
receive	When the port receives pause frames, it temporarily stops (pauses) sending traffic.
on	Enable the specified flow control.
off	Disable the specified flow control.
send	When the port is congested (receiving too much traffic), it sends pause frames to request the other end to temporarily stop (pause) sending traffic.

**Default** By default, flow control is disabled.

**Mode** Interface Configuration

**Usage notes** The flow control mechanism specified by 802.3x is only for full duplex links. It operates by sending PAUSE frames to the link partner to temporarily suspend transmission on the link.

Flow control enables connected Ethernet ports to control traffic rates during congestion by allowing congested nodes to pause link operation at the other end. If one port experiences congestion, and cannot receive any more traffic, it notifies the other port to stop sending until the condition clears. When the local device detects congestion at its end, it notifies the remote device by sending a pause frame. On receiving a pause frame, the remote device stops sending data packets, which prevents loss of data packets during the congestion period.

Flow control is not recommended when running QoS or ACLs, because the complex queuing, scheduling, and filtering configured by QoS or ACLs may be slowed by applying flow control.

For half-duplex links, an older form of flow control known as backpressure is supported. See the related [backpressure](#) command.

For flow control on async serial (console) ports, see the [flowcontrol hardware \(asyn/console\)](#) command.

**Examples** To enable flow control on port1.0.2 (receive only), use the commands:

```
awplus# configure terminal
awplus(config)# interface port1.0.2
awplus(config-if)# flowcontrol receive on
```

To enable flow control on port1.0.2 (send only), use the commands:

```
awplus# configure terminal
awplus(config)# interface port1.0.2
awplus(config-if)# flowcontrol send on
```

To disable flow control on port1.0.2 (receive only), use the commands:

```
awplus# configure terminal
awplus(config)# interface port1.0.2
awplus(config-if)# flowcontrol receive off
```

To disable flow control on port1.0.2 (send only), use the commands:

```
awplus# configure terminal
awplus(config)# interface port1.0.2
awplus(config-if)# flowcontrol send off
```

**Related commands** [backpressure](#)  
[show running-config](#)



# linkflap action

**Overview** Use this command to detect flapping on all ports. If more than 15 flaps occur in less than 15 seconds the flapping port will shut down.

Use the **no** variant of this command to disable flapping detection at this rate.

**Syntax** linkflap action [shutdown]  
no linkflap action

Parameter	Description
linkflap	Global setting for link flapping.
action	Specify the action for port.
shutdown	Shutdown the port.

**Default** Linkflap action is disabled by default.

**Mode** Global Configuration

**Example** To enable the linkflap action command on the device, use the following commands:

```
awplus# configure terminal  
awplus(config)# linkflap action shutdown
```

# loop-protection loop-detect

**Overview** Use this command to enable the loop-protection loop-detect feature and configure its parameters.

Use the **no** variant of this command to disable the loop-protection loop-detect feature.

**Syntax** `loop-protection loop-detect [ldf-interval <period>]  
[ldf-rx-window <frames>] [fast-block]`  
`no loop-protection loop-detect`

Parameter	Description
<code>ldf-interval</code>	The time (in seconds) between successive loop-detect frames being sent.
<code>&lt;period&gt;</code>	Specify a period between 1 and 600 seconds. The default is 10 seconds.
<code>ldf-rx-window</code>	The number of transmitted loop detect frames whose details are held for comparing with frames arriving at the same port.
<code>&lt;frames&gt;</code>	Specify a value for the window size between 1 and 5 frames. The default is 3 frames.
<code>[fast-block]</code>	The fast-block blocks transmitting port to keep partial connectivity.

**Default** The loop-protection loop-detect feature is disabled by default. The default interval is 10 seconds, and the default window size is 3 frames.

**Mode** Global Configuration

**Usage notes** See the “Loop Protection” section in the [Switching Feature Overview and Configuration Guide](#) for relevant conceptual, configuration, and overview information prior to applying this command.

**Example** To enable the loop-detect mechanism on the switch, and generate loop-detect frames once every 5 seconds, use the following commands:

```
awplus# configure terminal  
awplus(config)# loop-protection loop-detect ldf-interval 5
```

**Related commands** [loop-protection action](#)  
[loop-protection timeout](#)  
[show loop-protection](#)

# loop-protection action

**Overview** Use this command to specify the protective action to apply when a network loop is detected on an interface.

Use the **no** variant of this command to reset the loop protection actions to the default action, `vlan-disable`, on an interface.

**Syntax** `loop-protection action`  
{ `link-down` | `log-only` | `port-disable` | `vlan-disable` | `none` }  
`no loop-protection action`

Parameter	Description
<code>link-down</code>	Block all traffic on a port (or aggregated link) that detected the loop, and take <b>down</b> the link.
<code>log-only</code>	Details of loop conditions are logged. No action is applied to the port (or aggregated link).
<code>port-disable</code>	Block all traffic on interface for which the loop occurred, but keep the link in the <b>up</b> state.
<code>vlan-disable</code>	Block all traffic for the VLAN on which the loop traffic was detected. Note that setting this parameter will also enable ingress filtering. This is the default action.
<code>none</code>	Applies no protective action.

**Default** `loop-protection action vlan-disable`

**Mode** Interface Configuration

**Usage notes** See the “Loop Protection” section in the [Switching Feature Overview and Configuration Guide](#) for relevant conceptual, configuration, and overview information prior to applying this command.

**Example** To disable the interface `port1.0.2` and bring the link down when a network loop is detected, use the commands:

```
awplus# configure terminal
awplus(config)# interface port1.0.2
awplus(config-if)# loop-protection action link-down
```

**Related commands** [loop-protection loop-detect](#)  
[loop-protection timeout](#)  
[show loop-protection](#)

# loop-protection action-delay-time

**Overview** Use this command to sets the loop protection action delay time for an interface to specified values in seconds. The action delay time specifies the waiting period for the action.

Use the **no** variant of this command to reset the loop protection action delay time for an interface to default.

**Syntax** `loop-protection action-delay-time <0-86400>`  
`no loop-protection action`

Parameter	Description
<code>&lt;0-86400&gt;</code>	Time in seconds; 0 means action delay timer is disabled.

**Default** Action delay timer is disabled by default.

**Mode** Interface Configuration

**Example** To configure a loop protection action delay time of 10 seconds on port1.0.4, use the commands:

```
awplus# configure terminal
awplus(config)# interface port1.0.4
awplus(config-if)# loop-protection action-delay-time 10
```

**Related commands** [loop-protection loop-detect](#)  
[loop-protection timeout](#)  
[show loop-protection](#)

# loop-protection timeout

**Overview** Use this command to specify the Loop Protection recovery action duration on an interface.

Use the **no** variant of this command to set the loop protection timeout to the default.

**Syntax** `loop-protection timeout <duration>`  
`no loop-protection timeout`

Parameter	Description
<code>&lt;duration&gt;</code>	The time (in seconds) for which the configured action will apply before being disabled. This duration can be set between 0 and 86400 seconds (24 hours). The set of 0 means infinity so timeout does not expire.

**Default** The default is 7 seconds.

**Mode** Interface Configuration

**Usage notes** See the “Loop Protection” section in the [Switching\\_Feature\\_Overview\\_and\\_Configuration\\_Guide](#) for relevant conceptual, configuration, and overview information prior to applying this command.

**Example** To configure a loop protection action timeout of 10 seconds for port1.0.4, use the command:

```
awplus# configure terminal
awplus(config)# interface port1.0.4
awplus(config-if)# loop-protection timeout 10
```

**Related commands** [loop-protection loop-detect](#)  
[loop-protection action](#)  
[show loop-protection](#)

# mac address-table acquire

**Overview** Use this command to enable MAC address learning on the device.

Use the **no** variant of this command to disable learning.

**Syntax** `mac address-table acquire`  
`no mac address-table acquire`

**Default** Learning is enabled by default for all instances.

**Mode** Global Configuration

**Example** `awplus# configure terminal`  
`awplus(config)# mac address-table acquire`

# mac address-table ageing-time

**Overview** Use this command to specify an ageing-out time for a learned MAC address. The learned MAC address will persist for at least the specified time.

The **no** variant of this command will reset the ageing-out time back to the default of 300 seconds (5 minutes).

**Syntax** `mac address-table ageing-time <ageing-timer> none`  
`no mac address-table ageing-time`

Parameter	Description
<code>&lt;ageing-timer&gt;</code>	<code>&lt;10-1000000&gt;</code> The number of seconds of persistence.
<code>none</code>	Disable learned MAC address timeout.

**Default** The default ageing time is 300 seconds.

**Mode** Global Configuration

**Examples** The following commands specify various ageing timeouts on the device:

```
awplus# configure terminal
awplus(config)# mac address-table ageing-time 1000
awplus# configure terminal
awplus(config)# mac address-table ageing-time none
awplus# configure terminal
awplus(config)# no mac address-table ageing-time
```

# mac address-table logging

**Overview** Use this command to create log entries when the content of the FDB (forwarding database) changes. Log messages are produced when a MAC address is added to or removed from the FDB.

**CAUTION:** *MAC address table logging may impact the performance of the switch. Only enable it when necessary as a debug tool.*

Use the **no** variant of this command to stop creating log entries when the content of the FDB changes.

**Syntax** mac address-table logging  
no mac address-table logging

**Default** MAC address table logging is disabled by default.

**Mode** User Exec/Privileged Exec

**Usage** When MAC address table logging is enabled, the switch produces the following messages:

Change	Message format	Example
MAC added	MAC add <mac> <port> <vlan>	MAC add eccd.6db5.68a7 port1.0.1 vlan2
MAC removed	MAC remove <mac> <port> <vlan>	MAC remove eccd.6db5.68a7 port1.0.1 vlan2

Note that rapid changes may not be logged. For example, if an entry is added and then removed within a few seconds, those actions may not be logged.

To see whether MAC address table logging is enabled, use the command [show running-config](#).

**Example** To create log messages when the content of the FDB changes, use the command:

```
awplus# mac address-table logging
```

**Related commands** [show running-config](#)



# mac address-table static

**Overview** Use this command to statically configure the MAC address-table to forward or discard frames with a matching destination MAC address.

**Syntax** `mac address-table static <mac-addr> {forward|discard} interface <port> [vlan <vid>]`  
`no mac address-table static <mac-addr> {forward|discard} interface <port> [vlan <vid>]`

Parameter	Description
<code>&lt;mac-addr&gt;</code>	The destination MAC address in HHHH . HHHH . HHHH format.
<code>interface &lt;port&gt;</code>	Specify a switch port to be cleared from the filtering database. The port can be: <ul style="list-style-type: none"><li>• a switchport (e.g. port1.0.4)</li><li>• a static channel group (e.g. sa2)</li><li>• a dynamic (LACP) channel group (e.g. po2)</li></ul>
<code>vlan &lt;vid&gt;</code>	The ID of a VLAN to apply the command to, in the range 1 to 4094. If you do not specify a VLAN, the command applies to VLAN1.

**Mode** Global Configuration

**Usage notes** The **mac address-table static** command is only applicable to Layer 2 switched traffic within a single VLAN. Do not apply the **mac address-table static** command to Layer 3 switched traffic passing from one VLAN to another VLAN. Frames will not be discarded across VLANs because packets are routed across VLANs. This command only works on Layer 2 traffic.

**Example** `awplus# configure terminal`  
`awplus(config)# mac address-table static 2222.2222.2222 forward`  
`interface port1.0.4 vlan 3`

**Related commands** [clear mac address-table static](#)  
[show mac address-table](#)

# mac address-table thrash-limit

**Overview** Use this command to set the thrash limit on the device.

Thrashing occurs when a MAC address table rapidly “flips” its mapping of a single MAC address between two switchports on the same VLAN. This is usually because of a network loop.

Use the **no** variant of this command to return the thrash limit to its default setting.

**Syntax** `mac address-table thrash-limit <rate>`  
`no mac address-table thrash-limit`

Parameter	Description
<code>&lt;rate&gt;</code>	The maximum thrash rate at which limiting is applied. This rate can be set to between 5 and 255 MAC thrashing flips per second. Once the thrash limit rate is reached, the port is considered to be thrashing.

**Default** 10 MAC thrashing flips per second

**Mode** Global Configuration

**Usage notes** Use this command to limit thrashing on the selected port range.

**Example** To apply a thrash limit of 20 MAC address flips per second:

```
awplus# configure terminal
awplus(config)# mac address-table thrash-limit 20
```

**Related commands** [show interface](#)  
[show mac address-table thrash-limit](#)  
[thrash-limiting](#)

# platform l3-vlan-hashing-algorithm

**Overview** This command enables you to change the L3 VLAN hash-key-generating algorithm.

The **no** variant of this command returns the hash-key algorithm to the default of `crc32l`.

**Syntax** `platform l3-vlan-hashing-algorithm`  
`{crc16l|crc16u|crc32l|crc32u}`  
`no platform l3-vlan-hashing-algorithm`

Parameter	Description
<code>crc16l</code>	The algorithm that will apply to the lower bits of CRC-16
<code>crc16u</code>	The algorithm that will apply to the upper bits of CRC-16
<code>crc32l</code>	The algorithm that will apply to the lower bits of CRC-32
<code>crc32u</code>	The algorithm that will apply to the upper bits of CRC-32

**Default** The hash-key algorithm is `crc32l` by default.

**Mode** Global configuration

**Usage notes** Occasionally, when using the Multiple Dynamic VLAN feature, a supplicant cannot be authenticated because a collision occurs within the VLAN L3 table. This can happen when more than four different IP addresses produce the same hash-key.

When this situation occurs, collisions can sometimes be avoided by changing the hashing algorithm from its default of `crc32l`. Several different algorithms may need to be tried to rectify the problem.

You must restart the switch for this command to take effect.

Note that this command is intended for technical support staff, or advanced end users.

**Example** To change the hash-key generating algorithm applying to the lower bits of CRC-16, use the command:

```
awplus# configure terminal
awplus(config)# platform l3-vlan-hashing-algorithm crc16l
```

**Related commands** [platform mac-vlan-hashing-algorithm](#)  
[show platform](#)

# platform load-balancing

**Overview** This command selects which address fields are used as inputs into the load balancing algorithm for aggregated links. The output from this algorithm is used to select which individual path a given packet will traverse within an aggregated link.

The **no** variant of this command applies its default setting.

**Syntax** `platform load-balancing {src-dst-mac|src-dst-ip}`  
`no platform load-balancing`

Parameter	Description
<code>src-dst-mac</code>	Include the source and destination MAC addresses (Layer 2)
<code>src-dst-ip</code>	Include the source and destination IP addresses (Layer 3) and UDP/TCP source and destination ports. If you choose this option, the algorithm will use MAC addresses to calculate load balancing for Layer 2 and non-IP packets.

**Default** The default is **src-dst-ip**.

**Mode** Global configuration

**Examples** To set the load balancing algorithm to include only Layer 2 MAC addresses, use the commands:

```
awplus# configure terminal
awplus(config)# platform load-balancing src-dst-mac
```

To set the load balancing algorithm to include only Layer 3 IP addresses and Layer 4 ports, use the commands:

```
awplus# configure terminal
awplus(config)# platform load-balancing src-dst-ip
```

**Related commands** [show platform](#)

# platform mac-vlan-hashing-algorithm

**Overview** This command enables you to change the MAC VLAN hash-key-generating algorithm.

The **no** variant of this command returns the hash-key algorithm to the default of `crc32l`

**Syntax** `platform mac-vlan-hashing-algorithm`  
`{crc16l | crc16u | crc32l | crc32u}`  
`no platform mac-vlan-hashing-algorithm`

Parameter	Description
<code>crc16l</code>	The algorithm that will apply to the lower bits of CRC-16
<code>crc16u</code>	The algorithm that will apply to the upper bits of CRC-16
<code>crc32l</code>	The algorithm that will apply to the lower bits of CRC-32
<code>crc32u</code>	The algorithm that will apply to the upper bits of CRC-32

**Default** The hash-key algorithm is `crc32l` by default.

**Mode** Global configuration

**Usage notes** Occasionally, when using the Multiple Dynamic VLAN feature, a supplicant cannot be authenticated because a collision occurs within the VLAN MAC table. This can happen when more than four different MAC addresses produce the same hash-key.

When this situation occurs, collisions can sometimes be avoided by changing the hashing algorithm from its default of `crc32l`. Several different algorithms may need to be tried to rectify the problem.

You must restart the switch for this command to take effect.

Note that this command is intended for technical support staff, or advanced end users.

**Example** To change the hash-key generating algorithm applying to the lower bits of CRC-16, use the command:

```
awplus# configure terminal
awplus(config)# platform mac-vlan-hashing-algorithm crc16l
```

**Related commands** [platform l3-vlan-hashing-algorithm](#)  
[show platform](#)

# platform multicast-ratelimit

**Overview** Use this command to set the maximum number of multicast packets to be forwarded to the CPU (in packets per second). Setting the value to zero disables rate limiting.

This command should be used with care. Increasing or removing the limit could make the device less responsive under heavy multicast load.

Use the **no** variant of this command to return the limit to its default.

**Syntax** `platform multicast-ratelimit <0-100>`  
`no platform multicast-ratelimit`

**Default** 10 packets per second (pps)

**Mode** Global Configuration

**Usage notes** If you find that the CPU load on your device from multicast traffic is higher than desired, reducing this rate may reduce the CPU load.

If you need the device to process a large amount of multicast traffic, increasing this rate may improve performance.

**Example** To set the rate to 30pps, use the commands:

```
awplus# configure terminal
awplus(config)# platform multicast-ratelimit 30
```

**Command changes** Version 5.4.8-1.1: default changed to 100pps on SBx908 GEN2, SBx8100, and x930 Series switches.

# platform stop-unreg-mc-flooding

**Overview** If a multicast stream is arriving at a network device, and that network device has received no IGMP reports that request the receipt of the stream, then that stream is referred to as "unregistered". IGMP snooping actively prevents the flooding of unregistered streams to all ports in the VLAN on which the stream is received. However, there are brief moments at which this prevention is not in operation, and an unregistered stream may be briefly flooded. This command stops this flooding during even those brief periods when IGMP snooping is not explicitly preventing the flooding.

Use the **no** variant of this command to revert to default behavior and disable this feature.

**NOTE:** *This command should not be used within any IPv6 networks. IPv6 neighbor discovery operation is inhibited by this feature.*

This command does not affect the flooding of Local Network Control Block IPv4 multicast packets in the address range 224.0.0.1 to 224.0.0.255 (224.0.0/24). Such packets will continue to be uninterruptedly flooded, as they need to be.

**Syntax** `platform stop-unreg-mc-flooding`  
`no platform stop-unreg-mc-flooding`

**Default** This feature is disabled by default.

**Mode** Global Configuration

**Usage notes** This command stops the periodic flooding of unknown or unregistered multicast packets when the Group Membership interval timer expires and there are no subscribers to a multicast group. If there is multicast traffic in a VLAN without subscribers, multicast traffic temporarily floods out of the VLAN when the Group Membership interval timer expires, which happens when the switch does not get replies from Group Membership queries.

This command also stops the initial flood of multicast packets that happens when a new multicast source starts to send traffic. This flooding lasts until snooping realises that this the multicast group is arriving at the switch, and puts an entry into hardware to prevent it from being flooded.

This command is useful in networks where low-performance devices are attached. The operation of such devices can be impaired by them receiving unnecessary streams of traffic. For example, in sites where IP cameras are in use, the flooding of video streams to a whole VLAN can send enough traffic to the cameras to cause interruption of their video streaming.

Do not use this command in IPv6 networks. The following console message is displayed after entering this command to warn you of this:

```
% WARNING: IPv6 will not work with this setting enabled
% Please consult the documentation for more information
```

**Examples** To enable this feature and stop multicast packet flooding, use the following commands:

```
awplus# configure terminal
awplus(config)# platform stop-unreg-mc-flooding
```

To disable this feature and allow multicast packet flooding, use the following commands:

```
awplus# configure terminal
awplus(config)# no platform stop-unreg-mc-flooding
```

**Related commands** [show platform](#)  
[show running-config](#)



# polarity

**Overview** This command sets the MDI/MDIX polarity on a copper-based switch port.

**Syntax** `polarity {auto|mdi|mdix}`

Parameter	Description
mdi	Sets the polarity to MDI (medium dependent interface).
mdix	Sets the polarity to MDI-X (medium dependent interface crossover).
auto	The switch port sets the polarity automatically. This is the default option.

**Default** By default, switch ports set the polarity automatically (**auto**).

**Mode** Interface Configuration

**Usage notes** We recommend the default **auto** setting for MDI/MDIX polarity. Polarity applies to copper 10BASE-T, 100BASE-T, and 1000BASE-T switch ports; it does not apply to fiber ports. See the “MDI/MDIX Connection Modes” section in the [Switching Feature Overview and Configuration Guide](#) for more information.

**Example** To set the polarity for port1.0.4 to fixed MDI mode, use the following commands:

```
awplus# configure terminal
awplus(config)# interface port1.0.4
awplus(config-if)# polarity mdi
```

# show debugging loopprot

**Overview** This command shows Loop Protection debugging information.

**Syntax** `show debugging loopprot`

**Mode** User Exec and Privileged Exec

**Example** To display the enabled Loop Protection debugging modes, use the command:

```
awplus# show debugging loopprot
```

**Related commands** [debug loopprot](#)

# show debugging platform packet

**Overview** This command shows platform to CPU level packet debugging information.

**Syntax** show debugging platform packet

**Mode** User Exec and Privileged Exec

**Example** To display the platform packet debugging information, use the command:

```
awplus# show debugging platform packet
```

**Related commands** [debug platform packet](#)  
[undebug platform packet](#)

# show flowcontrol interface

**Overview** Use this command to display flow control information.

**Syntax** `show flowcontrol interface <port>`

Parameter	Description
<port>	Specifies the name of the port to be displayed.

**Mode** User Exec and Privileged Exec

**Example** To display the flow control for port1.0.3, use the command:

```
awplus# show flowcontrol interface port1.0.3
```

**Output** Figure 13-1: Example output from the **show flowcontrol interface** command for a specific interface

Port	Send admin	FlowControl oper	Receive admin	FlowControl oper	RxPause	TxPause
port1.0.3	on	on	on	on	0	0

# show interface err-disabled

**Overview** Use this command to show the ports which have been dynamically shut down by protocols running on the device and the protocols responsible for the shutdown.

**Syntax** `show interface [<interface-range> err-disabled]`

Parameter	Description
<code>&lt;interface-range&gt;</code>	Interface range
<code>err-disabled</code>	Brief summary of interfaces shut down by protocols

**Mode** User Exec and Privileged Exec

**Example** To show which protocols have shut down ports, use the commands:

```
awplus# show interface err-disabled
```

**Output** Figure 13-2: Example output from **show interface err-disabled**

```
awplus#show interface err-disabled
Interface          Reason
port1.0.1          loop protection
port1.0.2          loop protection
```

# show interface switchport

**Overview** Use this command to show VLAN information about each switch port.

**Syntax** show interface switchport

**Mode** User Exec and Privileged Exec

**Example** To display VLAN information about each switch port, enter the command:

```
awplus# show interface switchport
```

**Output** Figure 13-3: Example output from the **show interface switchport** command

```
Interface name      : port1.0.1
Switchport mode    : access
Ingress filter     : enable
Acceptable frame types : all
Default Vlan       : 1
Configured Vlans   : 2
Dynamic Vlans      :

Interface name      : port1.0.2
Switchport mode    : trunk
Ingress filter     : enable
Acceptable frame types : all
Default Vlan       : 1
Configured Vlans   : 1 4 5 6 7 8
Dynamic Vlans      :
...
```

**Related commands** [show interface memory](#)

# show loop-protection

**Overview** Use this command to display the current loop protection setup for the device.

**Syntax** `show loop-protection [interface <port-list>] [counters]`

Parameter	Description
interface	The interface selected for display.
<port-list>	A port, a port range, or an aggregated link.
counters	Displays counter information for loop protection.

**Mode** User Exec and Privileged Exec

**Usage notes** This command is used to display the current configuration and operation of the Loop Protection feature.

**Example** To display the current configuration status, use the command:

```
awplus# show loop-protection
```

**Output** Figure 13-4: Example output from the **show loop-protection** command

```
awplus#show loop-protection

LDF Interval:      10
Fast Block:      Disabled

  Int           Enabled  Action      Status      Timeout      Timeout
  -----
  port1.0.1     Yes      vlan-dis   Normal      7            -
  port1.0.2     Yes      vlan-dis   Normal      7            -
  port1.0.3     Yes      vlan-dis   Normal      7            -
  ...
```

**Example** To display the counter information, use the command:

```
awplus# show loop-protection counters
```

**Output** Figure 13-5: Example output from the **show loop-protection counters** command

```
awplus#show loop-protection counters

Switch Loop Detection Counter

Interface      Tx      Rx      Rx Invalid  Last LDF Rx
-----
port1.0.1
  vlan1       60      0      0           -
port1.0.2
  vlan1       0       0      0           -
port1.0.3
  vlan1       0       0      0           -
...
```



# show mac address-table

**Overview** Use this command to display the MAC address-table for all configured VLANs.

**Syntax** show mac address-table

**Mode** User Exec and Privileged Exec

**Usage notes** The **show mac address-table** command is only applicable to view a MAC address-table for Layer 2 switched traffic within VLANs.

**Example** To display the mac address-table, use the following command:

```
awplus# show mac address-table
```

**Output** See the following sample output captured when there was no traffic being switched:

```
awplus#show mac address-table
```

VLAN	port	mac	type	
1	unknown	0000.cd28.0752	forward	static
ARP	-	0000.cd00.0000	forward	static

See the sample output captured when packets were switched and MAC addresses were learned:

```
awplus#show mac address-table
```

VLAN	port	mac	type	
1	unknown	0000.cd28.0752	forward	static
1	port1.0.2	0030.846e.9bf4	forward	dynamic
1	port1.0.3	0030.846e.bac7	forward	dynamic
ARP	-	0000.cd00.0000	forward	static

Note the new MAC addresses learned for port1.0.2 and port1.0.3 added as dynamic entries.

Note the first column of the output below shows VLAN IDs if multiple VLANs are configured:

```
awplus#show mac address-table
```

VLAN	port	mac	type	
1	unknown	0000.cd28.0752	forward	static
1	port1.0.2	0030.846e.bac7	forward	dynamic
2	unknown	0000.cd28.0752	forward	static
2	port1.0.3	0030.846e.9bf4	forward	dynamic
ARP	-	0000.cd00.0000	forward	static

Also note if manually configured static MAC addresses exist, this is shown to the right of the type column:

```
awplus(config)#mac address-table static 0000.1111.2222 for int
port1.0.3 vlan 1
awplus(config)#end
awplus#
awplus#show mac address-table
```

VLAN	port	mac	type	
1	unknown	0000.cd28.0752	forward	static
1	port1.0.2	0030.846e.bac7	forward	dynamic
1	port1.0.3	0000.1111.2222	forward	static
...				

**Related  
commands**

- [clear mac address-table dynamic](#)
- [clear mac address-table static](#)
- [mac address-table static](#)

# show mac address-table thrash-limit

**Overview** Use this command to display the current thrash limit set for all interfaces on the device.

**Syntax** `show mac address-table thrash-limit`

**Mode** User Exec and Privileged Exec

**Example** To display the current, use the following command:

```
awplus# show mac address-table thrash-limit
```

**Output** Figure 13-6: Example output from the **show mac address-table thrash-limit** command

```
% Thrash-limit 7 movements per second
```

**Related commands** [mac address-table thrash-limit](#)

# show platform

**Overview** This command displays the settings configured by using the **platform** commands.

**Syntax** `show platform`

**Mode** Privileged Exec

**Usage notes** This command displays the settings in the running config. For changes in some of these settings to take effect, the device must be rebooted with the new settings in the startup config.

**Example** To check the settings configured with **platform** commands on the device, use the following command:

```
awplus# show platform
```

**Output** Figure 13-7: Example output from the **show platform** command

```
awplus# show platform

MAC vlan hashing algorithm      crc32l
L3 hashing algorithm           crc32l
Load Balancing                 src-dst-ip
stop-unreg-mc-flooding        off
Vlan-stacking TPID            0x8100
```

**Table 14:** Parameters in the output of the **show platform** command. Note that the parameters displayed depend on your device, and that not all displayed parameters can be modified on all devices.

Parameter	Description
Routing Ratio	Whether all memory is allocated to IPv4 address table entries only, or whether it is allocated evenly to both IPv4 and IPv6 addresses (set with the <b>platform routingratio</b> command).
Route Weighting	The split between multicast and unicast route entries (set with the <b>platform routingratio</b> command).
MAC vlan hashing algorithm	The MAC VLAN hash-key-generating algorithm (set with the <b>platform mac-vlan-hashing-algorithm</b> command). The default algorithm is <code>crc32l</code> . The algorithm may need to be changed in rare circumstances in which hash collisions occur.
L3 hashing algorithm	The L3 VLAN hash-key-generating algorithm (set with the <b>platform l3-vlan-hashing-algorithm</b> command). The default algorithm is <code>crc32l</code> . The algorithm may need to be changed in rare circumstances in which hash collisions occur.
Load Balancing	Which packet fields are used in the channel load balancing algorithm (set with the <b>platform load-balancing</b> command).

**Table 14:** Parameters in the output of the **show platform** command. Note that the parameters displayed depend on your device, and that not all displayed parameters can be modified on all devices. (cont.)

Parameter	Description
Control-plane-prioritization	Maximum traffic rate on the CPU port (set with the <b>platform control-plane-prioritization rate</b> command).
Fdb-chain-length	The length of the FDB hash chain (set with the <b>platform fdb-chain-length</b> command). FDB entries are hashed and indexed using a hash. In rare circumstances it may be useful to reduce the chain length.
L2MC overlapped group check	Whether Layer 2 multicast entries are checked before deletion (set with the <b>platform l2mc-overlap</b> command).
silicon-profile	The silicon profile setting (set with the <b>platform silicon-profile</b> command) for the switch hardware; one of: <ul style="list-style-type: none"> <li>• profile 1</li> <li>• profile 2</li> <li>• profile 3</li> <li>• None (default)</li> </ul>
fdb-l3-hosts mode	Whether Host Mode is turned on or not. Host Mode increases the number of host entries and is available for systems containing SBx81CFC960 controller cards and SBx81XLEM line cards. See <b>platform silicon-profile</b> and <b>platform fdb-l3-hosts</b> for details.
Jumboframe support	Whether the jumbo frames setting is enabled or disabled (set with the <b>platform jumboframe</b> command).
Traffic Manager	A test setting that is disabled by default.
stop-unreg-mc-flooding	Whether the stop-unreg-mc-flooding feature is on or off (set with the <b>platform stop-unreg-mc-flooding</b> command). This feature prevents flooding of unregistered multicast packets in the occasional situations in which IGMP snooping does not prevent it.
Port Mode	Whether each port on the AT-StackQS is configured as one 40Gbps port or four 10Gbps ports, if they are operating as network ports (set with the <b>platform portmode interface</b> command).
Vlan-stacking TPID	The value of the TPID set in the Ethernet type field when a frame has a double VLAN tag (set with the <b>platform vlan-stacking-tpid</b> command).
PBR enabled	Whether policy-based routing is globally enabled or not (set with the <b>platform pbr-enable</b> command).

**Table 14:** Parameters in the output of the **show platform** command. Note that the parameters displayed depend on your device, and that not all displayed parameters can be modified on all devices. (cont.)

Parameter	Description
Hardware Filter Size	Whether hardware ACLs can filter on IPv6 addresses (ipv4-full-ipv6) or not (ipv4-limited-ipv6). This is set with the <b>platform hwfilter-size</b> command.
Vlan Ingress Filter Hard Drop	The Bridge Vlan Ingress Filtering drops traffic if the VID assigned to the packet does not match with the port's VLAN membership. There are two ways the traffic is dropped by the Ingress Filtering mechanism: <ul style="list-style-type: none"><li>• HARD DROP - Traffic is dropped by the Bridge Engine and not forwarded or trapped.</li><li>• SOFT DROP - Traffic may be mirrored or trapped by the Bridge Engine.</li></ul>

# show platform classifier statistics utilization brief

**Overview** This command displays the number of used entries available for various platform functions, and the percentage that number of entries represents of the total available.

**Syntax** `show platform classifier statistics utilization brief`

**Mode** Privileged Exec

**Example** To display the platform classifier utilization statistics, use the following command:

```
awplus# show platform classifier statistics utilization brief
```

**Output** Figure 13-8: Output from **show platform classifier statistics utilization brief**

```
awplus#show platform classifier statistics utilization brief

[Instance 0]
Number of Entries:
Policy Type      Group ID      Used / Total
-----
ACL              1476395009   0 / 118 ( 0%)
Web Auth        Inactive      0 / 0 ( 0%)
QoS              0 / 128 ( 0%)
```

**Output parameters** Depending on your switch, you will see some of the following parameters in the output from **show platform classifier statistics utilization brief**

Parameter	Description
IPv6 Multicast	Reserved hardware space for use by IPv6 multicast.
System	Fixed system entries. For example, resiliency links make use of system ACLs.
MLD Snooping	Entries to send various packets that MLD Snooping is interested in to the CPU.
DHCP Snooping	Entries used to send DHCP and ARP packets to the CPU. User-added DHCP Snooping filters under ACLs are counted under the ACL or QoS categories.
Loop Detection	Entries uses to send the special loop detection frame to the CPU.
EPSR	Entries used to send EPSR control traffic to the CPU.
CFM	Entries used by Connectivity Fault Management.
G8032	Entries used to send G.8032 control traffic to the CPU.

Parameter	Description
Global ACLs	Entries for ACLs appear here if the ACLs are applied globally instead of per switchport.
ACL	Entries for ACL filters that have been applied directly to ports using the <a href="#">access-group</a> command.
VACL	Entries for VLAN-based ACLs (ACLs that are applied to VLANs instead of ports).
DOS	Entries used for Denial of Service protection.
UFO	Entries used by Upward Forwarding Only (UFO).
QoS	Entries for ACL filters and other class-map configurations, such as policers, applied through policy maps using the service input command.
RA Guard	Entries used to block IPv6 router advertisements, configured with the <b>ipv6 nd rguard</b> command.
AMFAPPS	Entries used by AMF Application Proxy. These entries enable the SES Controller to block infected ports.
Pre-Ingress	Entries used for VLAN ID Translation (and also for subnet-based and MAC-based VLAN entries on SBx81XLEM cards).
Egress	Entries used for VLAN ID Translation.
UDB	User Defined Bytes (UDB), which are a limited resource of bytes that can be used to implement additional arbitrary matching on packet bytes on some switches. The software manages the use and allocation of these bytes automatically. The output of this table is intended for use by Allied Telesis Customer Support only.

**Related commands** [show platform](#)



# show platform port

**Overview** This command displays the various port registers or platform counters for specified switchports.

**Syntax** `show platform port [<port-list>] [counters]`

Parameter	Description
<code>&lt;port-list&gt;</code>	The ports to display information about. A port-list can be: <ul style="list-style-type: none"><li>• a switchport (e.g. port1.0.4)</li><li>• a continuous range of ports separated by a hyphen (e.g. port1.0.1-1.0.4)</li><li>• a comma-separated list (e.g. port1.0.1,port1.0.3-1.0.4).</li></ul>
<code>counters</code>	Show the platform counters.

**Mode** Privileged Exec

**Examples** To display port registers for port1.0.1 to port1.0.4, use the command:

```
awplus# show platform port port1.0.1-port1.0.4
```

To display platform counters for port1.0.1 to port1.0.4, use the command:

```
awplus# show platform port port1.0.1-port1.0.4 counters
```

**Output** Figure 13-9: Example output from the **show platform port** command

```
awplus#show platform port port1.0.1
Phy register value for port1.0.1 (ifindex: 5001)

00:1140 01:79ed 02:600d 03:85b0 04:01e1 05:c1e1 06:006d 07:2001
08:4d44 09:0600 0a:3800 0b:0000 0c:0000 0d:4007 0e:0000 0f:3000
10:0021 11:0f00 12:0000 13:0000 14:0000 15:0238 16:0000 17:0000
18:4c00 19:871c 1a:243e 1b:ffff 1c:0002 1d:22d7 1e:0000 1f:0000

Port configuration for lport 0x08002002:
Phy Driver: 542XX Gigabit PHY Driver
  enabled: 1
  loopback: 0
  link: 1
  speed: 1000 max speed: 1000
  duplex: 1
  linkscan: 2
  autonegotiate: 1
  master: 2
  tx pause: 0 rx pause: 0
  untagged vlan: 4000
  vlan filter: 3
  stp state: 4
  learn: 5
  discard: 0
  jam: 0
  max frame size: 1500
  MC Disable SA: no
  MC Disable TTL: no
  MC egress untag: 0
  MC egress vid: 1
  MC TTL threshold: -1
```

# show port-security interface

**Overview** Use this command to show the current port-security configuration and the switch port status.

**Syntax** `show port-security interface <port>`

Parameter	Description
<code>&lt;port&gt;</code>	The port to display information about. The port may be a switch port (e.g. port1.0.2), a static channel group (e.g. sa3), or a dynamic (LACP) channel group (e.g. po4).

**Mode** Privileged Exec

**Example** To see the port-security status on port1.0.2, use the following command:

```
awplus# show port-security interface port1.0.2
```

**Output** Figure 13-10: Example output from the **show port-security interface** command

```
Port Security configuration
Security Enabled           : YES
Port Status                : ENABLED
Violation Mode             : TRAP
Aging                      : OFF
Maximum MAC Addresses     : 3
Total MAC addresses       : 1
Lock Status                : UNLOCKED
Security Violation Count   : 0
Last Violation Source Address : None
```

**Related commands**

- [clear port-security intrusion](#)
- [show port-security intrusion](#)
- [switchport port-security](#)
- [switchport port-security aging](#)
- [switchport port-security maximum](#)
- [switchport port-security violation](#)

# show port-security intrusion

**Overview** Use this command to show the intrusion list. If the port is not specified, the entire intrusion table is shown.

**Syntax** `show port-security intrusion [interface <port>]`

Parameter	Description
interface	Specify a port
<port>	The port to display information about. The port may be a switch port (e.g. port1.0.2), a static channel group (e.g. sa3), or a dynamic (LACP) channel group (e.g. po4).

**Mode** Privileged Exec

**Example** To see the intrusion list on port1.0.2, use the following command:

```
awplus# show port-security intrusion interface port1.0.2
```

**Output** Figure 13-11: Example output from the **show port-security intrusion** command for port1.0.2

```
Port Security Intrusion List
Interface: port1.0.2 -3 intrusion(s) detected
11-22-33-44-55-04 11-22-33-44-55-06 11-22-33-44-55-08
```

**Related commands**

- [clear port-security intrusion](#)
- [show port-security interface](#)
- [switchport port-security](#)
- [switchport port-security aging](#)
- [switchport port-security maximum](#)
- [switchport port-security violation](#)

# show storm-control

**Overview** Use this command to display storm-control information for all interfaces or a particular interface.

**Syntax** `show storm-control [<port>]`

Parameter	Description
<port>	The port to display information about. The port may be: <ul style="list-style-type: none"><li>• a switchport (e.g. port1.0.4)</li><li>• a static channel group (e.g. sa2)</li><li>• a dynamic (LACP) channel group (e.g. po2)</li></ul>

**Mode** User Exec and Privileged Exec

**Example** To display storm-control information for port1.0.2, use the following command:

```
awplus# show storm-control port1.0.2
```

**Output** Figure 13-12: Example output from the **show storm-control** command for port1.0.2

Port	BcastLevel	McastLevel	DlfLevel
port1.0.2	40.0%	100.0%	100.0%

**Related commands** [storm-control level](#)

# speed

**Overview** This command changes the speed of the specified port. You can optionally specify the speed or speeds that get autonegotiated, so autonegotiation is only attempted at the specified speeds.

To see the currently-negotiated speed for ports whose links are up, use the [show interface](#) command. To see the configured speed (when different from the default), use the [show running-config](#) command.

**Syntax** `speed {10|100|1000}`  
`speed auto [10] [100] [1000]`

The following table shows the speed options for each type of port.

Port type	Speed Options (units are Mbps)
RJ-45 copper ports	auto (default) 10 100 1000
tri-speed copper SFPs	auto (default) 10 100 1000
100 Mbps fiber SFPs	100
1000 Mbps fiber SFPs	auto (default) 1000
1000 Mbps copper SFPs	auto (default) 1000

**Mode** Interface Configuration

**Default** By default, ports autonegotiate speed (except for 100Base-FX ports which do not support auto-negotiation, so default to 100 Mbps).

**Usage notes** We recommend having autonegotiation enabled for link speeds of 1000 Mbps and above. For example, to apply a fixed speed of 1000 Mbps use the command **speed auto 1000**.

If multiple speeds are specified after the auto option to autonegotiate speeds, then the device only attempts autonegotiation at those specified speeds.

Switch ports in a static or dynamic (LACP) channel group must have the same port speed and be in full duplex mode. Once switch ports have been aggregated into a channel group, you can set the speed of all the switch ports in the channel group by applying this command to the channel group.

**Examples** To set the speed of a tri-speed port to 100 Mbps, enter the following commands:

```
awplus# configure terminal
awplus(config)# interface port1.0.2
awplus(config-if)# speed 100
```

To return the port to auto-negotiating its speed, enter the following commands:

```
awplus# configure terminal
awplus(config)# interface port1.0.2
awplus(config-if)# speed auto
```

To set the port to auto-negotiate its speed at 100 Mbps and 1000 Mbps, enter the following commands:

```
awplus# configure terminal
awplus(config)# interface port1.0.2
awplus(config-if)# speed auto 100 1000
```

To set the port to auto-negotiate its speed at 1000 Mbps only, which will fix this port speed to 1000 Mbps, enter the following commands:

```
awplus# configure terminal
awplus(config)# interface port1.0.2
awplus(config-if)# speed auto 1000
```

**Related commands**

- [duplex](#)
- [polarity](#)
- [show interface](#)
- [speed \(asyn\)](#)

# storm-control level

**Overview** Use this command to specify the speed limiting level for broadcast, multicast, or dlf (destination lookup failure) traffic for the port. Storm-control limits the selected traffic type to the specified percentage of the maximum port speed.

Use the **no** variant of this command to disable storm-control for broadcast, multicast or dlf traffic.

**Syntax** `storm-control {broadcast|multicast|dlf} level <level>`  
`no storm-control {broadcast|multicast|dlf} level`

Parameter	Description
<level>	<0-100> Specifies the percentage of the maximum port speed allowed for broadcast, multicast or destination lookup failure traffic.
broadcast	Applies the storm-control to broadcast frames.
multicast	Applies the storm-control to multicast frames.
dlf	Applies the storm-control to destination lookup failure traffic.

**Default** Disabled

**Mode** Interface Configuration

**Usage notes** Flooding techniques are used to block the forwarding of unnecessary flooded traffic. A packet storm occurs when a large number of broadcast packets are received on a port. Forwarding these packets can cause the network to slow down or time out.

More than one limit type can be set at a time. For example, you can configure both broadcast and multicast levels on the same port, at the same time.

**Example** To limit broadcast traffic on port 1.0.2 to 30% of the maximum port speed, use the following commands:

```
awplus# configure terminal
awplus(config)# interface port1.0.2
awplus(config-if)# storm-control broadcast level 30
```

**Related commands** [show storm-control](#)

**Command changes** Version 5.4.9-1.3: Multiple limit types available on x530 series



# switchport port-security

**Overview** Use this command to enable the port-security feature. This feature is also known as the port-based learn limit. It allows the user to set the maximum number of MAC addresses that each port can learn.

Use the **no** variant of this command to disable the port-security feature.

**Syntax** `switchport port-security`  
`no switchport port-security`

**Mode** Interface Configuration

**Examples** To enable the port-security feature on port1.0.2, use the following commands:

```
awplus# configure terminal
awplus(config)# interface port1.0.2
awplus(config-if)# switchport port-security
```

To disable the port-security feature on port1.0.2, use the following commands:

```
awplus# configure terminal
awplus(config)# interface port1.0.2
awplus(config-if)# no switchport port-security
```

**Related commands**

- [clear port-security intrusion](#)
- [show port-security interface](#)
- [show port-security intrusion](#)
- [switchport port-security aging](#)
- [switchport port-security maximum](#)
- [switchport port-security violation](#)

# switchport port-security aging

**Overview** Use this command to set MAC addresses that have been learned by port security to age out.

Use the **no** variant of this command to set the MAC addresses to not age out.

**Syntax** `switchport port-security aging`  
`no switchport port-security aging`

**Mode** Interface Configuration

**Examples** To set port1.0.2 so that the MAC addresses that have been learned by port security age out, use the following commands:

```
awplus# configure terminal
awplus(config)# interface port1.0.2
awplus(config-if)# switchport port-security aging
```

To stop the MAC addresses that have been learned by port security from aging out on port1.0.2, use the following commands:

```
awplus# configure terminal
awplus(config)# interface port1.0.2
awplus(config-if)# no switchport port-security aging
```

**Related commands**

- `clear port-security intrusion`
- `show port-security interface`
- `show port-security intrusion`
- `switchport port-security`
- `switchport port-security maximum`
- `switchport port-security violation`

# switchport port-security maximum

**Overview** Use this command to set the maximum number of MAC addresses that each port can learn.

Use the **no** variant of this command to unset the maximum number of MAC addresses that each port can learn. This is same as setting the maximum number to 0. This command also resets the intrusion list table.

If a new MAC is seen on a port with port security enabled and the MAC is statically configured for another port, a violation is triggered. The maximum learn limit will be ignored and the specified intrusion action for the port will be carried out.

**Syntax** `switchport port-security maximum <0-256>`  
`no switchport port-security maximum`

Parameter	Description
maximum <0-256>	Specify the maximum number of addresses to learn.

**Mode** Interface Configuration

**Examples** To learn 3 MAC addresses on port1.0.2, use the following commands:

```
awplus# configure terminal
awplus(config)# interface port1.0.2
awplus(config-if)# switchport port-security maximum 3
```

To remove the MAC learning limit on port1.0.2, use the following commands:

```
awplus# configure terminal
awplus(config)# interface port1.0.2
awplus(config-if)# no switchport port-security maximum
```

**Related commands**

- [clear port-security intrusion](#)
- [show port-security interface](#)
- [show port-security intrusion](#)
- [switchport port-security](#)
- [switchport port-security aging](#)
- [switchport port-security violation](#)

# switchport port-security violation

**Overview** Use this command to set the action taken on a switch port when the port exceeds the learning limits. The port action can be either **shutdown**, **restrict** or **protect**. If **shutdown** is set, the physical link will be disabled and "shutdown" will be shown in the config. If **restrict** is set, the packet from the un-authorized MAC will be discarded and SNMP TRAP will be generated to alert management. If **protect** is set, the packet will simply be discarded by the packet processor silently.

Use the **no** variant of this command to set the violation action to default. The default violation action is protect.

**Syntax** `switchport port-security violation {shutdown|restrict|protect}`  
`no switchport port-security violation`

Parameter	Description
shutdown	Disable the port.
restrict	Alert the network administrator.
protect	Discard the packet.

**Mode** Interface Configuration

**Examples** To set the action to be shutdown on port1.0.2, use the following commands:

```
awplus# configure terminal
awplus(config)# interface port1.0.2
awplus(config-if)# switchport port-security violation shutdown
```

To set the port-security action to the default (protect) on port1.0.2, use the following commands:

```
awplus# configure terminal
awplus(config)# interface port1.0.2
awplus(config-if)# no switchport port-security violation
```

**Related commands**

- [clear port-security intrusion](#)
- [show port-security interface](#)
- [show port-security intrusion](#)
- [switchport port-security](#)
- [switchport port-security aging](#)
- [switchport port-security maximum](#)

# thrash-limiting

**Overview** Use this command to configure the thrash limit action that will be applied to a port on the device when a thrashing condition is detected. The thrash-limiting timeout specifies the time, in seconds, for which the action is employed.

Use the **no** variant of this command to return the action or timeout to its default setting.

**Syntax** thrash-limiting {[action  
{learn-disable|link-down|port-disable|vlan-disable|none}]  
[timeout <0-86400>]}  
no thrash-limiting {action|timeout}

Parameter	Description
action	The action taken when MAC thrashing is detected.
learn-disable	Disable MAC address learning
link-down	Block all traffic on an interface - link down
port-disable	Block all traffic on an interface - link remains up
vlan-disable	Block all traffic on a VLAN if the switch detects thrashing for that VLAN on the selected port. Note that setting this parameter will also enable ingress filtering.
none	No thrash action
timeout	Set the duration for the thrash action
<0-86400>	The duration of the applied thrash action in seconds. The default is 1 seconds.

**Default** The default action is learn-disable and the default timeout is 1 second.

**Mode** Interface Configuration

**Usage** Thrash-limiting actions are initiated when MAC addresses are added and removed from a port's MAC table faster than a given rate. The rate is 10 MAC address changes per second by default. You can change it with the [mac address-table thrash-limit](#) command.

See the "Thrash Limiting" section in the [Switching Feature Overview and Configuration Guide](#) for more information.

**Examples** To set the action to learn disable for port1.0.1, use the following commands:

```
awplus# configure terminal
awplus(config)# interface port1.0.1
awplus(config-if)# thrash-limiting action learn-disable
```

To block all traffic on a VLAN on port1.0.1 if the switch detects thrashing for that VLAN on that port, use the following commands:

```
awplus# configure terminal
awplus(config)# interface port1.0.1
awplus(config-if)# thrash-limiting action vlan-disable
```

To set the thrash limiting action to its default on port1.0.1, use the following commands:

```
awplus# configure terminal
awplus(config)# interface port1.0.1
awplus(config-if)# no thrash-limiting action
```

To set the thrash limiting timeout to 5 seconds on port1.0.1, use the following commands:

```
awplus# configure terminal
awplus(config)# interface port1.0.1
awplus(config-if)# thrash-limiting timeout 5
```

To set the thrash limiting timeout value to its default on port1.0.1, use the following commands:

```
awplus# configure terminal
awplus(config)# interface port1.0.1
awplus(config-if)# no thrash-limiting timeout
```

**Related commands** [mac address-table thrash-limit](#)  
[show interface](#)

# undebbug loopprot

**Overview** This command applies the functionality of the no `debug loopprot` command.

# undebbug platform packet

**Overview** This command applies the functionality of the no `debug platform packet` command.



# 14

# VLAN Commands

## Introduction

**Overview** This chapter provides an alphabetical reference of commands used to configure VLANs. For more information see the [VLAN Feature Overview and Configuration Guide](#).

- Command List**
- “[port-vlan-forwarding-priority](#)” on page 475
  - “[private-vlan](#)” on page 478
  - “[private-vlan association](#)” on page 479
  - “[show port-vlan-forwarding-priority](#)” on page 480
  - “[show vlan](#)” on page 481
  - “[show vlan access-map](#)” on page 482
  - “[show vlan filter](#)” on page 483
  - “[show vlan private-vlan](#)” on page 484
  - “[switchport access vlan](#)” on page 485
  - “[switchport mode access](#)” on page 486
  - “[switchport mode private-vlan](#)” on page 487
  - “[switchport mode private-vlan trunk promiscuous](#)” on page 488
  - “[switchport mode private-vlan trunk secondary](#)” on page 490
  - “[switchport mode trunk](#)” on page 492
  - “[switchport private-vlan host-association](#)” on page 493
  - “[switchport private-vlan mapping](#)” on page 494
  - “[switchport trunk allowed vlan](#)” on page 495
  - “[switchport trunk native vlan](#)” on page 498
  - “[switchport voice dscp](#)” on page 499

- [“switchport voice vlan”](#) on page 500
- [“switchport voice vlan priority”](#) on page 502
- [“vlan”](#) on page 503
- [“vlan access-map”](#) on page 505
- [“vlan database”](#) on page 506
- [“vlan filter”](#) on page 507

# port-vlan-forwarding-priority

**Overview** Use this command to specify which protocol has the highest priority for controlling transitions from blocking to forwarding traffic, when more than one of EPSR, Loop Protection, and MAC thrashing protection are used on the switch.

These protocols use the same mechanism to block or forward traffic. This command specifies either EPSR or Loop Protection as the highest priority protocol. Setting the priority stops contention between protocols.

For more information, see the Usage section below.

**CAUTION:** The **loop-protection** and **none** parameter options must not be set on an EPSR master node. Use the **epsr** parameter option on an EPSR master node instead. Setting this command incorrectly on an EPSR master node could cause unexpected broadcast storms.

Use the **no** variant of this command to restore the default highest priority protocol back to the default of EPSR.

For more information about EPSR, see the [EPSR Feature Overview and Configuration\\_Guide](#).

**Syntax** `port-vlan-forwarding-priority {epsr | loop-protection | none}`  
`no port-vlan-forwarding-priority`

Parameter	Description
<code>epsr</code>	Sets EPSR as the highest priority protocol. Use this parameter on an EPSR master node to avoid unexpected broadcast storms.
<code>loop-protection</code>	Sets Loop Protection as the highest priority protocol. Note that this option must not be set on an EPSR master node. Use the <b>epsr</b> parameter option on an EPSR master node to avoid unexpected broadcast storms.
<code>none</code>	Sets the protocols to have equal priority. This allows protocols to override each other to set a port to forwarding for a VLAN. Note that this option must not be set on a EPSR master node. Use the <b>epsr</b> parameter option on an EPSR master node to avoid unexpected broadcast storms.

**Default** By default, the highest priority protocol is EPSR

**Mode** Global Configuration

**Usage notes** Usually, you only need to configure one of EPSR, Loop Protection and MAC Thrashing protection on a switch, because they perform similar functions—each prevents network loops by blocking a selected port for each (loop-containing) VLAN.

However, if more than one of these three features is configured on a switch, you can use this command to prioritize either EPSR or Loop Protection when their

effects on a port would conflict and override each other. Without this command, each protocol could set a port to forwarding for a VLAN, sometimes overriding the previous setting by another protocol to block the port. This could sometimes lead to unexpected broadcast storms.

This command means that, when a protocol is set to have the highest priority over a data VLAN on a port, it will not allow other protocols to put that port-vlan into a forwarding state if the highest priority protocol blocked it.

The priority mechanism is only used for blocking-to-forwarding transitions; protocols remain independent on the forwarding-to-blocking transitions.

For example, consider an EPSR master node in a two-node ESPR ring with the following settings:

- The EPSR master node primary port is configured to switchport interface port1.0.1
- The EPSR master node secondary port is configured to switchport interface port1.0.2
- The EPSR master node control VLAN is configured to VLAN interface vlan10
- The EPSR master node has a first data VLAN configured to VLAN interface vlan20
- The EPSR master node has a second data VLAN configured to VLAN interface vlan30.

Initially, the EPSR ring is complete, with port1.0.2 blocking data VLANs vlan20 and vlan30 and some broadcast traffic flowing through. If the user removes vlan30 from EPSR, a storm is created on vlan30. MAC thrashing protection detects it and blocks vlan30.

Then after the storm has stopped, MAC thrashing protection sets it to forwarding again and it keeps oscillating between forwarding and blocking. In the meantime, the user adds back vlan30 to EPSR as a data VLAN and EPSR blocks it on port1.0.2.

If the priority is set to none (**port-vlan-forwarding-priority none**), MAC thrashing protection notices that the storm has stopped again and decides to put vlan30 on port1.0.2 into forwarding state. This overrides what EPSR requires for this port-VLAN and creates a storm.

If the priority is set to EPSR or default (**port-vlan-forwarding-priority epsr**), MAC thrashing protection notices that the storm has stopped again and attempts to put vlan30 on port1.0.2 into forwarding state. The higher priority protocol (EPSR) is blocking the VLAN on this port, so it stays blocking and no storm occurs.

**Example** To prioritize EPSR over Loop Protection or MAC Thrashing protection settings, so that Loop Protection or MAC Thrashing protection cannot set a port to the forwarding state for a VLAN if EPSR has set it to the blocking state, use the commands:

```
awplus# configure terminal
awplus(config)# port-vlan-forwarding-priority epsr
```

To prioritize Loop Protection over EPSR or MAC Thrashing protection settings, so that EPSR or MAC Thrashing protection cannot set a port to the forwarding state for a VLAN if Loop Protection has set it to the blocking state, use the commands:

```
awplus# configure terminal
awplus(config)# port-vlan-forwarding-priority loop-protection
```

To set EPSR, Loop Protection, and MAC Thrashing protection protocols to have equal priority for port forwarding and blocking, which allows the protocols to override each other to set a port to the forwarding or blocking states, use the commands:

```
awplus# configure terminal
awplus(config)# port-vlan-forwarding-priority none
```

To restore the default highest priority protocol back to the default of EPSR, use the commands:

```
awplus# configure terminal
awplus(config)# no port-vlan-forwarding-priority
```

**Related commands** [show port-vlan-forwarding-priority](#)

# private-vlan

**Overview** Use this command to create a private VLAN. Private VLANs can be either primary or secondary. Secondary VLANs can be either community or isolated.

Use the **no** variant of this command to remove the specified private VLAN.

For more information, see the [VLAN Feature Overview and Configuration Guide](#).

**Syntax** `private-vlan <vlan-id> {community|isolated|primary}`  
`no private-vlan <vlan-id> {community|isolated|primary}`

Parameter	Description
<vlan-id>	VLAN ID in the range <2-4094> for the VLAN which is to be made a private VLAN.
community	Community VLAN.
isolated	Isolated VLAN.
primary	Primary VLAN.

**Mode** VLAN Configuration

**Examples** To configure a set of private VLANs, use the following commands:

```
awplus# configure terminal
awplus(config)# vlan database
awplus(config-vlan)# vlan 2 name vlan2 state enable
awplus(config-vlan)# vlan 3 name vlan3 state enable
awplus(config-vlan)# vlan 4 name vlan4 state enable
awplus(config-vlan)# private-vlan 2 primary
awplus(config-vlan)# private-vlan 3 isolated
awplus(config-vlan)# private-vlan 4 community
```

To remove a set of private VLANs, use the following commands:

```
awplus# configure terminal
awplus(config)# vlan database
awplus(config-vlan)# no private-vlan 2 primary
awplus(config-vlan)# no private-vlan 3 isolated
awplus(config-vlan)# no private-vlan 4 community
```

**Related commands** [show vlan private-vlan](#)

# private-vlan association

**Overview** Use this command to associate a secondary VLAN to a primary VLAN. Only one isolated VLAN can be associated to a primary VLAN. Multiple community VLANs can be associated to a primary VLAN.

Use the **no** variant of this command to remove association of all the secondary VLANs to a primary VLAN.

For more information, see the [VLAN\\_Feature Overview and Configuration Guide](#).

**Syntax** `private-vlan <primary-vlan-id> association {add <secondary-vlan-id>|remove <secondary-vlan-id>}`  
`no private-vlan <primary-vlan-id> association`

Parameter	Description
<code>&lt;primary-vlan-id&gt;</code>	VLAN ID of the primary VLAN.
<code>&lt;secondary-vlan-id&gt;</code>	VLAN ID of the secondary VLAN (either isolated or community).

**Mode** VLAN Configuration

**Examples** The following commands associate primary VLAN 2 with secondary VLAN 3:

```
awplus# configure terminal
awplus(config)# vlan database
awplus(config-vlan)# private-vlan 2 association add 3
```

The following commands remove the association of primary VLAN 2 with secondary VLAN 3:

```
awplus# configure terminal
awplus(config)# vlan database
awplus(config-vlan)# private-vlan 2 association remove 3
```

The following commands remove all secondary VLAN associations of primary VLAN 2:

```
awplus# configure terminal
awplus(config)# vlan database
awplus(config-vlan)# no private-vlan 2 association
```

# show port-vlan-forwarding-priority

**Overview** Use this command to display the highest priority protocol that controls port-vlan forwarding or blocking traffic. This command displays whether EPSR or Loop Protection is set as the highest priority for determining whether a port forwards a VLAN, as set by the [port-vlan-forwarding-priority](#) command.

For more information about EPSR, see the [EPSR Feature Overview and Configuration\\_Guide](#).

**Syntax** `show port-vlan-forwarding-priority`

**Mode** Privileged Exec

**Example** To display the highest priority protocol, use the command:

```
awplus# show port-vlan-forwarding-priority
```

**Output** Figure 14-1: Example output from the **show port-vlan-forwarding-priority** command

```
Port-vlan Forwarding Priority: EPSR
```

**Related commands** [port-vlan-forwarding-priority](#)



# show vlan

**Overview** Use this command to display information about a particular VLAN by specifying its VLAN ID. Selecting **all** will display information for all the VLANs configured.

**Syntax** `show vlan`  
`{all|brief|dynamic|static|auto|static-ports|<1-4094>}`

Parameter	Description
<1-4094>	Display information about the VLAN specified by the VLAN ID.
all	Display information about all VLANs on the device.
brief	Display information about all VLANs on the device.
dynamic	Display information about all VLANs learned dynamically.
static	Display information about all statically configured VLANs.
auto	Display information about all auto-configured VLANs.
static-ports	Display static egress/forbidden ports.

**Mode** User Exec and Privileged Exec

**Example** To display information about VLAN 2, use the command:

```
awplus# show vlan 2
```

**Output** Figure 14-2: Example output from the **show vlan** command

VLAN ID	Name	Type	State	Member ports
				(u)-Untagged, (t)-Tagged
2	VLAN0002	STATIC	ACTIVE	port1.0.3(u) port1.0.4(u) port1.0.5(u) port1.0.6(u)
...				

**Related commands** [vlan](#)

# show vlan access-map

**Overview** Use this command to display information about the configured VLAN access-maps. VLAN access-maps contain a series of ACLs and enable you to filter traffic ingressing specified VLANs.

**Syntax** `show vlan access-map [<name>]`

Parameter	Description
<name>	The name of the access-map to display.

**Mode** User Exec/Privileged Exec

**Example** To display the ACLs in all access-maps, use the command:

```
awplus# show vlan access-map
```

**Output** Figure 14-3: Example output from **show vlan access-map**

```
awplus#show vlan access-map

Vlan access map : deny_all
Hardware MAC access list 4000
  10 deny any any

Vlan access map : ip_range
Hardware IP access list 3000
  10 deny ip 192.168.1.1/24 any
```

**Related commands** [vlan access-map](#)

**Command changes** Version 5.4.6-2.1: command added

# show vlan filter

**Overview** Use this command to display information about the configured VLAN filters. VLAN filters apply access-maps (and therefore ACLs) to VLANs. This enables you to filter traffic ingressing specified VLANs.

**Syntax** `show vlan filter [<access-map-name>]`

Parameter	Description
<i>&lt;access-map-name&gt;</i>	The name of an access-map. The command output displays only the filters that use that access-map.

**Mode** User Exec/Privileged Exec

**Example** To display information about the filter that uses the access-map named "deny\_all", use the command:

```
awplus# show vlan filter deny_all
```

**Output** Figure 14-4: Example output from **show vlan filter**

```
awplus#show vlan filter deny_all
Vlan filter : deny_all
  direction : ingress
  vlan list : 48-49
  access map : deny_all
Hardware MAC access list 4000
  10 deny any any
```

**Related commands** [vlan access-map](#)  
[vlan filter](#)

**Command changes** Version 5.4.6-2.1: command added

# show vlan private-vlan

**Overview** Use this command to display the private VLAN configuration and associations.

**Syntax** `show vlan private-vlan`

**Mode** User Exec and Privileged Exec

**Example** To display the private VLAN configuration and associations, enter the command:

```
awplus# show vlan private-vlan
```

**Output** Figure 14-5: Example output from the **show vlan private-vlan** command

```
awplus#show vlan private-vlan
```

PRIMARY	SECONDARY	TYPE	INTERFACES
-----	-----	-----	-----
2	3	isolated	
2	4	community	
	8	isolated	

**Related commands** [private-vlan](#)  
[private-vlan association](#)

# switchport access vlan

**Overview** Use this command to change the port-based VLAN of the current port.  
Use the **no** variant of this command to change the port-based VLAN of this port to the default VLAN, vlan1.

**Syntax** `switchport access vlan <vlan-id>`  
`no switchport access vlan`

Parameter	Description
<vlan-id>	<1-4094> The port-based VLAN ID for the port.

**Default** Reset the default VLAN 1 to specified switchports using the negated form of this command.

**Mode** Interface Configuration

**Usage notes** Any untagged frame received on this port will be associated with the specified VLAN.

**Examples** To change the port-based VLAN to VLAN 3 for port1.0.2, use the commands:

```
awplus# configure terminal
awplus(config)# interface port1.0.2
awplus(config-if)# switchport access vlan 3
```

To reset the port-based VLAN to the default VLAN 1 for port1.0.2, use the commands:

```
awplus# configure terminal
awplus(config)# interface port1.0.2
awplus(config-if)# no switchport access vlan
```

**Related commands** [show interface switchport](#)  
[show vlan](#)

# switchport mode access

**Overview** Use this command to set the switching characteristics of the port to access mode. Received frames are classified based on the VLAN characteristics, then accepted or discarded based on the specified filtering criteria.

**Syntax** `switchport mode access [ingress-filter {enable|disable}]`

Parameter	Description
<code>ingress-filter</code>	Set the ingress filtering for the received frames.
<code>enable</code>	Turn on ingress filtering for received frames. This is the default.
<code>disable</code>	Turn off ingress filtering to accept frames that do not meet the classification criteria.

**Default** By default, ports are in access mode with ingress filtering on.

**Usage notes** Use access mode to send untagged frames only.

**Mode** Interface Configuration

**Example**

```
awplus# configure terminal
awplus(config)# interface port1.0.2
awplus(config-if)# switchport mode access ingress-filter enable
```

**Validation Command** `show interface switchport`

# switchport mode private-vlan

**Overview** Use this command to make a Layer 2 port a private VLAN host port or a promiscuous port.

Use the **no** variant of this command to remove the configuration.

**Syntax** `switchport mode private-vlan {host|promiscuous}`  
`no switchport mode private-vlan {host|promiscuous}`

Parameter	Description
host	This port type can communicate with all other host ports assigned to the same community VLAN, but it cannot communicate with the ports in the same isolated VLAN. All communications outside of this VLAN must pass through a promiscuous port in the associated primary VLAN.
promiscuous	A promiscuous port can communicate with all interfaces, including the community and isolated ports within a private VLAN.

**Mode** Interface Configuration

**Examples** To configure host mode, use the commands:

```
awplus# configure terminal
awplus(config)# interface port1.0.2
awplus(config-if)# switchport mode private-vlan host
```

To configure promiscuous mode, use the commands:

```
awplus# configure terminal
awplus(config)# interface port1.0.3
awplus(config-if)# switchport mode private-vlan promiscuous
```

To remove promiscuous mode, use the commands:

```
awplus# configure terminal
awplus(config)# interface port1.0.3
awplus(config-if)# no switchport mode private-vlan promiscuous
```

**Related commands** [switchport private-vlan mapping](#)

# switchport mode private-vlan trunk promiscuous

**Overview** Use this command to enable a port in trunk mode to be a promiscuous port for isolated VLANs.

Use the **no** variant of this command to remove a port in trunk mode as a promiscuous port for isolated VLANs. You must first remove the secondary port, or ports, in trunk mode associated with the promiscuous port with the **no switchport mode private-vlan trunk secondary** command.

**Syntax** `switchport mode private-vlan trunk promiscuous group <group-id>`  
`no switchport mode private-vlan trunk promiscuous`

Parameter	Description
<code>&lt;group-id&gt;</code>	The group ID is a numeric value in the range 1 to 32 that is used to associate the promiscuous port with secondary ports.

**Default** By default, a port in trunk mode is disabled as a promiscuous port.

**Mode** Interface Configuration

**Usage notes** A port must be put in trunk mode with [switchport mode trunk](#) command before it can be enabled as a promiscuous port.

To add VLANs to be trunked over the promiscuous port, use the [switchport trunk allowed vlan](#) command. These VLANs can be isolated VLANs, or non-private VLANs.

To configure the native VLAN for the promiscuous port, use the [switchport trunk native vlan](#) command. The native VLAN can be an isolated VLAN, or a non-private VLAN.

When you enable a promiscuous port, all of the secondary port VLANs associated with the promiscuous port via the group ID number must be added to the promiscuous port. In other words, the set of VLANs on the promiscuous port must be a superset of all the VLANs on the secondary ports within the group.



**Examples** To create the isolated VLANs 2, 3 and 4 and then enable port1.0.2 in trunk mode as a promiscuous port for these VLANs with the group ID of 3, use the following commands:

```
awplus# configure terminal
awplus(config)# vlan database
awplus(config-vlan)# vlan 2-4
awplus(config-vlan)# private-vlan 2 isolated
awplus(config-vlan)# private-vlan 3 isolated
awplus(config-vlan)# private-vlan 4 isolated
awplus(config-vlan)# exit
awplus(config)# interface port1.0.2
awplus(config-if)# switchport mode trunk
awplus(config-if)# switchport trunk allowed vlan add 2-4
awplus(config-if)# switchport mode private-vlan trunk
promiscuous group 3
```

To remove port1.0.2 in trunk mode as a promiscuous port for a private VLAN, use the commands:

```
awplus# configure terminal
awplus(config)# interface port1.0.2
awplus(config-if)# no switchport mode private-vlan trunk
promiscuous
```

Note that you must remove the secondary port or ports enabled as trunk ports that are associated with the promiscuous port before removing the promiscuous port.

**Related commands**

- [switchport mode private-vlan trunk secondary](#)
- [switchport mode trunk](#)
- [switchport trunk allowed vlan](#)
- [switchport trunk native vlan](#)
- [show vlan private-vlan](#)

# switchport mode private-vlan trunk secondary secondary

**Overview** Use this command to enable a port in trunk mode to be a secondary port for isolated VLANs.

Use the **no** variant of this command to remove a port in trunk mode as a secondary port for isolated VLANs.

**Syntax** `switchport mode private-vlan trunk secondary group <group-id>`  
`no switchport mode private-vlan trunk secondary`

Parameter	Description
<code>&lt;group-id&gt;</code>	The group ID is a numeric value in the range 1 to 32 that is used to associate a secondary port with its promiscuous port.

**Default** By default, a port in trunk mode is disabled as a secondary port.

When a port in trunk mode is enabled to be a secondary port for isolated VLANs, by default it will have a native VLAN of **none** (no native VLAN specified).

**Mode** Interface Configuration

**Usage notes** A port must be put in trunk mode with `switchport mode trunk` command before the port is enabled as a secondary port in trunk mode.

To add VLANs to be trunked over the secondary port use the `switchport trunk allowed vlan` command. These must be isolated VLANs and must exist on the associated promiscuous port.

To configure the native VLAN for the secondary port, use the `switchport trunk native vlan` command. The native VLAN must be an isolated VLAN and must exist on the associated promiscuous port.

**Examples** To create isolated private VLAN 2 and then enable port1.0.3 in trunk mode as a secondary port for the this VLAN with the group ID of 3, use the following commands:

```
awplus# configure terminal
awplus(config)# vlan database
awplus(config-vlan)# vlan 2
awplus(config-vlan)# private-vlan 2 isolated
awplus(config-vlan)# exit
awplus(config)# interface port1.0.3
awplus(config-if)# switchport mode trunk
awplus(config-if)# switchport trunk allowed vlan add 2
awplus(config-if)# switchport mode private-vlan trunk secondary
group 3
```

To remove port1.0.3 in trunk mode as a secondary port, use the commands:

```
awplus# configure terminal
awplus(config)# interface port1.0.3
awplus(config-if)# no switchport mode private-vlan trunk
secondary
```

**Related commands**

- [switchport mode private-vlan trunk promiscuous](#)
- [switchport mode trunk](#)
- [switchport trunk allowed vlan](#)
- [switchport trunk native vlan](#)
- [show vlan private-vlan](#)

# switchport mode trunk

**Overview** Use this command to set the switching characteristics of the port to trunk. Received frames are classified based on the VLAN characteristics, then accepted or discarded based on the specified filtering criteria.

**Syntax** `switchport mode trunk [ingress-filter {enable|disable}]`

Parameter	Description
<code>ingress-filter</code>	Set the ingress filtering for the frames received.
<code>enable</code>	Turn on ingress filtering for received frames. This is the default.
<code>disable</code>	Turn off ingress filtering to accept frames that do not meet the classification criteria.

**Default** By default, ports are in access mode, are untagged members of the default VLAN (vlan1), and have ingress filtering on.

**Mode** Interface Configuration

**Usage notes** A port in trunk mode can be a tagged member of multiple VLANs, and an untagged member of one native VLAN.

To configure which VLANs this port will trunk for, use the [switchport trunk allowed vlan](#) command.

**Example**

```
awplus# configure terminal
awplus(config)# interface port1.0.3
awplus(config-if)# switchport mode trunk ingress-filter enable
```

**Validation Command** [show interface switchport](#)

# switchport private-vlan host-association

**Overview** Use this command to associate a primary VLAN and a secondary VLAN to a host port. Only one primary and secondary VLAN can be associated to a host port.

Use the **no** variant of this command to remove the association.

**Syntax** `switchport private-vlan host-association <primary-vlan-id> add <secondary-vlan-id>`  
`no switchport private-vlan host-association`

Parameter	Description
<code>&lt;primary-vlan-id&gt;</code>	VLAN ID of the primary VLAN.
<code>&lt;secondary-vlan-id&gt;</code>	VLAN ID of the secondary VLAN (either isolated or community).

**Mode** Interface Configuration

**Examples** `awplus# configure terminal`  
`awplus(config)# interface port1.0.2`  
`awplus(config-if)# switchport private-vlan host-association 2`  
`add 3`  
`awplus# configure terminal`  
`awplus(config)# interface port1.0.2`  
`awplus(config-if)# no switchport private-vlan host-association`

# switchport private-vlan mapping

**Overview** Use this command to associate a primary VLAN and a set of secondary VLANs to a promiscuous port.

Use the **no** variant of this to remove all the association of secondary VLANs to primary VLANs for a promiscuous port.

**Syntax** `switchport private-vlan mapping <primary-vlan-id> add <secondary-vid-list>`  
`switchport private-vlan mapping <primary-vlan-id> remove <secondary-vid-list>`  
`no switchport private-vlan mapping`

Parameter	Description
<code>&lt;primary-vlan-id&gt;</code>	VLAN ID of the primary VLAN.
<code>&lt;secondary-vid-list&gt;</code>	VLAN ID of the secondary VLAN (either isolated or community), or a range of VLANs, or a comma-separated list of VLANs and ranges.

**Mode** Interface Configuration

**Usage notes** This command can be applied to a switch port or a static channel group, but not a dynamic (LACP) channel group. LACP channel groups (dynamic/LACP aggregators) cannot be promiscuous ports in private VLANs.

**Examples** `awplus# configure terminal`  
`awplus(config)# interface port1.0.2`  
`awplus(config-if)# switchport private-vlan mapping 2 add 3-4`  
`awplus(config-if)# switchport private-vlan mapping 2 remove 3-4`  
`awplus(config-if)# no switchport private-vlan mapping`

**Related commands** [switchport mode private-vlan](#)

# switchport trunk allowed vlan

**Overview** Use this command to add VLANs to be trunked over this switch port. Traffic for these VLANs can be sent and received on the port.

Use the **no** variant of this command to reset switching characteristics of a specified interface to negate a trunked configuration specified with **switchport trunk allowed vlan** command.

**Syntax**

```
switchport trunk allowed vlan all
switchport trunk allowed vlan none
switchport trunk allowed vlan add <vid-list>
switchport trunk allowed vlan remove <vid-list>
switchport trunk allowed vlan except <vid-list>
no switchport trunk
```

Parameter	Description
all	Allow all VLANs to transmit and receive through the port.
none	Allow no VLANs to transmit and receive through the port.
add	Add a VLAN to the list of VLANs that are allowed to transmit and receive through the port. Only use this parameter if a list of VLANs is already configured on a port.
remove	Remove a VLAN from the list of VLANs that are allowed to transmit and receive through the port. Only use this parameter if a list of VLANs is already configured on a port. If you are removing VLAN port membership for a large number of switchports and VLANs, note that this command may take a number of minutes to run.
except	All VLANs, except the VLAN for which the VID is specified, are part of its port member set. Only use this parameter to remove VLANs after either this parameter or the <b>all</b> parameter have added VLANs to a port.
<vid-list>	<2-4094> The ID of the VLAN or VLANs that will be added to, or removed from, the port. A single VLAN, VLAN range, or comma-separated VLAN list can be set. For a VLAN range, specify two VLAN numbers: lowest, then highest number in the range, separated by a hyphen. For a VLAN list, specify the VLAN numbers separated by commas. Do not enter spaces between hyphens or commas when setting parameters for VLAN ranges or lists.

**Default** By default, ports are untagged members of the default VLAN (vlan1).

**Mode** Interface Configuration

**Usage notes** The **all** parameter sets the port to be a tagged member of all the VLANs configured on the device. The **none** parameter removes all VLANs from the port's tagged member set. The **add** and **remove** parameters will add and remove VLANs to and from the port's member set. The **except** parameter creates an exception to the list.

If you use the **all** parameter, and then you want to remove VLANs from the port's member list, you must use the **except** parameter to remove the unwanted VLANs. Similarly, if you use the **except** parameter to remove a list of VLANs, and you want to change that list, you must use the **except** parameter to make that change (not the **add** and **remove** parameters).

For example, if you want to remove VLAN3-5 from a port and the port's configuration is currently **switchport trunk allowed vlan all**, then you should remove VLAN3-5 by entering the **except** parameter, instead of using the **remove** parameter. This means using the following commands:

```
awplus# configure terminal
awplus(config)# interface port1.0.6
awplus(config-if)# switchport trunk allowed vlan except 3-5
```

If you do this, then the configuration changes to:

```
awplus#show running-config

interface port1.0.6
switchport
switchport mode trunk
switchport trunk allowed vlan except 3-5
```

For example, if you want to add VLAN4 back in again, and the port configuration is currently **switchport trunk allowed vlan except 3-5**, then you should add VLAN4 by re-entering the **except** parameter with the list of VLANs to remove, instead of using the **add** parameter. This means using the following commands:

```
awplus# configure terminal
awplus(config)# interface port1.0.5
awplus(config-if)# switchport trunk allowed vlan except 3,5
```

If you do this, then the configuration changes to:

```
awplus#show running-config

interface port1.0.5
switchport
switchport mode trunk
switchport trunk allowed vlan except 3,5
```



**Examples** The following shows adding a single VLAN to the port's member set.

```
awplus# configure terminal
awplus(config)# interface port1.0.2
awplus(config-if)# switchport trunk allowed vlan add 2
```

The following shows adding a range of VLANs to the port's member set.

```
awplus# configure terminal
awplus(config)# interface port1.0.2
awplus(config-if)# switchport trunk allowed vlan add 2-4
```

The following shows adding a list of VLANs to the port's member set.

```
awplus# configure terminal
awplus(config)# interface port1.0.2
awplus(config-if)# switchport trunk allowed vlan add 2,3,4
```

# switchport trunk native vlan

**Overview** Use this command to configure the native VLAN for this port. The native VLAN is used for classifying the incoming untagged packets. Use the **none** parameter with this command to remove the native VLAN from the port and set the acceptable frame types to vlan-tagged only.

Use the **no** variant of this command to revert the native VLAN to the default VLAN ID 1. Command negation removes tagged VLANs, and sets the native VLAN to the default VLAN.

**Syntax** `switchport trunk native vlan {<vid>|none}`  
`no switchport trunk native vlan`

Parameter	Description
<vid>	The ID of the VLAN that will be used to classify the incoming untagged packets, in the range 2-2094. The VLAN ID must be a part of the VLAN member set of the port.
none	No native VLAN specified. This option removes the native VLAN from the port and sets the acceptable frame types to vlan-tagged only. Note: Use the <b>no</b> variant of this command to revert to the default VLAN 1 as the native VLAN for the specified interface switchport - not <b>none</b> .

**Default** VLAN 1 (the default VLAN), which is reverted to using the **no** form of this command.

**Mode** Interface Configuration

**Examples** The following commands show configuration of VLAN 2 as the native VLAN for port1.0.2:

```
awplus# configure terminal
awplus(config)# interface port1.0.2
awplus(config-if)# switchport trunk native vlan 2
```

The following commands show the removal of the native VLAN for interface port1.0.2:

```
awplus# configure terminal
awplus(config)# interface port1.0.2
awplus(config-if)# switchport trunk native vlan none
```

The following commands revert the native VLAN to the default VLAN 1 for interface port1.0.2:

```
awplus# configure terminal
awplus(config)# interface port1.0.2
awplus(config-if)# no switchport trunk native vlan
```

# switchport voice dscp

**Overview** Use this command for a specific port to configure the Layer 3 DSCP value advertised when the transmission of LLDP-MED Network Policy TLVs for voice devices is enabled. When LLDP-MED capable IP phones receive this network policy information, they transmit voice data with the specified DSCP value.

Use the **no** variant of this command to reset the DSCP value to the default, 0.

**Syntax** `switchport voice dscp <0-63>`  
`no switchport voice dscp`

Parameter	Description
dscp	Specify a DSCP value for voice data.
<0-63>	DSCP value.

**Default** A DSCP value of 0 will be advertised.

**Mode** Interface Configuration

**Usage notes** LLDP-MED advertisements including Network Policy TLVs are transmitted via a port if:

- LLDP is enabled (`lldp run` command)
- Voice VLAN is configured for the port (`switchport voice vlan` command)
- The port is configured to transmit LLDP advertisements—enabled by default (`lldp transmit receive` command)
- The port is configured to transmit Network Policy TLVs—enabled by default (`lldp med-tlv-select` command)
- There is an LLDP-MED device connected to the port

**Example** To tell IP phones connected to port1.0.2 to send voice data with DSCP value 27, use the commands:

```
awplus# configure terminal
awplus(config)# interface port1.0.2
awplus(config-if)# switchport voice dscp 27
```

**Related commands** `lldp med-tlv-select`  
`show lldp`  
`switchport voice vlan`

# switchport voice vlan

**Overview** Use this command to configure the Voice VLAN tagging advertised when the transmission of LLDP-MED Network Policy TLVs for voice endpoint devices is enabled. When LLDP-MED capable IP phones receive this network policy information, they transmit voice data with the specified tagging. This command also sets the ports to be spanning tree edge ports, that is, it enables spanning tree portfast on the ports.

Use the **no** variant of this command to remove LLDP-MED network policy configuration for voice devices connected to these ports. This does not change the spanning tree edge port status.

**Syntax** `switchport voice vlan [<vid>|dot1p|dynamic|untagged]`  
`no switchport voice vlan`

Parameter	Description
dot1p	The IP phone should send User Priority tagged packets, that is, packets in which the tag contains a User Priority value, and a VID of 0. (The User Priority tag is also known as the 802.1p priority tag, or the Class of Service (CoS) tag.)
dynamic	The VLAN ID with which the IP phone should send tagged packets will be assigned by RADIUS authentication.
untagged	The IP phone should send untagged packets.

**Default** By default, no Voice VLAN is configured, and therefore no network policy is advertised for voice devices.

**Mode** Interface Configuration

**Usage notes** LLDP-MED advertisements including Network Policy TLVs are transmitted via a port if:

- LLDP is enabled (`lldp run` command)
- Voice VLAN is configured for the port using this command (`switchport voice vlan`)
- The port is configured to transmit LLDP advertisements—enabled by default (`lldp transmit receive` command)
- The port is configured to transmit Network Policy TLVs—enabled by default (`lldp med-tlv-select` command)
- There is an LLDP-MED device connected to the port.

To set the priority value to be advertised for tagged frames, use the `switchport voice vlan priority` command.

If the Voice VLAN details are to be assigned by RADIUS, then the RADIUS server must be configured to send the attribute “Egress-VLANID (56)” or

“Egress-VLAN-Name (58)” in the RADIUS Accept message when authenticating a phone attached to this port.

To set these attributes on the local RADIUS server, use the [egress-vlan-id](#) command or the [egress-vlan-name](#) command.

**Examples** To tell IP phones connected to port1.0.4 to send voice data tagged for VLAN 10, use the commands:

```
awplus# configure terminal
awplus(config)# interface port1.0.4
awplus(config-if)# switchport voice vlan 10
```

To tell IP phones connected to port1.0.2-port1.0.8 to send priority tagged packets (802.1p priority tagged with VID 0, so that they will be assigned to the port VLAN) use the following commands. The priority value is 5 by default, but can be configured with the [switchport voice vlan priority](#) command.

```
awplus# configure terminal
awplus(config)# interface port1.0.2-port1.0.8
awplus(config-if)# switchport voice vlan dot1p
```

To dynamically configure the VLAN ID advertised to IP phones connected to port1.0.1 based on the VLAN assigned by RADIUS authentication (with RADIUS attribute “Egress- VLANID” or “Egress-VLAN-Name” in the RADIUS accept packet), use the commands:

```
awplus# configure terminal
awplus(config)# interface port1.0.1
awplus(config-if)# switchport voice vlan dynamic
```

To remove the Voice VLAN, and therefore disable the transmission of LLDP-MED network policy information for voice devices on port1.0.8, use the following commands:

```
awplus# configure terminal
awplus(config)# interface port1.0.8
awplus(config-if)# no switchport voice vlan
```

**Related commands** [switchport voice dscp](#)  
[switchport voice vlan priority](#)

# switchport voice vlan priority

**Overview** Use this command to configure the Layer 2 user priority advertised when the transmission of LLDP-MED Network Policy TLVs for voice devices is enabled. This is the priority in the User Priority field of the IEEE 802.1Q VLAN tag, also known as the Class of Service (CoS), or 802.1p priority. When LLDP-MED capable IP phones receive this network policy information, they transmit voice data with the specified priority.

**Syntax** `switchport voice vlan priority <0-7>`  
`no switchport voice vlan priority`

Parameter	Description
<code>priority</code>	Specify a user priority value for voice data.
<code>&lt;0-7&gt;</code>	Priority value.

To remove the Voice VLAN, and therefore disable the transmission of LLDP-MED network policy information for voice devices on port1.0.6, use the following commands:

```
awplus# configure terminal
awplus(config)# interface port1.0.6
awplus(config-if)# no switchport voice vlan
```

# vlan

**Overview** This command creates VLANs, assigns names to them, and enables or disables them. Disabling the VLAN causes all forwarding over the specified VLAN ID to cease. Enabling the VLAN allows forwarding of frames on the specified VLAN.

You can create a management-only VLAN that contains only one member port and may be used as a remote management port. Management-only VLANs process packets in the CPU rather than in hardware. See the parameter table below for more detail.

If you need to control ingress and egress traffic to and from management interfaces, you can use software-based ACLs to filter traffic to and from a management-only VLAN.

The **no** variant of this command destroys the specified VLANs or returns their MTU to the default.

**Syntax**

```
vlan <vid> [name <vlan-name>] [state {enable|disable|management-only}]
vlan <vid-range> [state {enable|disable|management-only}]
vlan {<vid>|<vlan-name>} [mtu <mtu-value>]
no vlan {<vid>|<vid-range>} [mtu]
```

Parameter	Description
<vid>	The VID of the VLAN to enable or disable, in the range 1-4094.
<vlan-name>	The ASCII name of the VLAN. Maximum length: 32 characters.
<vid-range>	Specifies a range of VLAN identifiers.
<mtu-value>	Specifies the Maximum Transmission Unit (MTU) size in bytes, in the range 68 to 1500 bytes, for the VLAN.
enable	Puts the VLAN into an enabled state.
disable	Puts the VLAN into a disabled state.
management-only	Management-only VLANs are VLANs which: <ul style="list-style-type: none"> <li>• have one and only one access port (no aggregators, trunk port etc.)</li> <li>• do not route to/from other interfaces.</li> <li>• process packets in the CPU, rather than in hardware.</li> <li>• cannot be converted to a normal VLAN, nor can a normal VLAN be converted to a management-only VLAN. Delete and re-create the VLAN to convert a normal VLAN to/from a management-only VLAN.</li> </ul>

**Default** By default, VLANs are enabled when they are created.

**Mode** VLAN Configuration

**Examples** To enable VLAN 45, use the commands:

```
awplus# configure terminal
awplus(config)# vlan database
awplus(config-vlan)# vlan 45 name accounts state enable
```

To destroy VLAN 45, use the commands:

```
awplus# configure terminal
awplus(config)# vlan database
awplus(config-vlan)# no vlan 45
```

To create a management-only VLAN with VID 100, use the commands:

```
awplus# configure terminal
awplus(config)# vlan database
awplus(config-vlan)# vlan 100 state management-only
```

**Related commands**

- [mtu](#)
- [vlan database](#)
- [show vlan](#)

**Command changes** Version 5.4.9-2.1: Parameter **management-only** added



# vlan access-map

**Overview** Use this command to create a VLAN access-map and enter into VLAN access-map mode, so you can add ACLs to the map. You can use any IPv4 or IPv6 hardware ACLs. VLAN access-maps are used to attach ACLs to VLANs, and therefore to filter traffic as it ingresses VLANs.

See the [ACL Feature Overview and Configuration Guide](#) for more information, including information about the number of rules consumed by per-VLAN ACLs, and ACL processing order.

Use the **no** variant of this command to delete a VLAN access-map.

**Syntax** `vlan access-map <name>`  
`no vlan access-map <name>`

Parameter	Description
<name>	A name for the access-map.

**Default** By default, no VLAN access-maps exist.

**Mode** Global Configuration

**Example** To apply ACL 3001 to VLAN 48, where the ACL drops IP traffic from any source to any destination, use the commands:

```
awplus# configure terminal
awplus(config)# access-list 3001 deny ip any any
awplus(config)# vlan access-map deny_all
awplus(config-vlan-access-map)# match access-group 3001
awplus(config-vlan-access-map)# exit
awplus(config)# vlan filter deny_all vlan-list 48 input
```

**Related commands** [match access-group](#)  
[show vlan access-map](#)  
[vlan filter](#)

**Command changes** Version 5.4.6-2.1: command added

# vlan database

**Overview** Use this command to enter the VLAN Configuration mode.

**Syntax** `vlan database`

**Mode** Global Configuration

**Usage notes** Use this command to enter the VLAN configuration mode. You can then add or delete a VLAN, or modify its values.

**Example** In the following example, note the change to VLAN configuration mode from Configure mode:

```
awplus# configure terminal
awplus(config)# vlan database
awplus(config-vlan)#
```

**Related commands** [vlan](#)

# vlan filter

**Overview** Use this command to apply a VLAN access-map to a list of VLANs. The switch uses the ACLs in the access-map to filter traffic ingressing those VLANs.

See the [ACL Feature Overview and Configuration Guide](#) for more information, including information about the number of rules consumed by per-VLAN ACLs, and ACL processing order.

Use the **no** variant of this command to to remove the access-map filter from the listed VLANs.

**Syntax** `vlan filter <access-map-name> vlan-list <vid> input`  
`no vlan filter <access-map-name> vlan-list <vid> input`

Parameter	Description
<code>&lt;access-map-name&gt;</code>	The name of the VLAN access-map to apply to the specified list of VLANs
<code>vlan-list &lt;vid&gt;</code>	The list of VLANs to filter. You can specify a single VLAN (e.g. 49), a comma-separated list of VLANs (e.g. 49, 51), a hyphenated range of VLANs (e.g. 49-51), or a combination (e.g. 49,51-53)
<code>input</code>	Apply the filter to ingress traffic

**Default** By default, no VLAN filters exist.

**Mode** Global Configuration

**Example** To apply ACL 3001 to VLAN 48, where the ACL drops IP traffic from any source to any destination, use the commands:

```
awplus# configure terminal
awplus(config)# access-list 3001 deny ip any any
awplus(config)# vlan access-map deny_all
awplus(config-vlan-access-map)# match access-group 3001
awplus(config-vlan-access-map)# exit
awplus(config)# vlan filter deny_all vlan-list 48 input
```

**Related commands** [match access-group](#)  
[show vlan filter](#)  
[vlan access-map](#)

**Command changes** Version 5.4.6-2.1: command added

# 15

# Spanning Tree Commands

## Introduction

**Overview** This chapter provides an alphabetical reference for commands used to configure RSTP, STP or MSTP. For information about spanning trees, including configuration procedures, see the [STP Feature Overview and Configuration Guide](#).

- Command List**
- [“clear spanning-tree statistics”](#) on page 510
  - [“clear spanning-tree detected protocols \(RSTP and MSTP\)”](#) on page 511
  - [“debug mstp \(RSTP and STP\)”](#) on page 512
  - [“instance priority \(MSTP\)”](#) on page 516
  - [“instance vlan \(MSTP\)”](#) on page 518
  - [“region \(MSTP\)”](#) on page 520
  - [“revision \(MSTP\)”](#) on page 521
  - [“show debugging mstp”](#) on page 522
  - [“show spanning-tree”](#) on page 523
  - [“show spanning-tree brief”](#) on page 526
  - [“show spanning-tree mst”](#) on page 527
  - [“show spanning-tree mst config”](#) on page 528
  - [“show spanning-tree mst detail”](#) on page 529
  - [“show spanning-tree mst detail interface”](#) on page 531
  - [“show spanning-tree mst instance”](#) on page 533
  - [“show spanning-tree mst instance interface”](#) on page 534
  - [“show spanning-tree mst interface”](#) on page 535
  - [“show spanning-tree statistics”](#) on page 536
  - [“show spanning-tree statistics instance”](#) on page 538

- [“show spanning-tree statistics instance interface”](#) on page 539
- [“show spanning-tree statistics interface”](#) on page 541
- [“show spanning-tree vlan range-index”](#) on page 543
- [“spanning-tree autoedge \(RSTP and MSTP\)”](#) on page 544
- [“spanning-tree bpdu”](#) on page 545
- [“spanning-tree cisco-interoperability \(MSTP\)”](#) on page 547
- [“spanning-tree edgeport \(RSTP and MSTP\)”](#) on page 548
- [“spanning-tree enable”](#) on page 549
- [“spanning-tree errdisable-timeout enable”](#) on page 551
- [“spanning-tree errdisable-timeout interval”](#) on page 552
- [“spanning-tree force-version”](#) on page 553
- [“spanning-tree forward-time”](#) on page 554
- [“spanning-tree guard root”](#) on page 555
- [“spanning-tree hello-time”](#) on page 556
- [“spanning-tree link-type”](#) on page 557
- [“spanning-tree max-age”](#) on page 558
- [“spanning-tree max-hops \(MSTP\)”](#) on page 559
- [“spanning-tree mode”](#) on page 560
- [“spanning-tree mst configuration”](#) on page 561
- [“spanning-tree mst instance”](#) on page 562
- [“spanning-tree mst instance path-cost”](#) on page 563
- [“spanning-tree mst instance priority”](#) on page 565
- [“spanning-tree mst instance restricted-role”](#) on page 566
- [“spanning-tree mst instance restricted-tcn”](#) on page 568
- [“spanning-tree path-cost”](#) on page 569
- [“spanning-tree portfast \(STP\)”](#) on page 570
- [“spanning-tree portfast bpdu-filter”](#) on page 572
- [“spanning-tree portfast bpdu-guard”](#) on page 574
- [“spanning-tree priority \(bridge priority\)”](#) on page 576
- [“spanning-tree priority \(port priority\)”](#) on page 577
- [“spanning-tree restricted-role”](#) on page 578
- [“spanning-tree restricted-tcn”](#) on page 579
- [“spanning-tree transmit-holdcount”](#) on page 580
- [“undebg mstp”](#) on page 581

# clear spanning-tree statistics

**Overview** Use this command to clear all the STP BPDU (Bridge Protocol Data Unit) statistics.

**Syntax** `clear spanning-tree statistics`  
`clear spanning-tree statistics [instance <mstp-instance>]`  
`clear spanning-tree statistics [interface <port> [instance <mstp-instance>]]`

Parameter	Description
<port>	The port to clear STP BPDU statistics for. The port may be a switch port (e.g. port1.0.4), a static channel group (e.g. sa2), or a dynamic (LACP) channel group (e.g. po2).
<mstp-instance>	The MSTP instance (MSTI - Multiple Spanning Tree Instance) to clear MSTP BPDU statistics.

**Mode** User Exec and Privileged Exec

**Usage notes** Use this command with the **instance** parameter in MSTP mode. Specifying this command with the **interface** parameter only not the instance parameter will work in STP and RSTP mode.

**Examples** `awplus# clear spanning-tree statistics`  
`awplus# clear spanning-tree statistics instance 1`  
`awplus# clear spanning-tree statistics interface port1.0.2`  
`awplus# clear spanning-tree statistics interface port1.0.2 instance 1`

# clear spanning-tree detected protocols (RSTP and MSTP)

**Overview** Use this command to clear the detected protocols for a specific port, or all ports. Use this command in RSTP or MSTP mode only.

**Syntax** `clear spanning-tree detected protocols [interface <port>]`

Parameter	Description
<code>&lt;port&gt;</code>	The port to clear detected protocols for. The port may be a switch port (e.g. <code>port1.0.4</code> ), a static channel group (e.g. <code>sa2</code> ), or a dynamic (LACP) channel group (e.g. <code>po2</code> ).

**Mode** Privileged Exec

**Example** `awplus# clear spanning-tree detected protocols`

# debug mstp (RSTP and STP)

**Overview** Use this command to enable debugging for the configured spanning tree mode, and echo data to the console, at various levels. Note that although this command uses the keyword **mstp** it displays debugging output for RSTP and STP protocols as well the MSTP protocol.

Use the **no** variant of this command to disable spanning tree debugging.

**Syntax**

```
debug mstp {all|cli|protocol [detail]|timer [detail]}
debug mstp {packet {rx|tx} [decode] [interface <interface>]}
debug mstp {topology-change [interface <interface>]}
no debug mstp {all|cli|protocol [detail]|timer [detail]}
no debug mstp {packet {rx|tx} [decode] [interface <interface>]}
no debug mstp {topology-change [interface <interface>]}
```

Parameter	Description
all	Echoes all spanning tree debugging levels to the console.
cli	Echoes spanning tree commands to the console.
packet	Echoes spanning tree packets to the console.
rx	Received packets.
tx	Transmitted packets.
protocol	Echoes protocol changes to the console.
timer	Echoes timer information to the console.
detail	Detailed output.
decode	Interprets packet contents
topology-change	Interprets topology change messages
interface	Keyword before <interface> placeholder to specify an interface to debug
<interface>	Placeholder used to specify the name of the interface to debug.

**Mode** Privileged Exec and Global Configuration mode

**Usage 1** Use the **debug mstp topology-change interface** command to generate debugging messages when the device receives an indication of a topology change in a BPDU from another device. The debugging can be activated on a per-port basis. Although this command uses the keyword **mstp**, it displays debugging output for RSTP and STP protocols as well as the MSTP protocol.

Due to the likely volume of output, these debug messages are best viewed using the [terminal monitor](#) command before issuing the relevant **debug mstp**



command. The default terminal monitor filter will select and display these messages. Alternatively, the messages can be directed to any of the other log outputs by adding a filter for the MSTP application using [log buffered \(filter\)](#) command:

```
awplus# configure terminal
awplus(config)# log buffered program mstp
```

### Output 1

```
awplus#terminal monitor
awplus#debug mstp topology-change interface port1.0.4
10:09:09 awplus MSTP[1409]: Topology change rcvd on port1.0.4 (internal)
10:09:09 awplus MSTP[1409]: Topology change rcvd on MSTI 1 port1.0.4
awplus#debug mstp topology-change interface port1.0.6
10:09:29 awplus MSTP[1409]: Topology change rcvd on port1.0.6 (external)
10:09:29 awplus MSTP[1409]: Topology change rcvd on MSTI 1 port1.0.6
```

**Usage 2** Use the **debug mstp packet rx|tx decode interface** command to generate debugging messages containing the entire contents of a BPDU displayed in readable text for transmitted and received xSTP BPDUs. The debugging can be activated on a per-port basis and transmit and receive debugging is controlled independently. Although this command uses the keyword **mstp**, it displays debugging output for RSTP and STP protocols as well as the MSTP protocol.

Due to the likely volume of output, these debug messages are best viewed using the [terminal monitor](#) command before issuing the relevant **debug mstp** command. The default terminal monitor filter will select and display these messages. Alternatively, the messages can be directed to any of the other log outputs by adding a filter for the MSTP application using the [log buffered \(filter\)](#) command:

```
awplus(config)# log buffered program mstp
```

**Output 2** In MSTP mode - an MSTP BPDU with 1 MSTI:

```
awplus#terminal monitor
awplus#debug mstp packet rx decode interface port1.0.4
17:23:42 awplus MSTP[1417]: port1.0.4 xSTP BPDU rx - start
17:23:42 awplus MSTP[1417]: Protocol version: MSTP, BPDU type: RST
17:23:42 awplus MSTP[1417]: CIST Flags: Agree Forward Learn role=Desig
17:23:42 awplus MSTP[1417]: CIST root id      : 0000:0000cd1000fe
17:23:42 awplus MSTP[1417]: CIST ext pathcost : 0
17:23:42 awplus MSTP[1417]: CIST reg root id  : 0000:0000cd1000fe
17:23:42 awplus MSTP[1417]: CIST port id     : 8001 (128:1)
17:23:42 awplus MSTP[1417]: msg age: 0 max age: 20 hellotime: 2 fwd delay: 15
17:23:42 awplus MSTP[1417]: Version 3 length : 80
17:23:42 awplus MSTP[1417]: Format id       : 0
17:23:42 awplus MSTP[1417]: Config name    : test
17:23:42 awplus MSTP[1417]: Revision level : 0
17:23:42 awplus MSTP[1417]: Config digest  : 3ab68794d602fdf43b21c0b37ac3bca8
17:23:42 awplus MSTP[1417]: CIST int pathcost : 0
17:23:42 awplus MSTP[1417]: CIST bridge id   : 0000:0000cd1000fe
17:23:42 awplus MSTP[1417]: CIST hops remaining : 20
17:23:42 awplus MSTP[1417]: MSTI flags      : Agree Forward Learn role=Desig
17:23:42 awplus MSTP[1417]: MSTI reg root id  : 8001:0000cd1000fe
17:23:42 awplus MSTP[1417]: MSTI pathcost   : 0
17:23:42 awplus MSTP[1417]: MSTI bridge priority : 32768 port priority : 128
17:23:42 awplus MSTP[1417]: MSTI hops remaining : 20
17:23:42 awplus MSTP[1417]: port1.0.4 xSTP BPDU rx - finish
```

In STP mode transmitting a TCN BPDU:

```
awplus#terminal monitor
awplus#debug mstp packet tx decode interface port1.0.4
17:28:09 awplus MSTP[1417]: port1.0.4 xSTP BPDU tx - start
17:28:09 awplus MSTP[1417]: Protocol version: STP, BPDU type: TCN
17:28:09 awplus MSTP[1417]: port1.0.4 xSTP BPDU tx - finish
```

In STP mode receiving an STP BPDU:

```
awplus#terminal monitor
awplus#debug mstp packet rx decode interface port1.0.4
17:31:36 awplus MSTP[1417]: port1.0.4 xSTP BPDU rx - start
17:31:36 awplus MSTP[1417]: Protocol version: STP, BPDU type: Config
17:31:36 awplus MSTP[1417]: Flags: role=none
17:31:36 awplus MSTP[1417]: Root id       : 8000:0000cd1000fe
17:31:36 awplus MSTP[1417]: Root pathcost : 0
17:31:36 awplus MSTP[1417]: Bridge id    : 8000:0000cd1000fe
17:31:36 awplus MSTP[1417]: Port id     : 8001 (128:1)
17:31:36 awplus MSTP[1417]: msg age: 0 max age: 20 hellotime: 2 fwd delay: 15
17:31:36 awplus MSTP[1417]: port1.0.4 xSTP BPDU rx - finish
```

In RSTP mode receiving an RSTP BPDU:

```
awplus#terminal monitor
awplus#debug mstp packet rx decode interface port1.0.4
awplus#17:30:17 awplus MSTP[1417]: port1.0.4 xSTP BPDU rx - start
17:30:17 awplus MSTP[1417]: Protocol version: RSTP, BPDU type: RST
17:30:17 awplus MSTP[1417]: CIST Flags: Forward Learn role=Desig
17:30:17 awplus MSTP[1417]: CIST root id      : 8000:0000cd1000fe
17:30:17 awplus MSTP[1417]: CIST ext pathcost : 0
17:30:17 awplus MSTP[1417]: CIST reg root id  : 8000:0000cd1000fe
17:30:17 awplus MSTP[1417]: CIST port id     : 8001 (128:1)
17:30:17 awplus MSTP[1417]: msg age: 0 max age: 20 hellotime: 2 fwd delay: 15
17:30:17 awplus MSTP[1417]: port1.0.4 xSTP BPDU rx - finish
```

**Examples**

```
awplus# debug mstp all
awplus# debug mstp cli
awplus# debug mstp packet rx
awplus# debug mstp protocol detail
awplus# debug mstp timer
awplus# debug mstp packet rx decode interface port1.0.2
awplus# debug mstp packet tx decode interface port1.0.6
```

**Related commands**

- [log buffered \(filter\)](#)
- [show debugging mstp](#)
- [terminal monitor](#)
- [undebug mstp](#)

# instance priority (MSTP)

**Overview** Use this command to set the priority for this device to become the root bridge for the specified MSTI (Multiple Spanning Tree Instance).

Use this command for MSTP only.

Use the **no** variant of this command to restore the root bridge priority of the device for the instance to the default.

**Syntax** `instance <instance-id> priority <priority>`  
`no instance <instance-id> priority`

Parameter	Description
<code>&lt;instance-id&gt;</code>	Specify an MSTP instance in the range 1-15.
<code>&lt;priority&gt;</code>	Specify the root bridge priority for the device for the MSTI in the range <0-61440>. Note that a lower priority number indicates a greater likelihood of the device becoming the root bridge. The priority values can be set only in increments of 4096. If you specify a number that is not a multiple of 4096, it will be rounded down. The default priority is 32768.

**Default** The default priority value for all instances is 32768.

**Mode** MST Configuration

**Usage notes** MSTP lets you distribute traffic more efficiently across a network by blocking different links for different VLANs. You do this by making different devices into the root bridge for each MSTP instance, so that each instance blocks a different link.

If all devices have the same root bridge priority for the instance, MSTP selects the device with the lowest MAC address to be the root bridge. Give the device a higher priority for becoming the root bridge for a particular instance by assigning it a lower priority number, or vice versa.

**Examples** To set the root bridge priority for MSTP instance 2 to be the highest (0), so that it will be the root bridge for this instance when available, use the commands:

```
awplus# configure terminal
awplus(config)# spanning-tree mst configuration
awplus(config-mst)# instance 2 priority 0
```

To reset the root bridge priority for instance 2 to the default (32768), use the commands:

```
awplus# configure terminal
awplus(config)# spanning-tree mst configuration
awplus(config-mst)# no instance 2 priority
```

**Related commands**

- region (MSTP)
- revision (MSTP)
- show spanning-tree mst config
- spanning-tree mst instance
- spanning-tree mst instance priority

# instance vlan (MSTP)

**Overview** Use this command to create an MST Instance (MSTI), and associate the specified VLANs with it. An MSTI is a spanning tree instance that exists within an MST region (MSTR).

When a VLAN is associated with an MSTI the member ports of the VLAN are automatically configured to send and receive spanning-tree information for the associated MSTI. You can disable this automatic configuration of member ports of the VLAN to the associated MSTI by using a **no spanning-tree mst instance** command to remove the member port from the MSTI.

Use the **instance vlan** command for MSTP only.

Use the **no** variant of this command to remove the specified VLANs from the MSTI.

**Syntax** `instance <instance-id> vlan <vid-list>`  
`no instance <instance-id> vlan <vid-list>`

Parameter	Description
<code>&lt;instance-id&gt;</code>	Specify an MSTP instance in the range 1-15.
<code>&lt;vid-list&gt;</code>	Specify one or more VLAN identifiers (VID) to be associated with the MSTI specified. This can be a single VID in the range 1-4094, or a hyphen-separated range or a comma-separated list of VLAN IDs.

**Mode** MST Configuration

**Usage notes** The VLANs must be created before being associated with an MST instance (MSTI). If the VLAN range is not specified, the MSTI will not be created.

This command removes the specified VLANs from the CIST and adds them to the specified MSTI. If you use the **no** variant of this command to remove the VLAN from the MSTI, it returns it to the CIST. To move a VLAN from one MSTI to another, you must first use the **no** variant of this command to return it to the CIST.

Ports in these VLANs will remain in the control of the CIST until you associate the ports with the MSTI using the [spanning-tree mst instance](#) command.

**Example** To associate VLAN 30 with MSTI 2, use the commands:

```
awplus# configure terminal
awplus(config)# spanning-tree mode mstp
awplus(config)# spanning-tree mst configuration
awplus(config-mst)# instance 2 vlan 30
```

**Related commands**

- region (MSTP)
- revision (MSTP)
- show spanning-tree mst config
- spanning-tree mst instance
- vlan

# region (MSTP)

**Overview** Use this command to assign a name to the device's MST Region. MST Instances (MSTI) of a region form different spanning trees for different VLANs.

Use this command for MSTP only.

Use the **no** variant of this command to remove this region name and reset it to the default.

**Syntax** `region <region-name>`  
`no region`

Parameter	Description
<code>&lt;region-name&gt;</code>	Specify the name of the region, up to 32 characters. Valid characters are upper-case, lower-case, digits, underscore.

**Default** By default, the region name is My Name.

**Mode** MST Configuration

**Usage** The region name, the revision number, and the digest of the VLAN to MSTI configuration table must be the same on all devices that are intended to be in the same MST region.

**Example**

```
awplus# configure terminal
awplus(config)# spanning-tree mst configuration
awplus(config-mst)# region ATL
```

**Related commands** [revision \(MSTP\)](#)  
[show spanning-tree mst config](#)



# revision (MSTP)

**Overview** Use this command to specify the MST revision number to be used in the configuration identifier.

Use this command for MSTP only.

**Syntax** `revision <revision-number>`

Parameter	Description
<code>&lt;revision-number&gt;</code>	<code>&lt;0-65535&gt;</code> Revision number.

**Default** The default of revision number is 0.

**Mode** MST Configuration

**Usage** The region name, the revision number, and the digest of the VLAN to MSTI configuration table must be the same on all devices that are intended to be in the same MST region.

**Example**

```
awplus# configure terminal
awplus(config)# spanning-tree mst configuration
awplus(config-mst)# revision 25
```

**Related commands**

- [region \(MSTP\)](#)
- [show spanning-tree mst config](#)
- [instance vlan \(MSTP\)](#)

# show debugging mstp

**Overview** Use this command to see what debugging is turned on for MSTP.  
For information on filtering and saving command output, see the [“Getting Started with AlliedWare Plus” Feature Overview and Configuration Guide](#).

**Syntax** `show debugging mstp`

**Mode** User Exec and Privileged Exec

**Example** To display the MSTP debugging options set, enter the command:

```
awplus# show debugging mstp
```

**Output** Figure 15-1: Example output from **show debugging mstp**

```
MSTP debugging status:  
MSTP receiving packet debugging is on
```

**Related commands** [debug mstp \(RSTP and STP\)](#)

# show spanning-tree

**Overview** Use this command to display detailed spanning tree information on the specified port or on all ports. Use this command for RSTP, MSTP or STP.

For information on filtering and saving command output, see the [“Getting Started with AlliedWare Plus” Feature Overview and Configuration Guide](#).

**Syntax** `show spanning-tree [interface <port-list>]`

Parameter	Description
<code>interface</code>	Display information about the following port only.
<code>&lt;port-list&gt;</code>	The ports to display information about. A port-list can be: <ul style="list-style-type: none"><li>• a switch port (e.g. port1.0.6) a static channel group (e.g. sa2) or a dynamic (LACP) channel group (e.g. po2)</li><li>• a continuous range of ports separated by a hyphen, e.g. port1.0.1-1.0.4, or sa1-2, or po1-2</li><li>• a comma-separated list of ports and port ranges, e.g. port1.0.1,port1.0.4-1.0.6. Do not mix switch ports, static channel groups, and dynamic (LACP) channel groups in the same list</li></ul>

**Mode** User Exec and Privileged Exec

**Usage notes** Note that any list of interfaces specified must not span any interfaces that are not installed.

A topology change counter has been included for RSTP and MSTP. You can see the topology change counter for RSTP by using the **show spanning-tree** command. You can see the topology change counter for MSTP by using the **show spanning-tree mst instance** command.

**Example** To display spanning tree information about port1.0.3, use the command:

```
awplus# show spanning-tree interface port1.0.3
```

**Output** Figure 15-2: Example output from **show spanning-tree** in RSTP mode

```
awplus#show spanning-tree
% 1: Bridge up - Spanning Tree Enabled
% 1: Root Path Cost 0 - Root Port 0 - Bridge Priority 32768
% 1: Forward Delay 15 - Hello Time 2 - Max Age 20
% 1: Root Id 80000000cd24ff2d
% 1: Bridge Id 80000000cd24ff2d
% 1: last topology change Mon Oct 3 02:06:26 2016
% 1: portfast bpdu-filter disabled
% 1: portfast bpdu-guard disabled
% 1: portfast errdisable timeout disabled
% 1: portfast errdisable timeout interval 300 sec
% port1.0.1: Port 5001 - Id 8389 - Role Disabled - State Discarding
% port1.0.1: Designated Path Cost 0
% port1.0.1: Configured Path Cost 20000000 - Add type Explicit ref count 1
% port1.0.1: Designated Port Id 8389 - Priority 128 -
% port1.0.1: Root 80000000cd24ff2d
% port1.0.1: Designated Bridge 80000000cd24ff2d
% port1.0.1: Message Age 0 - Max Age 20
% port1.0.1: Hello Time 2 - Forward Delay 15
% port1.0.1: Forward Timer 0 - Msg Age Timer 0 - Hello Timer 0 - topo change
timer 0
% port1.0.1: forward-transitions 0
% port1.0.1: Version Rapid Spanning Tree Protocol - Received None - Send STP
% port1.0.1: No portfast configured - Current portfast off
% port1.0.1: portfast bpdu-guard default - Current portfast bpdu-guard off
% port1.0.1: portfast bpdu-filter default - Current portfast bpdu-filter off
% port1.0.1: no root guard configured - Current root guard off
% port1.0.1: Configured Link Type point-to-point - Current shared
%
% port1.0.2: Port 5002 - Id 838a - Role Disabled - State Discarding
% port1.0.2: Designated Path Cost 0
% port1.0.2: Configured Path Cost 20000000 - Add type Explicit ref count 1
% port1.0.2: Designated Port Id 838a - Priority 128 -
% port1.0.2: Root 80000000cd24ff2d
% port1.0.2: Designated Bridge 80000000cd24ff2d
% port1.0.2: Message Age 0 - Max Age 20
% port1.0.2: Hello Time 2 - Forward Delay 15
% port1.0.2: Forward Timer 0 - Msg Age Timer 0 - Hello Timer 0 - topo change
timer 0
% port1.0.2: forward-transitions 0
% port1.0.2: Version Rapid Spanning Tree Protocol - Received None - Send STP
% port1.0.2: No portfast configured - Current portfast off
% port1.0.2: portfast bpdu-guard default - Current portfast bpdu-guard off
% port1.0.2: portfast bpdu-filter default - Current portfast bpdu-filter off
% port1.0.2: no root guard configured - Current root guard off
% port1.0.2: Configured Link Type point-to-point - Current shared
```

**Output** Figure 15-3: Example output from **show spanning-tree**

```
% 1: Bridge up - Spanning Tree Enabled
% 1: Root Path Cost 0 - Root Port 0 - Bridge Priority 32768
% 1: Forward Delay 15 - Hello Time 2 - Max Age 20
% 1: Root Id 80000000cd20f093
% 1: Bridge Id 80000000cd20f093
% 1: last topology change Mon Oct 3 02:06:26 2016
% 1: portfast bpdu-filter disabled
% 1: portfast bpdu-guard disabled
% 1: portfast errdisable timeout disabled
% 1: portfast errdisable timeout interval 300 sec
% port1.0.3: Port 5023 - Id 839f - Role Designated - State Forwarding
% port1.0.3: Designated Path Cost 0
% port1.0.3: Configured Path Cost 200000 - Add type Explicit ref count 1
% port1.0.3: Designated Port Id 839f - Priority 128 -
% port1.0.3: Root 80000000cd20f093
% port1.0.3: Designated Bridge 80000000cd20f093
% port1.0.3: Message Age 0 - Max Age 20
% port1.0.3: Hello Time 2 - Forward Delay 15
% port1.0.3: Forward Timer 0 - Msg Age Timer 0 - Hello Timer 1 - topo change
timer 0
% port1.0.3: forward-transitions 32
% port1.0.3: Version Rapid Spanning Tree Protocol - Received None - Send RSTP
% port1.0.3: No portfast configured - Current portfast off
% port1.0.3: portfast bpdu-guard default - Current portfast bpdu-guard off
% port1.0.3: portfast bpdu-filter default - Current portfast bpdu-filter off
% port1.0.3: no root guard configured - Current root guard off
% port1.0.3: Configured Link Type point-to-point - Current point-to-point
...
```

# show spanning-tree brief

**Overview** Use this command to display a summary of spanning tree status information on all ports. Use this command for RSTP, MSTP or STP.

**Syntax** `show spanning-tree brief`

Parameter	Description
brief	A brief summary of spanning tree information.

**Mode** User Exec and Privileged Exec

**Usage notes** Note that any list of interfaces specified must not span any interfaces that are not installed.

A topology change counter has been included for RSTP and MSTP. You can see the topology change counter for RSTP by using the **show spanning-tree** command. You can see the topology change counter for MSTP by using the **show spanning-tree mst instance** command.

**Example** To display a summary of spanning tree status information, use the command:

```
awplus# show spanning-tree brief
```

**Output** Figure 15-4: Example output from **show spanning-tree brief**

```
Default: Bridge up - Spanning Tree Enabled
Default: Root Path Cost 40000 - Root Port 4501 - Bridge Priority 32768
Default: Root Id 8000:0000cd250001
Default: Bridge Id 8000:0000cd296eb1

Port          Designated Bridge  Port Id  Role          State
sa1           8000:001577c9744b  8195    Rootport     Forwarding
po1           8000:0000cd296eb1  81f9    Designated   Forwarding
port1.0.1     8000:0000cd296eb1  8389    Disabled     Discarding
port1.0.2     8000:0000cd296eb1  838a    Disabled     Discarding
port1.0.3     8000:0000cd296eb1  838b    Disabled     Discarding
...
```

**Related commands** [show spanning-tree](#)

# show spanning-tree mst

**Overview** This command displays bridge-level information about the CIST and VLAN to MSTI mappings.

For information on filtering and saving command output, see the [“Getting Started with AlliedWare Plus” Feature Overview and Configuration Guide](#).

**Syntax** show spanning-tree mst

**Mode** User Exec, Privileged Exec and Interface Configuration

**Example** To display bridge-level information about the CIST and VLAN to MSTI mappings, enter the command:

```
awplus# show spanning-tree mst
```

**Output** Figure 15-5: Example output from **show spanning-tree mst**

```
% 1: Bridge up - Spanning Tree Enabled
% 1: CIST Root Path Cost 0 - CIST Root Port 0 - CIST Bridge
Priority 32768
% 1: Forward Delay 15 - Hello Time 2 - Max Age 20 - Max-hops 20
% 1: CIST Root Id 8000000475e93ffe
% 1: CIST Reg Root Id 8000000475e93ffe
% 1: CST Bridge Id 8000000475e93ffe
% 1: portfast bpdu-filter disabled
% 1: portfast bpdu-guard disabled
% 1: portfast errdisable timeout disabled
% 1: portfast errdisable timeout interval 300 sec
%
% Instance      VLAN
% 0:            1
% 2:            4
```

**Related commands** [show spanning-tree mst interface](#)

# show spanning-tree mst config

**Overview** Use this command to display MSTP configuration identifier for the device.

**Syntax** show spanning-tree mst config

**Mode** User Exec, Privileged Exec and Interface Configuration

**Usage notes** The region name, the revision number, and the digest of the VLAN to MSTI configuration table must be the same on all devices that are intended to be in the same MST region.

**Example** To display MSTP configuration identifier information, enter the command:

```
awplus# show spanning-tree mst config
```

**Output** Figure 15-6: Example output from **show spanning-tree mst config**

```
awplus#show spanning-tree mst config
%
% MSTP Configuration Information:
%-----
% Format Id      : 0
% Name          : My Name
% Revision Level : 0
% Digest        : 0x80DEE46DA92A98CF21C603291B22880A
%-----
%
```

**Related commands**

- [instance vlan \(MSTP\)](#)
- [region \(MSTP\)](#)
- [revision \(MSTP\)](#)



# show spanning-tree mst detail

**Overview** This command displays detailed information about each instance, and all interfaces associated with that particular instance.

For information on filtering and saving command output, see the [“Getting Started with AlliedWare Plus” Feature Overview and Configuration Guide](#).

**Syntax** show spanning-tree mst detail

**Mode** User Exec, Privileged Exec and Interface Configuration

**Example** To display detailed information about each instance, and all interfaces associated with them, enter the command:

```
awplus# show spanning-tree mst detail
```

**Output** Figure 15-7: Example output from **show spanning-tree mst detail**

```
% 1: Bridge up - Spanning Tree Enabled
% 1: CIST Root Path Cost 0 - CIST Root Port 0 - CIST Bridge Priority 32768
% 1: Forward Delay 15 - Hello Time 2 - Max Age 20 - Max-hops 20
% 1: CIST Root Id 80000000cd24ff2d
% 1: CIST Reg Root Id 80000000cd24ff2d
% 1: CIST Bridge Id 80000000cd24ff2d
% 1: portfast bpdu-filter disabled
% 1: portfast bpdu-guard disabled
% 1: portfast errdisable timeout disabled
% 1: portfast errdisable timeout interval 300 sec
% port1.0.1: Port 5001 - Id 8389 - Role Disabled - State Discarding
% port1.0.1: Designated External Path Cost 0 -Internal Path Cost 0
% port1.0.1: Configured Path Cost 20000000 - Add type Explicit ref count 1
% port1.0.1: Designated Port Id 8389 - CIST Priority 128 -
% port1.0.1: CIST Root 80000000cd24ff2d
% port1.0.1: Regional Root 80000000cd24ff2d
% port1.0.1: Designated Bridge 80000000cd24ff2d
% port1.0.1: Message Age 0 - Max Age 20
% port1.0.1: CIST Hello Time 2 - Forward Delay 15
% port1.0.1: CIST Forward Timer 0 - Msg Age Timer 0 - Hello Timer 0 - topo
change timer 0
...
% port1.0.2: forward-transitions 0
% port1.0.2: Version Multiple Spanning Tree Protocol - Received None - Send STP
% port1.0.2: No portfast configured - Current portfast off
% port1.0.2: portfast bpdu-guard default - Current portfast bpdu-guard off
% port1.0.2: portfast bpdu-filter default - Current portfast bpdu-filter off
% port1.0.2: no root guard configured - Current root guard off
% port1.0.2: Configured Link Type point-to-point - Current shared
%
```

```
% port1.0.3: Port 5003 - Id 838b - Role Disabled - State Discarding
% port1.0.3: Designated External Path Cost 0 -Internal Path Cost 0
% port1.0.3: Configured Path Cost 20000000 - Add type Explicit ref count 1
% port1.0.3: Designated Port Id 838b - CIST Priority 128 -
% port1.0.3: CIST Root 80000000cd24ff2d
% port1.0.3: Regional Root 80000000cd24ff2d
% port1.0.3: Designated Bridge 80000000cd24ff2d
% port1.0.3: Message Age 0 - Max Age 20
% port1.0.3: CIST Hello Time 2 - Forward Delay 15
% port1.0.3: CIST Forward Timer 0 - Msg Age Timer 0 - Hello Timer 0 - topo
change timer 0
% port1.0.3: forward-transitions 0
% port1.0.3: Version Multiple Spanning Tree Protocol - Received None - Send STP
% port1.0.3: No portfast configured - Current portfast off
% port1.0.3: portfast bpdu-guard default - Current portfast bpdu-guard off
% port1.0.3: portfast bpdu-filter default - Current portfast bpdu-filter off
% port1.0.3: no root guard configured - Current root guard off
% port1.0.3: Configured Link Type point-to-point - Current shared
```

# show spanning-tree mst detail interface

**Overview** This command displays detailed information about the specified switch port, and the MST instances associated with it.

For information on filtering and saving command output, see the [“Getting Started with AlliedWare Plus” Feature Overview and Configuration Guide](#).

**Syntax** `show spanning-tree mst detail interface <port>`

Parameter	Description
<port>	The port to display information about. The port may be a switch port (e.g. port1.0.4), a static channel group (e.g. sa2), or a dynamic (LACP) channel group (e.g. po2).

**Mode** User Exec, Privileged Exec and Interface Configuration

**Example** To display detailed information about port1.0.3 and the instances associated with it, enter the command:

```
awplus# show spanning-tree mst detail interface port1.0.3
```

**Output** Figure 15-8: Example output from **show spanning-tree mst detail interface**

```
% 1: Bridge up - Spanning Tree Enabled
% 1: CIST Root Path Cost 0 - CIST Root Port 0 - CIST Bridge Priority 32768
% 1: Forward Delay 15 - Hello Time 2 - Max Age 20 - Max-hops 20
% 1: CIST Root Id 80000000cd24ff2d
% 1: CIST Reg Root Id 80000000cd24ff2d
% 1: CIST Bridge Id 80000000cd24ff2d
% 1: portfast bpdu-filter disabled
% 1: portfast bpdu-guard disabled
% 1: portfast errdisable timeout disabled
% 1: portfast errdisable timeout interval 300 sec
% port1.0.2: Port 5002 - Id 838a - Role Disabled - State Discarding
% port1.0.2: Designated External Path Cost 0 -Internal Path Cost 0
% port1.0.2: Configured Path Cost 20000000 - Add type Explicit ref count 2
% port1.0.2: Designated Port Id 838a - CIST Priority 128 -
% port1.0.2: CIST Root 80000000cd24ff2d
% port1.0.2: Regional Root 80000000cd24ff2d
% port1.0.2: Designated Bridge 80000000cd24ff2d
% port1.0.2: Message Age 0 - Max Age 20
% port1.0.2: CIST Hello Time 2 - Forward Delay 15
% port1.0.2: CIST Forward Timer 0 - Msg Age Timer 0 - Hello Timer 0 - topo
change timer 0
% port1.0.2: forward-transitions 0
% port1.0.2: Version Multiple Spanning Tree Protocol - Received None - Send STP
```

```
% port1.0.2: No portfast configured - Current portfast off
% port1.0.2: portfast bpdu-guard default - Current portfast bpdu-guard off
% port1.0.2: portfast bpdu-filter default - Current portfast bpdu-filter off
% port1.0.2: no root guard configured - Current root guard off
% port1.0.2: Configured Link Type point-to-point - Current shared
%
% Instance 2: Vlans: 2
% 1: MSTI Root Path Cost 0 -MSTI Root Port 0 - MSTI Bridge Priority 32768
% 1: MSTI Root Id 80020000cd24ff2d
% 1: MSTI Bridge Id 80020000cd24ff2d
% port1.0.2: Port 5002 - Id 838a - Role Disabled - State Discarding
% port1.0.2: Designated Internal Path Cost 0 - Designated Port Id 838a
% port1.0.2: Configured Internal Path Cost 20000000
% port1.0.2: Configured CST External Path cost 20000000
% port1.0.2: CST Priority 128 - MSTI Priority 128
% port1.0.2: Designated Root 80020000cd24ff2d
% port1.0.2: Designated Bridge 80020000cd24ff2d
% port1.0.2: Message Age 0 - Max Age 0
% port1.0.2: Hello Time 2 - Forward Delay 15
% port1.0.2: Forward Timer 0 - Msg Age Timer 0 - Hello Timer 0
```

# show spanning-tree mst instance

**Overview** This command displays detailed information for the specified instance, and all switch ports associated with that instance.

A topology change counter has been included for RSTP and MSTP. You can see the topology change counter for RSTP by using the [show spanning-tree](#) command. You can see the topology change counter for MSTP by using the **show spanning-tree mst instance** command.

For information on filtering and saving command output, see the [“Getting Started with AlliedWare Plus” Feature Overview and Configuration Guide](#).

**Syntax** `show spanning-tree mst instance <instance-id>`

Parameter	Description
<instance-id>	Specify an MSTP instance in the range 1-15.

**Mode** User Exec, Privileged Exec, and Interface Configuration

**Example** To display detailed information for **instance 2**, and all switch ports associated with that instance, use the command:

```
awplus# show spanning-tree mst instance 2
```

**Output** Figure 15-9: Example output from **show spanning-tree mst instance**

```
% 1: MSTI Root Path Cost 0 - MSTI Root Port 0 - MSTI Bridge Priority 32768
% 1: MSTI Root Id 80020000cd24ff2d
% 1: MSTI Bridge Id 80020000cd24ff2d
% port1.0.2: Port 5002 - Id 838a - Role Disabled - State Discarding
% port1.0.2: Designated Internal Path Cost 0 - Designated Port Id 838a
% port1.0.2: Configured Internal Path Cost 20000000
% port1.0.2: Configured CST External Path cost 20000000
% port1.0.2: CST Priority 128 - MSTI Priority 128
% port1.0.2: Designated Root 80020000cd24ff2d
% port1.0.2: Designated Bridge 80020000cd24ff2d
% port1.0.2: Message Age 0 - Max Age 0
% port1.0.2: Hello Time 2 - Forward Delay 15
% port1.0.2: Forward Timer 0 - Msg Age Timer 0 - Hello Timer 0
%
```

# show spanning-tree mst instance interface

**Overview** This command displays detailed information for the specified MST (Multiple Spanning Tree) instance, and the specified switch port associated with that MST instance.

For information on filtering and saving command output, see the [“Getting Started with AlliedWare Plus” Feature Overview and Configuration Guide](#).

**Syntax** `show spanning-tree mst instance <instance-id> interface <port>`

Parameter	Description
<instance-id>	Specify an MSTP instance in the range 1-15.
<port>	The port to display information about. The port may be a switch port (e.g. port1.0.4), a static channel group (e.g. sa2), or a dynamic (LACP) channel group (e.g. po2).

**Mode** User Exec, Privileged Exec, and Interface Configuration

**Example** To display detailed information for instance 2, interface port1.0.2, use the command:

```
awplus# show spanning-tree mst instance 2 interface port1.0.2
```

**Output** Figure 15-10: Example output from **show spanning-tree mst instance**

```
% 1: MSTI Root Path Cost 0 - MSTI Root Port 0 - MSTI Bridge Priority 32768
% 1: MSTI Root Id 80020000cd24ff2d
% 1: MSTI Bridge Id 80020000cd24ff2d
% port1.0.2: Port 5002 - Id 838a - Role Disabled - State Discarding
% port1.0.2: Designated Internal Path Cost 0 - Designated Port Id 838a
% port1.0.2: Configured Internal Path Cost 20000000
% port1.0.2: Configured CST External Path cost 20000000
% port1.0.2: CST Priority 128 - MSTI Priority 128
% port1.0.2: Designated Root 80020000cd24ff2d
% port1.0.2: Designated Bridge 80020000cd24ff2d
% port1.0.2: Message Age 0 - Max Age 0
% port1.0.2: Hello Time 2 - Forward Delay 15
% port1.0.2: Forward Timer 0 - Msg Age Timer 0 - Hello Timer 0
%
```

# show spanning-tree mst interface

**Overview** This command displays the number of instances created, and VLANs associated with it for the specified switch port.

For information on filtering and saving command output, see the [“Getting Started with AlliedWare Plus” Feature Overview and Configuration Guide](#).

**Syntax** `show spanning-tree mst interface <port>`

Parameter	Description
<code>&lt;port&gt;</code>	The port to display information about. The port may be a switch port (e.g. <code>port1.0.4</code> ), a static channel group (e.g. <code>sa2</code> ), or a dynamic (LACP) channel group (e.g. <code>po2</code> ).

**Mode** User Exec, Privileged Exec, and Interface Configuration

**Example** To display detailed information about each instance, and all interfaces associated with them, for `port1.0.4`, use the command:

```
awplus# show spanning-tree mst interface port1.0.4
```

**Output** Figure 15-11: Example output from **show spanning-tree mst interface**

```
% 1: Bridge up - Spanning Tree Enabled
% 1: CIST Root Path Cost 0 - CIST Root Port 0 - CIST Bridge Priority 32768
% 1: Forward Delay 15 - Hello Time 2 - Max Age 20 - Max-hops 20
% 1: CIST Root Id 80000008c73a2b22
% 1: CIST Reg Root Id 80000008c73a2b22
% 1: CST Bridge Id 80000008c73a2b22
% 1: portfast bpdu-filter disabled
% 1: portfast bpdu-guard disabled
% 1: portfast errdisable timeout disabled
% 1: portfast errdisable timeout interval 1 sec
%
% Instance      VLAN
% 0:           1
% 1:           2-3
% 2:           4-5
```

# show spanning-tree statistics

**Overview** This command displays BPDU (Bridge Protocol Data Unit) statistics for all spanning-tree instances, and all switch ports associated with all spanning-tree instances.

For information on filtering and saving command output, see the [“Getting Started with AlliedWare Plus” Feature Overview and Configuration Guide](#).

**Syntax** show spanning-tree statistics

**Mode** Privileged Exec

**Usage notes** To display BPDU statistics for all spanning-tree instances, and all switch ports associated with all spanning-tree instances, use the command:

```
awplus# show spanning-tree statistics
```

**Output** Figure 15-12: Example output from **show spanning-tree statistics**

```
Port number = 915 Interface = port1.0.6
=====
% BPDU Related Parameters
% -----
% Port Spanning Tree           : Disable
% Spanning Tree Type          : Rapid Spanning Tree Protocol
% Current Port State           : Discarding
% Port ID                      : 8393
% Port Number                  : 393
% Path Cost                    : 20000000
% Message Age                  : 0
% Designated Root              : ec:cd:6d:20:c0:ed
% Designated Cost              : 0
% Designated Bridge            : ec:cd:6d:20:c0:ed
% Designated Port Id          : 8393
% Top Change Ack               : FALSE
% Config Pending               : FALSE
% PORT Based Information & Statistics
% -----
% Config Bpdu's xmitted        : 0
% Config Bpdu's received       : 0
% TCN Bpdu's xmitted           : 0
% TCN Bpdu's received          : 0
% Forward Trans Count          : 0
```



```
% STATUS of Port Timers
% -----
% Hello Time Configured           : 2
% Hello timer                     : INACTIVE
% Hello Time Value                : 0
% Forward Delay Timer             : INACTIVE
% Forward Delay Timer Value       : 0
% Message Age Timer               : INACTIVE
% Message Age Timer Value        : 0
% Topology Change Timer          : INACTIVE
% Topology Change Timer Value    : 0
% Hold Timer                      : INACTIVE
% Hold Timer Value                : 0
% Other Port-Specific Info
% -----
% Max Age Transitions             : 1
% Msg Age Expiry                  : 0
% Similar BPDUS Rcvd             : 0
% Src Mac Count                   : 0
% Total Src Mac Rcvd             : 0
% Next State                       : Learning
% Topology Change Time           : 0
```

# show spanning-tree statistics instance

**Overview** This command displays BPDU (Bridge Protocol Data Unit) statistics for the specified MST (Multiple Spanning Tree) instance, and all switch ports associated with that MST instance.

For information on filtering and saving command output, see the [“Getting Started with AlliedWare Plus” Feature Overview and Configuration Guide](#).

**Syntax** `show spanning-tree statistics instance <instance-id>`

Parameter	Description
<instance-id>	Specify an MSTP instance in the range 1-15.

**Mode** Privileged Exec

**Example** To display BPDU statistics information for MST instance 2, and all switch ports associated with that MST instance, use the command:

```
awplus# show spanning-tree statistics instance 2
```

**Output** Figure 15-13: Example output from **show spanning-tree statistics instance**

```
% % INST_PORT port1.0.3 Information & Statistics
% -----
% Config Bpdu's xmitted (port/inst)      : (0/0)
% Config Bpdu's received (port/inst)    : (0/0)
% TCN Bpdu's xmitted (port/inst)        : (0/0)
% TCN Bpdu's received (port/inst)       : (0/0)
% Message Age(port/Inst)                 : (0/0)
% port1.0.3: Forward Transitions          : 0
% Next State                             : Learning
% Topology Change Time                   : 0
...
```

**Related commands** [show spanning-tree statistics](#)

# show spanning-tree statistics instance interface

**Overview** This command displays BPDU (Bridge Protocol Data Unit) statistics for the specified MST (Multiple Spanning Tree) instance and the specified switch port associated with that MST instance.

For information on filtering and saving command output, see the [“Getting Started with AlliedWare Plus” Feature Overview and Configuration Guide](#).

**Syntax** `show spanning-tree statistics instance <instance-id> interface <port>`

Parameter	Description
<instance-id>	Specify an MSTP instance in the range 1-15.
<port>	The port to display information about. The port may be a switch port (e.g. port1.0.4), a static channel group (e.g. sa2), or a dynamic (LACP) channel group (e.g. po2).

**Mode** Privileged Exec

**Example** To display BPDU statistics for MST instance 2, interface port1.0.2, use the command:

```
awplus# show spanning-tree statistics instance 2 interface port1.0.2
```

**Output** Figure 15-14: Example output from **show spanning-tree statistics instance interface**

```
awplus#sh spanning-tree statistics interface port1.0.2 instance 1
Spanning Tree Enabled for Instance : 1
=====
% INST_PORT port1.0.2 Information & Statistics
% -----
% Config Bpdu's xmitted (port/inst)      : (0/0)
% Config Bpdu's received (port/inst)    : (0/0)
% TCN Bpdu's xmitted (port/inst)        : (0/0)
% TCN Bpdu's received (port/inst)       : (0/0)
% Message Age(port/Inst)                 : (0/0)
% port1.0.2: Forward Transitions         : 0
% Next State                             : Learning
% Topology Change Time                   : 0

% Other Inst/Vlan Information & Statistics
% -----
% Bridge Priority                         : 0
% Bridge Mac Address                     : ec:cd:6d:20:c0:ed
% Topology Change Initiator              : 5023
% Last Topology Change Occured           : Mon Oct 3 05:42:06 2016
% Topology Change                        : FALSE
% Topology Change Detected                : FALSE
% Topology Change Count                  : 1
% Topology Change Last Recvd from        : 00:00:00:00:00:00
```

**Related commands** [show spanning-tree statistics](#)

# show spanning-tree statistics interface

**Overview** This command displays BPDU (Bridge Protocol Data Unit) statistics for the specified switch port, and all MST instances associated with that switch port.

For information on filtering and saving command output, see the [“Getting Started with AlliedWare Plus” Feature Overview and Configuration Guide](#).

**Syntax** `show spanning-tree statistics interface <port>`

Parameter	Description
<code>&lt;port&gt;</code>	The port to display information about. The port may be a switch port (e.g. port1.0.2), a static channel group (e.g. sa2), or a dynamic (LACP) channel group (e.g. po2).

**Mode** Privileged Exec

**Example** To display BPDU statistics about each MST instance for port1.0.2, use the command:

```
awplus# show spanning-tree statistics interface port1.0.2
```

**Output** Figure 15-15: Example output from **show spanning-tree statistics interface**

```
awplus#show spanning-tree statistics interface port1.0.2

      Port number = 906 Interface = port1.0.2
      =====
% BPDU Related Parameters
% -----
% Port Spanning Tree           : Disable
% Spanning Tree Type          : Multiple Spanning Tree Protocol
% Current Port State           : Discarding
% Port ID                      : 838a
% Port Number                  : 38a
% Path Cost                    : 20000000
% Message Age                  : 0
% Designated Root              : ec:cd:6d:20:c0:ed
% Designated Cost              : 0
% Designated Bridge            : ec:cd:6d:20:c0:ed
% Designated Port Id          : 838a
% Top Change Ack               : FALSE
% Config Pending               : FALSE
```

```
% PORT Based Information & Statistics
% -----
% Config Bpdu's xmitted           : 0
% Config Bpdu's received          : 0
% TCN Bpdu's xmitted              : 0
% TCN Bpdu's received             : 0
% Forward Trans Count              : 0

% STATUS of Port Timers
% -----
% Hello Time Configured           : 2
% Hello timer                     : INACTIVE
% Hello Time Value                : 0
% Forward Delay Timer             : INACTIVE
% Forward Delay Timer Value       : 0
% Message Age Timer               : INACTIVE
% Message Age Timer Value        : 0
% Topology Change Timer           : INACTIVE
% Topology Change Timer Value    : 0
% Hold Timer                      : INACTIVE
% Hold Timer Value                : 0

% Other Port-Specific Info
% -----
% Max Age Transitions             : 1
% Msg Age Expiry                  : 0
% Similar BPDUS Rcvd             : 0
% Src Mac Count                   : 0
% Total Src Mac Rcvd             : 0
% Next State                      : Learning
% Topology Change Time           : 0
% Other Bridge information & Statistics
% -----
% STP Multicast Address           : 01:80:c2:00:00:00
% Bridge Priority                  : 32768
% Bridge Mac Address              : ec:cd:6d:20:c0:ed
% Bridge Hello Time               : 2
% Bridge Forward Delay            : 15
% Topology Change Initiator       : 5023
% Last Topology Change Occured    : Mon Oct 3 05:41:20 2016
% Topology Change                 : FALSE
% Topology Change Detected        : TRUE
% Topology Change Count           : 1
% Topology Change Last Recvd from : 00:00:00:00:00:00
```

**Related commands** [show spanning-tree statistics](#)

# show spanning-tree vlan range-index

**Overview** Use this command to display information about MST (Multiple Spanning Tree) instances and the VLANs associated with them including the VLAN range-index value for the device.

**Syntax** `show spanning-tree vlan range-index`

**Mode** Privileged Exec

**Example** To display information about MST instances and the VLANs associated with them for the device, including the VLAN range-index value, use the following command:

```
awplus# show spanning-tree vlan range-index
```

**Output** Figure 15-16: Example output from **show spanning-tree vlan range-index**

```
awplus#show spanning-tree vlan range-index
% MST Instance  VLAN      RangeIdx
%           1         1         1%
```

**Related commands** [show spanning-tree statistics](#)

# spanning-tree autoedge (RSTP and MSTP)

**Overview** Use this command to enable the autoedge feature on the port.

The autoedge feature allows the port to automatically detect that it is an edge port. If it does not receive any BPDUs in the first three seconds after linkup, enabling, or entering RSTP or MSTP mode, it sets itself to be an edgeport and enters the forwarding state.

Use this command for RSTP or MSTP.

Use the **no** variant of this command to disable this feature.

**Syntax** `spanning-tree autoedge`  
`no spanning-tree autoedge`

**Default** Disabled

**Mode** Interface Configuration

**Example** `awplus# configure terminal`  
`awplus(config)# interface port1.0.3`  
`awplus(config-if)# spanning-tree autoedge`

**Related commands** [spanning-tree edgeport \(RSTP and MSTP\)](#)



# spanning-tree bpdu

**Overview** Use this command to configure BPDU (Bridge Protocol Data Unit) discarding or forwarding, when STP is disabled on the switch. This may be needed for correct STP operation in complex networks.

There is no **no** variant for this command. Instead, apply the **discard** parameter to reset it back to the default then re-enable STP with the command `spanning-tree enable`.

**Syntax** `spanning-tree bpdu  
{discard|forward|forward-untagged-vlan|forward-vlan}`

Parameter	Description
bpdu	A port that has BPDU filtering enabled will not transmit any BPDUs and will ignore any BPDUs received. This port type has one of the following parameters (in Global Configuration mode):
discard	Discards all ingress STP BPDU frames.
forward	Forwards any ingress STP BPDU packets to all ports, regardless of any VLAN membership.
forward-untagged-vlan	Forwards any ingress STP BPDU frames to all ports that are untagged members of the ingress port's native VLAN.
forward-vlan	Forwards any ingress STP BPDU frames to all ports that are tagged members of the ingress port's native VLAN.

**Default** The discard parameter is enabled by default.

**Mode** Global Configuration

**Usage notes** This command enables the switch to forward unsupported BPDUs with an unsupported Spanning Tree Protocol, such as proprietary STP protocols with unsupported BPDUs, by forwarding BPDU (Bridge Protocol Data Unit) frames unchanged through the switch.

You must disable RSTP with the **no spanning-tree rstp enable** command before you can use this command.

When you want to revert to default behavior on the switch, issue a **spanning-tree bdp discard** command and re-enable Spanning Tree with a **spanning-tree rstp enable** command.

**Examples** To enable STP BPDU discard in Global Configuration mode with STP disabled, which discards all ingress STP BPDU frames, enter the commands:

```
awplus# configure terminal
awplus(config)# no spanning-tree rstp enable
awplus(config)# spanning-tree bpdu discard
```

To enable STP BPDU forward in Global Configuration mode with STP disabled, which forwards any ingress STP BPDU frames to all ports regardless of any VLAN membership, enter the commands:

```
awplus# configure terminal
awplus(config)# no spanning-tree rstp enable
awplus(config)# spanning-tree bpdu forward
```

To enable STP BPDU forwarding for untagged frames in Global Configuration mode with STP disabled, which forwards any ingress STP BPDU frames to all ports that are untagged members of the ingress port's native VLAN, enter the commands:

```
awplus# configure terminal
awplus(config)# no spanning-tree rstp enable
awplus(config)# spanning-tree bpdu forward-untagged-vlan
```

To enable STP BPDU forwarding for tagged frames in Global Configuration mode with STP disabled, which forwards any ingress STP BPDU frames to all ports that are tagged members of the ingress port's native VLAN, enter the commands:

```
awplus# configure terminal
awplus(config)# no spanning-tree rstp enable
awplus(config)# spanning-tree bpdu forward-vlan
```

To reset STP BPDU back to the default discard parameter and re-enable RSTP on the switch, enter the commands:

```
awplus# configure terminal
awplus(config)# spanning-tree bpdu discard
awplus(config)# spanning-tree rstp enable
```

**Related commands** [show spanning-tree](#)  
[spanning-tree enable](#)

# spanning-tree cisco-interoperability (MSTP)

**Overview** Use this command to enable/disable Cisco-interoperability for MSTP.  
Use this command for MSTP only.

**Syntax** `spanning-tree cisco-interoperability {enable|disable}`

Parameter	Description
enable	Enable Cisco interoperability for MSTP.
disable	Disable Cisco interoperability for MSTP.

**Default** If this command is not used, Cisco interoperability is disabled.

**Mode** Global Configuration

**Usage** For compatibility with certain Cisco devices, all devices in the switched LAN running the AlliedWare Plus™ Operating System must have Cisco-interoperability enabled. When the AlliedWare Plus Operating System is interoperating with Cisco, the only criteria used to classify a region are the region name and revision level. VLAN to instance mapping is not used to classify regions when interoperating with Cisco.

**Examples** To enable Cisco interoperability on a Layer 2 device:

```
awplus# configure terminal
awplus(config)# spanning-tree cisco-interoperability enable
```

To disable Cisco interoperability on a Layer 2 device:

```
awplus# configure terminal
awplus(config)# spanning-tree cisco-interoperability disable
```

# spanning-tree edgeport (RSTP and MSTP)

**Overview** Use this command to set a port as an edge-port.

Use this command for RSTP or MSTP.

This command has the same effect as the [spanning-tree portfast \(STP\)](#) command, but the configuration displays differently in the output of some show commands.

Use the **no** variant of this command to set a port to its default state (not an edge-port).

**Syntax** `spanning-tree edgeport`  
`no spanning-tree edgeport`

**Default** Not an edge port.

**Mode** Interface Configuration

**Usage notes** Use this command on a switch port connected to a LAN that has no other bridges attached. If a BPDU is received on the port that indicates that another bridge is connected to the LAN, then the port is no longer treated as an edge port.

**Example** `awplus# configure terminal`  
`awplus(config)# interface port1.0.2`  
`awplus(config-if)# spanning-tree edgeport`

**Related commands** [spanning-tree autoedge \(RSTP and MSTP\)](#)

# spanning-tree enable

**Overview** Use this command in Global Configuration mode to enable the specified spanning tree protocol for all switch ports. Note that this must be the spanning tree protocol that is configured on the device by the [spanning-tree mode](#) command.

Use the **no** variant of this command to disable the configured spanning tree protocol. This places all switch ports in the forwarding state.

**Syntax** `spanning-tree {mstp|rstp|stp} enable`  
`no spanning-tree {mstp|rstp|stp} enable`

Parameter	Description
mstp	Enables or disables MSTP (Multiple Spanning Tree Protocol).
rstp	Enables or disables RSTP (Rapid Spanning Tree Protocol).
stp	Enables or disables STP (Spanning Tree Protocol).

**Default** RSTP is enabled by default for all switch ports.

**Mode** Global Configuration

**Usage** With no configuration, spanning tree is enabled, and the spanning tree mode is set to RSTP. To change the mode, see [spanning-tree mode](#) command.

**Examples** To enable STP in Global Configuration mode, enter the below commands:

```
awplus# configure terminal
awplus(config)# spanning-tree stp enable
```

To disable STP in Global Configuration mode, enter the below commands:

```
awplus# configure terminal
awplus(config)# no spanning-tree stp enable
```

To enable MSTP in Global Configuration mode, enter the below commands:

```
awplus# configure terminal
awplus(config)# spanning-tree mstp enable
```

To disable MSTP in Global Configuration mode, enter the below commands:

```
awplus# configure terminal
awplus(config)# no spanning-tree mstp enable
```

To enable RSTP in Global Configuration mode, enter the below commands:

```
awplus# configure terminal
awplus(config)# spanning-tree rstp enable
```

To disable RSTP in Global Configuration mode, enter the below commands:

```
awplus# configure terminal
```

```
awplus(config)# no spanning-tree rstp enable
```

**Related  
commands**

[spanning-tree bpdu](#)

[spanning-tree mode](#)

# spanning-tree errdisable-timeout enable

**Overview** Use this command to enable the errdisable-timeout facility, which sets a timeout for ports that are disabled due to the BPDU guard feature.

Use this command for RSTP or MSTP.

Use the **no** variant of this command to disable the errdisable-timeout facility.

**Syntax** `spanning-tree errdisable-timeout enable`  
`no spanning-tree errdisable-timeout enable`

**Default** By default, the errdisable-timeout is disabled.

**Mode** Global Configuration

**Usage** The BPDU guard feature shuts down the port on receiving a BPDU on a BPDU-guard enabled port. This command associates a timer with the feature such that the port is re-enabled without manual intervention after a set interval. This interval can be configured by the user using the [spanning-tree errdisable-timeout interval](#) command.

**Example** `awplus# configure terminal`  
`awplus(config)# spanning-tree errdisable-timeout enable`

**Related commands** [show spanning-tree](#)  
[spanning-tree errdisable-timeout interval](#)  
[spanning-tree portfast bpdu-guard](#)

# spanning-tree errdisable-timeout interval

**Overview** Use this command to specify the time interval after which a port is brought back up when it has been disabled by the BPDU guard feature.

Use this command for RSTP or MSTP.

**Syntax** `spanning-tree errdisable-timeout interval <10-1000000>`  
`no spanning-tree errdisable-timeout interval`

Parameter	Description
<code>&lt;10-1000000&gt;</code>	Specify the errdisable-timeout interval in seconds.

**Default** By default, the port is re-enabled after 300 seconds.

**Mode** Global Configuration

**Example** `awplus# configure terminal`  
`awplus(config)# spanning-tree errdisable-timeout interval 34`

**Related commands** [show spanning-tree](#)  
[spanning-tree errdisable-timeout enable](#)  
[spanning-tree portfast bpdu-guard](#)



# spanning-tree force-version

**Overview** Use this command in Interface Configuration mode for a switch port interface only to force the protocol version for the switch port. Use this command for RSTP or MSTP only.

**Syntax** `spanning-tree force-version <version>`  
`no spanning-tree force-version`

Parameter	Description
<code>&lt;version&gt;</code>	<code>&lt;0-3&gt;</code> Version identifier.
0	Forces the port to operate in STP mode.
1	Not supported.
2	Forces the port to operate in RSTP mode. If it receives STP BPDUs, it can automatically revert to STP mode.
3	Forces the port to operate in MSTP mode (this option is only available if MSTP mode is configured). If it receives RSTP or STP BPDUs, it can automatically revert to RSTP or STP mode.

**Default** By default, no version is forced for the port. The port is in the spanning tree mode configured for the device, or a lower version if it automatically detects one.

**Mode** Interface Configuration mode for a switch port interface only.

**Examples** Set the value to enforce the spanning tree protocol (STP):

```
awplus# configure terminal
awplus(config)# interface port1.0.2
awplus(config-if)# spanning-tree force-version 0
```

Set the default protocol version:

```
awplus# configure terminal
awplus(config)# interface port1.0.2
awplus(config-if)# no spanning-tree force-version
```

**Related commands** [show spanning-tree](#)

# spanning-tree forward-time

**Overview** Use this command to set the forward delay value. Use the **no** variant of this command to reset the forward delay value to the default setting of 15 seconds.

The **forward delay** sets the time (in seconds) to control how fast a port changes its spanning tree state when moving towards the forwarding state. If the mode is set to STP, the value determines how long the port stays in each of the listening and learning states which precede the forwarding state. If the mode is set to RSTP or MSTP, this value determines the maximum time taken to transition from discarding to learning and from learning to forwarding.

This value is used only when the device is acting as the root bridge. Devices not acting as the Root Bridge use a dynamic value for the **forward delay** set by the root bridge. The **forward delay**, **max-age**, and **hello time** parameters are interrelated.

**Syntax** `spanning-tree forward-time <forward-delay>`  
`no spanning-tree forward-time`

Parameter	Description
<code>&lt;forward-delay&gt;</code>	<code>&lt;4-30&gt;</code> The forwarding time delay in seconds.

**Default** The default is 15 seconds.

**Mode** Global Configuration

**Usage notes** The allowable range for forward-time is 4-30 seconds.

The **forward delay**, **max-age**, and **hello time** parameters should be set according to the following formula, as specified in IEEE Standard 802.1d:

$2 \times (\text{forward delay} - 1.0 \text{ seconds}) \geq \text{max-age}$

$\text{max-age} \geq 2 \times (\text{hello time} + 1.0 \text{ seconds})$

**Example**

```
awplus# configure terminal
awplus(config)# spanning-tree forward-time 6
```

**Related commands** `show spanning-tree`  
`spanning-tree forward-time`  
`spanning-tree hello-time`  
`spanning-tree mode`

# spanning-tree guard root

**Overview** Use this command in Interface Configuration mode for a switch port only to enable the Root Guard feature for the switch port. The root guard feature disables reception of superior BPDUs. You can use this command for RSTP, STP or MSTP.

Use the **no** variant of this command to disable the root guard feature for the port.

**Syntax** `spanning-tree guard root`  
`no spanning-tree guard root`

**Mode** Interface Configuration mode for a switch port interface only.

**Usage notes** The Root Guard feature makes sure that the port on which it is enabled is a designated port. If the Root Guard enabled port receives a superior BPDU, it goes to a Listening state (for STP) or discarding state (for RSTP and MSTP).

**Example** `awplus# configure terminal`  
`awplus(config)# interface port1.0.2`  
`awplus(config-if)# spanning-tree guard root`

# spanning-tree hello-time

**Overview** Use this command to set the hello-time. This sets the time in seconds between the transmission of device spanning tree configuration information when the device is the Root Bridge of the spanning tree or is trying to become the Root Bridge.

Use this command for RSTP, STP or MSTP.

Use the **no** variant of this command to restore the default of the hello time.

**Syntax** `spanning-tree hello-time <hello-time>`  
`no spanning-tree hello-time`

Parameter	Description
<code>&lt;hello-time&gt;</code>	<code>&lt;1-10&gt;</code> The hello BPDU interval in seconds.

**Default** Default is 2 seconds.

**Mode** Global Configuration and Interface Configuration for switch ports.

**Usage notes** The allowable range of values is 1-10 seconds.

The forward delay, max-age, and hello time parameters should be set according to the following formula, as specified in IEEE Standard 802.1d:

$2 \times (\text{forward delay} - 1.0 \text{ seconds}) \geq \text{max-age}$

$\text{max-age} \geq 2 \times (\text{hello time} + 1.0 \text{ seconds})$

**Example** `awplus# configure terminal`  
`awplus(config)# spanning-tree hello-time 3`

**Related commands** [spanning-tree forward-time](#)  
[spanning-tree max-age](#)  
[show spanning-tree](#)

# spanning-tree link-type

**Overview** Use this command in Interface Configuration mode for a switch port interface only to enable or disable point-to-point or shared link types on the switch port.

Use this command for RSTP or MSTP only.

Use the **no** variant of this command to return the port to the default link type.

**Syntax** `spanning-tree link-type {point-to-point|shared}`  
`no spanning-tree link-type`

Parameter	Description
shared	Disable rapid transition.
point-to-point	Enable rapid transition.

**Default** The default link type is point-to-point.

**Mode** Interface Configuration mode for a switch port interface only.

**Usage notes** You may want to set link type to shared if the port is connected to a hub with multiple devices connected to it.

**Examples** `awplus# configure terminal`  
`awplus(config)# interface port1.0.2`  
`awplus(config-if)# spanning-tree link-type point-to-point`

# spanning-tree max-age

**Overview** Use this command to set the max-age. This sets the maximum age, in seconds, that dynamic spanning tree configuration information is stored in the device before it is discarded.

Use this command for RSTP, STP or MSTP.

Use the **no** variant of this command to restore the default of max-age.

**Syntax** `spanning-tree max-age <max-age>`  
`no spanning-tree max-age`

Parameter	Description
<code>&lt;max-age&gt;</code>	<code>&lt;6-40&gt;</code> The maximum time, in seconds.

**Default** The default of spanning-tree max-age is 20 seconds.

**Mode** Global Configuration

**Usage** Max-age is the maximum time in seconds for which a message is considered valid. Configure this value sufficiently high, so that a frame generated by the root bridge can be propagated to the leaf nodes without exceeding the max-age.

The **forward delay**, **max-age**, and **hello time** parameters should be set according to the following formula, as specified in IEEE Standard 802.1d:

$2 \times (\text{forward delay} - 1.0 \text{ seconds}) \geq \text{max-age}$

$\text{max-age} \geq 2 \times (\text{hello time} + 1.0 \text{ seconds})$

**Example** `awplus# configure terminal`  
`awplus(config)# spanning-tree max-age 12`

**Related commands** [show spanning-tree](#)  
[spanning-tree forward-time](#)  
[spanning-tree hello-time](#)

# spanning-tree max-hops (MSTP)

**Overview** Use this command to specify the maximum allowed hops for a BPDU in an MST region. This parameter is used by all the instances of the MST region.

Use the **no** variant of this command to restore the default.

Use this command for MSTP only.

**Syntax** `spanning-tree max-hops <hop-count>`  
`no spanning-tree max-hops <hop-count>`

Parameter	Description
<code>&lt;hop-count&gt;</code>	Specify the maximum hops the BPDU will be valid for in the range <1-40>.

**Default** The default max-hops in a MST region is 20.

**Mode** Global Configuration

**Usage** Specifying the max hops for a BPDU prevents the messages from looping indefinitely in the network. The hop count is decremented by each receiving port. When a device receives an MST BPDU that has a hop count of zero, it discards the BPDU.

**Examples**

```
awplus# configure terminal
awplus(config)# spanning-tree max-hops 25
awplus# configure terminal
awplus(config)# no spanning-tree max-hops
```

# spanning-tree mode

**Overview** Use this command to change the spanning tree protocol mode on the device. The spanning tree protocol mode on the device can be configured to either STP, RSTP or MSTP.

**Syntax** `spanning-tree mode {stp|rstp|mstp}`

**Default** The default spanning tree protocol mode on the device is RSTP.

**Mode** Global Configuration

**Usage** With no configuration, the device will have spanning tree enabled, and the spanning tree mode will be set to RSTP. Use this command to change the spanning tree protocol mode on the device. MSTP is VLAN aware, but RSTP and STP are not VLAN aware. To enable or disable spanning tree operation, see the [spanning-tree enable](#) command.

**Examples** To change the spanning tree mode from the default of RSTP to MSTP, use the following commands:

```
awplus# configure terminal
awplus(config)# spanning-tree mode mstp
```

**Related commands** [spanning-tree enable](#)



# spanning-tree mst configuration

**Overview** Use this command to enter the MST Configuration mode to configure the Multiple Spanning-Tree Protocol.

**Syntax** `spanning-tree mst configuration`

**Mode** Global Configuration

**Examples** The following example uses this command to enter MST Configuration mode. Note the change in the command prompt.

```
awplus# configure terminal
awplus(config)# spanning-tree mst configuration
awplus(config-mst)#
```

# spanning-tree mst instance

**Overview** Use this command to assign a Multiple Spanning Tree instance (MSTI) to a switch port or channel group.

Note that ports are automatically configured to send and receive spanning-tree information for the associated MSTI when VLANs are assigned to MSTIs using the [instance vlan \(MSTP\)](#) command.

Use the **no** variant of this command in Interface Configuration mode to remove the MSTI from the specified switch port or channel group.

**Syntax**

```
spanning-tree mst instance <instance-id>  
no spanning-tree mst instance <instance-id>
```

Parameter	Description
<instance-id>	Specify an MSTP instance in the range 1-15. The MST instance must have already been created using the <a href="#">instance vlan (MSTP)</a> command.

**Default** A port automatically becomes a member of an MSTI when it is assigned to a VLAN.

**Mode** Interface Configuration mode for a switch port or channel group.

**Usage notes** You can disable automatic configuration of member ports of a VLAN to an associated MSTI by using a **no spanning-tree mst instance** command to remove the member port from the MSTI. Use the **spanning-tree mst instance** command to add a VLAN member port back to the MSTI.

**Examples** To assign instance 3 to a switch port, use the commands:

```
awplus# configure terminal  
awplus(config)# interface port1.0.2  
awplus(config-if)# spanning-tree mst instance 3
```

To remove instance 3 from a switch port, use the commands:

```
awplus# configure terminal  
awplus(config)# interface port1.0.2  
awplus(config-if)# no spanning-tree mst instance 3
```

**Related commands**

- [instance vlan \(MSTP\)](#)
- [spanning-tree mst instance path-cost](#)

- [spanning-tree mst instance priority](#)

- [spanning-tree mst instance restricted-role](#)

- [spanning-tree mst instance restricted-tcn](#)

# spanning-tree mst instance path-cost

**Overview** Use this command to set the cost of a path associated with a switch port, for the specified MSTI.

This specifies the switch port's contribution to the cost of a path to the MSTI regional root via that port. This applies when the port is the root port for the MSTI.

Use the **no** variant of this command to restore the default cost value of the path.

**Syntax** `spanning-tree mst instance <instance-id> path-cost <path-cost>`  
`no spanning-tree mst instance <instance-id> path-cost`

Parameter	Description
<code>&lt;instance-id&gt;</code>	Specify an MSTP instance in the range 1-15.
<code>&lt;path-cost&gt;</code>	Specify the cost of path in the range of <1-200000000>, where a lower path-cost indicates a greater likelihood of the specific interface becoming a root.

**Default** The default path cost values and the range of recommended path cost values depend on the port speed, as shown in the following table from the IEEE 802.1q-2003 standard.

Port speed	Default path cost	Recommended path cost range
Less than 100 Kb/s	200,000,000	20,000,000-200,000,000
1Mbps	20,000,000	2,000,000-20,000,000
10Mbps	2,000,000	200,000-2,000,000
100 Mbps	200,000	20,000-200,000
1 Gbps	20,000	2,000-20,000
10 Gbps	2,000	200-2,000
100 Gbps	200	20-200
1Tbps	20	2-200
10 Tbps	2	2-20

**Mode** Interface Configuration mode for a switch port interface only.

**Usage notes** Before you can use this command to set a path-cost in a VLAN configuration, you must explicitly add an MST instance to a port using the [spanning-tree mst instance](#) command.

**Examples** To set a path cost of 1000 on instance 3, use the commands:

```
awplus# configure terminal
awplus(config)# interface port1.0.2
awplus(config-if)# spanning-tree mst instance 3 path-cost 1000
```

To return the path cost to its default value on instance 3, use the commands:

```
awplus# configure terminal
awplus(config)# interface port1.0.2
awplus(config-if)# no spanning-tree mst instance 3 path-cost
```

**Related  
commands**

[instance vlan \(MSTP\)](#)  
[spanning-tree mst instance](#)  
[spanning-tree mst instance priority](#)  
[spanning-tree mst instance restricted-role](#)  
[spanning-tree mst instance restricted-tcn](#)

# spanning-tree mst instance priority

**Overview** Use this command in Interface Configuration mode for a switch port interface only to set the port priority for an MST instance (MSTI).

Use the **no** variant of this command to restore the default priority value (128).

**Syntax** `spanning-tree mst instance <instance-id> priority <priority>`  
`no spanning-tree mst instance <instance-id> [priority]`

Parameter	Description
<code>&lt;instance-id&gt;</code>	Specify an MSTP instance in the range 1-15.
<code>&lt;priority&gt;</code>	This must be a multiple of 16 and within the range <0-240>. A lower priority indicates greater likelihood of the port becoming the root port.

**Default** The default is 128.

**Mode** Interface Configuration mode for a switch port interface.

**Usage notes** This command sets the value of the priority field contained in the port identifier. The MST algorithm uses the port priority when determining the root port for the switch in the MSTI. The port with the lowest value has the highest priority, so it will be chosen as root port over a port that is equivalent in all other aspects but with a higher priority value.

**Examples** To set the priority to 112 on instance 3, use the commands:

```
awplus# configure terminal
awplus(config)# interface port1.0.2
awplus(config-if)# spanning-tree mst instance 3 priority 112
```

To return the priority to its default value of 128 on instance 3, use the commands:

```
awplus# configure terminal
awplus(config)# interface port1.0.2
awplus(config-if)# no spanning-tree mst instance 3 priority
```

**Related commands**

- [instance vlan \(MSTP\)](#)
- [spanning-tree priority \(port priority\)](#)
- [spanning-tree mst instance](#)
- [spanning-tree mst instance path-cost](#)
- [spanning-tree mst instance restricted-role](#)
- [spanning-tree mst instance restricted-tcn](#)

# spanning-tree mst instance restricted-role

**Overview** Use this command in Interface Configuration mode for a switch port interface only to enable the restricted role for an MSTI (Multiple Spanning Tree Instance) on a switch port. Configuring the restricted role for an MSTI on a switch port prevents the switch port from becoming the root port in a spanning tree topology.

Use the **no** variant of this command to disable the restricted role for an MSTI on a switch port. Removing the restricted role for an MSTI on a switch port allows the switch port to become the root port in a spanning tree topology.

**Syntax** `spanning-tree mst instance <instance-id> restricted-role`  
`no spanning-tree mst instance <instance-id> restricted-role`

Parameter	Description
<code>&lt;instance-id&gt;</code>	Specify an MSTP instance in the range 1-15. The MST instance must have already been created using the <a href="#">instance vlan (MSTP)</a> command.

**Default** The restricted role for an MSTI instance on a switch port is disabled by default.

**Mode** Interface Configuration mode for a switch port interface only.

**Usage notes** The root port is the port providing the best path from the bridge to the root bridge. Use this command to disable a port from becoming a root port. Use the **no** variant of this command to enable a port to become a root port. See the [STP Feature Overview and Configuration Guide](#) for root port information.

**Examples** To prevent a switch port from becoming the root port, use the commands:

```
awplus# configure terminal
awplus(config)# interface port1.0.2
awplus(config-if)# spanning-tree mst instance 3 restricted-role
```

To stop preventing the switch port from becoming the root port, use the commands:

```
awplus# configure terminal
awplus(config)# interface port1.0.2
awplus(config-if)# no spanning-tree mst instance 3
restricted-role
```

**Related commands**

- instance vlan (MSTP)
- spanning-tree priority (port priority)
- spanning-tree mst instance
- spanning-tree mst instance path-cost
- spanning-tree mst instance restricted-tcn

# spanning-tree mst instance restricted-tcn

**Overview** Use this command to prevent a switch port from propagating received topology change notifications and topology changes to other switch ports. This is named restricted TCN (Topology Change Notification). A TCN is a simple Bridge Protocol Data Unit (BPDU) that a bridge sends out to its root port to signal a topology change.

Use the **no** variant of this command to stop preventing the switch port from propagating received topology change notifications and topology changes to other switch ports for the specified MSTI (Multiple Spanning Tree Instance).

The restricted TCN setting applies only to the specified MSTI (Multiple Spanning Tree Instance).

**Syntax** `spanning-tree mst instance <instance-id> restricted-tcn`  
`no spanning-tree mst instance <instance-id> restricted-tcn`

Parameter	Description
<code>&lt;instance-id&gt;</code>	Specify an MSTP instance in the range 1-15. The MST instance must have already been created using the <a href="#">instance vlan (MSTP)</a> command.

**Default** Disabled. By default, switch ports propagate TCNs.

**Mode** Interface Configuration mode for a switch port interface only.

**Examples** To prevent a switch port from propagating received topology change notifications and topology changes to other switch ports, use the commands:

```
awplus# configure terminal
awplus(config)# interface port1.0.2
awplus(config-if)# spanning-tree mst instance 3 restricted-tcn
```

To stop preventing a switch port from propagating received topology change notifications and topology changes to other switch ports, use the commands:

```
awplus# configure terminal
awplus(config)# interface port1.0.2
awplus(config-if)# no spanning-tree mst instance 3
restricted-tcn
```

**Related commands**

- [instance vlan \(MSTP\)](#)
- [spanning-tree priority \(port priority\)](#)
- [spanning-tree mst instance](#)
- [spanning-tree mst instance path-cost](#)
- [spanning-tree mst instance restricted-role](#)



# spanning-tree path-cost

**Overview** Use this command in Interface Configuration mode for a switch port interface only to set the cost of a path for the specified port. This value then combines with others along the path to the root bridge in order to determine the total cost path value from the particular port, to the root bridge. The lower the numeric value, the higher the priority of the path. This applies when the port is the root port.

Use this command for RSTP, STP or MSTP. When MSTP mode is configured, this will apply to the port's path cost for the CIST.

**Syntax** `spanning-tree path-cost <pathcost>`  
`no spanning-tree path-cost`

Parameter	Description
<code>&lt;pathcost&gt;</code>	<code>&lt;1-200000000&gt;</code> The cost to be assigned to the port.

**Default** The default path cost values and the range of recommended path cost values depend on the port speed, as shown in the following table from the IEEE 802.1q-2003 and IEEE 802.1d-2004 standards.

Port speed	Default path cost	Recommended path cost range
Less than 100 Kb/s	200,000,000	20,000,000-200,000,000
1Mbps	20,000,000	2,000,000-20,000,000
10Mbps	2,000,000	200,000-2,000,000
100 Mbps	200,000	20,000-200,000
1 Gbps	20,000	2,000-20,000
10 Gbps	2,000	200-2,000
100 Gbps	200	20-200
1Tbps	20	2-200
10 Tbps	2	2-20

**Mode** Interface Configuration mode for switch port interface only.

**Example** `awplus# configure terminal`  
`awplus(config)# interface port1.0.2`  
`awplus(config-if)# spanning-tree path-cost 123`

# spanning-tree portfast (STP)

**Overview** Use this command in Interface Configuration mode for a switch port interface only to set a port as an edge-port. The portfast feature enables a port to rapidly move to the forwarding state, without having first to pass through the intermediate spanning tree states. This command has the same effect as the [spanning-tree edgeport \(RSTP and MSTP\)](#) command, but the configuration displays differently in the output of some show commands.

**NOTE:** You can run either of two additional parameters with this command. To simplify the syntax these are documented as separate commands. See the following additional portfast commands:

- [spanning-tree portfast bpdu-filter](#) command
- [spanning-tree portfast bpdu-guard](#) command.

You can obtain the same effect by running the [spanning-tree edgeport \(RSTP and MSTP\)](#) command. However, the configuration output may display differently in some show commands.

Use the **no** variant of this command to set a port to its default state (not an edge-port).

**Syntax** `spanning-tree portfast`  
`no spanning-tree portfast`

**Default** Not an edge port.

**Mode** Interface Configuration mode for a switch port interface only.

**Usage notes** Portfast makes a port move from a blocking state to a forwarding state, bypassing both listening and learning states. The portfast feature is meant to be used for ports connected to end-user devices. Enabling portfast on ports that are connected to a workstation or server allows devices to connect to the network without waiting for spanning-tree to converge.

For example, you may need hosts to receive a DHCP address quickly and waiting for STP to converge would cause the DHCP request to time out. Ensure you do not use portfast on any ports connected to another device to avoid creating a spanning-tree loop on the network.

Use this command on a switch port that connects to a LAN with no other bridges attached. An edge port should never receive BPDUs. Therefore if an edge port receives a BPDU, the portfast feature takes one of three actions.

- Cease to act as an edge port and pass BPDUs as a member of a spanning tree network ([spanning-tree portfast \(STP\)](#) command disabled).
- Filter out the BPDUs and pass only the data and continue to act as a edge port ([spanning-tree portfast bpdu-filter](#) command enabled).
- Block the port to all BPDUs and data ([spanning-tree portfast bpdu-guard](#) command enabled).

**Example** awplus# configure terminal  
awplus(config)# interface port1.0.2  
awplus(config-if)# spanning-tree portfast

**Related commands** spanning-tree edgeport (RSTP and MSTP)  
show spanning-tree  
spanning-tree portfast bpdu-filter  
spanning-tree portfast bpdu-guard

# spanning-tree portfast bpdu-filter

**Overview** This command sets the bpdu-filter feature and applies a filter to any BPDUs (Bridge Protocol Data Units) received. Enabling this feature ensures that configured ports will not transmit any BPDUs and will ignore (filter out) any BPDUs received. BPDU Filter is not enabled on a port by default.

Using the **no** variant of this command to turn off the bpdu-filter, but retain the port's status as an enabled port. If the port then receives a BPDU it will change its role from an **edge-port** to a **non edge-port**.

**Syntax (Global Configuration)**

```
spanning-tree portfast bpdu-filter  
no spanning-tree portfast bpdu-filter
```

**Syntax (Interface Configuration)**

```
spanning-tree portfast bpdu-filter  
{default|disable|enable}  
no spanning-tree portfast bpdu-filter
```

Parameter	Description
bpdu-filter	A port that has bpdu-filter enabled will not transmit any BPDUs and will ignore any BPDUs received. This port type has one of the following parameters (in Interface Configuration mode):
default	Takes the setting that has been configured for the whole device, i.e. the setting made from the Global configuration mode.
disable	Turns off BPDU filter.
enable	Turns on BPDU filter.

**Default** BPDU Filter is not enabled on any ports by default.

**Mode** Global Configuration and Interface Configuration

**Usage notes** This command filters the BPDUs and passes only data to continue to act as an edge port. Using this command in Global Configuration mode applies the portfast bpdu-filter feature to all ports on the device. Using it in Interface mode applies the feature to a specific port, or range of ports. The command will operate in both RSTP and MSTP networks.

Use the [show spanning-tree](#) command to display status of the bpdu-filter parameter for the switch ports.

**Example** To enable STP BPDU filtering in Global Configuration mode, enter the commands:

```
awplus# configure terminal  
awplus(config)# spanning-tree portfast bpdu-filter
```

To enable STP BPDU filtering in Interface Configuration mode, enter the commands:

```
awplus# configure terminal
awplus(config)# interface port1.0.2
awplus(config-if)# spanning-tree portfast bpdu-filter enable
```

**Related  
commands**

[spanning-tree edgeport \(RSTP and MSTP\)](#)  
[show spanning-tree](#)  
[spanning-tree portfast \(STP\)](#)  
[spanning-tree portfast bpdu-guard](#)

# spanning-tree portfast bpdu-guard

**Overview** This command applies a BPDU (Bridge Protocol Data Unit) guard to the port. A port with the bpdu-guard feature enabled will block all traffic (BPDUs and user data), if it starts receiving BPDUs.

Use this command in Global Configuration mode to apply BPDU guard to all ports on the device. Use this command in Interface mode for an individual interface or a range of interfaces specified. BPDU Guard is not enabled on a port by default.

Use the **no** variant of this command to disable the BPDU Guard feature on a device in Global Configuration mode or to disable the BPDU Guard feature on a port in Interface mode.

**Syntax (Global Configuration)**

```
spanning-tree portfast bpdu-guard  
no spanning-tree portfast bpdu-guard
```

**Syntax (Interface Configuration)**

```
spanning-tree portfast bpdu-guard  
{default|disable|enable}  
no spanning-tree portfast bpdu-guard
```

Parameter	Description
bpdu-guard	A port that has bpdu-guard turned on will enter the STP blocking state if it receives a BPDU. This port type has one of the following parameters (in Interface Configuration mode):
default	Takes the setting that has been configured for the whole device, i.e. the setting made from the Global configuration mode.
disable	Turns off BPDU guard.
enable	Turns on BPDU guard and will also set the port as an edge port.

**Default** BPDU Guard is not enabled on any ports by default.

**Mode** Global Configuration or Interface Configuration

**Usage notes** This command blocks the port(s) to all devices and data when enabled. BPDU Guard is a port-security feature that changes how a portfast-enabled port behaves if it receives a BPDU. When **bpdu-guard** is set, then the port shuts down if it receives a BPDU. It does not process the BPDU as it is considered suspicious. When **bpdu-guard** is not set, then the port will negotiate spanning-tree with the device sending the BPDUs. By default, bpdu-guard is not enabled on a port.

You can configure a port disabled by the bpdu-guard to re-enable itself after a specific time interval. This interval is set with the [spanning-tree errdisable-timeout interval](#) command. If you do not use the **errdisable-timeout** feature, then you will need to manually re-enable the port by using the **no shutdown** command.

Use the `show spanning-tree` command to display the device and port configurations for the BPDU Guard feature. It shows both the administratively configured and currently running values of `bpdu-guard`.

**Example** To enable STP BPDU guard in Global Configuration mode, enter the below commands:

```
awplus# configure terminal
awplus(config)# spanning-tree portfast bpdu-guard
```

To enable STP BPDU guard in Interface Configuration mode, enter the below commands:

```
awplus# configure terminal
awplus(config)# interface port1.0.2
awplus(config-if)# spanning-tree portfast bpdu-guard enable
```

**Related commands**

- `spanning-tree edgeport (RSTP and MSTP)`
- `show spanning-tree`
- `spanning-tree portfast (STP)`
- `spanning-tree portfast bpdu-filter`

# spanning-tree priority (bridge priority)

**Overview** Use this command to set the bridge priority for the device. A lower priority value indicates a greater likelihood of the device becoming the root bridge.

Use this command for RSTP, STP or MSTP. When MSTP mode is configured, this will apply to the CIST.

Use the **no** variant of this command to reset it to the default.

**Syntax** `spanning-tree priority <priority>`  
`no spanning-tree priority`

Parameter	Description
<code>&lt;priority&gt;</code>	<code>&lt;0-61440&gt;</code> The bridge priority, which will be rounded to a multiple of 4096.

**Default** The default priority is 32678.

**Mode** Global Configuration

**Usage** To force a particular device to become the root bridge use a lower value than other devices in the spanning tree.

**Example** `awplus# configure terminal`  
`awplus(config)# spanning-tree priority 4096`

**Related commands** [spanning-tree mst instance priority](#)  
[show spanning-tree](#)



# spanning-tree priority (port priority)

**Overview** Use this command in Interface Configuration mode for a switch port interface only to set the port priority for port. A lower priority value indicates a greater likelihood of the port becoming part of the active topology.

Use this command for RSTP, STP, or MSTP. When the device is in MSTP mode, this will apply to the CIST.

Use the **no** variant of this command to reset it to the default.

**Syntax** `spanning-tree priority <priority>`  
`no spanning-tree priority`

Parameter	Description
<code>&lt;priority&gt;</code>	<code>&lt;0-240&gt;</code> , in increments of 16. The port priority, which will be rounded down to a multiple of 16.

**Default** The default priority is 128.

**Mode** Interface Configuration mode for a switch port interface only.

**Usage notes** To force a port to be part of the active topology (for instance, become the root port or a designated port) use a lower value than other ports on the device. (This behavior is subject to network topology, and more significant factors, such as bridge ID.)

**Example**

```
awplus# configure terminal
awplus(config)# interface port1.0.2
awplus(config-if)# spanning-tree priority 16
```

**Related commands**

- [spanning-tree mst instance priority](#)
- [spanning-tree priority \(bridge priority\)](#)
- [show spanning-tree](#)

# spanning-tree restricted-role

**Overview** Use this command in Interface Configuration mode for a switch port interface only to restrict the port from becoming a root port.

Use the **no** variant of this command to disable the restricted role functionality.

**Syntax** `spanning-tree restricted-role`  
`no spanning-tree restricted-role`

**Default** The restricted role is disabled.

**Mode** Interface Configuration mode for a switch port interface only.

**Example** `awplus# configure terminal`  
`awplus(config)# interface port1.0.2`  
`awplus(config-if)# spanning-tree restricted-role`

# spanning-tree restricted-tcn

**Overview** Use this command in Interface Configuration mode for a switch port interface only to prevent TCN (Topology Change Notification) BPDUs (Bridge Protocol Data Units) from being sent on a port. If this command is enabled, after a topology change a bridge is prevented from sending a TCN to its designated bridge.

Use the **no** variant of this command to disable the restricted TCN functionality.

**Syntax** `spanning-tree restricted-tcn`  
`no spanning-tree restricted-tcn`

**Default** The restricted TCN is disabled.

**Mode** Interface Configuration mode for a switch port interface only.

**Example** `awplus# configure terminal`  
`awplus(config)# interface port1.0.2`  
`awplus(config-if)# spanning-tree restricted-tcn`

# spanning-tree transmit-holdcount

**Overview** Use this command to set the maximum number of BPDU transmissions that are held back.

Use the **no** variant of this command to restore the default transmit hold-count value.

**Syntax** `spanning-tree transmit-holdcount`  
`no spanning-tree transmit-holdcount`

**Default** Transmit hold-count default is 3.

**Mode** Global Configuration

**Example** `awplus# configure terminal`  
`awplus(config)# spanning-tree transmit-holdcount`

# undebbug mstp

**Overview** This command applies the functionality of the no `debug mstp` (RSTP and STP) command.

# 16

# Unidirectional Link Detection (UDLD) Commands

## Introduction

**Overview** This chapter provides an alphabetical reference of commands used to configure the Unidirectional Link Detection (UDLD) protocol.

UDLD is a data link protocol which monitors network cables and detects broken bidirectional links. It complements the spanning tree protocol (STP), which is used to eliminate Layer 2 loops.

A license is required to use this feature. Please contact your authorized Allied Telesis representative for more information.

- Command List**
- [“debug udld”](#) on page 583
  - [“show debugging udld”](#) on page 584
  - [“show udld”](#) on page 585
  - [“show udld neighbors”](#) on page 586
  - [“show udld port”](#) on page 587
  - [“udld aggressive-mode”](#) on page 588
  - [“udld enable”](#) on page 589
  - [“udld port”](#) on page 590
  - [“udld port aggressive-mode”](#) on page 591
  - [“udld port disable”](#) on page 592
  - [“udld reset”](#) on page 593
  - [“udld time disable-period”](#) on page 594
  - [“udld time message-interval”](#) on page 595
  - [“undebug udld”](#) on page 596

# debug udld

**Overview** Use this command to enable UDLD debugging.  
Use the **no** variant of this command to disable UDLD debugging.

**Syntax** `debug udld [info|pkt|state|nsm|all]`  
`no debug udld [info|pkt|state|nsm|all]`

Parameter	Description
info	Enable or disable general UDLD debugging information.
pkt	Enable or disable debugging of UDLD packets.
state	Enable or disable UDLD state transition debugging.
nsm	Enable or disable UDLD Network Service Module (NSM) debugging information.
all	Enable or disable the all UDLD debugging.

**Default** Debugging is disabled for **all** by default.

**Mode** Global Configuration  
Privileged Exec

**Example** To enable UDLD packet debugging, use the commands:

```
awplus# configure terminal  
awplus(config)# debug udld pkt
```

**Related commands** [show debugging udld](#)  
[undebug udld](#)

# show debugging udld

**Overview** Use this command to show which UDLD debugging options are set.

**Syntax** show debugging udld

**Mode** Privileged Exec

**Example** To show which UDLD debugging options are set, use the command:

```
awplus# show debugging udld
```

**Output** Figure 16-1: Example output from **show debugging udld**

```
awplus# show debugging udld
UDLD debugging status:
  Info debugging   : off
  Packet debugging: off
  State debugging  : on
  NSM debugging    : off
```

**Related commands** [debug udld](#)



# show udld

**Overview** Use this command to display global UDLD status and configuration settings.

**Syntax** show udld

**Mode** Privileged Exec

**Example** To show global UDLD information, use the command:

```
awplus# show udld
```

**Output** Figure 16-2: Example output from **show udld**

```
awplus#show udld
Status          : Enabled
Mode            : Normal
Message-Interval: 7 seconds
Timeout-Interval: 5 seconds
Disable-Period  : 15 seconds

[Fiber-Ports]
Port           Status   Mode      Directional-State
-----
port1.0.1     Enabled  Aggressive Bidirectional
port1.0.2     Disabled Normal     -
```

**Related commands**

- [udld port](#)
- [udld port disable](#)
- [udld enable](#)

# show udld neighbors

**Overview** Use this command to display UDLD neighbor status.

**Syntax** `show udld neighbors [<interface-name>] [detail]`

Parameter	Description
<interface-name>	Show UDLD neighbor information for a specified interface.
detail	This option provides a greater level of detail.

**Mode** Privileged Exec

**Example** To show UDLD information for all neighbors, use the command:

```
awplus# show udld neighbors
```

To show detailed UDLD neighbor information for port1.0.1, use the command:

```
awplus# show udld neighbours port1.0.1 detail
```

**Output** Figure 16-3: Example output from **show udld neighbors**

```
awplus#show udld neighbors
```

Port	Device-ID	Port-ID	Device-Name	Neighbor-State
port1.0.1	0000F4272DA2	port2.0.1	X930	Bidirectional
port1.0.2	0000F5572632	port1.0.15	X610	Bidirectional

Figure 16-4: Example output from **show udld neighbor port1.0.1 detail**

```
awplus# show udld neighbor port1.0.1 detail
[port1.0.1]
Device-ID       : 0000F4272DA2
Port-ID        : port2.0.1
Device-Name    : X930
Operational-State: Bidirectional
Expiration-time : 35 seconds
Message-Interval : 15 seconds
Timeout-Interval : 5 seconds

Neighbors in Echo:
Device-ID      Port-ID
-----
0000F4272DA2 port2.0.1
0000F5572632 port1.0.15
```

**Related commands**

- [udld port](#)
- [udld port disable](#)
- [udld enable](#)

# show udld port

**Overview** Use this command to display UDLD port status and configuration settings.

**Syntax** show udld port [*<interface-name>*] [detail]

Parameter	Description
<i>&lt;interface-name&gt;</i>	Show UDLD information for a specified interface.
detail	This option provides a greater level of detail.

**Mode** Privileged Exec

**Example** To show UDLD information for all ports, use the command:

```
awplus# show udld port
```

To show detailed UDLD information for port1.0.1, use the command:

```
awplus# show udld port port1.0.1 detail
```

**Output** Figure 16-5: Example output from **show udld port**

```
awplus#show udld port
Port          Status   Mode      Directional-State
-----
port1.0.1     Enabled  Aggressive Bidirectional
port1.0.2     Disabled Normal     -
```

Figure 16-6: Example output from **show udld port port1.0.1 detail**

```
awplus#show udld port port1.0.1 detail
[port1.0.1]
Status          : Enabled
Mode            : Aggressive
Directional-State: Bidirectional
Operational-State: Advertisement - single neighbor detected

Neighbors:
Device-ID      Port-ID      Device-Name   Directional-State
-----
0000F4272DA2  port2.0.1   awplus       Bidirectional
```

**Related commands**

- [udld port](#)
- [udld port disable](#)
- [udld enable](#)

# udld aggressive-mode

**Overview** Use this command to set UDLD to aggressive mode on all interfaces.

In **normal mode**, when the UDLD information times out:

- No action is taken by UDLD.
- The UDLD port state is set to undetermined.
- The port behaves according to its STP state.

In **aggressive mode**, when the UDLD information times out:

- UDLD tries to re-establish the state of the port.
- If not successful, after 8 retries, the port is disabled.

Use the **no** variant of this command to disable aggressive mode on all interfaces.

**Syntax** `udld aggressive-mode`  
`no udld aggressive-mode`

**Default** Aggressive mode is disabled by default.

**Mode** Global Configuration

**Example** To enable aggressive mode on interfaces, use the commands:

```
awplus# configure terminal
awplus(config)# udld aggressive-mode
```

To disable aggressive mode, use the commands:

```
awplus# configure terminal
awplus(config)# no udld aggressive-mode
```

**Related commands** [udld port aggressive-mode](#)  
[show udld](#)

# udld enable

**Overview** Use this command to enable UDLD on all of a device's fiber-optic ports. It has no effect on copper ports. Use the [udld port](#) command to enable UDLD on copper ports.

Use the **no** variant of this command to disable the UDLD feature on all of a device's fiber interfaces.

**Syntax** `udld enable`  
`no udld enable`

**Default** UDLD is disabled by default.

**Mode** Global Configuration

**Example** To enable the UDLD feature on all fiber interfaces, use the command:

```
awplus# configure terminal
awplus(config)# udld enable
```

**Related commands**

- [show udld](#)
- [show udld neighbors](#)
- [udld aggressive-mode](#)
- [udld port](#)
- [udld port disable](#)
- [udld reset](#)
- [udld time disable-period](#)
- [udld time message-interval](#)

# udld port

**Overview** Use this command to enable UDLD on an interface. This command enables UDLD on both copper and fiber ports.

Use the **no** variant of this command to disable UDLD on an interface.

**Syntax** `udld port`  
`no udld port`

**Default** UDLD is disabled on an interface by default.

**Mode** Interface Configuration

- Usage notes**
- This command always enables the UDLD feature on a port.
  - The `udld port disable` command overwrites this command and disables UDLD on an interface.
  - If UDLD has been set globally, using the `udld enable` command, then AlliedWare Plus ignores the **no udld port** command on a fiber interface.

**Example** To enable UDLD on port1.0.1, use the commands:

```
awplus# configure terminal
awplus(config)# interface port1.0.1
awplus(config-if)# udld port
```

To disable UDLD on port1.0.1, use the commands:

```
awplus# configure terminal
awplus(config)# interface port1.0.1
awplus(config-if)# no udld port
```

**Related commands**

- `show udld port`
- `show udld neighbors`
- `udld enable`
- `udld port disable`
- `udld reset`
- `udld time disable-period`
- `udld time message-interval`

# udld port aggressive-mode

**Overview** Use this command to enable UDLD aggressive mode on an interface.

In **normal mode**, when the UDLD information times out:

- No action is taken by UDLD.
- The UDLD port state is set to undetermined.
- The port behaves according to its STP state.

In **aggressive mode**, when the UDLD information times out:

- UDLD tries to re-establish the state of the port.
- If not successful, after 8 retries, the port is disabled.

Use the **no** variant of this command to disable aggressive mode on an interface.

**Syntax** `udld port aggressive-mode`  
`no udld port aggressive-mode`

**Default** Aggressive mode is disabled on an interface by default.

**Mode** Interface Configuration

**Example** To change the UDLD mode to aggressive on port1.0.1, use the commands:

```
awplus# configure terminal
awplus(config)# interface port1.0.1
awplus(config-if)# udld port aggressive-mode
```

To disable aggressive mode on port1.0.1, use the commands:

```
awplus# configure terminal
awplus(config)# interface port1.0.1
awplus(config-if)# no port aggressive-mode
```

**Related commands** [udld aggressive-mode](#)  
[show udld port](#)

# udld port disable

**Overview** Use this command to disable UDLD on an interface. This command disables UDLD on both copper and fiber ports

Use the **no** variant of this command to allow UDLD on a fiber port.

**Syntax** `udld port disable`  
`no udld port disable`

**Default** UDLD disable is not set by default.

- Usage notes**
- This command always disables the UDLD feature on a port.
  - The `udld port` command overwrites this command and enables UDLD on an interface.
  - If UDLD has been set globally, using the `udld enable` command, then AlliedWare Plus ignores the **no udld port** command on a fiber interface.

**Mode** Interface Configuration

**Example** To disable UDLD on port1.0.1, use the commands:

```
awplus# configure terminal
awplus(config)# interface port1.0.1
awplus(config-if)# udld port disable
```

To enable UDLD on port1.0.1, use the commands:

```
awplus# configure terminal
awplus(config)# interface port1.0.1
awplus(config-if)# no udld port disable
```

**Related commands** `udld enable`  
`udld port`  
`show udld port`



# udld reset

**Overview** Use this command to reset the status of any interface disabled by UDLD.

**Syntax** `udld reset`

**Mode** Global Configuration

**Example** To reset an interface that has been disabled by UDLD, use the commands:

```
awplus# configure terminal
awplus(config)# udld reset
```

**Output** Figure 16-7: Example output from **udld reset**, when 2 ports are disabled

```
awplus#udld reset
2 ports disabled by udld reset
```

Figure 16-8: Example output from **udld reset**, when no ports are disabled

```
awplus#udld reset
No ports are disabled by udld reset
```

**Related commands** [show udld](#)  
[udld enable](#)

# udld time disable-period

**Overview** Use this command to set the UDLD disable period on all interfaces. The disable period is the time (in seconds) that a port is marked disabled before UDLD attempts to recheck it.

Manually reset the UDLD status of a port using the [udld reset](#) command.

Use the **no** variant of this command to reset the disable period to infinite.

**Syntax** `udld time disable-period <seconds>`  
`no udld time disable-period`

Parameter	Description
<code>&lt;seconds&gt;</code>	30-86400 Specify the disable period in seconds.

**Default** The default time disable period is infinite.

**Mode** Global Configuration

**Example** To change the UDLD disable period to 60 sec on all interfaces, use the commands:

```
awplus# configure terminal
awplus(config)# udld time disable-period 60
```

To reset the disable period to infinite, use the commands:

```
awplus# configure terminal
awplus(config)# no udld time disable-period
```

**Related commands** [udld enable](#)  
[udld port](#)  
[show udld](#)

# udld time message-interval

**Overview** Use this command to set the UDLD message send interval on all interfaces.

This is the time, in seconds, between UDLD probe messages.

Use the **no** variant of this command to reset the message send interval to 15 seconds.

**Syntax** `udld time message-interval <seconds>`  
`no udld time message-interval`

Parameter	Description
<code>&lt;seconds&gt;</code>	7-90 Specify the message send interval in seconds.

**Default** The default message send interval is 15 seconds.

**Mode** Global Configuration

**Example** To change UDLD message sending interval to 30 sec on all interfaces, use the commands:

```
awplus# configure terminal  
awplus(config)# udld time message-interval 30
```

To reset the message sending interval to 15 seconds, use the commands:

```
awplus# configure terminal  
awplus(config)# no udld time message-interval
```

**Related commands** [udld enable](#)  
[udld port](#)  
[show udld](#)

# undebbug udlld

**Overview** This command applies the functionality of the **no debug udlld** command.

# 17

# Link Aggregation Commands

## Introduction

**Overview** This chapter provides an alphabetical reference of commands used to configure a static channel group (static aggregator) and dynamic channel group (LACP channel group, etherchannel or LACP aggregator). Link aggregation is also sometimes referred to as channeling.

**NOTE:** *AlliedWare Plus™ supports IEEE 802.3ad link aggregation and uses the Link Aggregation Control Protocol (LACP). LACP does not interoperate with devices that use Port Aggregation Protocol (PAgP).*

*Link aggregation does not necessarily achieve exact load balancing across the links. The load sharing algorithm is designed to ensure that any given data flow always goes down the same link. It also aims to spread data flows across the links as evenly as possible.*

*For example, for a 2 Gbps LAG that is a combination of two 1 Gbps ports, any one flow of traffic can only ever reach a maximum throughput of 1 Gbps. However, the hashing algorithm should spread the flows across the links so that when many flows are operating, the full 2 Gbps can be utilized.*

*For information about load balancing see the [platform load-balancing](#) command.*

For a description of static and dynamic link aggregation (LACP), and configuration examples, see the [Link Aggregation Feature Overview and Configuration Guide](#).

- Command List**
- [“channel-group”](#) on page 599
  - [“clear lacp counters”](#) on page 601
  - [“debug lacp”](#) on page 602
  - [“lacp global-passive-mode enable”](#) on page 603
  - [“lacp port-priority”](#) on page 604
  - [“lacp system-priority”](#) on page 605
  - [“lacp timeout”](#) on page 606
  - [“platform load-balancing”](#) on page 608

- [“show debugging lacp”](#) on page 609
- [“show diagnostic channel-group”](#) on page 610
- [“show etherchannel”](#) on page 612
- [“show etherchannel detail”](#) on page 613
- [“show etherchannel summary”](#) on page 614
- [“show lacp sys-id”](#) on page 615
- [“show lacp-counter”](#) on page 616
- [“show port etherchannel”](#) on page 617
- [“show static-channel-group”](#) on page 618
- [“static-channel-group”](#) on page 619
- [“undebbug lacp”](#) on page 621

# channel-group

**Overview** Use this command to create a dynamic channel group, or to add a port to an existing dynamic channel group.

You can create up to 128 channel groups, in any combination of static and dynamic (LACP) groups. This means you can create up to 128 dynamic channel groups, if you have no static channel groups.

Use the **no** variant of this command to turn off link aggregation on the device port. You will be returned to Global Configuration mode from Interface Configuration mode.

**Syntax** `channel-group <dynamic-channel-group-number> mode {active|passive}`  
`no channel-group`

Parameter	Description
<code>&lt;dynamic-channel-group-number&gt;</code>	<1-248> Dynamic channel group number for an LACP link. You can create up to 128 dynamic channel groups, numbered in the range 1-248.
<code>active</code>	Enables initiation of LACP negotiation on a port. The port will transmit LACP dialogue messages whether or not it receives them from the partner device.
<code>passive</code>	Disables initiation of LACP negotiation on a port. The port will only transmit LACP dialogue messages if the partner device is transmitting them, i.e., the partner is in the active mode.

**Mode** Interface Configuration

**Usage notes** All the device ports in a channel-group must belong to the same VLANs, have the same tagging status, and can only be operated on as a group. All device ports within a channel group must have the same port speed and be in full duplex mode.

Once the LACP channel group has been created, it is treated as a device port. You can specify it in other commands. If you are specifying it in:

- an LACP command, then use the channel-group number on its own. For example, use the command **show etherchannel 2** to show details about channel group 2.
- a non-LACP command, then use **po** followed by the channel-group number. For example, use the command **show interface po2** to show details about channel group 2's interface.

For more information about LACP, see the [Link Aggregation Feature Overview and Configuration Guide](#) which is available on our website at [alliedtelesis.com](#).

**Examples** To add device port1.0.2 to a newly created LACP channel group 2, in active mode, use the commands below:

```
awplus# configure terminal
awplus(config)# interface port1.0.2
awplus(config-if)# channel-group 2 mode active
```

To remove device port1.0.2 from any created LACP channel groups, use the command below:

```
awplus# configure terminal
awplus(config)# interface port1.0.2
awplus(config-if)# no channel-group
```

To reference channel group 2 as an interface, use the following commands:

```
awplus# configure terminal
awplus(config)# interface po2
awplus(config-if)#
```

**Related commands**

- [show etherchannel](#)
- [show etherchannel detail](#)
- [show etherchannel summary](#)
- [show port etherchannel](#)

**Command changes** Version 5.4.9-0.1: Ability added to create up to 128 groups as any combination of static and dynamic channel groups. Also, numbering changed to 1-248.



# clear lacp counters

**Overview** Use this command to clear all counters of all present LACP aggregators (channel groups) or a given LACP aggregator.

**Syntax** `clear lacp [<1-248>] counters`

Parameter	Description
<1-248>	Channel-group number.

**Mode** Privileged Exec

**Example** `awplus# clear lacp 2 counters`

# debug lacp

**Overview** Use this command to enable all LACP troubleshooting functions.

Use the **no** variant of this command to disable this function.

**Syntax** `debug lacp {all|cli|event|ha|packet|sync|timer[detail]}`  
`no debug lacp {all|cli|event|ha|packet|sync|timer[detail]}`

Parameter	Description
all	Turn on all debugging for LACP.
cli	Specifies debugging for CLI messages. Echoes commands to the console.
event	Specifies debugging for LACP events. Echoes events to the console.
ha	Specifies debugging for HA (High Availability) events. Echoes High Availability events to the console.
packet	Specifies debugging for LACP packets. Echoes packet contents to the console.
sync	Specifies debugging for LACP synchronization. Echoes synchronization to the console.
timer	Specifies debugging for LACP timer. Echoes timer expiry to the console.
detail	Optional parameter for LACP timer-detail. Echoes timer start/stop details to the console.

**Mode** Privileged Exec and Global Configuration

**Examples** `awplus# debug lacp timer detail`  
`awplus# debug lacp all`

**Related commands** [show debugging lacp](#)  
[undebug lacp](#)

# lacp global-passive-mode enable

**Overview** Use this command to enable LACP channel-groups to dynamically self-configure when they are connected to another device that has LACP channel-groups configured with Active Mode.

**Syntax** lacp global-passive-mode enable  
no lacp global-passive-mode enable

**Default** Enabled

**Mode** Global Configuration

**Usage notes** Do not mix LACP configurations (manual and dynamic). When LACP global passive mode is turned on (by using the **lacp global-passive-mode enable** command), we do not recommend using a mixed configuration in a LACP channel-group; i.e. some links are manually configured (by the **channel-group** command) and others are dynamically learned in the same channel-group.

**Example** To enable global passive mode for LACP channel groups, use the command:

```
awplus(config)# lacp global-passive-mode enable
```

To disable global passive mode for LACP channel groups, use the command:

```
awplus(config)# no lacp global-passive-mode enable
```

**Related commands** [show etherchannel](#)  
[show etherchannel detail](#)

# lacp port-priority

**Overview** Use this command to set the priority of a device port. Ports are selected for aggregation based on their priority, with the higher priority (numerically lower) ports selected first.

Use the **no** variant of this command to reset the priority of port to the default.

**Syntax** lacp port-priority <1-65535>  
no lacp port-priority

Parameter	Description
<1-65535>	Specify the LACP port priority.

**Default** The default is 32768.

**Mode** Interface Configuration

**Example** awplus# configure terminal  
awplus(config)# interface port1.0.2  
awplus(config-if)# lacp port-priority 34

# lacp system-priority

**Overview** Use this command to set the system priority of a local system. This is used in determining the system responsible for resolving conflicts in the choice of aggregation groups.

Use the **no** variant of this command to reset the system priority of the local system to the default.

**Syntax** lacp system-priority <1-65535>  
no lacp system-priority

Parameter	Description
<1-65535>	LACP system priority. Lower numerical values have higher priorities.

**Default** The default is 32768.

**Mode** Global Configuration

**Example** awplus# configure terminal  
awplus(config)# lacp system-priority 6700

# lacp timeout

**Overview** Use this command to set the short or long timeout on a port. Ports will time out of the aggregation if three consecutive updates are lost.

**Syntax** lacp timeout {short|long}

Parameter	Description
timeout	Number of seconds before invalidating a received LACP data unit (DU).
short	LACP short timeout. The <b>short</b> timeout value is <b>1</b> second.
long	LACP long timeout. The <b>long</b> timeout value is <b>30</b> seconds.

**Default** The default is **long** timeout (30 seconds).

**Mode** Interface Configuration

**Usage notes** This command enables the device to indicate the rate at which it expects to receive LACPDUs from its neighbor.

If the timeout is set to **long**, then the device expects to receive an update every **30** seconds, and this will time a port out of the aggregation if no updates are seen for 90 seconds (i.e. 3 consecutive updates are lost).

If the timeout is set to **short**, then the device expects to receive an update every second, and this will time a port a port out of the aggregation if no updates are seen for 3 seconds (i.e. 3 consecutive updates are lost).

The device indicates its preference by means of the Timeout field in the Actor section of its LACPDUs. If the Timeout field is set to 1, then the device has set the **short** timeout. If the Timeout field is set to 0, then the device has set the **long** timeout.

Setting the **short** timeout enables the device to be more responsive to communication failure on a link, and does not add too much processing overhead to the device (1 packet per second).

**NOTE:** It is not possible to configure the rate that the device sends LACPDUs; the device must send at the rate which the neighbor indicates it expects to receive LACPDUs.

**Examples** The following commands set the LACP long timeout period for 30 seconds on port1.0.2.

```
awplus# configure terminal
awplus(config)# interface port1.0.2
awplus(config-if)# lacp timeout long
```

The following commands set the LACP short timeout for 1 second on port1.0.2.

```
awplus# configure terminal
awplus(config)# interface port1.0.2
awplus(config-if)# lacp timeout short
```

# platform load-balancing

**Overview** This command selects which address fields are used as inputs into the load balancing algorithm for aggregated links. The output from this algorithm is used to select which individual path a given packet will traverse within an aggregated link.

The **no** variant of this command applies its default setting.

**Syntax** `platform load-balancing {src-dst-mac|src-dst-ip}`  
`no platform load-balancing`

Parameter	Description
<code>src-dst-mac</code>	Include the source and destination MAC addresses (Layer 2)
<code>src-dst-ip</code>	Include the source and destination IP addresses (Layer 3) and UDP/TCP source and destination ports. If you choose this option, the algorithm will use MAC addresses to calculate load balancing for Layer 2 and non-IP packets.

**Default** The default is **src-dst-ip**.

**Mode** Global configuration

**Examples** To set the load balancing algorithm to include only Layer 2 MAC addresses, use the commands:

```
awplus# configure terminal
awplus(config)# platform load-balancing src-dst-mac
```

To set the load balancing algorithm to include only Layer 3 IP addresses and Layer 4 ports, use the commands:

```
awplus# configure terminal
awplus(config)# platform load-balancing src-dst-ip
```

**Related commands** [show platform](#)



# show debugging lacp

**Overview** Use this command to see what debugging is turned on for LACP management. For information on filtering and saving command output, see the [“Getting Started with AlliedWare Plus” Feature Overview and Configuration Guide](#).

**Syntax** `show debugging lacp`

**Mode** User Exec and Privileged Exec

**Example** `awplus# show debugging lacp`

**Output** Figure 17-1: Example output from the **show debugging lacp** command

```
LACP debugging status:
LACP timer debugging is on
LACP timer-detail debugging is on
LACP cli debugging is on
LACP packet debugging is on
LACP event debugging is on
LACP sync debugging is on
```

**Related commands** [debug lacp](#)

# show diagnostic channel-group

**Overview** This command displays dynamic and static channel group interface status information. The output of this command is useful for Allied Telesis authorized service personnel for diagnostic purposes.

For information on filtering and saving command output, see the [“Getting Started with AlliedWare Plus” Feature Overview and Configuration Guide](#).

**Syntax** `show diagnostic channel-group`

**Mode** User Exec and Privileged Exec

**Example** `awplus# show diagnostic channel-group`

**Output** Figure 17-2: Example output from the **show diagnostic channel-group** command

```
awplus#show diagnostic channel-group

Channel Group Info based on NSM:
Note: Pos - position in hardware table
-----
Dev  Interface  IfIndex  Member port  IfIndex  Active  Pos
-----
    sa3        4503    port1.0.15   5015        No
    sa3        4503    port1.0.18   5018        No
    po1        4601    port1.0.7    5007        No
    po1        4601    port1.0.8    5008        No
    po1        4601    port1.0.9    5009        No

Channel Group Info based on HSL:
Note: Pos - position in hardware table
-----
Dev  Interface  IfIndex  Member port  IfIndex  Active  Pos
-----
    sa3        4503                N/a
    po1        4601                N/a

Channel Group Info based on IPIFWD:
Note: Pos - position in hardware table
-----
Dev  Interface  IfIndex  Member port  IfIndex  Active  Pos
-----
    sa3        4503                N/a
    po1        4601                N/a
```

```
Channel Group Info based on HW:
Note: Pos - position in hardware table
      Only entries from first device are displayed.
-----
Dev  Interface  IfIndex  Member port  IfIndex  Active  Pos
-----
      sa3       4503                N/a
      po1       4601                N/a

No error found
```

**Related commands** [show tech-support](#)

# show etherchannel

**Overview** Use this command to display information about an LACP channel specified by the channel group number.

The command output also shows the thrash limiting status. If thrash limiting is detected and the **action** parameter of the **thrash-limiting** command is set to **vlan-disable**, the output will also show the VLANs on which thrashing is detected.

For information on filtering and saving command output, see the [“Getting Started with AlliedWare Plus” Feature Overview and Configuration Guide](#), which is available on our website at [alliedtelesis.com](http://alliedtelesis.com).

**Syntax** show etherchannel [*<1-248>*]

Parameter	Description
<i>&lt;1-248&gt;</i>	Channel-group number.

**Mode** User Exec and Privileged Exec

**Example** awplus# show etherchannel

**Output** Figure 17-3: Example output from **show etherchannel**

```
awplus#show etherchannel
LAG Maximum      : 128
LAG Static Count : 0
LAG Dynamic Count : 1
LAG Total Count  : 1
Lacp Aggregator: pol
Member:
  port1.0.1
  port1.0.2
```

**Example** awplus# show etherchannel 1

**Output** Figure 17-4: Example output from **show etherchannel** for a particular channel

```
awplus#show etherchannel 1
Aggregator pol (4601)
Mac address: 00:00:00:00:00:00
Admin Key: 0001 - Oper Key 0000
Receive link count: 0 - Transmit link count: 0
Individual: 0 - Ready: 0
Partner LAG: 0x0000,00-00-00-00-00-00
  Link: port1.0.1 (5001) disabled
  Link: port1.0.2 (5002) disabled
```

# show etherchannel detail

**Overview** Use this command to display detailed information about all LACP channels. For information on filtering and saving command output, see the [“Getting Started with AlliedWare Plus” Feature Overview and Configuration Guide](#), which is available on our website at [alliedtelesis.com](http://alliedtelesis.com).

**Syntax** `show etherchannel detail`

**Mode** User Exec and Privileged Exec

**Example** `awplus# show etherchannel detail`

**Output** Example output from **show etherchannel detail**

```
awplus#show etherchannel detail
Aggregator po1 (IfIndex: 4601)
  Mac address: 00:00:cd:37:05:17
  Admin Key: 0001 - Oper Key 0001
  Receive link count: 2 - Transmit link count: 2
  Individual: 0 - Ready: 1
  Partner LAG: 0x8000,00-00-cd-37-02-9a,0x0001
    Link: port1.0.1 (IfIndex: 8002) synchronized
    Link: port1.0.2 (IfIndex: 20002) synchronized
Aggregator po2 (IfIndex: 4602)
  Mac address: 00:00:cd:37:05:17
  Admin Key: 0002 - Oper Key 0002
  Receive link count: 2 - Transmit link count: 2
  Individual: 0 - Ready: 1
  Partner LAG: 0x8000,ec-cd-6d-aa-c8-56,0x0002
    Link: port1.0.3 (IfIndex: 8001) synchronized
    Link: port1.0.4 (IfIndex: 20001) synchronized
```

# show etherchannel summary

**Overview** Use this command to display a summary of all LACP channels.

For information on filtering and saving command output, see the [“Getting Started with AlliedWare Plus” Feature Overview and Configuration Guide](#), which is available on our website at [alliedtelesis.com](http://alliedtelesis.com).

**Syntax** `show etherchannel summary`

**Mode** User Exec and Privileged Exec

**Example** `awplus# show etherchannel summary`

**Output** Example output from **show etherchannel summary**

```
awplus#show etherchannel summary
Aggregator po10 (IfIndex: 4610)
Admin Key: 0010 - Oper Key 0010
  Link: port1.0.1 (IfIndex: 7007) synchronized
  Link: port1.0.2 (IfIndex: 8007) synchronized
  Link: port1.0.3 (IfIndex: 11007) synchronized
```

# show lacp sys-id

**Overview** Use this command to display the LACP system ID and priority.

For information on filtering and saving command output, see the [“Getting Started with AlliedWare Plus” Feature Overview and Configuration Guide](#), which is available on our website at [alliedtelesis.com](http://alliedtelesis.com).

**Syntax** `show lacp sys-id`

**Mode** User Exec and Privileged Exec

**Example** `awplus# show lacp sys-id`

**Output** Example output from **show lacp sys-id**

```
System Priority: 0x8000 (32768)
MAC Address: 0200.0034.5684
```

# show lacp-counter

**Overview** Use this command to display the packet traffic on all ports of all present LACP aggregators, or a given LACP aggregator.

For information on filtering and saving command output, see the [“Getting Started with AlliedWare Plus” Feature Overview and Configuration Guide](#), which is available on our website at [alliedtelesis.com](http://alliedtelesis.com).

**Syntax** `show lacp-counter [<1-248>]`

Parameter	Description
<1-248>	Channel-group number.

**Mode** User Exec and Privileged Exec

**Example** `awplus# show lacp-counter 2`

**Output** Example output from **show lacp-counter**

```
% Traffic statistics
Port          LACPDU      Marker      Pckt err
              Sent   Recv   Sent   Recv   Sent   Recv
% Aggregator po2 (IfIndex: 4604)
port1.0.2    0       0       0       0       0       0
```



# show port etherchannel

**Overview** Use this command to show LACP details of the device port specified.

For information on filtering and saving command output, see the [“Getting Started with AlliedWare Plus” Feature Overview and Configuration Guide](#), which is available on our website at [alliedtelesis.com](http://alliedtelesis.com).

**Syntax** show port etherchannel <port>

Parameter	Description
<port>	Name of the device port to display LACP information about.

**Mode** User Exec and Privileged Exec

**Example** awplus# show port etherchannel port1.0.2

**Output** Example output from **show port etherchannel**

```
awplus#show port etherchannel port1.0.2
LACP link info: port1.0.2 - 7007
Link: port1.0.2 (IfIndex: 7007)
Aggregator: po10 (IfIndex: 4610)
Receive machine state: Current
Periodic Transmission machine state: Slow periodic
Mux machine state: Collecting/Distributing
Actor Information:
Selected ..... Selected
Physical Admin Key ..... 2
Port Key ..... 10
Port Priority ..... 32768
Port Number ..... 7007
Mode ..... Active
Timeout ..... Long
Individual ..... Yes
Synchronised ..... Yes
Collecting ..... Yes
Distributing ..... Yes
Defaulted ..... No
Expired ..... No
Partner Information:
Partner Sys Priority ..... 0x8000
Partner System .. ec-cd-6d-d1-64-d0
Port Key ..... 10
Port Priority ..... 32768
Port Number ..... 5001
Mode ..... Active
Timeout ..... Long
Individual ..... Yes
Synchronised ..... Yes
Collecting ..... Yes
Distributing ..... Yes
Defaulted ..... No
Expired ..... No
```

# show static-channel-group

**Overview** Use this command to display all configured static channel groups and their corresponding member ports. Note that a static channel group is the same as a static aggregator.

The command output also shows the thrash limiting status. If thrash limiting is detected and the **action** parameter of the [thrash-limiting](#) command is set to **vlan-disable**, the output will also show the VLANs on which thrashing is detected.

For information on filtering and saving command output, see the [“Getting Started with AlliedWare Plus” Feature Overview and Configuration Guide](#), which is available on our website at [alliedtelesis.com](http://alliedtelesis.com).

**Syntax** `show static-channel-group`

**Mode** User Exec and Privileged Exec

**Example** `awplus# show static-channel-group`

**Output** Example output from **show static-channel-group**

```
% LAG Maximum      : 128
% LAG Static Count  : 2
% LAG Dynamic Count : 0
% LAG Total Count   : 2
% Static Aggregator: sa2
% Member:
  port1.0.1
port1.0.2
% Static Aggregator: sa3
% Member:
  port1.0.3
port1.0.4
```

**Related commands** [static-channel-group](#)

# static-channel-group

**Overview** Use this command to create a static channel group, or to add a port to an existing static channel group. Static channel groups are also known as static aggregators.

You can create up to 128 channel groups, in any combination of static and dynamic (LACP) groups. This means you can create up to 128 static channel groups, if you have no dynamic channel groups.

Use the **no** variant of this command to remove the device port from the static channel group.

**Syntax** `static-channel-group <static-channel-group-number>`  
`[member-filters]`  
  
`no static-channel-group`

Parameter	Description
<code>&lt;static-channel-group-number&gt;</code>	<1-248> Static channel group number. You can create up to 128 static channel groups, numbered in the range 1-248.
<code>member-filters</code>	Allow QoS and ACL settings to be configured on the aggregator's individual member ports, instead of the aggregator itself. This configuration is required when using QoS Storm Protection on a static aggregator.

**Mode** Interface Configuration

**Usage notes** This command adds the device port to the static channel group with the specified channel group number. If the channel group does not exist, it is created, and the port is added to it. The **no** prefix detaches the port from the static channel group. If the port is the last member to be removed, the static channel group is deleted.

All the ports in a channel group must have the same VLAN configuration: they must belong to the same VLANs and have the same tagging status, and can only be operated on as a group.

Once the static channel group has been created, it is treated as a device port. You can specify it in other commands by using **sa** followed by the channel-group number. For example, use the command **show interface sa2** to show details about channel group 2's interface:

**Examples** To define static channel group 2 on port1.0.2, use the commands:

```
awplus# configure terminal
awplus(config)# interface port1.0.2
awplus(config-if)# static-channel-group 2
```

To reference static channel group 2 as an interface, use the commands:

```
awplus# configure terminal
awplus(config)# interface sa2
awplus(config-if)#
```

To make it possible to use QoS Storm Protection on static channel group 2 on port1.0.2, with an ACL named "test-acl", use the commands:

```
awplus# configure terminal
awplus(config)# interface port1.0.2
awplus(config-if)# static-channel-group 2 member-filters
awplus(config-if)# access-group test-acl
```

**Related commands** [show static-channel-group](#)

**Command changes** Version 5.4.9-0.1: Ability added to create up to 128 groups as any combination of static and dynamic channel groups. Also, numbering changed to 1-248.

# undebbug lacp

**Overview** This command applies the functionality of the no `debug lacp` command.

# 18

# Power over Ethernet Commands

## Introduction

**Overview** This chapter contains an alphabetical list of commands used to configure Power over Ethernet (PoE). Each command contains a functional description and shows examples of configuration and output screens for show commands. These commands are only supported on PoE capable ports. An error message will display on the console if you enter a PoE command on a port that does not support PoE. The following documents offer further information for configuring PoE on AlliedWare Plus switches.

- the [PoE Feature Overview and Configuration\\_Guide](#).
- the [Support for Allied Telesis Enterprise\\_MIBs\\_in AlliedWare Plus](#), for information about which PoE MIB objects are supported.
- the [SNMP Feature Overview and Configuration\\_Guide](#), for information about SNMP traps.

Power over Ethernet (PoE) is a technology allowing devices such as security cameras to receive power over LAN cabling.

The Powered Device (PD) referred to throughout this chapter is a PoE or PoE+ powered device, such as an IP phone or a Wireless Access Point (WAP).

- Command List**
- ["clear power-inline counters interface"](#) on page 624
  - ["debug power-inline"](#) on page 625
  - ["power-inline allow-legacy"](#) on page 627
  - ["power-inline description"](#) on page 628
  - ["power-inline enable"](#) on page 629
  - ["power-inline max"](#) on page 630
  - ["power-inline priority"](#) on page 632
  - ["power-inline usage-threshold"](#) on page 634
  - ["service power-inline"](#) on page 635

- [“show debugging power-inline”](#) on page 636
- [“show power-inline”](#) on page 637
- [“show power-inline counters”](#) on page 640
- [“show power-inline interface”](#) on page 642
- [“show power-inline interface detail”](#) on page 645

# clear power-inline counters interface

**Overview** This command will clear the counters from a specified port, a range of ports, or all ports on the switch. If no ports are entered then PoE counters for all ports are cleared. It will also clear all Power over Ethernet (PoE) counters supported by the Power Ethernet MIB (RFC 3621).

**Syntax** `clear power-inline counters interface [<port-list>]`

Parameter	Description
<code>&lt;port-list&gt;</code>	Selects the port or ports whose counters are to be cleared.

**Mode** Privileged Exec

**Usage notes** The PoE counters are displayed with the [show power-inline counters](#) command.

**Examples** To clear the PoE counters for port1.0.2 only, use the following command:

```
awplus# clear power-inline counters interface port1.0.2
```

To clear the PoE counters for port1.0.5 through port1.0.8, use the following command:

```
awplus# clear power-inline counters interface  
port1.0.5-port1.0.8
```

To clear the PoE counters for all ports, use the following command:

```
awplus# clear power-inline counters interface
```

**Related commands** [show power-inline counters](#)

**Command changes** Version 5.4.8-0.2: added to x550 series products



# debug power-inline

**Overview** This command enables debugging display for messages that are specific to Power over Ethernet (PoE).

Use the **no** variant of this command to disable the specified PoE debugging messages.

**Syntax** `debug power-inline [all|event|info|power]`  
`no debug power-inline [all|event|info|power]`

Parameter	Description
all	Displays all (event, info, nsm, power) debug messages.
event	Displays event debug information, showing any error conditions that may occur during PoE operation.
info	Displays informational level debug information, showing high-level essential debugging, such as information about message types.
power	Displays power management debug information.

**Default** No debug messages are enabled by default.

**Mode** Privileged Exec

**Usage notes** Use the [terminal monitor](#) command to display PoE debug messages on the console.

Use the [show debugging power-inline](#) command to show the PoE debug configuration.

**Examples** To enable PoE debugging and start the display of PoE event and info debug messages on the console, use the following commands:

```
awplus# terminal monitor  
awplus# debug power-inline event info
```

To enable PoE debugging and start the display of all PoE debugging messages on the console, use the following commands:

```
awplus# terminal monitor  
awplus# debug power-inline all
```

To stop the display of PoE info debug messages on the console, use the following command:

```
awplus# no debug power-inline info
```

To disable all PoE debugging and stop the display of any PoE debugging messages on the console, use the following command:

```
awplus# no debug power-inline all
```

**Related commands** [show debugging power-inline](#)  
[terminal monitor](#)

**Command changes** Version 5.4.8-0.2: added to x550 series products

# power-inline allow-legacy

**Overview** This command enables detection of pre-IEEE 802.3af Power Ethernet standard legacy Powered Devices (PDs).

The **no** variant of this command disables detection of pre-IEEE 802.3af Power Ethernet standard legacy Powered Devices (PDs).

**Syntax** `power-inline allow-legacy`  
`no power-inline allow-legacy`

**Default** Detection of legacy PDs is disabled on all ports

**Mode** Global Configuration

**Examples** To enable detection of legacy PDs, use the following commands:

```
awplus# configure terminal
awplus(config)# power-inline allow-legacy
```

To disable detection of legacy PDs, use the following commands:

```
awplus# configure terminal
awplus(config)# no power-inline allow-legacy
```

**Validation Commands** `show power-inline`  
`show running-config power-inline`

**Command changes** Version 5.4.8-0.2: added to x550 series products  
Version 5.4.9-0.1: default changed to "disabled"

# power-inline description

**Overview** This command adds a description for a Powered Device (PD) connected to a PoE port.

The **no** variant of this command clears a previously entered description for a connected PD, resetting the PD description to the default (null).

**Syntax** `power-inline description <pd-description>`  
`no power-inline description`

Parameter	Description
<code>&lt;pd-description&gt;</code>	Description of the PD connected to the PoE capable port (with a maximum 256 character string limit per PD description).

**Default** No description for a connected PD is set by default.

**Mode** Interface Configuration

**Usage notes** Select a PoE port, a list of PoE ports, or a range of PoE ports with the preceding [interface \(to configure\)](#) command. If you specify a range or list of ports they must all be PoE capable ports.

**Examples** To add the description "Desk Phone" for a connected PD on port1.0.2, use the following commands:

```
awplus# configure terminal
awplus(config)# interface port1.0.2
awplus(config-if)# power-inline description Desk Phone
```

To clear the description for the connected PD on port1.0.2, use the following commands:

```
awplus# configure terminal
awplus(config)# interface port1.0.2
awplus(config-if)# no power-inline description
```

**Related commands** [show power-inline interface](#)  
[show running-config <power-inline>](#)

**Command changes** Version 5.4.8-0.2: added to x550 series products

# power-inline enable

**Overview** This command enables Power over Ethernet (PoE) to detect a connected Powered Device (PD) and supply power.

The **no** variant of this command disables PoE functionality on the selected PoE port(s). No power is supplied to a connected PD after PoE is disabled on the selected PoE port(s).

Ports still provide Ethernet connectivity after PoE is disabled.

**Syntax** `power-inline enable`  
`no power-inline enable`

**Default** PoE is enabled by default on all ports

**Mode** Interface Configuration for one or more PoE switchports.

**Usage notes** No PoE log messages are generated for ports on which PoE is disabled.

**Examples** To disable PoE on port1.0.1 to port1.0.4, use the following commands:

```
awplus# configure terminal
awplus(config)# interface port1.0.1-port1.0.4
awplus(config-if)# no power-inline enable
```

To enable PoE on port1.0.1 to port1.0.4, use the following commands:

```
awplus# configure terminal
awplus(config)# interface port1.0.1-port1.0.4
awplus(config-if)# power-inline enable
```

**Related commands** [show power-inline](#)  
[show power-inline interface](#)  
[show power-inline interface detail](#)  
[show running-config power-inline](#)

**Command changes** Version 5.4.8-0.2: added to x550 series products

# power-inline max

**Overview** This command sets the maximum power allocated to a Power over an Ethernet (PoE and PoE+) port. The amount of power actually supplied to the port depends on the power requirements of the connected PD. It is also a function of the total PoE power loading on the switch and the PoE priority set for the port by the [power-inline priority](#) command. However this command (power-inline max) does apply a maximum value to the power that the port is able to supply.

Note that the value set by this command will be the figure the switch will use when apportioning the power budget for its ports. For example, if 15.4 W is assigned to a port whose PD only consumes 5 W, the switch will reserve the full 15.4 W for this port when determining its total power PoE power requirement.

The **no** variant of this command sets the maximum power supplied to a PoE port to the default, which is set to the maximum power limit for the class of the connected Powered Device (PD).

**Syntax** `power-inline max <4000-30000>`  
`no power-inline max`

Parameter	Description
<code>&lt;4000-30000&gt;</code>	The maximum power supplied to a PoE port in milliwatts (mW).

**Default** The switch supplies the maximum power limit for the class of the PD connected to the port by default.

**NOTE:** See the [PoE Feature Overview and Configuration Guide](#) for further information about power classes.

**Mode** Interface Configuration for one or more ports. If you specify a range or list of ports, they must all be PoE capable ports.

**Usage notes** If you select a range of PoE ports in Interface Configuration mode before issuing this command, then each port in the range selected will have the same maximum power value configured.

If a PoE port attempts to draw more than the maximum power, this is logged and all power is removed.

Note that the value entered is rounded up to the next value supported by the hardware. The actual value used is displayed after you enter the command, such as in the following sample console output:

```
awplus#configure terminal
awplus(config)#interface port1.0.1
awplus(config-if)#power-line max 5300
% The maximum power has been rounded to 5450mW in hardware.
```

See the [LLDP Feature Overview and Configuration Guide](#) for information about power monitoring at the PD.

Note the difference in power supplied from the PSE to the power available at the PD due to line loss.

See the [PoE Feature Overview and Configuration Guide](#) for further information about the difference between the power supplied from the PSE and the power available at the PD.

**Examples** To set the maximum power supplied to ports in the range port1.0.1 to port1.0.4 to 6450mW per port, use the following commands:

```
awplus# configure terminal
awplus(config)# interface port1.0.2-port1.0.4
awplus(config-if)# power-inline max 6450
```

To clear the user-configured maximum power supplied to port1.0.1, and revert to using the default maximum power, use the following commands:

```
awplus# configure terminal
awplus(config)# interface port1.0.1
awplus(config-if)# no power-inline max
```

**Related commands** [show power-inline interface](#)  
[show running-config power-inline](#)

**Command changes** Version 5.4.8-0.2: added to x550 series products

# power-inline priority

**Overview** This command sets the Power over Ethernet (PoE) priority level of a PoE port to one of three available priority levels:

- low
- high
- critical

The **no** variant of this command restores the PoE port priority to the default (low).

**Syntax** `power-inline priority {low|high|critical}`  
`no power-inline priority`

Parameter	Description
low	The lowest priority for a PoE enabled port (default). PoE ports set to <b>low</b> only receive power if all the PoE ports assigned to the other two levels are already receiving power.
high	The second highest priority for a PoE enabled port. PoE ports set to <b>high</b> receive power only if all the ports set to <b>critical</b> are already receiving power.
critical	The highest priority for a PoE enabled port. PoE ports set to <b>critical</b> are guaranteed power before any ports assigned to the other two priority levels. Ports assigned to the other priority levels receive power only if all critical ports are receiving power.

**Default** The default priority is **low** for all PoE ports

**Mode** Interface Configuration

**Usage notes** Select a PoE port, a list of PoE ports, or a range of PoE ports with the preceding [interface \(to configure\)](#) command. If you specify a range or list of ports they must all be PoE capable ports.

PoE ports with higher priorities are given power before PoE ports with lower priorities. If the priorities for two PoE ports are the same then the lower numbered PoE port is given power before the higher numbered PoE port.

See the [PoE Feature Overview and Configuration Guide](#) for further information about PoE priority.

**Examples** To set the priority level to high on port1.0.1 to port1.0.4, use the following commands:

```
awplus# configure terminal
awplus(config)# interface port1.0.1-port1.0.4
awplus(config-if)# power-inline priority high
```



To reset the priority level to the default of low on port1.0.1 to port1.0.4, use the following commands:

```
awplus# configure terminal
awplus(config)# interface port1.0.1-port1.0.4
awplus(config-if)# no power-inline priority
```

**Related  
commands**

[power-inline usage-threshold](#)  
[show power-inline](#)  
[show power-inline interface](#)  
[show running-config power-inline](#)

**Command  
changes**

Version 5.4.8-0.2: added to x550 series products

# power-inline usage-threshold

**Overview** This command sets the level at which the switch will issue a message that the power supplied to all Powered Devices (PDs) has reached a critical level of the nominal power rating for the switch. The level is set as a percentage of total available power.

The **no** variant of this command resets the notification usage-threshold to the default (80% of the nominal power rating).

**Syntax** `power-inline usage-threshold <1-99>`  
`no power-inline usage-threshold`

Parameter	Description
<code>&lt;1-99&gt;</code>	The usage-threshold percentage configured with this command.

**Default** The default power usage threshold is 80% of the nominal power rating

**Mode** Global Configuration

**Usage notes** Use the `snmp-server enable trap` command to configure SNMP notification. An SNMP notification is sent when the usage-threshold, as configured in the example, is exceeded.

**Examples** To generate SNMP notifications when power supplied exceeds 70% of the nominal power rating, use the following commands:

```
awplus# configure terminal
awplus(config)# snmp-server enable trap power-inline
awplus(config)# power-inline usage-threshold 70
```

To reset the notification threshold to the default (80% of the nominal power rating), use the following commands:

```
awplus# configure terminal
awplus(config)# no power-inline usage-threshold
```

**Related commands** `snmp-server enable trap`  
`show power-inline interface`  
`show running-config power-inline`

**Command changes** Version 5.4.8-0.2: added to x550 series products

# service power-inline

**Overview** This command enables Power over Ethernet (PoE) globally on the switch, for all PoE ports.

**Syntax** `service power-inline`  
`no service power-inline`

**Default** PoE functionality is enabled by default

**Mode** Global Configuration

**Examples** To disable PoE, use the following commands:

```
awplus# configure terminal  
awplus(config)# no service power-inline
```

To re-enable PoE, if PoE has been disabled, use the following commands:

```
awplus# configure terminal  
awplus(config)# service power-inline
```

**Related commands** [show power-inline](#)  
[show running-config power-inline](#)

**Command changes** Version 5.4.8-0.2: added to x550 series products

# show debugging power-inline

**Overview** This command displays Power over Ethernet (PoE) debug settings.

**Syntax** show debugging power-inline

**Mode** User Exec and Privileged Exec

**Example** To display PoE debug settings, use the following command:

```
awplus# show debugging power-inline
```

**Output** Figure 18-1: Example output from the **show debugging power-inline** command

```
awplus#show debugging power-inline
PoE Debugging status:
PoE Informational debugging is disabled
PoE Event debugging is disabled
PoE Power Management debugging is disabled

PoE NSM debugging is enabled
```

**Related commands** [debug power-inline](#)  
[terminal monitor](#)

**Command changes** Version 5.4.8-0.2: added to x550 series products

# show power-inline

**Overview** This command displays the Power over Ethernet (PoE) status for all ports. For information on filtering and saving command output, see the [“Getting Started with AlliedWare Plus” Feature Overview and Configuration Guide](#).

**Syntax** show power-inline

**Mode** User Exec and Privileged Exec

**Example** To display the PoE status for all ports, use the following command:

```
awplus# show power-inline
```

**Output** Figure 18-2: Example output from **show power-inline**

```
awplus#show power-inline
PoE Status:

Nominal Power: 370W
Power Allocated: 246W

Actual Power Consumption: 151W
Operational Status: On
Power Usage Threshold: 80% (296W)
Power management mode: Static

PoE Interface:
Interface  Admin  Pri  Oper   Power  Device  Class  Max(mW)
port1.0.1  Enabled Low  Powered 3840   n/a     1     4000 [C]
port1.0.2  Enabled High Powered 6720   n/a     2     7000 [C]
port1.0.3  Enabled Low  Powered 14784  n/a     3    15400 [C]
port1.0.4  Enabled Crit Powered 14784  n/a     3    15400 [C]
port1.0.5  Enabled Crit Powered 3840   n/a     1     4000 [C]
...
```

**Table 1:** Parameters in the **show power-inline** command output

Parameter	Description
Nominal Power	The nominal power available on the switch in watts (W).
Power Allocated	The current power allocated in watts (W) that is available to be drawn by any connected Powered Devices (PDs). This is updated every 5 seconds.
Actual Power Consumption	The current power consumption in watts (W) drawn by all connected Powered Devices (PDs). This is updated every 5 seconds.

**Table 1:** Parameters in the **show power-inline** command output (cont.)

Parameter	Description
Operational Status	<p>The operational status of the PSU hardware when this command was issued:</p> <ul style="list-style-type: none"> <li>• <b>On</b> if the PSU is installed and switched on.</li> <li>• <b>Off</b> when the PSU is switched off (an RPS may be connected to the switch to power PoE instead of the PSU).</li> <li>• <b>Fault</b> when there is an issue with the PSU hardware.</li> </ul>
Power Usage Threshold (%)	The configured SNMP trap / log threshold, as configured from a <a href="#">power-inline usage-threshold</a> command.
Power management mode: Static	Indicates that PoE power is allocated statically. By default, each port is allocated the maximum amount of power that is required for the power class of the PD that is attached to that port. Alternatively, you can use the <a href="#">power-inline max</a> command to specify the maximum for a port.
Interface	The PoE port(s) in the format portx.y.z, where x is the device number, y is the module number within the device, and z is the PoE port number within the module.
Admin	The administrative state of PoE on a PoE port, either <b>Enabled</b> or <b>Disabled</b> .
Pri	<p>The current PoE priorities for PoE ports, as configured using the <a href="#">power-inline priority</a> command:</p> <ul style="list-style-type: none"> <li>• <b>Low</b> is the lowest priority (this is the default).</li> <li>• <b>High</b> is the second highest priority.</li> <li>• <b>Crit</b> (critical) is the highest priority.</li> </ul> <p>If the switch cannot supply all ports, it will supply critical ports, then high-priority ports, then low-priority ports.</p>
Oper	<p>The current PoE port state when this command was issued:</p> <ul style="list-style-type: none"> <li>• <b>Powered</b> displays if there is a PD connected and power is being supplied.</li> <li>• <b>Denied</b> displays if supplying power would make the switch go over the power budget.</li> <li>• <b>Off</b> displays if the port is not supplying power but has not been denied power by the switch. This is the default state for ports that are not connected to a PD.</li> <li>• <b>Disabled</b> displays if the PoE port is administratively disabled.</li> <li>• <b>Syncing</b> displays if PoE is still initializing the port when you issue the command.</li> <li>• <b>Fault</b> displays if there is a problem with PoE on the port.</li> <li>• <b>Unknown</b> displays if PoE cannot determine the state of the port.</li> </ul>

**Table 1:** Parameters in the **show power-inline** command output (cont.)

Parameter	Description
Power	The power consumption in milliwatts (mW) for the PoE port when this command was entered.
Device	The description of the connected PD device if a description has been added with the <a href="#">power-inline description</a> command. No description is shown for PDs not configured with the <a href="#">power-inline description</a> command.
Class	The class of the connected PD, if power is being supplied to the PD.
Max (mW)	The power in milliwatts (mW) allocated for the PoE port. Additionally, note the following as displayed per PoE port: <ul style="list-style-type: none"><li>• <b>[U]</b> if the power limit for a port was user configured (with the <a href="#">power-inline max</a> command).</li><li>• <b>[L]</b> if the power limit for a port was supplied by LLDP.</li><li>• <b>[C]</b> if the power limit for a port was supplied by the PD class.</li></ul>

**Related commands** [show power-inline counters](#)  
[show power-inline interface](#)

**Command changes** Version 5.4.8-0.2: added to x550 series products

# show power-inline counters

**Overview** This command displays Power over Ethernet (PoE) event counters for ports on the Power Sourcing Equipment (PSE). The PoE event counters displayed can also be accessed by objects in the PoE MIB (RFC 3621). See [the MIB Objects Feature Overview and Configuration Guide](#) for information about which PoE MIB objects are supported.

For information on filtering and saving command output, see the [“Getting Started with AlliedWare Plus” Feature Overview and Configuration Guide](#).

**Syntax** `show power-inline counters [<port-list>]`

Parameter	Description
<code>&lt;port-list&gt;</code>	Enter the PoE port(s) to display PoE event counters for them.

**Mode** User Exec and Privileged Exec

**Examples** To display all PoE event counters for all PoE ports, use the command:

```
awplus# show power-inline counters
```

To display the PoE event counters for port1.0.1, use the command:

```
awplus# show power-inline counters port1.0.1
```

**Output** Figure 18-3: Example output from the **show power-inline counters** command

```
awplus#show power-inline counters interface -  
PoE Counters:  
Interface      MPSAbsent  Overload  Short  Invalid  Denied  
0              0          0         0      0         0  
0              0          0         0      0         0  
0              0          0         0      0         0
```

**Table 2:** Parameters in the **show power-inline counters** command output

Parameter	Description
Interface	The PoE port(s) in the format portx.y.z, where x is the device number, y is the module number within the device, and z is the PoE port number within the module.
MPSAbsent	The number of instances when the PoE MPS (Maintain Power Signature) signal has been lost. The PoE MPS signal is lost when a PD is disconnected from the PSE. Also increments <code>pethPsePortMPSAbsentCounter</code> in the PoE MIB.



**Table 2:** Parameters in the **show power-inline counters** command output

Parameter	Description
Overload	The number of instances when a PD exceeds its configured power limit (as configured by the <code>power-inline max</code> command). Also increments <code>pethPsePortOverLoadCounter</code> in the PoE MIB.
Short	The number of short circuits that have happened with a PD. Also increments <code>pethPsePortShortCounter</code> in the PoE MIB.
Invalid	The number of times a PD with an Invalid Signature (where the PD has an open or short circuit, or is a legacy PD) is detected. Also increments <code>pethPseInvalidSignatureCounter</code> in the PoE MIB.
Denied	The number of times a PD has been refused power due to power budget limitations for the PSE. Also increments <code>pethPsePortPowerDeniedCounter</code> in the PoE MIB.

**Related commands**

- [clear power-inline counters interface](#)
- [show power-inline](#)
- [show power-inline interface](#)

**Command changes** Version 5.4.8-0.2: added to x550 series products

# show power-inline interface

**Overview** This command displays a summary of Power over Ethernet (PoE) information for specified ports. If no ports are specified then PoE information is displayed for all ports.

For information on filtering and saving command output, see the [“Getting Started with AlliedWare Plus” Feature Overview and Configuration Guide](#).

**Syntax** `show power-inline interface [<port-list>]`

Parameter	Description
<port-list>	Enter the PoE port(s) to display PoE specific information in the show output.

**Mode** User Exec and Privileged Exec

**Example** To display the PoE port-specific information for all PoE ports on the switch, use the following command:

```
awplus# show power-inline interface
```

To display the PoE port specific information for port1.0.1 to port1.0.3, use the following command:

```
awplus# show power-inline interface port1.0.1-port1.0.3
```

**Output** Figure 18-4: Example output from **show power-inline interface**

```
awplus#show power-inline interface port1.0.1-port1.0.3
Interface Admin Pri Oper Power Device Class Max(mW)
port1.0.1 Disabled Low Disabled 0 n/a n/a n/a
port1.0.2 Enabled High Powered 3840 Desk Phone 1 5000 [U]
port1.0.3 Enabled Crit Powered 6720 AccessPoint 2 7000 [C]
```

**Table 3:** Parameters in **show power-inline interface** output

Parameter	Description
Interface	The PoE port(s) in the format portx.y.z, where x is the device number, y is the module number within the device, and z is the PoE port number within the module.
Admin	The administrative state of PoE on a PoE port, either <b>Enabled</b> or <b>Disabled</b> .

**Table 3:** Parameters in **show power-inline interface** output (cont.)

Parameter	Description
Pri	<p>The current PoE priorities for PoE ports on the PSE, as configured from a <a href="#">power-inline priority</a> command:</p> <ul style="list-style-type: none"> <li>• <b>Low</b> displays when the <code>low</code> parameter is issued. The lowest priority for a PoE enabled port (default).</li> <li>• <b>High</b> displays when the <code>high</code> parameter is issued. The second highest priority for a PoE enabled port.</li> <li>• <b>Crit</b> displays when the <code>critical</code> parameter is issued. The highest priority for a PoE enabled port.</li> </ul>
Oper	<p>The current PoE port state when this command was issued:</p> <ul style="list-style-type: none"> <li>• <b>Powered</b> displays if there is a PD connected and power is being supplied.</li> <li>• <b>Denied</b> displays if supplying power would make the switch go over the power budget.</li> <li>• <b>Off</b> displays if the port is not supplying power but has not been denied power by the switch. This is the default state for ports that are not connected to a PD.</li> <li>• <b>Disabled</b> displays if the PoE port is administratively disabled.</li> <li>• <b>Syncing</b> displays if PoE is still initializing the port when you issue the command.</li> <li>• <b>Fault</b> displays if there is a problem with PoE on the port.</li> <li>• <b>Unknown</b> displays if PoE cannot determine the state of the port.</li> </ul>
Power	<p>The power consumption in milliwatts (mW) for the PoE port when this command was entered.</p>
Device	<p>The description of the connected PD device if a description has been added with the <a href="#">power-inline description</a> command. No description is shown for PDs not configured with the <a href="#">power-inline description</a> command.</p>
Class	<p>The class of the connected PD, if power is being supplied to the PD from the PSE. See the <a href="#">PoE Feature Overview and Configuration Guide</a> for further information about power classes.</p>
Max (mW)	<p>The power in milliwatts (mW) allocated for the PoE port. Additionally, note the following is displayed per PoE port:</p> <ul style="list-style-type: none"> <li>• <b>[U]</b> if the power limit for a port was user configured (with the <a href="#">power-inline max</a> command).</li> <li>• <b>[L]</b> if the power limit for a port was supplied by LLDP.</li> <li>• <b>[C]</b> if the power limit for a port was supplied by the PD class.</li> </ul>

**Related commands** [show power-inline](#)  
[show power-inline interface detail](#)

**Command changes** Version 5.4.8-0.2: added to x550 series products

# show power-inline interface detail

**Overview** This command displays detailed information for one or more Power over Ethernet (PoE) ports.

For information on filtering and saving command output, see the [“Getting Started with AlliedWare Plus” Feature Overview and Configuration Guide](#).

**Syntax** `show power-inline interface [<port-list>] detail`

Parameter	Description
<code>&lt;port-list&gt;</code>	Enter the PoE port(s) to display information about only the specified port or ports.

**Mode** User Exec and Privileged Exec

**Usage notes** The power allocated to each port is listed in the **Power allocated** row, and is limited by the maximum power per Powered Device (PD) class, or a user configured power limit.

**Examples** To display detailed PoE port specific information for the port range port1.0.1 to port1.0.2, use the command:

```
awplus# show power-inline interface port1.0.1-port1.0.2 detail
```

**Output** Figure 18-5: Example output from **show power-inline interface detail**

```
awplus#show power-inline interface port1.0.2 detail
Interface port1.0.2
  Powered device type: Access Point #3
  PoE admin: on
  Configured Priority: Low
  Actual Priority: Low
  Detection status: Powered
  Current power consumption: 6720 mW
  Powered device class: 2
  Power allocated: 7000 mW (from powered device class)
  Detection of legacy devices is enabled
  Powered pairs: Data
```

**Table 4:** Parameters in **show power-inline interface detail** output

Parameter	Description
Interface	The PoE port(s) in the format portx.y.z, where x is the device number, y is the module number within the device, and z is the PoE port number within the module.
Powered device type:	The name of the PD, if connected and if power is being supplied to the PD from the PSE, configured with the <a href="#">power-inline description</a> command. <b>n/a</b> displays if a description has not been configured for the PD.
PoE admin	The administrative state of PoE on a PoE capable port, either <b>Enabled</b> or <b>Disabled</b> as configured from the <a href="#">power-inline enable</a> command or the <b>no power-inline enable</b> command respectively.
Priority	The PoE priority of a port, which is either <b>Low</b> , or <b>High</b> , or <b>Critical</b> , as configured by the <a href="#">power-inline priority</a> command.
Detection status:	The current PSE PoE port state when this command was issued: <ul style="list-style-type: none"> <li>• <b>Powered</b> displays when there is a PD connected and power is being supplied from the PSE.</li> <li>• <b>Denied</b> displays when supplying power would make the PSE go over the power budget.</li> <li>• <b>Disabled</b> displays when the PoE port is administratively disabled.</li> <li>• <b>Off</b> displays when PoE has been disabled for the port.</li> <li>• <b>Fault</b> displays when a PSE goes over its power allocation.</li> </ul>
Current power consumption:	The power consumption for the PoE port when this command was entered. Note that the power consumption may have changed since the command was entered and the power is displayed.
Powered device class:	The class of the connected PD if connected, and if power is being supplied to the PD from the PSE. See the <a href="#">PoE Feature Overview and Configuration Guide</a> for further information about power classes.
Power allocated	The power in milliwatts (mW) allocated for the PoE port. Additionally, note the following as displayed per PoE port: <ul style="list-style-type: none"> <li>• <b>[U]</b> if the power limit for a port was user configured (with the <b>power-inline max</b> command).</li> <li>• <b>[L]</b> if the power limit for a port was supplied by LLDP.</li> <li>• <b>[C]</b> if the power limit for a port was supplied by the PD class.</li> </ul>
Detection of legacy devices is	The status of legacy PoE detection on the PoE port (enabled or disabled), as configured for the PoE port with the <a href="#">power-inline allow-legacy</a> command. Legacy detection involves measuring for a large capacitance value to confirm the presence of a legacy PD.
Powered pairs	The IEEE 802.3af and IEEE 802.3at standards allow for either <b>data</b> or <b>spare</b> twisted pairs to be used to transfer power to a PD.

**Related commands** [show power-inline](#)  
[show power-inline interface](#)

**Command changes** Version 5.4.8-0.2: added to x550 series products

# Part 3: Layer 3 Switching



# 19

# IP Addressing and Protocol Commands

## Introduction

**Overview** This chapter provides an alphabetical reference of commands used to configure various IP features, including the following protocols:

- Address Resolution Protocol (ARP)

For more information, see the [IP Feature Overview and Configuration Guide](#).

- Command List**
- [“arp-aging-timeout”](#) on page 651
  - [“arp-mac-disparity”](#) on page 652
  - [“arp”](#) on page 655
  - [“arp log”](#) on page 657
  - [“arp opportunistic-nd”](#) on page 660
  - [“arp-reply-bc-dmac”](#) on page 661
  - [“clear arp-cache”](#) on page 662
  - [“debug ip packet interface”](#) on page 663
  - [“ip address \(IP Addressing and Protocol\)”](#) on page 665
  - [“ip gratuitous-arp-link”](#) on page 667
  - [“ip redirects”](#) on page 669
  - [“ip tcp synack-retries”](#) on page 670
  - [“ip unreachable”](#) on page 671
  - [“ping”](#) on page 673
  - [“show arp”](#) on page 674
  - [“show debugging ip packet”](#) on page 675
  - [“show ip flooding-nextthops”](#) on page 676
  - [“show ip interface”](#) on page 677

- [“show ip sockets”](#) on page 678
- [“show ip traffic”](#) on page 681
- [“tcpdump”](#) on page 683
- [“traceroute”](#) on page 684
- [“undebug ip packet interface”](#) on page 685

# arp-aging-timeout

**Overview** This command sets a timeout period on dynamic ARP entries associated with a specific interface. If your device stops receiving traffic for the host specified in a dynamic ARP entry, it deletes the ARP entry from the ARP cache after this timeout is reached.

Your device times out dynamic ARP entries to ensure that the cache does not fill with entries for hosts that are no longer active. Static ARP entries are not aged or automatically deleted.

By default the time limit for dynamic ARP entries is 300 seconds on all interfaces. The **no** variant of this command sets the time limit to the default of 300 seconds.

**Syntax** `arp-aging-timeout <0-432000>`  
`no arp-aging timeout`

Parameter	Description
<code>&lt;0-432000&gt;</code>	The timeout period in seconds.

**Default** 300 seconds (5 minutes)

**Mode** Interface Configuration for a VLAN interface.

**Example** To set the ARP entries on interface vlan2 to time out after two minutes, use the commands:

```
awplus# configure terminal
awplus(config)# interface vlan2
awplus(config-if)# arp-aging-timeout 120
```

**Related commands** [clear arp-cache](#)  
[show arp](#)

# arp-mac-disparity

**Overview** Use this command to enable the switch to support services like Microsoft Network Load Balancing (MS-NLB).

Such services use ARP with disparate MAC addresses to ensure that packets destined for a server cluster virtual address are sent to all servers in the cluster. Disparate MAC addresses mean that the MAC address in the “sender hardware address” field of an ARP reply is different to the MAC address in the “Source MAC address” field of the Ethernet header that the ARP packet is encapsulated in.

The **no** variant of this command reverts to the default behavior. See the Default section below for more information.

**Syntax** `arp-mac-disparity {multicast|multicast-igmp|unicast}`  
`no arp-mac-disparity {multicast|multicast-igmp|unicast}`

Parameter	Description
multicast	Enables support of server clusters operating in multicast mode. Packets destined for the server cluster are flooded to all ports in the VLAN.
multicast-igmp	Enables support of server clusters operating in multicast/IGMP mode. In multicast/IGMP mode, the MS-NLB server cluster uses IGMP reports to forward server traffic to a limited set of ports.
unicast	Enables support of server clusters operating in unicast mode. Packets destined for the server cluster are flooded to all ports in the VLAN.

**Default** ARP-MAC disparity support is disabled and:

- If the Disparate ARP has a multicast MAC address in the ARP reply, the switch drops the ARP reply and does not learn any associated addresses
- If the Disparate ARP has a unicast MAC address in the ARP reply, the switch learns the address in the ARP reply. The learned ARP entry points to the single port that the ARP reply arrived on. Matching traffic will go out this port.

**Mode** Interface Configuration for a VLAN interface.

**Usage notes** **Multicast mode**

When you are using **multicast** mode, you can limit the number of ports that packets are flooded to, instead of flooding to all ports in the VLAN. To do this, specify the list of ports when creating the ARP entry.

For example, to flood only port1.0.1 to port1.0.3, use the commands:

```
awplus# configure terminal
awplus(config)# interface vlan2
awplus(config-if)# arp-mac-disparity multicast
awplus(config-if)# arp 10.10.1.100 010e.11ff.2222
port1.0.1-port1.0.3
```

### Multicast IGMP mode

You can enable Multicast-IGMP mode by using the command **arp-mac-disparity multicast-igmp**.

In this mode, the only difference to standard multicast mode is that the reception of IGMP reports now controls the ports to which the L3 switch floods traffic. That is, rather than simply flooding each packet destined for the NLB cluster IP address to all ports on the egress VLAN, those packets are only sent to the switchports in the VLAN that have received IGMP reports for the multicast group corresponding to the NLB cluster MAC address.

Like **arp-mac-disparity multicast**, the command **arp-mac-disparity multicast-igmp** puts the switch into a mode where it will accept Disparate ARP responses. Similarly, upon receiving a Disparate ARP response, an ARP entry is created for the IP/MAC in the content of the ARP packet. The difference with the **arp-mac-disparity multicast-igmp** command is that the egress port is set to the subset of ports in the VLAN that have received IGMP reports for the NLB cluster MAC address.

Note that the ARP entry is updated as ports join/leave the IGMP group. If no ports have received IGMP reports for the NLB cluster MAC address then the ARP entry will have no egress ports and will simply drop packets destined for the NLB cluster IP address.

Again, no FDB entry is created in response to receiving the ARP packet. However, since the NLB server is operating in multicast mode with the IGMP option set and is sending IGMP reports, an FDB entry will already exist for the IGMP group (and, as a result, the NLB cluster MAC address).

When the **arp-mac-disparity multicast-igmp** command is configured on the VLAN, ARP entries appear in the output of the command **show arp** like this:

```
awplus#show arp
IP Address    MAC Address      Interface  Port          Type
10.100.0.56   0100.5e7f.0038   vlan200    igmp-group    dynamic
```

**Examples** To enable support for MS-NLB in unicast mode on interface vlan2, use the following commands:

```
awplus# configure terminal
awplus(config)# interface vlan2
awplus(config-if)# arp-mac-disparity unicast
```

To disable support for MS-NLB in unicast mode on interface vlan2, use the following commands:

```
awplus# configure terminal
awplus(config)# interface vlan2
awplus(config-if)# no arp-mac-disparity unicast
```

**Related  
commands**

[arp](#)  
[clear arp-cache](#)  
[show arp](#)

# arp

**Overview** This command adds a static ARP entry to the ARP cache. This is typically used to add entries for hosts that do not support ARP or to speed up the address resolution function for a host. The ARP entry must not already exist. Use the **alias** parameter to allow your device to respond to ARP requests for this IP address.

The **no** variant of this command removes the static ARP entry. Use the [clear arp-cache](#) command to remove the dynamic ARP entries in the ARP cache.

**Syntax** `arp <ip-addr> <mac-address> [<port-number>] [alias]`  
`arp <ip-addr> <multicast-mac-address> [<port-list>]`  
`no arp <ip-addr>`

Parameter	Description
<code>&lt;ip-addr&gt;</code>	The IPv4 address of the device you are adding as a static ARP entry.
<code>&lt;mac-address&gt;</code>	The MAC address of the device you are adding as a static ARP entry, in hexadecimal notation with the format HHHH.HHHH.HHHH.
<code>&lt;port-number&gt;</code>	The port number associated with the IP address. Specify this when the IP address is part of a VLAN.
<code>&lt;multicast-mac-address&gt;</code>	The multicast MAC address for which you are adding a static ARP entry, in hexadecimal notation with the format HHHH.HHHH.HHHH.
<code>&lt;port-list&gt;</code>	The list of port numbers associated with the IP address. You can only specify multiple egress ports when the MAC address is a multicast MAC address.
<code>alias</code>	Allows your device to respond to ARP requests for the IP address. Proxy ARP must be enabled on the interface before using this parameter.

**Mode** Global Configuration

**Usage notes** One use of this command is to limit packet flooding when using services like Microsoft Network Load Balancing (MS-NLB). With such services, packets destined for server cluster virtual address must be sent to all servers in the cluster. The server cluster can operate in multicast mode, in which it uses a multicast MAC address. To support this, this command allows you to create a static ARP entry with a multicast MAC address, and specify which ports the packets will be forwarded out.

Creating a static ARP entry enables the switch to correctly forward server cluster traffic. If you want the switch to also respond to pings from the server cluster, you need to also enable server cluster support, using the [arp-mac-disparity](#) command.

**Examples** To add the IP address 10.10.10.9 with the MAC address 0010.2533.4655 into the ARP cache, and have your device respond to ARP requests for this address, use the commands:

```
awplus# configure terminal
awplus(config)# arp 10.10.10.9 0010.2355.4566 alias
```

**Related commands**

- [arp-mac-disparity](#)
- [clear arp-cache](#)
- [show arp](#)



# arp log

**Overview** This command enables the logging of dynamic and static ARP entries in the ARP cache. The ARP cache contains mappings of device ports, VLAN IDs, and IP addresses to physical MAC addresses for hosts.

This command can display the MAC addresses in the ARP log either using the notation HHHH.HHHH.HHHH, or using the IEEE standard hexadecimal notation (HH-HH-HH-HH-HH-HH).

Use the **no** variant of this command to disable the logging of ARP entries.

**Syntax** `arp log [mac-address-format ieee]`  
`no arp log [mac-address-format ieee]`

Parameter	Description
<code>mac-address-format ieee</code>	Display the MAC address in the standard IEEE format (HH-HH-HH-HH-HH-HH), instead of displaying the MAC address with the format HHHH.HHHH.HHHH.

**Default** The ARP logging feature is disabled by default.

**Mode** Global Configuration

**Usage notes** You have the option to change how the MAC address is displayed in the ARP log message. The output can either use the notation HHHH.HHHH.HHHH or HH-HH-HH-HH-HH-HH.

Enter **arp log** to use HHHH.HHHH.HHHH notation.

Enter **arp log mac-address-format ieee** to use HH-HH-HH-HH-HH-HH notation.

Enter **no arp log mac-address-format ieee** to revert from HH-HH-HH-HH-HH-HH to HHHH.HHHH.HHHH.

Enter **no arp log** to disable ARP logging.

To display ARP log messages use the command **show log | include ARP\_LOG**.

**Examples** To enable ARP logging and specify that the MAC address in the log message is displayed in HHHH.HHHH.HHHH notation, use the following commands:

```
awplus# configure terminal
awplus(config)# arp log
```

To disable ARP logging on the device, use the following commands:

```
awplus# configure terminal
awplus(config)# no arp log
```

To enable ARP logging and specify that the MAC address in the log message is displayed in the standard IEEE format hexadecimal notation (HH-HH-HH-HH-HH-HH), use the following commands:

```
awplus# configure terminal
awplus(config)# arp log mac-address-format ieee
```

To leave ARP logging enabled, but stop using HH-HH-HH-HH-HH-HH format and use HHHH.HHHH.HHHH format instead, use the following commands:

```
awplus# configure terminal
awplus(config)# no arp log mac-address-format ieee
```

To display ARP log messages, use the following command:

```
awplus# show log | include ARP_LOG
```

**Output** Figure 19-1: Output from **show log | include ARP\_LOG** after enabling ARP logging using **arp log**. Note that this output uses HHHH.HHHH.HHHH format.

```
awplus#configure terminal
awplus(config)#arp log
awplus(config)#exit
awplus#show log | include ARP_LOG
2018 Oct 6 06:21:01 user.notice awplus HSL[1007]: ARP_LOG port1.0.1 vlan1 add
0013.4078.3b98 (192.168.2.4)
2018 Oct 6 06:22:30 user.notice awplus HSL[1007]: ARP_LOG port1.0.1 vlan1 del
0013.4078.3b98 (192.168.2.4)
2018 Oct 6 06:23:26 user.notice awplus HSL[1007]: ARP_LOG port1.0.1 vlan1 add
0030.940e.136b (192.168.2.20)
2018 Oct 6 06:23:30 user.notice awplus IMISH[1830]: show log | include ARP_LOG
```

Figure 19-2: Output from **show log | include ARP\_LOG** after enabling ARP logging using **arp log mac-address format ieee**. Note that this output uses HH-HH-HH-HH-HH-HH format.

```
awplus#configure terminal
awplus(config)#arp log mac-address-format ieee
awplus(config)#exit
awplus#show log | include ARP_LOG
2018 Oct 6 06:25:28 user.notice awplus HSL[1007]: ARP_LOG port1.0.1 vlan1 add
00-17-9a-b6-03-69 (192.168.2.12)
2018 Oct 6 06:25:30 user.notice awplus HSL[1007]: ARP_LOG port1.0.1 vlan1 add
00-03-37-6b-a6-a5 (192.168.2.10)
2018 Oct 6 06:26:53 user.notice awplus HSL[1007]: ARP_LOG port1.0.1 vlan1 del
00-30-94-0e-13-6b (192.168.2.20)
2018 Oct 6 06:27:31 user.notice awplus HSL[1007]: ARP_LOG port1.0.1 vlan1 del
00-17-9a-b6-03-69 (192.168.2.12)
2018 Oct 6 06:28:09 user.notice awplus HSL[1007]: ARP_LOG port1.0.1 vlan1 del
00-03-37-6b-a6-a5 (192.168.2.10)
2018 Oct 6 06:28:14 user.notice awplus IMISH[1830]: show log | include ARP_LOG
```

The following table lists the parameters in output of the **show log | include ARP\_LOG** command. The ARP log message format is:

```
<date> <time> <severity> <hostname> <program-name>  
ARP_LOG <port-number> <vid> <operation> <MAC> <IP>
```

Table 19-1: Parameters in the output from **show log | include ARP\_LOG**

Parameter	Description
ARP_LOG	Indicates that ARP log entry information follows.
<port-number>	Indicates device port number for the ARP log entry.
<vid>	Indicates the VLAN ID for the ARP log entry.
<operation>	Indicates "add" if the ARP log entry displays an ARP addition. Indicates "del" if the ARP log entry displays an ARP deletion.
<MAC>	Indicates the MAC address for the ARP log entry, either in the default hexadecimal notation (HHHH.HHHH.HHHH) or in the IEEE standard format hexadecimal notation (HH-HH-HH-HH-HH-HH) as specified with the <b>arp log mac-address-format ieee</b> command.
<IP>	Indicates the IP address for the ARP log entry.

**Related commands** [show log](#)  
[show running-config](#)

# arp opportunistic-nd

**Overview** Use this command to enable opportunistic neighbor discovery for the global ARP cache. This command changes the behavior for unsolicited ARP packet forwarding on the device.

Use the **no** variant of this command to disable opportunistic neighbor discovery for the global ARP cache.

**Syntax** `arp opportunistic-nd`  
`no arp opportunistic-nd`

**Default** Opportunistic neighbor discovery is disabled by default.

**Mode** Global Configuration

**Usage notes** When opportunistic neighbor discovery is enabled, the device will reply to any received unsolicited ARP packets (but not gratuitous ARP packets). The source MAC address for the unsolicited ARP packet is added to the ARP cache, so the device forwards the ARP packet. When opportunistic neighbor discovery is disabled, the source MAC address for the ARP packet is not added to the ARP cache, so the ARP packet is not forwarded by the device.

**Examples** To enable opportunistic neighbor discovery for the global ARP cache, enter:

```
awplus# configure terminal
awplus(config)# arp opportunistic-nd
```

To disable opportunistic neighbor discovery for the global ARP cache, enter:

```
awplus# configure terminal
awplus(config)# no arp opportunistic-nd
```

**Related commands** [ipv6 opportunistic-nd](#)  
[show arp](#)  
[show running-config interface](#)

# arp-reply-bc-dmac

**Overview** Use this command to allow processing of ARP replies that arrive with a broadcast destination MAC (ffff.ffff.ffff). This makes neighbors reachable if they send ARP responses that contain a broadcast destination MAC.

Use the **no** variant of this command to turn off processing of ARP replies that arrive with a broadcast destination MAC.

**Syntax** `arp-reply-bc-dmac`  
`no arp-reply-bc-dmac`

**Default** By default, this functionality is disabled.

**Mode** Interface Configuration for VLAN interfaces

**Example** To allow processing of ARP replies that arrive on vlan2 with a broadcast destination MAC, use the commands:

```
awplus# configure terminal
awplus(config)# interface vlan2
awplus(config-if)# arp-reply-bc-dmac
```

**Related commands** [clear arp-cache](#)  
[show arp](#)

# clear arp-cache

**Overview** This command deletes dynamic ARP entries from the ARP cache. You can optionally specify the IPv4 address of an ARP entry to be cleared from the ARP cache.

**Syntax** `clear arp-cache [<ip-address>]`

Parameter	Description
<i>&lt;ip-address&gt;</i>	The IPv4 address of an ARP entry that is to be cleared from the ARP cache.

**Mode** Privileged Exec

**Usage notes** To display the entries in the ARP cache, use the [show arp](#) command. To remove static ARP entries, use the no variant of the [arp](#) command.

**Example** To clear all dynamic ARP entries, use the command:

```
awplus# clear arp-cache
```

To clear all dynamic ARP entries associated with the IPv4 address 192.168.1.1, use the command:

```
awplus# clear arp-cache 192.168.1.1
```

**Related commands**

- [arp-mac-disparity](#)
- [arp](#)
- [show arp](#)

# debug ip packet interface

**Overview** The **debug ip packet interface** command enables IP packet debug and is controlled by the **terminal monitor** command.

If the optional **icmp** keyword is specified then ICMP packets are shown in the output.

The **no** variant of this command disables the **debug ip interface** command.

**Syntax** `debug ip packet interface {<interface-name>|all} [address <ip-address>|verbose|hex|arp|udp|tcp|icmp]`  
`no debug ip packet interface [<interface-name>]`

Parameter	Description
<interface>	Specify a single Layer 3 interface name (not a range of interfaces) This keyword can be specified as either all or as a single Layer 3 interface to show debugging for either all interfaces or a single interface.
all	Specify all Layer 3 interfaces on the device.
<ip-address>	Specify an IPv4 address. If this keyword is specified, then only packets with the specified IP address as specified in the ip-address placeholder are shown in the output.
verbose	Specify <b>verbose</b> to output more of the IP packet. If this keyword is specified then more of the packet is shown in the output.
hex	Specify <b>hex</b> to output the IP packet in hexadecimal. If this keyword is specified, then the output for the packet is shown in hex.
arp	Specify <b>arp</b> to output ARP protocol packets. If this keyword is specified, then ARP packets are shown in the output.
udp	Specify <b>udp</b> to output UDP protocol packets. If this keyword is specified then UDP packets are shown in the output.
tcp	Specify <b>tcp</b> to output TCP protocol packets. If this keyword is specified, then TCP packets are shown in the output.
icmp	Specify <b>icmp</b> to output ICMP protocol packets. If this keyword is specified, then ICMP packets are shown in the output.

**Mode** Privileged Exec and Global Configuration

**Examples** To turn on ARP packet debugging on vlan2, use the command:

```
awplus# debug ip packet interface vlan2 arp
```

To turn off IP packet interface debugging on interface vlan2, use the command:

```
awplus# no debug ip packet interface vlan2
```

To turn on all packet debugging on all interfaces on the device, use the command:

```
awplus# debug ip packet interface all
```

To turn off IP packet interface debugging on all interfaces, use the command:

```
awplus# no debug ip packet interface
```

To turn on TCP packet debugging on vlan2 and IP address 192.168.2.4, use the command:

```
awplus# debug ip packet interface vlan2 address 192.168.2.4 tcp
```

**Related  
commands**

[no debug all](#)

[tcpdump](#)

[terminal monitor](#)

[undebug ip packet interface](#)



# ip address (IP Addressing and Protocol)

**Overview** This command sets a static IP address on an interface.

The **no** variant of this command removes the IP address from the interface.

You cannot remove the primary address when a secondary address is present.

**Syntax** `ip address <ip-addr/prefix-length> [secondary] [label <label>]`  
`no ip address [<ip-addr/prefix-length>] [secondary]`

Parameter	Description
<ip-addr/prefix-length>	The IPv4 address and prefix length you are assigning to the interface.
secondary	Secondary IP address.
label	Adds a user-defined description of the secondary IP address.
<label>	A user-defined description of the secondary IP address. Valid characters are any printable character and spaces.

**Mode** Interface Configuration for a VLAN interface or a local loopback interface.

**Usage notes** To set the primary IP address on the interface, specify only **ip address** <ip-address/m>. This overwrites any configured primary IP address. To add additional IP addresses on this interface, use the **secondary** parameter. You must configure a primary address on the interface before configuring a secondary address.

**NOTE:** Use **show running-config interface** not **show ip interface brief** when you need to view a secondary address configured on an interface. **show ip interface brief** will only show the primary address, not a secondary address for an interface.

**Examples** To add the IP address 10.10.10.50/24 to the interface vlan2, use the following commands:

```
awplus# configure terminal
awplus(config)# interface vlan2
awplus(config-if)# ip address 10.10.10.50/24
```

To add the secondary IP address 10.10.11.50/24 to the same interface, use the following commands:

```
awplus# configure terminal
awplus(config)# interface vlan2
awplus(config-if)# ip address 10.10.11.50/24 secondary
```

To add the IP address 10.10.11.50/24 to the local loopback interface lo, use the following commands:

```
awplus# configure terminal
awplus(config)# interface lo
awplus(config-if)# ip address 10.10.11.50/24
```

**Related commands**

- [interface \(to configure\)](#)
- [show ip interface](#)
- [show running-config interface](#)

# ip gratuitous-arp-link

**Overview** This command sets the Gratuitous ARP time limit for all switchports. The time limit restricts the sending of Gratuitous ARP packets to one Gratuitous ARP packet within the time in seconds.

**NOTE:** *This command specifies time between sequences of Gratuitous ARP packets, and time between individual Gratuitous ARP packets occurring in a sequence, to allow legacy support for older devices and interoperation between other devices that are not ready to receive and forward data until several seconds after linkup.*

*Additionally, jitter has been applied to the delay following linkup, so Gratuitous ARP packets applicable to a given port are spread over a period of 1 second so are not all sent at once. Remaining Gratuitous ARP packets in the sequence occur after a fixed delay from the first one.*

**Syntax** ip gratuitous-arp-link <0-300>  
no ip gratuitous-arp-link

Parameter	Description
<0-300>	Specify the minimum time between sequences of Gratuitous ARPs and the fixed time between Gratuitous ARPs occurring in a sequence, in seconds. 0 disables the sending of Gratuitous ARP packets. The default is 8 seconds.

**Default** The default Gratuitous ARP time limit for all switchports is 8 seconds.

**Mode** Global Configuration

**Usage** Every switchport will send a sequence of 3 Gratuitous ARP packets to each VLAN that the switchport is a member of, whenever the switchport moves to the forwarding state. The first Gratuitous ARP packet is sent 1 second after the switchport becomes a forwarding switchport. The second and third Gratuitous ARP packets are each sent after the time period specified by the Gratuitous ARP time limit.

Additionally, the Gratuitous ARP time limit specifies the minimum time between the end of one Gratuitous ARP sequence and the start of another Gratuitous ARP sequence. When a link is flapping, the switchport's state is set to forwarding several times. The Gratuitous ARP time limit is imposed to prevent Gratuitous ARP packets from being sent undesirably often.

**Examples** To disable the sending of Gratuitous ARP packets, use the commands :

```
awplus# configure terminal
awplus(config)# ip gratuitous-arp-link 0
```

To restrict the sending of Gratuitous ARP packets to one every 20 seconds, use the commands:

```
awplus# configure terminal  
awplus(config)# ip gratuitous-arp-link 20
```

**Validation  
Commands** `show running-config`

# ip redirects

**Overview** This command enables the device to send ICMP redirects on one or more interfaces.

Use the **no** variant of this command to stop the device from sending ICMP redirects on one or more interfaces.

**Syntax** `ip redirects`  
`no ip redirects`

**Default** ICMP redirects are disabled by default.

**Mode** Interface Configuration for a VLAN interface.

**Usage notes** ICMP redirect messages are used to notify hosts that a better route is available to a destination.

ICMP redirects are used when a packet is routed into the device on the same interface that the packet is routed out of the device. ICMP redirects are only sent to packet sources that are directly connected to the device.

**Examples** To enable the device to send ICMP redirects on interface vlan2, use the following commands:

```
awplus# configure terminal
awplus(config)# interface vlan2
awplus(config-if)# ip redirects
```

To stop the device from sending ICMP redirects on interface vlan2, use the following commands:

```
awplus# configure terminal
awplus(config)# interface vlan2
awplus(config-if)# no ip redirects
```

# ip tcp synack-retries

**Overview** Use this command to specify how many times the switch will retry sending a SYN ACK for a TCP connection for which it has received a SYN but not an ACK. Such connections are called half-open TCP connections. This command allows you to influence how long half-open TCP connections take to time out.

Use the **no** variant of this command to return to the default setting of 5 retries.

**Syntax** `ip tcp synack-retries <0-255>`  
`no ip tcp synack-retries`

Parameter	Description
<0-255>	Number of times to retry sending the SYN ACK

**Default** 5 retries

**Mode** Global Configuration

**Usage notes** The following table shows the approximate correlation between the number of retries and the time half-open TCP connections take to time out.

Number of retries	Approximate lower bound for the timeout
0 retries	1 second
1 retry	3 seconds
2 retries	7 seconds
3 retries	15 seconds
4 retries	31 seconds
5 retries	63 seconds

**Example** To retry twice, which leads to a timeout of approximately 7 seconds, use the commands:

```
awplus# configure terminal  
awplus(config)# ip tcp synack-retries 2
```

**Related commands** [show running-config](#)

**Command changes** Version 5.4.7-0.2: command added

# ip unreachables

**Overview** Use this command to enable ICMP (Internet Control Message Protocol) type 3, destination unreachable, messages.

Use the **no** variant of this command to disable destination unreachable messages. This prevents an attacker from using these messages to discover the topology of a network.

**Syntax** `ip unreachables`  
`no ip unreachables`

**Default** Destination unreachable messages are enabled by default.

**Mode** Global Configuration

**Usage notes** When a device receives a packet for a destination that is unreachable it returns an ICMP type 3 message, this message includes a reason code, as per the table below. An attacker can use these messages to obtain information regarding the topology of a network. Disabling destination unreachable messages, using the **no ip unreachables** command, secures your network against this type of probing.

**NOTE:** *Disabling ICMP destination unreachable messages breaks applications such as traceroute and Path MTU Discovery (PMTUD), which depend on these messages to operate correctly.*

Table 19-2: ICMP type 3 reason codes and description

Code	Description [RFC]
0	Network unreachable [RFC792]
1	Host unreachable [RFC792]
2	Protocol unreachable [RFC792]
3	Port unreachable [RFC792]
4	Fragmentation required, and DF flag set [RFC792]
5	Source route failed [RFC792]
6	Destination network unknown [RFC1122]
7	Destination host unknown [RFC1122]
8	Source host isolated [RFC1122]
9	Network administratively prohibited [RFC768]
10	Host administratively prohibited [RFC869]
11	Network unreachable for Type of Service [RFC908]
12	Host unreachable for Type of Service [RFC938]
13	Communication administratively prohibited [RFC905]

Table 19-2: ICMP type 3 reason codes and description (cont.)

Code	Description [RFC]
14	Host Precedence Violation [RFC1812]
15	Precedence cutoff in effect [RFC1812]

**Example** To disable destination unreachable messages, use the commands

```
awplus# configure terminal  
awplus(config)# no ip unreachable
```

To enable destination unreachable messages, use the commands

```
awplus# configure terminal  
awplus(config)# ip unreachable
```



# ping

**Overview** This command sends a query to another IPv4 host (send Echo Request messages).

**Syntax** ping [ip] <host> [broadcast] [df-bit {yes|no}] [interval <0-128>] [pattern <hex-data-pattern>] [repeat {<1-2147483647>|continuous}] [size <36-18024>] [source <ip-addr>] [timeout <1-65535>] [tos <0-255>]

Parameter	Description
<host>	The destination IP address or hostname.
broadcast	Allow pinging of a broadcast address.
df-bit	Enable or disable the do-not-fragment bit in the IP header.
interval <0-128>	Specify the time interval in seconds between sending ping packets. The default is 1. You can use decimal places to specify fractions of a second. For example, to ping every millisecond, set the interval to 0.001.
pattern <hex-data-pattern>	Specify the hex data pattern.
repeat	Specify the number of ping packets to send.
<1-2147483647>	Specify repeat count. The default is 5.
continuous	Continuous ping
size <36-18024>	The number of data bytes to send, excluding the 8 byte ICMP header. The default is 56 (64 ICMP data bytes).
source <ip-addr>	The IP address of a configured IP interface to use as the source in the IP header of the ping packet.
timeout <1-65535>	The time in seconds to wait for echo replies if the ARP entry is present, before reporting that no reply was received. If no ARP entry is present, it does not wait.
tos <0-255>	The value of the type of service in the IP header.

**Mode** User Exec and Privileged Exec

**Example** To ping the IP address 10.10.0.5 use the following command:

```
awplus# ping 10.10.0.5
```

# show arp

**Overview** Use this command to display entries in the ARP routing and forwarding table—the ARP cache contains mappings of IP addresses to physical addresses for hosts. To have a dynamic entry in the ARP cache, a host must have used the ARP protocol to access another host.

For information on filtering and saving command output, see the [“Getting Started with AlliedWare Plus” Feature Overview and Configuration Guide](#).

**Syntax** show arp

**Mode** User Exec and Privileged Exec

**Usage notes** Running this command with no additional parameters will display all entries in the ARP routing and forwarding table.

**Example** To display all ARP entries in the ARP cache, use the following command:

```
awplus# show arp
```

**Output** Figure 19-3: Example output from the **show arp** command

```
awplus#show arp
IP Address      LL Address      Interface  Port           Type
192.168.27.10   192.168.4.1    vlan1     port1.0.1     dynamic
192.168.27.100 0000.daaF.cd24 vlan1     port1.0.2     dynamic
192.168.1.100   192.168.20.1   vlan2    port1.0.3     static
```

**Table 20:** Parameters in the output of the **show arp** command

Parameter	Meaning
IP Address	IP address of the network device this entry maps to.
LL Address	Hardware address of the network device.
Interface	Interface over which the network device is accessed.
Port	Physical port that the network device is attached to.
Type	Whether the entry is a static or dynamic entry. Static entries are added using the <a href="#">arp</a> command. Dynamic entries are learned from ARP request/reply message exchanges.

**Related commands** arp  
clear arp-cache

**Command changes** Version 5.4.9-0.1: Link layer addresses now shown as the hardware address (MAC Address output parameter has been renamed to LL Address).

# show debugging ip packet

**Overview** Use this command to see what debugging is turned on for IP interfaces. IP interface debugging is set using the **debug ip packet interface** command.

For information on filtering and saving command output, see the [“Getting Started with AlliedWare Plus” Feature Overview and Configuration Guide](#).

**Syntax** show debugging ip packet

**Mode** User Exec and Privileged Exec

**Example** To display the IP interface debugging status when the terminal monitor is off, use the commands:

```
awplus# terminal no monitor
awplus# show debugging ip packet
```

**Output** Figure 19-4: Example output from the **show debugging ip packet** command with **terminal monitor** off

```
awplus#terminal no monitor
awplus#show debugging ip packet
IP debugging status:
interface all tcp (stopped)
interface vlan1 arp verbose (stopped)
```

**Example** To display the IP interface debugging status when the terminal monitor is on, use the commands:

```
awplus# terminal monitor
awplus# show debugging ip packet
```

**Output** Figure 19-5: Example output from the **show debugging ip packet** command with **terminal monitor** on

```
awplus#terminal monitor
awplus#show debugging ip packet
IP debugging status:
interface all tcp (running)
interface vlan1 arp verbose (running)
```

**Related commands** [debug ip packet interface](#)  
[terminal monitor](#)

# show ip flooding-nextops

**Overview** Use this command to display the static and dynamic ARP entries in the ARP cache that flood packets to multiple ports.

**Syntax** `show ip flooding-nextops`

**Mode** User Exec and Privileged Exec

**Example** To display all of the flooding nexthop entries in the ARP cache, use the command:

```
awplus# show ip flooding-nextops
```

**Output** Figure 19-6: Example output from **show ip flooding-nextops**

```
awplus#show ip flooding-nextops
```

IP Address	MAC Address	Interface	Flooding Mode	Type
11.11.11.10	0300.0000.0011	vlan1	port-group	static

**Related commands** [show arp](#)

**Command changes** Version 5.4.8-2.1: command added

# show ip interface

**Overview** Use this command to display information about interfaces and the IP addresses assigned to them. To display information about a specific interface, specify the interface name with the command.

For information on filtering and saving command output, see the [“Getting Started with AlliedWare Plus” Feature Overview and Configuration Guide](#).

**Syntax** `show ip interface [<interface-list>] [brief]`

Parameter	Description
<interface-list>	The interfaces to display information about. An interface-list can be: <ul style="list-style-type: none"><li>• a VLAN (e.g. vlan2)</li><li>• the loopback interface (lo)</li><li>• a continuous range of interfaces separated by a hyphen (e.g. vlan10-20)</li><li>• a comma-separated list (e.g. vlan1,vlan10-20). Do not mix interface types in a list.</li></ul> The specified interfaces must exist.

**Mode** User Exec and Privileged Exec

**Examples** To show brief information for the assigned IP address for interface port1.0.2 use the command:

```
awplus# show ip interface port1.0.2 brief
```

To show the IP addresses assigned to vlan2, use the command:

```
awplus# show ip interface vlan2 brief
```

**Output** Figure 19-7: Example output from the **show ip interface brief** command

Interface	IP-Address	Status	Protocol
port1.0.1	unassigned	admin up	down
...			
vlan1	192.168.1.1	admin up	running
...			

# show ip sockets

**Overview** Use this command to display information about the IP or TCP sockets that are present on the device. It includes TCP and UDP listen sockets, and displays the associated IP address and port.

The information displayed for established TCP sessions includes the remote IP address, port, and session state. Raw IP protocol listen socket information is also displayed for protocols such as ICMP6, which are configured to receive IP packets with the associated protocol number.

For information on filtering and saving command output, see the [“Getting Started with AlliedWare Plus” Feature Overview and Configuration Guide](#).

**Syntax** show ip sockets

**Mode** Privileged Exec

**Usage notes** Use this command to verify that the socket being used is opening correctly. If there is a local and remote endpoint, a connection is established with the ports indicated.

Note that this command does not display sockets that are used internally for exchanging data between the various processes that exist on the device and are involved in its operation and management. It only displays sockets that are present for the purposes of communicating with other external devices.

**Example** To display IP sockets currently present on the device, use the command:

```
awplus# show ip sockets
```

**Output** Figure 19-8: Example output from **show ip sockets**

```
Socket information

Not showing 40 local connections
Not showing 7 local listening ports
```

Typ	Local Address	Remote Address	State
tcp	0.0.0.0:111	0.0.0.0:*	LISTEN
tcp	0.0.0.0:80	0.0.0.0:*	LISTEN
tcp	0.0.0.0:23	0.0.0.0:*	LISTEN
tcp	0.0.0.0:443	0.0.0.0:*	LISTEN
tcp	0.0.0.0:4743	0.0.0.0:*	LISTEN
tcp	0.0.0.0:873	0.0.0.0:*	LISTEN
tcp	:::23	:::*	LISTEN
udp	0.0.0.0:111	0.0.0.0:*	
udp	226.94.1.1:5405	0.0.0.0:*	
udp	0.0.0.0:161	0.0.0.0:*	
udp	:::161	:::*	
raw	0.0.0.0:112	0.0.0.0:*	112
raw	:::58	:::*	58
raw	:::112	:::*	112

Table 19-1: Parameters in the output from **show ip sockets**

Parameter	Description
Not showing <number> local connections	This field refers to established sessions between processes internal to the device, that are used in its operation and management. These sessions are not displayed as they are not useful to the user. <number> is some positive integer.
Not showing <number> local listening ports	This field refers to listening sockets belonging to processes internal to the device, that are used in its operation and management. They are not available to receive data from other devices. These sessions are not displayed as they are not useful to the user. <number> is some positive integer.
Typ	This column displays the type of the socket. Possible values for this column are: tcp : IP Protocol 6 udp : IP Protocol 17 raw : Indicates that socket is for a non port-orientated protocol (i.e. a protocol other than TCP or UDP) where all packets of a specified IP protocol type are accepted. For raw socket entries the protocol type is indicated in subsequent columns.
Local Address	For TCP and UDP listening sockets this shows the destination IP address and destination TCP or UDP port number for which the socket will receive packets. The address and port are separated by ':'. If the socket will accept packets addressed to any of the device's IP addresses, the IP address will be 0.0.0.0 for IPv4 or :: for IPv6. For active TCP sessions the IP address will display which of the devices addresses the session was established with. For raw sockets this displays the IP address and IP protocol for which the socket will accept IP packets. The address and protocol are separated by ':'. If the socket will accept packets addressed to any of the device's IP addresses, the IP address will be 0.0.0.0 for IPv4 and :: for IPv6. IP Protocol assignments are described at: <a href="http://www.iana.org/assignments/protocol-numbers">www.iana.org/assignments/protocol-numbers</a>

Table 19-1: Parameters in the output from **show ip sockets** (cont.)

Parameter	Description
Remote Address	For TCP and UDP listening sockets this shows the source IP address (either IPv4 or IPv6) and source TCP or UDP port number for which the socket will accept packets. The address and port are separated by ':'. If the socket will accept packets addressed from any IP address, the IP address will be 0.0.0.0 for IPv4. This is the usual case for a listening socket. Normally for a listen socket any source port will be accepted. This is indicated by '*'. For active TCP sessions the IP address will display the remote address and port the session was established with. For raw sockets the entry in this column will be 0.0.0.0: for IPv4.
State	This column shows the state of the socket. For TCP sockets this shows the state of the TCP state machine. For UDP sockets this column is blank. For raw sockets it contains the IP protocol number. The possible TCP states are: LISTEN SYN-SENT SYN-RECEIVED ESTABLISHED FIN-WAIT-1 FIN-WAIT-2 CLOSE-WAIT CLOSING LAST-ACK TIME-WAIT CLOSED RFC793 contains the TCP state machine diagram with Section 3.2 describing each of the states.



# show ip traffic

**Overview** Use this command to display statistics regarding IP traffic sent and received by all interfaces on the device, showing totals for IP and IPv6 and then broken down into sub-categories such as TCP, UDP, ICMP and their IPv6 equivalents when appropriate.

For information on filtering and saving command output, see the [“Getting Started with AlliedWare Plus” Feature Overview and Configuration Guide](#).

**Syntax** show ip traffic

**Mode** Privileged Exec

**Example** To display IP traffic statistics, use the command:

```
awplus# show ip traffic
```

**Output** Figure 19-9: Example output from the **show ip traffic** command

```
awplus#show ip traffic
IP:
    168475 packets received
    168475 delivered
    208099 sent
    35 dropped due to missing route
    22646409 bytes received
    126783216 bytes sent
    InCsumErrors 0
    InNoECTPkts 168475
    InECT1Pkts 0
    InECT0Pkts 0
    InCEPkts 0
    In107 Destination Unreachable
    Out11 Destination Unreachable
IPv6:
    14 packets received
    14 received packets delivered
    18 packets transmitted
...
ICMP6:
    4 messages sent
...
UDP6:
    Udp6RcvbufErrors 0
...
UDPLite6:
    UdpLite6RcvbufErrors 0
...
```

```
TCP:
    8 remote connections established
...
UDP:
    79797 datagrams received
...
UDPLite:
    InCsumErrors 0
...
```

# tcpdump

**Overview** Use this command to start a tcpdump, which gives the same output as the Unix-like **tcpdump** command to display TCP/IP traffic. Press <ctrl> + c to stop a running tcpdump.

**Syntax** `tcpdump <line>`

Parameter	Description
<code>&lt;line&gt;</code>	Specify the dump options. For more information on the options for this placeholder see <a href="http://www.tcpdump.org/tcpdump_man.html">http://www.tcpdump.org/tcpdump_man.html</a>

**Mode** Privileged Exec

**Example** To start a tcpdump running to capture IP packets, enter the command:

```
awplus# tcpdump ip
```

**Output** Figure 19-10: Example output from the **tcpdump** command

```
03:40:33.221337 IP 192.168.1.1 > 224.0.0.13: PIMv2, Hello,  
length: 34  
1 packets captured  
2 packets received by filter  
0 packets dropped by kernel
```

**Related commands** [debug ip packet interface](#)

# traceroute

**Overview** Use this command to trace the route to the specified IPv4 host.

**Syntax** `traceroute {<ip-addr>|<hostname>}`

Parameter	Description
<code>&lt;ip-addr&gt;</code>	The destination IPv4 address. The IPv4 address uses the format A.B.C.D.
<code>&lt;hostname&gt;</code>	The destination hostname.

**Mode** User Exec and Privileged Exec

**Example** `awplus# traceroute 10.10.0.5`

# undebbug ip packet interface

**Overview** This command applies the functionality of the no `debug ip packet interface` command.

# 20

# Domain Name Service (DNS) Commands

## Introduction

**Overview** This chapter provides an alphabetical reference of commands used to configure the Domain Name Service (DNS) client.

For more information about DNS for Switches, see the [Domain Name System \(DNS\) for AlliedWare Plus Switches Feature Overview and Configuration Guide](#)

- Command List**
- [“ip domain-list”](#) on page 687
  - [“ip domain-lookup”](#) on page 688
  - [“ip domain-name”](#) on page 689
  - [“ip name-server”](#) on page 690
  - [“ip name-server preferred-order”](#) on page 692
  - [“show hosts”](#) on page 693
  - [“show ip domain-list”](#) on page 694
  - [“show ip domain-name”](#) on page 695
  - [“show ip name-server”](#) on page 696

# ip domain-list

**Overview** This command adds a domain to the DNS list. Domains are appended to incomplete host names in DNS requests. Each domain in this list is tried in turn in DNS lookups. This list is ordered so that the first entry you create is checked first.

The **no** variant of this command deletes a domain from the list.

**Syntax** `ip domain-list <domain-name>`  
`no ip domain-list <domain-name>`

Parameter	Description
<code>&lt;domain-name&gt;</code>	Domain string, for example "company.com".

**Mode** Global Configuration

**Usage notes** If there are no domains in the DNS list, then your device uses the domain specified with the `ip domain-name` command. If any domain exists in the DNS list, then the device does not use the domain set using the **ip domain-name** command.

**Example** To add the domain `example.net` to the DNS list, use the following commands:

```
awplus# configure terminal
awplus(config)# ip domain-list example.net
```

**Related commands** `ip domain-lookup`  
`ip domain-name`  
`show ip domain-list`

# ip domain-lookup

**Overview** This command enables the DNS client on your device. This allows you to use domain names instead of IP addresses in commands. The DNS client resolves the domain name into an IP address by sending a DNS inquiry to a DNS server, specified with the [ip name-server](#) command.

The **no** variant of this command disables the DNS client. The client will not attempt to resolve domain names. You must use IP addresses to specify hosts in commands.

**Syntax** `ip domain-lookup`  
`no ip domain-lookup`

**Mode** Global Configuration

**Usage notes** The client is enabled by default. However, it does not attempt DNS inquiries unless there is a DNS server configured.

**Examples** To enable the DNS client on your device, use the following commands:

```
awplus# configure terminal
awplus(config)# ip domain-lookup
```

To disable the DNS client on your device, use the following commands:

```
awplus# configure terminal
awplus(config)# no ip domain-lookup
```

**Related commands**

- [ip domain-list](#)
- [ip domain-name](#)
- [ip name-server](#)
- [show hosts](#)
- [show ip name-server](#)



# ip domain-name

**Overview** This command sets a default domain for the DNS. The DNS client appends this domain to incomplete host-names in DNS requests.

The **no** variant of this command removes the domain-name previously set by this command.

**Syntax** `ip domain-name <domain-name>`  
`no ip domain-name <domain-name>`

**Mode** Global Configuration

**Usage notes** If there are no domains in the DNS list (created using the [ip domain-list](#) command) then your device uses the domain specified with this command. If any domain exists in the DNS list, then the device does not use the domain configured with this command.

When your device is using its DHCP client for an interface, it can receive Option 15 from the DHCP server. This option replaces the domain name set with this command.

**Example** To configure the domain name, enter the following commands:

```
awplus# configure terminal
awplus(config)# ip domain-name company.com
```

**Related commands** [ip domain-list](#)  
[show ip domain-list](#)  
[show ip domain-name](#)

# ip name-server

**Overview** Use this command to add IPv4 or IPv6 DNS server addresses. The DNS client on your device sends DNS queries to IP addresses in this list when trying to resolve a host name. Host names cannot be resolved until you have added at least one server to this list. A maximum of three name servers can be added to this list.

The **no** variant of this command removes the specified DNS name-server address.

**Syntax** `ip name-server <ip-addr>`  
`no ip name-server <ip-addr>`

Parameter	Description
<code>&lt;ip-addr&gt;</code>	The IP address of the DNS server that is being added to the name server list. The address is entered in the form A.B.C.D for an IPv4 address, or in the form X:X::X:X for an IPv6 address. The order that you enter the servers in, is the order in which they will be used.

**Mode** Global Configuration

**Usage notes** To allow the device to operate as a DNS proxy, your device must have learned about a DNS name-server to forward requests to. Name-servers can be learned through the following means:

- Manual configuration, using the **ip name-server** command
- Learned from DHCP server with Option 6

Use this command to statically configure a DNS name-server for the device to use.

The order that you enter the servers in, is the order in which they will be used.

**Examples** To allow a device to send DNS queries to a DNS server with the IPv4 address 10.10.10.5, use the commands:

```
awplus# configure terminal
awplus(config)# ip name-server 10.10.10.5
```

To enable your device to send DNS queries to a DNS server with the IPv6 address 2001:0db8:010d::1, use the commands:

```
awplus# configure terminal
awplus(config)# ip name-server 2001:0db8:010d::1
```

**Related commands**

- [ip domain-list](#)
- [ip domain-lookup](#)
- [ip domain-name](#)
- [show ip name-server](#)

**Command changes** Version 5.4.6-2.1: VRF-lite support added to AR-series devices.

# ip name-server preferred-order

**Overview** Use this command to choose between using statically-configured DNS servers or dynamically-learned DNS servers.

Use the **no** variant of this command to set the DNS servers back to the default setting of dynamic.

**Syntax** `ip name-server preferred-order {dynamic|static}`  
`no ip name-server preferred-order`

Parameter	Description
dynamic	Use dynamically learned DNS servers first.
static	Use statically configured DNS servers first.

**Default** dynamic

**Mode** Global Configuration

**Usage notes** This command is used to choose which DNS server set to use first. Select either the **dynamic** or **static** parameter.

**Examples** To configure the preference to use static servers first, use the commands:

```
awplus# configure terminal
awplus(config)# ip name-server preferred-order static
```

To configure the preference to use dynamically-learned servers first, use the commands:

```
awplus# configure terminal
awplus(config)# ip name-server preferred-order dynamic
```

or

```
awplus# configure terminal
awplus(config)# no ip name-server preferred-order
```

**Related commands** [ip address dhcp](#)  
[ip name-server](#)  
[show ip name-server](#)

**Command changes** Version 5.4.9-0.1: command added

# show hosts

**Overview** This command shows the default domain, domain list, and name servers configured on your device.

For information on filtering and saving command output, see the [“Getting Started with AlliedWare Plus” Feature Overview and Configuration Guide](#).

**Syntax** show hosts

**Mode** User Exec and Privileged Exec

**Example** To display the default domain, use the command:

```
awplus# show hosts
```

**Output** Figure 20-1: Example output from the **show hosts** command when **no ip domain-lookup** is configured

```
awplus#show hosts

Default domain is not set
Name/address lookup is disabled
```

Figure 20-2: Example output from the **show hosts** command when **ip domain-lookup** is configured

```
awplus#show hosts

Default domain is mycompany.com
Domain list: company.com
Name/address lookup uses domain service
Name servers are 10.10.0.2 10.10.0.88
```

**Related commands** [ip domain-list](#)

[ip domain-lookup](#)

[ip domain-name](#)

[ip name-server](#)

# show ip domain-list

**Overview** This command shows the domains configured in the domain list. The DNS client uses the domains in this list to append incomplete hostnames when sending a DNS inquiry to a DNS server.

For information on filtering and saving command output, see the [“Getting Started with AlliedWare Plus” Feature Overview and Configuration Guide](#).

**Syntax** `show ip domain-list`

**Mode** User Exec and Privileged Exec

**Example** To display the list of domains in the domain list, use the command:

```
awplus# show ip domain-list
```

**Output** Figure 20-3: Example output from the **show ip domain-list** command

```
awplus#show ip domain-list
alliedtelesis.com
mycompany.com
```

**Related commands** [ip domain-list](#)  
[ip domain-lookup](#)

# show ip domain-name

**Overview** This command shows the default domain configured on your device. When there are no entries in the DNS list, the DNS client appends this domain to incomplete hostnames when sending a DNS inquiry to a DNS server.

For information on filtering and saving command output, see the [“Getting Started with AlliedWare Plus” Feature Overview and Configuration Guide](#).

**Syntax** `show ip domain-name`

**Mode** User Exec and Privileged Exec

**Example** To display the default domain configured on your device, use the command:

```
awplus# show ip domain-name
```

**Output** Figure 20-4: Example output from the **show ip domain-name** command

```
awplus#show ip domain-name
alliedtelesis.com
```

**Related commands** [ip domain-name](#)  
[ip domain-lookup](#)

# show ip name-server

**Overview** This command displays a list of IPv4 and IPv6 DNS server addresses that your device will send DNS requests to. This is a static list configured using the `ip name-server` command.

For information on filtering and saving command output, see the [“Getting Started with AlliedWare Plus” Feature Overview and Configuration Guide](#).

**Syntax** `show ip name-server`

**Mode** User Exec and Privileged Exec

**Example** To display the list of DNS servers that your device sends DNS requests to, use the command:

```
awplus# show ip name-server
```

**Output** Figure 20-5: Example output from the `show ip name-server` command

```
awplus# show ip name-server
10.10.0.123
10.10.0.124
2001:0db8:010d::1
```

**Related commands** [ip domain-lookup](#)  
[ip name-server](#)



# 21

# IPv6 Commands

## Introduction

**Overview** This chapter provides an alphabetical reference of commands used to configure IPv6. For more information, see the [IPv6 Feature Overview and Configuration Guide](#).

- Command List**
- “clear ipv6 neighbors” on page 699
  - “ipv6 address” on page 700
  - “ipv6 address autoconfig” on page 702
  - “ipv6 address suffix” on page 704
  - “ipv6 enable” on page 705
  - “ipv6 eui64-linklocal” on page 707
  - “ipv6 forwarding” on page 708
  - “ipv6 nd accept-ra-pinfo” on page 709
  - “ipv6 nd current-hoplimit” on page 710
  - “ipv6 nd managed-config-flag” on page 711
  - “ipv6 nd minimum-ra-interval” on page 712
  - “ipv6 nd other-config-flag” on page 713
  - “ipv6 nd prefix” on page 714
  - “ipv6 nd ra-interval” on page 716
  - “ipv6 nd ra-lifetime” on page 717
  - “ipv6 nd rguard” on page 718
  - “ipv6 nd reachable-time” on page 720
  - “ipv6 nd retransmission-time” on page 721
  - “ipv6 nd suppress-ra” on page 722

- [“ipv6 neighbor”](#) on page 723
- [“ipv6 opportunistic-nd”](#) on page 724
- [“ipv6 route”](#) on page 725
- [“ipv6 unreachable”](#) on page 726
- [“optimistic-nd”](#) on page 727
- [“ping ipv6”](#) on page 728
- [“show ipv6 forwarding”](#) on page 730
- [“show ipv6 interface brief”](#) on page 731
- [“show ipv6 neighbors”](#) on page 732
- [“show ipv6 route”](#) on page 733
- [“show ipv6 route summary”](#) on page 735
- [“traceroute ipv6”](#) on page 736

# clear ipv6 neighbors

**Overview** Use this command to clear all dynamic IPv6 neighbor entries.

**Syntax** `clear ipv6 neighbors`

**Mode** Privileged Exec

**Example** `awplus# clear ipv6 neighbors`

# ipv6 address

**Overview** Use this command to set the IPv6 address of an interface. The command also enables IPv6 on the interface, which creates an EUI-64 link-local address as well as enabling RA processing and SLAAC.

To stop the device from processing prefix information (routes and addresses from the received Router Advertisements) use the command **no ipv6 nd accept-ra-pinfo**.

To remove the EUI-64 link-local address, use the command **no ipv6 eui64-linklocal**.

Use the **no** variant of this command to remove the IPv6 address assigned and disable IPv6. Note that if no global addresses are left after removing the IPv6 address then IPv6 is disabled.

**Syntax** `ipv6 address <ipv6-addr/prefix-length>`  
`no ipv6 address <ipv6-addr/prefix-length>`

Parameter	Description
<code>&lt;ipv6-addr/prefix-length&gt;</code>	Specifies the IPv6 address to be set. The IPv6 address uses the format X:X::X/Prefix-Length. The prefix-length is usually set between 0 and 64.

**Mode** Interface Configuration for a VLAN interface.

**Usage notes** Note that link-local addresses are retained in the system until they are negated by using the **no** variant of the command that established them. See the [ipv6 enable](#) command for more information.

Also note that the link-local address is retained in the system if the global address is removed using another command, which was not used to establish the link-local address. For example, if a link local address is established with the [ipv6 enable](#) command then it will not be removed using a **no ipv6 address** command.

**Examples** To assign the IPv6 address 2001:0db8::a2/64 to the VLAN interface vlan2, use the following commands:

```
awplus# configure terminal
awplus(config)# interface vlan2
awplus(config-if)# ipv6 address 2001:0db8::a2/64
```

To remove the IPv6 address 2001:0db8::a2/64 from the VLAN interface vlan2, use the following commands:

```
awplus# configure terminal
awplus(config)# interface vlan2
awplus(config-if)# no ipv6 address 2001:0db8::a2/64
```

**Related commands**

- ipv6 address autoconfig
- ipv6 enable
- ipv6 eui64-linklocal
- show running-config
- show ipv6 interface brief
- show ipv6 route

# ipv6 address autoconfig

**Overview** Use this command to enable IPv6 stateless address autoconfiguration (SLAAC) for an interface. This configures an IPv6 address on an interface derived from the MAC address on the interface.

Use the **no** variant of this command to disable IPv6 SLAAC on an interface. Note that if no global addresses are left after removing all IPv6 autoconfigured addresses then IPv6 is disabled.

**Syntax** `ipv6 address autoconfig`  
`no ipv6 address autoconfig`

**Mode** Interface Configuration for a VLAN interface.

**Usage notes** Use this command to enable automatic configuration of IPv6 addresses using stateless autoconfiguration on an interface and enables IPv6.

IPv6 hosts can configure themselves when connected to an IPv6 network using ICMPv6 (Internet Control Message Protocol version 6) router discovery messages. Configured routers respond with a Router Advertisement (RA) containing configuration parameters for IPv6 hosts.

The SLAAC process derives the interface identifier of the IPv6 address from the MAC address of the interface. When applying SLAAC to an interface, note that the MAC address of the default VLAN is applied to the interface if the interface does not have its own MAC address.

Note that link-local addresses are retained in the system until they are negated by using the no variant of the command that established them. See the [ipv6 enable](#) command for more information.

Also note that the link-local address is retained in the system if the global address is removed using another command that was not used to establish the link-local address. For example, if a link local address is established with the [ipv6 enable](#) command then it will not be removed using a **no ipv6 address** command.

**Examples** To enable SLAAC on vlan2, use the following commands:

```
awplus# configure terminal
awplus(config)# interface vlan2
awplus(config-if)# ipv6 address autoconfig
```

To disable SLAAC on vlan2, use the following commands:

```
awplus# configure terminal
awplus(config)# interface vlan2
awplus(config-if)# no ipv6 address autoconfig
```

**Related commands**

- ipv6 address
- ipv6 enable
- show ipv6 interface brief
- show running-config

# ipv6 address suffix

**Overview** Use this command to configure the suffix to use when generating an address from prefix information. Any addresses that were created with the EUI-64 suffix will be removed, and new addresses will be added after the next Router Advertisement.

Use the **no** variant of this command to set it back to the default of disabled or set to `::` for the same result as the **no** variant.

**Syntax** `ipv6 address suffix <ipv6-addr-suffix>`  
`no ipv6 address suffix`

Parameter	Description
<code>&lt;ipv6-addr-suffix&gt;</code>	In the format of <code>::X:X:X</code> , for example <code>::a2d8:0fd8</code>

**Default** Disabled

**Mode** Interface Configuration

**Example** To configure the suffix to use when generating an address from prefix information on `vlan2`, use the command:

```
awplus# configure terminal
awplus(config)# interface vlan2
awplus(config-if)# ipv6 address suffix ::a2d8:0fd8
```

**Related commands** [ipv6 nd accept-ra-pinfo](#)  
[show running-config interface](#)

**Command changes** Version 5.4.8-2.1: command added



# ipv6 enable

**Overview** Use this command to enable automatic configuration of a link-local IPv6 address on an interface using Stateless Automatic Address Configuration (SLAAC). By default, the EUI-64 method is used to generate the link-local address.

Use the **no** variant of this command to disable IPv6 on an interface without a global address. Note, to stop EUI-64 from generating the automatic link-local address, use the command **no ipv6 eui64-linklocal**.

**Syntax** `ipv6 enable`  
`no ipv6 enable`

**Mode** Interface Configuration for a VLAN interface.

**Usage notes** The **ipv6 enable** command automatically configures an IPv6 link-local address on the interface and enables the interface for IPv6 processing.

A link-local address is an IP (Internet Protocol) address that is only used for communications in the local network, or for a point-to-point connection. Routing does not forward packets with link-local addresses. IPv6 requires that a link-local address is assigned to each interface that has the IPv6 protocol enabled, and when addresses are assigned to interfaces for routing IPv6 packets.

Note that link-local addresses are retained in the system until they are negated by using the no variant of the command that established them.

Also note that the link-local address is retained in the system if the global address is removed using another command that was not used to establish the link-local address. For example, if a link local address is established with the **ipv6 enable** command then it will not be removed using a **no ipv6 address** command.

**Default** All interfaces default to IPv6-down with no address.

**Examples** To enable IPv6 with only a link-local IPv6 address on the VLAN interface vlan2, use the following commands:

```
awplus# configure terminal
awplus(config)# interface vlan2
awplus(config-if)# ipv6 enable
```

To disable IPv6 with only a link-local IPv6 address on the VLAN interface vlan2, use the following commands:

```
awplus# configure terminal
awplus(config)# interface vlan2
awplus(config-if)# no ipv6 enable
```

**Related commands**

- ipv6 address
- ipv6 address autoconfig
- show ipv6 interface brief
- show ipv6 route
- show running-config

# ipv6 eui64-linklocal

**Overview** When IPv6 is enabled on an interface, an EUI link-local address is generated and installed on the interface. In other words, **ipv6 eui64-linklocal** is enabled by default on any IPv6 enabled interface.

Use the **no** variant of this command to disallow the automatic generation of the EUI-64 link-local address on an IPv6 enabled interface.

**Syntax** `ipv6 eui64-linklocal`  
`no ipv6 eui64-linklocal`

**Default** The command **ipv6 eui64-linklocal** is enabled by default on any IPv6 enabled interface.

**Mode** Interface

**Example** To enable IPv6 on the interface vlan1, and use the link-local address of fe80::1/10 instead of the EUI-64 link-local that is automatically generated, use the following commands:

```
awplus# configure terminal
awplus(config)# interface vlan1
awplus(config-if)# ipv6 enable
awplus(config-if)# no ipv6 eui64-linklocal
awplus(config-if)# ipv6 address fe80::1/10
```

**Related commands** [ipv6 address](#)  
[ipv6 address autoconfig](#)  
[ipv6 enable](#)

**Command changes** Version 5.4.7-0.1: command added

# ipv6 forwarding

**Overview** Use this command to turn on IPv6 unicast routing for IPv6 packet forwarding. Use this command globally on your device before using the `ipv6 enable` command on individual interfaces. Use the **no** variant of this command to turn off IPv6 unicast routing. Note IPv6 unicast routing is disabled by default.

**Syntax** `ipv6 forwarding`  
`no ipv6 forwarding`

**Mode** Global Configuration

**Default** IPv6 unicast forwarding is disabled by default.

**Usage notes** Enable IPv6 unicast forwarding globally for all interfaces on your device with this command. Use the **no** variant of this command to disable IPv6 unicast forwarding globally for all interfaces on your device.

IPv6 unicast forwarding allows devices to communicate with devices that are more than one hop away, providing that there is a route to the destination address. If IPv6 forwarding is not enabled then pings to addresses on devices that are more than one hop away will fail, even if there is a route to the destination address.

**Examples** To enable IPv6 unicast routing, use the commands:

```
awplus# configure terminal
awplus(config)# ipv6 forwarding
```

To disable IPv6 unicast routing, use the commands:

```
awplus# configure terminal
awplus(config)# no ipv6 forwarding
```

**Related commands** [ipv6 enable](#)

# ipv6 nd accept-ra-pinfo

**Overview** Use this command to allow the processing of the prefix information included in a received RA (Router Advertisement) on an IPv6 enabled interface.

Use the **no** variant of this command to disable an IPv6 interface from using the prefix information within a received RA.

**Syntax** `ipv6 nd accept-ra-pinfo`  
`no ipv6 nd accept-ra-pinfo`

**Default** The command **ipv6 nd accept-ra-pinfo** is enabled by default on any IPv6 interface.

**Mode** Interface

**Usage notes** By default, when IPv6 is enabled on an interface, SLAAC is also enabled. SLAAC addressing along with the EUI-64 process, uses the prefix information included in a received RA to generate an automatic link-local address on the IPv6 interface.

Note: an AlliedWare Plus device will, by default, add a prefix for the connected interface IPv6 address(es) to the RA it transmits. However, this behavior can be changed by using the command **no ipv6 nd prefix auto-advertise**, so there is no guarantee that an RA will contain a prefix.

**Example** To enable IPv6 on vlan1 without installing a SLAAC address on the interface, use the following commands:

```
awplus# configure terminal
awplus(config)# interface vlan1
awplus(config-if)# ipv6 enable
awplus(config-if)# no ipv6 nd accept-ra-pinfo
```

**Related commands** [ipv6 address](#)  
[ipv6 address autoconfig](#)  
[ipv6 enable](#)

**Command changes** Version 5.4.7-0.1: command added

# ipv6 nd current-hoplimit

**Overview** Use this command to specify the advertised current hop limit used between IPv6 Routers.

Use the **no** variant of this command to reset the current advertised hop limit to its default "0".

**Syntax** `ipv6 nd current-hoplimit <hoplimit>`  
`no ipv6 nd current-hoplimit`

Parameter	Description
<code>&lt;hoplimit&gt;</code>	Specifies the advertised current hop limit value. Valid values are from 0 to 255 hops.

**Default** 0 (No advertised current hop limit specified)

**Mode** Interface Configuration for a VLAN interface.

**Examples** To set the advertised current hop limit to 2 between IPv6 Routers on vlan2, use the following commands:

```
awplus# configure terminal
awplus(config)# interface vlan2
awplus(config-if)# ipv6 nd current-hoplimit 2
```

To reset the advertised current hop limit to the default 0 on vlan2, use the following commands:

```
awplus# configure terminal
awplus(config)# interface vlan2
awplus(config-if)# no ipv6 nd current-hoplimit
```

**Related commands** [ipv6 nd managed-config-flag](#)  
[ipv6 nd prefix](#)  
[ipv6 nd suppress-ra](#)

# ipv6 nd managed-config-flag

**Overview** Use this command to set the managed address configuration flag, contained within the router advertisement field.

Setting this flag indicates the operation of a stateful autoconfiguration protocol such as DHCPv6 for address autoconfiguration, and that address information (i.e. the network prefix) and other (non-address) information can be requested from the device.

An unset flag enables hosts receiving the advertisements to use a stateless autoconfiguration mechanism to establish their IPv6 addresses. The default is flag unset.

Use the **no** variant of this command to reset this command to its default of having the flag unset.

**Syntax** `ipv6 nd managed-config-flag`  
`no ipv6 nd managed-config-flag`

**Default** Unset

**Mode** Interface Configuration for a VLAN interface.

**Usage notes** Advertisement flags will not be transmitted unless you have applied the `ipv6 nd suppress-ra` command. This step is included in the example below.

**Example** To set the managed address configuration flag on the VLAN interface `vlan2`, use the following commands:

```
awplus# configure terminal
awplus(config)# interface vlan2
awplus(config-if)# ipv6 nd managed-config-flag
awplus(config-if)# no ipv6 nd suppress-ra
```

**Related commands** `ipv6 nd suppress-ra`  
`ipv6 nd prefix`  
`ipv6 nd other-config-flag`

# ipv6 nd minimum-ra-interval

**Overview** Use this command in Interface Configuration mode to set a minimum Router Advertisement (RA) interval for a VLAN interface.

Use the **no** variant of this command in Interface Configuration mode to remove the minimum RA interval for a VLAN interface.

**Syntax** `ipv6 nd minimum-ra-interval <seconds>`  
`no ipv6 nd minimum-ra-interval`

Parameter	Description
<code>&lt;seconds&gt;</code>	Specifies the number of seconds between IPv6 Router Advertisements (RAs). Valid values are from 3 to 1350 seconds.

**Default** The RA interval for a VLAN interface is unset by default.

**Mode** Interface Configuration for a VLAN interface.

**Examples** To set the minimum RA interval for the VLAN interface `vlan2`, use the following commands:

```
awplus# configure terminal
awplus(config)# interface vlan2
awplus(config-if)# ipv6 nd minimum-ra-interval 60
```

To remove the minimum RA interval for the VLAN interface `vlan2`, use the following commands:

```
awplus# configure terminal
awplus(config)# interface vlan2
awplus(config-if)# no ipv6 nd minimum-ra-interval
```

**Related commands**

- [ipv6 nd ra-interval](#)
- [ipv6 nd suppress-ra](#)
- [ipv6 nd prefix](#)
- [ipv6 nd other-config-flag](#)



# ipv6 nd other-config-flag

**Overview** Use this command to set the **other** stateful configuration flag (contained within the router advertisement field) to be used for IPv6 address auto-configuration. This flag is used to request the router to provide information in addition to providing addresses.

Setting the `ipv6 nd managed-config-flag` command implies that the `ipv6 nd other-config-flag` will also be set.

Use **no** variant of this command to reset the value to the default.

**Syntax** `ipv6 nd other-config-flag`  
`no ipv6 nd other-config-flag`

**Default** Unset

**Mode** Interface Configuration for a VLAN interface.

**Usage notes** Advertisement flags will not be transmitted unless you have applied the `ipv6 nd suppress-ra` command. This step is included in the example below.

**Example** To set the IPv6 other-config-flag on the VLAN interface vlan2, use the following commands:

```
awplus# configure terminal
awplus(config)# interface vlan2
awplus(config-if)# ipv6 nd other-config-flag
awplus(config-if)# no ipv6 nd suppress-ra
```

**Related commands** `ipv6 nd suppress-ra`  
`ipv6 nd prefix`  
`ipv6 nd managed-config-flag`

# ipv6 nd prefix

**Overview** Use this command in Interface Configuration mode for a VLAN interface to specify the IPv6 prefix information that is advertised by the router advertisement for IPv6 address auto-configuration.

Use the **no** parameter with this command to reset the IPv6 prefix for a VLAN interface in Interface Configuration mode.

**Syntax**

```

ipv6 nd prefix <ipv6-prefix/length>
ipv6 nd prefix <ipv6-prefix/length> [<valid-lifetime>]
ipv6 nd prefix <ipv6-prefix/length>
<valid-lifetime><preferred-lifetime> [no-autoconfig]
ipv6 nd prefix <ipv6-prefix/length>
<valid-lifetime><preferred-lifetime> off-link [no-autoconfig]
no ipv6 nd prefix [<ipv6-addr/prefix-length>|all]

```

Parameter	Description
<i>&lt;ipv6-prefix/length&gt;</i>	The prefix to be advertised by the router advertisement message. The IPv6 address prefix uses the format X:X::/prefix-length. The prefix-length is usually set between 0 and 64. The default is X:X::/64.
<i>&lt;valid-lifetime&gt;</i>	The the period during which the specified IPv6 address prefix is valid. This can be set to a value between 0 and 4294967295 seconds. The default is 2592000 (30 days). Note that this period should be set to a value greater than that set for the prefix preferred-lifetime.
<i>&lt;preferred-lifetime&gt;</i>	Specifies the IPv6 prefix preferred lifetime. This is the period during which the IPv6 address prefix is considered a current (undeprecated) value. After this period, the command is still valid but should not be used in new communications. Set to a value between 0 and 4294967295 seconds. The default is 604800 seconds (7 days). Note that this period should be set to a value less than that set for the prefix valid-lifetime.
off-link	Specify the IPv6 prefix off-link flag. The default is flag set.
no-autoconfig	Specify the IPv6 prefix no autoconfiguration flag. Setting this flag indicates that the prefix is not to be used for autoconfiguration. The default is flag set.
all	Specify all IPv6 prefixes associated with the VLAN interface.

**Default** Valid-lifetime default is 2592000 seconds (30 days). Preferred-lifetime default is 604800 seconds (7 days).

**Mode** Interface Configuration for a VLAN interface.

**Usage notes** This command specifies the IPv6 prefix flags that are advertised by the router advertisement message.

**Examples** To configure the device to issue router advertisements on vlan2, and advertise the address prefix of 2001:0db8::/64, use the commands:

```
awplus# configure terminal
awplus(config)# interface vlan2
awplus(config-if)# ipv6 nd prefix 2001:0db8::/64
```

To configure the device to issue router advertisements on vlan2, and advertise the address prefix of 2001:0db8::/64 with a valid lifetime of 10 days and a preferred lifetime of 5 days, use the commands:

```
awplus# configure terminal
awplus(config)# interface vlan2
awplus(config-if)# ipv6 nd prefix 2001:0db8::/64 864000 432000
```

To configure the device to issue router advertisements on vlan2 and advertise the address prefix of 2001:0db8::/64 with a valid lifetime of 10 days, a preferred lifetime of 5 days, and no prefix used for autoconfiguration, use the commands:

```
awplus# configure terminal
awplus(config)# interface vlan2
awplus(config-if)# ipv6 nd prefix 2001:0db8::/64 864000 432000
no-autoconfig
```

To reset router advertisements on vlan2, so the address prefix of 2001:0db8::/64 is not advertised from the device, use the commands:

```
awplus# configure terminal
awplus(config)# interface vlan2
awplus(config-if)# no ipv6 nd prefix 2001:0db8::/64
```

To reset all router advertisements on vlan2, use the commands:

```
awplus# configure terminal
awplus(config)# interface vlan2
awplus(config-if)# no ipv6 nd prefix all
```

**Related commands** [ipv6 nd suppress-ra](#)

# ipv6 nd ra-interval

**Overview** Use this command to specify the interval between IPv6 Router Advertisements (RA) transmissions.

Use **no** parameter with this command to reset the value to the default value (600 seconds).

**Syntax** `ipv6 nd ra-interval <seconds>`  
`no ipv6 nd ra-interval`

Parameter	Description
<code>&lt;seconds&gt;</code>	Specifies the number of seconds between IPv6 Router Advertisements (RAs). Valid values are from 4 to 1800 seconds.

**Default** 600 seconds.

**Mode** Interface Configuration for a VLAN interface.

**Usage notes** Advertisement flags will not be transmitted unless you have applied the `ipv6 nd suppress-ra` command as shown in the example below.

**Example** To set the advertisements interval on `vlan2` to be 60 seconds, use the following commands:

```
awplus# configure terminal
awplus(config)# interface vlan2
awplus(config-if)# ipv6 nd ra-interval 60
awplus(config-if)# no ipv6 nd suppress-ra
```

**Related commands** [ipv6 nd minimum-ra-interval](#)  
[ipv6 nd suppress-ra](#)  
[ipv6 nd prefix](#)

# ipv6 nd ra-lifetime

**Overview** Use this command to specify the time period that this router can usefully act as a default gateway for the network. Each router advertisement resets this time period.

Use **no** parameter with this command to reset the value to default.

**Syntax** `ipv6 nd ra-lifetime <seconds>`  
`no ipv6 nd ra-lifetime`

Parameter	Description
<code>&lt;seconds&gt;</code>	Time period in seconds. Valid values are from 0 to 9000. Note that you should set this time period to a value greater than the value you have set using the <a href="#">ipv6 nd ra-interval</a> command.

**Default** 1800 seconds

**Mode** Interface Configuration for a VLAN interface.

**Usage notes** This command specifies the lifetime of the current router to be announced in IPv6 Router Advertisements.

Advertisement flags will not be transmitted unless you have applied the [ipv6 nd suppress-ra](#) command. This instruction is included in the example shown below.

**Examples** To set the advertisement lifetime of 8000 seconds on the VLAN interface `vlan2`, use the following commands:

```
awplus# configure terminal
awplus(config)# interface vlan2
awplus(config-if)# ipv6 nd ra-lifetime 8000
awplus(config-if)# no ipv6 nd suppress-ra
```

**Related commands** [ipv6 nd suppress-ra](#)  
[ipv6 nd prefix](#)

# ipv6 nd rguard

**Overview** Use this command to apply the Router Advertisements (RA) Guard feature from the Interface Configuration mode for a device port. This blocks all RA messages received on a device port.

For more information about RA Guard, see the [IPv6 Feature Overview and Configuration Guide](#).

Use the **no** parameter with this command to disable RA Guard for a specified device port.

**Syntax** `ipv6 nd rguard`  
`no ipv6 nd rguard`

**Default** RA Guard is not disabled by default.

**Mode** Interface Configuration for a port.

**Usage notes** Router Advertisements (RAs) are used by Routers to announce themselves on the link. Applying RA Guard to a device port disallows Router Advertisements and redirect messages. RA Guard blocks RAs from untrusted hosts. Blocking RAs stops untrusted hosts from flooding malicious RAs and stops any misconfigured hosts from disrupting traffic on the local network.

Enabling RA Guard on a port blocks RAs from a connected host and indicates the port and host are untrusted. Disabling RA Guard on a port allows RAs from a connected host and indicates the port and host are trusted. Ports and hosts are trusted by default to allow RAs.

**Example** To enable RA Guard on port1.0.1-port1.0.4, use the following commands:

```
awplus# configure terminal
awplus(config)# interface port1.0.1-port1.0.4
awplus(config-if)# ipv6 nd rguard
```

To verify RA Guard is enabled on port1.0.1, use the command:

```
awplus# show running-config interface port1.0.1
```

To disable RA Guard on port1.0.1-port1.0.4, use the following commands:

```
awplus# configure terminal
awplus(config)# interface port1.0.1-port1.0.4
awplus(config-if)# no ipv6 nd rguard
```

When RA Guard is disabled on a port it is not displayed in **show running-config** output.

**Output** Example output from using **show running-config interface port1.0.1** to verify RA Guard:

```
!  
interface port1.0.1  
  switchport mode access  
  
  ipv6 nd raguard  
!
```

**Related commands** [show running-config interface](#)

# ipv6 nd reachable-time

**Overview** Use this command to specify the reachable time in the router advertisement to be used for detecting reachability of the IPv6 neighbor.

Use the **no** variant of this command to reset the value to default.

**Syntax** `ipv6 nd reachable-time <milliseconds>`  
`no ipv6 nd reachable-time`

Parameter	Description
<milliseconds>	Time period in milliseconds. Valid values are from 1000 to 3600000. Setting this value to 0 indicates an unspecified reachable-time.

**Default** 0 milliseconds

**Mode** Interface Configuration for a VLAN interface.

**Usage notes** This command specifies the reachable time of the current router to be announced in IPv6 Router Advertisements.

Advertisement flags will not be transmitted unless you have applied the [ipv6 nd suppress-ra](#) command. This instruction is included in the example shown below.

**Example** To set the reachable-time in router advertisements on the VLAN interface vlan2 to be 1800000 milliseconds, enter the following commands:

```
awplus# configure terminal
awplus(config)# interface vlan2
awplus(config-if)# ipv6 nd reachable-time 1800000
awplus(config-if)# no ipv6 nd suppress-ra
```

To reset the reachable-time in router advertisements on the VLAN interface vlan2 to an unspecified reachable-time (0 milliseconds), enter the following commands:

```
awplus# configure terminal
awplus(config)# interface vlan2
awplus(config-if)# no ipv6 nd reachable-time
```

**Related commands** [ipv6 nd suppress-ra](#)  
[ipv6 nd prefix](#)



# ipv6 nd retransmission-time

**Overview** Use this command to specify the advertised retransmission interval for Neighbor Solicitation in milliseconds between IPv6 Routers.

Use the **no** variant of this command to reset the retransmission time to the default (1 second).

**Syntax** `ipv6 nd retransmission-time <milliseconds>`  
`no ipv6 nd retransmission-time`

Parameter	Description
<code>&lt;milliseconds&gt;</code>	Time period in milliseconds. Valid values are from 1000 to 3600000.

**Default** 1000 milliseconds (1 second)

**Mode** Interface Configuration for a VLAN interface.

**Examples** To set the retransmission-time of Neighbor Solicitation on the VLAN interface `vlan2` to be 800000 milliseconds, enter the following commands:

```
awplus# configure terminal
awplus(config)# interface vlan2
awplus(config-if)# ipv6 nd retransmission-time 800000
```

To reset the retransmission-time of Neighbor Solicitation on the VLAN interface `vlan2` to the default 1000 milliseconds (1 second), enter the following commands:

```
awplus# configure terminal
awplus(config)# interface vlan2
awplus(config-if)# no ipv6 nd retransmission-time
```

**Related commands** [ipv6 nd suppress-ra](#)  
[ipv6 nd prefix](#)

# ipv6 nd suppress-ra

**Overview** Use this command to inhibit IPv6 Router Advertisement (RA) transmission for the current interface. Router advertisements are used when applying IPv6 stateless auto-configuration.

Use **no** parameter with this command to enable Router Advertisement transmission.

**Syntax** `ipv6 nd suppress-ra`  
`no ipv6 nd suppress-ra`

**Default** Router Advertisement (RA) transmission is suppressed by default.

**Mode** Interface Configuration for a VLAN interface.

**Example** To enable the transmission of router advertisements from vlan2 on the device, use the following commands:

```
awplus# configure terminal
awplus(config)# interface vlan2
awplus(config-if)# no ipv6 nd suppress-ra
```

**Related commands** [ipv6 nd ra-interval](#)  
[ipv6 nd prefix](#)

# ipv6 neighbor

**Overview** Use this command to add a static IPv6 neighbor entry.  
Use the **no** variant of this command to remove a specific IPv6 neighbor entry.

**Syntax** `ipv6 neighbor <ipv6-address> <vlan-name> <mac-address>  
<port-list>`  
`no ipv6 neighbor <ipv6-address> <vlan-name> <port-list>`

Parameter	Description
<code>&lt;ipv6-address&gt;</code>	Specify the neighbor's IPv6 address in the format X:X::X:X.
<code>&lt;vlan-name&gt;</code>	Specify the neighbor's VLAN name.
<code>&lt;mac-address&gt;</code>	Specify the MAC hardware address in hexadecimal notation in the format HHHH.HHHH.HHHH.
<code>&lt;port-list&gt;</code>	Specify the port number, or port range.

**Mode** Global Configuration

**Usage notes** Use this command to clear a specific IPv6 neighbor entry. To clear all dynamic address entries, use the [clear ipv6 neighbors](#) command.

**Example** To create a static neighbor entry for IPv6 address 2001:0db8::a2, on vlan2, with MAC address 0000.cd28.0880, on port1.0.1, use the command:

```
awplus# configure terminal
awplus(config)# ipv6 neighbor 2001:0db8::a2 vlan2
0000.cd28.0880 port1.0.1
```

**Related commands** [clear ipv6 neighbors](#)

# ipv6 opportunistic-nd

**Overview** Use this command to enable opportunistic neighbor discovery for the global IPv6 ND cache. Opportunistic neighbor discovery changes the behavior for unsolicited ICMPv6 ND packet forwarding on the device.

Use the **no** variant of this command to disable opportunistic neighbor discovery for the global IPv6 ND cache.

**Syntax** `ipv6 opportunistic-nd`  
`no ipv6 opportunistic-nd`

**Default** Opportunistic neighbor discovery is disabled by default.

**Mode** Global Configuration

**Usage notes** When opportunistic neighbor discovery is enabled, the device will reply to any received unsolicited ICMPv6 ND packets. The source MAC address for the unsolicited ICMPv6 ND packet is added to the IPv6 ND cache, so the device forwards the ICMPv6 ND packet. When opportunistic neighbor discovery is disabled, the source MAC address for the ICMPv6 packet is not added to the IPv6 ND cache, so the ICMPv6 ND packet is not forwarded by the device.

**Examples** To enable opportunistic neighbor discovery for the IPv6 ND cache, enter:

```
awplus# configure terminal
awplus(config)# ipv6 opportunistic-nd
```

To disable opportunistic neighbor discovery for the IPv6 ND cache, enter:

```
awplus# configure terminal
awplus(config)# no ipv6 opportunistic-nd
```

**Related commands** [arp opportunistic-nd](#)  
[show ipv6 neighbors](#)  
[show running-config interface](#)

# ipv6 route

**Overview** This command adds a static IPv6 route to the Routing Information Base (RIB). If this route is the best route for the destination, then your device adds it to the Forwarding Information Base (FIB). Your device uses the FIB to advertise routes to neighbors and forward packets.

The **no** variant of this command removes the static route.

**Syntax** `ipv6 route <dest-prefix> <dest-prefix/length> {<gateway-ip>|<gateway-name>} [<distvalue>]`  
`no ipv6 route <dest-prefix> <dest-prefix/length> {<gateway-ip>|<gateway-name>} [<distvalue>]`

Parameter	Description
<code>&lt;dest-prefix/length&gt;</code>	Specifies the IP destination prefix. The IPv6 address prefix uses the format X:X::/prefix-length. The prefix-length is usually set between 0 and 64.
<code>&lt;gateway-ip&gt;</code>	Specifies the IP gateway (or next hop) address. The IPv6 address uses the format X:X::X:Prefix-Length. The prefix-length is usually set between 0 and 64.
<code>&lt;gateway-name&gt;</code>	Specifies the name of the gateway (or next hop) interface.
<code>&lt;distvalue&gt;</code>	Specifies the administrative distance for the route. Valid values are from 1 to 255.

**Mode** Global Configuration

**Usage notes** You can use administrative distance to determine which routes take priority over other routes.

**Example** `awplus# configure terminal`  
`awplus(config)# ipv6 route 2001:0db8::1/128 vlan2 32`

**Validation Commands** `show running-config`  
`show ipv6 route`

# ipv6 unreachable

**Overview** Use this command to enable ICMPv6 (Internet Control Message Protocol version 6) type 1, destination unreachable, messages.

Use the **no** variant of this command to disable destination unreachable messages. This prevents an attacker from using these messages to discover the topology of a network.

**Syntax** `ipv6 unreachable`  
`no ipv6 unreachable`

**Default** Destination unreachable messages are enabled by default.

**Mode** Global Configuration

**Usage notes** When a device receives a packet for a destination that is unreachable it returns an ICMPv6 type 1 message. This message includes a reason code, as per the table below. An attacker can use these messages to obtain information regarding the topology of a network. Disabling destination unreachable messages, using the **no ipv6 unreachable** command, secures your network against this type of probing.

**NOTE:** *Disabling ICMPv6 destination unreachable messages breaks applications such as traceroute, which depend on these messages to operate correctly.*

Table 21-1: ICMPv6 type 1 reason codes and description

Code	Description [RFC]
0	No route to destination [RFC4443]
1	Communication with destination administratively prohibited [RFC4443]
2	Beyond scope of source address [RFC4443]
3	Address unreachable [RFC4443]
4	Port unreachable [RFC4443]
5	Source address failed ingress/egress policy [RFC4443]
6	Reject route to destination [RFC4443]
7	Error in Source Routing Header [RFC6554]

**Example** To disable destination unreachable messages, use the commands

```
awplus# configure terminal
awplus(config)# no ipv6 unreachable
```

To enable destination unreachable messages, use the commands

```
awplus# configure terminal
awplus(config)# ipv6 unreachable
```

# optimistic-nd

**Overview** Use this command to enable the optimistic neighbor discovery feature for both IPv4 and IPv6.

Use the **no** variant of this command to disable the optimistic neighbor discovery feature.

**Syntax** `optimistic-nd`  
`no optimistic-nd`

**Default** The optimistic neighbor discovery feature is enabled by default.

**Mode** Interface Configuration for a VLAN interface.

**Usage notes** The optimistic neighbor discovery feature allows the device, after learning an IPv4 or IPv6 neighbor, to refresh the neighbor before the neighbor is deleted from the hardware L3 switching table. The device puts the neighbour entry into the "stale" state in the software switching table if it is not refreshed, then the 'stale' neighbors are deleted from the hardware L3 switching table.

The optimistic neighbor discovery feature enables the device to sustain L3 traffic switching to a neighbor without interruption. Without the optimistic neighbor discovery feature enabled L3 traffic is interrupted when a neighbor is "stale" and is then deleted from the L3 switching table.

If a neighbor receiving optimistic neighbor solicitations does not answer optimistic neighbor solicitations with neighbor advertisements, then the neighbor will be put into the "stale" state, and subsequently deleted from both the software and the hardware L3 switching tables.

**Examples** To enable the optimistic neighbor discovery feature on vlan2, use the following commands:

```
awplus# configure terminal
awplus(config)# interface vlan2
awplus(config-if)# optimistic-nd
```

To disable the optimistic neighbor discovery feature on vlan2, use the following commands:

```
awplus# configure terminal
awplus(config)# interface vlan2
awplus(config-if)# no optimistic-nd
```

**Related commands** [show running-config](#)

# ping ipv6

**Overview** This command sends a query to another IPv6 host (send Echo Request messages).

**Syntax** ping ipv6 {<host>|<ipv6-address>} [repeat {<1-2147483647>|continuous}] [size <10-1452>] [interface <interface-list>] [timeout <1-65535>]

Parameter	Description
<ipv6-addr>	The destination IPv6 address. The IPv6 address uses the format X:X::X:X.
<hostname>	The destination hostname.
repeat	Specify the number of ping packets to send.
<1-2147483647>	Specify repeat count. The default is 5.
size <10-1452>	The number of data bytes to send, excluding the 8 byte ICMP header. The default is 56 (64 ICMP data bytes).
interface <interface-list>	The interface or range of configured IP interfaces to use as the source in the IP header of the ping packet. The interface can be one of: <ul style="list-style-type: none"> <li>• a VLAN (e.g. vlan2)</li> <li>• the loopback interface (lo)</li> <li>• a continuous range of interfaces separated by a hyphen (e.g. vlan10-20)</li> <li>• a comma-separated list (e.g. vlan1,vlan10-20). Do not mix interface types in a list.</li> </ul> You can only specify the interface when pinging a link local address.
timeout <1-65535>	The time in seconds to wait for echo replies if the ARP entry is present, before reporting that no reply was received. If no ARP entry is present, it does not wait.
repeat	Specify the number of ping packets to send.
<1-2147483647>	Specify repeat count. The default is 5.
continuous	Continuous ping.
size <10-1452>	The number of data bytes to send, excluding the 8 byte ICMP header. The default is 56 (64 ICMP data bytes).
timeout <1-65535>	The time in seconds to wait for echo replies if the ARP entry is present, before reporting that no reply was received. If no ARP entry is present, it does not wait.

**Mode** User Exec and Privileged Exec

**Example** awplus# ping ipv6 2001:0db8::a2



**Related  
commands** [traceroute ipv6](#)

# show ipv6 forwarding

**Overview** Use this command to display IPv6 forwarding status.

**Syntax** `show ipv6 forwarding`

**Mode** User Exec and Privileged Exec

**Example** `awplus# show ipv6 forwarding`

**Output** Figure 21-1: Example output from the **show ipv6 forwarding** command

```
ipv6 forwarding is on
```

# show ipv6 interface brief

**Overview** Use this command to display brief information about interfaces and the IPv6 address assigned to them.

For information on filtering and saving command output, see the [“Getting\\_Started with AlliedWare Plus” Feature Overview and Configuration\\_Guide](#).

**Syntax** `show ipv6 interface [brief]`

Parameter	Description
brief	Specify this optional parameter to display brief IPv6 interface information.

**Mode** User Exec and Privileged Exec

**Examples** `awplus# show ipv6 interface brief`

**Output** Figure 21-2: Example output from the **show ipv6 interface brief** command

```
awplus#show ipv6 interface brief
Interface      IPv6-Address          Status      Protocol
lo             unassigned            admin up    running
vlan1          2001:db8::1/48        admin up    down
                fe80::215:77ff:fee9:5c50/64
```

**Related commands** [show interface brief](#)

# show ipv6 neighbors

**Overview** Use this command to display all IPv6 neighbors.

For information on filtering and saving command output, see the [“Getting\\_Started with AlliedWare Plus” Feature Overview and Configuration\\_Guide](#).

**Syntax** `show ipv6 neighbors`

**Mode** User Exec and Privileged Exec

# show ipv6 route

**Overview** Use this command to display the IPv6 routing table for a protocol or from a particular table.

For information on filtering and saving command output, see the [“Getting Started with AlliedWare Plus” Feature Overview and Configuration Guide](#).

**Syntax** `show ipv6 route`  
[ `connected` | `database` | `static` | `summary` | `<ipv6-address>` | `<ipv6-addr/prefix-length>` ]

Parameter	Description
<code>connected</code>	Displays only the routes learned from connected interfaces.
<code>database</code>	Displays only the IPv6 routing information extracted from the database.
<code>static</code>	Displays only the IPv6 static routes you have configured.
<code>summary</code>	Displays summary information from the IPv6 routing table.
<code>&lt;ipv6-address&gt;</code>	Displays the routes for the specified address in the IP routing table. The IPv6 address uses the format X:X::X:X/Prefix-Length. The prefix-length is usually set between 0 and 64.
<code>&lt;ipv6-prefix/length&gt;</code>	Displays only the routes for the specified IP prefix.

**Mode** User Exec and Privileged Exec

**Example** To display an IP route with all parameters turned on, use the following command:

```
awplus# show ipv6 route
```

To display all database entries for an IP route, use the following command:

```
awplus# show ipv6 route database
```

**Output** Figure 21-3: Example output of the **show ipv6 route** command

```
IPv6 Routing Table
Codes: C - connected, S - static, R - RIP, O - OSPF, B - BGP
S   ::/0 [1/0] via 2001::a:0:0:c0a8:a6, vlan10
C   2001:db8::a:0:0:0:0/64 via ::, vlan10
C   2001:db8::14:0:0:0:0/64 via ::, vlan20
C   2001:db8::0:0:0:0:0/64 via ::, vlan30
C   2001:db8::28:0:0:0:0/64 via ::, vlan40
C   2001:db8::fa:0:0:0:0/64 via ::, vlan250
C   2001:db8::/64 via ::, vlan250
C   2001:db8::/64 via ::, vlan40
C   2001:db8::/64 via ::, vlan20
C   2001:db8::/64 via ::, vlan10
```

**Output** Figure 21-4: Example output of the **show ipv6 route database** command

```
IPv6 Routing Table
Codes: C - connected, S - static, R - RIP, O - OSPF, B - BGP
> - selected route, * - FIB route, p - stale info
Timers: Uptime
S   ::/0 [1/0] via 2001::a:0:0:c0a8:a01 inactive, 6d22h12m
      [1/0] via 2001::fa:0:0:c0a8:fa01 inactive, 6d22h12m
```

# show ipv6 route summary

**Overview** Use this command to display the summary of the current NSM RIB entries.  
For information on filtering and saving command output, see the [“Getting Started with AlliedWare Plus” Feature Overview and Configuration Guide](#).

**Syntax** `show ipv6 route summary`

**Mode** User Exec and Privileged Exec

**Example** To display IP route summary, use the following command:

```
awplus# show ipv6 route summary
```

**Output** Figure 21-5: Example output from the **show ipv6 route summary** command

```
IPv6 routing table name is Default-IPv6-Routing-Table(0)
IPv6 routing table maximum-paths is 4
RouteSource      Networks
connected        4
rip              5
Total            9
FIB              5
```

**Related commands** [show ip route database](#)

# traceroute ipv6

**Overview** Use this command to trace the route to the specified IPv6 host.

**Syntax** `traceroute ipv6 {<ipv6-addr>|<hostname>}`

Parameter	Description
<code>&lt;ipv6-addr&gt;</code>	The destination IPv6 address. The IPv6 address uses the format X:X::X:X.
<code>&lt;hostname&gt;</code>	The destination hostname.

**Mode** User Exec and Privileged Exec

**Example** To run a traceroute for the IPv6 address 2001:0db8::a2, use the following command:

```
awplus# traceroute ipv6 2001:0db8::a2
```

**Related commands** [ping ipv6](#)



# 22

# Routing Commands

## Introduction

**Overview** This chapter provides an alphabetical reference of routing commands that are common across the routing IP protocols. For more information, see the [Route Selection Feature Overview and Configuration Guide](#).

- Command List**
- [“ip route”](#) on page 738
  - [“ipv6 route”](#) on page 740
  - [“max-fib-routes”](#) on page 741
  - [“max-static-routes”](#) on page 742
  - [“show ip route”](#) on page 743
  - [“show ip route database”](#) on page 745
  - [“show ip route summary”](#) on page 746
  - [“show ipv6 route”](#) on page 747
  - [“show ipv6 route summary”](#) on page 749

# ip route

**Overview** This command adds a static route to the Routing Information Base (RIB). If this route is the best route for the destination, then your device adds it to the Forwarding Information Base (FIB). Your device uses the FIB to advertise routes to neighbors and forward packets.

The **no** variant of this command removes the static route from the RIB and FIB.

**Syntax** `ip route <subnet&mask> {<gateway-ip>|<interface>} [<distance>]`  
`no ip route <subnet&mask> {<gateway-ip>|<interface>} [<distance>]`

Parameter	Description
<code>&lt;subnet&amp;mask&gt;</code>	The IPv4 address of the destination subnet defined using either a prefix length or a separate mask specified in one of the following formats: <ul style="list-style-type: none"><li>The IPv4 subnet address in dotted decimal notation followed by the subnet mask, also in dotted decimal notation.</li><li>The IPv4 subnet address in dotted decimal notation, followed by a forward slash, then the prefix length</li></ul>
<code>&lt;gateway-ip&gt;</code>	The IPv4 address of the gateway device.
<code>&lt;interface&gt;</code>	The interface that connects your device to the network. Enter the name of the VLAN or its VID. The gateway IP address or the interface is required.
<code>&lt;distance&gt;</code>	The administrative distance for the static route in the range <1-255>. Static routes by default have an administrative distance of 1, which gives them the highest priority possible.

**Mode** Global Configuration

**Default** The default administrative distance for a static route is 1.

**Usage notes** You can use administrative distance to determine which routes take priority over other routes.

**Examples** To add the destination 192.168.3.0 with the mask 255.255.255.0 as a static route available through the device at "10.10.0.2" with the default administrative distance, use the commands:

```
awplus# configure terminal
awplus(config)# ip route 192.168.3.0 255.255.255.0 10.10.0.2
```

To remove the destination 192.168.3.0 with the mask 255.255.255.0 as a static route available through the device at "10.10.0.2" with the default administrative distance, use the commands:

```
awplus# configure terminal
awplus(config)# no ip route 192.168.3.0 255.255.255.0 10.10.0.2
```

To add the destination 192.168.3.0 with the mask 255.255.255.0 as a static route available through the device at "10.10.0.2" with an administrative distance of 128, use the commands:

```
awplus# configure terminal
awplus(config)# ip route 192.168.3.0 255.255.255.0 10.10.0.2
128
```

**Related commands** [show ip route](#)  
[show ip route database](#)

# ipv6 route

**Overview** This command adds a static IPv6 route to the Routing Information Base (RIB). If this route is the best route for the destination, then your device adds it to the Forwarding Information Base (FIB). Your device uses the FIB to advertise routes to neighbors and forward packets.

The **no** variant of this command removes the static route.

**Syntax** `ipv6 route <dest-prefix> <dest-prefix/length> {<gateway-ip>|<gateway-name>} [<distvalue>]`  
`no ipv6 route <dest-prefix> <dest-prefix/length> {<gateway-ip>|<gateway-name>} [<distvalue>]`

Parameter	Description
<code>&lt;dest-prefix/length&gt;</code>	Specifies the IP destination prefix. The IPv6 address prefix uses the format X:X::/prefix-length. The prefix-length is usually set between 0 and 64.
<code>&lt;gateway-ip&gt;</code>	Specifies the IP gateway (or next hop) address. The IPv6 address uses the format X:X::X/X/Prefix-Length. The prefix-length is usually set between 0 and 64.
<code>&lt;gateway-name&gt;</code>	Specifies the name of the gateway (or next hop) interface.
<code>&lt;distvalue&gt;</code>	Specifies the administrative distance for the route. Valid values are from 1 to 255.

**Mode** Global Configuration

**Usage notes** You can use administrative distance to determine which routes take priority over other routes.

**Example** `awplus# configure terminal`  
`awplus(config)# ipv6 route 2001:0db8::1/128 vlan2 32`

**Validation Commands** `show running-config`  
`show ipv6 route`

# max-fib-routes

**Overview** This command enables you to control the maximum number of FIB routes configured. It operates by providing parameters that enable you to configure preset maximums and warning message thresholds.

**NOTE:** For static routes use the *max-static-routes* command.

Use the **no** variant of this command to set the maximum number of FIB routes to the default of 4294967294 FIB routes.

**Syntax** `max-fib-routes <1-4294967294> [<1-100>|warning-only]`  
`no max-fib-routes`

Parameter	Description
<code>max-fib-routes</code>	This is the maximum number of routes that can be stored in the device's Forwarding Information dataBase. In practice, other practical system limits would prevent this maximum being reached.
<code>&lt;1-4294967294&gt;</code>	The allowable configurable range for setting the maximum number of FIB-routes.
<code>&lt;1-100&gt;</code>	This parameter enables you to optionally apply a percentage value. This percentage will be based on the maximum number of FIB routes you have specified. This will cause a warning message to appear when your routes reach your specified percentage value. Routes can continue to be added until your configured maximum value is reached.
<code>warning-only</code>	This parameter enables you to optionally apply a warning message. If you set this option a warning message will appear if your maximum configured value is reached. Routes can continue to be added until your device reaches either the maximum capacity value of 4294967294, or a practical system limit.

**Default** The default number of FIB routes is the maximum number of FIB routes (4294967294).

**Mode** Global Configuration

**Examples** To set the maximum number of dynamic routes to 2000 and warning threshold of 75%, use the following commands:

```
awplus# config terminal
awplus(config)# max-fib-routes 2000 75
```

# max-static-routes

**Overview** Use this command to set the maximum number of static routes, excluding FIB (Forwarding Information Base) routes.

**NOTE:** For FIB routes use the [max-fib-routes](#) command.

Use the **no** variant of this command to set the maximum number of static routes to the default of 1000 static routes.

**Syntax** `max-static-routes <1-1000>`  
`no max-static-routes`

**Default** The default number of static routes is the maximum number of static routes (1000).

**Mode** Global Configuration

**Example** To reset the maximum number of static routes to the default maximum, use the command:

```
awplus# configure terminal
awplus(config)# no max-static-routes
```

**NOTE:** Static routes are applied before adding routes to the RIB (Routing Information Base). Therefore, rejected static routes will not appear in the running config.

**Related commands** [max-fib-routes](#)

# show ip route

**Overview** Use this command to display routing entries in the FIB (Forwarding Information Base). The FIB contains the best routes to a destination, and your device uses these routes when forwarding traffic. You can display a subset of the entries in the FIB based on protocol.

To modify the lines displayed, use the | (output modifier token); to save the output to a file, use the > output redirection token.

**Syntax** `show ip route [connected|rip|static|<ip-addr>|<ip-addr/prefix-length>]`

Parameter	Description
<code>connected</code>	Displays only the routes learned from connected interfaces.
<code>rip</code>	Displays only the routes learned from RIP.
<code>static</code>	Displays only the static routes you have configured.
<code>&lt;ip-addr&gt;</code>	Displays the routes for the specified address. Enter an IPv4 address.
<code>&lt;ip-addr/prefix-length&gt;</code>	Displays the routes for the specified network. Enter an IPv4 address and prefix length.

**Mode** User Exec and Privileged Exec

**Example** To display the static routes in the FIB, use the command:

```
awplus# show ip route static
```

**Output** Each entry in the output from this command has a code preceding it, indicating the source of the routing entry. The first few lines of the output list the possible codes that may be seen with the route entries.

Typically, route entries are composed of the following elements:

- code
- a second label indicating the sub-type of the route
- network or host IP address
- administrative distance and metric
- next hop IP address
- outgoing interface name
- time since route entry was added

Figure 22-1: Example output from the **show ip route** command

```
Codes: C - connected, S - static, R - RIP, B - BGP
       O - OSPF, IA - OSPF inter area
       N1 - OSPF NSSA external type 1, N2 - OSPF NSSA external type 2
       E1 - OSPF external type 1, E2 - OSPF external type 2
       * - candidate default

C      3.3.3.0/24 is directly connected, vlan1
C      10.10.31.0/24 is directly connected, vlan2
C      10.70.0.0/24 is directly connected, vlan4
C      33.33.33.33/32 is directly connected, lo
```

**Connected Route** The connected route entry consists of:

```
C      10.10.31.0/24 is directly connected, vlan2
```

This route entry denotes:

- Route entries for network 10.10.31.0/24 are derived from the IP address of local interface vlan2.
- These routes are marked as Connected routes (C) and always preferred over routes for the same network learned from other routing protocols.

**Related commands** [ip route](#)  
[show ip route database](#)



# show ip route database

**Overview** This command displays the routing entries in the RIB (Routing Information Base).

When multiple entries are available for the same prefix, RIB uses the routes' administrative distances to choose the best route. All best routes are entered into the FIB (Forwarding Information Base). To view the routes in the FIB, use the [show ip route](#) command.

To modify the lines displayed, use the | (output modifier token); to save the output to a file, use the > output redirection token.

**Syntax** `show ip route database [connected|rip|static]`

Parameter	Description
connected	Displays only the routes learned from connected interfaces.
rip	Displays only the routes learned from RIP.
static	Displays only the static routes you have configured.

**Mode** User Exec and Privileged Exec

**Example** To display the static routes in the RIB, use the command:

```
awplus# show ip route database static
```

**Output** Figure 22-2: Example output from the **show ip route database** command

```
Codes: C - connected, S - static, R - RIP, B - BGP
       O - OSPF, IA - OSPF inter area
       N1 - OSPF NSSA external type 1, N2 - OSPF NSSA external type 2
       E1 - OSPF external type 1, E2 - OSPF external type 2
> - selected route, * - FIB route, p - stale info

C    *> 10.10.31.0/24 is directly connected, vlan2
S    *> 10.10.34.0/24 [1/0] via 10.10.31.16, vlan2
C    *> 10.30.0.0/24 is directly connected, vlan6
S    *> 11.22.11.0/24 [1/0] via 10.10.31.16, vlan2
S    *> 16.16.16.16/32 [1/0] via 10.10.31.16, vlan2
C    *> 45.45.45.45/32 is directly connected, lo
C    *> 127.0.0.0/8 is directly connected, lo
```

**Related commands** [show ip route](#)

# show ip route summary

**Overview** This command displays a summary of the current RIB (Routing Information Base) entries.

To modify the lines displayed, use the | (output modifier token); to save the output to a file, use the > output redirection token.

**Syntax** `show ip route summary`

**Mode** User Exec and Privileged Exec

**Example** To display a summary of the current RIB entries, use the command:

```
awplus# show ip route summary
```

**Output** Figure 22-3: Example output from the **show ip route summary** command

```
IP routing table name is Default-IP-Routing-Table(0)
IP routing table maximum-paths is 4
Route Source      Networks
connected         5
Total             8
```

**Related commands** [show ip route](#)  
[show ip route database](#)

# show ipv6 route

**Overview** Use this command to display the IPv6 routing table for a protocol or from a particular table.

For information on filtering and saving command output, see the [“Getting Started with AlliedWare Plus” Feature Overview and Configuration Guide](#).

**Syntax** `show ipv6 route`  
[ `connected` | `database` | `static` | `summary` | `<ipv6-address>` | `<ipv6-addr/prefix-length>` ]

Parameter	Description
<code>connected</code>	Displays only the routes learned from connected interfaces.
<code>database</code>	Displays only the IPv6 routing information extracted from the database.
<code>static</code>	Displays only the IPv6 static routes you have configured.
<code>summary</code>	Displays summary information from the IPv6 routing table.
<code>&lt;ipv6-address&gt;</code>	Displays the routes for the specified address in the IP routing table. The IPv6 address uses the format X:X::X/X/Prefix-Length. The prefix-length is usually set between 0 and 64.
<code>&lt;ipv6-prefix/length&gt;</code>	Displays only the routes for the specified IP prefix.

**Mode** User Exec and Privileged Exec

**Example** To display an IP route with all parameters turned on, use the following command:

```
awplus# show ipv6 route
```

To display all database entries for an IP route, use the following command:

```
awplus# show ipv6 route database
```

**Output** Figure 22-4: Example output of the **show ipv6 route** command

```
IPv6 Routing Table
Codes: C - connected, S - static, R - RIP, O - OSPF, B - BGP
S   ::/0 [1/0] via 2001::a:0:0:c0a8:a6, vlan10
C   2001:db8::a:0:0:0/64 via ::, vlan10
C   2001:db8::14:0:0:0/64 via ::, vlan20
C   2001:db8::0:0:0:0/64 via ::, vlan30
C   2001:db8::28:0:0:0/64 via ::, vlan40
C   2001:db8::fa:0:0:0/64 via ::, vlan250
C   2001:db8::/64 via ::, vlan250
C   2001:db8::/64 via ::, vlan40
C   2001:db8::/64 via ::, vlan20
C   2001:db8::/64 via ::, vlan10
```

**Output** Figure 22-5: Example output of the **show ipv6 route database** command

```
IPv6 Routing Table
Codes: C - connected, S - static, R - RIP, O - OSPF, B - BGP
> - selected route, * - FIB route, p - stale info
Timers: Uptime
S   ::/0 [1/0] via 2001::a:0:0:c0a8:a01 inactive, 6d22h12m
      [1/0] via 2001::fa:0:0:c0a8:fa01 inactive, 6d22h12m
```

# show ipv6 route summary

**Overview** Use this command to display the summary of the current NSM RIB entries.  
For information on filtering and saving command output, see the [“Getting Started with AlliedWare Plus” Feature Overview and Configuration Guide](#).

**Syntax** `show ipv6 route summary`

**Mode** User Exec and Privileged Exec

**Example** To display IP route summary, use the following command:

```
awplus# show ipv6 route summary
```

**Output** Figure 22-6: Example output from the **show ipv6 route summary** command

```
IPv6 routing table name is Default-IPv6-Routing-Table(0)
IPv6 routing table maximum-paths is 4
RouteSource      Networks
connected        4
rip               5
Total            9
FIB              5
```

**Related commands** [show ip route database](#)

# 23

# RIP Commands

## Introduction

**Overview** This chapter provides an alphabetical reference of commands used to configure RIP.

For information about configuring RIP, see the [RIP Feature Overview and Configuration Guide](#).

- Command List**
- ["accept-lifetime"](#) on page 752
  - ["alliedware-behavior"](#) on page 754
  - ["cisco-metric-behavior \(RIP\)"](#) on page 756
  - ["clear ip rip route"](#) on page 757
  - ["debug rip"](#) on page 758
  - ["default-information originate \(RIP\)"](#) on page 759
  - ["default-metric \(RIP\)"](#) on page 760
  - ["distance \(RIP\)"](#) on page 761
  - ["distribute-list \(RIP\)"](#) on page 762
  - ["fullupdate \(RIP\)"](#) on page 763
  - ["ip summary-address rip"](#) on page 764
  - ["ip rip authentication key-chain"](#) on page 765
  - ["ip rip authentication mode"](#) on page 767
  - ["ip rip authentication string"](#) on page 770
  - ["ip rip receive-packet"](#) on page 772
  - ["ip rip receive version"](#) on page 773
  - ["ip rip send-packet"](#) on page 774
  - ["ip rip send version"](#) on page 775

- ["ip rip send version 1-compatible"](#) on page 777
- ["ip rip split-horizon"](#) on page 779
- ["key"](#) on page 780
- ["key chain"](#) on page 781
- ["key-string"](#) on page 782
- ["maximum-prefix"](#) on page 783
- ["neighbor \(RIP\)"](#) on page 784
- ["network \(RIP\)"](#) on page 785
- ["offset-list \(RIP\)"](#) on page 786
- ["passive-interface \(RIP\)"](#) on page 787
- ["recv-buffer-size \(RIP\)"](#) on page 788
- ["redistribute \(RIP\)"](#) on page 789
- ["restart rip graceful"](#) on page 790
- ["rip restart grace-period"](#) on page 791
- ["route \(RIP\)"](#) on page 792
- ["router rip"](#) on page 793
- ["send-lifetime"](#) on page 794
- ["show debugging rip"](#) on page 796
- ["show ip protocols rip"](#) on page 797
- ["show ip rip"](#) on page 798
- ["show ip rip database"](#) on page 799
- ["show ip rip interface"](#) on page 800
- ["timers \(RIP\)"](#) on page 801
- ["undebg rip"](#) on page 802
- ["version \(RIP\)"](#) on page 803

# accept-lifetime

**Overview** Use this command to specify the time period during which the authentication key on a key chain is received as valid.

Use the **no** variant of this command to remove a specified time period for an authentication key on a key chain as set previously with the **accept-lifetime** command.

**Syntax** `accept-lifetime <start-date> {<end-date>|  
duration <seconds>|infinite}`  
`no accept-lifetime`

Parameter	Description
<code>&lt;start-date&gt;</code>	Specifies the start time and date in the format: <code>&lt;hh:mm:ss&gt; &lt;day&gt; &lt;month&gt; &lt;year&gt;</code> or <code>&lt;hh:mm:ss&gt; &lt;month&gt; &lt;day&gt; &lt;year&gt;</code> , where:
<code>&lt;hh:mm:ss&gt;</code>	The time of the day, in hours, minutes and seconds
<code>&lt;day&gt;</code>	<code>&lt;1-31&gt;</code> The day of the month
<code>&lt;month&gt;</code>	The month of the year (the first three letters of the month, for example, Jan)
<code>&lt;year&gt;</code>	<code>&lt;1993-2035&gt;</code> The year
<code>&lt;end-date&gt;</code>	Specifies the end time and date in the format: <code>&lt;hh:mm:ss&gt; &lt;day&gt; &lt;month&gt; &lt;year&gt;</code> or <code>&lt;hh:mm:ss&gt; &lt;month&gt; &lt;day&gt; &lt;year&gt;</code> , where:
<code>&lt;hh:mm:ss&gt;</code>	The time of the day, in hours, minutes and seconds
<code>&lt;day&gt;</code>	<code>&lt;1-31&gt;</code> The day of the month
<code>&lt;month&gt;</code>	The month of the year (the first three letters of the month, for example, Jan)
<code>&lt;year&gt;</code>	<code>&lt;1993-2035&gt;</code> The year
<code>&lt;seconds&gt;</code>	<code>&lt;1-2147483646&gt;</code> Duration of the key in seconds.
<code>infinite</code>	Never expires.

**Mode** Keychain-key Configuration

**Examples** The following examples show the setting of accept-lifetime for key 1 on the key chain named "mychain".

```
awplus# configure terminal
awplus(config)# key chain mychain
awplus(config-keychain)# key 1
awplus(config-keychain-key)# accept-lifetime 03:03:01 Sep 3
2016 04:04:02 Oct 6 2016
```



or:

```
awplus# configure terminal
awplus(config)# key chain mychain
awplus(config-keychain)# key 1
awplus(config-keychain-key)# accept-lifetime 03:03:01 3 Sep
2016 04:04:02 6 Oct 2016
```

**Related  
commands**

[key](#)  
[key-string](#)  
[key chain](#)  
[send-lifetime](#)

# alliedware-behavior

**Overview** This command configures your device to exhibit AlliedWare behavior when sending RIPv1 response/update messages. Configuring for this behavior may be necessary if you are replacing an AlliedWare device with an AlliedWare Plus device and wish to ensure consistent RIPv1 behavior.

Use the no variant of this command to implement AlliedWare Plus behavior.

This command has no impact on devices running RIPv2. Reception and transmission can be independently altered to conform to AlliedWare standard.

**Syntax** alliedware-behavior {ripl-send|ripl-recv}  
no alliedware-behavior {ripl-send|ripl-recv}

Parameter	Description
ripl-send	Configures the router to behave in AlliedWare mode when <b>sending</b> update messages.
ripl-recv	Configures the router to behave in AlliedWare mode when <b>receiving</b> update messages.

**Default** By default when sending out RIPv1 updates on an interface, if the prefix (learned through RIPv2 or otherwise redistributed into RIP) being advertised does not match the subnetting used on the outgoing RIPv1 interface it will be filtered. The **alliedware-behavior** command returns your router's RIPv1 behavior to the AlliedWare format, where the prefix will be advertised as-is.

For example, if a RIPv1 update is being sent over interface 192.168.1.4/26, by default the prefix 192.168.1.64/26 will be advertised, but the prefix 192.168.1.144/28 will be filtered because the mask /28 does not match the interface's mask of /26. If **alliedware-behavior ripl-send** is configured, the prefix 192.168.1.144 would be sent as-is.

**Mode** Router Configuration

**Examples** To configure your device for **alliedware-behavior** when sending and receiving RIPv1 update messages, enter the commands:

```
awplus# configure terminal
awplus(config)# router rip
awplus(config-router)# alliedware-behavior ripl-send
awplus(config-router)# alliedware-behavior ripl-recv
```

To return your device to **AlliedWare Plus**-like behavior when sending and receiving RIPv1 update messages, enter the commands:

```
awplus# configure terminal
awplus(config)# router rip
awplus(config-router)# no alliedware-behavior rip1-send
awplus(config-router)# no alliedware-behavior rip1-recv
```

**Validation  
Commands**    [show ip protocols rip](#)  
                  [show running-config](#)

**Related  
commands**    [fullupdate \(RIP\)](#)

# cisco-metric-behavior (RIP)

**Overview** Use this command to enable or disable the RIP routing metric update to conform to Cisco's implementation. This command is provided to allow inter-operation with older Cisco devices that do not conform to the RFC standard for RIP route metrics.

Use the **no** variant of this command to disable this feature.

**Syntax** `cisco-metric-behavior {enable|disable}`  
`no cisco-metric-behavior`

Parameter	Description
enable	Enables updating the metric consistent with Cisco.
disable	Disables updating the metric consistent with Cisco.

**Default** By default, the Cisco metric-behavior is disabled.

**Mode** Router Configuration

**Examples** To enable the routing metric update to behave as per the Cisco implementation, enter the commands:

```
awplus# configure terminal
awplus(config)# router rip
awplus(config-router)# cisco-metric-behavior enable
```

To disable the routing metric update to behave as per the default setting, enter the commands:

```
awplus# configure terminal
awplus(config)# router rip
awplus(config-router)# no cisco-metric-behavior
```

**Validation Commands** `show running-config`

# clear ip rip route

**Overview** Use this command to clear specific data from the RIP routing table.

**Syntax** `clear ip rip route <ip-dest-network/prefix-length>`  
`clear ip rip route`  
{static|connected|rip|ospf|invalid-routes|all}

Parameter	Description
<code>&lt;ip-dest-network/prefix-length&gt;</code>	Removes entries which exactly match this destination address from RIP routing table. Enter the IP address and prefix length of the destination network.
<code>static</code>	Removes static entries from the RIP routing table.
<code>connected</code>	Removes entries for connected routes from the RIP routing table.
<code>rip</code>	Removes only RIP routes from the RIP routing table.
<code>ospf</code>	Removes only OSPF routes from the RIP routing table.
<code>invalid-routes</code>	Removes routes with metric 16 immediately. Otherwise, these routes are not removed until RIP times out the route after 2 minutes.
<code>all</code>	Clears the entire RIP routing table.

**Mode** Privileged Exec

**Usage notes** Using this command with the **all** parameter clears the RIP table of all the routes.

**Examples** To clear the route 10.0.0.0/8 from the RIP routing table, use the following command:

```
awplus# clear ip rip route 10.0.0.0/8
```

# debug rip

**Overview** Use this command to specify the options for the displayed debugging information for RIP events and RIP packets.

Use the **no** variant of this command to disable the specified debug option.

**Syntax** `debug rip {events|nsm|<packet>|all}`  
`no debug rip {events|nsm|<packet>|all}`

Parameter	Description
events	RIP events debug information is displayed.
nsm	RIP and NSM communication is displayed.
<packet>	packet [recv send] [detail] Specifies RIP packets only.
recv	Specifies that information for received packets be displayed.
send	Specifies that information for sent packets be displayed.
detail	Displays detailed information for the sent or received packet.
all	Displays all RIP debug information.

**Default** Disabled

**Mode** Privileged Exec and Global Configuration

**Example** The following example displays information about the RIP packets that are received and sent out from the device.

```
awplus# debug rip packet
```

**Related commands** [undebug rip](#)

# default-information originate (RIP)

**Overview** Use this command to generate a default route into the Routing Information Protocol (RIP).

Use the **no** variant of this command to disable this feature.

**Syntax** `default-information originate`  
`no default-information originate`

**Default** Disabled

**Mode** Router Configuration

**Usage** If routes are being redistributed into RIP and the router's route table contains a default route, within one of the route categories that are being redistributed, the RIP protocol will advertise this default route, irrespective of whether the **default-information originate** command has been configured or not. However, if the router has not redistributed any default route into RIP, but you want RIP to advertise a default route anyway, then use this command.

This will cause RIP to create a default route entry in the RIP database. The entry will be of type RS (Rip Static). Unless actively filtered out, this default route will be advertised out every interface that is sending RIP. Split horizon does not apply to this route, as it is internally generated. This operates quite similarly to the OSPF **default-information originate always** command.

**Example** `awplus# configure terminal`  
`awplus(config)# router rip`  
`awplus(config-router)# default-information originate`

# default-metric (RIP)

**Overview** Use this command to specify the metrics to be assigned to redistributed RIP routes. Use the **no** variant of this command to reset the RIP metric back to its default (1).

**Syntax** `default-metric <metric>`  
`no default-metric [<metric>]`

Parameter	Description
<metric>	<1-16> Specifies the value of the default metric.

**Default** By default, the RIP metric value is set to 1.

**Mode** RIP Router Configuration

**Usage notes** This command is used with the [redistribute \(RIP\)](#) command to make the routing protocol use the specified metric value for all redistributed routes, regardless of the original protocol that the route has been redistributed from.

**Examples** This example assigns the cost of 10 to the routes that are redistributed into RIP.

```
awplus# configure terminal
awplus(config)# router rip
awplus(config-router)# default-metric 10
awplus(config-router)# redistribute ospf
awplus(config-router)# redistribute connected
```

**Related commands** [redistribute \(RIP\)](#)



# distance (RIP)

**Overview** This command sets the administrative distance for RIP routes. Your device uses this value to select between two or more routes to the same destination obtained from two different routing protocols. The route with the smallest administrative distance value is added to the Forwarding Information Base (FIB). For more information, see the [Route Selection Feature Overview and Configuration Guide](#).

The **no** variant of this command sets the administrative distance for the RIP route to the default of 120.

**Syntax** `distance <1-255> [<ip-addr/prefix-length> [<access-list>]]`  
`no distance [<1-255>] [<ip-addr/prefix-length> [<access-list>]]`

Parameter	Description
<code>&lt;1-255&gt;</code>	The administrative distance value you are setting for this RIP route.
<code>&lt;ip-addr/prefix-length&gt;</code>	The network IP address and prefix-length that you are changing the administrative distance for.
<code>&lt;access-list&gt;</code>	Specifies the access-list name. This access list specifies which routes within the specified network this command applies to.

**Mode** RIP Router Configuration

**Examples** To set the administrative distance to 8 for the RIP routes within the 10.0.0.0/8 network that match the access-list "mylist", use the commands:

```
awplus# configure terminal
awplus(config)# router rip
awplus(config-router)# distance 8 10.0.0.0/8 mylist
```

To set the administrative distance to the default of 120 for the RIP routes within the 10.0.0.0/8 network that match the access-list "mylist", use the commands:

```
awplus# configure terminal
awplus(config)# router rip
awplus(config-router)# no distance 8 10.0.0.0/8 mylist
```

# distribute-list (RIP)

**Overview** Use this command to filter incoming or outgoing route updates using the access-list or the prefix-list.

Use the **no** variant of this command to disable this feature.

**Syntax** `distribute-list {<access-list> | prefix <prefix-list>} {in|out} [<interface>]`  
`no distribute-list {<access-list> | prefix <prefix-list>} {in|out} [<interface>]`

Parameter	Description
<code>prefix</code>	Filter prefixes in routing updates.
<code>&lt;access-list&gt;</code>	Specifies the IPv4 access-list number or name to use.
<code>&lt;prefix-list&gt;</code>	Specifies the name of the IPv4 prefix-list to use.
<code>in</code>	Filter incoming routing updates.
<code>out</code>	Filter outgoing routing updates.
<code>&lt;interface&gt;</code>	The interface on which distribute-list applies. For instance: <code>vlan2</code>

**Default** Disabled

**Mode** RIP Router Configuration

**Usage notes** Filter out incoming or outgoing route updates using access-list or prefix-list. If you do not specify the name of the interface, the filter will be applied to all interfaces.

**Examples** In this example the following commands are used to apply an access list called `myfilter` to filter incoming routing updates in `vlan2`

```
awplus# configure terminal
awplus(config)# router rip
awplus(config-router)# distribute-list prefix myfilter in vlan2
```

**Related commands** [access-list extended \(named\)](#)

## fullupdate (RIP)

**Overview** Use this command to specify which routes RIP should advertise when performing a triggered update. By default, when a triggered update is sent, RIP will only advertise those routes that have changed since the last update. When **fullupdate** is configured, the device advertises the full RIP route table in outgoing triggered updates, including routes that have not changed. This enables faster convergence times, or allows inter-operation with legacy network equipment, but at the expense of larger update messages.

Use the **no** variant of this command to disable this feature.

**Syntax** fullupdate  
no fullupdate

**Default** By default this feature is disabled.

**Mode** RIP Router Configuration

**Example** To enable the fullupdate (RIP) function, use the commands:

```
awplus# configure terminal
awplus(config)# router rip
awplus(config-router)# fullupdate
```

# ip summary-address rip

**Overview** Use this command to configure a summary IP address on a RIPv2 interface. Use the **no** variant of this command to remove a summary IP address from a selected RIPv2 interface.

**Syntax** `ip summary-address rip {<ip-address/prefix-length>}`  
`no ip summary-address rip {<ip-address/prefix-length>}`

Parameter	Description
<code>&lt;ip-address/prefix-length&gt;</code>	The summary IPv4 address to be advertised

**Usage notes** Route summarization is a technique that helps network administrators in reducing the size of the routing tables by advertising a single super-network that covers a range of subnets.

You statically configure an IP summary address on a router interface. The router then advertises the summary address downstream through this interface. This means that:

- all the routers that are downstream from the configured interface will receive only the summary route, and none of the child routes via the RIP advertisement.
- As long as any of the child routes is valid, the router will propagate the summary route. But when the last child that is part of the summarized range disappears, then the router will stop advertising the summary route through the interface.

This command will be rejected if there is no IP address configured on the interface.

**NOTE:** *Manual route summarization is not supported when the interface/router is running in RIPv1.*

**Example** The subnets: 10.4.1.0/24, 10.4.2.128/25, 10.4.3.0/24 can be summarized and advertised as 10.4.0.0/16 on vlan1 using the following commands:

```
awplus# configure terminal
awplus(config)# interface vlan1
awplus(config-if)# ip summary-address rip 10.4.0.0/16
```

**Related commands** [show ip rip database](#)  
[show ip protocols rip](#)

**Command changes** Version 5.4.8-0.2 command added

# ip rip authentication key-chain

**Overview** Use this command to enable RIPv2 authentication on an interface and specify the name of the key chain to be used.

Use the **no** variant of this command to disable this function.

**Syntax** `ip rip authentication key-chain <key-chain-name>`  
`no ip rip authentication key-chain`

Parameter	Description
<code>&lt;key-chain-name&gt;</code>	Specify the name of the key chain. This is an alpha-numeric string, but it cannot include spaces.

**Mode** Interface Configuration for a VLAN interface.

**Usage notes** Use this command to perform authentication on the interface. Not configuring the key chain results in no authentication at all.

The AlliedWare Plus™ implementation provides the choice of configuring authentication for single key or multiple keys at different times. Use the [ip rip authentication string](#) command for single key authentication. Use the [ip rip authentication key-chain](#) command for multiple keys authentication. See the [RIP Feature Overview and Configuration Guide](#) for illustrated RIP configuration examples.

For multiple key authentication, use the following steps to configure a route to enable RIPv2 authentication using multiple keys at different times:

1) Define a key chain with a key chain name, using the following commands:

```
awplus# configure terminal
awplus(config)# key chain <key-chain-name>
```

2) Define a key on this key chain, using the following command:

```
awplus(config-keychain)# key <keyid>
```

3) Define the password used by the key, using the following command:

```
awplus(config-keychain-key)# key-string <key-password>
```

4) Enable authentication on the desired interface and specify the key chain to be used, using the following commands:

```
awplus# configure terminal
awplus(config)# interface <id>
awplus(config-if)# ip rip authentication key-chain
<key-chain-name>
```

- 5) Specify the mode of authentication for the given interface (text or MD5), using the following command:

```
awplus(config-if)# ip rip authentication mode {md5|text}
```

**Example** In the following example of a configuration for multiple keys authentication, a password “toyota” is set for key 1 in key chain “cars”. Authentication is enabled on vlan2 and the authentication mode is set to MD5:

```
awplus# configure terminal
awplus(config)# key chain cars
awplus(config-keychain)# key 1
awplus(config-keychain-key)# key-string toyota
awplus(config-keychain-key)# accept-lifetime 10:00:00 Oct 08
2016 duration 43200
awplus(config-keychain-key)# send-lifetime 10:00:00 Oct 08 2016
duration 43200
awplus(config-keychain-key)# exit
awplus(config-keychain)# exit
awplus(config)# interface vlan2
awplus(config-if)# ip rip authentication key-chain cars
awplus(config-if)# ip rip authentication mode md5
```

**Example** In the following example, the VLAN interface vlan23 is configured to use key-chain authentication with the keychain “mykey”. See the [key](#) command for a description of how a key chain is created.

```
awplus# configure terminal
awplus(config)# interface vlan23
awplus(config-if)# ip rip authentication key-chain mykey
```

**Related  
commands**

[accept-lifetime](#)  
[send-lifetime](#)  
[ip rip authentication mode](#)  
[ip rip authentication string](#)  
[key](#)  
[key chain](#)

# ip rip authentication mode

**Overview** Use this command to specify the type of authentication mode used for RIP v2 packets.

Use the **no** variant of this command to restore clear text authentication.

**Syntax** `ip rip authentication mode {md5|text}`  
`no ip rip authentication mode`

Parameter	Description
md5	Uses the keyed MD5 authentication algorithm.
text	Specifies clear text or simple password authentication.

**Default** Text authentication is enabled

**Mode** Interface Configuration for a VLAN interface.

**Usage notes** The AlliedWare Plus™ implementation provides the choice of configuring authentication for single key or multiple keys at different times. Use the [ip rip authentication string](#) command for single key authentication. Use the [ip rip authentication key-chain](#) command for multiple keys authentication. See the [RIP Feature Overview and Configuration Guide](#) for illustrated RIP configuration examples.

**Usage: single key** Use the following steps to configure a route to enable RIPv2 authentication using a single key or password:

- 1) Define the authentication string or password used by the key for the desired interface, using the following commands:

```
awplus# configure terminal
awplus(config)# interface <id>
awplus(config-if)# ip rip authentication string <auth-string>
```

- 2) Specify the mode of authentication for the given interface (text or MD5), using the following commands:

```
awplus# configure terminal
awplus(config)# interface <id>
awplus(config-if)# ip rip authentication mode {md5|text}
```

**Usage: multiple key** For multiple keys authentication, use the following steps to configure a route to enable RIPv2 authentication using multiple keys at different times:

- 1) Define a key chain with a key chain name, using the following commands:

```
awplus# configure terminal
awplus(config)# key chain <key-chain-name>
```

- 2) Define a key on this key chain using the following command:

```
awplus(config-keychain)# key <keyid>
```

- 3) Define the password used by the key, using the following command:

```
awplus(config-keychain-key)# key-string <key-password>
```

- 4) Enable authentication on the desired interface and specify the key chain to be used, using the following commands:

```
awplus(config-if)# ip rip authentication key-chain  
<key-chain-name>
```

- 5) Specify the mode of authentication for the given interface (text or MD5), using the following commands:

```
awplus(config-if)# ip rip authentication mode {md5|text}
```

**Example 1** In the following example of a configuration for multiple keys authentication, a password of "toyota" is set for key 1 in key chain "cars". Authentication is enabled on vlan2 and the authentication mode is set to MD5:

```
awplus# configure terminal  
awplus(config)# key chain cars  
awplus(config-keychain)# key 1  
awplus(config-keychain-key)# key-string toyota  
awplus(config-keychain-key)# accept-lifetime 10:00:00 Oct 08  
2016 duration 43200  
awplus(config-keychain-key)# send-lifetime 10:00:00 Oct 08 2016  
duration 43200  
awplus(config-keychain-key)# exit  
awplus(config-keychain)# exit  
awplus(config)# interface vlan2  
awplus(config-if)# ip rip authentication key-chain cars  
awplus(config-if)# ip rip authentication mode md5
```

**Example 2** The following example shows MD5 authentication configured on VLAN interface vlan2, ensuring authentication of RIP packets received on this interface.

```
awplus# configure terminal  
awplus(config)# interface vlan2  
awplus(config-if)# ip rip authentication mode md5
```

**Example 3** The following example specifies "mykey" as the authentication string with MD5 authentication, for the VLAN interface vlan2:

```
awplus# configure terminal  
awplus(config)# interface vlan2  
awplus(config-if)# ip rip authentication string mykey  
awplus(config-if)# ip rip authentication mode md5
```



**Related  
commands** [ip rip authentication string](#)  
[ip rip authentication key-chain](#)

# ip rip authentication string

**Overview** Use this command to specify the authentication string or password used by a key. Use the **no** variant of this command to remove the authentication string.

**Syntax** `ip rip authentication string <auth-string>`  
`no ip rip authentication string`

Parameter	Description
<code>&lt;auth-string&gt;</code>	The authentication string or password used by a key. It is an alphanumeric string and can include spaces.

**Mode** Interface Configuration for a VLAN interface.

**Usage notes** The AlliedWare Plus™ implementation provides the choice of configuring authentication for single key or multiple keys at different times. Use this command to specify the password for a single key on an interface. Use the [ip rip authentication key-chain](#) command for multiple keys authentication. For information about configuring RIP, see the [RIP Feature Overview and Configuration Guide](#).

Use the following steps to configure a route to enable RIPv2 authentication using a single key or password:

- 1) Define the authentication string or password used by the key for the desired interface, using the following commands:

```
awplus# configure terminal  
awplus(config)# interface <id>
```

- 2) Specify the mode of authentication for the given interface (text or MD5), using the following commands:

```
awplus# configure terminal  
awplus(config-if)# ip rip authentication string <auth-string>  
awplus(config)# interface <id>  
awplus(config-if)# ip rip authentication mode {md5|text}
```

**Example** See the example below to specify `mykey` as the authentication string with MD5 authentication for the VLAN interface `vlan2`:

```
awplus# configure terminal  
awplus(config)# interface vlan2  
awplus(config-if)# ip rip authentication string mykey  
awplus(config-if)# ip rip authentication mode md5
```

**Example** In the following example, the VLAN interface `vlan2` is configured to have an authentication string as `guest`. Any received RIP packet in that interface should have the same string as password.

```
awplus# configure terminal
awplus(config)# interface vlan2
awplus(config-if)# ip rip authentication string guest
```

**Related commands** [ip rip authentication key-chain](#)  
[ip rip authentication mode](#)

# ip rip receive-packet

**Overview** Use this command to configure the interface to enable the reception of RIP packets.

Use the **no** variant of this command to disable this feature.

**Syntax** ip rip receive-packet  
no ip rip receive-packet

**Default** Receive-packet is enabled

**Mode** Interface Configuration for a VLAN interface.

**Example** This example shows packet receiving being turned on for the VLAN interface vlan3:

```
awplus# configure terminal
awplus(config)# interface vlan3
awplus(config-if)# ip rip receive-packet
```

**Related commands** [ip rip send-packet](#)

# ip rip receive version

**Overview** Use this command to specify the version of RIP packets accepted on an interface and override the setting of the version command.

Use the **no** variant of this command to use the setting specified by the [version \(RIP\)](#) command.

**Syntax** `ip rip receive version {[1][2]}`  
`no ip rip receive version`

Parameter	Description
1	Specifies acceptance of RIP version 1 packets on the interface.
2	Specifies acceptance of RIP version 2 packets on the interface.

**Default** Version 2

**Mode** Interface Configuration for a VLAN interface.

**Usage notes** This command applies to a specific VLAN interface and overrides any the version specified by the [version \(RIP\)](#) command.

RIP can be run in version 1 or version 2 mode. Version 2 has more features than version 1; in particular RIP version 2 supports authentication and classless routing. Once the RIP version is set, RIP packets of that version will be received and sent on all the RIP-enabled interfaces.

**Example** In the following example, the VLAN interface `vlan3` is configured to receive both RIP version 1 and 2 packets:

```
awplus# configure terminal
awplus(config)# interface vlan3
awplus(config-if)# ip rip receive version 1 2
```

**Related commands** [version \(RIP\)](#)

# ip rip send-packet

**Overview** Use this command to enable sending RIP packets through the current interface. Use the **no** variant of this command to disable this feature.

**Syntax** `ip rip send-packet`  
`no ip rip send-packet`

**Default** Send packet is enabled

**Mode** Interface Configuration for a VLAN interface.

**Example** This example shows packet sending being turned on for the VLAN interface `vlan4`:

```
awplus# configure terminal
awplus(config)# interface vlan4
awplus(config-if)# ip rip send-packet
```

**Related commands** [ip rip receive-packet](#)

# ip rip send version

**Overview** Use this command in Interface Configuration mode to specify the version of RIP packets sent on an interface and override the setting of the [version \(RIP\)](#) command. This mechanism causes RIP version 2 interfaces to send multicast packets instead of broadcasting packets.

Use the **no** variant of this command to use the setting specified by the [version \(RIP\)](#) command.

**Syntax** `ip rip send version {1|2|1 2|2 1}`  
`no ip rip send version`

Parameter	Description
1	Specifies the sending of RIP version 1 packets out of an interface.
2	Specifies the sending of RIP version 2 packets out of an interface.
12	Specifies the sending of both RIP version 1 and RIP version 2 packets out of an interface.
21	Specifies the sending of both RIP version 2 and RIP version 1 packets out of an interface.

**Default** RIP version 2 is enabled by default.

**Mode** Interface Configuration for a VLAN interface.

**Usage notes** This command applies to a specific interface and overrides the version specified by the [version \(RIP\)](#) command.

RIP can be run in version 1 or version 2 mode. Version 2 has more features than version 1; in particular RIP version 2 supports authentication and classless routing. Once the RIP version is set, RIP packets of that version will be received and sent on all the RIP-enabled interfaces. Selecting version parameters 1 2 or 2 1 sends RIP version 1 and 2 packets.

Use the [ip rip send version 1-compatible](#) command in an environment where you cannot send multicast packets. For example, in environments where multicast is not enabled and where hosts do not listen to multicast.

**Examples** In the following example, the VLAN interface `vlan4` is configured to send both RIP version 1 and 2 packets.

```
awplus# configure terminal
awplus(config)# interface vlan4
awplus(config-if)# ip rip send version 1 2
```

In the following example, the VLAN interface `vlan4` is configured to send both RIP version 2 and 1 packets.

```
awplus# configure terminal
awplus(config)# interface vlan4
awplus(config-if)# ip rip send version 2 1
```

In the following example, the VLAN interface `vlan4` is configured to send RIP version 1 packets only.

```
awplus# configure terminal
awplus(config)# interface vlan4
awplus(config-if)# ip rip send version 1
```

In the following example, the VLAN interface `vlan4` is configured to send RIP version 2 packets only.

```
awplus# configure terminal
awplus(config)# interface vlan4
awplus(config-if)# ip rip send version 2
```

In the following example, the VLAN interface `vlan3` is configured to use the RIP version specified by the [version \(RIP\)](#) command.

```
awplus# configure terminal
awplus(config)# interface vlan3
awplus(config-if)# no ip rip send version
```

**Related commands** [ip rip send version 1-compatible](#)  
[version \(RIP\)](#)



# ip rip send version 1-compatible

**Overview** Use this command in Interface Configuration mode to send RIP version 1 compatible packets from a RIP version 2 interfaces to other RIP Interfaces. This mechanism causes RIP version 2 interfaces to send broadcast packets instead of multicasting packets, and is used in environments where multicast is not enabled or where hosts do not listen to multicast.

Use the **no** variant of this command to use the setting specified by the [version \(RIP\)](#) command, and disable the broadcast of RIP version 2 packets that are sent as broadcast packets.

**Syntax** `ip rip send version 1-compatible`  
`no ip rip send version`

Parameter	Description
1-compatible	Specify this parameter to send RIP version 1 compatible packets from a version 2 RIP interface to other RIP interfaces. This mechanism causes version 2 RIP interfaces to broadcast packets instead of multicasting packets.

**Default** RIP version 2 is enabled by default.

**Mode** Interface Configuration for a VLAN interface.

**Usage notes** This command applies to a specific interface and overrides the version specified by the [version \(RIP\)](#) command.

RIP can be run in version 1 compatible mode. Version 2 has more features than version 1; in particular RIP version 2 supports authentication and classless routing. Once the RIP version is set, RIP packets of that version will be received and sent on all the RIP-enabled interfaces.

Use the [ip rip send version](#) command in an environment where you can send multicast packets. For example, in environments where multicast is enabled and where hosts listen to multicast.

**Examples** In the following example, the VLAN interface `vlan2` is configured to send RIP version 1-compatible packets.

```
awplus# configure terminal
awplus(config)# interface vlan2
awplus(config-if)# ip rip send version 1-compatible
```

In the following example, the VLAN interface `vlan3` is configured to use the RIP version specified by the [version \(RIP\)](#) command.

```
awplus# configure terminal
awplus(config)# interface vlan3
awplus(config-if)# no ip rip send version
```

**Related  
commands** [ip rip send version](#)  
[version \(RIP\)](#)

# ip rip split-horizon

**Overview** Use this command to turn on the split-horizon mechanism on the interface. Use the **no** variant of this command to disable this mechanism.

**Syntax** `ip rip split-horizon [poisoned]`  
`no ip rip split-horizon`

Parameter	Description
poisoned	Performs split-horizon with poison-reverse. See "Usage" below for more information.

**Default** Split horizon poisoned

**Mode** Interface Configuration for a VLAN interface.

**Usage notes** Use this command to avoid including routes in updates sent to the same gateway from which they were learned. Without the **poisoned** parameter, using this command causes routes learned from a neighbor to be omitted from updates sent to that neighbor. With the **poisoned** parameter, using this command causes such routes to be included in updates, but sets their metrics to infinity. This advertises that these routes are not reachable.

**Example** To turn on split horizon poisoned on vlan2, use the following commands:

```
awplus# configure terminal
awplus(config)# interface vlan2
awplus(config-if)# ip rip split-horizon poisoned
```

# key

**Overview** Use this command to manage, add and delete authentication keys in a key-chain. Use the **no** variant of this command to delete the authentication key.

**Syntax** `key <keyid>`  
`no key <keyid>`

Parameter	Description
<code>&lt;keyid&gt;</code>	<code>&lt;0-2147483647&gt;</code> Key identifier number.

**Mode** Keychain Configuration

**Usage** This command allows you to enter the keychain-key mode where a password can be set for the key.

**Example** The following example configures a key number 1 and shows the change into a **keychain- key** command mode prompt.

```
awplus# configure terminal
awplus(config)# key chain mychain
awplus(config-keychain)# key 1
awplus(config-keychain-key)#
```

**Related commands** [key chain](#)  
[key-string](#)  
[accept-lifetime](#)  
[send-lifetime](#)

# key chain

**Overview** Use this command to enter the key chain management mode and to configure a key chain with a key chain name.

Use the **no** variant of this command to remove the key chain and all configured keys.

**Syntax** `key chain <key-chain-name>`  
`no key chain <key-chain-name>`

Parameter	Description
<code>&lt;key-chain-name&gt;</code>	Specify the name of the key chain to manage.

**Mode** Global Configuration

**Usage** This command allows you to enter the keychain mode from which you can specify keys on this key chain.

**Example** The following example shows the creation of a key chain named `mychain` and the change into **keychain** mode prompt.

```
awplus# configure terminal
awplus(config)# key chain mychain
awplus(config-keychain)#
```

**Related commands** [key](#)  
[key-string](#)  
[accept-lifetime](#)  
[send-lifetime](#)

# key-string

**Overview** Use this command to define the password to be used by a key.  
Use the **no** variant of this command to remove a password.

**Syntax** `key-string <key-password>`  
`no key-string`

Parameter	Description
<code>&lt;key-password&gt;</code>	A string of characters to be used as a password by the key.

**Mode** Keychain-key Configuration

**Usage** Use this command to specify passwords for different keys.

**Examples** In the following example, the password for `key1` in the key chain named `mychain` is set to password **prime**:

```
awplus# configure terminal
awplus(config)# key chain mychain
awplus(config-keychain)# key 1
awplus(config-keychain-key)# key-string prime
```

In the following example, the password for `key1` in the key chain named `mychain` is removed:

```
awplus# configure terminal
awplus(config)# key chain mychain
awplus(config-keychain)# key 1
awplus(config-keychain-key)# no key-string
```

**Related commands** [key](#)  
[key chain](#)  
[accept-lifetime](#)  
[send-lifetime](#)

# maximum-prefix

**Overview** Use this command to configure the maximum number of RIP routes stored in the routing table.

Use the **no** variant of this command to disable all limiting of the number of RIP routes stored in the routing table.

**Syntax** `maximum-prefix <maxprefix> [<threshold>]`  
`no maximum-prefix`

Parameter	Description
<code>&lt;maxprefix&gt;</code>	<code>&lt;1-65535&gt;</code> The maximum number of RIP routes allowed.
<code>&lt;threshold&gt;</code>	<code>&lt;1-100&gt;</code> Percentage of maximum routes to generate a warning. The default threshold is 75%.

**Mode** Router Configuration

**Example** To configure the maximum number of RIP routes to 150, use the following command:

```
awplus# configure terminal
awplus(config)# router rip
awplus(config-router)# maximum-prefix 150
```

# neighbor (RIP)

**Overview** Use this command to specify a neighbor router. It is used for each router to which you wish to send unicast RIP updates.

Use the **no** variant of this command to stop sending unicast updates to the specific router.

**Syntax** `neighbor <ip-address>`  
`no neighbor <ip-address>`

Parameter	Description
<code>&lt;ip-address&gt;</code>	The IP address of a neighboring router with which the routing information will be exchanged.

**Default** Disabled

**Mode** Router Configuration

**Usage** Use this command to exchange nonbroadcast routing information. It can be used multiple times for additional neighbors.

The [passive-interface \(RIP\)](#) command disables sending routing updates on an interface. Use the `neighbor` command in conjunction with the [passive-interface \(RIP\)](#) to send routing updates to specific neighbors.

**Example** To specify the neighbor router to 1.1.1.1, use the following command:

```
awplus# configure terminal
awplus(config)# router rip
awplus(config-router)# passive-interface vlan1
awplus(config-router)# neighbor 1.1.1.1
```

**Related commands** [passive-interface \(RIP\)](#)



# network (RIP)

**Overview** Use this command to activate the transmission of RIP routing information on the defined network.

Use the **no** variant of this command to remove the specified network or VLAN as one that runs RIP.

**Syntax** `network {<network-address>[/<subnet-mask>]|<vlan-name>}`  
`no network {<network-address>[/<subnet-mask>]|<vlan-name>}`

Parameter	Description
<code>&lt;network-address&gt;</code> <code>[ /&lt;subnet-mask&gt; ]</code>	Specifies the network address to run RIP. Entering a subnet mask (or prefix length) for the network address is optional. Where no mask is entered, the device will attempt to apply a mask that is appropriate to the class (A, B, or C) of the address entered, e.g. an IP address of 10.0.0.0 will have a prefix length of 8 applied to it.
<code>&lt;vlan-name&gt;</code>	Specify a VLAN name with up to 32 alphanumeric characters to run RIP.

**Default** Disabled

**Mode** RIP Router Configuration

**Usage notes** Use this command to specify networks, or VLANs, to which routing updates will be sent and received. The connected routes corresponding to the specified network, or VLANs, will be automatically advertised in RIP updates. RIP updates will be sent and received within the specified network or VLAN.

**Example** Use the following commands to activate RIP routing updates on network 172.16.20.0/24:

```
awplus# configure terminal
awplus(config)# router rip
awplus(config-router)# network 172.16.20.0/24
```

**Related commands** [show ip rip](#)  
[show running-config](#)  
[clear ip rip route](#)

# offset-list (RIP)

**Overview** Use this command to add an offset to the **in** and **out** metrics of routes learned through RIP.

Use the **no** variant of this command to remove the offset list.

**Syntax** `offset-list <access-list> {in|out} <offset> [<interface>]`  
`no offset-list <access-list> {in|out} <offset> [<interface>]`

Parameter	Description
<code>&lt;access-list&gt;</code>	Specifies the access-list number or names to apply. Note that you can only use standard ACLs, not extended ACLs.
<code>in</code>	Indicates the access list will be used for metrics of incoming advertised routes.
<code>out</code>	Indicates the access list will be used for metrics of outgoing advertised routes.
<code>&lt;offset&gt;</code>	<code>&lt;0-16&gt;</code> Specifies that the offset is used for metrics of networks matching the access list.
<code>&lt;interface&gt;</code>	An alphanumeric string that specifies the interface to match.

**Default** The default offset value is the metric value of the interface over which the updates are being exchanged.

**Mode** RIP Router Configuration

**Usage** Use this command to specify the offset value that is added to the routing metric. When the networks match the access list the offset is applied to the metrics. No change occurs if the offset value is zero.

**Examples** In this example the router examines the RIP updates being sent out from interface `vlan2` and adds 5 hops to the routes matching the IP addresses specified in the access list 8. To do this, use these commands:

```
awplus# configure terminal
awplus(config)# router rip
awplus(config-router)# offset-list 8 in 5 vlan2
```

**Related commands** [access-list \(extended numbered\)](#)

# passive-interface (RIP)

**Overview** Use this command to block RIP broadcasts on the interface.  
Use the **no** variant of this command to disable this function.

**Syntax** `passive-interface <interface>`  
`no passive-interface <interface>`

Parameter	Description
<code>&lt;interface&gt;</code>	Specifies the interface name.

**Default** Disabled

**Mode** RIP Router Configuration

**Example** Use the following commands to block RIP broadcasts on vlan20:

```
awplus# configure terminal
awplus(config)# router rip
awplus(config-router)# passive-interface vlan20
```

**Related commands** [show ip rip](#)

# recv-buffer-size (RIP)

**Overview** Use this command to run-time configure the RIP UDP (User Datagram Protocol) receive-buffer size to improve UDP reliability by avoiding UDP receive buffer overrun.

Use the **no** variant of this command to reset the configured RIP UDP receive-buffer size to the system default (196608 bits).

**Syntax** `recv-buffer-size <8192-2147483647>`  
`no recv-buffer-size [<8192-2147483647>]`

Parameter	Description
<code>&lt;8192-2147483647&gt;</code>	Specify the RIP UDP (User Datagram Protocol) buffer size value in bits.

**Default** 196608 bits is the system default when reset using the **no** variant of this command.

**Mode** Router Configuration

**Examples** To run-time configure the RIP UDP, use the following commands:

```
awplus# configure terminal
awplus(config)# router rip
awplus(config-router)# recv-buffer-size 23456789
awplus# configure terminal
awplus(config)# router rip
awplus(config-router)# no recv-buffer-size 23456789
```

# redistribute (RIP)

**Overview** Use this command to redistribute information from other routing protocols into RIP.

Use the **no** variant of this command to disable the specified redistribution. The parameters **metric** and **route-map** may be used with the **no** variant, but have no effect.

**Syntax** `redistribute {connected|static|ospf} [metric <0-16>] [route-map <route-map>]`

`no redistribute {connected|static|ospf} [metric] [route-map]`

Parameter	Description
<code>route-map</code>	Optional. Specifies route-map that controls how routes are redistributed.
<code>&lt;route-map&gt;</code>	Optional. The name of the route map.
<code>connected</code>	Redistribute from connected routes.
<code>static</code>	Redistribute from static routes.
<code>ospf</code>	Redistribute from Open Shortest Path First (OSPF).
<code>metric &lt;0-16&gt;</code>	Optional. Sets the value of the metric that will be applied to routes redistributed into RIP from other protocols. If a value is not specified, and no value is specified using the <a href="#">default-metric (RIP)</a> command, the default is one.

**Default** By default, the RIP metric value is set to 1.

**Mode** RIP Router Configuration

**Example** To apply the metric value 15 to static routes being redistributed into RIP, use the commands:

```
awplus# configure terminal
awplus(config)# router rip
awplus(config-router)# redistribute static metric 15
```

**Related commands** [default-metric \(RIP\)](#)

# restart rip graceful

**Overview** Use this command to force the RIP process to restart, and optionally set the grace-period.

**Syntax** `restart rip graceful [grace-period <1-65535>]`

**Mode** Privileged Exec

**Default** The default RIP grace-period is 60 seconds.

**Usage notes** After this command is executed, the RIP process immediately shuts down. It notifies the system that RIP has performed a graceful shutdown. Routes that have been installed into the route table by RIP are preserved until the specified grace-period expires.

When a **restart rip graceful** command is issued, the RIP configuration is reloaded from the last saved configuration. Ensure you first enter the command `copy running-config startup-config`.

**Example** To apply a restart rip graceful setting, grace-period to 100 seconds use the following commands:

```
awplus# copy running-config startup-config
awplus# restart rip graceful grace-period 100
```

# rip restart grace-period

**Overview** Use this command to change the grace period of RIP graceful restart.  
Use the **no** variant of this command to disable this function.

**Syntax** `rip restart grace-period <1-65535>`  
`no rip restart grace-period <1-65535>`

**Mode** Global Configuration

**Default** The default RIP grace-period is 60 seconds.

**Usage notes** Use this command to enable the **Graceful Restart** feature on the RIP process.  
Entering this command configures a grace period for RIP.

**Example** `awplus# configure terminal`  
`awplus(config)# rip restart grace-period 200`

# route (RIP)

**Overview** Use this command to add a static RIP route.  
Use the **no** variant of this command to remove a static RIP route.

**Syntax** `route <ip-addr/prefix-length>`  
`no route <ip-addr/prefix-length>`

Parameter	Description
<code>&lt;ip-addr/prefix-length&gt;</code>	The IPv4 address and prefix length.

**Default** No static RIP route is added by default.

**Mode** RIP Router Configuration

**Usage notes** Use this command to add a static RIP route. After adding the RIP route, the route can be checked in the RIP routing table.

**Example** To create a static RIP route to IP subnet 192.168.1.0/24, use the following commands:

```
awplus# configure terminal
awplus(config)# router rip
awplus(config-router)# route 192.168.1.0/24
```

**Related commands** [show ip rip](#)  
[clear ip rip route](#)



# router rip

**Overview** Use this global command to enter Router Configuration mode to enable the RIP routing process.

Use the **no** variant of this command to disable the RIP routing process.

**Syntax** `router rip`  
`no router rip`

**Mode** Global Configuration

**Example** This command is used to begin the RIP routing process:

```
awplus# configure terminal
awplus(config)# router rip
awplus(config-router)# version 1
awplus(config-router)# network 10.10.10.0/24
awplus(config-router)# network 10.10.11.0/24
awplus(config-router)# neighbor 10.10.10.10
```

**Related commands** [network \(RIP\)](#)  
[version \(RIP\)](#)

# send-lifetime

**Overview** Use this command to specify the time period during which the authentication key on a key chain can be sent.

**Syntax** `send-lifetime <start-date> {<end-date>|  
duration <seconds>|infinite}`  
`no send-lifetime`

Parameter	Description
<code>&lt;start-date&gt;</code>	Specifies the start time and date in the format: <code>&lt;hh:mm:ss&gt; &lt;day&gt; &lt;month&gt; &lt;year&gt;</code> or <code>&lt;hh:mm:ss&gt; &lt;month&gt; &lt;day&gt; &lt;year&gt;</code> , where:
<code>&lt;hh:mm:ss&gt;</code>	The time of the day, in hours, minutes and seconds
<code>&lt;day&gt;</code>	<1-31> The day of the month
<code>&lt;month&gt;</code>	The month of the year (the first three letters of the month, for example, Jan)
<code>&lt;year&gt;</code>	<1993-2035> The year
<code>&lt;end-date&gt;</code>	Specifies the end time and date in the format: <code>&lt;hh:mm:ss&gt; &lt;day&gt; &lt;month&gt; &lt;year&gt;</code> or <code>&lt;hh:mm:ss&gt; &lt;month&gt; &lt;day&gt; &lt;year&gt;</code> , where:
<code>&lt;hh:mm:ss&gt;</code>	The time of the day, in hours, minutes and seconds
<code>&lt;day&gt;</code>	<1-31> The day of the month
<code>&lt;month&gt;</code>	The month of the year (the first three letters of the month, for example, Jan)
<code>&lt;year&gt;</code>	<1993-2035> The year
<code>&lt;seconds&gt;</code>	<1-2147483646> Duration of the key in seconds.
<code>infinite</code>	Never expires.

**Mode** Keychain-key Configuration

**Example** The following example shows the setting of send-lifetime for key 1 on the key chain named "mychain".

```
awplus# configure terminal
awplus(config)# key chain mychain
awplus(config-keychain)# key 1
awplus(config-keychain-key)# send-lifetime 03:03:01 Jan 3 2016
04:04:02 Dec 6 2016
```

**Related  
commands** [key](#)  
[key-string](#)  
[key chain](#)  
[accept-lifetime](#)

# show debugging rip

**Overview** Use this command to display the RIP debugging status for these debugging options: nsm debugging, RIP event debugging, RIP packet debugging and RIP nsm debugging.

For information on filtering and saving command output, see the [“Getting\\_Started with AlliedWare Plus” Feature Overview and Configuration\\_Guide](#).

**Syntax** `show debugging rip`

**Mode** User Exec and Privileged Exec

**Usage notes** Use this command to display the debug status of RIP.

**Example** `awplus# show debugging rip`

# show ip protocols rip

**Overview** Use this command to display RIP process parameters and statistics.  
For information on filtering and saving command output, see the [“Getting\\_Started with AlliedWare Plus” Feature Overview and Configuration\\_Guide](#).

**Syntax** `show ip protocols rip`

**Mode** User Exec and Privileged Exec

**Example** `awplus# show ip protocols rip`

**Output** Figure 23-1: Example output from the **show ip protocols rip** command

```
Routing Protocol is "rip"
Sending updates every 30 seconds with +/-50%, next due in 12
seconds
Timeout after 180 seconds, garbage collect after 120 seconds
Outgoing update filter list for all interface is not set
Incoming update filter list for all interface is not set
Default redistribution metric is 1
Redistributing: connected static
Default version control: send version 2, receive version 2
Interface          Send  Recv  Key-chain
   vlan25           2    2
Routing for Networks:
  10.10.0.0/24
Routing Information Sources:
  Gateway          BadPackets BadRoutes  Distance Last Update
Distance: (default is 120
```

# show ip rip

**Overview** Use this command to show RIP routes.

For information on filtering and saving command output, see the [“Getting Started with AlliedWare Plus” Feature Overview and Configuration Guide](#).

**Syntax** `show ip rip`

**Mode** User Exec and Privileged Exec

**Example** `awplus# show ip rip`

**Output** Figure 23-2: Example output from the **show ip rip** command

```
awplus#show ip rip
Codes: R - RIP, Rc - RIP connected, Rs - RIP static
       C - Connected, S - Static, O - OSPF, B - BGP
Network      Next Hop Metric From If    Time
C 10.0.1.0/24          1      vlan20
S 10.10.10.0/24        1      vlan20
C 10.10.11.0/24        1      vlan20
S 192.168.101.0/24     1      vlan20
R 192.192.192.0/24     1      --
```

**Related commands**

- [route \(RIP\)](#)
- [network \(RIP\)](#)
- [clear ip rip route](#)

# show ip rip database

**Overview** Use this command to display information about the RIP database.  
For information on filtering and saving command output, see the [“Getting\\_Started with AlliedWare Plus” Feature Overview and Configuration\\_Guide](#).

**Syntax** `show ip rip database [full]`

Parameter	Description
full	Specify the full RIP database including sub-optimal RIP routes.

**Mode** User Exec and Privileged Exec

**Example**  
`awplus# show ip rip database`  
`awplus# show ip rip database full`

**Related commands** [show ip rip](#)

# show ip rip interface

**Overview** Use this command to display information about the RIP interfaces. You can specify an interface name to display information about a specific interface.

**Syntax** `show ip rip interface [<interface>]`

Parameter	Description
<interface>	The interface to display information about. For instance: <code>vlan2</code> .

**Mode** User Exec and Privileged Exec

**Example** `awplus# show ip rip interface`



# timers (RIP)

**Overview** Use this command to adjust routing network timers.  
Use the **no** variant of this command to restore the defaults.

**Syntax** `timers basic <update> <timeout> <garbage>`  
`no timers basic`

Parameter	Description
<code>&lt;update&gt;</code>	<code>&lt;5-2147483647&gt;</code> Specifies the period at which RIP route update packets are transmitted. The default is 30 seconds.
<code>&lt;timeout&gt;</code>	<code>&lt;5-2147483647&gt;</code> Specifies the routing information timeout timer in seconds. The default is 180 seconds. After this interval has elapsed and no updates for a route are received, the route is declared invalid.
<code>&lt;garbage&gt;</code>	<code>&lt;5-2147483647&gt;</code> Specifies the routing garbage collection timer in seconds. The default is 120 seconds.

**Default** Enabled

**Mode** RIP Router Configuration

**Usage notes** This command adjusts the RIP timing parameters.

The update timer is the time between sending out updates, that contain the complete routing table, to every neighboring router.

If an update for a given route has not been seen for the time specified by the timeout parameter, that route is no longer valid. However, it is retained in the routing table for a short time, with metric 16, so that neighbors are notified that the route has been dropped.

When the time specified by the garbage parameter expires the metric 16 route is finally removed from the routing table. Until the garbage time expires, the route is included in all updates sent by the router.

All the routers in the network must have the same timers to ensure the smooth operation of RIP throughout the network.

**Examples** To set the update timer to 30, the routing information timeout timer to 180, and the routing garbage collection timer to 120, use the following command:

```
awplus# configure terminal
awplus(config)# router rip
awplus(config-router)# timers basic 30 180 120
```

# undebg rip

**Overview** Use this command to disable the options set for debugging information of RIP events, packets and communication between RIP and NSM.

This command has the same effect as the **no debug rip** command.

**Syntax** `undebg rip {all|events|nsm|<packet>}`

Parameter	Description
all	Disables all RIP debugging.
events	Disables the logging of RIP events.
nsm	Disables the logging of RIP and NSM communication.
<packet>	packet [recv send] [detail] Disables the debugging of RIP packets.
recv	Disables the logging of received packet information.
send	Disables the logging of sent packet information.
detail	Disables the logging of sent or received RIP packets.

**Mode** Privileged Exec

**Example** To disable the options set for debugging RIP information events, use the following command:

```
awplus# undebg rip packet
```

**Related commands** [debug rip](#)

# version (RIP)

**Overview** Use this command to specify a RIP version used globally by the router.  
Use the **no** variant of this command to restore the default version.

**Syntax** `version {1|2}`  
`no version`

Parameter	Description
1   2	Specifies the version of RIP processing.

**Default** Version 2

**Mode** RIP Router Configuration

**Usage notes** RIP can be run in version 1 or version 2 mode. Version 2 has more features than version 1; in particular RIP version 2 supports authentication and classless routing. Once the RIP version is set, RIP packets of that version will be received and sent on all the RIP-enabled interfaces.

Setting the version command has no impact on receiving updates, only on sending them. The `ip rip send version` command overrides the value set by the `version (RIP)` command on an interface-specific basis. The `ip rip receive version` command allows you to configure a specific interface to accept only packets of the specified RIP version. The `ip rip receive version` command and the `ip rip send version` command override the value set by this command.

**Examples** To specify a RIP version, use the following commands:

```
awplus# configure terminal
awplus(config)# router rip
awplus(config-router)# version 1
```

**Related commands** `ip rip receive version`  
`ip rip send version`  
`show running-config`

# Part 4: Multicast Applications

# 24

# IGMP and IGMP Snooping Commands

## Introduction

**Overview** Devices running AlliedWare Plus use IGMP (Internet Group Management Protocol) and MLD (Multicast Listener Discovery) to track which multicast groups their clients belong to. This enables them to send the correct multimedia streams to the correct destinations. IGMP is used for IPv4 multicasting, and MLD is used for IPv6 multicasting.

This chapter describes the commands to configure IGMP Querier behaviour and selection and IGMP Snooping.

- Command List**
- [“clear ip igmp”](#) on page 807
  - [“clear ip igmp group”](#) on page 808
  - [“clear ip igmp interface”](#) on page 809
  - [“debug igmp”](#) on page 810
  - [“ip igmp”](#) on page 811
  - [“ip igmp access-group”](#) on page 812
  - [“ip igmp flood specific-query”](#) on page 813
  - [“ip igmp immediate-leave”](#) on page 814
  - [“ip igmp last-member-query-count”](#) on page 815
  - [“ip igmp last-member-query-interval”](#) on page 816
  - [“ip igmp limit”](#) on page 817
  - [“ip igmp maximum-groups”](#) on page 818
  - [“ip igmp querier-timeout”](#) on page 820
  - [“ip igmp query-holdtime”](#) on page 821
  - [“ip igmp query-interval”](#) on page 823
  - [“ip igmp query-max-response-time”](#) on page 825

- [“ip igmp ra-option”](#) on page 827
- [“ip igmp robustness-variable”](#) on page 828
- [“ip igmp snooping”](#) on page 829
- [“ip igmp snooping fast-leave”](#) on page 830
- [“ip igmp snooping mrouter”](#) on page 831
- [“ip igmp snooping querier”](#) on page 832
- [“ip igmp snooping report-suppression”](#) on page 833
- [“ip igmp snooping routermode”](#) on page 834
- [“ip igmp snooping source-timeout”](#) on page 836
- [“ip igmp snooping tcn query solicit”](#) on page 837
- [“ip igmp source-address-check”](#) on page 839
- [“ip igmp static-group”](#) on page 840
- [“ip igmp startup-query-count”](#) on page 842
- [“ip igmp startup-query-interval”](#) on page 843
- [“ip igmp trusted”](#) on page 844
- [“ip igmp version”](#) on page 845
- [“show debugging igmp”](#) on page 846
- [“show ip igmp groups”](#) on page 847
- [“show ip igmp interface”](#) on page 849
- [“show ip igmp snooping mrouter”](#) on page 851
- [“show ip igmp snooping routermode”](#) on page 852
- [“show ip igmp snooping source-timeout”](#) on page 853
- [“show ip igmp snooping statistics”](#) on page 854
- [“undebg igmp”](#) on page 856

# clear ip igmp

**Overview** Use this command to clear all IGMP group membership records on all VLAN interfaces.

**Syntax** `clear ip igmp`

**Mode** Privileged Exec

**Example** `awplus# clear ip igmp`

**Related commands**

- `clear ip igmp group`
- `clear ip igmp interface`
- `show ip igmp interface`
- `show running-config`

**Command changes**

- Version 5.4.7-1.1: VRF-lite support added SBx8100.
- Version 5.4.8-1.1: VRF-lite support added x930, SBx908 GEN2.

# clear ip igmp group

**Overview** Use this command to clear IGMP group membership records for a specific group on either all interfaces, a single interface, or for a range of interfaces.

**Syntax** `clear ip igmp group *`  
`clear ip igmp group <ip-address> <interface>`

Parameter	Description
*	Clears all groups on all interfaces. This has the same effect as the <b>clear ip igmp</b> command.
<ip-address>	Specifies the group whose membership records will be cleared from all interfaces, entered in the form A.B.C.D.
<interface>	Specifies the name of the interface; all groups learned on this interface are deleted.

**Mode** Privileged Exec

**Usage notes** This command applies to groups learned by IGMP or IGMP Snooping. In addition to the group, an interface can be specified. Specifying this will mean that only entries with the group learned on the interface will be deleted.

**Examples** To delete all group records, use the command:

```
awplus# clear ip igmp group *
```

To delete records for 224.1.1.1 on vlan1, use the command:

```
awplus# clear ip igmp group 224.1.1.1 vlan1
```

**Related commands** [clear ip igmp](#)  
[clear ip igmp interface](#)  
[show ip igmp interface](#)  
[show running-config](#)

**Command changes** Version 5.4.7-1.1: VRF-lite support added SBx8100.  
Version 5.4.8-1.1: VRF-lite support added x930, SBx908 GEN2.



# clear ip igmp interface

**Overview** Use this command to clear IGMP group membership records on a particular interface.

**Syntax** `clear ip igmp interface <interface>`

Parameter	Description
<interface>	Specifies the name of the interface. All groups learned on this interface are deleted.

**Mode** Privileged Exec

**Usage notes** This command applies to interfaces configured for IGMP or IGMP Snooping.

**Example** To delete records for vlan1, use the command:

```
awplus# clear ip igmp interface vlan1
```

**Related commands**

- [clear ip igmp](#)
- [clear ip igmp group](#)
- [show ip igmp interface](#)
- [show running-config](#)

**Command changes**

- Version 5.4.7-1.1: VRF-lite support added SBx8100.
- Version 5.4.8-1.1: VRF-lite support added x930, SBx908 GEN2.

# debug igmp

**Overview** Use this command to enable debugging of either all IGMP or a specific component of IGMP.

Use the **no** variant of this command to disable all IGMP debugging, or debugging of a specific component of IGMP.

**Syntax** `debug igmp {all|decode|encode|events|fsm|tib}`  
`no debug igmp {all|decode|encode|events|fsm|tib}`

Parameter	Description
all	Enable or disable all debug options for IGMP
decode	Debug of IGMP packets that have been received
encode	Debug of IGMP packets that have been sent
events	Debug IGMP events
fsm	Debug IGMP Finite State Machine (FSM)
tib	Debug IGMP Tree Information Base (TIB)

**Modes** Privileged Exec and Global Configuration

**Example** `awplus# configure terminal`  
`awplus(config)# debug igmp all`

**Related commands** [show debugging igmp](#)  
[undebug igmp](#)

**Command changes** Version 5.4.7-1.1: VRF-lite support added SBx8100.  
Version 5.4.8-1.1: VRF-lite support added x930, SBx908 GEN2.

# ip igmp

**Overview** Use this command to enable IGMP on an interface. The command configures the device as an IGMP querier.

Use the **no** variant of this command to return all IGMP related configuration to the default on this interface.

**Syntax** ip igmp  
no ip igmp

**Default** Disabled

**Mode** Interface Configuration for a VLAN interface.

**Usage notes** An IP address must be assigned to the interface first, before this command will work.

**Example** To specify an interface as an IGMP querier, use the commands:

```
awplus# configure terminal
awplus(config)# interface vlan2
awplus(config-if)# ip igmp
```

**Validation  
Commands** show ip igmp interface  
show running-config

# ip igmp access-group

**Overview** This command adds an access control list to a VLAN interface configured for IGMP or IGMP Snooping. The access control list is used to control and filter the multicast groups learned on the VLAN interface.

The **no** variant of this command disables the access control filtering on the interface.

**Syntax** `ip igmp access-group {<access-list-number> | <access-list-name>}`  
`no ip igmp access-group`

Parameter	Description
<code>&lt;access-list-number&gt;</code>	Standard IP access-list number, in the range <1-99>.
<code>&lt;access-list-name&gt;</code>	Standard IP access-list name.

**Default** By default there are no access lists configured on any interface.

**Mode** Interface Configuration for a VLAN interface.

**Usage notes** This command applies to VLAN interfaces configured for IGMP or IGMP Snooping.

**Example** In the following example, hosts serviced by VLAN interface `vlan2` can only join the group `225.2.2.2`:

```
awplus# configure terminal
awplus(config)# access-list 1 permit 225.2.2.2 0.0.0.0
awplus(config)# interface vlan2
awplus(config-if)# ip igmp access-group 1
```

# ip igmp flood specific-query

**Overview** Use this command if you want IGMP to flood specific queries to all VLAN member ports, instead of only sending the queries to multicast group member ports.

Use the **no** variant of this command if you want IGMP to only send the queries to multicast group member ports.

**Syntax** `ip igmp flood specific-query`  
`no ip igmp flood specific-query`

**Default** By default, specific queries are flooded to all VLAN member ports.

**Mode** Global Configuration

**Usage** In an L2 switched network running IGMP, it is considered more robust to flood all specific queries. In most cases, the benefit of flooding specific queries to all VLAN member ports outweighs the disadvantages.

However, sometimes this is not the case. For example, if hosts with very low CPU capability receive specific queries for multicast groups they are not members of, their performance may degrade unacceptably. In this situation, it is desirable for IGMP to send specific queries to known member ports only. This minimizes the performance degradation of such hosts. In those circumstances, use this command to turn off flooding of specific queries.

**Example** To cause IGMP to flood specific queries only to multicast group member ports, use the commands:

```
awplus# configure terminal
awplus(config)# no ip igmp flood specific-query
```

**Related commands** [show ip igmp interface](#)

**Command changes** Version 5.4.7-1.1: VRF-lite support added SBx8100.  
Version 5.4.8-1.1: VRF-lite support added x930, SBx908 GEN2.

# ip igmp immediate-leave

**Overview** In IGMP version 2, use this command to minimize the leave latency of IGMP memberships for specified multicast groups. The specified access list number or name defines the multicast groups in which the immediate leave feature is enabled.

Use the **no** variant of this command to disable this feature.

**Syntax** `ip igmp immediate-leave group-list  
{<access-list-number> | <access-list-number-expanded> |  
<access-list-name>}`  
`no ip igmp immediate-leave`

Parameter	Description
<code>&lt;access-list-number&gt;</code>	Access-list number, in the range <1-99>.
<code>&lt;access-list-number-expanded&gt;</code>	Access-list number (expanded range), in the range <1300-1999>.
<code>&lt;access-list-name&gt;</code>	Standard IP access-list name.

**Default** Disabled by default.

**Mode** Interface Configuration for a VLAN interface.

**Usage notes** This command applies to VLAN interfaces configured for IGMP or IGMP Snooping.

**Example** The following example shows how to enable the immediate-leave feature on the VLAN interface `vlan2` for a specific range of multicast groups:

```
awplus# configure terminal
awplus(config)# interface vlan2
awplus(config-if)# ip igmp immediate-leave group-list 34
awplus(config-if)# exit
awplus(config)# access-list 34 permit 225.192.20.0 0.0.0.255
```

**Related commands** [ip igmp last-member-query-interval](#)

# ip igmp last-member-query-count

**Overview** Use this command to set the last-member query-count value for an interface.  
Use the **no** variant of this command to return to the default on an interface.

**Syntax** `ip igmp last-member-query-count <2-7>`  
`no ip igmp last-member-query-count`

Parameter	Description
<2-7>	Last member query count value.

**Default** The default last member query count value is 2.

**Mode** Interface Configuration for a VLAN interface.

**Usage notes** This command applies to VLAN interfaces configured for IGMP or IGMP Snooping.

**Example** To set the last-member query-count to 3 on vlan2, use the commands:

```
awplus# configure terminal
awplus(config)# interface vlan2
awplus(config-if)# ip igmp last-member-query-count 3
```

**Related commands**

- [ip igmp last-member-query-interval](#)
- [ip igmp startup-query-count](#)
- [show ip igmp interface](#)
- [show running-config](#)

# ip igmp last-member-query-interval

**Overview** Use this command to configure the frequency at which the router sends IGMP group specific host query messages.

Use the **no** variant of this command to set this frequency to the default.

**Syntax** `ip igmp last-member-query-interval <interval>`  
`no ip igmp last-member-query-interval`

Parameter	Description
<code>&lt;interval&gt;</code>	The frequency in milliseconds at which IGMP group-specific host query messages are sent, in the range 1000-25500.

**Default** 1000 milliseconds

**Mode** Interface Configuration for a VLAN interface.

**Usage notes** This command applies to VLAN interfaces configured for IGMP or IGMP Snooping.

**Example** To change the IGMP group-specific host query message interval to 2 seconds (2000 milliseconds) on vlan2, use the commands:

```
awplus# configure terminal
awplus(config)# interface vlan2
awplus(config-if)# ip igmp last-member-query-interval 2000
```

**Related commands** [ip igmp last-member-query-count](#)  
[show ip igmp interface](#)  
[show running-config](#)



# ip igmp limit

**Overview** Use this command to configure the limit on the maximum number of group membership entries for the device as a whole or for the specified interface (if in interface mode). Once the specified number of group memberships is reached, all further membership reports will be ignored.

Optionally, you can configure an access-list to stop certain addresses from being subject to the limit.

Use the **no** variant of this command to unset the limit and any specified exception access-list.

**Syntax**

```
ip igmp limit <limit-value> [except  
{<access-list-number> | <access-list-number-extended> |  
<access-list-name>}]  
  
no ip igmp limit
```

Parameter	Description
<limit-value>	Maximum number of group membership entries, from 2 to 512.
<access-list-number>	Access-list number, in the range 1 to 99.
<access-list-number-extended>	Access-list number (expanded range), in the range 1300 to 1999.
<access-list-name>	IP access-list name.

**Default** The default limit, which is reset by the **no** variant of this command, is 512.

**Mode** Global Configuration and Interface Configuration for a VLAN interface.

**Usage notes** This command applies to VLAN interfaces configured for IGMP or IGMP Snooping.

**Example** To configure an IGMP limit of 100 group membership entries on vlan2, use the commands:

```
awplus# configure terminal  
awplus(config)# interface vlan2  
awplus(config-if)# ip igmp limit 100
```

To configure an IGMP limit of 100 group membership entries across all interfaces on which IGMP is enabled, and exclude group 224.1.1.1 from this limitation, use the commands:

```
awplus# configure terminal  
awplus(config)# access-list 1 permit 224.1.1.1 0.0.0.0  
awplus(config)# ip igmp limit 100 except 1
```

# ip igmp maximum-groups

**Overview** Use this command to set a limit, per switch port, on the number of IGMP groups clients can join. This stops a single client from using all the switch's available group-entry resources, and ensures that clients on all ports have a chance to join IGMP groups.

Use the **no** variant of this command to remove the limit.

**Syntax** `ip igmp maximum-groups <0-65535>`  
`no ip igmp maximum-groups`

Parameter	Description
<code>&lt;0-65535&gt;</code>	The maximum number of IGMP groups clients can join on this switch port. 0 means no limit.

**Default** The default is 0, which means no limit

**Mode** Interface mode for a switch port

**Usage notes** We recommend using this command with IGMP snooping fast leave on the relevant VLANs. To enable fast leave, use the command:

```
awplus(config-if)# ip igmp snooping fast-leave
```

The device keeps count of the number of groups learned by each port. This counter is incremented when group joins are received via IGMP reports. It is decremented when:

- Group memberships time out
- Group leaves are received via leave messages or reports

Also, the port's group counter is cleared when:

- The port goes down
- You run the command **clear ip igmp group \***
- The port is removed from a VLAN

You can see the current value of the group counter by using either of the commands:

```
awplus# show ip igmp snooping statistics interface <port-list>
```

```
awplus# show ip igmp interface <port>
```

**Example** To limit clients to 10 groups on port 1.0.1, which is in vlan1, use the commands:

```
awplus# configure terminal
awplus(config)# interface port1.0.1
awplus(config-if)# ip igmp maximum-groups 10
awplus(config-if)# exit
awplus(config)# interface vlan1
awplus(config-if)# ip igmp snooping fast-leave
```

**Related commands**

- clear ip igmp group
- ip igmp snooping fast-leave
- show ip igmp interface
- show ip igmp snooping statistics

# ip igmp querier-timeout

**Overview** Use this command to configure the timeout period before the device takes over as the querier for the interface after the previous querier has stopped querying.

Use the **no** variant of this command to restore the default.

**Syntax** `ip igmp querier-timeout <timeout>`  
`no ip igmp querier-timeout`

Parameter	Description
<code>&lt;timeout&gt;</code>	IGMP querier timeout interval value in seconds, in the range 1-65535.

**Default** The default timeout interval is 255 seconds.

**Mode** Interface Configuration for a VLAN interface.

**Usage notes** This command applies to VLAN interfaces configured for IGMP.  
The timeout value should not be less than the current active querier's general query interval.

**Example** To configure the device to wait 130 seconds from the time it received the last query before it takes over as the querier for vlan2, use the commands:

```
awplus# configure terminal
awplus(config)# interface vlan2
awplus(config-if)# ip igmp querier-timeout 130
```

**Related commands** `ip igmp query-interval`  
`show ip igmp interface`  
`show running-config`

# ip igmp query-holdtime

**Overview** This command sets the time that an IGMP Querier waits after receiving a query solicitation before it sends an IGMP Query. IGMP General Query messages will not be sent during the hold time interval.

Use the **no** variant of this command to return to the default query hold time period.

**Syntax** `ip igmp query-holdtime <interval>`  
`no ip igmp query-holdtime`

Parameter	Description
<interval>	Query interval value in milliseconds, in the range <100-5000>.

**Default** By default the delay before sending IGMP General Query messages is 500 milliseconds.

**Mode** Interface Configuration for a VLAN interface.

**Usage notes** Use this command to configure a value for the IGMP query hold time in the current network. IGMP Queries can be generated after receiving Query Solicitation (QS) packets and there is a possibility of a DoS (Denial of Service) attack if a stream of Query Solicitation (QS) packets are sent to the IGMP Querier, eliciting a rapid stream of IGMP Queries. This command applies to interfaces on which the device is acting as an IGMP Querier.

Use the `ip igmp query-interval` command when a delay for IGMP general query messages is required and IGMP general query messages are required. The **ip igmp query-holdtime** command stops IGMP query messages during the configured holdtime interval, so the rate of IGMP Queries that can be sent out of an interface can be restricted.

See the [IGMP Feature Overview and Configuration Guide](#) for introductory information about the Query Solicitation feature.

**Examples** To set the IGMP query holdtime to 900 ms for vlan20, use the following commands:

```
awplus# configure terminal
awplus(config)# interface vlan20
awplus(config-if)# ip igmp query-holdtime 900
```

To reset the IGMP query holdtime to the default (500 ms) for vlan10, use the following commands:

```
awplus# configure terminal
awplus(config)# interface vlan10
awplus(config-if)# no ip igmp query-holdtime
```

**Related commands**

- ip igmp query-interval
- ip igmp snooping tcn query solicit
- show ip igmp interface
- show running-config

# ip igmp query-interval

**Overview** Use this command to configure the period for sending IGMP General Query messages.

The IGMP query interval specifies the time between IGMP General Query messages being sent.

Use the **no** variant of this command to return to the default query interval period.

**NOTE:** The IGMP query interval must be greater than IGMP query maximum response time.

**Syntax** `ip igmp query-interval <interval>`  
`no ip igmp query-interval`

Parameter	Description
<interval>	Query interval value in seconds, in the range <2-18000>.

**Default** The default IGMP query interval is 125 seconds.

**Mode** Interface Configuration for a VLAN interface.

**Usage notes** This command applies to interfaces configured for IGMP. Note that the IGMP query interval is automatically set to a greater value than the IGMP query max response time.

For example, if you set the IGMP query max response time to 2 seconds using the [ip igmp query-max-response-time](#) command, and the IGMP query interval is currently less than 3 seconds, then the IGMP query interval period will be automatically reconfigured to be 3 seconds, so it is greater than the IGMP query maximum response time.

Use the **ip igmp query-interval** command when a non-default interval for IGMP General Query messages is required.

The [ip igmp query-holdtime](#) command can occasionally delay the sending of IGMP Queries.

**Examples** To set the period between IGMP host-query messages to 3 minutes (180 seconds) for vlan20, use the following commands:

```
awplus# configure terminal
awplus(config)# interface vlan20
awplus(config-if)# ip igmp query-interval 180
```

To reset the period between sending IGMP host-query messages to the default (125 seconds) for vlan10, use the following commands:

```
awplus# configure terminal
awplus(config)# interface vlan10
awplus(config-if)# no ip igmp query-interval
```

**Related  
commands**

```
ip igmp query-holdtime
ip igmp query-max-response-time
ip igmp startup-query-interval
show ip igmp interface
show running-config
```



# ip igmp query-max-response-time

**Overview** Use this command to configure the maximum response time advertised in IGMP Queries.

Use the **no** variant of this command to restore the default.

**NOTE:** *The IGMP query maximum response time must be less than the IGMP query interval.*

**Syntax** `ip igmp query-max-response-time <response-time>`  
`no ip igmp query-max-response-time`

Parameter	Description
<code>&lt;response-time&gt;</code>	Response time value in seconds, in the range 1-3180.

**Default** The default IGMP query maximum response time is 10 seconds.

**Mode** Interface Configuration for a VLAN interface.

**Usage notes** This command applies to interfaces configured for IGMP.

Note that the IGMP query interval is automatically set to a greater value than the IGMP query maximum response time.

For example, if you set the IGMP query interval to 3 seconds using the `ip igmp query-interval` command, and the current IGMP query interval is less than 3 seconds, then the IGMP query maximum response time will be automatically reconfigured to be 2 seconds, so it is less than the IGMP query interval time.

To get the network to converge faster, use the **ip igmp query-max-response-time** command and set a low response time value, such as one or two seconds, so that the clients will respond immediately with a report as a response to the IGMP Queries.

**Examples** To set a maximum response time of 8 seconds for vlan20, use the following commands:

```
awplus# configure terminal
awplus(config)# interface vlan20
awplus(config-if)# ip igmp query-max-response-time 8
```

To reset the default maximum response time to the default (10 seconds) for vlan10, use the following commands:

```
awplus# configure terminal
awplus(config)# interface vlan10
awplus(config-if)# no ip igmp query-max-response-time
```

**Related commands** ip igmp query-interval  
show ip igmp interface  
show running-config

## ip igmp ra-option

**Overview** Use this command to enable strict Router Alert (RA) option validation. With strict RA option enabled, IGMP packets without RA options are ignored.

Use the **no** variant of this command to disable strict RA option validation.

**Syntax** `ip igmp ra-option`  
`no ip igmp ra-option`

**Default** The default state of RA validation is unset.

**Mode** Interface Configuration for a VLAN interface.

**Usage notes** This command applies to interfaces configured for IGMP and IGMP Snooping.

**Examples** To enable strict Router Alert (RA) option validation on vlan20, use the following commands:

```
awplus# configure terminal
awplus(config)# interface vlan20
awplus(config-if)# ip igmp ra-option
```

# ip igmp robustness-variable

**Overview** Use this command to change the robustness variable value on an interface.  
Use the **no** variant of this command to return to the default on an interface.

**Syntax** `ip igmp robustness-variable <1-7>`  
`no ip igmp robustness-variable`

Parameter	Description
<1-7>	The robustness variable value.

**Default** The default robustness variable value is 2.

**Mode** Interface Configuration for a VLAN interface.

**Usage notes** This command applies to interfaces configured for IGMP and IGMP Snooping.

**Examples** To set the robustness variable to 3 on vlan20, use the following commands:

```
awplus# configure terminal
awplus(config)# interface vlan20
awplus(config-if)# ip igmp robustness-variable 3
```

**Related commands** [show ip igmp interface](#)  
[show running-config](#)

# ip igmp snooping

**Overview** Use this command to enable IGMP Snooping. When this command is used in the Global Configuration mode, IGMP Snooping is enabled at the device level. When this command is used in Interface Configuration mode, IGMP Snooping is enabled for the specified VLANs.

Use the **no** variant of this command to either globally disable IGMP Snooping, or disable IGMP Snooping on a specified interface.

**NOTE:** *IGMP snooping cannot be disabled on an interface if IGMP snooping has already been disabled globally. IGMP snooping can be disabled on both an interface and globally if disabled on the interface first and then disabled globally.*

**Syntax** ip igmp snooping  
no ip igmp snooping

**Default** By default, IGMP Snooping is enabled both globally and on all VLANs.

**Mode** Global Configuration and Interface Configuration for a VLAN interface.

**Usage notes** For IGMP snooping to operate on particular VLAN interfaces, it must be enabled both globally by using this command in Global Configuration mode, and on individual VLAN interfaces by using this command in Interface Configuration mode (both are enabled by default.)

Both IGMP snooping and MLD snooping must be enabled globally on the device for IGMP snooping to operate. MLD snooping is also enabled by default. To enable it if it has been disabled, use the [ipv6 mld snooping](#) command in Global Configuration mode.

**Examples** To enable IGMP Snooping on vlan2, use the commands:

```
awplus# configure terminal
awplus(config)# ip igmp snooping
awplus(config)# interface vlan2
awplus(config-if)# ip igmp snooping
```

**Related commands** [ipv6 mld snooping](#)  
[show ip igmp interface](#)  
[show running-config](#)

# ip igmp snooping fast-leave

**Overview** Use this command to enable IGMP Snooping fast-leave processing. Fast-leave processing is analogous to immediate-leave processing. The IGMP group-membership entry is removed as soon as an IGMP leave group message is received, without sending out a group-specific query.

Use the **no** variant of this command to disable fast-leave processing.

**Syntax** `ip igmp snooping fast-leave`  
`no ip igmp snooping fast-leave`

**Default** IGMP Snooping fast-leave processing is disabled.

**Mode** Interface Configuration for a VLAN interface.

**Usage notes** This IGMP Snooping command can only be configured on VLAN interfaces.

**Example** To enable fast-leave processing on vlan2, use the commands:

```
awplus# configure terminal
awplus(config)# interface vlan2
awplus(config-if)# ip igmp snooping fast-leave
```

**Related commands** [show ip igmp interface](#)  
[show running-config](#)

# ip igmp snooping mrouter

**Overview** Use this command to statically configure the specified port as a multicast router port for IGMP Snooping for an interface. This command applies to interfaces configured for IGMP Snooping.

Use the **no** variant of this command to remove the static configuration of the port as a multicast router port.

**Syntax** `ip igmp snooping mrouter interface <port>`  
`no ip igmp snooping mrouter interface <port>`

Parameter	Description
<code>&lt;port&gt;</code>	The port may be a device port (e.g. port1.0.2), a static channel group (e.g. sa3), or a dynamic (LACP) channel group (e.g. po4).

**Mode** Interface Configuration for a VLAN interface.

**Example** To configure port1.0.2 statically as a multicast router interface for vlan2, use the commands:

```
awplus# configure terminal
awplus(config)# interface vlan2
awplus(config-if)# ip igmp snooping mrouter interface port1.0.2
```

**Related commands** [show ip igmp snooping mrouter](#)

# ip igmp snooping querier

**Overview** Use this command to enable IGMP querier operation when no multicast routing protocol is configured. When enabled, the IGMP Snooping querier sends out periodic IGMP queries for all interfaces. This command applies to interfaces configured for IGMP Snooping.

Use the **no** variant of this command to disable IGMP querier configuration.

**Syntax** `ip igmp snooping querier`  
`no ip igmp snooping querier`

**Mode** Interface Configuration for a VLAN interface.

**Usage notes** The IGMP Snooping querier uses the 0 . 0 . 0 . 0 Source IP address because it only masquerades as a proxy IGMP querier for faster network convergence.

It does not start, or automatically cease, the IGMP Querier operation if it detects query message(s) from a multicast router.

If an IP address is assigned to a VLAN, which has IGMP querier enabled on it, then the IGMP Snooping querier uses the VLAN's IP address as the Source IP Address in IGMP queries.

The IGMP Snooping Querier will not stop sending IGMP Queries if there is another IGMP Snooping Querier in the network with a lower Source IP Address.

**NOTE:** Do not enable the IGMP Snooping Querier feature on a Layer 2 device when there is an operational IGMP Querier in the network.

**Example** To configure vlan2 as a Snooping querier, use the commands:

```
awplus# configure terminal
awplus(config)# interface vlan2
awplus(config-if)# ip igmp snooping querier
```

**Related commands** [show ip igmp interface](#)  
[show running-config](#)



# ip igmp snooping report-suppression

**Overview** Use this command to enable report suppression for IGMP versions 1 and 2. This command applies to interfaces configured for IGMP Snooping.

Report suppression stops reports being sent to an upstream multicast router port when there are already downstream ports for this group on this interface.

Use the **no** variant of this command to disable report suppression.

**Syntax** `ip igmp snooping report-suppression`  
`no ip igmp snooping report-suppression`

**Default** Report suppression does not apply to IGMPv3, and is turned on by default for IGMPv1 and IGMPv2 reports.

**Mode** Interface Configuration for a VLAN interface.

**Example** To enable report suppression for IGMPv2 reports for vlan2, use the commands:

```
awplus# configure terminal
awplus(config)# interface vlan2
awplus(config-if)# ip igmp version 2
awplus(config-if)# ip igmp snooping report-suppression
```

**Related commands** [show ip igmp interface](#)  
[show running-config](#)

# ip igmp snooping routermode

**Overview** Use this command to set the destination IP addresses as router multicast addresses.

Use the **no** variant of this command to set it to the default. You can also remove a specified IP address from a custom list of multicast addresses.

**Syntax** `ip igmp snooping routermode`  
`{all|default|ip|multicastrouter|address <ip-address>}`  
`no ip igmp snooping routermode [address <ip-address>]`

Parameter	Description
all	All reserved multicast addresses (224.0.0.x). Packets from all possible addresses in range 224.0.0.x are treated as coming from routers.
default	Default set of reserved multicast addresses. Packets from 224.0.0.1, 224.0.0.2, 224.0.0.4, 224.0.0.5, 224.0.0.6, 224.0.0.9, 224.0.0.13, 224.0.0.15 and 224.0.0.24 are treated as coming from routers.
ip	Custom reserved multicast addresses. Packets from custom IP address in the 224.0.0.x range are treated as coming from routers.
multicastrouter	Packets from DVMRP (224.0.0.4) and PIM (224.0.0.13) multicast addresses are treated as coming from routers.
address <ip-address>	Packets from the specified multicast address are treated as coming from routers. The address must be in the 224.0.0.x range.

**Default** The default routermode is **default** (not **all**) and shows the following reserved multicast addresses:

```
Router mode.....Def
Reserved multicast address
224.0.0.1
224.0.0.2
224.0.0.4
224.0.0.5
224.0.0.6
224.0.0.9
224.0.0.13
224.0.0.15
224.0.0.24
```

**Mode** Global Configuration

**Examples** To set **ip igmp snooping routermode** for all default reserved addresses enter:

```
awplus(config)# ip igmp snooping routermode default
```

To remove the multicast address 224.0.0.5 from the custom list of multicast addresses enter:

```
awplus(config)# no ip igmp snooping routermode address  
224.0.0.5
```

**Related commands** [ip igmp trusted](#)  
[show ip igmp snooping routermode](#)

**Command changes** Version 5.4.7-1.1: VRF-lite support added SBx8100.  
Version 5.4.8-1.1: VRF-lite support added x930, SBx908 GEN2.

# ip igmp snooping source-timeout

**Overview** Use this command to set the global IGMP Snooping source time-out value (in seconds) on the switch.

Use the **no** variant of this command to set the source time-out value to be the same as the group membership timeout.

**Syntax** `ip igmp snooping source-timeout <timeout>`  
`no ip igmp snooping source-timeout <timeout>`

Parameter	Description
<code>&lt;timeout&gt;</code>	Time-out value in seconds <code>&lt;0-86400&gt;</code>

**Default** Global IGMP Snooping source-timeout is disabled by default, and unregistered multicast will be timed-out like normal entries.

Interface IGMP Snooping source timeout is disabled by default, and unregistered multicast will be timed-out like normal entries.

**Mode** Interface/Global Configuration

**Usage notes** The timeout determines how long unregistered multicast entries will be kept for. If the value '0' is specified, then effectively all unregistered multicast entries will never be timed out, and can only be cleared by using the command **clear ip igmp group**. The interface settings will always take precedence over the global setting.

**Example** To configure IGMP Snooping source timeout on 'vlan1', use the commands:

```
awplus# configure terminal
awplus(config)# interface vlan1
awplus(config-if)# ip igmp snooping source-timeout 200
```

**Related commands** [show ip igmp snooping source-timeout](#)

# ip igmp snooping tcn query solicit

**Overview** Use this command to enable IGMP (Internet Group Management Protocol) Snooping TCN (Topology Change Notification) Query Solicitation feature. When this command is used in the Global Configuration mode, Query Solicitation is enabled.

Use the **no** variant of this command to disable IGMP Snooping TCN Query Solicitation. When the **no** variant of this command is used in Interface Configuration mode, this overrides the Global Configuration mode setting and Query Solicitation is disabled.

**Syntax**

```
ip igmp snooping tcn query solicit
no ip igmp snooping tcn query solicit
```

**Default** IGMP Snooping TCN Query Solicitation is disabled by default on the device, unless the device is the Master Node in an EPSR ring, or is the Root Bridge in a Spanning Tree.

When the device is the Master Node in an EPSR ring, or the device is the Root Bridge in a Spanning Tree, then IGMP Snooping TCN Query Solicitation is enabled by default and cannot be disabled using the Global Configuration mode command. However, Query Solicitation can be disabled for specified interfaces using the **no** variant of this command from the Interface Configuration mode.

**Mode** Global Configuration, and Interface Configuration for a VLAN interface.

**Usage notes** Once enabled, if the device is not an IGMP Querier, on detecting a topology change, the device generates IGMP Query Solicit messages that are sent to all the ports of the vlan configured for IGMP Snooping on the device.

On a device that is not the Master Node in an EPSR ring or the Root Bridge in a Spanning Tree, Query Solicitation can be disabled using the **no** variant of this command after being enabled.

If the device that detects a topology change is an IGMP Querier then the device will generate an IGMP Query message.

Note that the **no** variant of this command when issued in Global Configuration mode has no effect on a device that is the Master Node in an EPSR ring or on a device that is a Root Bridge in a Spanning Tree. Query Solicitation is not disabled for the device these instances. However, Query Solicitation can be disabled on a per-vlan basis from the Interface Configuration mode.

See the following state table that shows when Query Solicit messages are sent in these instances:

Command issued from Global Configuration	Command issued from Interface Configuration	Device is STP Root Bridge or the EPR Master Node	IGMP Query Solicit message sent on VLAN
No	Yes	Yes	Yes
Yes	No	Yes	No
Yes	Yes	Yes	Yes

See the [IGMP Feature Overview and Configuration Guide](#) for introductory information about the Query Solicitation feature.

**Examples** To enable Query Solicitation on a device, use the commands:

```
awplus# configure terminal
awplus(config)# ip igmp snooping tcn query solicit
```

To disable Query Solicitation on a device, use the commands:

```
awplus# configure terminal
awplus(config)# no ip igmp snooping tcn query solicit
```

To enable Query Solicitation for vlan2, use the commands:

```
awplus# configure terminal
awplus(config)# interface vlan2
awplus(config-if)# ip igmp snooping tcn query solicit
```

To disable Query Solicitation for vlan2, use the commands:

```
awplus# configure terminal
awplus(config)# interface vlan2
awplus(config-if)# no ip igmp snooping tcn query solicit
```

**Related commands**

- [ip igmp query-holdtime](#)
- [show ip igmp interface](#)
- [show running-config](#)

**Command changes**

- Version 5.4.7-1.1: VRF-lite support added SBx8100.
- Version 5.4.8-1.1: VRF-lite support added x930, SBx908 GEN2.

# ip igmp source-address-check

**Overview** This command enables the checking of the Source Address for an IGMP Report, rejecting any IGMP Reports originating on devices outside of the local subnet.

Use the **no** variant of this command to disable the checking of the Source Address for an IGMP Report, which allows IGMP Reports from devices outside of the local subnet.

**Syntax** `ip igmp source-address-check`  
`no ip igmp source-address-check`

**Default** Source address checking for IGMP Reports is enabled by default.

**Mode** Interface Configuration for a VLAN interface.

**Usage notes** This is a security feature, and should be enabled unless IGMP Reports from outside the local subnet are expected, for example, if Multicast VLAN Registration is active in the network.

The no variant of this command is required to disable the IGMP Report source address checking feature in networks that use Multicast VLAN Registration to allow IGMP Reports from devices outside of the local subnet.

**Examples** To deny IGMP Reports from outside the current subnet for vlan20, use the following commands:

```
awplus# configure terminal
awplus(config)# interface vlan20
awplus(config-if)# ip igmp source-address-check
```

To allow IGMP Reports from outside the current subnet for vlan10, use the following commands:

```
awplus# configure terminal
awplus(config)# interface vlan10
awplus(config-if)# no ip igmp source-address-check
```

**Validation Commands** `show ip igmp interface`  
`show running-config`

# ip igmp static-group

**Overview** Use this command to statically configure multicast group membership entries on a VLAN interface, or to statically forward a multicast channel out a particular port or port range.

To statically add only a group membership, do not specify any parameters.

To statically add a (\*,g) entry to forward a channel out of a port, specify only the multicast group address and the switch port range.

To statically add an (s,g) entry to forward a channel out of a port, specify the multicast group address, the source IP address, and the switch port range.

Use the **no** variant of this command to delete static group membership entries.

**Syntax** `ip igmp static-group <ip-address> [source {<ip-source-addr>}] [interface <port>]`  
`no ip igmp static-group <ip-address> [source {<ip-source-addr>}] [interface <port>]`

Parameter	Description
<code>&lt;ip-address&gt;</code>	Standard IP Multicast group address, entered in the form A.B.C.D, to be configured as a static group member.
<code>source</code>	Optional.
<code>&lt;ip-source-addr&gt;</code>	Standard IP source address, entered in the form A.B.C.D, to be configured as a static source from where multicast packets originate.
<code>interface</code>	Use this parameter to specify a specific switch port or switch port range to statically forward the multicast group out of. If not used, static configuration is applied on all ports in the VLAN.
<code>&lt;port&gt;</code>	The port or port range to statically forward the group out of. The port may be a switch port (e.g. port1.0.4), a static channel group (e.g. sa2), or a dynamic (LACP) channel group (e.g. po2).

**Mode** Interface Configuration for a VLAN interface.

**Usage notes** This command applies to IGMP operation, or to IGMP Snooping on a VLAN interface.



**Example** The following example show how to statically add group and source records for IGMP on vlan3:

```
awplus# configure terminal
awplus(config)# interface vlan3
awplus(config-if)# ip igmp
awplus(config-if)# ip igmp static-group 226.1.2.4 source
10.2.3.4
```

# ip igmp startup-query-count

**Overview** Use this command to configure the IGMP startup query count for an interface. The IGMP startup query count is the number of IGMP General Query messages sent by a querier at startup. The default IGMP startup query count is 2.

**Syntax** `ip igmp startup-query-count <startup-query-count>`  
`no ip igmp startup-query-count`

Parameter	Description
<code>&lt;startup-query-count&gt;</code>	Specify the IGMP startup query count, in the range 2-10.

**Default** The default IGMP startup query count is 2.

**Mode** Interface Configuration for a VLAN interface.

**Example** To set the IGMP startup query count to 4 on vlan2, use the commands:

```
awplus# configure terminal
awplus(config)# interface vlan2
awplus(config-if)# ip igmp startup-query-count 4
```

**Related commands** [ip igmp last-member-query-count](#)  
[ip igmp startup-query-interval](#)

# ip igmp startup-query-interval

**Overview** Use this command to configure the IGMP startup query interval for an interface. The IGMP startup query interval is the amount of time in seconds between successive IGMP General Query messages sent by a querier during startup. The default IGMP startup query interval is one quarter of the IGMP query interval value.

**Syntax** `ip igmp startup-query-interval <startup-query-interval>`  
`no ip igmp startup-query-interval`

Parameter	Description
<code>&lt;startup-query-interval&gt;</code>	Specify the IGMP startup query interval, in the range of 2-1800 seconds. The value must be one quarter of the IGMP query interval value.

**Default** The default IGMP startup query interval is one quarter of the IGMP query interval value.

**NOTE:** *The IGMP startup query interval must be one quarter of the IGMP query interval.*

**Mode** Interface Configuration for a VLAN interface.

**Example** To set the IGMP startup query interval to 15 seconds for vlan2, which is one quarter of the IGMP query interval of 60 seconds, use the commands:

```
awplus# configure terminal
awplus(config)# interface vlan2
awplus(config-if)# ip igmp query-interval 60
awplus(config-if)# ip igmp startup-query-interval 15
```

**Related commands** [ip igmp last-member-query-interval](#)  
[ip igmp query-interval](#)  
[ip igmp startup-query-count](#)

# ip igmp trusted

**Overview** Use this command to allow IGMP to process packets received on certain trusted ports only.

Use the **no** variant of this command to stop IGMP from processing specified packets if the packets are received on the specified ports or aggregator.

**Syntax** `ip igmp trusted {all|query|report|routermode}`  
`no ip igmp trusted {all|query|report|routermode}`

Parameter	Description
all	Specifies whether or not the interface is allowed to receive all IGMP and other routermode packets
query	Specifies whether or not the interface is allowed to receive IGMP queries
report	Specifies whether or not the interface is allowed to receive IGMP membership reports
routermode	Specifies whether or not the interface is allowed to receive routermode packets

**Default** By default, all ports and aggregators are trusted interfaces, so IGMP is allowed to process all IGMP query, report, and router mode packets arriving on all interfaces.

**Mode** Interface mode for one or more switch ports or aggregators

**Usage** Because all ports are trusted by default, use this command in its **no** variant to stop IGMP processing packets on ports you do not trust.

For example, you can use this command to make sure that only ports attached to approved IGMP routers are treated as router ports.

**Example** To stop ports port1.0.3-port1.0.6 from being treated as router ports by IGMP, use the commands:

```
awplus(config)# interface port1.0.3-port1.0.6  
awplus(config-if)# no ip igmp trusted routermode
```

# ip igmp version

**Overview** Use this command to set the current IGMP version (IGMP version 1, 2 or 3) on an interface.

Use the **no** variant of this command to return to the default version.

**Syntax** `ip igmp version <1-3>`  
`no ip igmp version`

Parameter	Description
<code>version &lt;1-3&gt;</code>	IGMP protocol version number

**Default** The default IGMP version is 3.

**Mode** Interface Configuration for a VLAN interface.

**Example** To set the IGMP version to 2 for vlan2, use the commands:

```
awplus# configure terminal
awplus(config)# interface vlan2
awplus(config-if)# ip igmp version 2
```

**Related commands** [show ip igmp interface](#)

# show debugging igmp

**Overview** Use this command to see what debugging is turned on for IGMP.  
For information on filtering and saving command output, see the [“Getting Started with AlliedWare Plus” Feature Overview and Configuration Guide](#).

**Syntax** `show debugging igmp`

**Mode** User Exec and Privileged Exec

**Example** To display the IGMP debugging options set, enter the command:

```
awplus# show debugging igmp
```

**Output** Figure 24-1: Example output from the **show debugging igmp** command

```
IGMP Debugging status:
IGMP Decoder debugging is on
IGMP Encoder debugging is on
IGMP Events debugging is on
IGMP FSM debugging is on
IGMP Tree-Info-Base (TIB) debugging is on
```

**Related commands** [debug igmp](#)

**Command changes** Version 5.4.7-1.1: VRF-lite support added SBx8100.  
Version 5.4.8-1.1: VRF-lite support added x930, SBx908 GEN2.

# show ip igmp groups

**Overview** Use this command to display the multicast groups with receivers directly connected to the router, and learned through IGMP.

For information on filtering and saving command output, see the [“Getting Started with AlliedWare Plus” Feature Overview and Configuration Guide](#).

**Syntax** `show ip igmp groups [<ip-address>|<interface> detail | brief]`

Parameter	Description
<ip-address>	Address of the multicast group, entered in the form A.B.C.D.
<interface>	Interface name for which to display local information.
brief	Brief display of all interfaces

**Mode** User Exec and Privileged Exec

**Example** The following command displays local-membership information for all ports in all interfaces:

```
awplus# show ip igmp groups
```

**Output** Figure 24-2: Example output from **show ip igmp groups**

IGMP Connected Group Membership				
Group Address	Interface	Uptime	Expires	Last Reporter
224.0.1.1	port1.0.1	00:00:09	00:04:17	10.10.0.82
224.0.1.24	port1.0.2	00:00:06	00:04:14	10.10.0.84
...				

Table 24-1: Parameters in the output of **show ip igmp groups**

Parameter	Description
Group Address	Address of the multicast group.
Interface	Port through which the group is reachable.
Uptime	The time in weeks, days, hours, minutes, and seconds that this multicast group has been known to the device.
Expires	Time (in hours, minutes, and seconds) until the entry expires.
Last Reporter	Last host to report being a member of the multicast group.

- Command changes**
- Version 5.4.7-1.1: VRF-lite support added SBx8100.
  - Version 5.4.8-1.1: VRF-lite support added x930, SBx908 GEN2.
  - Version 5.4.8-2.3: **brief** parameter added.



# show ip igmp interface

**Overview** Use this command to display the state of IGMP Snooping for a specified VLAN, or all VLANs. IGMP is shown as Active or Disabled in the show output. You can also display the number of groups a switch port belongs to.

For information on filtering and saving command output, see the [“Getting Started with AlliedWare Plus” Feature Overview and Configuration Guide](#).

**Syntax** `show ip igmp interface [<interface>]`

Parameter	Description
<interface>	The name of the interface. If you specify a switch port number, the output displays the number of groups the port belongs to, and the port’s group membership limit, if a limit has been set (with the command <code>ip igmp maximum-groups</code> ).

**Mode** User Exec and Privileged Exec

**Output** The following output shows IGMP interface status for vlan2 with IGMP Snooping enabled:

```
awplus#show ip igmp interface vlan2
Interface vlan2 (Index 202)
  IGMP Disabled, Inactive, Version 3 (default)
  IGMP interface has 0 group-record states
  IGMP activity: 0 joins, 0 leaves
  IGMP robustness variable is 2
  IGMP last member query count is 2
  IGMP query interval is 125 seconds
  IGMP query holdtime is 500 milliseconds
  IGMP querier timeout is 255 seconds
  IGMP max query response time is 10 seconds
  Last member query response interval is 1000 milliseconds
  Group Membership interval is 260 seconds
  Strict IGMPv3 ToS checking is disabled on this interface
  Source Address checking is enabled
  IGMP Snooping is globally enabled
  IGMP Snooping query solicitation is globally disabled
  Num. query-solicit packets: 57 sent, 0 recvd
  IGMP Snooping is enabled on this interface
  IGMP Snooping fast-leave is not enabled
  IGMP Snooping querier is not enabled
  IGMP Snooping report suppression is enabled
```

The following output shows IGMP interface status for vlan2 with IGMP Snooping disabled:

```
awplus#show ip igmp interface vlan2
Interface vlan2 (Index 202)
  IGMP Disabled, Inactive, Version 3 (default)
  IGMP interface has 0 group-record states
  IGMP activity: 0 joins, 0 leaves
  IGMP robustness variable is 2
  IGMP last member query count is 2
  IGMP query interval is 125 seconds
  IGMP query holdtime is 500 milliseconds
  IGMP querier timeout is 255 seconds
  IGMP max query response time is 10 seconds
  Last member query response interval is 1000 milliseconds
  Group Membership interval is 260 seconds
  Strict IGMPv3 ToS checking is disabled on this interface
  Source Address checking is enabled
  IGMP Snooping is globally enabled
  IGMP Snooping query solicitation is globally disabled
  Num. query-solicit packets: 57 sent, 0 recvd
  IGMP Snooping is not enabled on this interface
  IGMP Snooping fast-leave is not enabled
  IGMP Snooping querier is not enabled
  IGMP Snooping report suppression is enabled
```

The following output displays membership information for port1.0.1:

```
awplus#show ip igmp interface port1.0.1
IGMP information for port1.0.1
  Maximum groups limit set: 10
  Number of groups port belongs to: 0
```

**Command  
changes**

Version 5.4.7-1.1: VRF-lite support added SBx8100.

Version 5.4.8-1.1: VRF-lite support added x930, SBx908 GEN2.

# show ip igmp snooping mrouter

**Overview** Use this command to display the multicast router ports, both static and dynamic, in a VLAN.

For information on filtering and saving command output, see the [“Getting Started with AlliedWare Plus” Feature Overview and Configuration Guide](#).

**Syntax** `show ip igmp snooping mrouter [interface <interface>]`

Parameter	Description
interface	A specific interface.
<interface>	The name of the VLAN interface.

**Mode** User Exec and Privileged Exec

**Example** To show all multicast router interfaces, use the command:

```
awplus# show ip igmp snooping mrouter
```

To show the multicast router interfaces in `vlan1`, use the command:

```
awplus# show ip igmp snooping mrouter interface vlan1
```

**Output** Figure 24-3: Example output from **show ip igmp snooping mrouter**

VLAN	Interface	Static/Dynamic
1	port1.0.1	Statically configured
200	port1.0.2	Statically configured

Figure 24-4: Example output from **show ip igmp snooping mrouter interface vlan1**

VLAN	Interface	Static/Dynamic
1	port1.0.1	Statically configured

**Related commands** [ip igmp snooping mrouter](#)

**Command changes** Version 5.4.7-1.1: VRF-lite support added SBx8100.

Version 5.4.8-1.1: VRF-lite support added x930, SBx908 GEN2.

# show ip igmp snooping routermode

**Overview** Use this command to display the current router mode and the list of IP addresses set as router multicast addresses from the `ip igmp snooping routermode` command.

For information on filtering and saving command output, see the [“Getting Started with AlliedWare Plus” Feature Overview and Configuration Guide](#).

**Syntax** `show ip igmp snooping routermode`

**Mode** User Exec and Privileged Exec

**Example** To show the router mode and the list of router multicast addresses, use the command:

```
awplus# show ip igmp snooping routermode
```

**Output** Figure 24-5: Example output from `show ip igmp snooping routermode`

```
awplus#show ip igmp snooping routermode
Router mode.....Def
Reserved multicast address

      224.0.0.1
      224.0.0.2
      224.0.0.4
      224.0.0.5
      224.0.0.6
      224.0.0.9
      224.0.0.13
      224.0.0.15
      224.0.0.24
```

**Related commands** `ip igmp snooping routermode`

**Command changes** Version 5.4.7-1.1: VRF-lite support added SBx8100.

Version 5.4.8-1.1: VRF-lite support added x930, SBx908 GEN2.

# show ip igmp snooping source-timeout

**Overview** Use this command to display the configured IGMP snooping source timeouts for a specified VLAN or VLAN range.

**Syntax** `show ip igmp snooping source-timeout [interface|  
<interface-range>]`

Parameter	Description
<interface-range>	The name of the VLAN interface or VLAN range

**Mode** Privileged Exec

**Example** To display the configured IGMP snooping source timeouts for all VLANs, use the command:

```
awplus# show ip igmp snooping source-timeout
```

**Output** Figure 24-6: Example output from **show ip igmp snooping source-timeout**

```
awplus#show ip igmp snooping source-timeout
Global IGMP snooping source-timeout is enabled (60 secs)

vlan1          enabled (300 secs)
vlan2          inherits global setting
vlan1000       inherits global settingawplus#show ip igmp
snooping source-timeout int vlan1
Global IGMP snooping source-timeout is enabled (60 secs)vlan1
enabled (300 secs)
```

**Related commands** [ip igmp snooping source-timeout](#)

**Command changes** Version 5.4.7-1.1: VRF-lite support added SBx8100.

Version 5.4.8-1.1: VRF-lite support added x930, SBx908 GEN2.

# show ip igmp snooping statistics

**Overview** Use this command to display IGMP Snooping statistics data.

For information on filtering and saving command output, see the [“Getting Started with AlliedWare Plus” Feature Overview and Configuration Guide](#).

**Syntax** `show ip igmp snooping statistics interface <interface-range> [group [<ip-address>]]`

Parameter	Description
<ip-address>	Optionally specify the address of the multicast group, entered in the form A.B.C.D.
<interface>	Specify the name of the interface or interface range. If you specify a port number, the output displays the number of groups the port belongs to, and the port’s group membership limit, if a limit has been set (with the command <code>ip igmp maximum-groups</code> )

**Mode** Privileged Exec

**Example** To display IGMP statistical information for **vlan1** and **vlan2**, use the command:

```
awplus# show ip igmp snooping statistics interface vlan1-vlan2
```

**Output** Figure 24-7: Example output from the **show ip igmp snooping statistics** command for VLANs

```
awplus#show ip igmp interface vlan1-vlan2
IGMP Snooping statistics for vlan1
Interface:      port1.0.1
Group:         224.1.1.1
Uptime:        00:00:09
Group mode:    Exclude (Expires: 00:04:10)
Last reporter: 10.4.4.5
Source list is empty
IGMP Snooping statistics for vlan2
Interface:      port1.0.2
Group:         224.1.1.2
Uptime:        00:00:19
Group mode:    Exclude (Expires: 00:05:10)
Last reporter: 10.4.4.6
Source list is empty
```

Figure 24-8: Example output from the **show ip igmp snooping statistics** command for a switch port

```
awplus#show ip igmp interface port1.0.1
IGMP information for port1.0.1
  Maximum groups limit set: 10
  Number of groups port belongs to: 0
```

**Command  
changes**

Version 5.4.7-1.1: VRF-lite support added SBx8100.

Version 5.4.8-1.1: VRF-lite support added x930, SBx908 GEN2.

# undebbug igmp

**Overview** This command applies the functionality of the no `debug igmp` command.



# 25

# MLD Snooping Commands

## Introduction

**Overview** This chapter provides an alphabetical reference of configuration, clear, and show commands related to MLD Snooping.

- Command List**
- “clear ipv6 mld” on page 858
  - “clear ipv6 mld group” on page 859
  - “clear ipv6 mld interface” on page 860
  - “debug mld” on page 861
  - “ipv6 mld immediate-leave” on page 862
  - “ipv6 mld limit” on page 863
  - “ipv6 mld snooping” on page 865
  - “ipv6 mld snooping fast-leave” on page 867
  - “ipv6 mld snooping mrouter” on page 868
  - “ipv6 mld snooping querier” on page 870
  - “ipv6 mld snooping report-suppression” on page 871
  - “ipv6 mld static-group” on page 873
  - “show debugging mld” on page 875
  - “show ipv6 mld groups” on page 876
  - “show ipv6 mld interface” on page 877
  - “show ipv6 mld snooping mrouter” on page 878
  - “show ipv6 mld snooping statistics” on page 879

# clear ipv6 mld

**Overview** Use this command to clear all MLD local memberships on all interfaces.

**Syntax** `clear ipv6 mld`

**Mode** Privileged Exec

**Example** `awplus# clear ipv6 mld`

**Related commands** [clear ipv6 mld group](#)  
[clear ipv6 mld interface](#)

# clear ipv6 mld group

**Overview** Use this command to clear MLD specific local-membership(s) on all interfaces, for a particular group.

**Syntax** `clear ipv6 mld group {*|<ipv6-address>}`

Parameter	Description
*	Clears all groups on all interfaces. This is an alias to the <a href="#">clear ipv6 mld</a> command.
<ipv6-address>	Specify the group address for which MLD local-memberships are to be cleared from all interfaces. Specify the IPv6 multicast group address in the format in the format X:X::X:X.

**Mode** Privileged Exec

**Example** `awplus# clear ipv6 mld group *`

**Related commands** [clear ipv6 mld](#)  
[clear ipv6 mld interface](#)

# clear ipv6 mld interface

**Overview** Use this command to clear MLD interface entries.

**Syntax** `clear ipv6 mld interface <interface>`

Parameter	Description
<code>&lt;interface&gt;</code>	Specifies name of the interface; all groups learned from this interface are deleted.

**Mode** Privileged Exec

**Example** `awplus# clear ipv6 mld interface vlan2`

**Related commands** [clear ipv6 mld](#)  
[clear ipv6 mld group](#)

# debug mld

**Overview** Use this command to enable all MLD debugging modes, or a specific MLD debugging mode.

Use the **no** variant of this command to disable all MLD debugging modes, or a specific MLD debugging mode.

**Syntax** debug mld {all|decode|encode|events|fsm|tib}  
no debug mld {all|decode|encode|events|fsm|tib}

Parameter	Description
all	Debug all MLD.
decode	Debug MLD decoding.
encode	Debug MLD encoding.
events	Debug MLD events.
fsm	Debug MLD Finite State Machine (FSM).
tib	Debug MLD Tree Information Base (TIB).

**Mode** Privileged Exec and Global Configuration

**Examples**

```
awplus# configure terminal
awplus(config)# debug mld all
awplus# configure terminal
awplus(config)# debug mld decode
awplus# configure terminal
awplus(config)# debug mld encode
awplus# configure terminal
awplus(config)# debug mld events
```

**Related commands** [show debugging mld](#)

# ipv6 mld immediate-leave

**Overview** Use this command to minimize the leave latency of MLD memberships.

Use the **no** variant of this command to disable this feature.

**Syntax** `ipv6 mld immediate-leave group-list <IPv6-access-list-name>`  
`no ipv6 mld immediate-leave`

Parameter	Description
<code>&lt;IPv6-access-list-name&gt;</code>	Specify a Standard or an Extended software IPv6 access-list name that defines multicast groups in which the immediate leave feature is enabled. See <a href="#">IPv6 Software Access Control List (ACL) Commands</a> for supported IPv6 ACLs.

**Default** Disabled

**Mode** Interface Configuration for a specified VLAN interface or a range of VLAN interfaces.

**Example** The following example shows how to enable the immediate-leave feature on an interface for a specific range of multicast groups. In this example, the router assumes that the group access-list consists of groups that have only one node membership at a time per interface:

```
awplus# configure terminal
awplus(config)# ipv6 forwarding
awplus(config)# ipv6 multicast-routing
awplus(config)# interface vlan2
awplus(config-if)# ipv6 enable
awplus(config-if)# ipv6 mld immediate-leave v6grp
awplus(config-if)# exit
```

# ipv6 mld limit

**Overview** Use this command to configure a limit on the maximum number of group memberships that may be learned. The limit may be set for the device as a whole, or for a specific interface.

Once the specified group membership limit is reached, all further local-memberships will be ignored.

Optionally, an exception access-list can be configured to specify the group-address(es) that are exempted from being subject to the limit.

Use the **no** variant of this command to unset the limit and any specified exception access-list.

**Syntax** `ipv6 mld limit <limitvalue> [except <IPv6-access-list-name>]`  
`no ipv6 mld limit`

Parameter	Description
<limitvalue>	<2-512> Maximum number of group membership states.
<IPv6-access-list-name>	Specify a Standard or an Extended software IPv6 access-list name that defines multicast groups, which are exempted from being subject to the configured limit. See <a href="#">IPv6 Software Access Control List (ACL) Commands</a> for supported IPv6 ACLs.

**Default** The default limit, which is reset by the **no** variant of this command, is the same as maximum number of group membership entries that can be learned with the **ipv6 mld limit** command.

The default limit of group membership entries that can be learned is 512 entries.

**Mode** Global Configuration and Interface Configuration for a specified VLAN interface or a range of VLAN interfaces.

**Usage notes** This command applies to interfaces configured for MLD Layer-3 multicast protocols and learned by MLD Snooping.

**Examples** The following example configures an MLD limit of 100 group-memberships across all VLAN interfaces on which MLD is enabled, and excludes groups in the range `ffe:0db8:0001::/64` from this limitation:

```
awplus# configure terminal
awplus(config)# ipv6 forwarding
awplus(config)# ipv6 multicast-routing
awplus(config)# ipv6 access-list standard v6grp permit
ffe:0db8:0001::/64
awplus(config)# ipv6 mld limit 100 except v6grp
```

The following example configures an MLD limit of 100 group-membership states on the VLAN interface `vlan2`:

```
awplus# configure terminal
awplus(config)# ipv6 forwarding
awplus(config)# ipv6 multicast-routing
awplus(config)# interface vlan2
awplus(config-if)# ipv6 enable
awplus(config-if)# ipv6 mld limit 100
```

The following example configures an MLD limit of 100 group-membership states on the VLAN interfaces `vlan2-vlan4`:

```
awplus# configure terminal
awplus(config)# ipv6 forwarding
awplus(config)# ipv6 multicast-routing
awplus(config)# interface vlan2-vlan4
awplus(config-if)# ipv6 enable
awplus(config-if)# ipv6 mld limit 100
```

**Related commands** [ipv6 mld immediate-leave](#)  
[show ipv6 mld groups](#)



# ipv6 mld snooping

**Overview** Use this command to enable MLD Snooping. When this command is issued in the Global Configuration mode, MLD Snooping is enabled globally for the device. When this command is issued in Interface mode for a VLAN then MLD Snooping is enabled for the specified VLAN. Note that MLD Snooping is enabled on the VLAN only if it is enabled globally and on the VLAN.

Use the **no** variant of this command to globally disable MLD Snooping in Global Configuration mode, or for the specified VLAN interface in Interface mode.

**Syntax** `ipv6 mld snooping`  
`no ipv6 mld snooping`

**Default** By default, MLD Snooping is enabled both globally and on all VLANs.

**Mode** Global Configuration and Interface Configuration for a specified VLAN interface or a range of VLAN interfaces.

**Usage notes** For MLD Snooping to operate on particular VLAN interfaces, it must be enabled both globally by using this command in Global Configuration mode, and on individual VLAN interfaces by using this command in Interface Configuration mode (both are enabled by default).

MLD requires memory for storing data structures, as well as the hardware tables to implement hardware routing. As the number of ports, VLANs, static and dynamic groups increases then more memory is consumed. You can track the memory used for MLD with the command:

```
awplus# show memory pools nsm | grep MLD
```

Static and dynamic groups (LACP), ports and VLANs are not limited for MLD. For VLANs, this allows you to configure MLD across more VLANs with fewer ports per VLAN, or fewer VLANs with more ports per VLAN. For LACPs, you can configure MLD across more LACP groups with fewer ports per LACP, or fewer LACP groups with more ports per LACP.

**Examples** To configure MLD Snooping on the VLAN interfaces `vlan2-vlan4`, enter the following commands:

```
awplus# configure terminal
awplus(config)# interface vlan2-vlan4
awplus(config-if)# ipv6 mld snooping
```

To disable MLD Snooping for the VLAN interfaces `vlan2-vlan4`, enter the following commands:

```
awplus# configure terminal
awplus(config)# interface vlan2-vlan4
awplus(config)# no ipv6 mld snooping
```

To configure MLD Snooping globally for the device, enter the following commands:

```
awplus# configure terminal  
awplus(config)# ipv6 mld snooping
```

To disable MLD Snooping globally for the device, enter the following commands:

```
awplus# configure terminal  
awplus(config)# no ipv6 mld snooping
```

# ipv6 mld snooping fast-leave

**Overview** Use this command to enable MLD Snooping fast-leave processing. Fast-leave processing is analogous to immediate-leave processing; the MLD group-membership is removed as soon as an MLD leave group message is received, without sending out a group-specific query.

Use the **no** variant of this command to disable fast-leave processing.

**Syntax** `ipv6 mld snooping fast-leave`  
`no ipv6 mld snooping fast-leave`

**Default** MLD Snooping fast-leave processing is disabled.

**Mode** Interface Configuration for a specified VLAN interface or a range of VLAN interfaces.

**Usage notes** This MLD Snooping command can only be configured on VLAN interfaces.

**Examples** This example shows how to enable fast-leave processing on the VLAN interface `vlan2`.

```
awplus# configure terminal
awplus(config)# interface vlan2
awplus(config-if)# ipv6 mld snooping fast-leave
```

This example shows how to enable fast-leave processing on the VLAN interface `vlan2-vlan4`.

```
awplus# configure terminal
awplus(config)# interface vlan2-vlan4
awplus(config-if)# ipv6 mld snooping fast-leave
```

# ipv6 mld snooping mrrouter

**Overview** Use this command to statically configure the specified port as a Multicast Router interface for MLD Snooping within the specified VLAN.

See detailed usage notes below to configure static multicast router ports when using static IPv6 multicast routes with EPSR, and the destination VLAN is an EPSR data VLAN.

Use the **no** variant of this command to remove the static configuration of the interface as a Multicast Router interface.

**Syntax** `ipv6 mld snooping mrrouter interface <port>`  
`no ipv6 mld snooping mrrouter interface <port>`

Parameter	Description
<port>	Specify the name of the port.

**Mode** Interface Configuration for a specified VLAN interface or a range of VLAN interfaces.

**Usage notes** This MLD Snooping command statically configures a switch port as a Multicast Router interface.

Note that if static IPv6 multicast routing is being used with EPSR and the destination VLAN is an EPSR data VLAN, then multicast router (mrrouter) ports must be statically configured. This minimizes disruption for multicast traffic in the event of ring failure or restoration.

When configuring the EPSR data VLAN, statically configure mrrouter ports so that the multicast router can be reached in either direction around the EPSR ring.

For example, if port1.0.1 and port1.0.6 are ports on an EPSR data VLAN vlan101, which is the destination for a static IPv6 multicast route, then configure both ports as multicast router (mrrouter) ports as shown in the example commands listed below:

Figure 25-1: Example **ipv6 mld snooping mrrouter** commands when static IPv6 multicast routing is being used and the destination VLAN is an EPSR data VLAN:

```
awplus>enable
awplus#configure terminal
awplus(config)#interface vlan101
awplus(config-if)#ipv6 mld snooping mrrouter interface port1.0.1
awplus(config-if)#ipv6 mld snooping mrrouter interface port1.0.6
```

**Examples** This example shows how to specify the next-hop interface to the multicast router for VLAN interface `vlan2`:

```
awplus# configure terminal
awplus(config)# interface vlan2
awplus(config-if)# ipv6 mld snooping mrouter interface
port1.0.5
```

This example shows how to specify the next-hop interface to the multicast router for VLAN interfaces `vlan2-vlan4`:

```
awplus# configure terminal
awplus(config)# interface vlan2-vlan4
awplus(config-if)# ipv6 mld snooping mrouter interface
port1.0.5
```

# ipv6 mld snooping querier

**Overview** Use this command to enable MLD querier operation on a subnet (VLAN) when no multicast routing protocol is configured in the subnet (VLAN). When enabled, the MLD Snooping querier sends out periodic MLD queries for all interfaces on that VLAN.

Use the **no** variant of this command to disable MLD querier configuration.

**Syntax** `ipv6 mld snooping querier`  
`no ipv6 mld snooping querier`

**Mode** Interface Configuration for a specified VLAN interface.

**Usage** This command can only be configured on a single VLAN interface - not on multiple VLANs.

The MLD Snooping querier uses the 0.0.0.0 Source IP address because it only masquerades as an MLD querier for faster network convergence.

The MLD Snooping querier does not start, or automatically cease, the MLD Querier operation if it detects query message(s) from a multicast router. It restarts as an MLD Snooping querier if no queries are seen within the other querier interval.

**Example** `awplus# configure terminal`  
`awplus(config)# interface vlan2`  
`awplus(config-if)# ipv6 mld snooping querier`

# ipv6 mld snooping report-suppression

**Overview** Use this command to enable report suppression from hosts for Multicast Listener Discovery version 1 (MLDv1) on a VLAN in Interface Configuration mode.

Use the **no** variant of this command to disable report suppression on a VLAN in Interface Configuration mode.

**Syntax** `ipv6 mld snooping report-suppression`  
`no ipv6 mld snooping report-suppression`

**Default** Report suppression does not apply to MLDv2, and is turned on by default for MLDv1 reports.

**Mode** Interface Configuration for a specified VLAN interface or a range of VLAN interfaces.

**Usage** This MLD Snooping command can only be configured on VLAN interfaces. MLDv1 Snooping maybe configured to suppress reports from hosts. When a querier sends a query, only the first report for particular set of group(s) from a host will be forwarded to the querier by the MLD Snooping device. Similar reports (to the same set of groups) from other hosts, which would not change group memberships in the querier, will be suppressed by the MLD Snooping device to prevent 'flooding' of query responses.

**Examples** This example shows how to enable report suppression for MLD reports on VLAN interface `vlan2`:

```
awplus# configure terminal
awplus(config)# interface vlan2
awplus(config-if)# ipv6 mld snooping report-suppression
```

This example shows how to disable report suppression for MLD reports on VLAN interface `vlan2`:

```
awplus# configure terminal
awplus(config)# interface vlan2
awplus(config-if)# no ipv6 mld snooping report-suppression
```

This example shows how to enable report suppression for MLD reports on VLAN interfaces `vlan2-vlan4`:

```
awplus# configure terminal
awplus(config)# interface vlan2-vlan4
awplus(config-if)# ipv6 mld snooping report-suppression
```

This example shows how to disable report suppression for MLD reports on VLAN interfaces `vlan2-vlan4`:

```
awplus# configure terminal
awplus(config)# interface vlan2-vlan4
awplus(config-if)# no ipv6 mld snooping report-suppression
```



# ipv6 mld static-group

**Overview** Use this command to statically configure IPv6 group membership entries on an interface. To statically add only a group membership, do not specify any parameters.

Use the **no** variant of this command to delete static group membership entries.

**Syntax** `ipv6 mld static-group <ipv6-group-address> [source <ipv6-source-address>] [interface <port>]`  
`no ipv6 mld static-group <ipv6-group-address> [source <ipv6-source-address>] [interface <port>]`

Parameter	Description
<code>&lt;ipv6-group-address&gt;</code>	Specify a standard IPv6 Multicast group address to be configured as a static group member. The IPv6 address uses the format X:X::X:X.
<code>&lt;ipv6-source-address&gt;</code>	Optional. Specify a standard IPv6 source address to be configured as a static source from where multicast packets originate. The IPv6 address uses the format X:X::X:X.
<code>&lt;port&gt;</code>	Optional. Physical interface. This parameter specifies a physical port. If this parameter is used, the static configuration is applied to just to that physical interface. If this parameter is not used, the static configuration is applied on all ports in the VLAN.

**Mode** Interface Configuration for a VLAN interface.

**Usage notes** This command applies to MLD Snooping on a VLAN interface to statically add groups and/or source records.

**Examples** To add a static group record, use the following commands:

```
awplus# configure terminal
awplus(config)# interface vlan2
awplus(config-if)# ipv6 mld static-group ff1e::10
```

To add a static group and source record, use the following commands:

```
awplus# configure terminal
awplus(config)# interface vlan2
awplus(config-if)# ipv6 mld static-group ff1e::10 source
fe80::2fd:6cff:fe1c:b
```

To add a static group record on a specific port on vlan2, use the following commands:

```
awplus# configure terminal
awplus(config)# interface vlan2
awplus(config-if)# ipv6 mld static-group ff1e::10 interface
port1.0.4
```

# show debugging mld

**Overview** Use this command to see what debugging is turned on for MLD. MLD debugging modes are enabled with the [debug mld](#) command.

For information on filtering and saving command output, see the [“Getting\\_Started with AlliedWare Plus” Feature Overview and Configuration\\_Guide](#).

**Syntax** show debugging mld

**Mode** Privileged Exec

**Example** awplus# show debugging mld

## Output

```
show debugging mld
MLD Debugging status:
  MLD Decoder debugging is on
  MLD Encoder debugging is on
  MLD Events debugging is on
  MLD FSM debugging is on
  MLD Tree-Info-Base (TIB) debugging is on
```

**Related commands** [debug mld](#)

# show ipv6 mld groups

**Overview** Use this command to display the multicast groups that have receivers directly connected to the router and learned through MLD.

For information on filtering and saving command output, see the [“Getting Started with AlliedWare Plus” Feature Overview and Configuration Guide](#).

**Syntax** `show ipv6 mld groups [<ipv6-address>|<interface>] [detail]`

Parameter	Description
<ipv6-address>	Optional. Specify Address of the multicast group in format X:X::X:X.
<interface>	Optional. Specify the Interface name for which to display local information.

**Mode** User Exec and Privileged Exec

**Examples** The following command displays local-membership information for all interfaces:

```
awplus# show ipv6 mld groups
```

**Output** Figure 25-2: Example output for **show ipv6 mld groups**

```
awplus#show ipv6 mld groups
MLD Connected Group Membership
Group Address                Interface                Uptime    Expires
                               Last Reporter
ff08::1                      vlan10 (port1.0.1)     00:07:27 00:03:10
                               fe80::200:1ff:fe20:b5ac
```

The following command displays local-membership information for all interfaces:

```
awplus# show ipv6 mld groups detail
```

# show ipv6 mld interface

**Overview** Use this command to display the state of MLD and MLD Snooping for a specified interface, or all interfaces.

For information on filtering and saving command output, see the [“Getting Started with AlliedWare Plus” Feature Overview and Configuration Guide](#).

**Syntax** `show ipv6 mld interface [<interface>]`

Parameter	Description
<interface>	Interface name.

**Mode** User Exec and Privileged Exec

**Example** The following command displays MLD interface status on all interfaces enabled for MLD:

```
awplus# show ipv6 mld interface
```

## Output

```
awplus#show ipv6 mld interface

Interface vlan1 (Index 301)
  MLD Enabled, Active, Querier, Version 2 (default)
  Internet address is fe80::215:77ff:fec9:7468
  MLD interface has 0 group-record states
  MLD activity: 0 joins, 0 leaves
  MLD robustness variable is 2
  MLD last member query count is 2
  MLD query interval is 125 seconds
  MLD querier timeout is 255 seconds
  MLD max query response time is 10 seconds
  Last member query response interval is 1000 milliseconds
  Group Membership interval is 260 seconds
  MLD Snooping is globally enabled
  MLD Snooping is enabled on this interface
  MLD Snooping fast-leave is not enabled
  MLD Snooping querier is enabled
  MLD Snooping report suppression is enabled
```

# show ipv6 mld snooping mrouter

**Overview** Use this command to display the multicast router interfaces, both configured and learned, in a VLAN. If you do not specify a VLAN interface then all the VLAN interfaces are displayed.

For information on filtering and saving command output, see the [“Getting\\_Started with AlliedWare Plus” Feature Overview and Configuration\\_Guide](#).

**Syntax** `show ipv6 mld snooping mrouter [<interface>]`

Parameter	Description
<interface>	Optional. Specify the name of the VLAN interface. Note: If you do not specify a single VLAN interface, then all VLAN interfaces are shown.

**Mode** User Exec and Privileged Exec

**Examples** The following command displays the multicast router interfaces in `vlan2`:

```
awplus# show ipv6 mld snooping mrouter vlan2
```

## Output

```
awplus#show ipv6 mld snooping mrouter vlan2
VLAN      Interface      Static/Dynamic
2         port1.0.2      Dynamically Learned
2         port1.0.3      Dynamically Learned
```

The following command displays the multicast router interfaces for all VLAN interfaces:

```
awplus# show ipv6 mld snooping mrouter
```

## Output

```
awplus#show ipv6 mld snooping mrouter
VLAN      Interface      Static/Dynamic
2         port1.0.2      Dynamically Learned
2         port1.0.3      Dynamically Learned
3         port1.0.4      Statically Assigned
3         port1.0.5      Statically Assigned
```

# show ipv6 mld snooping statistics

**Overview** Use this command to display MLD Snooping statistics data.

For information on filtering and saving command output, see the [“Getting Started with AlliedWare Plus”\\_Feature Overview and Configuration Guide](#).

**Syntax** `show ipv6 mld snooping statistics interface <interface>`

Parameter	Description
<interface>	The name of the VLAN interface.

**Mode** User Exec and Privileged Exec

**Example** The following command displays MLDv2 statistical information for vlan1:

```
awplus# show ipv6 mld snooping statistics interface vlan1
```

## Output

```
awplus#show ipv6 mld snooping statistics interface vlan1
MLD Snooping statistics for vlan1
Interface:      port1.0.1
Group:         ff08::1
Uptime:        00:02:18
Group mode:    Include ( )
Last reporter: fe80::eecd:6dff:fe6b:4783
Group source list: (R - Remote, M - SSM Mapping, S - Static )
  Source Address      Uptime      v2 Exp      Fwd  Flags
  2001:db8::1         00:02:18    00:02:02  Yes  R
  2001:db8::3         00:02:18    00:02:02  Yes  R
```

# Part 5: Access and Security



# 26

# IPv4 Hardware Access Control List (ACL) Commands

## Introduction

**Overview** This chapter provides an alphabetical reference of IPv4 Hardware Access Control List (ACL) commands. It contains detailed command information and command examples about IPv4 hardware ACLs, which you can apply directly to interfaces using the `access-group` command.

To apply ACLs to an LACP channel group, apply it to all the individual switch ports in the channel group. To apply ACLs to a static channel group, apply it to the static channel group itself.

Most ACL command titles include information in parentheses:

- When the command title ends with words in parentheses, these words indicate usage instead of keywords to enter into the CLI. For example, the title **access-list (numbered hardware ACL for ICMP)** indicates that the command is used to create an ACL with the syntax:

```
access-list <3000-3699> <action> icmp <source-ip> <dest-ip>  
[icmp-type <number>] [vlan <1-4094>]
```

- When the command title is completely surrounded by parentheses, the title indicates the type of ACL filter instead of keywords to enter into the CLI. For example, the title **(named hardware ACL: ICMP entry)** represents a command with the syntax:

```
[<sequence-number>] <action> icmp <source-ip> <dest-ip>  
[icmp-type <number>] [vlan <1-4094>]
```

Hardware ACLs will **permit** access unless **explicitly denied** by an ACL action.

**Sub-modes** Many of the ACL commands operate from sub-modes that are specific to particular ACL types. The following table shows the CLI prompts at which ACL commands are entered.

Table 26-1: IPv4 Hardware Access List Commands and Prompts

Command Name	Command Mode	Prompt
show interface access-group	Privileged Exec	awplus#
show access-group	Privileged Exec	awplus#
show access-list (IPv4 Hardware ACLs)	Privileged Exec	awplus#
show interface access-group	Privileged Exec	awplus#
access-list (numbered hardware ACL for IP packets)	Global Configuration	awplus(config)#
access-list (numbered hardware ACL for ICMP)	Global Configuration	awplus(config)#
access-list (numbered hardware ACL for IP protocols)	Global Configuration	awplus(config)#
access-list (numbered hardware ACL for TCP or UDP)	Global Configuration	awplus(config)#
access-list (numbered hardware ACL for MAC addresses)	Global Configuration	awplus(config)#
access-list hardware (named hardware ACL)	Global Configuration	awplus(config)#
(named hardware ACL entry for IP packets)	IPv4 Hardware ACL Configuration	awplus(config-ip-hw-acl)#
(named hardware ACL entry for ICMP)	IPv4 Hardware ACL Configuration	awplus(config-ip-hw-acl)#
(named hardware ACL entry for IP protocols)	IPv4 Hardware ACL Configuration	awplus(config-ip-hw-acl)#
(named hardware ACL entry for TCP or UDP)	IPv4 Hardware ACL Configuration	awplus(config-ip-hw-acl)#
(named hardware ACL entry for MAC addresses)	IPv4 Hardware ACL Configuration	awplus(config-ip-hw-acl)#
commit (IPv4)	IPv4 Hardware ACL Configuration	awplus(config-ip-hw-acl)#
access-group	Interface Configuration	awplus(config-if)#

**References** For descriptions of ACLs, and further information about rules when applying them, see the [ACL Feature Overview and Configuration Guide](#).

For more information on link aggregation see the following references:

- [the Link Aggregation Feature Overview\\_and\\_Configuration\\_Guide](#).
- [Link Aggregation Commands](#)

- Command List**
- “access-group” on page 884
  - “access-list (numbered hardware ACL for ICMP)” on page 886

- “access-list (numbered hardware ACL for IP packets)” on page 890
- “access-list (numbered hardware ACL for IP protocols)” on page 893
- “access-list (numbered hardware ACL for MAC addresses)” on page 898
- “access-list (numbered hardware ACL for TCP or UDP)” on page 901
- “access-list hardware (named hardware ACL)” on page 905
- “(named hardware ACL entry for ICMP)” on page 907
- “(named hardware ACL entry for IP packets)” on page 911
- “(named hardware ACL entry for IP protocols)” on page 915
- “(named hardware ACL entry for MAC addresses)” on page 920
- “(named hardware ACL entry for TCP or UDP)” on page 923
- “commit (IPv4)” on page 927
- “show access-group” on page 928
- “show access-list (IPv4 Hardware ACLs)” on page 929
- “show interface access-group” on page 931

# access-group

**Overview** This command adds or removes a hardware-based access-list to or from a switch port interface or interfaces. The number of hardware numbered and named access-lists that can be added to a switch port interface is determined by the available memory in hardware-based packet classification tables.

This command works in Interface Configuration mode to apply hardware access-lists to selected switch port interfaces.

The **no** variant of this command removes the selected access-list from an interface.

**Syntax**

```
access-group  
[ <3000-3699> | <4000-4699> | <hardware-access-list-name> ]  
  
no access-group  
[ <3000-3699> | <4000-4699> | <hardware-access-list-name> ]
```

Parameter	Description
<3000-3699>	Hardware IP access-list.
<4000-4699>	Hardware MAC access-list.
<hardware-access-list-name>	The hardware access-list name.

**Mode** Interface Configuration for a switch port interface or interfaces

**Default** Any traffic on an interface controlled by a hardware ACL that does not explicitly match a filter is permitted.

**Usage notes** First create an IP access-list that applies the appropriate permit/deny requirements with the [access-list \(numbered hardware ACL for IP packets\)](#) command, the [access-list \(numbered hardware ACL for MAC addresses\)](#) command or the [access-list hardware \(named hardware ACL\)](#) command. Then use this command to apply this hardware access-list to a specific port or port range. Note that this command will apply the access-list only to incoming data packets.

To apply ACLs to an LACP aggregated link, apply it to all the individual switch ports in the aggregated group. To apply ACLs to a static channel group, apply it to the static channel group itself. An ACL can even be applied to a static aggregated link that spans more than one switch instance ([Link Aggregation Commands](#)).

Note that you cannot apply software numbered ACLs to switch port interfaces with the access-group command. This command will only apply hardware ACLs.

**NOTE:** Hardware ACLs will **permit** access unless **explicitly denied** by an ACL action.

**Examples** To add the numbered hardware access-list 3005 to switch port interface port1.0.1, enter the following commands:

```
awplus# configure terminal
awplus(config)# interface port1.0.1
awplus(config-if)# access-group 3005
```

To add the named hardware access-list "hw-acl" to switch port interface port1.0.2, enter the following commands:

```
awplus# configure terminal
awplus(config)# interface port1.0.2
awplus(config-if)# access-group hw-acl
```

To apply an ACL to static channel group 2 containing switch port1.0.3 and port1.0.4, use the commands:

```
awplus# configure terminal
awplus(config)# interface port1.0.3-port1.0.4
awplus(config-if)# static-channel-group 2
awplus(config)# interface sa2
awplus(config-if)# access-group 3000
```

**Related commands**

[access-list hardware \(named hardware ACL\)](#)  
[access-list \(numbered hardware ACL for IP packets\)](#)  
[access-list \(numbered hardware ACL for MAC addresses\)](#)  
[show interface access-group](#)

# access-list (numbered hardware ACL for ICMP)

**Overview** This command creates an access-list for use with hardware classification. The access-list will match on ICMP packets that have the specified source and destination IP addresses and, optionally, ICMP type. You can use the value **any** instead of source or destination address if an address does not matter.

Once you have configured the ACL, you can use the [access-group](#) or the [match access-group](#) command to apply this ACL to a port, VLAN or QoS class-map.

The optional **vlan** parameter can be used to match tagged (802.1q) packets.

The **no** variant of this command removes the previously specified access-list.

Hardware ACLs will **permit** access unless **explicitly denied** by an ACL action.

**CAUTION:** Specifying a "send" action enables you to use ACLs to redirect packets from their original destination. Use such ACLs with caution. They could prevent control packets from reaching the correct destination, such as EPSR healthcheck messages and AMF messages.

**Syntax** `access-list <3000-3699> <action> icmp <source-ip> <dest-ip> [icmp-type <number>] [vlan <1-4094>]`  
`no access-list <3000-3699>`

The following actions are available for hardware ACLs:

Values for the <action> parameter	
deny	Reject packets that match the source and destination filtering specified with this command.
permit	Permit packets that match the source and destination filtering specified with this command.
copy-to-cpu	Send a copy of matching packets to the CPU.
copy-to-mirror	Send a copy of matching packets to the mirror port. Use the <b>mirror interface</b> command to configure the mirror port.
send-to-mirror	Send matching packets to the mirror port. Use the <b>mirror interface</b> command to configure the mirror port.
send-to-vlan-port vlan <vid> port <port-number>	Send matching packets to the specified port, tagged with the specified VLAN. The specified port must belong to the specified VLAN.
send-to-cpu	Send matching packets to the CPU.

Parameter	Description
<3000-3699>	An ID number for this hardware IP access-list.
<action>	The action that the switch will take on matching packets. See the table above for valid values.
icmp	Match against ICMP packets
<source-ip>	The source addresses to match against. You can specify a single host, a subnet, or all source addresses. The following are the valid formats for specifying the source:
any	Match any source IP address.
host <ip-addr>	Match a single source host with the IP address given by <ip-addr> in dotted decimal notation.
<ip-addr>/<prefix>	Match any source IP address within the specified subnet. Specify the subnet by entering the IPv4 address, then a forward slash, then the prefix length.
<ip-addr> <reverse-mask>	Match any source IP address within the specified subnet. Specify the subnet by entering a reverse mask in dotted decimal format. For example, entering "192.168.1.1 0.0.0.255" is the same as entering 192.168.1.1/24.
<dest-ip>	The destination addresses to match against. You can specify a single host, a subnet, or all destination addresses. The following are the valid formats for specifying the destination:
any	Match any destination IP address.
host <ip-addr>	Match a single destination host with the IP address given by <ip-addr> in dotted decimal notation.
<ip-addr>/<prefix>	Match any destination IP address within the specified subnet. Specify the subnet by entering the IPv4 address, then a forward slash, then the prefix length.
<ip-addr> <reverse-mask>	Match any destination IP address within the specified subnet. Specify the subnet by entering a reverse mask in dotted decimal format. For example, entering "192.168.1.1 0.0.0.255" is the same as entering 192.168.1.1/24.
icmp-type <number>	The type of ICMP message to match against, as defined in RFC792 and RFC950. Values include:
0	Echo replies.

Parameter	Description
	3 Destination unreachable messages.
	4 Source quench messages.
	5 Redirect (change route) messages.
	8 Echo requests.
	11 Time exceeded messages.
	12 Parameter problem messages.
	13 Timestamp requests.
	14 Timestamp replies.
	15 Information requests.
	16 Information replies.
	17 Address mask requests.
	18 Address mask replies.
vlan <1-4094>	The VLAN to match against. The ACL will match against the specified ID in the packet's VLAN tag.

**Mode** Global Configuration

**Default** On an interface controlled by a hardware ACL, any traffic that does not explicitly match a filter is permitted.

**Usage notes** This command creates an ACL for use with hardware classification. Once you have configured the ACL, use the [access-group](#) or the [match access-group](#) command to apply this ACL to a port, VLAN or QoS class-map.

ACLs numbered in the range 3000-3699 match on packets that have the specified source and destination IP addresses.

ICMP ACLs will match any ICMP packet that has the specified source and destination IP addresses and ICMP type. The ICMP type is an optional parameter.

**Examples** To create an access-list that will permit ICMP packets with a source address of 192.168.1.0/24 with any destination address and an ICMP type of 5 enter the following commands:

```
awplus# configure terminal
awplus(config)# access-list 3000 permit icmp 192.168.1.0/24 any
icmp-type 5
```

To destroy the access-list with an access-list identity of 3000 enter the following commands:

```
awplus# configure terminal
awplus(config)# no access-list 3000
```

**Related commands** [access-group](#)



match access-group  
show running-config  
show access-list (IPv4 Hardware ACLs)

**Command changes** Version 5.4.6-2.1: **send-to-vlan-port** action parameter added

# access-list (numbered hardware ACL for IP packets)

**Overview** This command creates an access-list for use with hardware classification. The access-list will match on packets that have the specified source and destination IP addresses. You can use the value **any** instead of source or destination address if an address does not matter.

Once you have configured the ACL, you can use the [access-group](#) or the [match access-group](#) command to apply this ACL to a port, VLAN or QoS class-map.

The optional **vlan** parameter can be used to match tagged (802.1q) packets.

The **no** variant of this command removes the previously specified IP hardware access-list.

Hardware ACLs will **permit** access unless **explicitly denied** by an ACL action.

**CAUTION:** Specifying a "send" action enables you to use ACLs to redirect packets from their original destination. Use such ACLs with caution. They could prevent control packets from reaching the correct destination, such as EPSR healthcheck messages and AMF messages.

**Syntax** `access-list <3000-3699> <action> ip <source-ip> <dest-ip> [vlan <1-4094>]`

`no access-list <3000-3699>`

The following actions are available for hardware ACLs:

Values for the <action> parameter	
deny	Reject packets that match the source and destination filtering specified with this command.
permit	Permit packets that match the source and destination filtering specified with this command.
copy-to-cpu	Send a copy of matching packets to the CPU.
copy-to-mirror	Send a copy of matching packets to the mirror port. Use the <b>mirror interface</b> command to configure the mirror port.
send-to-mirror	Send matching packets to the mirror port. Use the <b>mirror interface</b> command to configure the mirror port.
send-to-vlan-port vlan <vid> port <port-number>	Send matching packets to the specified port, tagged with the specified VLAN. The specified port must belong to the specified VLAN.
send-to-cpu	Send matching packets to the CPU.

Table 26-2: IP and ICMP parameters in **access-list (hardware IP numbered)**

Parameter	Description
<3000-3699>	An ID number for this hardware IP access-list.
<action>	The action that the switch will take on matching packets. See the table above for valid values.
ip	Match against IP packets
<source-ip>	The source addresses to match against. You can specify a single host, a subnet, or all source addresses. The following are the valid formats for specifying the source:
any	Match any source IP address.
host <ip-addr>	Match a single source host with the IP address given by <ip-addr> in dotted decimal notation.
<ip-addr>/<prefix>	Match any source IP address within the specified subnet. Specify the subnet by entering the IPv4 address, then a forward slash, then the prefix length.
<ip-addr> <reverse-mask>	Match any source IP address within the specified subnet. Specify the subnet by entering a reverse mask in dotted decimal format. For example, entering "192.168.1.1 0.0.0.255" is the same as entering 192.168.1.1/24.
<dest-ip>	The destination addresses to match against. You can specify a single host, a subnet, or all destination addresses. The following are the valid formats for specifying the destination:
any	Match any destination IP address.
host <ip-addr>	Match a single destination host with the IP address given by <ip-addr> in dotted decimal notation.
<ip-addr>/<prefix>	Match any destination IP address within the specified subnet. Specify the subnet by entering the IPv4 address, then a forward slash, then the prefix length.
<ip-addr> <reverse-mask>	Match any destination IP address within the specified subnet. Specify the subnet by entering a reverse mask in dotted decimal format. For example, entering "192.168.1.1 0.0.0.255" is the same as entering 192.168.1.1/24.
vlan <1-4094>	The VLAN to match against. The ACL will match against the specified ID in the packet's VLAN tag.

**Mode** Global Configuration

**Default** On an interface controlled by a hardware ACL, any traffic that does not explicitly match a filter is permitted.

**Usage notes** This command creates an ACL for use with hardware classification. Once you have configured the ACL, use the [access-group](#) or the [match access-group](#) command to apply this ACL to a port, VLAN or QoS class-map.

ACLs numbered in the range 3000-3699 match on packets that have the specified source and destination IP addresses.

**Examples** To create an access-list that will permit IP packets with a source address of 192.168.1.1 and any destination address, enter the commands:

```
awplus# configure terminal
awplus(config)# access-list 3000 permit ip 192.168.1.1/32 any
```

To destroy the access-list with an access-list identity of 3000 enter the following commands:

```
awplus# configure terminal
awplus(config)# no access-list 3000
```

**Related commands**

- [access-group](#)
- [match access-group](#)
- [show running-config](#)
- [show access-list \(IPv4 Hardware ACLs\)](#)

**Command changes** Version 5.4.6-2.1: **send-to-vlan-port** action parameter added

# access-list (numbered hardware ACL for IP protocols)

**Overview** This command creates an access-list for use with hardware classification. The access-list will match on packets that have the specified source and destination IP addresses and IP protocol number. You can use the value **any** instead of source or destination address if an address does not matter.

Once you have configured the ACL, you can use the [access-group](#) or the [match access-group](#) command to apply this ACL to a port, VLAN or QoS class-map.

The optional **vlan** parameter can be used to match tagged (802.1q) packets.

The **no** variant of this command removes the previously specified IP hardware access-list.

Hardware ACLs will **permit** access unless **explicitly denied** by an ACL action.

**CAUTION:** Specifying a "send" action enables you to use ACLs to redirect packets from their original destination. Use such ACLs with caution. They could prevent control packets from reaching the correct destination, such as EPSR healthcheck messages and AMF messages.

**Syntax** `access-list <3000-3699> <action> proto <1-255> <source-ip> <dest-ip> [vlan <1-4094>]`  
`no access-list <3000-3699>`

The following actions are available for hardware ACLs:

Values for the <action> parameter	
deny	Reject packets that match the source and destination filtering specified with this command.
permit	Permit packets that match the source and destination filtering specified with this command.
copy-to-cpu	Send a copy of matching packets to the CPU.
copy-to-mirror	Send a copy of matching packets to the mirror port. Use the <b>mirror interface</b> command to configure the mirror port.
send-to-mirror	Send matching packets to the mirror port. Use the <b>mirror interface</b> command to configure the mirror port.
send-to-vlan-port vlan <vid> port <port-number>	Send matching packets to the specified port, tagged with the specified VLAN. The specified port must belong to the specified VLAN.
send-to-cpu	Send matching packets to the CPU.

Table 26-3: Parameters in **access-list (hardware IP numbered)**

Parameter	Description
<3000-3699>	An ID number for this hardware IP access-list.
<action>	The action that the switch will take on matching packets. See the table above for valid values.
proto <1-255>	The IP protocol number to match against, as defined by IANA (Internet Assigned Numbers Authority) <a href="http://www.iana.org/assignments/protocol-numbers">www.iana.org/assignments/protocol-numbers</a> See below for a list of IP protocol numbers and their descriptions.
<source-ip>	The source addresses to match against. You can specify a single host, a subnet, or all source addresses. The following are the valid formats for specifying the source:
any	Match any source IP address.
host <ip-addr>	Match a single source host with the IP address given by <ip-addr> in dotted decimal notation.
<ip-addr>/<prefix>	Match any source IP address within the specified subnet. Specify the subnet by entering the IPv4 address, then a forward slash, then the prefix length.
<ip-addr> <reverse-mask>	Match any source IP address within the specified subnet. Specify the subnet by entering a reverse mask in dotted decimal format. For example, entering "192.168.1.1 0.0.0.255" is the same as entering 192.168.1.1/24.
<dest-ip>	The destination addresses to match against. You can specify a single host, a subnet, or all destination addresses. The following are the valid formats for specifying the destination:
any	Match any destination IP address.
host <ip-addr>	Match a single destination host with the IP address given by <ip-addr> in dotted decimal notation.
<ip-addr>/<prefix>	Match any destination IP address within the specified subnet. Specify the subnet by entering the IPv4 address, then a forward slash, then the prefix length.

Table 26-3: Parameters in **access-list (hardware IP numbered)** (cont.)

Parameter	Description
<i>&lt;ip-addr&gt;</i> <i>&lt;reverse-mask&gt;</i>	Match any destination IP address within the specified subnet. Specify the subnet by entering a reverse mask in dotted decimal format. For example, entering "192.168.1.1 0.0.0.255" is the same as entering 192.168.1.1/24.
vlan <i>&lt;1-4094&gt;</i>	The VLAN to match against. The ACL will match against the specified ID in the packet's VLAN tag.

Table 26-4: IP protocol number and description

Protocol Number	Protocol Description [RFC]
1	Internet Control Message [RFC792]
2	Internet Group Management [RFC1112]
3	Gateway-to-Gateway [RFC823]
4	IP in IP [RFC2003]
5	Stream [RFC1190] [RFC1819]
6	TCP (Transmission Control Protocol) [RFC793]
8	EGP (Exterior Gateway Protocol) [RFC888]
9	IGP (Interior Gateway Protocol) [IANA]
11	Network Voice Protocol [RFC741]
17	UDP (User Datagram Protocol) [RFC768]
20	Host monitoring [RFC869]
27	RDP (Reliable Data Protocol) [RFC908]
28	IRTP (Internet Reliable Transaction Protocol) [RFC938]
29	ISO-TP4 (ISO Transport Protocol Class 4) [RFC905]
30	Bulk Data Transfer Protocol [RFC969]
33	DCCP (Datagram Congestion Control Protocol) [RFC4340]
48	DSR (Dynamic Source Routing Protocol) [RFC4728]
50	ESP (Encap Security Payload) [RFC2406]
51	AH (Authentication Header) [RFC2402]
54	NARP (NBMA Address Resolution Protocol) [RFC1735]
58	ICMP for IPv6 [RFC1883]
59	No Next Header for IPv6 [RFC1883]
60	Destination Options for IPv6 [RFC1883]

Table 26-4: IP protocol number and description (cont.)

Protocol Number	Protocol Description [RFC]
88	EIGRP (Enhanced Interior Gateway Routing Protocol)
89	OSPFv2 [RFC1583]
97	Ethernet-within-IP Encapsulation / RFC3378
98	Encapsulation Header / RFC1241
108	IP Payload Compression Protocol / RFC2393
112	Virtual Router Redundancy Protocol / RFC3768
134	RSVP-E2E-IGNORE / RFC3175
135	Mobility Header / RFC3775
136	UDPLite / RFC3828
137	MPLS-in-IP / RFC4023
138	MANET Protocols / RFC-ietf-manet-iana-07.txt
139-252	Unassigned / IANA
253	Use for experimentation and testing / RFC3692
254	Use for experimentation and testing / RFC3692
255	Reserved / IANA

**Mode** Global Configuration

**Default** On an interface controlled by a hardware ACL, any traffic that does not explicitly match a filter is permitted.

**Usage notes** This command creates an ACL for use with hardware classification. Once you have configured the ACL, use the [access-group](#) or the [match access-group](#) command to apply this ACL to a port, VLAN or QoS class-map.

ACLs numbered in the range 3000-3699 match on packets that have the specified source and destination IP addresses.

**Examples** To create an access-list that will deny all IGMP packets (IP protocol 2) from the 192.168.0.0 network, enter the commands:

```
awplus# configure terminal
awplus(config)# access-list 3000 deny proto 2 192.168.0.0/16
any
```

To destroy the access-list with an access-list identity of 3000 enter the following commands:

```
awplus# configure terminal
awplus(config)# no access-list 3000
```

**Related commands** [access-group](#)



match access-group  
show running-config  
show access-list (IPv4 Hardware ACLs)

**Command changes** Version 5.4.6-2.1: **send-to-vlan-port** action parameter added

# access-list (numbered hardware ACL for MAC addresses)

**Overview** This command creates an access-list for use with hardware classification. The access-list will match on packets that have the specified source and destination MAC addresses. You can use the value **any** instead of source or destination address if an address does not matter.

Once you have configured the ACL, you can use the [access-group](#) or the [match access-group](#) command to apply this ACL to a port, VLAN or QoS class-map.

The **no** variant of this command removes the specified MAC hardware filter access-list.

Hardware ACLs will **permit** access unless **explicitly denied** by an ACL action.

**CAUTION:** Specifying a "send" action enables you to use ACLs to redirect packets from their original destination. Use such ACLs with caution. They could prevent control packets from reaching the correct destination, such as EPSR healthcheck messages and AMF messages.

**Syntax**

```
access-list <4000-4699> <action> {<source-mac>|any}  
{<dest-mac>|any} [vlan <1-4094>]  
  
no access-list <4000-4699>
```

The following actions are available for hardware ACLs:

Values for the <action> parameter	
deny	Reject packets that match the source and destination filtering specified with this command.
permit	Permit packets that match the source and destination filtering specified with this command.
copy-to-cpu	Send a copy of matching packets to the CPU.
copy-to-mirror	Send a copy of matching packets to the mirror port. Use the <b>mirror interface</b> command to configure the mirror port.
send-to-mirror	Send matching packets to the mirror port. Use the <b>mirror interface</b> command to configure the mirror port.
send-to-vlan-port vlan <vid> port <port-number>	Send matching packets to the specified port, tagged with the specified VLAN. The specified port must belong to the specified VLAN.
send-to-cpu	Send matching packets to the CPU.

Parameter	Description
<4000-4699>	Hardware MAC access-list.
<action>	The action that the switch will take on matching packets. See the table above for valid values.
<source-mac>	The source MAC address to match against, followed by the mask. Enter the address in the format <HHHH.HHHH.HHHH>, where each <i>H</i> is a hexadecimal number. Enter the mask in the format <HHHH.HHHH.HHHH>, where each <i>H</i> is a hexadecimal number. For a mask, each value is either 0 or F, where FF = Ignore, and 00 = Match.
any	Match against any source MAC address.
<dest-mac>	The destination MAC address to match against, followed by the mask. Enter the address in the format <HHHH.HHHH.HHHH>, where each <i>H</i> is a hexadecimal number. Enter the mask in the format <HHHH.HHHH.HHHH>, where each <i>H</i> is a hexadecimal number. For a mask, each value is either 0 or F, where FF = Ignore, and 00 = Match.
any	Match against any destination MAC address.
vlan <1-4094>	Match against the specified ID in the packet's VLAN tag.

**Mode** Global Configuration

**Default** On an interface controlled by a hardware ACL, any traffic that does not explicitly match a filter is permitted.

**Usage notes** This command creates an ACL for use with hardware classification. Once you have configured the ACL, use the [access-group](#) or the [match access-group](#) command to apply this ACL to a port, VLAN or QoS class-map.

ACLs numbered in the range 4000-4699 match on packets that have the specified source and destination MAC addresses.

**Examples** To create an access-list that will permit packets with a source MAC address of 0000.00ab.1234 and any destination address, use the commands:

```
awplus# configure terminal
awplus(config)# access-list 4000 permit 0000.00ab.1234
0000.0000.0000 any
```

To create an access-list that will permit packets if their source MAC address starts with 0000.00ab, use the commands:

```
awplus# configure terminal
awplus(config)# access-list 4001 permit 0000.00ab.1234
0000.0000.FFFF any
```

To create an access-list that will send a copy of packets to the mirror port if their source MAC address starts with 0000.00ab, use the commands:

```
awplus# configure terminal
awplus(config)# access-list 4001 copy-to-mirror 0000.00ab.1234
0000.0000.FFFF any
```

You also need to configure the mirror port with the [mirror interface](#) command.

To destroy the access-list with an access-list identity of 4000 enter the commands:

```
awplus# configure terminal
awplus(config)# no access-list 4000
```

**Related  
commands**

[access-group](#)  
[match access-group](#)  
[show running-config](#)  
[show access-list \(IPv4 Hardware ACLs\)](#)

**Command  
changes**

Version 5.4.7-2.1: **send-to-vlan-port** action parameter added to GS900MX, SBx8100, SBx908 GEN2, XS900MX series.

Version 5.4.6-2.1: **send-to-vlan-port** action parameter added

# access-list (numbered hardware ACL for TCP or UDP)

**Overview** This command creates an access-list for use with hardware classification. The access-list will match on TCP or UDP packets that have the specified source and destination IP addresses and optionally, port values. You can use the value **any** instead of source or destination IP address if an address does not matter.

Once you have configured the ACL, you can use the [access-group](#) or the [match access-group](#) command to apply this ACL to a port, VLAN or QoS class-map.

You can use the optional **vlan** parameter to match tagged (802.1q) packets.

The **no** variant of this command removes the specified IP hardware access-list.

Hardware ACLs will **permit** access unless **explicitly denied** by an ACL action.

**CAUTION:** Specifying a “send” action enables you to use ACLs to redirect packets from their original destination. Use such ACLs with caution. They could prevent control packets from reaching the correct destination, such as EPSR healthcheck messages and AMF messages.

**Syntax** `access-list <3000-3699> <action> {tcp|udp} <source-ip> [  
<source-ports>] <dest-ip> [<dest-ports>] [vlan <1-4094>]  
no access-list <3000-3699>`

The following actions are available for hardware ACLs:

Values for the <action> parameter	
deny	Reject packets that match the source and destination filtering specified with this command.
permit	Permit packets that match the source and destination filtering specified with this command.
copy-to-cpu	Send a copy of matching packets to the CPU.
copy-to-mirror	Send a copy of matching packets to the mirror port. Use the <b>mirror interface</b> command to configure the mirror port.
send-to-mirror	Send matching packets to the mirror port. Use the <b>mirror interface</b> command to configure the mirror port.
send-to-vlan-port vlan <vid> port <port-number>	Send matching packets to the specified port, tagged with the specified VLAN. The specified port must belong to the specified VLAN.
send-to-cpu	Send matching packets to the CPU.

Parameter	Description
<3000-3699>	An ID number for this hardware IP access-list.
<action>	The action that the switch will take on matching packets. See the table above for valid values.
tcp	Match against TCP packets.
udp	Match against UDP packets.
<source-ip>	The source addresses to match against. You can specify a single host, a subnet, or all source addresses. The following are the valid formats for specifying the source:
any	Match any source IP address.
host <ip-addr>	Match a single source host with the IP address given by <ip-addr> in dotted decimal notation.
<ip-addr>/<prefix>	Match any source IP address within the specified subnet. Specify the subnet by entering the IPv4 address, then a forward slash, then the prefix length.
<ip-addr> <reverse-mask>	Match any source IP address within the specified subnet. Specify the subnet by entering a reverse mask in dotted decimal format. For example, entering "192.168.1.1 0.0.0.255" is the same as entering 192.168.1.1/24.
<source-ports> >	Match source TCP or UDP port numbers. Port numbers are specified as integers between 0 and 65535. You can specify one or more port numbers as follows:
eq <0-65535>	Match a single port number.
lt <0-65535>	Match all port numbers that are less than the specified port number.
gt <0-65535>	Match all port numbers that are greater than the specified port number.
ne <0-65535>	Match all port numbers except the specified port number.
range <start-port> <end-port>	Match a range of port numbers.
<dest-ip>	The destination addresses to match against. You can specify a single host, a subnet, or all destination addresses. The following are the valid formats for specifying the destination:
any	Match any destination IP address.
host <ip-addr>	Match a single destination host with the IP address given by <ip-addr> in dotted decimal notation.

Parameter	Description
	<p><i>&lt;ip-addr&gt;/&lt;prefix&gt;</i> Match any destination IP address within the specified subnet. Specify the subnet by entering the IPv4 address, then a forward slash, then the prefix length.</p>
	<p><i>&lt;ip-addr&gt;</i> <i>&lt;reverse-mask&gt;</i> Match any destination IP address within the specified subnet. Specify the subnet by entering a reverse mask in dotted decimal format. For example, entering "192.168.1.1 0.0.0.255" is the same as entering 192.168.1.1/24.</p>
<i>&lt;dest-ports&gt;</i>	Match destination TCP or UDP port numbers. Port numbers are specified as integers between 0 and 65535. You can specify one or more port numbers as follows:
<i>eq &lt;0-65535&gt;</i>	Match a single port number.
<i>lt &lt;0-65535&gt;</i>	Match all port numbers that are less than the specified port number.
<i>gt &lt;0-65535&gt;</i>	Match all port numbers that are greater than the specified port number.
<i>ne &lt;0-65535&gt;</i>	Match all port numbers except the specified port number.
<i>range &lt;start-port&gt;</i> <i>&lt;end-port&gt;</i>	Match a range of port numbers.
<i>vlan &lt;1-4094&gt;</i>	The VLAN to match against. The ACL will match against the specified ID in the packet's VLAN tag.

**Mode** Global Configuration

**Default** On an interface controlled by a hardware ACL, any traffic that does not explicitly match a filter is permitted.

**Usage notes** This command creates an ACL for use with hardware classification. Once you have configured the ACL, use the [access-group](#) or the [match access-group](#) command to apply this ACL to a port, VLAN or QoS class-map.

ACLs numbered in the range 3000-3699 match on packets that have the specified source and destination IP addresses.

**Examples** To create an access-list that will permit TCP packets with a destination address of 192.168.1.1, a destination port of 80, and any source address and source port, enter the commands:

```
awplus# configure terminal
awplus(config)# access-list 3000 permit tcp any 192.168.1.1/32
eq 80
```

To create an access-list that will copy TCP packets to the mirror port, if they have a destination address of 192.168.1.1, a destination port of 80, and any source address and source port, enter the commands:

```
awplus# configure terminal
awplus(config)# access-list 3000 copy-to-mirror tcp any
192.168.1.1/32 eq 80
```

You also need to configure the mirror port with the [mirror interface](#) command.

**Related  
commands**

[access-group](#)  
[match access-group](#)  
[show running-config](#)  
[show access-list \(IPv4 Hardware ACLs\)](#)

**Command  
changes**

Version 5.4.6-2.1: **send-to-vlan-port** action parameter added



# access-list hardware (named hardware ACL)

**Overview** This command creates a named hardware access-list and puts you into IPv4 Hardware ACL Configuration mode, where you can add filter entries to the ACL. Once you have configured the ACL, you can use the [access-group](#) or the [match access-group](#) command to apply this ACL to a port, VLAN or QoS class-map. The **no** variant of this command removes the specified named hardware ACL.

**Syntax** `access-list hardware <name>`  
`no access-list hardware <name>`

Parameter	Description
<code>&lt;name&gt;</code>	Specify a name for the hardware ACL.

**Mode** Global Configuration

**Default** Any traffic on an interface controlled by a hardware ACL that does not explicitly match a filter is permitted.

**Usage notes** Use this command to name a hardware ACL and enter the IPv4 Hardware ACL Configuration mode. If the named hardware ACL does not exist, it will be created after entry. If the named hardware ACL already exists, then this command puts you into IPv4 Hardware ACL Configuration mode for that existing ACL.

Entering this command moves you to the IPv4 Hardware ACL Configuration mode (config-ip-hw-acl prompt), so you can enter ACL filters with sequence numbers. From this prompt, configure the filters for the ACL. See the [ACL Feature Overview and Configuration Guide](#) for complete examples of configured sequenced numbered ACLs.

**NOTE:** Hardware ACLs will **permit** access unless **explicitly denied** by an ACL action.

**Examples** To create the hardware access-list named "ACL-1" and enter the IPv4 Hardware ACL Configuration mode to specify the ACL filter entry, use the commands:

```
awplus# configure terminal
awplus(config)# access-list hardware ACL-1
awplus(config-ip-hw-acl)#
```

To remove the hardware access-list named "ACL-1", use the commands:

```
awplus# configure terminal
awplus(config)# no access-list hardware ACL-1
```

**Related commands**

- `access-group`  
(named hardware ACL entry for ICMP)
- (named hardware ACL entry for IP protocols)
- (named hardware ACL entry for TCP or UDP)
- (access-list standard named filter)
- `show access-list` (IPv4 Hardware ACLs)

## (named hardware ACL entry for ICMP)

**Overview** Use this command to add a new ICMP filter entry to the current hardware access-list. The filter will match on any ICMP packet that has the specified source and destination IP addresses and (optionally) ICMP type. You can specify the value **any** if source or destination address does not matter.

If you specify a sequence number, the switch inserts the new filter at the specified location. Otherwise, the switch adds the new filter to the end of the access-list.

The **no** variant of this command removes an ICMP filter entry from the current hardware access-list. You can specify the ICMP filter entry for removal by entering either its sequence number (e.g. **no 100**), or by entering its ICMP filter profile without specifying its sequence number (e.g. **no permit icmp 192.168.1.0/24 any icmp-type 11**).

You can find the sequence number by running the [show access-list \(IPv4 Hardware ACLs\)](#) command.

Hardware ACLs will **permit** access unless **explicitly denied** by an ACL action.

**CAUTION:** Specifying a “send” action enables you to use ACLs to redirect packets from their original destination. Use such ACLs with caution. They could prevent control packets from reaching the correct destination, such as EPSR healthcheck messages and AMF messages.

**Syntax** [`<sequence-number>`] `<action>` icmp `<source-ip>` `<dest-ip>`  
[icmp-type `<number>`] [vlan `<1-4094>`]  
  
no `<sequence-number>`  
  
no `<action>` icmp `<source-ip>` `<dest-ip>` [icmp-type `<number>`]  
[vlan `<1-4094>`]

The following actions are available for hardware ACLs:

Values for the <code>&lt;action&gt;</code> parameter	
deny	Reject packets that match the source and destination filtering specified with this command.
permit	Permit packets that match the source and destination filtering specified with this command.
copy-to-cpu	Send a copy of matching packets to the CPU.
copy-to-mirror	Send a copy of matching packets to the mirror port. Use the <b>mirror interface</b> command to configure the mirror port.
send-to-mirror	Send matching packets to the mirror port. Use the <b>mirror interface</b> command to configure the mirror port.

Values for the <action> parameter	
send-to-vlan-port vlan <vid> port <port-number>	Send matching packets to the specified port, tagged with the specified VLAN. The specified port must belong to the specified VLAN.
send-to-cpu	Send matching packets to the CPU.

Parameter	Description
<sequence-number>	The sequence number for the filter entry of the selected access control list, in the range 1-65535. If you do not specify a sequence number, the switch puts the entry at the end of the ACL and assigns it the next available multiple of 10 as its sequence number. .
<action>	The action that the switch will take on matching packets. See the table above for valid values.
icmp	Match against ICMP packets
<source-ip>	The source addresses to match against. You can specify a single host, a subnet, or all source addresses. The following are the valid formats for specifying the source:
any	Match any source IP address.
host <ip-addr>	Match a single source host with the IP address given by <ip-addr> in dotted decimal notation.
<ip-addr>/<prefix>	Match any source IP address within the specified subnet. Specify the subnet by entering the IPv4 address, then a forward slash, then the prefix length.
<ip-addr> <reverse-mask>	Match any source IP address within the specified subnet. Specify the subnet by entering a reverse mask in dotted decimal format. For example, entering "192.168.1.1 0.0.0.255" is the same as entering 192.168.1.1/24.
<dest-ip>	The destination addresses to match against. You can specify a single host, a subnet, or all destination addresses. The following are the valid formats for specifying the destination:
any	Match any destination IP address.
host <ip-addr>	Match a single destination host with the IP address given by <ip-addr> in dotted decimal notation.

Parameter	Description																										
	<p><i>&lt;ip-addr&gt;/&lt;prefix&gt;</i> Match any destination IP address within the specified subnet. Specify the subnet by entering the IPv4 address, then a forward slash, then the prefix length.</p>																										
	<p><i>&lt;ip-addr&gt;</i> <i>&lt;reverse-mask&gt;</i> Match any destination IP address within the specified subnet. Specify the subnet by entering a reverse mask in dotted decimal format. For example, entering "192.168.1.1 0.0.0.255" is the same as entering 192.168.1.1/24.</p>																										
icmp-type <i>&lt;number&gt;</i>	<p>The type of ICMP message to match against, as defined in RFC792 and RFC950. Values include:</p> <table border="1"> <tbody> <tr> <td>0</td> <td>Echo replies.</td> </tr> <tr> <td>3</td> <td>Destination unreachable messages.</td> </tr> <tr> <td>4</td> <td>Source quench messages.</td> </tr> <tr> <td>5</td> <td>Redirect (change route) messages.</td> </tr> <tr> <td>8</td> <td>Echo requests.</td> </tr> <tr> <td>11</td> <td>Time exceeded messages.</td> </tr> <tr> <td>12</td> <td>Parameter problem messages.</td> </tr> <tr> <td>13</td> <td>Timestamp requests.</td> </tr> <tr> <td>14</td> <td>Timestamp replies.</td> </tr> <tr> <td>15</td> <td>Information requests.</td> </tr> <tr> <td>16</td> <td>Information replies.</td> </tr> <tr> <td>17</td> <td>Address mask requests.</td> </tr> <tr> <td>18</td> <td>Address mask replies.</td> </tr> </tbody> </table>	0	Echo replies.	3	Destination unreachable messages.	4	Source quench messages.	5	Redirect (change route) messages.	8	Echo requests.	11	Time exceeded messages.	12	Parameter problem messages.	13	Timestamp requests.	14	Timestamp replies.	15	Information requests.	16	Information replies.	17	Address mask requests.	18	Address mask replies.
0	Echo replies.																										
3	Destination unreachable messages.																										
4	Source quench messages.																										
5	Redirect (change route) messages.																										
8	Echo requests.																										
11	Time exceeded messages.																										
12	Parameter problem messages.																										
13	Timestamp requests.																										
14	Timestamp replies.																										
15	Information requests.																										
16	Information replies.																										
17	Address mask requests.																										
18	Address mask replies.																										
vlan <i>&lt;1-4094&gt;</i>	The VLAN to match against. The ACL will match against the specified ID in the packet's VLAN tag.																										

**Mode** IPv4 Hardware ACL Configuration (accessed by running the command [access-list hardware \(named hardware ACL\)](#))

**Default** On an interface controlled by a hardware ACL, any traffic that does not explicitly match a filter is permitted.

**Usage notes** To use this command, first run the command [access-list hardware \(named hardware ACL\)](#) and enter the desired access-list name. This changes the prompt to awplus(config-ip-hw-acl)#.

Then use this command (and the other "named hardware ACL: entry" commands) to add filter entries. You can add multiple filter entries to an ACL. You can insert a

new filter entry into the middle of an existing list by specifying the appropriate sequence number. If you do not specify a sequence number, the switch puts the entry at the end of the ACL and assigns it the next available multiple of 10 as its sequence number.

Then use the [access-group](#) or the [match access-group](#) command to apply this ACL to a port, VLAN or QoS class-map. Note that the ACL will only apply to incoming data packets.

**Examples** To add an access-list filter entry with a sequence number of 100 to the access-list named "my-list" that will permit ICMP packets with a source address of 192.168.1.0/24, any destination address and an ICMP type of 5, use the commands:

```
awplus# configure terminal
awplus(config)# access-list hardware my-list
awplus(config-ip-hw-acl)# 100 permit icmp 192.168.1.0/24 any
icmp-type 5
```

To remove an access-list filter entry with a sequence number of 100 from the access-list named "my-list", use the commands:

```
awplus# configure terminal
awplus(config)# access-list hardware my-list
awplus(config-ip-hw-acl)# no 100
```

**Related commands**

- [access-group](#)
- [access-list hardware \(named hardware ACL\)](#)
- [match access-group](#)
- [show running-config](#)
- [show access-list \(IPv4 Hardware ACLs\)](#)

**Command changes** Version 5.4.6-2.1: **send-to-vlan-port** action parameter added

## (named hardware ACL entry for IP packets)

**Overview** Use this command to add an IP packet filter entry to the current hardware access-list. The filter will match on IP packets that have the specified IP and/or MAC addresses. You can use the value **any** instead of source or destination IP or MAC address if an address does not matter.

If you specify a sequence number, the switch inserts the new filter at the specified location. Otherwise, the switch adds the new filter to the end of the access-list.

The **no** variant of this command removes a filter entry from the current hardware access-list. You can specify the filter entry for removal by entering either its sequence number (e.g. **no 100**), or by entering its filter profile without specifying its sequence number (e.g. **no deny ip 192.168.0.0/16 any**).

You can find the sequence number by running the [show access-list \(IPv4 Hardware ACLs\)](#) command.

Hardware ACLs will **permit** access unless **explicitly denied** by an ACL action.

**CAUTION:** Specifying a "send" action enables you to use ACLs to redirect packets from their original destination. Use such ACLs with caution. They could prevent control packets from reaching the correct destination, such as EPSR healthcheck messages and AMF messages.

**Syntax** [`<sequence-number>`] `<action>` ip `<source-ip>` `<dest-ip>`  
[`<source-mac>` `<dest-mac>`] [`vlan <1-4094>`]  
  
no `<sequence-number>`  
  
no `<action>` ip `<source-ip>` `<dest-ip>` [`<source-mac>` `<dest-mac>`]  
[`vlan <1-4094>`]

The following actions are available for hardware ACLs:

Values for the <code>&lt;action&gt;</code> parameter	
deny	Reject packets that match the source and destination filtering specified with this command.
permit	Permit packets that match the source and destination filtering specified with this command.
copy-to-cpu	Send a copy of matching packets to the CPU.
copy-to-mirror	Send a copy of matching packets to the mirror port. Use the <b>mirror interface</b> command to configure the mirror port.
send-to-mirror	Send matching packets to the mirror port. Use the <b>mirror interface</b> command to configure the mirror port.
send-to-vlan-port vlan <code>&lt;vid&gt;</code> port <code>&lt;port-number&gt;</code>	Send matching packets to the specified port, tagged with the specified VLAN. The specified port must belong to the specified VLAN.
send-to-cpu	Send matching packets to the CPU.

Parameter	Description
<i>&lt;sequence-number&gt;</i>	The sequence number for the filter entry of the selected access control list, in the range 1-65535. If you do not specify a sequence number, the switch puts the entry at the end of the ACL and assigns it the next available multiple of 10 as its sequence number. .
<i>&lt;action&gt;</i>	The action that the switch will take on matching packets. See the table above for valid values.
ip	Match against IP packets
<i>&lt;source-ip&gt;</i>	The source addresses to match against. You can specify a single host, a subnet, or all source addresses. The following are the valid formats for specifying the source:
any	Match any source IP address.
dhcp snooping	Match the source address learned from the DHCP Snooping binding database.
host <i>&lt;ip-addr&gt;</i>	Match a single source host with the IP address given by <i>&lt;ip-addr&gt;</i> in dotted decimal notation.
<i>&lt;ip-addr&gt;/&lt;prefix&gt;</i>	Match any source IP address within the specified subnet. Specify the subnet by entering the IPv4 address, then a forward slash, then the prefix length.
<i>&lt;ip-addr&gt;</i> <i>&lt;reverse-mask&gt;</i>	Match any source IP address within the specified subnet. Specify the subnet by entering a reverse mask in dotted decimal format. For example, entering "192.168.1.1 0.0.0.255" is the same as entering 192.168.1.1/24.
<i>&lt;dest-ip&gt;</i>	The destination addresses to match against. You can specify a single host, a subnet, or all destination addresses. The following are the valid formats for specifying the destination:
any	Match any destination IP address.
host <i>&lt;ip-addr&gt;</i>	Match a single destination host with the IP address given by <i>&lt;ip-addr&gt;</i> in dotted decimal notation.
<i>&lt;ip-addr&gt;/&lt;prefix&gt;</i>	Match any destination IP address within the specified subnet. Specify the subnet by entering the IPv4 address, then a forward slash, then the prefix length.



Parameter	Description
	<p><i>&lt;ip-addr&gt;</i> <i>&lt;reverse-mask&gt;</i></p> <p>Match any destination IP address within the specified subnet. Specify the subnet by entering a reverse mask in dotted decimal format. For example, entering "192.168.1.1 0.0.0.255" is the same as entering 192.168.1.1/24.</p>
<i>&lt;source-mac&gt;</i>	<p>The source MAC address to match against. You can specify a single MAC address, a range (through a mask), the address learned from DHCP snooping, or any:</p>
any	Match against any source MAC address.
<i>&lt;source-mac&gt;</i>	<p>The source MAC address to match against, followed by the mask. Enter the address in the format &lt;HHHH.HHHH.HHHH&gt;, where each <i>H</i> is a hexadecimal number. Enter the mask in the format &lt;HHHH.HHHH.HHHH&gt;, where each <i>H</i> is a hexadecimal number. For a mask, each value is either 0 or F, where FF = Ignore, and 00 = Match.</p>
dhcp snooping	Match the source address learned from the DHCP Snooping binding database.
<i>&lt;dest-mac&gt;</i>	<p>The destination MAC address to match against. You can specify a single MAC address, a range (through a mask), or any:</p>
any	Match against any destination MAC address.
<i>&lt;dest-mac&gt;</i>	<p>The destination MAC address to match against, followed by the mask. Enter the address in the format &lt;HHHH.HHHH.HHHH&gt;, where each <i>H</i> is a hexadecimal number. Enter the mask in the format &lt;HHHH.HHHH.HHHH&gt;, where each <i>H</i> is a hexadecimal number. For a mask, each value is either 0 or F, where FF = Ignore, and 00 = Match.</p>
vlan <i>&lt;1-4094&gt;</i>	The VLAN to match against. The ACL will match against the specified ID in the packet's VLAN tag.

**Mode** IPv4 Hardware ACL Configuration (accessed by running the command [access-list hardware \(named hardware ACL\)](#))

**Default** On an interface controlled by a hardware ACL, any traffic that does not explicitly match a filter is permitted.

**Usage notes** To use this command, first run the command [access-list hardware \(named hardware ACL\)](#) and enter the desired access-list name. This changes the prompt to `awplus(config-ip-hw-acl)#`.

Then use this command (and the other “named hardware ACL: entry” commands) to add filter entries. You can add multiple filter entries to an ACL. You can insert a new filter entry into the middle of an existing list by specifying the appropriate sequence number. If you do not specify a sequence number, the switch puts the entry at the end of the ACL and assigns it the next available multiple of 10 as its sequence number.

Then use the [access-group](#) or the [match access-group](#) command to apply this ACL to a port, VLAN or QoS class-map. Note that the ACL will only apply to incoming data packets.

**Examples** To add a filter entry to the access-list named “my-list” that will permit any IP packet with a source address of 192.168.1.1, use the commands:

```
awplus# configure terminal
awplus(config)# access-list hardware my-list
awplus(config-ip-hw-acl)# permit ip 192.168.1.1/32 any
```

To add a filter entry to the access-list named “my-list” that will permit any IP packet with a source address of 192.168.1.1 and a MAC source address of ffee.ddcc.bbaa, use the commands:

```
awplus# configure terminal
awplus(config)# access-list hardware my-list
awplus(config-ip-hw-acl)# permit ip 192.168.1.1/32 any mac
ffee.ddcc.bbaa 0000.0000.0000 any
```

To add a filter entry to the access-list named “my-list” that will deny all IP packets on vlan 2, use the commands:

```
awplus# enable
awplus(config)# configure terminal
awplus(config)# access-list hardware my-list
awplus(config-ip-hw-acl)# deny ip any any vlan 2
```

**Related commands**

[access-group](#)  
[access-list hardware \(named hardware ACL\)](#)  
[match access-group](#)  
[show running-config](#)  
[show access-list \(IPv4 Hardware ACLs\)](#)

**Command changes**

Version 5.4.6-2.1: **send-to-vlan-port** action parameter added

# (named hardware ACL entry for IP protocols)

**Overview** Use this command to add an IP protocol type filter entry to the current hardware access-list. The filter will match on IP packets that have the specified IP protocol number, and the specified IP and/or MAC addresses. You can use the value **any** instead of source or destination IP or MAC address if an address does not matter.

If you specify a sequence number, the switch inserts the new filter at the specified location. Otherwise, the switch adds the new filter to the end of the access-list.

The **no** variant of this command removes a filter entry from the current hardware access-list. You can specify the filter entry for removal by entering either its sequence number (e.g. **no 100**), or by entering its filter profile without specifying its sequence number (e.g. **no deny proto 2 192.168.0.0/16 any**).

You can find the sequence number by running the [show access-list \(IPv4 Hardware ACLs\)](#) command.

Hardware ACLs will **permit** access unless **explicitly denied** by an ACL action.

**CAUTION:** Specifying a "send" action enables you to use ACLs to redirect packets from their original destination. Use such ACLs with caution. They could prevent control packets from reaching the correct destination, such as EPSR healthcheck messages and AMF messages.

**Syntax** [`<sequence-number>`] `<action>` proto `<1-255>` `<source-ip>`  
`<dest-ip>` [`<source-mac>` `<dest-mac>`] [`vlan <1-4094>`]  
`no <sequence-number>`  
`no <action>` proto `<1-255>` `<source-ip>` `<dest-ip>` [`<source-mac>`  
`<dest-mac>`] [`vlan <1-4094>`]

The following actions are available for hardware ACLs:

Values for the <code>&lt;action&gt;</code> parameter	
deny	Reject packets that match the source and destination filtering specified with this command.
permit	Permit packets that match the source and destination filtering specified with this command.
copy-to-cpu	Send a copy of matching packets to the CPU.
copy-to-mirror	Send a copy of matching packets to the mirror port. Use the <b>mirror interface</b> command to configure the mirror port.
send-to-mirror	Send matching packets to the mirror port. Use the <b>mirror interface</b> command to configure the mirror port.
send-to-vlan-port vlan <code>&lt;vid&gt;</code> port <code>&lt;port-number&gt;</code>	Send matching packets to the specified port, tagged with the specified VLAN. The specified port must belong to the specified VLAN.
send-to-cpu	Send matching packets to the CPU.

Table 26-5: Parameters in IP protocol ACL entries

Parameter	Description
<code>&lt;sequence-number&gt;</code>	The sequence number for the filter entry of the selected access control list, in the range 1-65535. If you do not specify a sequence number, the switch puts the entry at the end of the ACL and assigns it the next available multiple of 10 as its sequence number. .
<code>&lt;action&gt;</code>	The action that the switch will take on matching packets. See the table above for valid values.
<code>proto &lt;1-255&gt;</code>	The IP protocol number to match against, as defined by IANA (Internet Assigned Numbers Authority <a href="http://www.iana.org/assignments/protocol-numbers">www.iana.org/assignments/protocol-numbers</a> ) See below for a list of IP protocol numbers and their descriptions.
<code>&lt;source-ip&gt;</code>	The source addresses to match against. You can specify a single host, a subnet, or all source addresses. The following are the valid formats for specifying the source:
<code>any</code>	Match any source IP address.
<code>dhcpsnooping</code>	Match the source address learned from the DHCP Snooping binding database.
<code>host &lt;ip-addr&gt;</code>	Match a single source host with the IP address given by <code>&lt;ip-addr&gt;</code> in dotted decimal notation.
<code>&lt;ip-addr&gt;/&lt;prefix&gt;</code>	Match any source IP address within the specified subnet. Specify the subnet by entering the IPv4 address, then a forward slash, then the prefix length.
<code>&lt;ip-addr&gt; &lt;reverse-mask&gt;</code>	Match any source IP address within the specified subnet. Specify the subnet by entering a reverse mask in dotted decimal format. For example, entering "192.168.1.1 0.0.0.255" is the same as entering 192.168.1.1/24.
<code>&lt;dest-ip&gt;</code>	The destination addresses to match against. You can specify a single host, a subnet, or all destination addresses. The following are the valid formats for specifying the destination:
<code>any</code>	Match any destination IP address.
<code>host &lt;ip-addr&gt;</code>	Match a single destination host with the IP address given by <code>&lt;ip-addr&gt;</code> in dotted decimal notation.
<code>&lt;ip-addr&gt;/&lt;prefix&gt;</code>	Match any destination IP address within the specified subnet. Specify the subnet by entering the IPv4 address, then a forward slash, then the prefix length.

Table 26-5: Parameters in IP protocol ACL entries (cont.)

Parameter	Description
<i>&lt;ip-addr&gt;</i> <i>&lt;reverse-mask&gt;</i>	Match any destination IP address within the specified subnet. Specify the subnet by entering a reverse mask in dotted decimal format. For example, entering "192.168.1.1 0.0.0.255" is the same as entering 192.168.1.1/24.
<i>&lt;source-mac&gt;</i>	The source MAC address to match against. You can specify a single MAC address, a range (through a mask), the address learned from DHCP snooping, or any:
any	Match against any source MAC address.
<i>&lt;source-mac&gt;</i>	The source MAC address to match against, followed by the mask. Enter the address in the format <HHHH.HHHH.HHHH>, where each <i>H</i> is a hexadecimal number. Enter the mask in the format <HHHH.HHHH.HHHH>, where each <i>H</i> is a hexadecimal number. For a mask, each value is either 0 or F, where FF = Ignore, and 00 = Match.
dhcpsnooping	Match the source address learned from the DHCP Snooping binding database.
<i>&lt;dest-mac&gt;</i>	The destination MAC address to match against. You can specify a single MAC address, a range (through a mask), or any:
any	Match against any destination MAC address.
<i>&lt;dest-mac&gt;</i>	The destination MAC address to match against, followed by the mask. Enter the address in the format <HHHH.HHHH.HHHH>, where each <i>H</i> is a hexadecimal number. Enter the mask in the format <HHHH.HHHH.HHHH>, where each <i>H</i> is a hexadecimal number. For a mask, each value is either 0 or F, where FF = Ignore, and 00 = Match.
vlan <i>&lt;1-4094&gt;</i>	The VLAN to match against. The ACL will match against the specified ID in the packet's VLAN tag.

Table 26-6: IP protocol number and description

Protocol Number	Protocol Description [RFC]
1	Internet Control Message [RFC792]
2	Internet Group Management [RFC1112]
3	Gateway-to-Gateway [RFC823]
4	IP in IP [RFC2003]
5	Stream [RFC1190] [RFC1819]
6	TCP (Transmission Control Protocol) [RFC793]
8	EGP (Exterior Gateway Protocol) [RFC888]
9	IGP (Interior Gateway Protocol) [IANA]
11	Network Voice Protocol [RFC741]
17	UDP (User Datagram Protocol) [RFC768]
20	Host monitoring [RFC869]
27	RDP (Reliable Data Protocol) [RFC908]
28	IRTP (Internet Reliable Transaction Protocol) [RFC938]
29	ISO-TP4 (ISO Transport Protocol Class 4) [RFC905]
30	Bulk Data Transfer Protocol [RFC969]
33	DCCP (Datagram Congestion Control Protocol) [RFC4340]
48	DSR (Dynamic Source Routing Protocol) [RFC4728]
50	ESP (Encap Security Payload) [RFC2406]
51	AH (Authentication Header) [RFC2402]
54	NARP (NBMA Address Resolution Protocol) [RFC1735]
58	ICMP for IPv6 [RFC1883]
59	No Next Header for IPv6 [RFC1883]
60	Destination Options for IPv6 [RFC1883]
88	EIGRP (Enhanced Interior Gateway Routing Protocol)
89	OSPFv2 [RFC1583]
97	Ethernet-within-IP Encapsulation / RFC3378
98	Encapsulation Header / RFC1241
108	IP Payload Compression Protocol / RFC2393
112	Virtual Router Redundancy Protocol / RFC3768
134	RSVP-E2E-IGNORE / RFC3175
135	Mobility Header / RFC3775
136	UDPLite / RFC3828

Table 26-6: IP protocol number and description (cont.)

Protocol Number	Protocol Description [RFC]
137	MPLS-in-IP / RFC4023
138	MANET Protocols / RFC-ietf-manet-iana-07.txt
139-252	Unassigned / IANA
253	Use for experimentation and testing / RFC3692
254	Use for experimentation and testing / RFC3692
255	Reserved / IANA

**Mode** IPv4 Hardware ACL Configuration (accessed by running the command `access-list hardware (named hardware ACL)`)

**Default** On an interface controlled by a hardware ACL, any traffic that does not explicitly match a filter is permitted.

**Usage notes** To use this command, run the command `access-list hardware (named hardware ACL)` and enter the desired access-list name. This changes the prompt to `awplus(config-ip-hw-acl)#`.

Then use this command (and the other “named hardware ACL: entry” commands) to add filter entries. You can add multiple filter entries to an ACL. You can insert a new filter entry into the middle of an existing list by specifying the appropriate sequence number. If you do not specify a sequence number, the switch puts the entry at the end of the ACL and assigns it the next available multiple of 10 as its sequence number.

Then use the `access-group` or the `match access-group` command to apply this ACL to a port, VLAN or QoS class-map. Note that the ACL will only apply to incoming data packets.

**Examples** To add a filter entry to the access-list named “my-list” that will deny all IGMP packets (protocol 2) from the 192.168.0.0 subnet, and give it a sequence number of 50, use the commands:

```
awplus# configure terminal
awplus(config)# access-list hardware my-list
awplus(config-ip-hw-acl)# 50 deny proto 2 192.168.0.0/16 any
```

**Related commands**

- `access-group`
- `access-list hardware (named hardware ACL)`
- `match access-group`
- `show running-config`
- `show access-list (IPv4 Hardware ACLs)`

**Command changes** Version 5.4.6-2.1: **send-to-vlan-port** action parameter added

# (named hardware ACL entry for MAC addresses)

**Overview** Use this command to add a MAC address filter entry to the current hardware access-list. The access-list will match on packets that have the specified source and destination MAC addresses. You can use the value **any** instead of source or destination MAC address if an address does not matter.

If you specify a sequence number, the switch inserts the new filter at the specified location. Otherwise, the switch adds the new filter to the end of the access-list.

The **no** variant of this command removes a filter entry from the current hardware access-list. You can specify the filter entry for removal by entering either its sequence number (e.g. **no 100**), or by entering its filter profile without specifying its sequence number (e.g. **no permit mac aaaa.bbbb.cccc 0000.0000.0000 any**).

You can find the sequence number by running the [show access-list \(IPv4 Hardware ACLs\)](#) command.

Hardware ACLs will **permit** access unless **explicitly denied** by an ACL action.

**CAUTION:** Specifying a “send” action enables you to use ACLs to redirect packets from their original destination. Use such ACLs with caution. They could prevent control packets from reaching the correct destination, such as EPSR healthcheck messages and AMF messages.

**Syntax** [`<sequence-number>`] `<action>` mac {`<source-mac>`|any} {`<dest-mac>`|any} [vlan `<1-4094>`]

`no <sequence-number>`

`no <action>` mac {`<source-mac>`|any} {`<dest-mac>`|any} [vlan `<1-4094>`]

The following actions are available for hardware ACLs:

Values for the <code>&lt;action&gt;</code> parameter	
deny	Reject packets that match the source and destination filtering specified with this command.
permit	Permit packets that match the source and destination filtering specified with this command.
copy-to-cpu	Send a copy of matching packets to the CPU.
copy-to-mirror	Send a copy of matching packets to the mirror port. Use the <b>mirror interface</b> command to configure the mirror port.
send-to-mirror	Send matching packets to the mirror port. Use the <b>mirror interface</b> command to configure the mirror port.



Values for the <action> parameter	
send-to-vlan-port vlan <vid> port <port-number>	Send matching packets to the specified port, tagged with the specified VLAN. The specified port must belong to the specified VLAN.
send-to-cpu	Send matching packets to the CPU.

Parameter	Description
<4000-4699>	Hardware MAC access-list.
<action>	The action that the switch will take on matching packets. See the table above for valid values.
mac	Match against MAC address
<source-mac>	The source MAC address to match against, followed by the mask. Enter the address in the format <HHHH.HHHH.HHHH>, where each <i>H</i> is a hexadecimal number. Enter the mask in the format <HHHH.HHHH.HHHH>, where each <i>H</i> is a hexadecimal number. For a mask, each value is either 0 or F, where FF = Ignore, and 00 = Match.
any	Match against any source MAC address.
<dest-mac>	The destination MAC address to match against, followed by the mask. Enter the address in the format <HHHH.HHHH.HHHH>, where each <i>H</i> is a hexadecimal number. Enter the mask in the format <HHHH.HHHH.HHHH>, where each <i>H</i> is a hexadecimal number. For a mask, each value is either 0 or F, where FF = Ignore, and 00 = Match.
any	Match against any destination MAC address.
vlan <1-4094>	Match against the specified ID in the packet's VLAN tag.

**Mode** IPv4 Hardware ACL Configuration (accessed by running the command [access-list hardware \(named hardware ACL\)](#))

**Default** On an interface controlled by a hardware ACL, any traffic that does not explicitly match a filter is permitted.

**Usage notes** To use this command, first run the command [access-list hardware \(named hardware ACL\)](#) and enter the desired access-list name. This changes the prompt to `awplus(config-ip-hw-acl)#`.

Then use this command (and the other “named hardware ACL: entry” commands) to add filter entries. You can add multiple filter entries to an ACL. You can insert a new filter entry into the middle of an existing list by specifying the appropriate sequence number. If you do not specify a sequence number, the switch puts the entry at the end of the ACL and assigns it the next available multiple of 10 as its sequence number.

Then use the [access-group](#) or the [match access-group](#) command to apply this ACL to a port, VLAN or QoS class-map. Note that the ACL will only apply to incoming data packets.

**Examples** To add a filter entry to the access-list named "my-list" that will permit packets with a source MAC address of 0000.00ab.1234 and any destination MAC address, use the commands:

```
awplus# configure terminal
awplus(config)# access-list hardware my-list
awplus(config-ip-hw-acl)# permit mac 0000.00ab.1234
0000.0000.0000 any
```

To remove a filter entry that permit packets with a source MAC address of 0000.00ab.1234 and any destination MAC address, use the commands:

```
awplus# configure terminal
awplus(config)# access-list hardware my-list
awplus(config-ip-hw-acl)# no permit mac 0000.00ab.1234
0000.0000.0000 any
```

**Related commands**

- [access-group](#)
- [access-list hardware \(named hardware ACL\)](#)
- [match access-group](#)
- [show running-config](#)
- [show access-list \(IPv4 Hardware ACLs\)](#)

**Command changes** Version 5.4.7-2.1: **send-to-vlan-port** action parameter added to GS900MX, SBx8100, SBx908 GEN2, XS900MX series.

Version 5.4.6-2.1: **send-to-vlan-port** action parameter added

# (named hardware ACL entry for TCP or UDP)

**Overview** Use this command to add a TCP or UDP filter entry to the current hardware access-list. The access-list will match on TCP or UDP packets that have the specified source and destination IP addresses and optionally, port values. You can use the value **any** instead of source or destination IP address if an address does not matter.

If you specify a sequence number, the switch inserts the new filter at the specified location. Otherwise, the switch adds the new filter to the end of the access-list.

The **no** variant of this command removes a filter entry from the current hardware access-list. You can specify the filter entry for removal by entering either its sequence number (e.g. **no 100**), or by entering its filter profile without specifying its sequence number (e.g. **no permit udp 192.168.0.0/16 any**).

You can find the sequence number by running the [show access-list \(IPv4 Hardware ACLs\)](#) command.

Hardware ACLs will **permit** access unless **explicitly denied** by an ACL action.

**CAUTION:** Specifying a "send" action enables you to use ACLs to redirect packets from their original destination. Use such ACLs with caution. They could prevent control packets from reaching the correct destination, such as EPSR healthcheck messages and AMF messages.

**Syntax** [`<sequence-number>`] `<action>` {`tcp|udp`} `<source-ip>`  
[`<source-ports>`] `<dest-ip>` [`<dest-ports>`] [`vlan <1-4094>`]  
`no <sequence-number>`  
`no <action>` {`tcp|udp`} `<source-ip>` [`<source-ports>`] `<dest-ip>`  
[`<dest-ports>`] [`vlan <1-4094>`]

The following actions are available for hardware ACLs:

Values for the <code>&lt;action&gt;</code> parameter	
<code>deny</code>	Reject packets that match the source and destination filtering specified with this command.
<code>permit</code>	Permit packets that match the source and destination filtering specified with this command.
<code>copy-to-cpu</code>	Send a copy of matching packets to the CPU.
<code>copy-to-mirror</code>	Send a copy of matching packets to the mirror port. Use the <b>mirror interface</b> command to configure the mirror port.
<code>send-to-mirror</code>	Send matching packets to the mirror port. Use the <b>mirror interface</b> command to configure the mirror port.
<code>send-to-vlan-port</code> <code>vlan &lt;vid&gt; port</code> <code>&lt;port-number&gt;</code>	Send matching packets to the specified port, tagged with the specified VLAN. The specified port must belong to the specified VLAN.
<code>send-to-cpu</code>	Send matching packets to the CPU.

Parameter	Description
<code>&lt;sequence-number&gt;</code>	The sequence number for the filter entry of the selected access control list, in the range 1-65535. If you do not specify a sequence number, the switch puts the entry at the end of the ACL and assigns it the next available multiple of 10 as its sequence number. .
<code>&lt;action&gt;</code>	The action that the switch will take on matching packets. See the table above for valid values.
tcp	Match against TCP packets.
udp	Match against UDP packets.
<code>&lt;source-ip&gt;</code>	The source addresses to match against. You can specify a single host, a subnet, or all source addresses. The following are the valid formats for specifying the source:
any	Match any source IP address.
host <code>&lt;ip-addr&gt;</code>	Match a single source host with the IP address given by <code>&lt;ip-addr&gt;</code> in dotted decimal notation.
<code>&lt;ip-addr&gt;/&lt;prefix&gt;</code>	Match any source IP address within the specified subnet. Specify the subnet by entering the IPv4 address, then a forward slash, then the prefix length.
<code>&lt;ip-addr&gt;</code> <code>&lt;reverse-mask&gt;</code>	Match any source IP address within the specified subnet. Specify the subnet by entering a reverse mask in dotted decimal format. For example, entering "192.168.1.1 0.0.0.255" is the same as entering 192.168.1.1/24.
<code>&lt;source-ports&gt;</code>	Match source TCP or UDP port numbers. Port numbers are specified as integers between 0 and 65535. You can specify one or more port numbers as follows:
eq <code>&lt;0-65535&gt;</code>	Match a single port number.
lt <code>&lt;0-65535&gt;</code>	Match all port numbers that are less than the specified port number.
gt <code>&lt;0-65535&gt;</code>	Match all port numbers that are greater than the specified port number.
ne <code>&lt;0-65535&gt;</code>	Match all port numbers except the specified port number.
range <code>&lt;start-port&gt;</code> <code>&lt;end-port&gt;</code>	Match a range of port numbers.
<code>&lt;dest-ip&gt;</code>	The destination addresses to match against. You can specify a single host, a subnet, or all destination addresses. The following are the valid formats for specifying the destination:

Parameter	Description
<code>any</code>	Match any destination IP address.
<code>host &lt;ip-addr&gt;</code>	Match a single destination host with the IP address given by <code>&lt;ip-addr&gt;</code> in dotted decimal notation.
<code>&lt;ip-addr&gt;/&lt;prefix&gt;</code>	Match any destination IP address within the specified subnet. Specify the subnet by entering the IPv4 address, then a forward slash, then the prefix length.
<code>&lt;ip-addr&gt; &lt;reverse-mask&gt;</code>	Match any destination IP address within the specified subnet. Specify the subnet by entering a reverse mask in dotted decimal format. For example, entering "192.168.1.1 0.0.0.255" is the same as entering 192.168.1.1/24.
<code>&lt;dest-ports&gt;</code>	Match destination TCP or UDP port numbers. Port numbers are specified as integers between 0 and 65535. You can specify one or more port numbers as follows:
<code>eq &lt;0-65535&gt;</code>	Match a single port number.
<code>lt &lt;0-65535&gt;</code>	Match all port numbers that are less than the specified port number.
<code>gt &lt;0-65535&gt;</code>	Match all port numbers that are greater than the specified port number.
<code>ne &lt;0-65535&gt;</code>	Match all port numbers except the specified port number.
<code>range &lt;start-port&gt; &lt;end-port&gt;</code>	Match a range of port numbers.
<code>vlan &lt;1-4094&gt;</code>	The VLAN to match against. The ACL will match against the specified ID in the packet's VLAN tag.

**Mode** IPv4 Hardware ACL Configuration (accessed by running the command `access-list hardware (named hardware ACL)`)

**Default** On an interface controlled by a hardware ACL, any traffic that does not explicitly match a filter is permitted.

**Usage notes** To use this command, first run the command `access-list hardware (named hardware ACL)` and enter the desired access-list name. This changes the prompt to `awplus(config-ip-hw-acl)#`.

Then use this command (and the other "named hardware ACL: entry" commands) to add filter entries. You can add multiple filter entries to an ACL. You can insert a new filter entry into the middle of an existing list by specifying the appropriate sequence number. If you do not specify a sequence number, the switch puts the

entry at the end of the ACL and assigns it the next available multiple of 10 as its sequence number.

Then use the [access-group](#) or the [match access-group](#) command to apply this ACL to a port, VLAN or QoS class-map. Note that the ACL will only apply to incoming data packets.

**Example** To add a filter entry to access-list named "my-list" that will permit TCP packets with a destination address of 192.168.1.1, a destination port of 80, from any source, use the commands:

```
awplus# configure terminal
awplus(config)# access-list hardware my-list
awplus(config-ip-hw-acl)# permit tcp any 192.168.1.1/32 eq 80
```

**Related  
commands**

[access-group](#)  
[access-list hardware \(named hardware ACL\)](#)  
[match access-group](#)  
[show running-config](#)  
[show access-list \(IPv4 Hardware ACLs\)](#)

**Command  
changes**

Version 5.4.6-2.1: **send-to-vlan-port** action parameter added

## commit (IPv4)

**Overview** Use this command to commit the IPv4 ACL filter configuration entered at the console to the hardware immediately without exiting the IPv4 Hardware ACL Configuration mode.

This command forces the associated hardware and software IPv4 ACLs to synchronize.

**Syntax** `commit`

**Mode** IPv4 Hardware ACL Configuration

**Usage notes** Normally, when an IPv4 hardware ACL is edited, the new configuration state of the IPv4 ACL is not written to hardware until you exit IPv4 Hardware ACL Configuration mode. By entering this command you can ensure that the current state of a hardware access-list that is being edited is written to hardware immediately.

Scripts typically do not include the `exit` command to exit configuration modes, potentially leading to IPv4 ACL filters in hardware not being correctly updated. Using this **commit** command in a configuration script after specifying an IPv4 hardware ACL filter ensures that it is updated in the hardware immediately.

**Example** To update the hardware with the IPv4 ACL filter configuration, use the command:

```
awplus# configure terminal
awplus(config)# access-list hardware my-hw-list
awplus(config-ip-hw-acl)# commit
```

**Related commands** [access-list hardware \(named hardware ACL\)](#)

# show access-group

**Overview** Use this command to show the access-lists attached globally. If an access-list is specified, only that access-list will be displayed.

**Syntax** `show access-group`  
`[ { <3000-3699> | <4000-4699> | <access-list-name> } ]`

Parameter	Description
<3000-3699>	Specify a Hardware IP access-list.
<4000-4699>	Specify a Hardware MAC access-list.
<access-list-name>	Specify a Hardware IPv4 access-list name.

**Mode** User Exec and Privileged Exec

**Example** To show all access-lists attached globally:

```
awplus# show access-group
```

**Output** Figure 26-1: Example output from the show access-group command

```
Global access control list
access-group 3000
access-group 4000
```

**Related commands** [access-group](#)  
[show interface access-group](#)



# show access-list (IPv4 Hardware ACLs)

**Overview** Use this command to display the specified access-list, or all access-lists if none have been specified. Note that only defined access-lists are displayed. An error message is displayed for an undefined access-list.

**Syntax** `show access-list`  
[<1-99> | <100-199> | <1300-1999> | <2000-2699> | <3000-3699> | <4000-4499> | <access-list-name>]

Parameter	Description
<1-99>	IP standard access-list.
<1300-1999>	IP standard access-list (standard - expanded range).
<3000-3699>	Hardware IP access-list.
<4000-4499>	Hardware MAC access-list.
<access-list-name>	IP named access-list.

**Mode** User Exec and Privileged Exec

**Examples** To show all access-lists configured on the switch:

```
awplus# show access-list
```

```
Standard IP access list 1
  deny 172.16.2.0, wildcard bits 0.0.0.255
Standard IP access list 20
  deny 192.168.10.0, wildcard bits 0.0.0.255
  deny 192.168.12.0, wildcard bits 0.0.0.255
Hardware IP access list 3001
  permit ip 192.168.20.0 255.255.255.0 any
Hardware IP access list 3020
  permit tcp any 192.0.2.0/24
awplus#show access-list 20
```

To show the access-list with an ID of 20:

```
awplus# show access-list 20
```

```
Standard IP access-list 20
  deny 192.168.10.0, wildcard bits 0.0.0.255
  deny 192.168.12.0, wildcard bits 0.0.0.255
```

The following error message is displayed if you try to show an undefined access-list.

```
awplus# show access-list 2
```

```
% Can't find access-list 2
```

**Related  
commands**

[access-list extended \(named\)](#)

[access-list \(numbered hardware ACL for MAC addresses\)](#)

[access-list hardware \(named hardware ACL\)](#)

# show interface access-group

**Overview** Use this command to display the access groups attached to a port. If an access group is specified, then the output only includes the ports that the specified access group is attached to. If no access group is specified then this command displays all access groups that are attached to the ports that are specified with <port-list>.

Note that **access group** is the term given for an access-list when it is applied to an interface.

**Syntax** `show interface <port-list> access-group  
[ <3000-3699> | <4000-4699> ]`

Parameter	Description
<port-list>	Specify the ports to display information. A port-list can be either: <ul style="list-style-type: none"><li>• a switch port (e.g. port1.0.6) a static channel group (e.g. sa2) or a dynamic (LACP) channel group (e.g. po2)</li><li>• a continuous range of ports separated by a hyphen, e.g. port1.0.1-1.0.6 or port1.0.1-port1.0.6 or po1-po2</li><li>• a comma-separated list of ports and port ranges, e.g. port1.0.1,port1.0.3-1.0.6. Do not mix switch ports, static channel groups, and LACP channel groups in the same list.</li></ul>
access group	Select the access group whose details you want to show.
<3000-3699>	Specifies the Hardware IP access-list.
<4000-4699>	Specifies the Hardware MAC access-list.

**Mode** User Exec and Privileged Exec

**Example** To show all access-lists attached to port1.0.1, use the command:

```
awplus# show interface port1.0.1 access-group
```

**Output** Figure 26-2: Example output from the **show interface access-group** command

```
Interface port1.0.1  
  access-group 3000  
  access-group 3002  
  access-group 3001
```

**Related commands** [access-group](#)

# 27

# IPv4 Software Access Control List (ACL) Commands

## Introduction

**Overview** This chapter provides an alphabetical reference for the IPv4 Software Access Control List (ACL) commands, and contains detailed command information and command examples about IPv4 software ACLs as applied to Routing and Multicasting, which are not applied to interfaces.

For information about ACLs, see the [ACL Feature Overview and Configuration Guide](#).

To apply ACLs to an LACP channel group, apply it to all the individual switch ports in the channel group. To apply ACLs to a static channel group, apply it to the static channel group itself. For more information on link aggregation see the following references:

- the [Link Aggregation Feature Overview\\_and Configuration Guide](#).
- [Link Aggregation Commands](#)

**NOTE:** Text in parenthesis in command names indicates usage not keyword entry. For example, **access-list hardware (named)** indicates named IPv4 hardware ACLs entered as `access-list hardware <name>` where <name> is a placeholder not a keyword.

Parenthesis surrounding ACL filters indicates the type of ACL filter not the keyword entry in the CLI, such as **(access-list standard numbered filter)** represents command entry in the format shown in the syntax:

```
[<sequence-number>] {deny|permit} {<source-address>|host  
<host-address>|any}
```

**NOTE:** Software ACLs will **deny** access unless **explicitly permitted** by an ACL action.

**Sub-modes** Many of the ACL commands operate from sub-modes that are specific to particular ACL types. The following table shows the CLI prompts at which ACL commands are entered.

Table 27-1: IPv4 Software Access List Commands and Prompts

Command Name	Command Mode	Prompt
show ip access-list	Privileged Exec	awplus#
access-group	Global Configuration	awplus(config)#
access-list (extended named)	Global Configuration	awplus(config)#
access-list (extended numbered)	Global Configuration	awplus(config)#
access-list (standard named)	Global Configuration	awplus(config)#
access-list (standard numbered)	Global Configuration	awplus(config)#
maximum-access-list	Global Configuration	awplus(config)#
(access-list extended ICMP filter)	IPv4 Extended ACL Configuration	awplus(config-ip-ext-acl)#
(access-list extended IPfilter)	IPv4 Extended ACL Configuration	awplus(config-ip-ext-acl)#
(access-list extended IP protocol filter)	IPv4 Extended ACL Configuration	awplus(config-ip-ext-acl)#
(access-list extended TCP UDP filter)	IPv4 Extended ACL Configuration	awplus(config-ip-ext-acl)#
(access-list standard named filter)	IPv4 Standard ACL Configuration	awplus(config-ip-std-acl)#
(access-list standard numbered filter)	IPv4 Standard ACL Configuration	awplus(config-ip-std-acl)#

- Command List**
- [“access-list extended \(named\)”](#) on page 935
  - [“access-list \(extended numbered\)”](#) on page 943
  - [“\(access-list extended ICMP filter\)”](#) on page 946
  - [“\(access-list extended IP filter\)”](#) on page 948
  - [“\(access-list extended IP protocol filter\)”](#) on page 951
  - [“\(access-list extended TCP UDP filter\)”](#) on page 955
  - [“access-list standard \(named\)”](#) on page 957
  - [“access-list \(standard numbered\)”](#) on page 959
  - [“\(access-list standard named filter\)”](#) on page 961
  - [“\(access-list standard numbered filter\)”](#) on page 963
  - [“dos”](#) on page 965
  - [“maximum-access-list”](#) on page 968
  - [“show access-list \(IPv4 Software ACLs\)”](#) on page 969
  - [“show dos interface”](#) on page 971

- [“show ip access-list”](#) on page 974
- [“vty access-class \(numbered\)”](#) on page 975

# access-list extended (named)

**Overview** This command configures an extended named access-list that permits or denies packets from specific source and destination IP addresses. You can either create an extended named ACL together with an ACL filter entry in the Global Configuration mode, or you can use the IPv4 Extended ACL Configuration mode for sequenced ACL filter entry after entering a list name.

The **no** variant of this command removes a specified extended named access-list.

**Syntax [list-name]**  
access-list extended <list-name>  
no access-list extended <list-name>

Parameter	Description
<list-name>	A user-defined name for the access-list

**Syntax [icmp]**  
access-list extended <list-name>{deny|permit} icmp <source>  
<destination> [icmp-type <type-number>] [log]  
no access-list extended <list-name>{deny|permit} icmp <source>  
<destination> [icmp-type <type-number>] [log]

Table 27-2: Parameters in the access-list extended (named) command - icmp

Parameter	Description
<list-name>	A user-defined name for the access-list.
deny	The access-list rejects packets that match the type, source, and destination filtering specified with this command.
permit	The access-list permits packets that match the type, source, and destination filtering specified with this command.
icmp	The access-list matches only ICMP packets.
icmp-type	Matches only a specified type of ICMP messages. This is valid only when the filtering is set to match ICMP packets.

Table 27-2: Parameters in the access-list extended (named) command - icmp

Parameter	Description
<i>&lt;source&gt;</i>	The source address of the packets. You can specify a single host, a subnet, or all sources. The following are the valid formats for specifying the source:
<i>any</i>	Matches any source IP address.
<i>host&lt;ip-addr&gt;</i>	Matches a single source host with the IP address given by <i>&lt;ip-addr&gt;</i> in dotted decimal notation.
<i>&lt;ip-addr&gt;/ &lt;prefix&gt;</i>	An IPv4 address, followed by a forward slash, then the prefix length. This matches any source IP address within the specified subnet.
<i>&lt;ip-addr&gt; &lt;reverse-mask&gt;</i>	Alternatively, you can enter a reverse mask in dotted decimal format. For example, entering 192.168.1.10.0.0.255 is the same as entering 192.168.1.1/24.
<i>&lt;destination&gt;</i>	The destination address of the packets. You can specify a single host, a subnet, or all destinations. The following are the valid formats for specifying the destination:
<i>any</i>	Matches any destination IP address.
<i>host&lt;ip-addr&gt;</i>	Matches a single destination host with the IP address given by <i>&lt;ip-addr&gt;</i> in dotted decimal notation.
<i>&lt;ip-addr&gt;/ &lt;prefix&gt;</i>	An IPv4 address, followed by a forward slash, then the prefix length. This matches any destination IP address within the specified subnet.
<i>&lt;ip-addr&gt; &lt;reverse-mask&gt;</i>	Alternatively, you can enter a reverse mask in dotted decimal format. For example, entering 192.168.1.10.0.0.255 is the same as entering 192.168.1.1/24.



Table 27-2: Parameters in the access-list extended (named) command - icmp

Parameter	Description
<type-number>	The ICMP type, as defined in RFC792 and RFC950. Specify one of the following integers to create a filter for the ICMP message type:
0	Echo replies.
3	Destination unreachable messages.
4	Source quench messages.
5	Redirect (change route) messages.
8	Echo requests.
11	Time exceeded messages.
12	Parameter problem messages.
13	Timestamp requests.
14	Timestamp replies.
15	Information requests.
16	Information replies.
17	Address mask requests.
18	Address mask replies.
log	Logs the results.

**Syntax [tcp|udp]**

```
access-list extended <list-name> {deny|permit} {tcp|udp}
<source> [eq <sourceport>|lt <sourceport>|gt <sourceport>|ne
<sourceport>] <destination> [eq <destport>|lt <destport>|gt
<destport>|ne <destport>] [log]
```

```
no access-list extended <list-name> {deny|permit} {tcp|udp}
<source> [eq <sourceport>|lt <sourceport>|gt <sourceport>|ne
<sourceport>] <destination> [eq <destport> |lt <destport>|gt
<destport>|ne <destport>][log]
```

Table 27-3: Parameters in the access-list extended (named) command - tcp|udp

Parameter	Description
<list-name>	A user-defined name for the access-list.
deny	The access-list rejects packets that match the type, source, and destination filtering specified with this command.
permit	The access-list permits packets that match the type, source, and destination filtering specified with this command.
tcp	The access-list matches only TCP packets.
udp	The access-list matches only UDP packets.

Table 27-3: Parameters in the access-list extended (named) command - tcp|udp

Parameter	Description
<i>&lt;source&gt;</i>	The source address of the packets. You can specify a single host, a subnet, or all sources. The following are the valid formats for specifying the source:
any	Matches any source IP address.
host<ip-addr>	Matches a single source host with the IP address given by <ip-addr> in dotted decimal notation.
<ip-addr>/ <prefix>	An IPv4 address, followed by a forward slash, then the prefix length. This matches any source IP address within the specified subnet.
<ip-addr> <reverse-mask>	Alternatively, you can enter a reverse mask in dotted decimal format. For example, entering 192.168.1.10.0.0.0.255 is the same as entering 192.168.1.1/24.
<i>&lt;destination&gt;</i>	The destination address of the packets. You can specify a single host, a subnet, or all destinations. The following are the valid formats for specifying the destination:
any	Matches any destination IP address.
host<ip-addr>	Matches a single destination host with the IP address given by <ip-addr> in dotted decimal notation.
<ip-addr>/ <prefix>	An IPv4 address, followed by a forward slash, then the prefix length. This matches any destination IP address within the specified subnet.
<ip-addr> <reverse-mask>	Alternatively, you can enter a reverse mask in dotted decimal format. For example, entering 192.168.1.10.0.0.0.255 is the same as entering 192.168.1.1/24.
<i>&lt;sourceport&gt;</i>	The source port number, specified as an integer between 0 and 65535.
<i>&lt;destport&gt;</i>	The destination port number, specified as an integer between 0 and 65535.
eq	Matches port numbers equal to the port number specified immediately after this parameter.
lt	Matches port numbers less than the port number specified immediately after this parameter.
gt	Matches port numbers greater than the port number specified immediately after this parameter.

Table 27-3: Parameters in the access-list extended (named) command - tcp|udp

Parameter	Description
ne	Matches port numbers not equal to the port number specified immediately after this parameter.
log	Log the results.

**Syntax**  
**[proto|any|ip]**

```
access-list extended <list-name> {deny|permit} {proto
<ip-protocol>|any|ip} {<source>} {<destination>} [log]
no access-list extended <list-name>{deny|permit} {proto
<ip-protocol>|any|ip}{<source>}{<destination>}[log]
```

Table 27-4: Parameters in the access-list extended (named) command - proto|ip|any

Parameter	Description								
<list-name>	A user-defined name for the access-list.								
deny	The access-list rejects packets that match the type, source, and destination filtering specified with this command.								
permit	The access-list permits packets that match the type, source, and destination filtering specified with this command.								
proto	Matches only a specified type of IP Protocol.								
any	The access-list matches any type of IP packet.								
ip	The access-list matches only IP packets.								
<source>	The source address of the packets. You can specify a single host, a subnet, or all sources. The following are the valid formats for specifying the source: <table border="1" data-bbox="662 1344 1420 1807"> <tbody> <tr> <td>any</td> <td>Matches any source IP address.</td> </tr> <tr> <td>host&lt;ip-addr&gt;</td> <td>Matches a single source host with the IP address given by &lt;ip-addr&gt; in dotted decimal notation.</td> </tr> <tr> <td>&lt;ip-addr&gt;/&lt;prefix&gt;</td> <td>An IPv4 address, followed by a forward slash, then the prefix length. This matches any source IP address within the specified subnet.</td> </tr> <tr> <td>&lt;ip-addr&gt;&lt;reverse-mask&gt;</td> <td>Alternatively, you can enter a reverse mask in dotted decimal format. For example, entering 192.168.1.1 0.0.0.255 is the same as entering 192.168.1.1/24.</td> </tr> </tbody> </table>	any	Matches any source IP address.	host<ip-addr>	Matches a single source host with the IP address given by <ip-addr> in dotted decimal notation.	<ip-addr>/<prefix>	An IPv4 address, followed by a forward slash, then the prefix length. This matches any source IP address within the specified subnet.	<ip-addr><reverse-mask>	Alternatively, you can enter a reverse mask in dotted decimal format. For example, entering 192.168.1.1 0.0.0.255 is the same as entering 192.168.1.1/24.
any	Matches any source IP address.								
host<ip-addr>	Matches a single source host with the IP address given by <ip-addr> in dotted decimal notation.								
<ip-addr>/<prefix>	An IPv4 address, followed by a forward slash, then the prefix length. This matches any source IP address within the specified subnet.								
<ip-addr><reverse-mask>	Alternatively, you can enter a reverse mask in dotted decimal format. For example, entering 192.168.1.1 0.0.0.255 is the same as entering 192.168.1.1/24.								

Table 27-4: Parameters in the access-list extended (named) command - proto|ip|any (cont.)

Parameter	Description
<i>&lt;destination&gt;</i>	The destination address of the packets. You can specify a single host, a subnet, or all destinations. The following are the valid formats for specifying the destination:
any	Matches any destination IP address.
host<ip-addr>	Matches a single destination host with the IP address given by <ip-addr> in dotted decimal notation.
<ip-addr>/ <prefix>	An IPv4 address, followed by a forward slash, then the prefix length. This matches any destination IP address within the specified subnet.
<ip-addr> <reverse-mask>	Alternatively, you can enter a reverse mask in dotted decimal format. For example, entering 192.168.1.1 0.0.0.255 is the same as entering 192.168.1.1/24.
log	Logs the results.
<ip-protocol>	The IP protocol number, as defined by IANA (Internet Assigned Numbers Authority) <a href="http://www.iana.org/assignments/protocol-numbers">www.iana.org/assignments/protocol-numbers</a> See below for a list of IP protocol numbers and their descriptions.

Table 27-5: IP protocol number and description

Protocol Number	Protocol Description [RFC]
1	Internet Control Message [RFC792]
2	Internet Group Management [RFC1112]
3	Gateway-to-Gateway [RFC823]
4	IP in IP [RFC2003]
5	Stream [RFC1190] [RFC1819]
6	TCP (Transmission Control Protocol) [RFC793]
8	EGP (Exterior Gateway Protocol) [RFC888]
9	IGP (Interior Gateway Protocol) [IANA]
11	Network Voice Protocol [RFC741]
17	UDP (User Datagram Protocol) [RFC768]
20	Host monitoring [RFC869]
27	RDP (Reliable Data Protocol) [RFC908]
28	IRTP (Internet Reliable Transaction Protocol) [RFC938]

Table 27-5: IP protocol number and description (cont.)

Protocol Number	Protocol Description [RFC]
29	ISO-TP4 (ISO Transport Protocol Class 4) [RFC905]
30	Bulk Data Transfer Protocol [RFC969]
33	DCCP (Datagram Congestion Control Protocol) [RFC4340]
48	DSR (Dynamic Source Routing Protocol) [RFC4728]
50	ESP (Encap Security Payload) [RFC2406]
51	AH (Authentication Header) [RFC2402]
54	NARP (NBMA Address Resolution Protocol) [RFC1735]
58	ICMP for IPv6 [RFC1883]
59	No Next Header for IPv6 [RFC1883]
60	Destination Options for IPv6 [RFC1883]
88	EIGRP (Enhanced Interior Gateway Routing Protocol)
89	OSPFv2 [RFC1583]
97	Ethernet-within-IP Encapsulation / RFC3378
98	Encapsulation Header / RFC1241
108	IP Payload Compression Protocol / RFC2393
112	Virtual Router Redundancy Protocol / RFC3768
134	RSVP-E2E-IGNORE / RFC3175
135	Mobility Header / RFC3775
136	UDPLite / RFC3828
137	MPLS-in-IP / RFC4023
138	MANET Protocols / RFC-ietf-manet-iana-07.txt
139-252	Unassigned / IANA
253	Use for experimentation and testing / RFC3692
254	Use for experimentation and testing / RFC3692
255	Reserved / IANA

**Mode** Global Configuration

**Default** Any traffic controlled by a software ACL that does not explicitly match a filter is denied.

**Usage** Use this command when configuring access-lists for filtering IP software packets.

You can either create access-lists from within this command, or you can enter **access-list extended** followed by only the name. Entering only the name moves you to the IPv4 Extended ACL Configuration mode for the selected access-list.

From there you can configure your access-lists by using the commands ([access-list extended ICMP filter](#)), ([access-list extended IP filter](#)), and ([access-list extended IP protocol filter](#)).

Note that packets must match both the source and the destination details.

**NOTE:** Software ACLs will **deny** access unless **explicitly permitted** by an ACL action.

**Examples** You can enter the extended named ACL in the Global Configuration mode together with the ACL filter entry on the same line, as shown below:

```
awplus# configure terminal
awplus(config)# access-list extended TK deny tcp 2.2.2.3/24 eq
14 3.3.3.4/24 eq 12 log
```

Alternatively, you can enter the extended named ACL in Global Configuration mode before specifying the ACL filter entry in the IPv4 Extended ACL Configuration mode, as shown below:

```
awplus# configure terminal
awplus(config)# access-list extended TK
awplus(config-ip-ext-acl)# deny tcp 2.2.2.3/24 eq 14 3.3.3.4/24
eq 12 log
```

**Related commands**

- [\(access-list extended ICMP filter\)](#)
- [\(access-list extended IP filter\)](#)
- [\(access-list extended TCP UDP filter\)](#)
- [show running-config](#)
- [show ip access-list](#)

# access-list (extended numbered)

**Overview** This command configures an extended numbered access-list that permits or denies packets from specific source and destination IP addresses. You can either create an extended numbered ACL together with an ACL filter entry in the Global Configuration mode, or you can use the IPv4 Extended ACL Configuration mode for sequenced ACL filter entry after entering a list number.

The **no** variant of this command removes a specified extended named access-list.

**Syntax [list-number]**

```
access-list {<100-199>|<2000-2699>}
no access-list {<100-199>|<2000-2699>}
```

Parameter	Description
<100-199>	IP extended access-list.
<2000-2699>	IP extended access-list (expanded range).

**Syntax [deny|permit]**

```
access-list {<100-199>|<2000-2699>} {deny|permit} ip <source>
<destination>
no access-list {<100-199>|<2000-2699>} {deny|permit} ip <source>
<destination>
```

Parameter	Description
<100-199>	IP extended access-list.
<2000-2699>	IP extended access-list (expanded range).
deny	Access-list rejects packets that match the source and destination filtering specified with this command.
permit	Access-list permits packets that match the source and destination filtering specified with this command.
<source>	The source address of the packets. You can specify a single host, a subnet, or all sources. The following are the valid formats for specifying the source:
any	Matches any source IP address.
host<ip-addr>	Matches a single source host with the IP address given by <ip-addr> in dotted decimal notation.
<ip-addr> <reverse-mask>	An IPv4 address, followed by a reverse mask in dotted decimal format. For example, entering 192.168.1.10.0.0.255 is the same as entering 192.168.1.1/24. This matches any source IP address within the specified subnet.

Parameter	Description
<destination>	The destination address of the packets. You can specify a single host, a subnet, or all destinations. The following are the valid formats for specifying the destination:
any	Matches any destination IP address.
host<ip-addr>	Matches a single destination host with the IP address given by <ip-addr> in dotted decimal notation.
<ip-addr> <reverse-mask>	An IPv4 address, followed by a reverse mask in dotted decimal format. For example, entering 192.168.1.10.0.0.255 is the same as entering 192.168.1.1/24. This matches any destination IP address within the specified subnet.

**Mode** Global Configuration

**Default** Any traffic controlled by a software ACL that does not explicitly match a filter is denied.

**Usage notes** Use this command when configuring access-list for filtering IP software packets.

You can either create access-lists from within this command, or you can enter **access-list** followed by only the number. Entering only the number moves you to the IPv4 Extended ACL Configuration mode for the selected access-list. From there you can configure your access-lists by using the commands ([access-list extended ICMP filter](#)), ([access-list extended IP filter](#)), and ([access-list extended IP protocol filter](#)).

Note that packets must match both the source and the destination details.

**NOTE:** Software ACLs will **deny** access unless **explicitly permitted** by an ACL action.

**Examples** You can enter the extended ACL in the Global Configuration mode together with the ACL filter entry on the same line, as shown below:

```
awplus# configure terminal
awplus(config)# access-list 101 deny ip 172.16.10.0 0.0.0.255
any
```

Alternatively, you can enter the extended ACL in Global Configuration mode before specifying the ACL filter entry in the IPv4 Extended ACL Configuration mode, as shown below:

```
awplus# configure terminal
awplus(config)# access-list 101
awplus(config-ip-ext-acl)# deny ip 172.16.10.0 0.0.0.255 any
```



**Related commands** (access-list extended ICMP filter)  
(access-list extended IP filter)  
(access-list extended TCP UDP filter)  
show running-config  
show ip access-list

## (access-list extended ICMP filter)

**Overview** Use this ACL filter to add a new ICMP filter entry to the current extended access-list. If the sequence number is specified, the new filter is inserted at the specified location. Otherwise, the new filter is added at the end of the access-list.

The **no** variant of this command removes an ICMP filter entry from the current extended access-list. You can specify the ICMP filter entry for removal by entering either its sequence number (e.g. `no 10`), or by entering its ICMP filter profile without specifying its sequence number.

Note that the sequence number can be found by running the [show access-list \(IPv4 Software ACLs\)](#) command.

**Syntax [icmp]** [*<sequence-number>*] {deny|permit} icmp *<source>* *<destination>*  
[icmp-type *<icmp-value>*] [log]

no {deny|permit} icmp *<source>* *<destination>*[icmp-type  
*<icmp-value>*] [log]

no *<sequence-number>*

Parameter	Description				
<i>&lt;sequence-number&gt;</i>	<1-65535> The sequence number for the filter entry of the selected access control list.				
deny	Access-list rejects packets that match the source and destination filtering specified with this command.				
permit	Access-list permits packets that match the source and destination filtering specified with this command.				
icmp	ICMP packet type.				
<i>&lt;source&gt;</i>	The source address of the packets. You can specify a single host, a subnet, or all sources. The following are the valid formats for specifying the source: <table border="1" data-bbox="667 1503 1422 1697"> <tbody> <tr> <td><i>&lt;ip-addr&gt;/ &lt;prefix&gt;</i></td> <td>An IPv4 address, followed by a forward slash, then the prefix length. This matches any source IP address within the specified subnet.</td> </tr> <tr> <td>any</td> <td>Matches any source IP address.</td> </tr> </tbody> </table>	<i>&lt;ip-addr&gt;/ &lt;prefix&gt;</i>	An IPv4 address, followed by a forward slash, then the prefix length. This matches any source IP address within the specified subnet.	any	Matches any source IP address.
<i>&lt;ip-addr&gt;/ &lt;prefix&gt;</i>	An IPv4 address, followed by a forward slash, then the prefix length. This matches any source IP address within the specified subnet.				
any	Matches any source IP address.				
<i>&lt;destination&gt;</i>	The destination address of the packets. You can specify a single host, a subnet, or all destinations. The following are the valid formats for specifying the destination: <table border="1" data-bbox="667 1816 1422 2011"> <tbody> <tr> <td><i>&lt;ip-addr&gt;/ &lt;prefix&gt;</i></td> <td>An IPv4 address, followed by a forward slash, then the prefix length. This matches any destination IP address within the specified subnet.</td> </tr> <tr> <td>any</td> <td>Matches any destination IP address.</td> </tr> </tbody> </table>	<i>&lt;ip-addr&gt;/ &lt;prefix&gt;</i>	An IPv4 address, followed by a forward slash, then the prefix length. This matches any destination IP address within the specified subnet.	any	Matches any destination IP address.
<i>&lt;ip-addr&gt;/ &lt;prefix&gt;</i>	An IPv4 address, followed by a forward slash, then the prefix length. This matches any destination IP address within the specified subnet.				
any	Matches any destination IP address.				

Parameter	Description
icmp-type	The ICMP type.
<icmp-value>	The value of the ICMP type.
log	Log the results.

**Mode** IPv4 Extended ACL Configuration

**Default** Any traffic controlled by a software ACL that does not explicitly match a filter is denied.

**Usage notes** An ACL can be configured with multiple ACL filters using sequence numbers. If the sequence number is omitted, the next available multiple of 10 will be used as the sequence number for the new filter. A new ACL filter can be inserted into the middle of an existing list by specifying the appropriate sequence number.

**NOTE:** The access control list being configured is selected by running the *access-list (extended numbered)* command or the *access-list extended (named)* command, with the required access control list number, or name - but with no further parameters selected.

Software ACLs will **deny** access unless **explicitly permitted** by an ACL action.

**Examples** To add a new entry in access-list called `my-list` that will reject ICMP packets from 10.0.0.1 to 192.168.1.1, use the commands:

```
awplus# configure terminal
awplus(config)# access-list extended my-list
awplus(config-ip-ext-acl)# deny icmp 10.0.0.1/32 192.168.1.1/32
```

Use the following commands to add a new filter at sequence number 5 position of the access-list called `my-list`. The filter will accept the ICMP type 8 packets from 10.1.1.0/24 network, to 192.168.1.0 network:

```
awplus# configure terminal
awplus(config)# access-list extended my-list
awplus(config-ip-ext-acl)# 5 permit icmp 10.1.1.0/24
192.168.1.0/24 icmp-type 8
```

**Related commands**

- [access-group](#)
- [show running-config](#)
- [show ip access-list](#)

## (access-list extended IP filter)

**Overview** Use this ACL filter to add a new IP filter entry to the current extended access-list. If the sequence number is specified, the new filter is inserted at the specified location. Otherwise, the new filter is added at the end of the access-list.

The **no** variant of this command removes an IP filter entry from the current extended access-list. You can specify the IP filter entry for removal by entering either its sequence number (e.g. `no 10`), or by entering its IP filter profile without specifying its sequence number.

Note that the sequence number can be found by running the [show access-list \(IPv4 Software ACLs\)](#) command.

**Syntax [ip]** [*<sequence-number>*] {deny|permit} ip *<source>* *<destination>*  
no {deny|permit} ip *<source>* *<destination>*  
no *<sequence-number>*

Parameter	Description						
<i>&lt;sequence-number&gt;</i>	<i>&lt;1-65535&gt;</i> The sequence number for the filter entry of the selected access control list.						
deny	Access-list rejects packets that match the source and destination filtering specified with this command.						
permit	Access-list permits packets that match the source and destination filtering specified with this command.						
<i>&lt;source&gt;</i>	The source address of the packets. You can specify a single host, a subnet, or all sources. The following are the valid formats for specifying the source: <table border="1"><tbody><tr><td>any</td><td>Matches any source IP address.</td></tr><tr><td>host<i>&lt;ip-addr&gt;</i></td><td>Matches a single source host with the IP address given by <i>&lt;ip-addr&gt;</i> in dotted decimal notation.</td></tr><tr><td><i>&lt;ip-addr&gt;</i> <i>&lt;reverse-mask&gt;</i></td><td>Alternatively, enter an IPv4 address followed by a reverse mask in dotted decimal format. For example, enter 192.168.1.1 0.0.0.255.</td></tr></tbody></table>	any	Matches any source IP address.	host <i>&lt;ip-addr&gt;</i>	Matches a single source host with the IP address given by <i>&lt;ip-addr&gt;</i> in dotted decimal notation.	<i>&lt;ip-addr&gt;</i> <i>&lt;reverse-mask&gt;</i>	Alternatively, enter an IPv4 address followed by a reverse mask in dotted decimal format. For example, enter 192.168.1.1 0.0.0.255.
any	Matches any source IP address.						
host <i>&lt;ip-addr&gt;</i>	Matches a single source host with the IP address given by <i>&lt;ip-addr&gt;</i> in dotted decimal notation.						
<i>&lt;ip-addr&gt;</i> <i>&lt;reverse-mask&gt;</i>	Alternatively, enter an IPv4 address followed by a reverse mask in dotted decimal format. For example, enter 192.168.1.1 0.0.0.255.						

Parameter	Description
<destination>	The destination address of the packets. You can specify a single host, a subnet, or all destinations. The following are the valid formats for specifying the destination:
any	Matches any destination IP address.
host<ip-addr>	Matches a single destination host with the IP address given by <ip-addr> in dotted decimal notation.
<ip-addr> <reverse-mask>	Alternatively, enter an IPv4 address followed by a reverse mask in dotted decimal format. For example, enter 192.168.1.1 0.0.0.255.

**Mode** Extended ACL Configuration

**Default** Any traffic controlled by a software ACL that does not explicitly match a filter is denied.

**Usage notes** An ACL can be configured with multiple ACL filters using sequence numbers. If the sequence number is omitted, the next available multiple of 10 will be used as the sequence number for the new filter. A new ACL filter can be inserted into the middle of an existing list by specifying the appropriate sequence number.

**NOTE:** The access control list being configured is selected by running the *access-list (extended numbered)* command or the *access-list extended (named)* command, with the required access control list number, or name - but with no further parameters selected.

Software ACLs will **deny** access unless **explicitly permitted** by an ACL action.

**Example 1 [list-number]** First use the following commands to enter the IPv4 Extended ACL Configuration mode and define a numbered extended access-list 101:

```
awplus# configure terminal
awplus(config)# access-list 101
awplus(config-ip-ext-acl)#
```

Then use the following commands to add a new entry to the numbered extended access-list 101 that will reject packets from 10.0.0.1 to 192.168.1.1:

```
awplus(config-ip-ext-acl)# deny ip host 10.0.0.1 host
192.168.1.1
awplus(config-ip-ext-acl)# 20 permit ip any any
```

**Example 2 [list-name]** First use the following commands to enter the IPv4 Extended ACL Configuration mode and define a named access-list called my-acl:

```
awplus# configure terminal
awplus(config)# access-list extended my-acl
awplus(config-ip-ext-acl)#
```

Then use the following commands to add a new entry to the named access-list `my-acl` that will reject packets from `10.0.0.1` to `192.168.1.1`:

```
awplus(config-ip-ext-acl)# deny ip host 10.0.0.1 host  
192.168.1.1  
awplus(config-ip-ext-acl)# 20 permit ip any any
```

**Example 3** Use the following commands to remove the access-list filter entry with sequence  
**[list-number]** number 20 from extended numbered access-list 101.

```
awplus# configure terminal  
awplus(config)# access-list 101  
awplus(config-ip-ext-acl)# no 20
```

**Example 4** Use the following commands to remove the access-list filter entry with sequence  
**[list-name]** number 20 from extended named access-list `my-acl`:

```
awplus# configure terminal  
awplus(config)# access-list extended my-acl  
awplus(config-ip-ext-acl)# no 20
```

**Related commands**

- [access-list extended \(named\)](#)
- [access-list \(extended numbered\)](#)
- [show running-config](#)
- [show ip access-list](#)

## (access-list extended IP protocol filter)

**Overview** Use this ACL filter to add a new IP protocol type filter entry to the current extended access-list. If the sequence number is specified, the new filter is inserted at the specified location. Otherwise, the new filter is added at the end of the access-list.

The **no** variant of this command removes an IP protocol filter entry from the current extended access-list. You can specify the IP filter entry for removal by entering either its sequence number (e.g. `no 10`), or by entering its IP filter profile without specifying its sequence number.

Note that the sequence number can be found by running the [show access-list \(IPv4 Software ACLs\)](#) command.

**Syntax [proto]** [*<sequence-number>*] {deny|permit} proto *<ip-protocol>* *<source>* *<destination>* [log]  
`no` {deny|permit} proto *<ip-protocol>* *<source>* *<destination>* [log]  
`no` *<sequence-number>*

Parameter	Description				
<i>&lt;sequence-number&gt;</i>	<i>&lt;1-65535&gt;</i> The sequence number for the filter entry of the selected access control list.				
deny	Access-list rejects packets that match the source and destination filtering specified with this command.				
permit	Access-list permits packets that match the source and destination filtering specified with this command.				
proto <i>&lt;ip-protocol&gt;</i>	<i>&lt;1-255&gt;</i> Specify IP protocol number, as defined by IANA (Internet Assigned Numbers Authority) <a href="http://www.iana.org/assignments/protocol-numbers">www.iana.org/assignments/protocol-numbers</a> See below for a list of IP protocol numbers and their descriptions.				
<i>&lt;source&gt;</i>	The source address of the packets. You can specify a single host, a subnet, or all sources. The following are the valid formats for specifying the source: <table border="1"><tbody><tr><td><i>&lt;ip-addr&gt;/ &lt;prefix&gt;</i></td><td>An IPv4 address, followed by a forward slash, then the prefix length. This matches any source IP address within the specified subnet.</td></tr><tr><td>any</td><td>Matches any source IP address.</td></tr></tbody></table>	<i>&lt;ip-addr&gt;/ &lt;prefix&gt;</i>	An IPv4 address, followed by a forward slash, then the prefix length. This matches any source IP address within the specified subnet.	any	Matches any source IP address.
<i>&lt;ip-addr&gt;/ &lt;prefix&gt;</i>	An IPv4 address, followed by a forward slash, then the prefix length. This matches any source IP address within the specified subnet.				
any	Matches any source IP address.				

Parameter	Description
<i>&lt;destination&gt;</i>	The destination address of the packets. You can specify a single host, a subnet, or all destinations. The following are the valid formats for specifying the destination:
<i>&lt;ip-addr&gt;/ &lt;prefix&gt;</i>	An IPv4 address, followed by a forward slash, then the prefix length. This matches any destination IP address within the specified subnet.
any	Matches any destination IP address.
log	Log the results.

Table 27-6: IP protocol number and description

Protocol Number	Protocol Description [RFC]
1	Internet Control Message [RFC792]
2	Internet Group Management [RFC1112]
3	Gateway-to-Gateway [RFC823]
4	IP in IP [RFC2003]
5	Stream [RFC1190] [RFC1819]
6	TCP (Transmission Control Protocol) [RFC793]
8	EGP (Exterior Gateway Protocol) [RFC888]
9	IGP (Interior Gateway Protocol) [IANA]
11	Network Voice Protocol [RFC741]
17	UDP (User Datagram Protocol) [RFC768]
20	Host monitoring [RFC869]
27	RDP (Reliable Data Protocol) [RFC908]
28	IRTP (Internet Reliable Transaction Protocol) [RFC938]
29	ISO-TP4 (ISO Transport Protocol Class 4) [RFC905]
30	Bulk Data Transfer Protocol [RFC969]
33	DCCP (Datagram Congestion Control Protocol) [RFC4340]
48	DSR (Dynamic Source Routing Protocol) [RFC4728]
50	ESP (Encap Security Payload) [RFC2406]
51	AH (Authentication Header) [RFC2402]
54	NARP (NBMA Address Resolution Protocol) [RFC1735]
58	ICMP for IPv6 [RFC1883]
59	No Next Header for IPv6 [RFC1883]



Table 27-6: IP protocol number and description (cont.)

Protocol Number	Protocol Description [RFC]
60	Destination Options for IPv6 [RFC1883]
88	EIGRP (Enhanced Interior Gateway Routing Protocol)
89	OSPFv2 [RFC1583]
97	Ethernet-within-IP Encapsulation / RFC3378
98	Encapsulation Header / RFC1241
108	IP Payload Compression Protocol / RFC2393
112	Virtual Router Redundancy Protocol / RFC3768
134	RSVP-E2E-IGNORE / RFC3175
135	Mobility Header / RFC3775
136	UDPLite / RFC3828
137	MPLS-in-IP / RFC4023
138	MANET Protocols / RFC-ietf-manet-iana-07.txt
139-252	Unassigned / IANA
253	Use for experimentation and testing / RFC3692
254	Use for experimentation and testing / RFC3692
255	Reserved / IANA

**Mode** IPv4 Extended ACL Configuration

**Default** Any traffic controlled by a software ACL that does not explicitly match a filter is denied.

**Usage notes** An ACL can be configured with multiple ACL filters using sequence numbers. If the sequence number is omitted, the next available multiple of 10 will be used as the sequence number for the new filter. A new ACL filter can be inserted into the middle of an existing list by specifying the appropriate sequence number.

**NOTE:** The access control list being configured is selected by running the *access-list (extended numbered)* command or the *access-list extended (named)* command, with the required access control list number, or name - but with no further parameters selected.

Software ACLs will **deny** access unless **explicitly permitted** by an ACL action.

**Example 1 [creating a list]** Use the following commands to add a new access-list filter entry to the access-list named `my-list` that will reject IP packets from source address `10.10.1.1/32` to destination address `192.68.1.1/32`:

```
awplus# configure terminal
awplus(config)# access-list extended my-list
awplus(config-ip-ext-acl)# deny ip 10.10.1.1/32 192.168.1.1/32
```

**Example 2** Use the following commands to add a new access-list filter entry at sequence  
**[adding to a list]** position 5 in the access-list named `my-list` that will accept packets from source  
address `10.10.1.1/24` to destination address `192.68.1.1/24`:

```
awplus# configure terminal
awplus(config)# access-list extended my-list
awplus(config-ip-ext-acl)# 5 permit ip 10.10.1.1/24
192.168.1.1/ 24
```

**Related commands**

- [access-list extended \(named\)](#)
- [access-list \(extended numbered\)](#)
- [show running-config](#)
- [show ip access-list](#)

## (access-list extended TCP UDP filter)

**Overview** Use this ACL filter to add a new TCP or UDP filter entry to the current extended access-list. If the sequence number is specified, the new filter is inserted at the specified location. Otherwise, the new filter is added at the end of the access-list.

The **no** variant of this command removes a TCP or UDP filter entry from the current extended access-list. You can specify the TCP or UDP filter entry for removal by entering either its sequence number (e.g. `no 10`), or by entering its TCP or UDP filter profile without specifying its sequence number.

Note that the sequence number can be found by running the [show access-list \(IPv4 Software ACLs\)](#) command.

**Syntax [tcp|udp]** [`<sequence-number>`] {deny|permit} {tcp|udp} <source> {eq <sourceport> |lt <sourceport>|gt <sourceport>|ne <sourceport>} <destination> [eq <destport>|lt <destport>|gt <destport>|ne <destport>] [log]

`no` [`<sequence-number>`]{deny|permit} {tcp|udp} <source> {eq <sourceport> |lt <sourceport>|gt <sourceport>|ne <sourceport>} <destination> [eq <destport>|lt <destport>|gt <destport>|ne <destport>] [log]

`no` <sequence-number>

**Mode** IPv4 Extended ACL Configuration

**Default** Any traffic controlled by a software ACL that does not explicitly match a filter is denied.

**Usage** An ACL can be configured with multiple ACL filters using sequence numbers. If the sequence number is omitted, the next available multiple of 10 will be used as the sequence number for the new filter. A new ACL filter can be inserted into the middle of an existing list by specifying the appropriate sequence number.

**NOTE:** *The access control list being configured is selected by running the [access-list \(extended numbered\)](#) command or the [access-list extended \(named\)](#) command, with the required access control list number, or name - but with no further parameters selected.*

*Software ACLs will **deny** access unless **explicitly permitted** by an ACL action.*

**Example 1 [creating a list]** To add a new entry to the access-list named `my-list` that will reject TCP packets from `10.0.0.10` on TCP port 10 to `192.168.1.1` on TCP port 20, use the commands:

```
awplus# configure terminal
awplus(config)# access-list extended my-list
awplus(config-ip-ext-acl)# deny tcp 10.0.0.1/32 eq 10
192.168.1.1/32 eq 20
```

**Example 2** To insert a new entry with sequence number 5 of the access-list named `my-list` **[adding to a list]** that will accept UDP packets from `10.1.1.0/24` network to `192.168.1.0/24` network on UDP port 80, use the commands:

```
awplus# configure terminal
awplus(config)# access-list extended my-list
awplus(config-ip-ext-acl)# 5 permit udp 10.1.1.0/24
192.168.1.0/24 eq 80
```

**Related commands**

- [access-list extended \(named\)](#)
- [access-list \(extended numbered\)](#)
- [show running-config](#)
- [show ip access-list](#)

# access-list standard (named)

**Overview** This command configures a standard named access-list that permits or denies packets from a specific source IP address. You can either create a standard named ACL together with an ACL filter entry in the Global Configuration mode, or you can use the IPv4 Standard ACL Configuration mode for sequenced ACL filter entry after first entering an access-list name.

The **no** variant of this command removes a specified standard named access-list.

**Syntax [list-name]**  
`access-list standard <standard-access-list-name>`  
`no access-list standard <standard-access-list-name>`

Parameter	Description
<code>&lt;standard-access-list-name&gt;</code>	Specify a name for the standard access-list.

**Syntax [deny|permit]**  
`access-list standard <standard-access-list-name> {deny|permit} <source>`  
`no access-list standard <standard-access-list-name> {deny|permit} <source>`

Parameter	Description				
<code>&lt;standard-access-list-name&gt;</code>	Specify a name for the standard access-list.				
deny	The access-list rejects packets that match the source filtering specified with this command.				
permit	The access-list permits packets that match the source filtering specified with this command.				
<code>&lt;source&gt;</code>	The source address of the packets. You can specify a single host, a subnet, or all sources. The following are the valid formats for specifying the source: <table border="1"><tbody><tr><td><code>&lt;ip-addr&gt;/&lt;prefix&gt;</code></td><td>An IPv4 address, followed by a forward slash, then the prefix length. This matches any source IP address within the specified subnet.</td></tr><tr><td>any</td><td>Matches any source IP address.</td></tr></tbody></table>	<code>&lt;ip-addr&gt;/&lt;prefix&gt;</code>	An IPv4 address, followed by a forward slash, then the prefix length. This matches any source IP address within the specified subnet.	any	Matches any source IP address.
<code>&lt;ip-addr&gt;/&lt;prefix&gt;</code>	An IPv4 address, followed by a forward slash, then the prefix length. This matches any source IP address within the specified subnet.				
any	Matches any source IP address.				

**Mode** Global Configuration

**Default** Any traffic controlled by a software ACL that does not explicitly match a filter is denied.

**Usage notes** Use this command when configuring a standard named access-list for filtering IP software packets.

You can either create access-lists from within this command, or you can enter **access-list standard** followed by only the name. Entering only the name moves you to the IPv4 Standard ACL Configuration mode for the selected access-list. From there you can configure your access-lists by using the command ([access-list standard named filter](#)).

**NOTE:** Software ACLs will **deny** access unless **explicitly permitted** by an ACL action.

**Examples** To define a standard access-list named `my-list` and deny any packets from any source, use the commands:

```
awplus# configure terminal
awplus(config)# access-list standard my-list deny any
```

Alternatively, to define a standard access-list named `my-list` and enter the IPv4 Standard ACL Configuration mode to deny any packets from any source, use the commands:

```
awplus# configure terminal
awplus(config)# access-list standard my-list
awplus(config-ip-std-acl)# 5 deny any
```

**Related commands** ([access-list standard named filter](#))  
[show running-config](#)  
[show ip access-list](#)

# access-list (standard numbered)

**Overview** This command configures a standard numbered access-list that permits or denies packets from a specific source IP address. You can either create a standard numbered ACL together with an ACL filter entry in the Global Configuration mode, or you can use the IPv4 Standard ACL Configuration mode for sequenced ACL filter entry after first entering an access-list number.

The **no** variant of this command removes a specified standard numbered access-list.

**Syntax [list-number]**

```
access-list {<1-99>|<1300-1999>}  
no access-list {<1-99>|<1300-1999>}
```

Parameter	Description
<1-99>	IP standard access-list.
<1300-1999>	IP standard access-list (expanded range).

**Syntax [deny|permit]**

```
access-list {<1-99>|<1300-1999>} {deny|permit} <source>  
no access-list {<1-99>|<1300-1999>} {deny|permit} <source>
```

Parameter	Description				
<1-99>	IP standard access-list.				
<1300-1999>	IP standard access-list (expanded range).				
deny	Access-list rejects packets from the specified source.				
permit	Access-list accepts packets from the specified source.				
<source>	The source address of the packets. You can specify a single host, a subnet, or all sources. The following are the valid formats for specifying the source: <table border="1"><tbody><tr><td>&lt;ip-addr&gt;</td><td>Enter an IPv4 address followed by a reverse mask in dotted decimal format. For example, entering 192.168.1.1 0.0.0.255 is the same as entering 192.168.1.1/24.</td></tr><tr><td>&lt;reverse-mask&gt;</td><td></td></tr></tbody></table>	<ip-addr>	Enter an IPv4 address followed by a reverse mask in dotted decimal format. For example, entering 192.168.1.1 0.0.0.255 is the same as entering 192.168.1.1/24.	<reverse-mask>	
<ip-addr>	Enter an IPv4 address followed by a reverse mask in dotted decimal format. For example, entering 192.168.1.1 0.0.0.255 is the same as entering 192.168.1.1/24.				
<reverse-mask>					
any	Matches any source IP address.				

**Mode** Global Configuration

**Default** Any traffic controlled by a software ACL that does not explicitly match a filter is denied.

**Usage notes** Use this command when configuring a standard numbered access-list for filtering IP software packets.

You can either create access-lists from within this command, or you can enter **access-list** followed by only the number. Entering only the number moves you to the IPv4 Standard ACL Configuration mode for the selected access-list. From there you can configure your access-lists by using the command ([access-list standard numbered filter](#)).

**NOTE:** Software ACLs will **deny** access unless **explicitly permitted** by an ACL action.

**Examples** To create ACL number 67 that will deny packets from subnet 172.16.10, use the commands:

```
awplus# configure terminal
awplus(config)# access-list 67 deny 172.16.10.0 0.0.0.255
```

Alternatively, to enter the IPv4 Standard ACL Configuration mode to create the ACL filter and deny packets from subnet 172.16.10.0 for the standard numbered access-list 67, use the commands:

```
awplus# configure terminal
awplus(config)# access-list 67
awplus(config-ip-std-acl)# deny 172.16.10.0 0.0.0.255
```

**Related commands** ([access-list standard named filter](#))  
[show running-config](#)  
[show ip access-list](#)



## (access-list standard named filter)

**Overview** This ACL filter adds a source IP address filter entry to a current named standard access-list. If the sequence number is specified, the new filter entry is inserted at the specified location. Otherwise, the new entry is added at the end of the access-list.

The **no** variant of this command removes a source IP address filter entry from the current named standard access-list. You can specify the source IP address filter entry for removal by entering either its sequence number (e.g. `no 10`), or by entering its source IP address filter profile without specifying its sequence number.

Note that the sequence number can be found by running the [show access-list \(IPv4 Software ACLs\)](#) command.

**Syntax** [`<sequence-number>`] {deny|permit} {<source> [exact-match]|any}  
no {deny|permit} {<source> [exact-match]|any}  
no <sequence-number>

Parameter	Description				
<code>&lt;sequence-number&gt;</code>	<code>&lt;1-65535&gt;</code> The sequence number for the filter entry of the selected access control list.				
deny	Access-list rejects packets of the source filtering specified.				
permit	Access-list allows packets of the source filtering specified				
<code>&lt;source&gt;</code>	The source address of the packets. You can specify either a subnet or all sources. The following are the valid formats for specifying the source: <table border="1"><tbody><tr><td><code>&lt;ip-addr&gt;/ &lt;prefix&gt;</code></td><td>An IPv4 address, followed by a forward slash, then the prefix length. This matches any destination IP address within the specified subnet.</td></tr><tr><td><code>&lt;ip-addr&gt;</code></td><td>An IPv4 address in a.b.c.d format.</td></tr></tbody></table>	<code>&lt;ip-addr&gt;/ &lt;prefix&gt;</code>	An IPv4 address, followed by a forward slash, then the prefix length. This matches any destination IP address within the specified subnet.	<code>&lt;ip-addr&gt;</code>	An IPv4 address in a.b.c.d format.
<code>&lt;ip-addr&gt;/ &lt;prefix&gt;</code>	An IPv4 address, followed by a forward slash, then the prefix length. This matches any destination IP address within the specified subnet.				
<code>&lt;ip-addr&gt;</code>	An IPv4 address in a.b.c.d format.				
exact-match	Specify an exact IP prefix to match on.				
any	Matches any source IP address.				

**Mode** IPv4 Standard ACL Configuration

**Default** Any traffic controlled by a software ACL that does not explicitly match a filter is denied.

**Usage notes** An ACL can be configured with multiple ACL filters using sequence numbers. If the sequence number is omitted, the next available multiple of 10 will be used as the sequence number for the new filter. A new ACL filter can be inserted into the middle of an existing list by specifying the appropriate sequence number.

**NOTE:** *The access control list being configured is selected by running the `access-list standard (named)` command with the required access control list name, but with no further parameters selected.*

Software ACLs will **deny** access unless **explicitly permitted** by an ACL action.

**Examples** Use the following commands to add a new filter entry to access-list `my-list` that will reject IP address `10.1.1.1`:

```
awplus# configure terminal
awplus(config)# access-list standard my-list
awplus(config-ip-std-acl)# deny 10.1.1.1/32
```

Use the following commands to insert a new filter entry into access-list `my-list` at sequence position number 15 that will accept IP network `10.1.2.0`:

```
awplus# configure terminal
awplus(config)# access-list standard my-list
awplus(config-ip-std-acl)# 15 permit 10.1.2.0/24
```

**Related commands**

- `access-list standard (named)`
- `show running-config`
- `show ip access-list`

## (access-list standard numbered filter)

**Overview** This ACL filter adds a source IP address filter entry to a current standard numbered access-list. If a sequence number is specified, the new filter entry is inserted at the specified location. Otherwise, the new filter entry is added at the end of the access-list.

The **no** variant of this command removes a source IP address filter entry from the current standard numbered access-list. You can specify the source IP address filter entry for removal by entering either its sequence number (e.g. `no 10`), or by entering its source IP address filter profile without specifying its sequence number.

Note that the sequence number can be found by running the [show access-list \(IPv4 Software ACLs\)](#) command.

**Syntax** [`<sequence-number>`] {deny|permit} {<source>|host <host-address>|any}  
no {deny|permit} {<source>|host <host-address>|any}  
no <sequence-number>

Parameter	Description				
<code>&lt;sequence-number&gt;</code>	<1-65535> The sequence number for the filter entry of the selected access control list.				
deny	Access-list rejects packets of the type specified.				
permit	Access-list allows packets of the type specified				
<code>&lt;source&gt;</code>	The source address of the packets. You can specify either a subnet or all sources. The following are the valid formats for specifying the source: <table border="1"><tr><td><code>&lt;ip-addr&gt;</code> <code>&lt;reverse-mask&gt;</code></td><td>Enter a reverse mask for the source address in dotted decimal format. For example, entering 192.168.1.10.0.0.0.255 is the same as entering 192.168.1.1/24.</td></tr><tr><td><code>&lt;ip-addr&gt;</code></td><td>An IPv4 address in a.b.c.d format.</td></tr></table>	<code>&lt;ip-addr&gt;</code> <code>&lt;reverse-mask&gt;</code>	Enter a reverse mask for the source address in dotted decimal format. For example, entering 192.168.1.10.0.0.0.255 is the same as entering 192.168.1.1/24.	<code>&lt;ip-addr&gt;</code>	An IPv4 address in a.b.c.d format.
<code>&lt;ip-addr&gt;</code> <code>&lt;reverse-mask&gt;</code>	Enter a reverse mask for the source address in dotted decimal format. For example, entering 192.168.1.10.0.0.0.255 is the same as entering 192.168.1.1/24.				
<code>&lt;ip-addr&gt;</code>	An IPv4 address in a.b.c.d format.				
host	A single source host.				
<code>&lt;host-address&gt;</code>	Single source host address.				
any	Matches any source IP address.				

**Mode** IPv4 Standard ACL Configuration

**Default** Any traffic controlled by a software ACL that does not explicitly match a filter is denied.

**Usage notes** An ACL can be configured with multiple ACL filters using sequence numbers. If the sequence number is omitted, the next available multiple of 10 will be used as the sequence number for the new filter. A new ACL filter can be inserted into the middle of an existing list by specifying the appropriate sequence number.

**NOTE:** The access control list being configured is selected by running the *access-list (standard numbered)* command with the required access control list number but with no further parameters selected.

Software ACLs will **deny** access unless **explicitly permitted** by an ACL action.

**Example** To add a new entry accepting the IP network 10.1.1.0/24 at the sequence number 15 position, use the commands:

```
awplus# configure terminal
awplus(config)# access-list 99
awplus(config-ip-std-acl)# 15 permit 10.1.2.0 0.0.0.255
```

**Related commands**

- [access-list \(standard numbered\)](#)
- [show running-config](#)
- [show ip access-list](#)

# dos

**Overview** Use this command to configure Denial-of-Service (DoS) features for a port. Six different DoS attacks can be detected: IP Options, Land, Ping-of-Death, Smurf, Synflood and Teardrop.

When the attack is detected, three different actions are available:

- Shutdown the port for one minute
- Cause an SNMP trap.
- Send traffic to the mirror port

**Syntax** `dos {ipoptions|land|ping-of-death|smurf broadcast <ip-address>|synflood|teardrop} action {shutdown|trap|mirror}`

Parameter	Description
dos	Denial-Of-Service.
ipoptions	IP Options attack.
land	Land attack.
ping-of-death	Large ping attack.
smurf	Ping to broadcast address.
broadcast	Broadcast.
<ip-address>	Local IP Broadcast Address.
synflood	SYN flood attack.
teardrop	IP fragmentation attack.
action	Action.
shutdown	Shutdown port.
trap	Trap to SNMP.
mirror	Send packets to mirror port.

**Mode** Interface Configuration for a switch port interface.

**Default** DoS attack detection is not configured by default on any switch port interface.

**Usage notes** See the below table for more information about the DoS attacks recognized by this command:

Type of DoS attack	Description
ipoptions	<p>This type of attack occurs when an attacker sends packets containing bad IP options to a victim node. There are many different types of IP options attacks and this software does not try to distinguish between them. Rather, if this defense is activated, the number of ingress IP packets containing IP options is counted. If the number exceeds 20 packets per second, the switch considers this a possible IP options attack. This defense does not require the CPU to monitor packets, so does not put extra load on the switch's CPU.</p>
land	<p>This type of attack occurs when the Source IP and Destination IP address are the same. This can cause a target host to be confused. Since packets with the same source and destination addresses should never occur, these packets are dropped when this attack is enabled.</p> <p>This defense does not require the CPU to monitor packets, so does not put extra load on the switch's CPU.</p>
ping-of-death	<p>This type of attack results from a fragmented packet which, when reassembled, would exceed the maximum size of a valid IP datagram. To detect this attack, the final fragment of ICMP packets has to be sent to the CPU for inspection. This defense can therefore load the CPU.</p> <p>Note that the extra CPU load will not affect normal traffic switching between ports, but other protocols such as IGMP and STP may be affected. This defense is not recommended where a large number of fragmented packets are expected.</p>
smurf	<p>This type of attack is an ICMP ping packet to a broadcast address. Although routers should not forward packets to local broadcast addresses anymore (see RFC2644), the Smurf attack can still be explicitly discarded with this command. In order for the Smurf attack to work, the broadcast IP address is required. Any ICMP Ping packet with this destination address is considered an attack.</p> <p>This defense does not require the CPU to monitor packets, so does not put extra load on the switch's CPU.</p>
synflood	<p>In this type of attack, an attacker, seeking to overwhelm a victim with TCP connection requests, sends a large number of TCP SYN packets with bogus source addresses to the victim. The victim responds with SYN ACK packets, but since the original source addresses are bogus, the victim node does not receive any replies. If the attacker sends enough requests in a short enough period, the victim may freeze operations once the requests exceed the capacity of its connections queue.</p> <p>To defend against this form of attack, a switch port monitors the number of ingress TCP-SYN packets it receives. An attack is recorded if a port receives more 60 TCP-SYN packets per second.</p>
teardrop	<p>In this DoS attack, an attacker sends a packet in several fragments with a bogus offset value, used to reconstruct the packet, in one of the fragments to a victim. This results in the victim being unable to reassemble the packet, possibly causing it to freeze operations.</p>

**Examples** To configure **smurf** DoS detection on port1.0.1, and shutdown the interface if an attack is detected, use the commands:

```
awplus# configure terminal
awplus(config)# interface port1.0.1
awplus(config-if)# dos smurf broadcast 192.168.1.0 action
shutdown
```

To configure **land** DoS detection on port1.0.1, and shutdown the interface if an attack is detected, use the commands:

```
awplus# configure terminal
awplus(config)# interface port1.0.1
awplus(config-if)# dos land action shutdown
```

To configure **ipoptions** DoS detection on port1.0.1, and shutdown the interface if an attack is detected, use the commands:

```
awplus# configure terminal
awplus(config)# interface port1.0.1
awplus(config-if)# dos ipoptions action shutdown
```

To configure **ping-of-death** DoS detection on port1.0.1, and shutdown the interface if an attack is detected, use the commands:

```
awplus# configure terminal
awplus(config)# interface port1.0.1
awplus(config-if)# dos ping-of-death action shutdown
```

To configure **synflood** DoS detection on port1.0.1, and shutdown the interface if an attack is detected, use the commands:

```
awplus# configure terminal
awplus(config)# interface port1.0.1
awplus(config-if)# dos synflood action shutdown
```

To configure **teardrop** DoS detection on port1.0.1, and shutdown the interface if an attack is detected, use the commands:

```
awplus# configure terminal
awplus(config)# interface port1.0.1
awplus(config-if)# dos teardrop action shutdown
```

**Related commands** [show dos interface](#)

# maximum-access-list

**Overview** Use this command to set the maximum number of filters that can be added to any access-list. These are access-lists within the ranges 1-199, 1300-1999 and 2000-2699, and named standard and extended access-lists.

The **no** variant of this command removes the limit on the number of filters that can be added to a software access-list.

**Syntax** `maximum-access-list <1-4294967294>`  
`no maximum-access-list`

Parameter	Description
<code>&lt;1-4294967294&gt;</code>	Filter range.

**Mode** Global Configuration

**Example** To set the maximum number of software filters to 200, use the commands:

```
awplus# configure terminal
awplus(config)# maximum-access-list 200
```



# show access-list (IPv4 Software ACLs)

**Overview** Use this command to display the specified access-list, or all access-lists if none have been specified. Note that only defined access-lists are displayed. An error message is displayed for an undefined access-list

**Syntax** `show access-list`  
[<1-99> | <100-199> | <1300-1999> | <2000-2699> | <3000-3699> |  
<4000-4499> | <access-list-name>]

Parameter	Description
<1-99>	IP standard access-list.
<100-199>	IP extended access-list.
<1300-1999>	IP standard access-list (standard - expanded range).
<2000-2699>	IP extended access-list (extended - expanded range).
<3000-3699>	Hardware IP access-list.
<4000-4499>	Hardware MAC access-list.
<access-list-name>	IP named access-list.

**Mode** User Exec and Privileged Exec

**Examples** To show all access-lists configured on the switch:

```
awplus# show access-list
```

```
Standard IP access list 1
  deny 172.16.2.0, wildcard bits 0.0.0.255
Standard IP access list 20
  deny 192.168.10.0, wildcard bits 0.0.0.255
  deny 192.168.12.0, wildcard bits 0.0.0.255
Hardware IP access list 3001
  permit ip 192.168.20.0 255.255.255.0 any
Hardware IP access list 3020
  permit tcp any 192.0.2.0/24
awplus#show access-list 20
```

To show the access-list with an ID of 20:

```
awplus# show access-list 20
```

```
Standard IP access-list 20
deny 192.168.10.0, wildcard bits 0.0.0.255
deny 192.168.12.0, wildcard bits 0.0.0.255
```

Note the following error message is displayed if you attempt to show an undefined access-list:

```
awplus# show access-list 2
```

```
% Can't find access-list 2
```

**Related  
commands**

[access-list standard \(named\)](#)

[access-list \(standard numbered\)](#)

# show dos interface

**Overview** Use this command to display the Denial-of-Service (DoS) features configured on a switch port interface from the `dos` command. See the `dos` command for descriptions of DoS attack types.

**Syntax** `show dos interface {<port-list>}`

Parameter	Description
<code>&lt;port-list&gt;</code>	Specify the switch port or port list to display DoS configuration options set with the <code>dos</code> command.

**Mode** Privileged Exec

**Output** Figure 27-1: Example output from the **show dos interface** command prior to a DoS attack

```
awplus#configure terminal
Enter configuration commands, one per line. End with CTNTRL/Z.
awplus(config)#interface port1.0.1
awplus(config-if)#dos synflood action shutdown
awplus(config-if)#exit
awplus(config)#exit
awplus#show dos interface port1.0.1

DoS settings for interface port1.0.1
-----
Port status           : Enabled
ipoptions             : Disabled
land                  : Disabled
ping-of-death         : Disabled
smurf                 : Disabled
synflood              : Enabled
  Action               : Shutdown port
  Attacks detected    : 0
teardrop              : Disabled
awplus#
```

Figure 27-2: Example output from the **show dos interface** command after a **synflood** DoS attack

```
awplus#show dos interface port1.0.1

DoS settings for interface port1.0.1
-----
Port status           : Enabled
ipoptions             : Disabled
land                  : Disabled
ping-of-death        : Disabled
smurf                 : Disabled
synflood              : Enabled
  Action               : Shutdown port
  Attacks detected    : 1
teardrop              : Disabled
awplus#
```

**Table 28:** Parameters in the **show dos interface** command output:

Type of DoS attack	Description
Port status	Displays Enabled when the port is configured as being administratively up after issuing the <b>no shutdown</b> command. Displays Disabled when the port is configured as being administratively down with the <b>shutdown</b> command.
ipoptions	Displays Enabled when the <b>ipoptions</b> parameter is configured with the <b>dos</b> command, plus the action (Shutdown port, Mirror port, or Trap port) and the number of instances of any <b>ipoptions</b> DoS attacks that have occurred on the interface. Displays Disabled when the <b>ipoptions</b> parameter is not configured with the <b>dos</b> command.
land	Displays Enabled when the <b>land</b> parameter is configured with the <b>dos</b> command, plus the action (Shutdown port, Mirror port, or Trap port) and the number of instances of any <b>land</b> DoS attacks that have occurred on the interface. Displays Disabled when the <b>land</b> parameter is not configured with the <b>dos</b> command.
ping-of-death	Displays Enabled when the <b>ping-of-death</b> parameter is configured with the <b>dos</b> command, plus the action (Shutdown port, Mirror port, or Trap port) and the number of instances of any <b>ping-of-death</b> DoS attacks that have occurred on the interface. Displays Disabled when the <b>ping-of-death</b> parameter is not configured with the <b>dos</b> command.

**Table 28:** Parameters in the **show dos interface** command output: (cont.)

Type of DoS attack	Description
smurf	Displays Enabled when the <b>smurf</b> parameter is configured with the <b>dos</b> command, plus the action (Shutdown port, Mirror port, or Trap port) and the number of instances of any <b>smurf</b> DoS attacks that have occurred on the interface. Displays Disabled when the <b>smurf</b> parameter is not configured with the <b>dos</b> command.
synflood	Displays Enabled when the <b>synflood</b> parameter is configured with the <b>dos</b> command, plus the action (Shutdown port, Mirror port, or Trap port) and the number of instances of any <b>synflood</b> DoS attacks that have occurred on the interface. Displays Disabled when the <b>synflood</b> parameter is not configured with the <b>dos</b> command.
teardrop	Displays Enabled when the <b>teardrop</b> parameter is configured with the <b>dos</b> command, plus the action (Shutdown port, Mirror port, or Trap port) and the number of instances of any <b>teardrop</b> DoS attacks that have occurred on the interface. Displays Disabled when the <b>teardrop</b> parameter is not configured with the <b>dos</b> command.

**Related commands**    dos

# show ip access-list

**Overview** Use this command to display IP access-lists.

**Syntax** `show ip access-list`  
`[ <1-99> | <100-199> | <1300-1999> | <2000-2699> | <access-list-name> ]`

Parameter	Description
<1-99>	IP standard access-list.
<100-199>	IP extended access-list.
<1300-1999>	IP standard access-list (expanded range).
<2000-2699>	IP extended access-list (expanded range).
<access-list-name>	IP named access-list.

**Mode** User Exec and Privileged Exec

**Example** `awplus# show ip access-list`

**Output** Figure 27-3: Example output from the **show ip access-list** command

```
Standard IP access-list 1
  permit 172.168.6.0, wildcard bits 0.0.0.255
  permit 192.168.6.0, wildcard bits 0.0.0.255
```

# vty access-class (numbered)

**Overview** For IPv4, use this command to set a standard numbered software access list to be the management ACL. This is then applied to all available VTY lines for controlling remote access by Telnet and SSH. This command allows or denies packets containing the IP addresses included in the ACL to create a connection to your device.

ACLs that are attached using this command have an implicit deny-all filter as the final entry in the ACL. So a typical configuration would be to permit a specific address, or range of addresses, and rely on the deny-all filter to block all other access.

Use the **no** variant of this command to remove the access list.

**Syntax** `vty access-class {<1-99>|<1300-1999>}`  
`no vty access-class [<1-99>|<1300-1999>]`

Parameter	Description
<1-99>	IPv4 standard access-list number
<1300-1999>	IPv4 standard access-list number (expanded range)

**Mode** Global Configuration

**Examples** To set access-list 4 to be the management ACL, use the following commands:

```
awplus# configure terminal  
awplus(config)# vty access-class 4
```

To remove access-list 4 from the management ACL, use the following commands:

```
awplus# configure terminal  
awplus(config)# no vty access-class 4
```

**Output** Figure 27-4: Example output from the **show running-config** command

```
awplus#show running-config|grep access-class  
vty access-class 4
```

**Related commands** [show running-config](#)  
[vty ipv6 access-class \(named\)](#)

# 28

# IPv6 Software Access Control List (ACL) Commands

## Introduction

**Overview** This chapter provides an alphabetical reference for the IPv6 Software Access Control List (ACL) commands, and contains detailed command information and command examples about IPv6 software ACLs as applied to Routing and Multicasting, which are not applied to interfaces.

For information about ACLs, see the [ACL Feature Overview and Configuration Guide](#).

To apply ACLs to an LACP channel group, apply it to all the individual switch ports in the channel group. To apply ACLs to a static channel group, apply it to the static channel group itself. For more information on link aggregation see the following references:

- the [Link Aggregation Feature Overview\\_and\\_Configuration Guide](#).
- [Link Aggregation Commands](#)

Note that text in parenthesis in command names indicates usage not keyword entry. For example, **ipv6-access-list (named)** indicates named IPv6 ACLs entered as `ipv6-access-list <name>` where *<name>* is a placeholder not a keyword.

Note also that parenthesis surrounding ACL filters indicates the type of ACL filter not the keyword entry in the CLI. For example, **(ipv6 access-list standard IPv6 filter)** represents command entry in the format shown in the syntax:

```
[ <sequence-number> ] {deny|permit}  
{ <source-ipv6-address/prefix-length> | any }
```

**NOTE:** Software ACLs will **deny** access unless **explicitly permitted** by an ACL action.

**Sub-modes** Many of the ACL commands operate from sub-modes that are specific to particular ACL types. The following table shows the CLI prompts at which ACL commands are entered.



Table 28-1: IPv6 Software Access List Commands and Prompts

Command Name	Command Mode	Prompt
show ipv6 access-list (IPv6 Software ACLs)	Privileged Exec	awplus#
ipv6 access-list standard (named)	Global Configuration	awplus(config)#
(ipv6 access-list standard filter)	IPv6 Standard ACL Configuration	awplus(config-ipv6-std-acl)#

- Command List**
- “[ipv6 access-list standard \(named\)](#)” on page 978
  - “[\(ipv6 access-list standard filter\)](#)” on page 980
  - “[show ipv6 access-list \(IPv6 Software ACLs\)](#)” on page 982
  - “[vty ipv6 access-class \(named\)](#)” on page 983

# ipv6 access-list standard (named)

**Overview** This command configures an IPv6 standard access-list for filtering frames that permit or deny IPv6 packets from a specific source IPv6 address.

The **no** variant of this command removes a specified IPv6 standard access-list.

**Syntax [list-name]** `ipv6 access-list standard <ipv6-acl-list-name>`  
`no ipv6 access-list standard <ipv6-acl-list-name>`

Parameter	Description
<code>&lt;ipv6-acl-list-name&gt;</code>	A user-defined name for the IPv6 software standard access-list.

**Syntax [deny|permit]** `ipv6 access-list standard <ipv6-acl-list-name> [{deny|permit} {<ipv6-source-address/prefix-length>|any} [exact-match]]`  
`no ipv6 access-list standard <ipv6-acl-list-name> [{deny|permit} {<ipv6-source-address/prefix-length>|any} [exact-match]]`

Parameter	Description
<code>&lt;ipv6-acl-list-name&gt;</code>	A user-defined name for the IPv6 software standard access-list.
<code>deny</code>	The IPv6 software standard access-list rejects packets that match the type, source, and destination filtering specified with this command.
<code>permit</code>	The IPv6 software standard access-list permits packets that match the type, source, and destination filtering specified with this command.
<code>&lt;ipv6-source-address/prefix-length&gt;</code>	Specifies a source address and prefix length. The IPv6 address prefix uses the format X:X::/prefix-length. The prefix-length is usually set between 0 and 64.
<code>any</code>	Matches any source IPv6 address.
<code>exact-match</code>	Exact match of the prefixes.

**Mode** Global Configuration

**Default** Any traffic controlled by a software ACL that does not explicitly match a filter is denied.

**Usage notes** Use IPv6 standard access-lists to control the transmission of IPv6 packets on an interface, and restrict the content of routing updates. The switch stops checking the IPv6 standard access-list when a match is encountered.

For backwards compatibility you can either create IPv6 standard access-lists from within this command, or you can enter `ipv6 access-list standard` followed by only the IPv6 standard access-list name. This latter (and preferred) method moves you to the `(config-ipv6-std-acl)` prompt for the selected IPv6 standard access-list, and from here you can configure the filters for this selected IPv6 standard access-list.

**NOTE:** Software ACLs will **deny** access unless **explicitly permitted** by an ACL action.

**Example** To enter the IPv6 Standard ACL Configuration mode for the access-list named `my-list`, use the commands:

```
awplus# configure terminal
awplus(config)# ipv6 access-list standard my-list
awplus(config-ipv6-std-acl)#
```

**Related commands** [\(ipv6 access-list standard filter\)](#)  
[show ipv6 access-list \(IPv6 Software ACLs\)](#)  
[show running-config](#)

## (ipv6 access-list standard filter)

**Overview** Use this ACL filter to add a filter entry for an IPv6 source address and prefix length to the current standard IPv6 access-list. If a sequence number is specified, the new entry is inserted at the specified location. Otherwise, the new entry is added at the end of the access-list.

The **no** variant of this command removes a filter entry for an IPv6 source address and prefix from the current standard IPv6 access-list. You can specify the filter entry for removal by entering either its sequence number, or its filter entry profile.

**Syntax [icmp]** [`<sequence-number>`] {deny|permit}  
{`<ipv6-source-address/prefix-length>`|any}  
no {deny|permit} {`<ipv6-source-address/prefix-length>`|any}  
no `<sequence-number>`

Parameter	Description
<code>&lt;sequence-number&gt;</code>	<code>&lt;1-65535&gt;</code> The sequence number for the filter entry of the selected access control list.
deny	Specifies the packets to reject.
permit	Specifies the packets to accept.
<code>&lt;ipv6-source-address/prefix-length&gt;</code>	IPv6 source address and prefix-length in the form X::X:X/P.
any	Any IPv6 source host address.

**Mode** IPv6 Standard ACL Configuration

**Default** Any traffic controlled by a software ACL that does not explicitly match a filter is denied.

**Usage** The filter entry will match on any IPv6 packet that has the specified IPv6 source address and prefix length. The parameter `any` may be specified if an address does not matter.

**NOTE:** Software ACLs will **deny** access unless **explicitly permitted** by an ACL action.

**Examples** To add an ACL filter entry with sequence number 5 that will deny any IPv6 packets to the standard IPv6 access-list named `my-list`, enter the commands:

```
awplus# configure terminal
awplus(config)# ipv6 access-list standard my-list
awplus(config-ipv6-std-acl)# 5 deny any
```

To remove the ACL filter entry that will deny any IPv6 packets from the standard IPv6 access-list named `my-list`, enter the commands:

```
awplus# configure terminal
awplus(config)# ipv6 access-list standard my-list
awplus(config-ipv6-std-acl)# no deny any
```

Alternately, to remove the ACL filter entry with sequence number 5 to the standard IPv6 access-list named `my-list`, enter the commands:

```
awplus# configure terminal
awplus(config)# ipv6 access-list standard my-list
awplus(config-ipv6-std-acl)# no 5
```

**Related  
commands**

[ipv6 access-list standard \(named\)](#)  
[show ipv6 access-list \(IPv6 Software ACLs\)](#)  
[show running-config](#)

# show ipv6 access-list (IPv6 Software ACLs)

**Overview** Use this command to display all configured IPv6 access-lists or the IPv6 access-list specified by name.

**Syntax** `show ipv6 access-list [<access-list-name>]`  
`show ipv6 access-list standard [<access-list-name>]`

Parameter	Description
<access-list-name>	Only display information about an IPv6 access-list with the specified name.
standard	Only display information about standard access-lists.

**Mode** User Exec and Privileged Exec

**Example** To show all configured IPv6 access-lists, use the following command:

```
awplus# show ipv6 access-list
```

**Output** Figure 28-1: Example output from **show ipv6 access-list**

```
IPv6 access-list deny_icmp
deny icmp any any vlan 1

IPv6 access-list deny_ssh
deny tcp abcd::0/64 any eq 22
```

**Example** To show the IPv6 access-list named **deny\_icmp**, use the following command:

```
awplus# show ipv6 access-list deny_icmp
```

**Output** Figure 28-2: Example output from **show ipv6 access-list** for a named ACL

```
IPv6 access-list deny_icmp
deny icmp any any vlan 1
```

**Related commands** [ipv6 access-list standard \(named\)](#)  
[\(ipv6 access-list standard filter\)](#)

# vty ipv6 access-class (named)

**Overview** For IPv6, use this command to set a standard named software access list to be the management ACL. This is then applied to all available VTY lines for controlling remote access by Telnet and SSH. This command allows or denies packets containing the IPv6 addresses included in the ACL to create a connection to your device.

ACLs that are attached using this command have an implicit 'deny-all' filter as the final entry in the ACL. A typical configuration is to permit a specific address, or range of addresses, and rely on the 'deny-all' filter to block all other access.

Use the **no** variant of this command to remove the access list.

**Syntax** vty ipv6 access-class <access-name>  
no vty ipv6 access-class [<access-name>]

Parameter	Description
<access-name>	Specify an IPv6 standard software access-list name

**Mode** Global Configuration

**Examples** To set the named standard access-list named **access-ctrl** to be the IPv6 management ACL, use the following commands:

```
awplus# configure terminal  
awplus(config)# vty ipv6 access-class access-ctrl
```

To remove **access-ctrl** from the management ACL, use the following commands:

```
awplus# configure terminal  
awplus(config)# no vty ipv6 access-class access-ctrl
```

**Output** Figure 28-3: Example output from the **show running-config** command

```
awplus#showrunning-config|grep access-class  
  
vty ipv6 access-class access-ctrl
```

**Related commands** show running-config  
vty access-class (numbered)

# 29

# QoS Commands

## Introduction

**Overview** This chapter provides an alphabetical reference for Quality of Service commands. QoS uses ACLs. For more information about ACLs, see the [ACL Feature Overview and Configuration Guide](#).

- Command List**
- ["class"](#) on page 986
  - ["class-map"](#) on page 987
  - ["clear mls qos interface policer-counters"](#) on page 988
  - ["default-action"](#) on page 989
  - ["description \(QoS policy-map\)"](#) on page 990
  - ["egress-rate-limit"](#) on page 991
  - ["egress-rate-limit overhead"](#) on page 992
  - ["match access-group"](#) on page 993
  - ["match cos"](#) on page 995
  - ["match dscp"](#) on page 996
  - ["match eth-format protocol"](#) on page 997
  - ["match ip-precedence"](#) on page 1000
  - ["match mac-type"](#) on page 1001
  - ["match tcp-flags"](#) on page 1002
  - ["match vlan"](#) on page 1003
  - ["mls qos cos"](#) on page 1004
  - ["mls qos enable"](#) on page 1005
  - ["mls qos map cos-queue"](#) on page 1006
  - ["mls qos map premark-dscp"](#) on page 1007



- [“no police”](#) on page 1009
- [“police single-rate action”](#) on page 1010
- [“police twin-rate action”](#) on page 1012
- [“policy-map”](#) on page 1014
- [“priority-queue”](#) on page 1015
- [“remark-map”](#) on page 1016
- [“remark new-cos”](#) on page 1018
- [“service-policy input”](#) on page 1020
- [“show class-map”](#) on page 1021
- [“show mls qos”](#) on page 1022
- [“show mls qos interface”](#) on page 1023
- [“show mls qos interface policer-counters”](#) on page 1026
- [“show mls qos interface queue-counters”](#) on page 1027
- [“show mls qos interface storm-status”](#) on page 1028
- [“show mls qos maps cos-queue”](#) on page 1029
- [“show mls qos maps premark-dscp”](#) on page 1030
- [“show platform classifier statistics utilization brief”](#) on page 1031
- [“show policy-map”](#) on page 1033
- [“storm-action”](#) on page 1034
- [“storm-downtime”](#) on page 1035
- [“storm-protection”](#) on page 1036
- [“storm-rate”](#) on page 1037
- [“storm-window”](#) on page 1038
- [“trust dscp”](#) on page 1039
- [“wrr-queue disable queues”](#) on page 1040
- [“wrr-queue egress-rate-limit queues”](#) on page 1041
- [“wrr-queue weight queues”](#) on page 1042

# class

**Overview** Use this command to associate an existing class-map to a policy or policy-map (traffic classification), and to enter Policy Map Class Configuration mode to configure the class-map.

Use the **no** variant of this command to delete an existing class-map.

If your class-map does not exist, you can create it by using the [class-map](#) command.

**Syntax** `class {<name>|default}`  
`no class <name>`

Parameter	Description
<name>	Name of the (already existing) class-map.
default	Specify the default class-map.

**Mode** Policy Map Configuration

**Example** The following example creates the policy-map `pmap1` (using the `policy-map` command), then associates this to an already existing class-map named `cmap1`, use the commands:

```
awplus# configure terminal
awplus(config)# policy-map pmap1
awplus(config-pmap)# class cmap1
awplus(config-pmap-c)#
```

**Related commands** [class-map](#)  
[policy-map](#)

# class-map

**Overview** Use this command to create a class-map.  
Use the **no** variant of this command to delete the named class-map.

**Syntax** class-map <name>  
no class-map <name>

Parameter	Description
<name>	Name of the class-map to be created.

**Mode** Global Configuration

**Example** This example creates a class-map called `cmap1`, use the commands:

```
awplus# configure terminal
awplus(config)# class-map cmap1
awplus(config-cmap)#
```

# clear mls qos interface policer-counters

**Overview** Resets an interface's policer counters to zero. You can either clear a specific class-map, or you can clear all class-maps by not specifying a class map.

**Syntax** `clear mls qos interface <port> policer-counters [class-map <class-map>]`

Parameter	Description
<port>	The port may be a switch port (e.g. port1.0.4), a static channel group (e.g. sa3), or a dynamic (LACP) channel group (e.g. po4).
class-map	Select a class-map.
<class-map>	Class-map name.

**Mode** Privileged Exec

**Example** To reset the policy counters to zero for all class-maps for port1.0.4, use the command:

```
awplus# clear mls qos interface port1.0.4 policer-counters
```

**Related commands** [show mls qos interface policer-counters](#)

# default-action

**Overview** Sets the action for the default class-map belonging to a particular policy-map. The action for a non-default class-map depends on the action of any ACL that is applied to the policy-map.

The default action can therefore be thought of as specifying the action that will be applied to any data that does not meet the criteria specified by the applied matching commands.

Use the **no** variant of this command to reset to the default action of 'permit'.

**Syntax** `default-action <action>`  
`no default-action`

Parameter	Description
<code>&lt;action&gt;</code> permit	Packets to permit.
deny	Packets to deny.
send-to-cpu	Specify packets to send to the CPU.
copy-to-cpu	Specify packets to copy to the CPU.
copy-to-mirror	Specify packets to copy to the mirror port.
send-to-mirror	Specify packets to send to the mirror port.
send-to-vlan-port vlan <vid> port <port-number>	Send matching packets to the specified port, tagged with the specified VLAN. The specified port must belong to the specified VLAN.

**Default** The default is **permit**.

**Mode** Policy Map Configuration

**Examples** To set the action for the default class-map to deny, use the command:

```
awplus(config-pmap)# default-action deny
```

To set the action for the default class-map to copy-to-mirror for use with the [mirror interface](#) command, use the command:

```
awplus(config-pmap)# default-action copy-to-mirror
```

**Related commands** [mirror interface](#)

## description (QoS policy-map)

**Overview** Adds a textual description of the policy-map. This can be up to 80 characters long. Use the **no** variant of this command to remove the current description from the policy-map.

**Syntax** `description <line>`  
`no description`

Parameter	Description
<code>&lt;line&gt;</code>	Up to 80 character long line description.

**Mode** Policy Map Configuration

**Example** To add the description, VOIP traffic, use the command:  
`awplus(config-pmap)# description VOIP traffic`

# egress-rate-limit

**Overview** Use this command to limit the amount of traffic that can be transmitted per second from this port.

Use the **no** variant of this command to disable the limiting of traffic egressing on the interface.

**Syntax** `egress-rate-limit <rate-limit>`  
`no egress-rate-limit`

Parameter	Description
<code>&lt;rate-limit&gt;</code>	Bandwidth <1-10000000 units per second> (usable units: k, m, g). The egress rate limit can be configured in multiples of 64kbps. If you configure a value that is not an exact multiple of 64kbps, then the value will be rounded up to the nearest higher exact multiple of 64kbps. The minimum is 64 Kb. The default unit is Kb ( <b>k</b> ), but Mb ( <b>m</b> ) or Gb ( <b>g</b> ) can also be specified. The command syntax is not case sensitive, so a value such as 20m or 20M will be interpreted as 20 megabits.

**Mode** Interface Configuration

**Examples** To enable egress rate limiting on a port, with a limit of approximately 500Mbps, use the commands:

```
awplus# configure terminal
awplus(config)# interface port1.0.1
awplus(config-if)# egress-rate-limit 500m
```

To disable egress rate limiting on a port, use the commands:

```
awplus# configure terminal
awplus(config)# interface port1.0.1
awplus(config-if)# no egress-rate-limit
```

**Related commands** [egress-rate-limit overhead](#)

# egress-rate-limit overhead

**Overview** Use this command to allow for the size of packet preamble and inter-packet gap (the “overhead”) in egress queue rate limiting on switch ports.

Doing this keeps the rate limit at the same percentage of line rate for all packet sizes. Otherwise, the percentage of line rate changes with packet size, because of the size of the overhead relative to smaller packets. This means smaller packets take up a larger percentage of the line rate.

Use the **no** variant of this command to turn off the overhead allowance.

**Syntax** `egress-rate-limit overhead <bytes>`  
`no egress-rate-limit overhead`

Parameter	Description
<code>&lt;bytes&gt;</code>	The number of bytes to allow for overhead. For standard ethernet packets, use a value of 20 bytes (8 bytes of preamble and a inter-packet gap of 12 bytes).

**Default** No overhead allowance

**Mode** Interface Configuration

**Example** To configure an overhead allowance of 20 bytes (8 bytes of preamble and a inter-packet gap of 12 bytes) on port1.0.1, use the commands:

```
awplus# configure terminal
awplus(config)# interface port1.0.1
awplus(config-if)# egress-rate-limit overhead 20
```

To return port1.0.1 to the default of no overhead allowance, use the commands:

```
awplus# configure terminal
awplus(config)# interface port1.0.1
awplus(config-if)# no egress-rate-limit overhead
```

**Related commands** [egress-rate-limit](#)

**Command changes** Version 5.4.9-2.1: command added



# match access-group

**Overview** Use this command to apply an ACL to a class-map or VLAN.

Use the **no** variant of this command to remove the match.

**Syntax** `match access-group { <hw-IP-ACL> | <hw-MAC-ACL> | <hw-named-ACL> }`  
`no match access-group`  
`{ <hw-IP-ACL> | <hw-MAC-ACL> | <hw-named-ACL> }`

Parameter	Description
<hw-IP-ACL>	Specify a hardware IP ACL number in the range <3000-3699>.
<hw-MAC-ACL>	Specify a hardware MAC ACL number in the range <4000-4699>.
<hw-named-ACL>	Specify a hardware named ACL (IP, IPv6 or MAC address entries).

**Mode** Class Map or VLAN Access-Map

**Usage notes** First create an access-list that applies the appropriate action to matching packets. Then use the **match access-group** command to apply this access-list as desired. Note that this command will apply the access-list matching only to *incoming* data packets.

**Examples** To configure a class-map named "cmap1", which matches traffic against access-list 3001, which allows IP traffic from any source to any destination, use the commands:

```
awplus# configure terminal
awplus(config)# access-list 3001 permit ip any any
awplus(config)# class-map cmap1
awplus(config-cmap)# match access-group 3001
```

To configure a class-map named "cmap2", which matches traffic against access-list 4001, which allows MAC traffic from any source to any destination, use the commands:

```
awplus# configure terminal
awplus(config)# access-list 4001 permit any any
awplus(config)# class-map cmap2
awplus(config-cmap)# match access-group 4001
```

To configure a class-map named "cmap3", which matches traffic against access-list "hw\_acl", which allows IP traffic from any source to any destination, use the commands:

```
awplus# configure terminal
awplus(config)# access-list hardware hw_acl
awplus(config-ip-hw-acl)# permit ip any any
awplus(config)# class-map cmap3
awplus(config-cmap)# match access-group hw_acl
```

To apply ACL 3001 to VLAN 48, where the ACL drops IP traffic from any source to any destination, use the commands:

```
awplus# configure terminal
awplus(config)# access-list 3001 deny ip any any
awplus(config)# vlan access-map deny_all
awplus(config-vlan-access-map)# match access-group 3001
awplus(config-vlan-access-map)# exit
awplus(config)# vlan filter deny_all vlan-list 48 input
```

**Related commands** [class-map](#)  
[vlan access-map](#)

**Command changes** Version 5.4.6-2.1: support for VLAN access-maps added

# match cos

**Overview** Use this command to define a COS to match against incoming packets.  
Use the **no** variant of this command to remove CoS.

**Syntax** `match cos <0-7>`  
`no match cos`

Parameter	Description
<0-7>	Specify the CoS value.

**Mode** Class Map Configuration

**Examples** To set the class-map's CoS to 4, use the commands:

```
awplus# configure terminal
awplus(config)# class-map cmap1
awplus(config-cmap)# match cos 4
```

To remove CoS from a class-map, use the commands:

```
awplus# configure terminal
awplus(config)# class-map cmap1
awplus(config-cmap)# no match cos
```

# match dscp

**Overview** Use this command to define the DSCP to match against incoming packets. Use the **no** variant of this command to remove a previously defined DSCP.

**Syntax** `match dscp <0-63>`  
`no match dscp`

Parameter	Description
<0-63>	Specify DSCP value (only one value can be specified).

**Mode** Class Map Configuration

**Usage** Use the **match dscp** command to define the match criterion after creating a class-map.

**Examples** To configure a class-map named `cmap1` with criterion that matches DSCP 56, use the commands:

```
awplus# configure terminal
awplus(config)# class-map cmap1
awplus(config-cmap)# match dscp 56
```

To remove a previously defined DSCP from a class-map named `cmap1`, use the commands:

```
awplus# configure terminal
awplus(config)# class-map cmap1
awplus(config-cmap)# no match dscp
```

**Related commands** [class-map](#)

# match eth-format protocol

**Overview** This command sets the Ethernet format and the protocol for a class-map to match on.

Select one Layer 2 format and one Layer 3 protocol when you issue this command.

Use the **no** variant of this command to remove the configured Ethernet format and protocol from a class-map.

**Syntax** `match eth-format <layer-two-format> protocol  
<layer-three-protocol>`

`no match eth-format protocol`

The following eth-formats and protocols are available (note that not all options are available on all AlliedWare Plus switch models):

Parameter	Description
<i>&lt;layer-two-formats&gt;</i>	
802dot2-tagged	802.2 Tagged Packets (enter the parameter name).
802dot2-untagged	802.2 Untagged Packets (enter the parameter name).
ethii-tagged	EthII Tagged Packets (enter the parameter name).
ethii-untagged	EthII Untagged Packets (enter the parameter name).
ethii-any	EthII Tagged or Untagged Packets (enter the parameter name).
netwareraw-tagged	Netware Raw Tagged Packets (enter the parameter name).
netwareraw-untagged	Netware Raw Untagged Packets (enter the parameter name).
snap-tagged	SNAP Tagged Packets (enter the parameter name).
snap-untagged	SNAP Untagged Packets (enter the parameter name).
<i>&lt;layer-three-protocols&gt;</i>	
<word>	A Valid Protocol Number in hexadecimal.
any	Note that the parameter "any" is only valid when used with the netwarerawtagged and netwarerawuntagged protocol options.
sna-path-control	Protocol Number 04 (enter the parameter name or its number).
proway-lan	Protocol Number 0E (enter the parameter name or its number).
eia-rs Protocol	Number 4E (enter the parameter name or its number).
proway Protocol	Number 8E (enter the parameter name or its number).

Parameter	Description
ipx-802dot2	Protocol Number E0 (enter the parameter name or its number).
netbeui	Protocol Number F0 (enter the parameter name or its number).
iso-clns-is	Protocol Number FE (enter the parameter name or its number).
xdot75-internet	Protocol Number 0801 (enter the parameter name or its number).
nbs-internet	Protocol Number 0802 (enter the parameter name or its number).
ecma-internet	Protocol Number 0803 (enter the parameter name or its number).
chaosnet	Protocol Number 0804 (enter the parameter name or its number).
xdot25-level-3	Protocol Number 0805 (enter the parameter name or its number).
arp Protocol	Number 0806 (enter the parameter name or its number).
xns-compat	Protocol Number 0807 (enter the parameter name or its number).
banyan-systems	Protocol Number 0BAD (enter the parameter name or its number).
bbn-simnet	Protocol Number 5208 (enter the parameter name or its number).
dec-mop-dump-ld	Protocol Number 6001 (enter the parameter name or its number).
dec-mop-rem-cdons	Protocol Number 6002 (enter the parameter name or its number).
dec-decnet	Protocol Number 6003 (enter the parameter name or its number).
dec-lat	Protocol Number 6004 (enter the parameter name or its number).
dec-diagnostic	Protocol Number 6005 (enter the parameter name or its number).
dec-customer	Protocol Number 6006 (enter the parameter name or its number).
dec-lavc	Protocol Number 6007 (enter the parameter name or its number).
rarp	Protocol Number 8035 (enter the parameter name or its number).
dec-lanbridge	Protocol Number 8038 (enter the parameter name or its number).

Parameter	Description
dec-encryption	Protocol Number 803D (enter the parameter name or its number).
appletalk	Protocol Number 809B (enter the parameter name or its number).
ibm-sna	Protocol Number 80D5 (enter the parameter name or its number).
appletalk-aarp	Protocol Number 80F3 (enter the parameter name or its number).
snmp	Protocol Number 814CV.
ethertalk-2	Protocol Number 809B (enter the parameter name or its number).
ethertalk-2-aarp	Protocol Number 80F3 (enter the parameter name or its number).
ipx-snap	Protocol Number 8137 (enter the parameter name or its number).
ipx-802dot3	Protocol Number FFFF (enter the parameter name or its number).
ip	Protocol Number 0800 (enter the parameter name or its number).
ipx	Protocol Number 8137 (enter the parameter name or its number).
ipv6	Protocol Number 86DD (enter the parameter name or its number).

**Mode** Class Map Configuration

**Examples** To set the eth-format to ethii-tagged and the protocol to 0800 (IP) for class-map cmap1, use the commands:

```
awplus# configure terminal
awplus(config)# class-map cmap1
awplus(config-cmap)# match eth-format ethii-tagged protocol
0800
awplus(config-cmap)# match eth-format ethii-tagged protocol ip
```

To remove the eth-format and the protocol from the class-map cmap1, use the commands:

```
awplus# configure terminal
awplus(config)# class-map cmap1
awplus(config-cmap)# no match eth-format protocol
```

# match ip-precedence

**Overview** Use this command to identify IP precedence values as match criteria.  
Use the **no** variant of this command to remove IP precedence values from a class-map.

**Syntax** `match ip-precedence <0-7>`  
`no match ip-precedence`

Parameter	Description
<0-7>	The precedence value to be matched.

**Mode** Class Map Configuration

**Example** To configure a class-map named `cmap1` to match all IPv4 packets with a precedence value of 5, use the commands:

```
awplus# configure terminal
awplus(config)# class-map cmap1
awplus(config-cmap)# match ip-precedence 5
```



# match mac-type

**Overview** Use this command to set the MAC type for a class-map to match on.  
Use **no** variant of this command to remove the MAC type match entry.

**Syntax** `match mac-type {l2broadcast|l2multicast|l2unicast}`  
`no match mac-type`

Parameter	Description
l2broadcast	Layer 2 Broadcast traffic.
l2multicast	Layer 2 Multicast traffic.
l2unicast	Layer 2 Unicast traffic.

**Mode** Class Map Configuration

**Examples** To set the class-map's MAC type to Layer 2 multicast, use the commands:

```
awplus# configure terminal
awplus(config)# class-map cmap1
awplus(config-cmap)# match mac-type l2multicast
```

To remove the class-map's MAC type entry, use the commands:

```
awplus# configure terminal
awplus(config)# class-map cmap1
awplus(config-cmap)# no match mac-type
```

# match tcp-flags

**Overview** Sets one or more TCP flags (control bits) for a class-map to match on.  
Use the **no** variant of this command to remove one or more TCP flags for a class-map to match on.

**Syntax** `match tcp-flags [ack] [fin] [psh] [rst] [syn] [urg]`  
`no match tcp-flags [ack] [fin] [psh] [rst] [syn] [urg]`

Parameter	Description
ack	Acknowledge.
fin	Finish.
psh	Push.
rst	Reset.
syn	Synchronize.
urg	Urgent.

**Mode** Class Map Configuration

**Examples** To set the class-map's TCP flags to **ack** and **syn**, use the commands:

```
awplus# configure terminal
awplus(config)# class-map
awplus(config-cmap)# match tcp-flags ack syn
```

To remove the TCP flags **ack** and **rst**, use the commands:

```
awplus# configure terminal
awplus(config)# class-map
awplus(config-cmap)# no match tcp-flags ack rst
```

# match vlan

**Overview** Use this command to define the VLAN ID as match criteria.  
Use the **no** variant of this command to disable the VLAN ID used as match criteria.

**Syntax** `match vlan <1-4094>`  
`no match vlan`

Parameter	Description
<code>&lt;1-4094&gt;</code>	The VLAN number.

**Mode** Class Map Configuration

**Examples** To configure a class-map named `cmap1` to include traffic from VLAN 3, use the commands:

```
awplus# configure terminal
awplus(config)# class-map cmap1
awplus(config-cmap)# match vlan 3
```

To disable the configured VLAN ID as a match criteria for the class-map named `cmap1`, use the commands:

```
awplus# configure terminal
awplus(config)# class-map cmap1
awplus(config-cmap)# no match vlan
```

# mls qos cos

**Overview** This command assigns a CoS (Class of Service) user-priority value to untagged frames entering a specified interface. By default, all untagged frames are assigned a CoS value of 0.

Use the **no** variant of this command to return the interface to the default CoS setting for untagged frames entering the interface.

**Syntax** `mls qos cos <0-7>`  
`no mls qos cos`

Parameter	Description
<0-7>	The Class of Service, user-priority value.

**Default** By default, all untagged frames are assigned a CoS value of 0. Note that for tagged frames, the default behavior is not to alter the CoS value.

**Mode** Interface Configuration

**Example** To assign a CoS user priority value of 2 to all untagged packets entering port1.0.1 to port1.0.4, use the commands:

```
awplus# configure terminal
awplus(config)# interface port1.0.1-port1.0.4
awplus(config-if)# mls qos cos 2
```

# mls qos enable

**Overview** Use this command to enable QoS.

Use the **no** variant of this command to globally disable QoS and remove all QoS configuration. The **no** variant of this command removes all class-maps, policy-maps, and policers that have been created. Running the **no mls qos** command will therefore remove all pre-existing QoS configurations on the switch.

**Mode** Global Configuration

**Syntax** `mls qos enable`  
`no mls qos`

**Example** To enable QoS on the switch, use the commands:

```
awplus# configure terminal
awplus(config)# mls qos enable
```

# mls qos map cos-queue

**Overview** Use this command to set the default CoS to egress queue mapping. This is the default queue mapping for packets that do not get assigned an egress queue via any other QoS functionality.

Use the **no** variant of this command to reset the cos-queue map back to its default setting. The default mappings for this command are:

CoS Priority :	0	1	2	3	4	5	6	7
-----								
CoS QUEUE:	2	0	1	3	4	5	6	7

**Syntax** `mls qos map cos-queue <cos-priority> to <queue-number>`  
`no mls qos map cos-queue`

Parameter	Description
<cos-priority>	CoS priority value. Can take a value between 0 and 7.
<queue-number>	Queue number. Can take a value between 0 and 7.

**Mode** Global Configuration

**Examples** To map CoS 2 to queue 0, use the command:

```
awplus# configure terminal  
awplus(config)# mls qos map cos-queue 2 to 0
```

To set the cos-queue map back to its defaults, use the command:

```
awplus# configure terminal  
awplus(config)# no mls qos map cos-queue
```

**Related commands** [show mls qos interface](#)

# mls qos map premark-dscp

**Overview** This command configures the premark-dscp map. It is used when traffic is classified by a class-map that has **trust dscp** configured. Based on a lookup DSCP, the map determines new QoS settings for the traffic.

The **no** variant of this command resets the premark-dscp map to its defaults. If no DSCP is specified then all DSCP entries will be reset to their defaults.

**Syntax**

```
mls qos map premark-dscp <0-63> to  
{[new-dscp <0-63>][new-cos <0-7>]  
[new-bandwidth-class {green|yellow|red}]}
```

```
no mls qos map premark-dscp [<0-63>]
```

Parameter	Description
premark-dscp <0-63>	The DSCP value on ingress.
new-dscp <0-63>	The DSCP value that the packet will have on egress. If unspecified, this value will remain the DSCP ingress value.
new-cos <0-7>	The CoS value that the packet will have on egress. If unspecified, this value will retain its value on ingress.
new-bandwidth-class	Modify Egress Bandwidth-class. If unspecified, this value will be set to green.
green	Egress Bandwidth-class green (marked down Bandwidth-class).
yellow	Egress Bandwidth-class yellow (marked down Bandwidth-class).
red	Egress Bandwidth-class red (marked down Bandwidth-class).

**Mode** Global Configuration

**Usage notes** With the **trust dscp** command set, this command (**mls qos map premark-dscp**) enables you to remap the DSCP, CoS, output queue, or bandwidth class values.

However, note that you cannot simultaneously change the DSCP and CoS, because they use the same byte in the IP header.

**Example** To set the entry for DSCP 1 to use a new DSCP of 2, use the command:

```
awplus# configure terminal  
awplus(config)# mls qos map premark-dscp 1 to new-dscp 2
```

**Example** To set the entry for DSCP 1 to use a new CoS of 3, and a new bandwidth class of yellow, use the command:

```
awplus# configure terminal
awplus(config)# mls qos map premark-dscp 1 to new-cos 3
new-bandwidth-class yellow
```

**Example** To reset the entry for DSCP 1 use the command:

```
awplus# configure terminal
awplus(config)# no mls qos map premark-dscp 1
```

**Related commands** [show mls qos maps premark-dscp](#)  
[trust dscp](#)



# no police

**Overview** Use this command to disable any policer previously configured on the class-map.

**Syntax** no police

**Mode** Policy Map Class Configuration

**Usage notes** This command disables any policer previously configured on the class-map.

**Example** To disable policing on a class-map, use the commands:

```
awplus# configure terminal
awplus(config)# policy-map name
awplus(config-pmap)# class classname
awplus(config-pmap-c)# no police
```

**Related commands** [police single-rate action](#)  
[police twin-rate action](#)

# police single-rate action

**Overview** Configures a single-rate policer for a class-map.

**Syntax** `police single-rate <cir> <cbs> <ebs> action  
{drop-red|remark-transmit}`

Parameter	Description
<cir>	Specify the Committed Information Rate (CIR) (1-100000000 kbps).
<cbs>	Specify the Committed Burst Size (CBS) (0-16777216 bytes).
<ebs>	Specify a Excess Burst Size (EBS) (0-16777216 bytes).
action	Specify the action if the rate is exceeded.
drop-red	Drop the red packets.
remark-transmit	Modify the packets using the remark map, then transmit. You can configure the remark map using the <a href="#">remark-map</a> command.

**Mode** Policy Map Class Configuration

**Usage notes** You can use a policer to meter the traffic classified by the class-map and assign it to one of three bandwidth classes.

The bandwidth classes are green (conforming), yellow (partially-conforming), and red (non-conforming). A single-rate policer is based on three values. These are the average rate, minimum burst and maximum burst.

Color	Definition
green	The traffic rate is less than the average rate and minimum burst.
yellow	The traffic rate is between the minimum burst and the maximum burst.
red	The traffic rate exceeds the average rate and the maximum burst.

Using an action of drop-red means that any packets classed as red are discarded.

**NOTE:** *This command will not take effect when applied to a class-map that attaches to a channel group whose ports span processor instances.*

Note that the [remark-map](#) does not only apply to red traffic. If a remark-map is configured on the same class-map as the policer, then the remark-map will apply to green- colored and yellow-colored traffic irrespective of the value configured on the **action** parameter of the policer. So, even if **action** is configured to **drop-red**, the remark-map will be applied to green and yellow traffic. So, the **action** parameter only applies to red- colored traffic. If **action** is set to **drop-red**, then red

traffic is dropped; if **action** is set to **remark-transmit**, then the red traffic has the action of the remark map applied to it, and is then transmitted.

**Example** To configure a single rate meter measuring traffic of 100 Mbps that drops a sustained burst of traffic over this rate, use the commands:

```
awplus# configure terminal
awplus(config)# policy-map name
awplus(config-pmap)# class classname
awplus(config-pmap-c)# police single-rate 100000 1875000
1875000 action drop-red
```

**Related commands**

- [no police](#)
- [police twin-rate action](#)
- [remark-map](#)

# police twin-rate action

**Overview** Configures a twin-rate policer for a class-map.

**Syntax** `police twin-rate <cir> <pir> <cbs> <pbs> action  
{drop-red|remark-transmit}`

Parameter	Description
<cir>	Specify the Committed Information Rate (CIR) (1-100000000 kbps).
<pir>	Specify the Peak Information Rate (PIR) (1-100000000 kbps).
<cbs>	Specify the Committed Burst Size (CBS) (0-16777216 bytes).
<pbs>	Specify the Peak Burst Size (PBS) (0-16777216 bytes).
action	Specify the action if rate is exceeded.
drop-red	Drop the red packets.
remark-transmit	Modify the packets using the remark map, then transmit. You can configure the remark map using the <a href="#">remark-map</a> command.

**Mode** Policy Map Class Configuration

**Usage notes** A policer can be used to meter the traffic classified by the class-map and as a result will be given one of three bandwidth classes. These are green (conforming), yellow (partially-conforming), and red (non-conforming).

A twin-rate policer is based on four values. These are the minimum rate (CIR), minimum burst size (CBS), maximum rate (PIR), and maximum burst size (PBS). The following table shows how these values define the bandwidth classes.

Bandwidth Class	Definition
green	The sum of the number of existing (buffered) bytes plus those arriving at the port per unit time results in a value that is less than that set for the CBS.
yellow	The sum of the number of existing (buffered) bytes plus those arriving at the port per unit time results in a value that is between those set for the CBS and the PBS.
red	The sum of the number of existing (buffered) bytes plus those arriving at the port per unit time results in a value that exceeds that set for the PBS.

Using an action of drop-red means that any packets classed as red will be discarded.

Using an action of remark-transmit means that the packet will be remarked with the values configured in the policed-dscp map. The index into this map is determined by the DSCP in the packet.

Note that the [remark-map](#) does not only apply to red traffic. If a remark-map is configured on the same class-map as the policer, then the remark-map will apply to green-colored and yellow-colored traffic irrespective of the value configured on the **action** parameter of the policer. So, even if **action** is configured to **drop-red**, the remark-map will be applied to green and yellow traffic. So, the **action** parameter only applies to red-colored traffic. If **action** is set to **drop-red**, then red traffic is dropped; if **action** is set to **remark-transmit**, then the red traffic has the action of the remark map applied to it, and is then transmitted.

**Example** To configure a twin rate meter measuring a minimum rate of 10 Mbps and a maximum rate of 20 Mbps, and drop red packets, use the commands:

```
awplus# configure terminal
awplus(config)# policy-map name
awplus(config-pmap)# class classname
awplus(config-pmap-c)# police twin-rate 10000 20000 1875000
3750000 action drop-red
```

To configure a twin rate meter measuring a minimum rate of 10 Mbps and a maximum rate of 20 Mbps that uses the remark map to remark any non-conforming traffic, use the commands:

```
awplus# configure terminal
awplus(config)# policy-map name
awplus(config-pmap)# class classname
awplus(config-pmap-c)# police twin-rate 10000 20000 1875000
3750000 action remark-transmit
```

**Related commands** [no police](#)  
[police single-rate action](#)

# policy-map

**Overview** Use this command to create a policy-map and to enter Policy Map Configuration mode to configure the specified policy-map.

Use the **no** variant of this command to delete an existing policy-map.

**Syntax** `policy-map <name>`  
`no policy-map <name>`

Parameter	Description
<code>&lt;name&gt;</code>	Name of the policy-map.

**Mode** Global Configuration

**Example** To create a policy-map called pmap1, use the commands:

```
awplus# configure terminal
awplus(config)# policy-map pmap1
awplus(config-pmap)#
```

**Related commands** [class-map](#)

# priority-queue

**Overview** This command configures strict priority-based scheduling on the specified egress queues. You must specify at least one queue.

**Syntax** `priority-queue [0][1][2][3][4][5][6][7]`

Parameter	Description
[0][1]...[7]	Specify the queues that will use strict priority scheduling. With strict priority scheduling, the switch will completely empty the highest numbered queue first, then start processing the next lowest numbered queue.

**Mode** Interface Configuration.

**Usage notes** By default, the queues on all ports are set for priority queuing. You can change the queue emptying sequence to weighted round robin, by using the [wrr-queue weight queues](#) command. You can then use the [priority-queue](#) command to reset the selected queues to priority queuing.

Note that the emptying sequence for priority queuing is always highest queue number to lowest queue number.

**Example** To apply priority-based scheduling to egress queues 1 and 2, use the commands:

```
awplus#configure terminal
awplus(config)#interface port1.0.1
awplus(config-if)#priority-queue 1 2
```

**Related commands** [show mls qos interface](#)  
[show mls qos interface queue-counters](#)  
[wrr-queue weight queues](#)

# remark-map

**Overview** Use this command to configure the remark map. If a re-mark map is applied to a class, and a policer is also applied to the same class, then:

- green and yellow traffic will all be acted upon by the remark-map, and
- red traffic will be either dropped or acted upon by the remark-map, depending on whether the policer **action** is set to **drop-red** or **remark-transmit**.

The **no** variant of this command resets the remark map to its defaults. Specifying the bandwidth class is optional. If no bandwidth class is specified, then all bandwidth classes are reset to their defaults.

**Syntax** remark-map [bandwidth-class {green|yellow|red}] to {[new-dscp <0-63>] [new-bandwidth-class {green|yellow|red}]}

no remark-map [bandwidth-class {green|yellow|red}] to {[new-dscp <0-63>] [new-bandwidth-class {green|yellow|red}]}

Parameter	Description
bandwidth-class	Specify the bandwidth class of packets to remark.
green	Remark green packets.
yellow	Remark yellow packets.
red	Remark red packets.
new-dscp	Specify the new DSCP value.
<0-63>	The DSCP value.
new-bandwidth-class	Specify the new bandwidth class.
green	Remark the packet green.
yellow	Remark the packet yellow.
red	Remark the packet red.

**Mode** Policy Map Class Configuration

**Examples** To remark the policed green traffic to a new DSCP of 2 and a new bandwidth class of yellow, use the commands:

```
awplus# configure terminal
awplus(config)# policy-map pmap1
awplus(config-pmap)# class cmap1
awplus(config-pmap-c)# remark-map bandwidth-class green to
new-dscp 2 new-bandwidth-class yellow
```



To remark the policed green traffic to a new DSCP of 2, use the commands:

```
awplus# configure terminal
awplus(config)# policy-map pmap1
awplus(config-pmap)# class cmap1
awplus(config-pmap-c)# remark-map bandwidth-class green to
new-dscp 2
```

To reset the DSCP for all bandwidth classes, use the commands:

```
awplus# configure terminal
awplus(config)# policy-map pmap1
awplus(config-pmap)# class cmap1
awplus(config-pmap-c)# no remark-map to new-dscp
```

**Related commands** [police single-rate action](#)  
[police twin-rate action](#)

# remark new-cos

**Overview** This command enables you to configure and remark either or both of:

- the CoS flag in the data packet
- the input into the CoS to queue map, thus changing the destination egress queue.

**Syntax** `remark new-cos <0-7> [internal|external|both]`  
`no remark new-cos [internal|external|both]`

Parameter	Description
<0-7>	The new value for the CoS flag and/or the input into the CoS to queue map.
external	Remarks the CoS flag in the packet.
internal	Remarks the new-CoS input into the CoS to queue map.
both	Remarks (with the same value) both the CoS flag in the packet and the input to the CoS to queue map.

**Mode** Policy Map Class Configuration

**Usage notes** The default CoS to Queue mappings are shown in the following table:

CoS Value	0	1	2	3	4	5	6	7
Egress Queue No	2	0	1	3	4	5	6	7

The relationship between this command and the CoS to queue map is shown in the following figure.

Figure 29-1: Remarking and the CoS to Q map

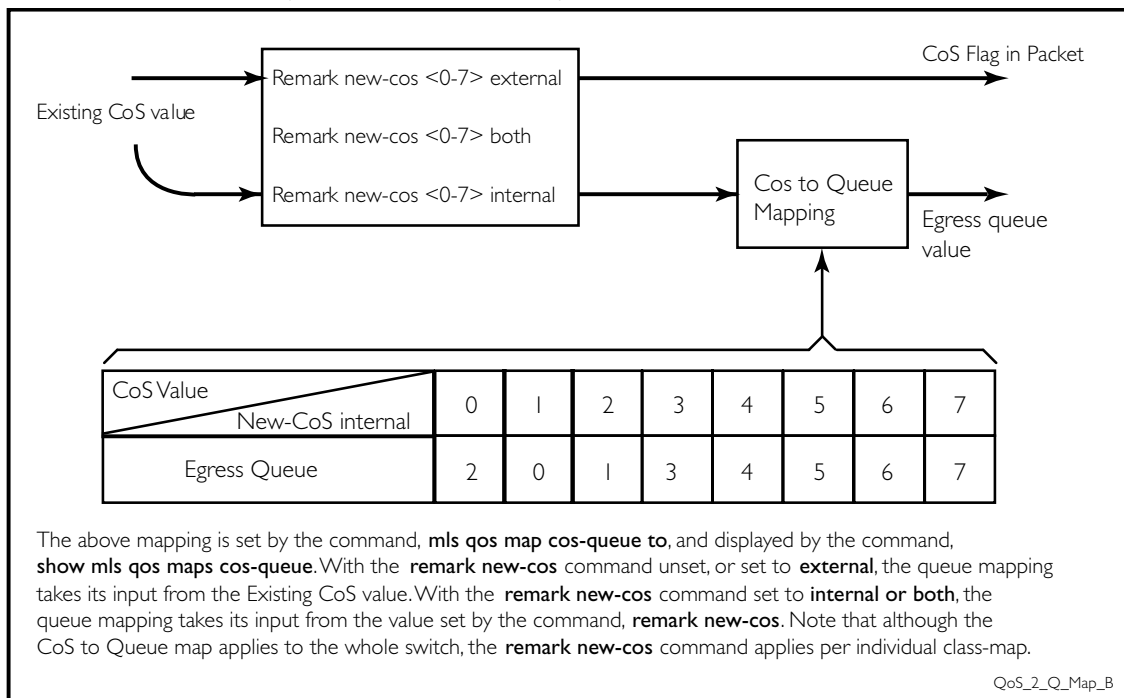

Table 29-1: CoS to egress queue remarking function

Input	Command	Output
CoS field = 1	Remark new-cos (not configured)	CoS value = 1 Packet sent to egress queue 0
CoS field = 1	Remark new-cos 2 external	CoS value = 2 Packet sent to egress queue 0
CoS set to 1	Remark new-cos 2 internal	CoS value = 1 Packet sent to egress queue 1
CoS set to 1	Remark new-cos 2 both	CoS value = 2 Packet sent to egress queue 1
Note: This table assumes that the CoS to Queue map is set to its default values.		

**Example** For policy-map “pmap3” and class-map “cmap1”, set the CoS value to 2 and also set the input to the CoS to queue map so that the traffic is assigned to egress queue 1:

```
awplus# configure terminal
awplus(config)# policy-map pmap3
awplus(config-pmap)# class cmap1
awplus(config-pmap-c)# remark new-cos 2 both
```

**Related commands** [mls qos map cos-queue](#)  
[show mls qos maps cos-queue](#)

# service-policy input

**Overview** Use this command to apply a policy-map to the input of an interface.  
Use the **no** variant of this command to remove a policy-map and interface association.

**Syntax** `service-policy input <policy-map>`  
`no service-policy input <policy-map>`

Parameter	Description
<code>&lt;policy-map&gt;</code>	Policy map name that will be applied to the input.

**Mode** Interface Configuration

**Usage notes** This command can be applied to switch ports or static channel groups, but not to dynamic (LACP) channel groups.

**Example** To apply a policy-map named `pmap1` to interface `port1.0.2`, use the commands:

```
awplus# configure terminal
awplus(config)# interface port1.0.2
wplus(config-if)# service-policy input pmap1
```

# show class-map

**Overview** Use this command to display the QoS class-maps' criteria for classifying traffic.

**Syntax** `show class-map [<class-map-name>]`

Parameter	Description
<i>&lt;class-map-name&gt;</i>	Name of the class-map.

**Mode** User Exec and Privileged Exec

**Example** To display a QoS class-map's match criteria for classifying traffic, use the command:

```
awplus# show class-map cmap1
```

**Output** Figure 29-2: Example output from the **show class-map** command

```
awplus#show class-map

CLASS-MAP-NAME: myClass
Match Mac Type: 2 12mcast

CLASS-MAP-NAME: default
```

**Related commands** [class-map](#)

# show mls qos

**Overview** Use this command to display whether QoS is enabled or disabled on the switch.

**Syntax** `show mls qos`

**Mode** User Exec and Privileged Exec

**Example** To display whether QoS is enabled or disabled, use the command:

```
awplus# show mls qos
```

**Output** Figure 29-3: Example output from the **show mls qos** command

```
awplus#show mls qos
Enable
```

**Related commands** [mls qos enable](#)

# show mls qos interface

**Overview** Displays the current settings for the interface. This includes its default CoS and queue, scheduling used for each queue, and any policies/maps that are attached.

**Syntax** `show mls qos interface [<port>]`

Parameter	Description
<port>	Switch port.

**Mode** User Exec and Privileged Exec

**Example** To display current CoS and queue settings for interface port1.0.1, use the command:

```
awplus# show mls qos interface port1.0.1
```

**Output** Figure 29-4: Example output from the **show mls qos interface** command for port1.0.1

```
awplus#show mls qos interface port1.0.1
Interface: port1.0.1

Number of egress queues: 8

Egress Queue:      0
  Status:          Enabled
  Scheduler:       Strict Priority
  Queue Limit:     12%
  Egress Rate Limit: 0 Kb

Egress Queue:      1
  Status:          Enabled
  Scheduler:       Strict Priority
  Queue Limit:     12%
  Egress Rate Limit: 0 Kb
```

```
Egress Queue:      2
  Status:          Enabled
  Scheduler:       Strict Priority
  Queue Limit:     12%
  Egress Rate Limit: 0 Kb
Egress Queue:      3
  Status:          Enabled
  Scheduler:       Wrr Group 2
  Weight:          10
  Queue Limit:     12%
  Egress Rate Limit: 0 Kb
Egress Queue:      4
  Status:          Enabled
  Scheduler:       Wrr Group 1
  Weight:          10
  Queue Limit:     12%
  Egress Rate Limit: 0 Kb
Egress Queue:      5
  Status:          Enabled
  Scheduler:       Strict Priority
  Queue Limit:     12%
  Egress Rate Limit: 0 Kb
Egress Queue:      6
  Status:          Enabled
  Scheduler:       Strict Priority
  Queue Limit:     12%
  Egress Rate Limit: 0 Kb
Egress Queue:      7
  Status:          Enabled
  Scheduler:       Strict Priority
  Queue Limit:     12%
  Egress Rate Limit: 0 Kb
Trust Mode: Ports default priority
Port Default Priority: 0
VLAN Priority Override: Not Configured
Egress Traffic Shaping Overhead: 20
Egress Traffic Shaping: Not Configured
  The number of COS Values mapped: 8
  Cos (Queue): 0(0), 1(0), 2(0), 3(0), 4(0), 5(0), 6(0), 7(0)
  Dscp (Queue): 0(0), 1(0), 2(0), 3(0), 4(0), 5(0), 6(0), 7(0)
  Dscp (Queue): 8(0), 9(0), 10(0), 11(0), 12(0), 13(0), 14(0), 15(0)
  Dscp (Queue): 16(0), 17(0), 18(0), 19(0), 20(0), 21(0), 22(0), 23(0)
  Dscp (Queue): 24(0), 25(0), 26(0), 27(0), 28(0), 29(0), 30(0), 31(0)
  Dscp (Queue): 32(0), 33(0), 34(0), 35(0), 36(0), 37(0), 38(0), 39(0)
  Dscp (Queue): 40(0), 41(0), 42(0), 43(0), 44(0), 45(0), 46(0), 47(0)
  Dscp (Queue): 48(0), 49(0), 50(0), 51(0), 52(0), 53(0), 54(0), 55(0)
  Dscp (Queue): 56(0), 57(0), 58(0), 59(0), 60(0), 61(0), 62(0), 63(0)
```



Table 29-2: Parameters in the output of the show mls qos interface command

Parameter	Description
Number of egress queues	The total number of egress queues available on this interface.
Egress Queue	Number of this egress queue.
Status	Queue can either be enabled or disabled.
Scheduler	The scheduling mode being used for servicing the transmission of packets on this port.
Queue Limit	The percentage of the port's buffers that have been allocated to this queue.
Egress Rate Limit	The amount of traffic that can be transmitted via this queue per second. 0 Kb means there is currently no rate-limiting enabled.
Egress Traffic Shaping Overhead	The number of bytes specified to allow for the size of packet preamble and inter-packet gap (the "overhead") in egress queue rate limiting. Use the <code>egress-rate-limit overhead</code> command to change this.

# show mls qos interface policer-counters

**Overview** This command displays an interface's policer counters. This can either be for a specific class-map or for all class-maps attached to the interface. If no class-map is specified then all class-map policer counters attached to the interface are displayed.

**Syntax** `show mls qos interface <port> policer-counters [class-map <class-map>]`

Parameter	Description
<port>	Switch port.
class-map	Select a class-map.
<class-map>	Class-map name.

**Mode** User Exec and Privileged Exec

**Usage** Note that:

- The hardware does not record distinct counters for the number of Green or Yellow bytes, so the field marked Green/Yellow is the summation of bytes that have been marked Green or Yellow by the meter.
- The counters are based on metering performed on the specified class-map. Therefore, the 'Dropped Bytes' counter is the number of bytes dropped due to metering. This is different from packets dropped via a 'deny' action in the ACL. If a policer is configured to perform re-marking, bytes can be marked Red but are not dropped, and is shown with a value of 0 for the Dropped field and a non-0 value for the 'Red Bytes' field.

**Example** To show the counters for all class-maps attached to port1.0.1, use the command:

```
awplus# show mls qos interface port1.0.1 policer-counters
```

**Output** Figure 29-5: Example output from **show mls qos interface policer-counters** on a port

```
awplus#show mls qos interface port1.0.1 policer-counters
Interface:                port1.0.1
  Class-map:              default
    Green/Yellow Bytes:   0
    Red Bytes:            0
    Dropped Bytes:       0
    Non-dropped Bytes:   0
  Class-map:              cmap1
    Green/Yellow Bytes:  1290
    Red Bytes:           0
    Dropped Bytes:       0
    Non-dropped Bytes:  1290
```

# show mls qos interface queue-counters

**Overview** This command displays an interface's egress queue counters. This can either be for a specific queue or for all queues on the interface. If no queue is specified all queue counters on the interface will be displayed.

The counters show the number of frames currently in the queue and the maximum number of frames allowed in the queue, for individual egress queues and the port's queue (which will be a sum of all egress queues).

**Syntax** `show mls qos interface <port> queue-counters [queue <number>]`

Parameter	Description
<port>	Switch port.
queue <number>	Queue number, from 0 to 7.

**Mode** User Exec and Privileged Exec

**Example** To show the counters for all queues on port1.0.1, use the command:

```
awplus# show mls qos interface port1.0.1 queue-counters
```

**Output** Figure 29-6: Example output from **show mls qos interface queue-counters**

```
Interface port1.0.1 Queue Counters:
Port queue length      1169
Egress Queue length:
Queue 0                 0
Queue 1                 0
Queue 2                 1169
Queue 3                 0
Queue 4                 0
Queue 5                 0
Queue 6                 0
Queue 7                 0
```

Table 29-3: Parameters in the output from **show mls qos interface queue-counters**

Parameter	Description
Interface	Port we are showing the counters for.
Port queue length	Number of frames in the port's queue. This will be the sum of all egress queues on the port.
Egress Queue length	Number of frames in a specific egress queue.

# show mls qos interface storm-status

**Overview** Show the current configuration and status of the QoS Storm Protection (QSP) on the given port.

**Syntax** `show mls qos interface <port> storm-status`

Parameter	Description
<port>	Switch port.

**Mode** User Exec and Privileged Exec

**Example** To see the QSP status on port1.0.1, use the command:

```
awplus# show mls qos interface port1.0.1 storm-status
```

**Output** Figure 29-7: Example output from **show mls qos interface storm-status**

Interface:	port1.0.1
Storm-Protection:	Enabled
Port-status:	Enabled
Storm Action:	vlandisable
Storm Window:	5000 ms
Storm Downtime:	0 s
Timeout Remaining:	0 s
Last read data-rate:	0 kbps
Storm Rate:	1000 kbps

**Related commands**

- [storm-action](#)
- [storm-downtime](#)
- [storm-protection](#)
- [storm-rate](#)
- [storm-window](#)

# show mls qos maps cos-queue

**Overview** Show the current configuration of the cos-queue map.

**Syntax** show mls qos maps cos-queue

**Mode** User Exec and Privileged Exec

**Example** To display the current configuration of the cos-queue map, use the command:

```
awplus# show mls qos maps cos-queue
```

**Output** Figure 29-8: Example output from **show mls qos maps cos-queue**

```
COS-TO-QUEUE-MAP :
COS :           0 1 2 3 4 5 6 7
-----
QUEUE:         2 0 1 3 4 5 6 7
```

**Related commands** [mls qos map cos-queue](#)

# show mls qos maps premark-dscp

**Overview** This command displays the premark-dscp map. This map is used to replace the DSCP, CoS and/or bandwidth class of a packet matching the class-map, based on a lookup DSCP value.

**Syntax** `show mls qos maps premark-dscp [<0-63>]`

Parameter	Description
<0-63>	DSCP table entry.

**Mode** User Exec and Privileged Exec

**Example** To display the premark-dscp map for DSCP 1, use the command:

```
awplus# show mls qos maps premark-dscp 1
```

**Output** Figure 29-9: Example output from the **show mls qos maps premark-dscp** command

```
PREMARK-DSCP-MAP:

DSCP 1
Bandwidth Class
-----
New DSCP           2
New CoS            0
New Bandwidth Class green
```

**Related commands** [mls qos map premark-dscp](#)  
[trust dscp](#)

# show platform classifier statistics utilization brief

**Overview** This command displays the number of used entries available for various platform functions, and the percentage that number of entries represents of the total available.

**Syntax** `show platform classifier statistics utilization brief`

**Mode** Privileged Exec

**Example** To display the platform classifier utilization statistics, use the following command:

```
awplus# show platform classifier statistics utilization brief
```

**Output** Figure 29-10: Output from **show platform classifier statistics utilization brief**

```
awplus#show platform classifier statistics utilization brief

[Instance 0]
Number of Entries:
Policy Type      Group ID      Used / Total
-----
ACL              1476395009   0 / 118 ( 0%)
Web Auth        Inactive      0 / 0 ( 0%)
QoS              0 / 128 ( 0%)
```

**Output parameters** Depending on your switch, you will see some of the following parameters in the output from **show platform classifier statistics utilization brief**

Parameter	Description
IPv6 Multicast	Reserved hardware space for use by IPv6 multicast.
System	Fixed system entries. For example, resiliency links make use of system ACLs.
MLD Snooping	Entries to send various packets that MLD Snooping is interested in to the CPU.
DHCP Snooping	Entries used to send DHCP and ARP packets to the CPU. User-added DHCP Snooping filters under ACLs are counted under the ACL or QoS categories.
Loop Detection	Entries uses to send the special loop detection frame to the CPU.
EPSR	Entries used to send EPSR control traffic to the CPU.
CFM	Entries used by Connectivity Fault Management.
G8032	Entries used to send G.8032 control traffic to the CPU.

Parameter	Description
Global ACLs	Entries for ACLs appear here if the ACLs are applied globally instead of per switchport.
ACL	Entries for ACL filters that have been applied directly to ports using the <a href="#">access-group</a> command.
VACL	Entries for VLAN-based ACLs (ACLs that are applied to VLANs instead of ports).
DOS	Entries used for Denial of Service protection.
UFO	Entries used by Upward Forwarding Only (UFO).
QoS	Entries for ACL filters and other class-map configurations, such as policers, applied through policy maps using the service input command.
RA Guard	Entries used to block IPv6 router advertisements, configured with the <b>ipv6 nd rguard</b> command.
AMFAPPS	Entries used by AMF Application Proxy. These entries enable the SES Controller to block infected ports.
Pre-Ingress	Entries used for VLAN ID Translation (and also for subnet-based and MAC-based VLAN entries on SBx81XLEM cards).
Egress	Entries used for VLAN ID Translation.
UDB	User Defined Bytes (UDB), which are a limited resource of bytes that can be used to implement additional arbitrary matching on packet bytes on some switches. The software manages the use and allocation of these bytes automatically. The output of this table is intended for use by Allied Telesis Customer Support only.

**Related commands** [show platform](#)



# show policy-map

**Overview** Displays the policy-maps configured on the switch. The output also shows whether or not they are connected to a port (attached / detached) and shows their associated class-maps.

**Syntax** `show policy-map [<name>]`

Parameter	Description
<name>	The name of a specific policy-map.

**Mode** User Exec and Privileged Exec

**Example** To display a listing of the policy-maps configured on the switch, use the command:

```
awplus# show policy-map
```

**Output** Figure 29-11: Example output from the **show policy-map** command

```
POLICY-MAP-NAME: example
  Interfaces:
  Default class-map action: permit

  CLASS-MAP-NAME: default
    Policer counters enabled
```

**Related commands** [no police](#)  
[service-policy input](#)

# storm-action

**Overview** Sets the action to be taken when triggered by QoS Storm Protection (QSP). There are three available options:

- **portdisable** will disable the port in software.
- **vlandisable** will disable the port from the VLAN matched by the class-map in class-map. This option requires the match vlan class-map to be present in the class-map
- **linkdown** will physically bring the port down. .

The **no** variant of this command will negate the action set by the **storm-action** command.

**Syntax** `storm-action {portdisable|vlandisable|linkdown}`  
`no storm-action`

Parameter	Description
portdisable	Disable the port in software.
vlandisable	Disable the VLAN.
linkdown	Shutdown the port physically.

**Mode** Policy Map Class Configuration

**Examples** To apply the storm protection of **vlandisable** to the policy-map named "pmap2" and the class-map named "cmap1", use the following commands:

```
awplus# configure terminal
awplus(config)# policy-map pmap2
awplus(config-pmap)# class cmap1
awplus(config-pmap-c# storm-action vlandisable
```

To negate the storm protection set on the policy-map named "pmap2" and the class-map named "cmap1", use the following commands:

```
awplus# configure terminal
awplus(config)# policy-map pmap2
awplus(config-pmap)# class cmap1
awplus(config-pmap-c# no storm-action
```

**Related commands**

- [storm-downtime](#)
- [storm-protection](#)
- [storm-rate](#)
- [storm-window](#)

# storm-downtime

**Overview** Sets the time to re-enable a port that has been disabled by QoS Storm Protection (QSP). The time is given in seconds, from a minimum of one second to maximum of 86400 seconds (i.e. one day).

The **no** variant of this command resets the time to the default value of 10 seconds.

**Syntax** `storm-downtime <1-86400>`  
`no storm-downtime`

Parameter	Description
<1-86400>	Seconds.

**Default** 10 seconds

**Mode** Policy Map Class Configuration

**Examples** To re-enable the port in 1 minute, use the following commands:

```
awplus# configure terminal
awplus(config)# policy-map pmap2
awplus(config-pmap)# class cmap1
awplus(config-pmap-c)# storm-downtime 60
```

To re-set the port to the default (10 seconds), use the following commands:

```
awplus# configure terminal
awplus(config)# policy-map pmap2
awplus(config-pmap)# class cmap1
awplus(config-pmap-c)# no storm-downtime
```

**Related commands**

- [storm-action](#)
- [storm-protection](#)
- [storm-rate](#)
- [storm-window](#)

# storm-protection

**Overview** Use this command to enable policy-based Storm Protection (such as QSP - QoS Storm Protection). Storm protection is activated as soon as a port is enabled. However, it will only be functional after [storm-rate](#) and [storm-window](#) have been set.

The **no** variant of this command disables policy-based Storm Protection.

**Syntax** `storm-protection`  
`no storm-protection`

**Default** By default, storm protection is disabled.

**Mode** Policy Map Class Configuration

**Examples** To enable QSP on cmap2 in pmap2, use the following commands:

```
awplus# configure terminal
awplus(config)# policy-map pmap2
awplus(config-pmap)# class cmap2
awplus(config-pmap-c)# storm-protection
```

To disable QSP on cmap2 in pmap2, use the following commands:

```
awplus# policy-map pmap2
awplus(config-pmap)# class cmap2
awplus(config-pmap-c)# no storm-protection
```

**Related commands** [show mls qos interface storm-status](#)  
[storm-action](#)  
[storm-downtime](#)  
[storm-rate](#)  
[storm-window](#)

# storm-rate

**Overview** Sets the data rate that triggers the storm-action. The rate is in kbps and the range is from 1kbps to 40Gbps.

Note that this setting is made in conjunction with the [storm-window](#) command.

Use the **no** variant of this command to negate the **storm-rate** command.

**Syntax** `storm-rate <1-40000000>`  
`no storm-rate`

Parameter	Description
<code>&lt;1-40000000&gt;</code>	The range of the storm-rate.

**Default** No default

**Mode** Policy Map Class Configuration

**Usage** This setting is made in conjunction with the [storm-window](#) command.

**Examples** To limit the data rate to 100Mbps, use the following commands:

```
awplus# configure terminal
awplus(config)# policy-map pmap2
awplus(config-pmap)# class cmap2
awplus(config-pmap-c)# storm-rate 100000
```

To negate the limit set previously, use the following commands:

```
awplus# configure terminal
awplus(config)# policy-map pmap2
awplus(config-pmap)# class cmap2
awplus(config-pmap-c)# no storm-rate
```

**Related commands**

- [storm-action](#)
- [storm-downtime](#)
- [storm-protection](#)
- [storm-window](#)

# storm-window

**Overview** Sets the window size of QoS Storm Protection (QSP). This sets the time to poll the data-rate every given milliseconds. Minimum window size is 100 ms and the maximum size is 60 sec.

Use the **no** variant of this command to negate the **storm-window** command.

**Syntax** storm-window <100-60000>  
no storm-window

Parameter	Description
<100-60000>	The window size, measured in milliseconds.

**Default** No default

**Mode** Policy Map Class Configuration

**Usage** This command should be set in conjunction with the [storm-rate](#) command.

**Examples** To set the QSP window size to 5000 ms, use the following commands:

```
awplus# configure terminal
awplus(config)# policy-map pmap2
awplus(config-pmap)# class cmap2
awplus(config-pmap-c)# storm-window 5000
```

To negate the QSP window size set previously, use the following commands:

```
awplus# configure terminal
awplus(config)# policy-map pmap2
awplus(config-pmap)# class cmap2
awplus(config-pmap-c)# no storm-window
```

**Related commands** [storm-action](#)  
[storm-downtime](#)  
[storm-protection](#)  
[storm-rate](#)

# trust dscp

**Overview** This command enables the premark-dscp map to replace the DSCP, bandwidth-class and/or CoS of classified traffic based on a lookup DSCP value.

With the **no** variant of this command, no premark-dscp mapping function will be applied for the selected class-map. QoS components of the packet existing either at ingress, or applied by the class-map, will pass unchanged.

**Syntax** trust dscp  
no trust

**Mode** Policy-Map Configuration

**Examples** To enable the premark-dscp map lookup for policy-map pmap1, use the commands:

```
awplus# configure terminal
awplus(config)# policy-map pmap1
awplus(config-pmap)# trust dscp
```

To disable the premark-dscp map lookup for policy-map pmap1, use the commands:

```
awplus# configure terminal
awplus(config)# policy-map pmap1
awplus(config-pmap)# no trust
```

**Related commands** [mls qos map premark-dscp](#)

# wrr-queue disable queues

**Overview** Use this command to disable an egress queue from transmitting traffic. The **no** variant of this command enables an egress queue to transmit traffic.

**Syntax** `wrr-queue disable queues [0][1][2][3][4][5][6][7]`  
`no wrr-queue disable queues [0][1][2][3][4][5][6][7]`

Parameter	Description
[0][2]...[7]	Selects one or more queues numbered 0 to 7.

**Mode** Interface Configuration

**Examples** To disable queue 1 on port1.0.1 from transmitting traffic, use the commands:

```
awplus# configure terminal
awplus(config)# interface port1.0.1
awplus(config-if)# wrr-queue disable queues 1
```

To enable queue 1 on port1.0.1 to transmit traffic, use the commands:

```
awplus# configure terminal
awplus(config)# interface port1.0.1
awplus(config-if)# no wrr-queue disable queues 1
```

**Related commands** [show mls qos interface](#)



# wrr-queue egress-rate-limit queues

**Overview** Sets a limit on the amount of traffic that can be transmitted per second from these queues. The default unit is in Kb, but Mb or Gb can also be specified. The minimum is 651 Kb.

**Syntax** `wrr-queue egress-rate-limit <bandwidth> queues  
[0][1][2][3][4][5][6][7]`  
`no wrr-queue egress-rate-limit <bandwidth> queues  
[0][1][2][3][4][5][6][7]`

Parameter	Description
<bandwidth>	Bandwidth <1-100000000 kbits> (usable units: k, m, g).
[0][2]...[7]	Selects one or more queues numbered 0 to 7.

**Mode** Interface Configuration

**Example** To limit the egress rate of queues 0, 1 and 2 on port1.0.1, use the commands:

```
awplus# configure terminal
awplus(config)# interface port1.0.1
awplus(config-if)# wrr-queue egress-rate-limit 500M queues 0 1
2
```

**Related commands** [show mls qos interface](#)

# wrr-queue weight queues

**Overview** This command configures weighted round-robin based scheduling on the specified egress queues on switch port interfaces only. The weights are specified as ratios relative to each other.

Use the **no wrr-queue** command to remove weighted round-robin based scheduling from the specified egress queue. The queue then reverts to its normal priority-based scheduling.

**Syntax** `wrr-queue weight <1-15> queues [0][1][2][3][4][5][6][7]`  
`no wrr-queue <queue-number>`

Parameter	Description
<1-15>	Weight (the higher the number the greater will be the queue servicing).
[0][2]...[7]	Selects one or more queues numbered 0 to 7.
<queue-number>	Egress queue to revert to priority-based scheduling.

**Mode** Interface Configuration for switch port interfaces only (not for static aggregated interfaces).

**Usage notes** You cannot apply weighted round-robin based scheduling to static aggregated interfaces (for example, sa2).

**Example** To apply a WRR weight of 6 to queues 0 and 1 on port1.0.1, use the commands:

```
awplus# configure terminal
awplus(config)# interface port1.0.1
awplus(config-if)# wrr-queue weight 6 queues 0 1
```

To remove weighted round-robin scheduling from egress queue 2 on port1.0.1, use the commands:

```
awplus# configure terminal
awplus(config)# interface port1.0.1
awplus(config-if)# no wrr-queue 2
```

**Related commands** [priority-queue](#)  
[show mls qos interface](#)

# 30

# 802.1X Commands

## Introduction

**Overview** 802.1X is an IEEE standard providing a mechanism for authenticating devices attached to a LAN port or wireless device. Devices wishing to access services behind a port must authenticate themselves before any Ethernet packets are allowed to pass through. The protocol is referred to as 802.1X because it was initially defined in the IEEE standard 802.1X, published in 2001 and revised in 2004 and again as the current 802.1X 2010 standard.

This chapter provides an alphabetical reference of commands used to configure 802.1X port access control. For more information, see the [AAA and Port Authentication\\_Feature Overview and Configuration Guide](#).

- Command List**
- ["dot1x accounting"](#) on page 1045
  - ["dot1x authentication"](#) on page 1046
  - ["debug dot1x"](#) on page 1047
  - ["dot1x control-direction"](#) on page 1048
  - ["dot1x eap"](#) on page 1050
  - ["dot1x eapol-version"](#) on page 1051
  - ["dot1x initialize interface"](#) on page 1052
  - ["dot1x initialize supplicant"](#) on page 1053
  - ["dot1x keytransmit"](#) on page 1054
  - ["dot1x max-auth-fail"](#) on page 1055
  - ["dot1x max-reauth-req"](#) on page 1057
  - ["dot1x port-control"](#) on page 1059
  - ["dot1x timeout tx-period"](#) on page 1061
  - ["show debugging dot1x"](#) on page 1063
  - ["show dot1x"](#) on page 1064

- [“show dot1x diagnostics”](#) on page 1067
- [“show dot1x interface”](#) on page 1069
- [“show dot1x sessionstatistics”](#) on page 1071
- [“show dot1x statistics interface”](#) on page 1072
- [“show dot1x supplicant”](#) on page 1073
- [“show dot1x supplicant interface”](#) on page 1075
- [“undebbug dot1x”](#) on page 1077

# dot1x accounting

**Overview** This command overrides the **default** RADIUS accounting method for IEEE 802.1X-based authentication on an interface by allowing you to apply a user-defined named method list.

Use the **no** variant of this command to remove the named list from the interface and apply the **default** method list.

**Syntax** dot1x accounting {default|<list-name>}  
no dot1x accounting

Parameter	Description
default	Apply the default accounting method list
<list-name>	Apply the user-defined named list

**Default** The **default** method list is applied to an interface by default.

**Mode** Interface Configuration for a static channel, a dynamic (LACP) channel group, or a switch port; or Authentication Profile mode.

**Example** To apply the named list 'vlan10\_acct' on the vlan10 interface, use the commands:

```
awplus# configure terminal
awplus(config)# interface vlan10
awplus(config-if)# dot1x accounting vlan10_acct
```

To remove the named list from the vlan10 interface and set the authentication method back to **default**, use the commands:

```
awplus# configure terminal
awplus(config)# interface vlan10
awplus(config-if)# no dot1x accounting
```

**Related commands** [aaa accounting dot1x](#)

**Command changes** Version 5.4.9-2.1: command added to AR2050V, AR3050S, and AR4050S

# dot1x authentication

**Overview** This command overrides the **default** 802.1X-based authentication method on an interface by allowing you to apply a user-defined named list.

Use the **no** variant of this command to remove the named list from the interface and apply the **default** method.

**Syntax** dot1x authentication {default|<list-name>}  
no dot1x authentication

Parameter	Description
<i>default</i>	Apply the default authentication method list
<list-name>	Apply the user-defined named list

**Default** The **default** method list is applied to an interface by default.

**Mode** Interface Configuration for a static channel, a dynamic (LACP) channel group, or a switch port; or Authentication Profile mode.

**Example** To apply the named list 'vlan10\_auth' on the vlan10 interface, use the commands:

```
awplus# configure terminal
awplus(config)# interface vlan10
awplus(config-if)# dot1x authentication vlan10_auth
```

To remove the named list from the vlan10 interface and set the authentication method back to **default**, use the commands:

```
awplus# configure terminal
awplus(config)# interface vlan10
awplus(config-if)# no dot1x authentication
```

**Related commands** [aaa authentication dot1x](#)

**Command changes** Version 5.4.9-2.1: command added to AR2050V, AR3050S, and AR4050S

# debug dot1x

**Overview** Use this command to enable 802.1X IEEE Port-Based Network Access Control troubleshooting functions.

Use the **no** variant of this command to disable this function.

**Syntax** debug dot1x [all|auth-web|event|nsm|packet|timer]  
no debug all dot1x  
no debug dot1x [all|auth-web|event|nsm|packet|timer]

Parameter	Description
all	Used with the <b>no</b> variant of this command exclusively; turns off all debugging for 802.1X.
auth-web	Specifies debugging for 802.1X auth-web information.
events	Specifies debugging for 802.1X events.
nsm	Specifies debugging for NSM messages.
packet	Specifies debugging for 802.1X packets.
timer	Specifies debugging for 802.1X timers.

**Mode** Privileged Exec and Global Configuration

**Usage notes** This command turns on a mode where trace-level information is output during authentication conversations. Be aware that this is a very verbose output. It is mostly useful to capture this as part of escalating an issue to ATI support.

**Examples** Use this command without any parameters to turn on normal 802.1X debug information.

```
awplus# debug dot1x  
awplus# show debugging dot1x
```

```
802.1X debugging status:  
802.1X events debugging is  
802.1X timer debugging is on  
802.1X packets debugging is on  
802.1X NSM debugging is on
```

**Related commands** [show debugging dot1x](#)  
[undebug dot1x](#)

**Command changes** Version 5.4.9-2.1: command added to AR2050V, AR3050S, and AR4050S

# dot1x control-direction

- Overview** This command sets the direction of the filter for the unauthorized interface.
- If the optional **in** parameter is specified with this command then packets entering the specified port are discarded. The **in** parameter discards the ingress packets received from the supplicant.
- If the optional **both** parameter is specified with this command then packets entering (ingress) and leaving (egress) the specified port are discarded. The **both** parameter discards the packets received from the supplicant and sent to the supplicant.
- The **no** variant of this command sets the direction of the filter to **both**. The port will then discard both ingress and egress traffic.

**Syntax** dot1x control-direction {in|both}  
no dot1x control-direction

Parameter	Description
in	Discard received packets from the supplicant (ingress packets).
both	Discard received packets from the supplicant (ingress packets) and transmitted packets to the supplicant (egress packets).

- Default** The authentication port direction is set to **both** by default.
- Mode** Interface Configuration for a static channel, a dynamic (LACP) channel group, or a switch port; or Authentication Profile mode.

**Examples** To set the port direction to the default (**both**) for port1.0.2, use the commands:

```
awplus# configure terminal
awplus(config)# interface port1.0.2
awplus(config-if)# no dot1x control-direction
```

To set the port direction to **in** for port1.0.2, use the commands:

```
awplus# configure terminal
awplus(config)# interface port1.0.2
awplus(config-if)# dot1x control-direction in
```

To set the port direction to **in** for authentication profile 'student', use the commands:

```
awplus# configure terminal
awplus(config)# auth profile student
awplus(config-auth-profile)# dot1x control-direction in
```



**Related commands** auth profile (global)  
show dot1x  
show dot1x interface  
show auth interface

**Command changes** Version 5.4.9-2.1: command added to AR2050V, AR3050S, and AR4050S

# dot1x eap

**Overview** This command selects the transmit mode for the EAP packet. If the authentication feature is not enabled then EAP transmit mode is not enabled. The default setting discards EAP packets.

**Syntax** `dot1x eap {discard|forward|forward-untagged-vlan|forward-vlan}`

Parameter	Description
discard	Discard.
forward	Forward to all ports on the switch.
forward-untagged-vlan	Forward to ports with the same untagged VLAN.
forward-vlan	Forward to ports with the same VLAN.

**Default** The transmit mode is set to `discard` EAP packets by default.

**Mode** Global Configuration

**Examples** To set the transmit mode of EAP packet to **forward**, to forward EAP packets to all ports on the switch, use the commands:

```
awplus# configure terminal
awplus(config)# dot1x eap forward
```

To set the transmit mode of EAP packet to **discard**, to discard EAP packets, use the commands:

```
awplus# configure terminal
awplus(config)# dot1x eap discard
```

To set the transmit mode of EAP packet to **forward-untagged-vlan**, to forward EAP packets to ports with the same untagged VLAN, use the commands:

```
awplus# configure terminal
awplus(config)# dot1x eap forward-untagged-vlan
```

To set the transmit mode of EAP packet to **forward-vlan**, to forward EAP packets to ports with the same VLAN, use the commands:

```
awplus# configure terminal
awplus(config)# dot1x eap forward-vlan
```

**Command changes** Version 5.4.9-2.1: command added to AR2050V, AR3050S, and AR4050S

# dot1x eapol-version

**Overview** This command sets the EAPOL protocol version for EAP packets when 802.1X port authentication is applied.

Use the **no** variant of this command to set the EAPOL protocol version to 1.

The default EAPOL protocol version is version 1.

**Syntax** dot1x eapol-version {1|2}  
no dot1x eapol-version

Parameter	Description
1   2	EAPOL protocol version 1 or 2.

**Default** The EAP version for 802.1X authentication is set to 1 by default.

**Mode** Interface Configuration for a static channel, a dynamic (LACP) channel group, or a switch port; or Authentication Profile mode.

**Examples** To set the EAPOL protocol version to 2 for port1.0.2, use the commands:

```
awplus# configure terminal
awplus(config)# interface port1.0.2
awplus(config-if)# dot1x eapol-version 2
```

To set the EAPOL protocol version to the default version (1) for interface port1.0.2, use the commands:

```
awplus# configure terminal
awplus(config)# interface port1.0.2
awplus(config-if)# no dot1x eapol-version
```

To set the EAPOL protocol version to 2 for authentication profile 'student', use the commands:

```
awplus# configure terminal
awplus(config)# auth profile student
awplus(config-auth-profile)# dot1x eapol-version 2
```

**Validation Commands** auth profile (global)  
show dot1x  
show dot1x interface

**Command changes** Version 5.4.9-2.1: command added to AR2050V, AR3050S, and AR4050S

# dot1x initialize interface

**Overview** This command removes authorization for a specified connected interface. The connection will attempt to re-authorize when the specified port attempts to make use of the network connection.

**NOTE:** Reauthentication could be a long time after the use of this command because the reauthorization attempt is not triggered by this command. The attempt is triggered by the first packet from the interface trying to access the network resources.

**Syntax** dot1x initialize interface <interface-list>

Parameter	Description
<interface-list>	The interfaces or ports to configure. An interface-list can be: <ul style="list-style-type: none"><li>• a VLAN (e.g. vlan2)</li><li>• a switchport (e.g. port1.0.4)</li><li>• a static channel group (e.g. sa2)</li><li>• a dynamic (LACP) channel group (e.g. po2)</li><li>• a continuous range of interfaces separated by a hyphen (e.g. port1.0.1-port1.0.3)</li><li>• a comma-separated list (e.g. port1.0.1, port1.0.3-port1.0.4). Do not mix interface types in a list.</li></ul> The specified interfaces must exist.

**Mode** Privileged Exec

**Examples** To initialize 802.1X port authentication on the interface port1.0.2, use the command:

```
awplus# dot1x initialize interface port1.0.2
```

To unauthorize switch port1.0.2 and attempt reauthentication on switch port1.0.2, use the command:

```
awplus# dot1x initialize interface port1.0.2
```

To unauthorize all switch ports for a 18-port device and attempt reauthentication, use the command:

```
awplus# dot1x initialize interface port1.0.1-port1.0.18
```

**Related commands** [dot1x initialize supplicant](#)  
[show dot1x](#)  
[show dot1x interface](#)

**Command changes** Version 5.4.9-2.1: command added to AR2050V, AR3050S, and AR4050S

# dot1x initialize supplicant

**Overview** This command removes authorization for a connected supplicant with the specified MAC address or username. The connection will attempt to re-authorize when the specified supplicant attempts to make use of the network connection.

**NOTE:** *Reauthentication could be a long time after the use of this command because the reauthorization attempt is not triggered by this command. The attempt is triggered by the first packet from the supplicant trying to access the network resources.*

**Syntax** dot1x initialize supplicant {<macadd>|username}

Parameter	Description
dot1x	IEEE 802.1X Port-Based Access Control.
initialize	Initialize the port to attempt reauthentication.
supplicant	Specify the supplicant to initialize.
<macadd>	MAC (hardware address of the supplicant.
username	The name of the supplicant entry.

**Mode** Privileged Exec

**Example** To initialize the supplicant authentication, use the commands

```
awplus# configure terminal
awplus(config)# dot1x initialize supplicant 0090.99ab.a020
awplus(config)# dot1x initialize supplicant guest
```

**Related commands** [dot1x initialize interface](#)  
[show dot1x](#)  
[show dot1x supplicant](#)

**Command changes** Version 5.4.9-2.1: command added to AR2050V, AR3050S, and AR4050S

# dot1x keytransmit

**Overview** This command enables key transmission on the interface specified previously in Interface mode.

The **no** variant of this command disables key transmission on the interface specified.

**Syntax** dot1x keytransmit  
no dot1x keytransmit

**Default** Key transmission for port authentication is enabled by default.

**Mode** Interface Configuration for a static channel, a dynamic (LACP) channel group, or a switch port; or Authentication Profile mode.

**Usage notes** Use this command to enable key transmission over an Extensible Authentication Protocol (EAP) packet between the authenticator and supplicant. Use the **no** variant of this command to disable key transmission.

**Examples** To enable the key transmit feature on interface port1.0.2, after it has been disabled by negation, use the commands:

```
awplus# configure terminal
awplus(config)# interface port1.0.2
awplus(config-if)# dot1x keytransmit
```

To disable the key transmit feature from the default startup configuration on interface port1.0.2, use the commands:

```
awplus# configure terminal
awplus(config)# interface port1.0.2
awplus(config-if)# no dot1x keytransmit
```

**Related commands** [show dot1x](#)  
[show dot1x interface](#)

**Command changes** Version 5.4.9-2.1: command added to AR2050V, AR3050S, and AR4050S

# dot1x max-auth-fail

**Overview** Use this command to configure the maximum number of login attempts for a supplicant (client device) using the **auth-fail vlan** feature, when using 802.1X port authentication on an interface.

The **no** variant of this command resets the maximum login attempts for a supplicant (client device) using the auth-fail vlan feature, to the default configuration of 3 login attempts.

**Syntax** dot1x max-auth-fail <0-10>  
no dot1x max-auth-fail

Parameter	Description
<0-10>	Specify the maximum number of login attempts for supplicants on an interface using 802.1X port authentication.

**Default** The default maximum number of login attempts for a supplicant on an interface using 802.1X port authentication is 3 login attempts.

**Mode** Interface Configuration for a static channel, a dynamic (LACP) channel group, or a switch port; or Authentication Profile mode.

**Usage notes** This command sets the maximum number of login attempts for supplicants on an interface. The supplicant is moved to the auth-fail VLAN from the Guest VLAN after the number of failed login attempts using 802.1X authentication is equal to the number set with this command.

See the [AAA and Port Authentication Feature Overview and Configuration Guide](#) for information about:

- the auth-fail VLAN feature, and
- restrictions regarding combinations of authentication enhancements working together

**Examples** To configure the maximum number of login attempts for a supplicant on interface port1.0.2 to a single login attempt, use the commands:

```
awplus# configure terminal
awplus(config)# interface port1.0.2
awplus(config-if)# dot1x max-auth-fail 1
```

To configure the maximum number of login attempts for a supplicant on interface port1.0.2 to the default number of 3 login attempts, use the commands:

```
awplus# configure terminal
awplus(config)# interface port1.0.2
awplus(config-if)# no dot1x max-auth-fail
```

To configure the maximum number of login attempts for a supplicant on authentication profile 'student' to a single login attempt, use the commands:

```
awplus# configure terminal
awplus(config)# auth profile student
awplus(config-auth-profile)# dot1x max-auth-fail 1
```

**Related  
commands**

[auth auth-fail vlan](#)  
[auth profile \(global\)](#)  
[dot1x max-reauth-req](#)  
[show dot1x interface](#)

**Command  
changes**

Version 5.4.9-2.1: command added to AR2050V, AR3050S, and AR4050S



# dot1x max-reauth-req

**Overview** Use this command to set the number of reauthentication attempts before an interface is unauthorized.

The **no** variant of this command resets the reauthentication delay to the default.

**Syntax** dot1x max-reauth-req <1-10>  
no dot1x max-reauth-req

Parameter	Description
<1-10>	Specify the maximum number of reauthentication attempts for supplicants on an interface using 802.1X port authentication.

**Default** The default maximum reauthentication attempts for interfaces using 802.1X port authentication is two (2) reauthentication attempts, before an interface is unauthorized.

**Mode** Interface Configuration for a static channel, a dynamic (LACP) channel group, or a switch port; or Authentication Profile mode.

**Usage notes** Use this command to set the maximum reauthentication attempts after failure.

**Examples** To configure the maximum number of reauthentication attempts for interface port1.0.2 to a single (1) reauthentication request, use the commands:

```
awplus# configure terminal
awplus(config)# interface port1.0.2
awplus(config-if)# dot1x max-reauth-req 1
```

To configure the maximum number of reauthentication attempts for interface port1.0.2 to the default maximum number of two (2) reauthentication attempts, use the commands:

```
awplus# configure terminal
awplus(config)# interface port1.0.2
awplus(config-if)# no dot1x max-reauth-req
```

To configure the maximum number of reauthentication attempts for authentication profile 'student' to a single (1) reauthentication request, use the commands:

```
awplus# configure terminal
awplus(config)# auth profile student
awplus(config-auth-profile)# dot1x max-reauth-req 1
```

**Related commands** auth profile (global)  
dot1x max-auth-fail  
show dot1x interface

**Command changes** Version 5.4.9-2.1: command added to AR2050V, AR3050S, and AR4050S

# dot1x port-control

**Overview** This command enables 802.1X port authentication on the interface specified, and sets the control of the authentication port.

The **no** variant of this command disables the port authentication on the interface specified.

**Syntax** `dot1x port-control {force-unauthorized|force-authorized|auto}`  
`no dot1x port-control`

Parameter	Description
<code>force-unauthorized</code>	Force the port state to unauthorized. Specify this to force a port to always be in an unauthorized state.
<code>force-authorized</code>	Force the port state to authorized. Specify this to force a port to always be in an authorized state.
<code>auto</code>	Allow the port client to negotiate authentication. Specify this to enable authentication on the port.

**Default** 802.1X port control is disabled by default.

**Mode** Interface Configuration for a static channel, a dynamic (LACP) channel group, or a switch port; or Authentication Profile mode.

**Usage notes** Use this command to force a port state.

When **port-control** is set to **auto**, the 802.1X authentication feature is executed on the interface, but only if the **aaa authentication dot1x** command has been issued.

**Examples** To enable port authentication on the interface port1.0.2, use the commands:

```
awplus# configure terminal
awplus(config)# interface port1.0.2
awplus(config-if)# dot1x port-control auto
```

To enable port authentication force authorized on the interface port1.0.2, use the commands:

```
awplus# configure terminal
awplus(config)# interface port1.0.2
awplus(config-if)# dot1x port-control force-authorized
```

To disable port authentication on the interface port1.0.2 use the commands:

```
awplus# configure terminal
awplus(config)# interface port1.0.2
awplus(config-if)# no dot1x port-control
```

To enable port authentication on authentication profile 'student', use the commands:

```
awplus# configure terminal
awplus(config)# auth profile student
awplus(config-auth-profile)# dot1x port-control auto
```

**Related  
commands**

[aaa authentication dot1x](#)

[auth profile \(global\)](#)

[show dot1x interface](#)

**Command  
changes**

Version 5.4.9-2.1: command added to AR2050V, AR3050S, and AR4050S

# dot1x timeout tx-period

**Overview** This command sets the transmit timeout for the authentication request on the specified interface.

The **no** variant of this command resets the transmit timeout period to the default (30 seconds).

**Syntax** dot1x timeout tx-period <1-65535>  
no dot1x timeout tx-period

Parameter	Description
<1-65535>	Seconds.

**Default** The default transmit period for port authentication is 30 seconds.

**Mode** Interface Configuration for a static channel, a dynamic (LACP) channel group, or a switch port; or Authentication Profile mode.

**Usage notes** Use this command to set the interval between successive attempts to request an ID.

**Examples** To set the transmit timeout period to 5 seconds on interface port1.0.2, use the commands:

```
awplus# configure terminal
awplus(config)# interface port1.0.2
awplus(config-if)# dot1x timeout tx-period 5
```

To reset transmit timeout period to the default (30 seconds) on interface port1.0.2, use the commands:

```
awplus# configure terminal
awplus(config)# interface port1.0.2
awplus(config-if)# no dot1x timeout tx-period
```

To set the transmit timeout period to 5 seconds on authentication profile 'student', use the commands:

```
awplus# configure terminal
awplus(config)# auth profile student
awplus(config-auth-profile)# dot1x timeout tx-period 5
```

**Related commands** [auth profile \(global\)](#)  
[show dot1x](#)  
[show dot1x interface](#)

**Command changes** Version 5.4.9-2.1: command added to AR2050V, AR3050S, and AR4050S

# show debugging dot1x

**Overview** Use this command to see what debugging is turned on for 802.1X.  
For information on filtering and saving command output, see the [“Getting Started with AlliedWare Plus” Feature Overview and Configuration Guide](#).

**Syntax** `show debugging dot1x`

**Mode** User Exec and Privileged Exec

**Example** To enable 802.1X debugging and display the debugging option set, use the following commands:

```
awplus# debug dot1x  
awplus# show debugging dot1x
```

```
802.1X debugging status:  
802.1X events debugging is on  
802.1X timer debugging is on  
802.1X packets debugging is on  
802.1X NSM debugging is on
```

**Related commands** [debug dot1x](#)

**Command changes** Version 5.4.9-2.1: command added to AR2050V, AR3050S, and AR4050S

# show dot1x

**Overview** Use this command to show authentication information for 802.1X port authentication.

If you specify the optional **all** parameter then this command also displays all authentication information for each port available on the switch.

For information on filtering and saving command output, see the [“Getting Started with AlliedWare\\_Plus” Feature Overview and Configuration Guide](#).

**Syntax** show dot1x [all]

Parameter	Description
all	Displays all authentication information for each port available on the switch.

**Mode** Privileged Exec

**Example** awplus# show dot1x all

**Table 1:** Example output from the **show dot1x all** command

```
awplus# show dot1x all
802.1X Port-Based Authentication Enabled
RADIUS server address: 150.87.18.89:1812
Next radius message id: 5
RADIUS client address: not configured
Authentication info for interface port1.0.2
portEnabled: true - portControl: Auto
portStatus: Authorized
reAuthenticate: disabled
reAuthPeriod: 3600
PAE: quietPeriod: 60 - maxReauthReq: 2 - txPeriod: 30
PAE: connectTimeout: 30
BE: suppTimeout: 30 - serverTimeout: 30
CD: adminControlledDirections: in
KT: keyTxEnabled: false
critical: disabled
guestVlan: disabled
dynamicVlanCreation: single-dynamic-vlan
multiVlanSession: disabled
assignFailActionRule: deny
hostMode: multi-supplicant
maxsupplicant: 1024
```



**Table 1:** Example output from the **show dot1x all** command (cont.)

```
dot1x: enabled
protocolVersion: 1
authMac: enabled
method: PAP
reauthRelearning: disabled
authWeb: enabled
method: PAP
lockCount: 3
packetForwarding: disabled
twoStepAuthentication:
    configured: enabled
    actual: enabled
SupplicantMac: none
supplicantMac: none
Supplicant name: manager
Supplicant address: 00d0.59ab.7037
    authenticationMethod: 802.1X Authentication
    portStatus: Authorized - currentId: 1
    abort:F fail:F start:F timeout:F success:T
    PAE: state: Authenticated - portMode: Auto
    PAE: reAuthCount: 0 - rxRespId: 0
    PAE: quietPeriod: 60 - maxReauthReq: 2 - txPeriod: 30
    BE: state: Idle - reqCount: 0 - idFromServer: 0
    CD: adminControlledDirections: in - operControlledDirections: in
    CD: bridgeDetected: false
    KR: rxKey: false
    KT: keyAvailable: false - keyTxEnabled: false
    criticalState: off
    dynamicVlanId: 2
802.1X statistics for interface port1.0.2
    EAPOL Frames Rx: 5 - EAPOL Frames Tx: 16
    EAPOL Start Frames Rx: 0 - EAPOL Logoff Frames Rx: 0
    EAP Rsp/Id Frames Rx: 3 - EAP Response Frames Rx: 2
    EAP Req/Id Frames Tx: 8 - EAP Request Frames Tx: 2
    Invalid EAPOL Frames Rx: 0 - EAP Length Error Frames Rx: 0
    EAPOL Last Frame Version Rx: 1 - EAPOL Last Frame Src: 00d0.59ab.7037
Authentication session statistics for interface port1.0.2
    session user name: manager
    session authentication method: Remote server
    session time: 19440 secs
    session terminate cause: Not terminated yet
Authentication Diagnostics for interface port1.0.2
    Supplicant address: 00d0.59ab.7037
    authEnterConnecting: 2
    authEaplogoffWhileConnecting: 1
    authEnterAuthenticating: 2
    authSuccessWhileAuthenticating: 1
    authTimeoutWhileAuthenticating: 1
    authFailWhileAuthenticating: 0
    authEapstartWhileAuthenticating: 0
```

**Table 1:** Example output from the **show dot1x all** command (cont.)

```
authEaplogoggWhileAuthenticating: 0
authReauthsWhileAuthenticated: 0
authEapstartWhileAuthenticated: 0
authEaplogoffWhileAuthenticated: 0
BackendResponses: 2
BackendAccessChallenges: 1
BackendOtherrequestToSupplicant: 3
BackendAuthSuccess: 1
BackendAuthFails: 0
```

**Command changes** Version 5.4.9-2.1: command added to AR2050V, AR3050S, and AR4050S

# show dot1x diagnostics

**Overview** This command shows 802.1X authentication diagnostics for the specified interface (optional).

If no interface is specified then authentication diagnostics are shown for all interfaces.

For information on filtering and saving command output, see the [“Getting Started with AlliedWare Plus” Feature Overview and Configuration Guide](#).

**Syntax** `show dot1x diagnostics [interface <interface-list>]`

Parameter	Description
<code>interface</code>	Specify a port to show.
<code>&lt;interface-list&gt;</code>	The interfaces or ports to configure. An interface-list can be: <ul style="list-style-type: none"><li>• a VLAN (e.g. vlan2)</li><li>• a switchport (e.g. port1.0.4)</li><li>• a static channel group (e.g. sa2)</li><li>• a dynamic (LACP) channel group (e.g. po2)</li><li>• a continuous range of interfaces separated by a hyphen (e.g. port1.0.1-port1.0.3)</li><li>• a comma-separated list (e.g. port1.0.1, port1.0.3-port1.0.4). Do not mix interface types in a list.</li></ul> The specified interfaces must exist.

**Mode** Privileged Exec

**Example** See the sample output below showing 802.1X authentication diagnostics for port1.0.2:

```
awplus# show dot1x diagnostics interface port1.0.2
```

**Output** Figure 30-1: Example output from the **show dot1x diagnostics** command

```
Authentication Diagnostics for interface port1.0.2
  Supplicant address: 00d0.59ab.7037
  authEnterConnecting: 2
  authEaplogoffWhileConnecting: 1
  authEnterAuthenticating: 2
  authSuccessWhileAuthenticating: 1
  authTimeoutWhileAuthenticating: 1
  authFailWhileAuthenticating: 0
  authEapstartWhileAuthenticating: 0
  authEaplogoggWhileAuthenticating: 0
  authReauthsWhileAuthenticated: 0
  authEapstartWhileAuthenticated: 0
  authEaplogoffWhileAuthenticated: 0
  BackendResponses: 2
  BackendAccessChallenges: 1
  BackendOtherrequestToSupplicant: 3
  BackendAuthSuccess: 1
```

**Command changes** Version 5.4.9-2.1: command added to AR2050V, AR3050S, and AR4050S

# show dot1x interface

**Overview** Use this command to show the status of 802.1X port-based authentication on the specified interface.

For information on filtering and saving command output, see the [“Getting Started with AlliedWare\\_Plus” Feature Overview and Configuration Guide](#).

**Syntax** `show dot1x interface <interface-list>`

Parameter	Description
<code>&lt;interface-list&gt;</code>	The interfaces to display information about. An interface-list can be: <ul style="list-style-type: none"><li>• a VLAN (e.g. vlan2)</li><li>• a switchport (e.g. port1.0.4)</li><li>• a static channel group (e.g. sa2)</li><li>• a dynamic (LACP) channel group (e.g. po2)</li><li>• a continuous range of interfaces separated by a hyphen (e.g. port1.0.1-port1.0.3)</li><li>• a comma-separated list (e.g. port1.0.1, port1.0.3-port1.0.4). Do not mix interface types in a list.</li></ul>

**Mode** Privileged Exec

**Examples** See the sample output below showing 802.1X authentication status for port1.0.2:

```
awplus# show dot1x interface port1.0.2
```

**Table 2:** Example output from the **show dot1x interface** command for a port

```
awplus#show dot1x interface port1.0.2
Authentication info for interface port1.0.2
  portEnabled: true - portControl: Auto
  portStatus: Authorized
  reAuthenticate: disabled
  reAuthPeriod: 3600
  PAE: quietPeriod: 60 - maxReauthReq: 2 - txPeriod: 30
  PAE: connectTimeout: 30
  BE: suppTimeout: 30 - serverTimeout: 30
  CD: adminControlledDirections: in
  KT: keyTxEnabled: false
  critical: disabled
  guestVlan: disabled
  dynamicVlanCreation: single-dynamic-vlan
    assignFailActionRule: deny
  multiVlanSession: disabled
  hostMode: multi-supPLICANT
    maxsupPLICANT: 1024
  dot1x: enabled
  protocolVersion: 1
  authMac: enabled
  method: PAP
  reauthRelearning: disabled
  authWeb: enabled
  method: PAP
  lockCount: 3
  packetForwarding: disabled
    twoStepAuthentication:
      configured: enabled
      actual: enabled
  supPLICANTMac: none
```

**Related commands**

- [show auth diagnostics](#)
- [show dot1x sessionstatistics](#)
- [show dot1x statistics interface](#)
- [show dot1x supPLICANT interface](#)

**Command changes**

Version 5.4.9-2.1: command added to AR2050V, AR3050S, and AR4050S

# show dot1x sessionstatistics

**Overview** This command shows authentication session statistics for the specified interface, which may be a static channel (or static aggregator) or a dynamic (or LACP) channel group or a switch port.

For information on filtering and saving command output, see the [“Getting Started with AlliedWare Plus” Feature Overview and Configuration Guide](#).

**Syntax** `show dot1x sessionstatistics [interface <interface-list>]`

Parameter	Description
interface	Specify a port to show.
<interface-list>	The interfaces to display information about. An interface-list can be: <ul style="list-style-type: none"><li>• a VLAN (e.g. vlan2)</li><li>• a switchport (e.g. port1.0.4)</li><li>• a static channel group (e.g. sa2)</li><li>• a dynamic (LACP) channel group (e.g. po2)</li><li>• a continuous range of interfaces separated by a hyphen (e.g. port1.0.1-port1.0.3)</li><li>• a comma-separated list (e.g. port1.0.1, port1.0.3-port1.0.4). Do not mix interface types in a list.</li></ul>

**Mode** Privileged Exec

**Example** See sample output below showing 802.1X authentication session statistics for port1.0.2:

```
awplus# show dot1x sessionstatistics interface port1.0.2
```

```
Authentication session statistics for interface port1.0.2
  session user name: manager
  session authentication method: Remote server
  session time: 19440 secs
  session terminat cause: Not terminated yet
```

**Command changes** Version 5.4.9-2.1: command added to AR2050V, AR3050S, and AR4050S

# show dot1x statistics interface

**Overview** Use this command to show the authentication statistics for the specified interface. For information on filtering and saving command output, see the [“Getting Started with AlliedWare Plus” Feature Overview and Configuration Guide](#).

The output from this command is the same as the output from the [show auth statistics interface](#) command.

**Syntax** `show dot1x statistics interface <interface-list>`

Parameter	Description
<code>&lt;interface-list&gt;</code>	The interfaces to display information about. An interface-list can be: <ul style="list-style-type: none"><li>• a VLAN (e.g. vlan2)</li><li>• a switchport (e.g. port1.0.4)</li><li>• a static channel group (e.g. sa2)</li><li>• a dynamic (LACP) channel group (e.g. po2)</li><li>• a continuous range of interfaces separated by a hyphen (e.g. port1.0.1-port1.0.3)</li><li>• a comma-separated list (e.g. port1.0.1, port1.0.3-port1.0.4). Do not mix interface types in a list.</li></ul>

**Mode** Privileged Exec

**Example** To display 802.1X authentication statistics for port1.0.2, use the command:

```
awplus# show dot1x statistics interface port1.0.2
```

**Output** Figure 30-2: Example output from **show dot1x statistics interface** for a port

```
awplus# show dot1x statistics interface port1.0.2
802.1X statistics for interface port1.0.2
EAPOL Frames Rx: 5 - EAPOL Frames Tx: 16
EAPOL Start Frames Rx: 0 - EAPOL Logoff Frames Rx: 0
EAP Rsp/Id Frames Rx: 3 - EAP Response Frames Rx: 2
EAP Req/Id Frames Tx: 8 - EAP Request Frames Tx: 2
Invalid EAPOL Frames Rx: 0 - EAP Length Error Frames Rx: 0
EAPOL Last Frame Version Rx: 1 - EAPOL Last Frame
Src:00d0.59ab.7037
```

**Command changes** Version 5.4.9-2.1: command added to AR2050V, AR3050S, and AR4050S



# show dot1x supplicant

**Overview** This command shows the supplicant state of the authentication mode set for the switch.

This command shows a summary when the optional **brief** parameter is used.

For information on filtering and saving command output, see the [“Getting Started with AlliedWare\\_Plus” Feature Overview and Configuration Guide](#).

**Syntax** show dot1x supplicant [*<macadd>*] [brief]

Parameter	Description
<i>&lt;macadd&gt;</i>	MAC (hardware) address of the Supplicant.
brief	Brief summary of the Supplicant state.

**Mode** Privileged Exec

**Example** See sample output below showing the 802.1X authenticated supplicant on the switch:

```
awplus# show dot1x supplicant
```

```
authenticationMethod: dot1x
totalSupplicantNum: 1
authorizedSupplicantNum: 1
macBasedAuthenticationSupplicantNum: 0
dot1xAuthenticationSupplicantNum: 1
webBasedAuthenticationSupplicantNum: 0
Supplicant name: manager
Supplicant address: 00d0.59ab.7037
  authenticationMethod: dot1x
    Two-Step Authentication:
      firstAuthentication: Pass - Method: mac
      secondAuthentication: Pass - Method: dot1x
portStatus: Authorized - currentId: 4
abort:F fail:F start:F timeout:F success:T
PAE: state: Authenticated - portMode: Auto
PAE: reAuthCount: 0 - rxRespId: 0
PAE: quietPeriod: 60 - maxReauthReq: 2 - txPeriod: 30
BE: state: Idle - reqCount: 0 - idFromServer: 3
BE: suppTimeout: 30 - serverTimeout: 30
CD: adminControlledDirections: in - operControlledDirections: in
CD: bridgeDetected: false
KR: rxKey: false
KT: keyAvailable: false - keyTxEnabled: false
RADIUS server group (auth): radius
RADIUS server (auth): 192.168.1.40
```

See sample output below showing the supplicant on the switch using the **brief** parameter:

```
awplus# show dot1x supplicant 00d0.59ab.7037 brief
```

```
Interface port1.0.2
 authenticationMethod: dot1x
 totalSupplicantNum: 1
 authorizedSupplicantNum: 1
   macBasedAuthenticationSupplicantNum: 0
   dot1xAuthenticationSupplicantNum: 1
   webBasedAuthenticationSupplicantNum: 0
```

Interface	VID	Mode	MAC Address	Status	IP Address	Username
port1.0.2	2	D	00d0.59ab.7037	Authenticated	192.168.2.201	manager

See sample output below showing the supplicant on the switch using the **brief** parameter:

```
awplus# show dot1x supplicant brief
```

For example, if two-step authentication is configured with 802.1X authentication as the first method and web authentication as the second method then the output is as follows:

```
Interface port1.0.2 authenticationMethod: dot1x/web
 Two-Step Authentication
   firstMethod: dot1x
   secondMethod: web
 totalSupplicantNum: 1
 authorizedSupplicantNum: 1
   macBasedAuthenticationSupplicantNum: 0
   dot1xAuthenticationSupplicantNum: 0
   webBasedAuthenticationSupplicantNum: 1
   otherAuthenticationSupplicantNum: 0
```

Interface	VID	Mode	MAC Address	Status	IP Address	Username
port1.0.2	5	W	0008.0d5e.c216	Authenticated	192.168.1.200	web

**Related commands** [show dot1x supplicant interface](#)

**Command changes** Version 5.4.9-2.1: command added to AR2050V, AR3050S, and AR4050S

# show dot1x supplicant interface

**Overview** Use this command to show the supplicant state of the authentication mode set for the interface.

This command shows a summary when the optional **brief** parameter is used.

For information on filtering and saving command output, see the [“Getting Started with AlliedWare\\_Plus” Feature Overview and Configuration Guide](#).

**Syntax** `show dot1x supplicant interface <interface-list> [brief]`

Parameter	Description
<code>&lt;interface-list&gt;</code>	The interfaces to display information about. An interface-list can be: <ul style="list-style-type: none"><li>• a VLAN (e.g. vlan2)</li><li>• a switchport (e.g. port1.0.4)</li><li>• a static channel group (e.g. sa2)</li><li>• a dynamic (LACP) channel group (e.g. po2)</li><li>• a continuous range of interfaces separated by a hyphen (e.g. port1.0.1-port1.0.3)</li><li>• a comma-separated list (e.g. port1.0.1, port1.0.3-port1.0.4). Do not mix interface types in a list.</li></ul>
<code>brief</code>	Brief summary of the Supplicant state.

**Mode** Privileged Exec

**Examples** See sample output below showing the supplicant on the interface port1.0.2:

```
awplus# show dot1x supplicant interface port1.0.2
```

```
Interface port1.0.2
 authenticationMethod: dot1x
  totalSupplicantNum: 1
 authorizedSupplicantNum: 1
   macBasedAuthenticationSupplicantNum: 0
   dot1xAuthenticationSupplicantNum: 1
   webBasedAuthenticationSupplicantNum: 0
   otherAuthenticationSupplicantNum: 0

Supplicant name: VCSPCVLAN10
Supplicant address: 0000.cd07.7b60
 authenticationMethod: 802.1X
Two-Step Authentication:
 firstAuthentication: Pass - Method: mac
 secondAuthentication: Pass - Method: dot1x
 portStatus: Authorized - currentId: 3
 abort:F fail:F start:F timeout:F success:T
 PAE: state: Authenticated - portMode: Auto
 PAE: reAuthCount: 0 - rxRespId: 0
 PAE: quietPeriod: 60 - maxReauthReq: 2
 BE: state: Idle - reqCount: 0 - idFromServer: 2
 CD: adminControlledDirections:in -
 operControlledDirections:in
 CD: bridgeDetected: false
 KR: rxKey: false
 KT: keyAvailable: false - keyTxEnabled: false
```

See sample output below showing the supplicant on the switch using the **brief** parameter:

```
awplus# show dot1x supplicant interface port1.0.2 brief
```

```
Interface port1.0.2
 authenticationMethod: dot1x
Two-Step Authentication:
 firstMethod: mac
 secondMethod: dot1x
totalSupplicantNum: 1
authorizedSupplicantNum: 1
macBasedAuthenticationSupplicantNum: 0
dot1xAuthenticationSupplicantNum: 1
webBasedAuthenticationSupplicantNum: 0

Interface  VID  Mode  MAC Address      Status           IP Address      Username
=====  ===  ====  =====
port1.0.2  2    D     00d0.59ab.7037  Authenticated   192.168.2.201  manager
```

**Related commands** [show dot1x supplicant](#)

**Command changes** Version 5.4.9-2.1: command added to AR2050V, AR3050S, and AR4050S

# undebbug dot1x

**Overview** This command applies the functionality of the **no** variant of the [debug dot1x](#) command.

# 31

# Authentication Commands

## Introduction

**Overview** Port authentication commands enable you to specify three different types of device authentication: 802.1X authentication, web authentication, and MAC authentication.

- 802.1X is an IEEE standard providing a mechanism for authenticating devices attached to a LAN port or wireless device.
- Web authentication is applicable to devices that have a human user who opens the web browser and types in a user name and password when requested.
- MAC authentication is used to authenticate devices that have neither a human user nor implement 802.1X supplicant when making a network connection request.

This chapter provides an alphabetical reference for MAC and web authentication commands. For a list of 802.1X commands see the [802.1X Commands](#) chapter.

For more information on configuring and using port authentication, see the [AAA and Port Authentication Feature Overview and Configuration Guide](#).

- Command List**
- [“auth auth-fail vlan”](#) on page 1081
  - [“auth critical”](#) on page 1083
  - [“auth dynamic-vlan-creation”](#) on page 1084
  - [“auth guest-vlan”](#) on page 1087
  - [“auth guest-vlan forward”](#) on page 1089
  - [“auth host-mode”](#) on page 1091
  - [“auth log”](#) on page 1093
  - [“auth max-supplicant”](#) on page 1095
  - [“auth multi-vlan-session”](#) on page 1097
  - [“auth profile \(global\)”](#) on page 1098

- [“auth profile \(interface\)”](#) on page 1099
- [“auth reauthentication”](#) on page 1100
- [“auth roaming disconnected”](#) on page 1101
- [“auth roaming enable”](#) on page 1103
- [“auth supplicant-ip”](#) on page 1105
- [“auth supplicant-mac”](#) on page 1107
- [“auth timeout connect-timeout”](#) on page 1110
- [“auth timeout quiet-period”](#) on page 1111
- [“auth timeout reauth-period”](#) on page 1112
- [“auth timeout server-timeout”](#) on page 1114
- [“auth timeout supp-timeout”](#) on page 1116
- [“auth two-step enable”](#) on page 1117
- [“auth-mac accounting”](#) on page 1120
- [“auth-mac authentication”](#) on page 1121
- [“auth-mac enable”](#) on page 1122
- [“auth-mac method”](#) on page 1124
- [“auth-mac password”](#) on page 1126
- [“auth-mac reauth-relearning”](#) on page 1127
- [“auth-mac static”](#) on page 1128
- [“auth-mac username”](#) on page 1129
- [“auth-web accounting”](#) on page 1130
- [“auth-web authentication”](#) on page 1131
- [“auth-web enable”](#) on page 1132
- [“auth-web forward”](#) on page 1134
- [“auth-web max-auth-fail”](#) on page 1137
- [“auth-web method”](#) on page 1139
- [“auth-web-server blocking-mode”](#) on page 1140
- [“auth-web-server dhcp ipaddress”](#) on page 1141
- [“auth-web-server dhcp lease”](#) on page 1142
- [“auth-web-server dhcp-wpad-option”](#) on page 1143
- [“auth-web-server host-name”](#) on page 1144
- [“auth-web-server intercept-port”](#) on page 1145
- [“auth-web-server ipaddress”](#) on page 1146
- [“auth-web-server page language”](#) on page 1147
- [“auth-web-server login-url”](#) on page 1148

- [“auth-web-server page logo”](#) on page 1149
- [“auth-web-server page sub-title”](#) on page 1150
- [“auth-web-server page success-message”](#) on page 1151
- [“auth-web-server page title”](#) on page 1152
- [“auth-web-server page welcome-message”](#) on page 1153
- [“auth-web-server ping-poll enable”](#) on page 1154
- [“auth-web-server ping-poll failcount”](#) on page 1155
- [“auth-web-server ping-poll interval”](#) on page 1156
- [“auth-web-server ping-poll reauth-timer-refresh”](#) on page 1157
- [“auth-web-server ping-poll timeout”](#) on page 1158
- [“auth-web-server port”](#) on page 1159
- [“auth-web-server redirect-delay-time”](#) on page 1160
- [“auth-web-server redirect-url”](#) on page 1161
- [“auth-web-server session-keep”](#) on page 1162
- [“auth-web-server ssl”](#) on page 1163
- [“auth-web-server ssl intercept-port”](#) on page 1164
- [“copy proxy-autoconfig-file”](#) on page 1165
- [“copy web-auth-https-file”](#) on page 1166
- [“description \(auth-profile\)”](#) on page 1167
- [“erase proxy-autoconfig-file”](#) on page 1168
- [“erase web-auth-https-file”](#) on page 1169
- [“platform l3-vlan-hashing-algorithm”](#) on page 1170
- [“platform mac-vlan-hashing-algorithm”](#) on page 1171
- [“show auth”](#) on page 1172
- [“show auth diagnostics”](#) on page 1174
- [“show auth interface”](#) on page 1176
- [“show auth sessionstatistics”](#) on page 1178
- [“show auth statistics interface”](#) on page 1179
- [“show auth supplicant”](#) on page 1180
- [“show auth supplicant interface”](#) on page 1183
- [“show auth two-step supplicant brief”](#) on page 1184
- [“show auth-web-server”](#) on page 1186
- [“show auth-web-server page”](#) on page 1187
- [“show proxy-autoconfig-file”](#) on page 1188



# auth auth-fail vlan

**Overview** Use this command to enable the **auth-fail vlan** feature on the specified vlan interface. This feature assigns supplicants (client devices) to the specified VLAN if they fail port authentication.

Use the **no** variant of this command to disable the auth-fail vlan feature for a specified VLAN interface.

**Syntax** `auth auth-fail vlan <1-4094>`  
`no auth auth-fail vlan`

Parameter	Description
<1-4094>	Assigns the VLAN ID to any supplicants that have failed port authentication.

**Default** The auth-fail vlan feature is disabled by default.

**Mode** Interface Configuration for a static channel, a dynamic (LACP) channel group, or a switch port; or Authentication Profile mode.

**Usage notes** Use the auth-fail vlan feature when using web authentication instead of the Guest VLAN feature, when you need to separate networks where one supplicant (client device) requires authentication and another supplicant does not require authentication from the same interface.

This is because the DHCP lease time using the Web-Authentication feature is shorter, and the auth-fail vlan feature enables assignment to a different VLAN if a supplicant fails authentication.

To enable the auth-fail vlan feature with web authentication, you need to set the web authentication server virtual IP address by using the `auth-web-server ipaddress` command or the `auth-web-server dhcp ipaddress` command.

When using 802.1X port authentication, use a `dot1x max-auth-fail` command to set the maximum number of login attempts. Three login attempts are allowed by default for 802.1X port authentication before supplicants trying to authenticate are moved from the Guest VLAN to the auth-fail VLAN. See the `dot1x max-auth-fail` on page 1055 for command information.

See the [AAA and Port Authentication Feature Overview and Configuration Guide](#) for information about:

- the auth-fail VLAN feature, which allows the Network Administrator to separate the supplicants who attempted authentication, but failed, from the supplicants who did not attempt authentication, and
- restrictions regarding combinations of authentication enhancements working together

Use appropriate ACLs (Access Control Lists) on interfaces for extra security if a supplicant allocated to the designated auth-fail vlan can access the same network

as a supplicant on the Guest VLAN. For more information about ACL concepts, and configuring ACLs see the [ACL Feature Overview and Configuration Guide](#). For more information about ACL commands see:

- [IPv4 Hardware Access Control List \(ACL\) Commands](#)
- [IPv4 Software Access Control List \(ACL\) Commands](#)
- [IPv6 Software Access Control List \(ACL\) Commands](#)

**Examples** To enable the auth-fail vlan feature for port1.0.2 and assign VLAN 100, use the following commands:

```
awplus# configure terminal
awplus(config)# interface port1.0.2
awplus(config-if)# auth auth-fail vlan 100
```

To disable the auth-fail vlan feature for port1.0.2, use the following commands:

```
awplus# configure terminal
awplus(config)# interface port1.0.2
awplus(config-if)# no auth auth-fail vlan
```

**Related commands**

- [auth profile \(global\)](#)
- [dot1x max-auth-fail](#)
- [show dot1x](#)
- [show dot1x interface](#)
- [show running-config](#)

**Command changes** Version 5.4.9-2.1: command added to AR2050V, AR3050S, and AR4050S

# auth critical

**Overview** Use this command to enable the critical port feature on the interface. When the critical port feature is enabled on an interface, and all the RADIUS servers are unavailable, then the interface becomes authorized.

The **no** variant of this command disables the critical port feature on the interface.

**Syntax** `auth critical`  
`no auth critical`

**Default** The critical port of port authentication is disabled.

**Mode** Interface Configuration for a static channel, a dynamic (LACP) channel group, or a switch port; or Authentication Profile mode.

**Examples** To enable the critical port feature on interface port1.0.2, use the following commands:

```
awplus# configure terminal
awplus(config)# interface port1.0.2
awplus(config-if)# auth critical
```

To disable the critical port feature on interface port1.0.2, use the following commands:

```
awplus# configure terminal
awplus(config)# interface port1.0.2
awplus(config-if)# no auth critical
```

To enable the critical port feature on authentication profile 'student', use the commands:

```
awplus# configure terminal
awplus(config)# auth profile student
awplus(config-auth-profile)# auth critical
```

**Related commands**

- [auth profile \(global\)](#)
- [show auth-web-server](#)
- [show dot1x](#)
- [show dot1x interface](#)
- [show running-config](#)

# auth dynamic-vlan-creation

**Overview** Use this command to enable and disable the Dynamic VLAN assignment feature.

The Dynamic VLAN assignment feature allows a supplicant (client device) to be placed into a specific VLAN based on information returned from the RADIUS server during authentication, on a given interface.

Use the **no** variant of this command to disable the Dynamic VLAN assignment feature.

**Syntax** `auth dynamic-vlan-creation [rule {deny|permit}] [type {multi|single}]`  
`no auth dynamic-vlan-creation`

Parameter	Description
rule	VLAN assignment rule.
deny	Deny a differently assigned VLAN ID. This is the default rule.
permit	Permit a differently assigned VLAN ID.
type	Specifies whether multiple different VLANs can be assigned to supplicants (client devices) attached to the port, or whether only a single VLAN can be assigned to supplicants on the port.
multi	Multiple Dynamic VLAN.
single	Single Dynamic VLAN.

**Default** By default, the Dynamic VLAN assignment feature is disabled.

**Mode** Interface Configuration for a static channel, a dynamic (LACP) channel group, or a switch port; or Authentication Profile mode.

**Usage notes** If the Dynamic VLAN assignment feature is enabled, VLAN assignment is dynamic. If the Dynamic VLAN assignment feature is disabled then RADIUS attributes are ignored and configured VLANs are assigned to ports. Dynamic VLANs may be associated with authenticated MAC addresses if the **type** parameter is applied with the **rule** parameter.

The **rule** parameter deals with the case where there are multiple supplicants attached to a port, and the type parameter has been set to **single-vlan**. The parameter specifies how the switch should act if different VLAN IDs end up being assigned to different supplicants. The keyword value **deny** means that once a given VID has been assigned to the first supplicant, then if any subsequent supplicant is assigned a different VID, that supplicant is rejected. The keyword value **permit** means that once a given VID has been assigned to the first supplicant, then if any subsequent supplicant is assigned a different VID, that supplicant is accepted, but it is actually assigned the same VID as the first supplicant.

If you issue an **auth dynamic-vlan-creation** command without a **rule** parameter then a second supplicant with a different VLAN ID is rejected. It is not assigned to the first supplicant's VLAN. Issuing an **auth dynamic-vlan-creation** command without a **rule** parameter has the same effect as issuing an **auth dynamic-vlan-creation rule deny** command rejecting supplicants with differing VLANs.

The **type** parameter specifies whether multiple different VLANs can be assigned to supplicants attached to the port, or whether only a single VLAN can be assigned to supplicants on the port. The **type** parameter can select the port base VLAN or the MAC base VLAN from the RADIUS VLAN ID. This can be used when the host-mode is set to multi-supplicant. For **single**-host ports, the VLAN ID will be assigned to the port. It is not supported with the Guest VLAN feature. Display the ID assigned using a **show vlan** command. For **multi**-host ports, the VLAN ID will be assigned to the MAC address of the authenticated supplicant. The VLAN ID assigned for the MAC Base VLAN is displayed using the **show platform table vlan** command.

To configure Dynamic VLAN with Web Authentication, you need to set the Web Authentication Server virtual IP address by using the **auth-web-server ipaddress** command or the **auth-web-server dhcp ipaddress** command. You also need to create a hardware access-list that can be applied to the switch port interface.

You need to configure an IPv4 address for the VLAN interface on which Web Authentication is running.

**Examples** To enable the Dynamic VLAN assignment feature on interface port1.0.2, use the commands:

```
awplus# configure terminal
awplus(config)# interface port1.0.2
awplus(config-if)# switchport access vlan 10
awplus(config-if)# auth-web enable
awplus(config-if)# auth dynamic-vlan-creation
awplus(config-if)# interface vlan10
awplus(config-if)# ip address 10.1.1.1/24
```

To enable the Dynamic VLAN assignment feature with Web Authentication on interface port1.0.2 when Web Authentication is needed, use the commands:

```
awplus# configure terminal
awplus(config)# auth-web-server ipaddress 1.2.3.4
awplus(config)# access-list hardware acl-web send-to-cpu ip any
1.2.3.4
awplus(config)# interface port1.0.2
awplus(config-if)# auth-web enable
awplus(config-if)# auth dynamic-vlan-creation
awplus(config-if)# access-group acl-web
awplus(config-if)# interface vlan1
awplus(config-if)# ip address 10.1.1.1/24
```

To disable the Dynamic VLAN assignment feature on interface port1.0.2, use the commands:

```
awplus# configure terminal
awplus(config)# interface port1.0.2
awplus(config-if)# no auth dynamic-vlan-creation
```

To enable the Dynamic VLAN assignment feature on authentication profile 'student', use the commands:

```
awplus# configure terminal
awplus(config)# auth profile student
awplus(config-auth-profile)# auth dynamic-vlan-creation
```

**Related  
commands**

[auth profile \(global\)](#)  
[auth host-mode](#)  
[show dot1x](#)  
[show dot1x interface](#)  
[show running-config](#)

**Command  
changes**

Version 5.4.9-2.1: command added to AR2050V, AR3050S, and AR4050S

# auth guest-vlan

**Overview** Use this command to enable and configure the Guest VLAN feature on the interface specified by associating a Guest VLAN with an interface. This command does not start authentication. The supplicant's (client device's) traffic is associated with the native VLAN of the interface unless it is already associated with another VLAN. The **routing** option enables routing from the Guest VLAN to another VLAN, so the switch can lease DHCP addresses and accept access to a limited network.

The **no** variant of this command disables the guest VLAN feature on the interface specified.

**Syntax** `auth guest-vlan <1-4094> [routing]`  
`no auth guest-vlan [routing]`

Parameter	Description
<1-4094>	VLAN ID (VID).
routing	Enables routing from the Guest VLAN to other VLANs.

**Default** The Guest VLAN authentication feature is disabled by default.

**Mode** Interface Configuration for a static channel, a dynamic (LACP) channel group, or a switch port; or Authentication Profile mode.

**Usage notes** The Guest VLAN feature may be used by supplicants (client devices) that have not attempted authentication, or have failed the authentication process. Note that if a port is in multi-supplicant mode with per-port dynamic VLAN configuration, after the first successful authentication, subsequent hosts cannot use the guest VLAN due to the change in VLAN ID. This may be avoided by using per-user dynamic VLAN assignment.

When using the Guest VLAN feature with the multi-host mode, a number of supplicants can communicate via a guest VLAN before authentication. A supplicant's traffic is associated with the native VLAN of the specified switch port. The supplicant must belong to a VLAN before traffic from the supplicant can be associated.

Note that you must enable 802.1X on the port and define a VLAN using the [vlan](#) command before you can configure it as a guest VLAN.

Roaming Authentication cannot be enabled if DHCP snooping is enabled ([service dhcp-snooping](#) command), and vice versa.

Note that Guest VLAN can use only untagged ports.

See the [AAA and Port Authentication Feature Overview and Configuration Guide](#) for information about:

- Guest VLAN, and

- restrictions regarding combinations of authentication enhancements working together

**Examples** To define vlan100 and assign the guest VLAN feature to vlan100 on interface port1.0.2, and enable routing from the guest VLAN to other VLANs, use the following commands:

```
awplus# configure terminal
awplus(config)# vlan database
awplus(config-vlan)# vlan 100
awplus(config-vlan)# exit
awplus(config)# interface port1.0.2
awplus(config-if)# dot1x port-control auto
awplus(config-if)# auth guest-vlan 100 routing
```

To disable the guest VLAN feature on port1.0.2, use the following commands:

```
awplus# configure terminal
awplus(config)# interface port1.0.2
awplus(config-if)# no auth guest-vlan
```

To define vlan100 and assign the guest VLAN feature to vlan100 on authentication profile 'student', use the commands:

```
awplus# configure terminal
awplus(config)# vlan database
awplus(config-vlan)# vlan 100
awplus(config-vlan)# exit
awplus(config)# auth profile student
awplus(config-auth-profile)# auth guest-vlan 100
```

**Related commands**

- [auth profile \(global\)](#)
- [auth guest-vlan forward](#)
- [dot1x port-control](#)
- [show dot1x](#)
- [show dot1x interface](#)

**Command changes** Version 5.4.9-2.1: command added to AR2050V, AR3050S, and AR4050S



# auth guest-vlan forward

**Overview** Use this command to enable packet forwarding from the Guest VLAN to a destination IP address or subnet. If this command is configured, the device can lease DHCP addresses and accept access to a limited part of your network. Also, when using NAP authentication, the supplicant can log on to a domain controller to gain certification.

Use the **no** variant of this command to disable packet forwarding from the Guest VLAN to a destination IP address or subnet.

**Syntax** `auth guest-vlan forward {<ip-address>|<ip-address/mask>} [dns|tcp <1-65535>|udp <1-65535>]`  
`no auth guest-vlan forward {<ip-address>|<ip-address/mask>} [dns|tcp <1-65535>|udp <1-65535>]`

Parameter	Description
<code>&lt;ip-address&gt;</code> <code>&lt;ip-address/mask&gt;</code>	The IP address or subnet to which the guest VLAN can forward packets, in dotted decimal notation
<code>dns</code>	Enable forwarding of DNS packets
<code>tcp &lt;1-65535&gt;</code>	Enable forwarding of packets for the specified TCP port number
<code>udp &lt;1-65535&gt;</code>	Enable forwarding of packets for the specified UDP port number

**Default** Forwarding is disabled by default.

**Mode** Interface Configuration mode for a specified switch port, or Authentication Profile mode

**Usage** Before using this command, you must configure the guest VLAN with the [auth guest-vlan](#) command.

**Example** To enable packet forwarding from the guest VLAN to the destination IP address on interface port1.0.2, use the commands:

```
awplus# configure terminal
awplus(config)# interface port1.0.2
awplus(config-if)# auth guest-vlan forward 10.0.0.1
```

To enable forwarding of DNS packets from the guest VLAN to the destination IP address on interface port1.0.2, use the commands:

```
awplus# configure terminal
awplus(config)# interface
awplus(config-if)# auth guest-vlan forward 10.0.0.1 dns
```

To disable forwarding of DNS packets from the guest VLAN to the destination IP address on port1.0.2, use the commands:

```
awplus# configure terminal
awplus(config)# interface port1.0.2
awplus(config-if)# no auth guest-vlan forward 10.0.0.1 dns
```

To enable the tcp forwarding port 137 on authentication profile 'student', use the commands:

```
awplus# configure terminal
awplus(config)# auth profile student
awplus(config-auth-profile)# auth guest-vlan forward 10.0.0.1
tcp 137
```

**Related  
commands**

[auth guest-vlan](#)  
[auth profile \(global\)](#)  
[show running-config](#)

**Command  
changes**

Version 5.4.9-2.1: command added to AR2050V, AR3050S, and AR4050S

# auth host-mode

**Overview** Use this command to select the host mode on the specified interface. Use the **no** variant of this command to set host mode to the default setting (single host).

**Syntax** `auth host-mode {single-host|multi-host|multi-supPLICANT}`  
`no auth host-mode`

Parameter	Description
single-host	In this mode, only one supplicant is allowed per port. This is the default mode.
multi-host	In this mode, once the first host on a port is authenticated, all other downstream hosts are allowed without being authenticated (piggy-back mode).
multi-supPLICANT	In this mode, multiple separate supplicants are individually authenticated on one port.

**Default** The default host mode for port authentication is for a single host.

**Mode** Interface Configuration for a static channel, a dynamic (LACP) channel group, or a switch port; or Authentication Profile mode.

## Usage notes **Single-host mode**

With this mode, only one supplicant may be authenticated on the port. Once that host has been authenticated, no other supplicants may be authenticated until the first supplicant's session has closed. This means, of course, that none of the other hosts downstream of the port will be able to send or receive traffic on that port.

This option is recommended when you know that there should only be one host connected to a port. By limiting the port to a single authenticated host, you guard against the consequences of someone accidentally or maliciously connecting a downstream switch to the port.

## **Multi-host mode**

With this mode, once the first host has been authenticated on the port, all other downstream hosts are allowed without being authenticated. This is sometimes known as piggy-back mode. It is useful when the downstream switch attached to the authenticating port is an intelligent switch that can act as an authentication supplicant.

If you trust that malicious users cannot be connected to that switch but you do not know the identity of those users, then you can simply authenticate the switch and then allow its attached users to have network access. If the valid switch is disconnected and an invalid one is connected which is not configured with the correct authentication credentials, then the devices connected to the invalid switch will be blocked from accessing the network.

**Examples** To set the host mode to multi-supPLICANT on interface port1.0.2, use the following commands:

```
awplus# configure terminal
awplus(config)# interface port1.0.2
awplus(config-if)# auth host-mode multi-supPLICANT
```

To set the host mode to default (single host) on interface port1.0.2, use the following commands:

```
awplus# configure terminal
awplus(config)# interface port1.0.2
awplus(config-if)# no auth host-mode
```

To set the host mode to multi-supPLICANT on authentication profile 'student', use the commands:

```
awplus# configure terminal
awplus(config)# auth profile student
awplus(config-auth-profile)# auth host-mode multi-supPLICANT
```

To set the host mode to default (single host) on authentication profile 'student', use the commands:

```
awplus# configure terminal
awplus(config)# auth profile student
awplus(config-auth-profile)# no auth host-mode
```

**Related commands**

- [auth profile \(global\)](#)
- [show dot1x](#)
- [show dot1x interface](#)
- [show running-config](#)

# auth log

**Overview** Use this command to configure the types of authentication feature log messages that are output to the log file.

Use the **no** variant of this command to remove either specified types or all types of authentication feature log messages that are output to the log file.

**Syntax**

```
auth log {dot1x|auth-mac|auth-web}  
{success|failure|logoff|all}  
  
no auth log {dot1x|auth-mac|auth-web}  
{success|failure|logoff|all}
```

Parameter	Description
dot1x	Specify only 802.1X-Authentication log messages are output to the log file.
auth-mac	Specify only MAC-Authentication log messages are output to the log file.
auth-web	Specify only Web-Authentication log messages are output to the log file.
success	Specify only successful authentication log messages are output to the log file.
failure	Specify only authentication failure log messages are output to the log file.
logoff	Specify only authentication log-off messages are output to the log file. Note that link down, age out and expired ping polling messages will be included.
all	Specify all types of authentication log messages are output to the log file. Note that this is the default behavior for the authentication logging feature.

**Default** All types of authentication log messages are output to the log file by default.

**Mode** Interface Configuration for a static channel, a dynamic (LACP) channel group, or a switch port; or Authentication Profile mode.

**Examples** To configure the logging of MAC authentication failures to the log file for supplicants (client devices) connected to interface port1.0.2, use the following commands:

```
awplus# configure terminal  
awplus(config)# interface port1.0.2  
awplus(config-if)# auth log auth-mac failure
```

To disable the logging of all types of authentication log messages to the log file for auth-mac supplicants (client devices) connected to interface port1.0.2, use the following commands:

```
awplus# configure terminal
awplus(config)# interface port1.0.2
awplus(config-if)# no auth log auth-mac all
```

To configure the logging of web authentication failures to the log file for supplicants (client devices) connected to authentication profile 'student', use the commands:

```
awplus# configure terminal
awplus(config)# auth profile student
awplus(config-auth-profile)# auth log auth-web failure
```

To disable the logging of all types of authentication log messages to the log file for auth-mac supplicants (client devices) connected to authentication profile 'student', use the commands:

```
awplus# configure terminal
awplus(config)# auth profile student
awplus(config-auth-profile)# no auth log auth-mac all
```

**Related commands**

- [auth profile \(global\)](#)
- [show running-config](#)

# auth max-supPLICANT

**Overview** Use this command to set the maximum number of supplicants (client devices) that can be authenticated on the selected port. Once this value is exceeded, further supplicants will not be authenticated.

The **no** variant of this command resets the maximum supplicant number to the default.

**Syntax** `auth max-supPLICANT <2-1024>`  
`no auth max-supPLICANT`

Parameter	Description
<2-1024>	Limit number.

**Default** The max supplicant of port authentication is 1024.

**Mode** Interface Configuration for a static channel, a dynamic (LACP) channel group, or a switch port; or Authentication Profile mode.

**Examples** To set the maximum number of supplicants to 10 on interface port1.0.2, use the following commands:

```
awplus# configure terminal
awplus(config)# interface port1.0.2
awplus(config-if)# auth max-supPLICANT 10
```

To reset the maximum number of supplicants to the default value on interface port1.0.2, use the following commands:

```
awplus# configure terminal
awplus(config)# interface port1.0.2
awplus(config-if)# no auth max-supPLICANT
```

To set the maximum number of supplicants to 10 on authentication profile 'student', use the commands:

```
awplus# configure terminal
awplus(config)# auth profile student
awplus(config-auth-profile)# auth max-supPLICANT 10
```

To reset the maximum number of supplicants to the default value on authentication profile 'student', use the commands:

```
awplus# configure terminal
awplus(config)# auth profile student
awplus(config-auth-profile)# no auth max-supPLICANT
```

**Related  
commands**    `auth profile (global)`  
                  `show dot1x`  
                  `show dot1x interface`  
                  `show running-config`



# auth multi-vlan-session

**Overview** Use this command to enable packet forwarding on multiple VLANs for an authenticated supplicant attached to a trunked (tagged VLAN) port.

By default, AlliedWare Plus only allows packet forwarding on the VLAN that a device was authenticated on. This command enables packet forwarding to the attached device on any VLAN configured on the switchport. After the device authenticates it will have access to all VLANs configured on the switchport.

Use the **no** variant of this command to disable packet forwarding on multiple VLANs for an authenticated supplicant.

**Syntax** `auth multi-vlan-session`  
`no auth multi-vlan-session`

**Default** By default, **multi-vlan-session** is disabled.

**Mode** Interface Configuration for a static channel, a dynamic (LACP) channel group, or a switch port; or Authentication Profile mode.

**Example** To allow a client attached to port1.0.2 to access all VLANs configured on the AlliedWare Plus device, use the commands:

```
awplus# configure terminal
awplus(config)# interface port1.0.2
awplus(config-if)# switchport mode trunk
awplus(config-if)# switchport trunk allowed vlan all
awplus(config-if)# auth host-mode multi-supplicant
awplus(config-if)# auth multi-vlan-session
```

To disable **multi-vlan-session** on interface port1.0.2, use the commands:

```
awplus# configure terminal
awplus(config)# interface port1.0.2
awplus(config-if)# no auth multi-vlan-session
```

**Related commands**

- [auth-mac enable](#)
- [auth-web enable](#)
- [dot1x port-control](#)
- [show auth interface](#)
- [show dot1x interface](#)

**Command changes** Version 5.4.8-1.1: command added  
Version 5.4.9-2.1: command added to AR2050V, AR3050S, and AR4050S

# auth profile (global)

**Overview** Use this command to enter port authentication profile mode and configure a port authentication profile.

If the specified profile does not exist a new authentication profile is created with the name provided.

Use the **no** variant of this command to delete the specified port authentication profile.

**Syntax** `auth profile <profile-name>`  
`no auth profile <profile-name>`

Parameter	Description
<code>&lt;profile-name&gt;</code>	Name of the profile to create or configure.

**Default** No port authentication profiles are created by default.

**Mode** Global Configuration

**Usage** A port authentication profile is a configuration object that aggregates multiple port authentication commands. These profiles are attached or detached from an interface using the [auth profile \(interface\)](#) command.

**Example** To create a new authentication profile 'student', use the following commands:

```
awplus# configure terminal
awplus(config)# auth profile student
awplus(config-auth-profile)#
```

To delete an authentication profile 'student', use the following commands:

```
awplus# configure terminal
awplus(config)# no auth profile student
```

**Related commands** [auth profile \(interface\)](#)  
[description \(auth-profile\)](#)

# auth profile (interface)

**Overview** Use this command to attach a port authentication profile to the current interface. Use the **no** variant of this command to detach a port authentication profile from the current interface.

**Syntax** `auth profile <profile-name>`  
`no auth profile <profile-name>`

Parameter	Description
<code>&lt;profile-name&gt;</code>	The name of the profile to attach to the current interface.

**Default** No profile is attached by default.

**Mode** Interface Configuration for a static channel, a dynamic (LACP) channel group, or a switch port; or Authentication Profile mode.

**Usage** This command attaches an authentication profile, that was created using the [auth profile \(global\)](#) command, to a static channel, a dynamic (LACP) channel group, or a switch port.

You can only attach one profile to an interface at a time. Use the **no** variant of the command to detach a profile before attempting to attach another one.

**Example** To attach the authentication profile 'student' to port1.0.2, use the following commands:

```
awplus# configure terminal
awplus(config)# interface port1.0.2
awplus(config-if)# auth profile student
```

To detach the authentication profile 'student' from port1.0.2, use the following commands:

```
awplus# configure terminal
awplus(config)# interface port1.0.2
awplus(config-if)# no auth profile student
```

**Related commands** [auth profile \(global\)](#)

# auth reauthentication

**Overview** Use this command to enable re-authentication on the interface specified in the Interface mode, which may be a static channel group (or static aggregator) or a dynamic (or LACP) channel group or a switch port.

Use the **no** variant of this command to disable reauthentication on the interface.

**Syntax** `auth reauthentication`  
`no auth reauthentication`

**Default** Reauthentication of port authentication is disabled by default.

**Mode** Interface Configuration for a static channel, a dynamic (LACP) channel group, or a switch port; or Authentication Profile mode.

**Examples** To enable reauthentication on interface port1.0.2, use the following commands:

```
awplus# configure terminal
awplus(config)# interface port1.0.2
awplus(config-if)# auth reauthentication
```

To disable reauthentication on interface port1.0.2, use the following commands:

```
awplus# configure terminal
awplus(config)# interface port1.0.2
awplus(config-if)# no auth reauthentication
```

To enable reauthentication on authentication profile 'student', use the commands:

```
awplus# configure terminal
awplus(config)# auth profile student
awplus(config-auth-profile)# auth reauthentication
```

**Related commands** [auth profile \(global\)](#)  
[show dot1x](#)  
[show dot1x interface](#)  
[show running-config](#)

# auth roaming disconnected

**Overview** This command allows a supplicant to move to another authenticating interface without reauthentication, even if the link is down for the interface that the supplicant is currently connected to.

You must enter the [auth roaming enable](#) command on both interfaces before using this command.

The **no** variant of this command disables roaming authentication on interfaces that are link-down, and forces a supplicant to be reauthenticated when moving between interfaces.

See the [AAA and Port Authentication Feature Overview and Configuration Guide](#) for further information about this feature.

**Syntax** `auth roaming disconnected`  
`no auth roaming disconnected`

**Default** By default, the authentication status for a roaming supplicant is deleted when an interface goes down, so supplicants must reauthenticate.

**Mode** Interface Configuration for a static channel, a dynamic (LACP) channel group, or a switch port; or Authentication Profile mode.

**Usage notes** Note that 802.1X port authentication, MAC-authentication, or Web-authentication must be configured before using this feature. The port that the supplicant is moving to must have the same authentication configuration as the port the supplicant is moving from.

Roaming Authentication cannot be enabled if DHCP snooping is enabled ([service dhcp-snooping](#) command), and vice versa.

**Examples** To allow supplicants to move from port1.0.2 without reauthentication even when the link is down, when using 802.1X authentication, use the commands:

```
awplus# configure terminal
awplus(config)# interface port1.0.2
awplus(config-if)# dot1x port-control auto
awplus(config-if)# auth roaming enable
awplus(config-if)# auth roaming disconnected
```

To require supplicants to reauthenticate when moving from port1.0.2 if the link is down, when using 802.1X authentication, use the commands:

```
awplus# configure terminal
awplus(config)# interface port1.0.2
awplus(config-if)# no auth roaming disconnected
```

To allow supplicants using authentication profile 'student' to move between ports without reauthentication even when the link is down, use the commands:

```
awplus# configure terminal
awplus(config)# auth profile student
awplus(config-auth-profile)# auth roaming disconnected
```

To require supplicants using authentication profile 'student' to reauthenticate when moving between ports if the link is down, use the commands:

```
awplus# configure terminal
awplus(config)# auth profile student
awplus(config-auth-profile)# no auth roaming disconnected
```

**Related  
commands**

- auth profile (global)
- auth-mac enable
- auth roaming enable
- auth-web enable
- dot1x port-control
- show auth interface
- show dot1x interface
- show running-config

# auth roaming enable

**Overview** Use this command to allow a supplicant to move to another authenticating interface without reauthentication, providing the link is up for the interface that the supplicant is currently connected to.

The **no** variant of this command disables roaming authentication on an interface, and forces a supplicant to be reauthenticated when moving between interfaces.

See the [AAA and Port Authentication Feature Overview and Configuration Guide](#) for further information about this feature.

**Syntax** `auth roaming enable`  
`no auth roaming enable`

**Default** Roaming authentication is disabled by default.

**Mode** Interface Configuration for a static channel, a dynamic (LACP) channel group, or a switch port; or Authentication Profile mode.

**Usage notes** Note that 802.1X port authentication, MAC authentication, or web-based authentication must be configured before using this feature. The port that the supplicant is moving to must have the same authentication configuration as the port the supplicant is moving from.

This command only enables roaming authentication for links that are up. If you want roaming authentication on links that are down, you must also use the command [auth roaming disconnected](#).

Roaming Authentication cannot be enabled if DHCP snooping is enabled ([service dhcp-snooping](#) command), and vice versa.

**Examples** To enable roaming authentication for port1.0.4, when using auth-mac authentication, use the commands:

```
awplus# configure terminal
awplus(config)# interface port1.0.4
awplus(config-if)# auth-mac enable
awplus(config-if)# auth roaming enable
```

To disable roaming authentication for port1.0.4, use the commands:

```
awplus# configure terminal
awplus(config)# interface port1.0.4
awplus(config-if)# no auth roaming enable
```

To enable roaming authentication for authentication profile 'student', use the commands:

```
awplus# configure terminal
awplus(config)# auth profile student
awplus(config-auth-profile)# auth roaming enable
```

**Related commands**

- auth profile (global)
- auth-mac enable
- auth roaming disconnected
- auth-web enable
- dot1x port-control
- show auth interface
- show dot1x interface
- show running-config



# auth supplicant-ip

**Overview** Use this command to add a supplicant (client device) IP address on a given interface and provides parameters for its configuration.

Use the **no** variant of this command to delete the supplicant IP address and reset other parameters to their default values. The IP address can be determined before authentication for auth-web clients only.

**Syntax** `auth supplicant-ip <ip-addr> [max-reauth-req <1-10>] [port-control {auto|force-authorized|force-unauthorized|skip-second-auth}] [quiet-period <1-65535>] [reauth-period <1-4294967295>] [supp-timeout <1-65535>] [server-timeout <1-65535>] [reauthentication]`  
`no auth supplicant-ip <ip-addr> [reauthentication]`

Parameter	Description
<code>&lt;ip-addr&gt;</code>	IP address of the supplicant entry in A.B.C.D/P format.
<code>max-reauth-req</code>	The number of reauthentication attempts before becoming unauthorized.
<code>&lt;1-10&gt;</code>	Count of reauthentication attempts (default 2).
<code>port-control</code>	Port control commands.
<code>auto</code>	A port control parameter that allows port clients to negotiate authentication.
<code>force-authorized</code>	A port control parameter that forces the port state to authorized.
<code>force-unauthorized</code>	A port control parameter that forces the port state to unauthorized.
<code>skip-second-auth</code>	Skip the second authentication.
<code>quiet-period</code>	Quiet period during which the port remains in the HELD state (default 60 seconds).
<code>&lt;1-65535&gt;</code>	Seconds for quiet period.
<code>reauth-period</code>	Seconds between reauthorization attempts (default 3600 seconds).
<code>&lt;1-4294967295&gt;</code>	Seconds for reauthorization attempts (reauth-period).
<code>supp-timeout</code>	Supplicant response timeout.
<code>&lt;1-65535&gt;</code>	Seconds for supplicant response timeout (default 30 seconds).
<code>server-timeout</code>	The period, in seconds, before the authentication server response times out.

Parameter	Description
<1-65535>	The server-timeout period, in seconds, default 3600 seconds.
reauthentication	Enable reauthentication on a port.

**Default** No supplicant IP address for port authentication exists by default until first created with the **auth supplicant-ip** command. The defaults for parameters applied are as shown in the table above.

**Mode** Interface Configuration for a static channel, a dynamic (LACP) channel group, or a switch port; or Authentication Profile mode.

**Examples** To add the supplicant IP address 192.168.10.0/24 to force authorized port control for interface port1.0.2, use the commands:

```
awplus# configure terminal
awplus(config)# interface port1.0.2
awplus(config-if)# auth supplicant-ip 192.168.10.0/24
port-control force-authorized
```

To delete the supplicant IP address 192.168.10.0/24 for interface port1.0.2, use the commands:

```
awplus# configure terminal
awplus(config)# interface port1.0.2
awplus(config-if)# no auth supplicant-ip 192.168.10.0/24
```

To disable reauthentication for the supplicant(s) IP address 192.168.10.0/24 for interface port1.0.2, use the commands:

```
awplus# configure terminal
awplus(config)# interface port1.0.2
awplus(config-if)# no auth supplicant-ip 192.168.10.0/24
reauthentication
```

To add the supplicant IP address 192.168.10.0/24 to force authorized port control for auth profile 'student', use the commands:

```
awplus# configure terminal
awplus(config)# auth profile student
awplus(config-auth-profile)# auth supplicant-ip
192.168.10.0/24 port-control force-authorized
```

**Related commands**

- [show auth](#)
- [show dot1x](#)
- [show dot1x interface](#)
- [show running-config](#)

# auth supplicant-mac

**Overview** This command adds a supplicant (client device) MAC address or MAC mask on a given interface with the parameters as specified in the table below.

Use the **no** variant of this command to delete the supplicant MAC address and reset other parameters to their default values.

**Syntax** `auth supplicant-mac <mac-addr> [mask <mac-addr-mask>]  
[max-reauth-req <1-10>] [port-control {auto|force-authorized|  
force-unauthorized|skip-second-auth}] [quiet-period <1-65535>]  
[reauth-period <1-4294967295>] [supp-timeout <1-65535>]  
[server-timeout <1-65535>] [reauthentication]  
  
no auth supplicant-mac <mac-addr> [reauthentication]`

Parameter	Description
<mac-addr>	MAC (hardware) address of the supplicant entry in HHHH.HHHH.HHHH MAC address hexadecimal format.
mask	A mask applied to MAC addresses in order to select only those addresses containing a specific string.
<mac-addr-mask>	The mask comprises a string of three (period separated) bytes, where each byte comprises four hexadecimal characters that will generally be either 1 or 0. When the mask is applied to a specific MAC address, a match is only required for characters that correspond to a 1 in the mask. Characters that correspond to a 0 in the mask are effectively ignored.  In the examples section below, the mask ffff.ff00.0000 is applied for the MAC address 0000.5E00.0000. The applied mask will then match only those MAC addresses that begin with 0000.5E (in this case the OUI component). The remaining portion of the addresses (in this case the NIC component) will be ignored.
port-control	Port control commands.
auto	Allow port client to negotiate authentication.
force-authorized	Force port state to authorized.
force-unauthorized	Force port state to unauthorized.
skip-second-auth	Skip the second authentication.
quiet-period	Quiet period in the HELD state (default 60 seconds).
<1-65535>	Seconds for quiet period.
reauth-period	Seconds between reauthorization attempts (default 3600 seconds).
<1-4294967295>	Seconds for reauthorization attempts (reauth-period).
supp-timeout	Supplicant response timeout (default 30 seconds).

Parameter	Description
<1-65535>	Seconds for supplicant response timeout.
server-timeout	Authentication server response timeout (default 30 seconds).
<1-65535>	Seconds for authentication server response timeout.
reauthentication	Enable reauthentication on a port.
max-reauth-req	No of reauthentication attempts before becoming unauthorized (default 2).
<1-10>	Count of reauthentication attempts.

**Default** No supplicant MAC address for port authentication exists by default until first created with the **auth supplicant-mac** command. The defaults for parameters are shown in the table above.

**Mode** Interface Configuration for a static channel, a dynamic (LACP) channel group, or a switch port; or Authentication Profile mode.

**Examples** To add the supplicant MAC address 0000.5E00.5343 to force authorized port control for interface port1.0.2, use the commands:

```
awplus# configure terminal
awplus(config)# interface port1.0.2
awplus(config-if)# auth supplicant-mac 0000.5E00.5343
port-control force-authorized
```

To apply the mask ffff.ff00.0000 in order to add any supplicant MAC addresses whose MAC address begins with 0000.5E, and then to force authorized port control for interface port1.0.2, use the commands:

```
awplus# configure terminal
awplus(config)# interface port1.0.2
awplus(config-if)# auth supplicant-mac 0000.5E00.0000 mask
ffff.ff00.0000 port-control force-authorized
```

To delete the supplicant MAC address 0000.5E00.5343 for interface port1.0.2, use the commands:

```
awplus# configure terminal
awplus(config)# interface port1.0.2
awplus(config-if)# no auth supplicant-mac 0000.5E00.5343
```

To disable reauthentication for the supplicant MAC address 0000.5E00.5343 for interface port1.0.2, use the commands:

```
awplus# configure terminal
awplus(config)# interface eth1
awplus(config-if)# no auth supplicant-mac 0000.5E00.5343
reauthentication
```

To add the supplicant MAC address 0000.5E00.5343 to force authorized port control for authentication profile 'student', use the commands:

```
awplus# configure terminal
awplus(config)# auth profile student
awplus(config-auth-profile)# auth supplicant-mac
0000.5E00.5343 port-control force-authorized
```

To delete the supplicant MAC address 0000.5E00.5343 for authentication profile 'student', use the commands:

```
awplus# configure terminal
awplus(config)# auth profile student
awplus(config-auth-profile)# no auth supplicant-mac
0000.5E00.5343
```

**Related  
commands**

[show auth](#)  
[show dot1x](#)  
[show dot1x interface](#)  
[show running-config](#)

# auth timeout connect-timeout

**Overview** Use this command to set the connect-timeout period for the interface.  
Use the **no** variant of this command to reset the connect-timeout period to the default.

**Syntax** `auth timeout connect-timeout <1-65535>`  
`no auth timeout connect-timeout`

Parameter	Description
<1-65535>	Specifies the connect-timeout period (in seconds).

**Default** The connect-timeout default is 30 seconds.

**Mode** Interface Configuration for a static channel, a dynamic (LACP) channel group, or a switch port; or Authentication Profile mode.

**Usage notes** This command is used for MAC and web authentication. If the connect-timeout has lapsed and the supplicant has the state **connecting**, then the supplicant is deleted. When `auth-web-server session-keep` or `auth two-step enable` is enabled, we recommend you configure a longer connect-timeout period.

**Examples** To set the connect-timeout period to 3600 seconds for port1.0.2, use the following commands:

```
awplus# configure terminal
awplus(config)# interface port1.0.2
awplus(config-if)# auth timeout connect-timeout 3600
```

To reset the connect-timeout period to the default (30 seconds) for port1.0.2, use the following commands:

```
awplus# configure terminal
awplus(config)# interface port1.0.2
awplus(config-if)# no auth timeout connect-timeout
```

To set the connect-timeout period to 3600 seconds for authentication profile 'student', use the commands:

```
awplus# configure terminal
awplus(config)# auth profile student
awplus(config-auth-profile)# auth timeout connect-timeout 3600
```

**Related commands** `auth profile (global)`  
`show dot1x`  
`show dot1x interface`

# auth timeout quiet-period

**Overview** Use this command to set a time period for which another authentication request is not accepted on a given interface, after an authentication request has failed.

Use the **no** variant of this command to reset the quiet period to the default.

**Syntax** `auth timeout quiet-period <1-65535>`  
`no auth timeout quiet-period`

Parameter	Description
<1-65535>	Specifies the quiet period (in seconds).

**Default** The quiet period for port authentication is 60 seconds.

**Mode** Interface Configuration for a static channel, a dynamic (LACP) channel group, or a switch port; or Authentication Profile mode.

**Examples** To set the quiet period to 10 seconds for interface port1.0.2, use the following commands:

```
awplus# configure terminal
awplus(config)# interface port1.0.2
awplus(config-if)# auth timeout quiet-period 10
```

To reset the quiet period to the default (60 seconds) for interface port1.0.2, use the following commands:

```
awplus# configure terminal
awplus(config)# interface port1.0.2
awplus(config-if)# no auth timeout quiet-period
```

To set the quiet period to 10 seconds for authentication profile 'student', use the commands:

```
awplus# configure terminal
awplus(config)# auth profile student
awplus(config-auth-profile)# auth timeout quiet-period 10
```

**Related commands** [auth profile \(global\)](#)

# auth timeout reauth-period

**Overview** Use this command to set the timer for reauthentication on a given interface. The re-authentication for the supplicant (client device) is executed at this timeout. The timeout is only applied if the **auth reauthentication** command is applied.

Use the **no** variant of this command to reset the **reauth-period** parameter to the default (3600 seconds).

**Syntax** `auth timeout reauth-period <1-4294967295>`  
`no auth timeout reauth-period`

Parameter	Description
<1-4294967295>	The reauthentication timeout period (in seconds).

**Default** The default reauthentication period for port authentication is 3600 seconds, when reauthentication is enabled on the port.

**Mode** Interface Configuration for a static channel, a dynamic (LACP) channel group, or a switch port; or Authentication Profile mode.

**Examples** To set the reauthentication period to 1 day for interface port1.0.2, use the following commands:

```
awplus# configure terminal
awplus(config)# interface port1.0.2
awplus(config-if)# auth timeout reauth-period 86400
```

To reset the reauthentication period to the default (3600 seconds) for interface port1.0.2, use the following commands:

```
awplus# configure terminal
awplus(config)# interface port1.0.2
awplus(config-if)# no auth timeout reauth-period
```

To set the reauthentication period to 1 day for authentication profile 'student', use the commands:

```
awplus# configure terminal
awplus(config)# auth profile student
awplus(config-auth-profile)# auth timeout reauth-period 86400
```

To reset the reauthentication period to the default (3600 seconds) for authentication profile 'student', use the commands:

```
awplus# configure terminal
awplus(config)# auth profile student
awplus(config-auth-profile)# no auth timeout reauth-period
```



**Related commands**

- auth profile (global)
- auth reauthentication
- show dot1x
- show dot1x interface
- show running-config

# auth timeout server-timeout

**Overview** Use this command to set the timeout for the waiting response from the RADIUS server on a given interface.

Use the **no** variant of this command to reset the server-timeout to the default (30 seconds).

**Syntax** `auth timeout server-timeout <1-65535>`  
`no auth timeout server-timeout`

Parameter	Description
<1-65535>	Server timeout period (in seconds).

**Default** The server timeout for port authentication is 30 seconds.

**Mode** Interface Configuration for a static channel, a dynamic (LACP) channel group, or a switch port; or Authentication Profile mode.

**Examples** To set the server timeout to 120 seconds for interface port1.0.2, use the following commands:

```
awplus# configure terminal
awplus(config)# interface port1.0.2
awplus(config-if)# auth timeout server-timeout 120
```

To set the server timeout to the default (30 seconds) for interface port1.0.2 use the following commands:

```
awplus# configure terminal
awplus(config)# interface port1.0.2
awplus(config-if)# no auth timeout server-timeout
```

To set the server timeout to 120 seconds for authentication profile 'student', use the commands:

```
awplus# configure terminal
awplus(config)# auth profile student
awplus(config-auth-profile)# auth timeout server-timeout 120
```

To set the server timeout to the default (30 seconds) for authentication profile 'student', use the commands:

```
awplus# configure terminal
awplus(config)# auth profile student
awplus(config-auth-profile)# no auth timeout server-timeout
```

**Related commands** [auth profile \(global\)](#)

show dot1x  
show dot1x interface  
show running-config

# auth timeout supp-timeout

**Overview** This command sets the timeout of the waiting response from the supplicant (client device) on a given interface.

The **no** variant of this command resets the supplicant timeout to the default (30 seconds).

**Syntax** `auth timeout supp-timeout <1-65535>`  
`no auth timeout supp-timeout`

Parameter	Description
<1-65535>	The supplicant timeout period (in seconds).

**Default** The supplicant timeout for port authentication is 30 seconds.

**Mode** Interface Configuration for a static channel, a dynamic (LACP) channel group, or a switch port; or Authentication Profile mode.

**Examples** To set the supplicant timeout to 2 seconds for interface port1.0.2, use the following commands:

```
awplus# configure terminal
awplus(config)# interface port1.0.2
awplus(config-if)# auth timeout supp-timeout 2
```

To reset the supplicant timeout to the default (30 seconds) for interface port1.0.2, use the following commands:

```
awplus# configure terminal
awplus(config)# interface port1.0.2
awplus(config-if)# no auth timeout supp-timeout
```

To set the supplicant timeout to 2 seconds for authentication profile 'student', use the commands:

```
awplus# configure terminal
awplus(config)# auth profile student
awplus(config-auth-profile)# auth timeout supp-timeout 2
```

**Related commands**

- [auth profile \(global\)](#)
- [show dot1x](#)
- [show dot1x interface](#)
- [show running-config](#)

# auth two-step enable

**Overview** Use this command to enable a two-step authentication feature on an interface. When this feature is enabled, the supplicant is authorized in a two-step process. If authentication succeeds, the supplicant becomes authenticated.

Use this command to apply the two-step authentication method based on 802.1X, MAC or web authentication.

Use the **no** variant of this command disables the two-step authentication feature.

**Syntax** `auth two-step enable`  
`no auth two-step enable`

**Default** Two step authentication is disabled by default.

**Mode** Interface Configuration for a static channel, a dynamic (LACP) channel group, or a switch port; or Authentication Profile mode.

**Usage** The single step authentication methods (either user or device authentication) have a potential security risk:

- an unauthorized user can access the network with an authorized device, or
- an authorized user can access the network with an unauthorized device.

Two-step authentication solves this problem by authenticating both the user and the device. The supplicant will only become authenticated if both these steps are successful. If the first authentication step fails, then the second step is not started.

**Examples** To enable the two step authentication feature, use the following commands:

```
awplus# configure terminal
awplus(config)# interface port1.0.2
awplus(config-if)# auth two-step enable
```

To disable the two step authentication feature, use the following commands:

```
awplus# configure terminal
awplus(config)# interface port1.0.2
awplus(config-if)# no auth two-step enable
```

To enable MAC authentication followed by 802.1X authentication, use the following commands:

```
awplus# configure terminal
awplus(config)# interface port1.0.2
awplus(config-if)# switchport mode access
awplus(config-if)# auth-mac enable
awplus(config-if)# dot1x port-control auto
awplus(config-if)# auth dynamic-vlan-creation
awplus(config-if)# auth two-step enable
```

To enable MAC authentication followed by web authentication, use the following commands:

```
awplus# configure terminal
awplus(config)# interface port1.0.2
awplus(config-if)# switchport mode access
awplus(config-if)# auth-mac enable
awplus(config-if)# auth-web enable
awplus(config-if)# auth dynamic-vlan-creation
awplus(config-if)# auth two-step enable
```

To enable 802.1X authentication followed by web authentication, use the following commands:

```
awplus# configure terminal
awplus(config)# interface port1.0.2
awplus(config-if)# switchport mode access
awplus(config-if)# dot1x port-control auto
awplus(config-if)# auth-web enable
awplus(config-if)# auth dynamic-vlan-creation
awplus(config-if)# auth two-step enable
```

To enable the two step authentication feature for authentication profile 'student', use the commands:

```
awplus# configure terminal
awplus(config)# auth profile student
awplus(config-auth-profile)# auth two-step enable
```

**Related Commands**

- auth profile (global)
- show auth two-step supplicant brief
- show auth
- show auth interface
- show auth supplicant
- show dot1x
- show dot1x interface
- show dot1x supplicant

**Command changes** Version 5.4.9-2.1: command added to AR2050V, AR3050S, and AR4050S

# auth-mac accounting

**Overview** Use this command to override the **default** RADIUS accounting method for MAC-based authentication on an interface by allowing you to apply a user-defined named list.

Use the **no** variant of this command to remove the named list from the interface and apply the **default** method.

**Syntax** `auth-mac accounting {default|<list-name>}`  
`no auth-mac accounting`

Parameter	Description
default	Apply the default accounting method list
<list-name>	Apply the user-defined named list

**Default** The **default** method list is applied to an interface by default.

**Mode** Interface Configuration for a static channel, a dynamic (LACP) channel group, or a switch port; or Authentication Profile mode.

**Example** To apply the named list 'vlan10\_acct' on the vlan10 interface, use the commands:

```
awplus# configure terminal
awplus(config)# interface vlan10
awplus(config-if)# auth-mac accounting vlan10_acct
```

To remove the named list from the vlan10 interface and set the accounting method back to **default**, use the commands:

```
awplus# configure terminal
awplus(config)# interface vlan10
awplus(config-if)# no auth-mac accounting
```

**Related commands** [aaa accounting auth-mac](#)

**Command changes** Version 5.4.8-2.1: Command added to AR2050V, AR3050S, AR4050S



# auth-mac authentication

**Overview** This command overrides the **default** MAC authentication method on an interface by allowing you to apply a user-defined named list.

Use the **no** variant of this command to remove the named list from the interface and apply the **default** method.

**Syntax** `auth-mac authentication {default|<list-name>}`  
`no auth-mac authentication`

Parameter	Description
default	Apply the default authentication method list
<list-name>	Apply a user-defined named list

**Default** The **default** method list is applied to an interface by default.

**Mode** Interface Configuration for a static channel, a dynamic (LACP) channel group, or a switch port; or Authentication Profile mode.

**Example** To apply the named list 'vlan10\_auth' on the vlan10 interface, use the commands:

```
awplus# configure terminal
awplus(config)# interface vlan10
awplus(config-if)# auth-mac authentication vlan10_auth
```

To remove the named list from the vlan10 interface and set the authentication method back to **default**, use the commands:

```
awplus# configure terminal
awplus(config)# interface vlan10
awplus(config-if)# no auth-mac authentication
```

**Related commands** [aaa authentication auth-mac](#)

**Command changes** Version 5.4.8-2.1: Command added to AR2050V, AR3050S, AR4050S

# auth-mac enable

**Overview** This command enables MAC authentication on the interface specified in the Interface command mode.

Use the **no** variant of this command to disable MAC authentication on an interface.

**Syntax** `auth-mac enable`  
`no auth-mac enable`

**Default** MAC-Authentication is disabled by default.

**Mode** Interface Configuration for a static channel, a dynamic (LACP) channel group, or a switch port; or Authentication Profile mode.

**Usage notes** Enabling **spanning-tree edgeport** on ports after enabling MAC authentication avoids unnecessary re-authentication when the port state changes, which does not happen when spanning tree edgeport is enabled. Note that re-authentication is correct behavior without **spanning-tree edgeport** enabled.

Applying **switchport mode access** on ports is also good practice to set the ports to access mode with ingress filtering turned on, whenever ports for MAC authentication are in a VLAN.

**Examples** To enable MAC authentication on interface port1.0.2 and enable spanning tree edgeport to avoid unnecessary re-authentication, use the following commands:

```
awplus# configure terminal
awplus(config)# interface port1.0.2
awplus(config-if)# auth-mac enable
awplus(config-if)# spanning-tree edgeport
awplus(config-if)# switchport mode access
```

To disable MAC authentication on interface port1.0.2, use the following commands:

```
awplus# configure terminal
awplus(config)# interface port1.0.2
awplus(config-if)# no auth-mac enable
```

To enable MAC authentication on authentication profile 'student', use the commands:

```
awplus# configure terminal
awplus(config)# auth profile student
awplus(config-auth-profile)# auth-mac enable
```

**Related commands** [auth profile \(global\)](#)  
[show auth](#)

show auth interface

show running-config

**Command  
changes**

Version 5.4.8-2.1: Command added to AR2050V, AR3050S, AR4050S

# auth-mac method

**Overview** This command sets the type of authentication method for MAC authentication that is used with RADIUS on the interface specified in the interface command mode.

The **no** variant of this command resets the authentication method used to the default method (PAP) as the RADIUS authentication method used by the MAC authentication.

**Syntax** `auth-mac method [eap-md5|pap]`  
`no auth-mac method`

Parameter	Description
<code>eap-md5</code>	Enable EAP-MD5 as the authentication method.
<code>pap</code>	Enable PAP as the authentication method.

**Default** The MAC authentication method is PAP.

**Mode** Interface Configuration for a static channel, a dynamic (LACP) channel group, or a switch port; or Authentication Profile mode.

**Examples** To set the MAC authentication method to PAP on interface port1.0.2, use the following commands:

```
awplus# configure terminal
awplus(config)# interface port1.0.2
awplus(config-if)# auth-mac method pap
```

To set the MAC authentication method to the default on interface port1.0.2, use the following commands:

```
awplus# configure terminal
awplus(config)# interface port1.0.2
awplus(config-if)# no auth-mac method
```

To set the MAC authentication method to EAP-MD5 on authentication profile 'student', use the commands:

```
awplus# configure terminal
awplus(config)# auth profile student
awplus(config-auth-profile)# auth-mac method eap-md5
```

**Related commands** [auth profile \(global\)](#)  
[show auth](#)

show auth interface

show running-config

**Command  
changes**

Version 5.4.8-2.1: Command added to AR2050V, AR3050S, AR4050S

# auth-mac password

**Overview** This command changes the password for MAC-based authentication. Use the **no** variant of this command to return the password to its default.

**Syntax** `auth-mac [encrypted] password <password>`  
`no auth-mac password`

Parameter	Description
<code>auth-mac</code>	MAC-based authentication
<code>encrypted</code>	Specify an encrypted password
<code>password</code>	Configure the password
<code>&lt;password&gt;</code>	The new password. Passwords can be up to 64 characters in length and can contain any printable characters except: <ul style="list-style-type: none"><li>• ?</li><li>• " (double quotes)</li><li>• space</li></ul>

**Default** By default, the password is the MAC address of the supplicant.

**Mode** Global Configuration

**Usage notes** Changing the password increases the security of MAC-based authentication, because the default password is easy for an attacker to discover. This is particularly important if:

- some MAC-based supplicants on the network are intelligent devices, such as computers, and/or
- you are using two-step authentication (see the “Ensuring Authentication Methods Require Different Usernames and Passwords” section of the [AAA and Port Authentication Feature\\_Overview\\_and\\_Configuration\\_Guide](#)).

**Examples** To change the password to verySecurePassword, use the commands:

```
awplus# configure terminal
awplus(config)# auth-mac password verySecurePassword
```

**Related commands** [auth two-step enable](#)  
[show auth](#)

**Command changes** Version 5.4.8-2.1: Command added to AR2050V, AR3050S, AR4050S

# auth-mac reauth-relearning

**Overview** This command sets the MAC address learning of the supplicant (client device) to re-learning for re-authentication on the interface specified in the interface command mode.

Use the **no** variant of this command to disable the auth-mac re-learning option.

**Syntax** `auth-mac reauth-relearning`  
`no auth-mac reauth-relearning`

**Default** Re-learning for port authentication is disabled by default.

**Mode** Interface Configuration for a static channel, a dynamic (LACP) channel group, or a switch port; or Authentication Profile mode.

**Examples** To enable the re-authentication re-learning feature on interface port1.0.2, use the following commands:

```
awplus# configure terminal
awplus(config)# interface port1.0.2
awplus(config-if)# auth-mac reauth-relearning
```

To disable the re-authentication re-learning feature on interface port1.0.2, use the following commands:

```
awplus# configure terminal
awplus(config)# interface port1.0.2
awplus(config-if)# no auth-mac reauth-relearning
```

To enable the re-authentication re-learning feature on authentication profile 'student', use the commands:

```
awplus# configure terminal
awplus(config)# auth profile student
awplus(config-auth-profile)# auth-mac reauth-relearning
```

**Related commands** [auth profile \(global\)](#)  
[show auth](#)  
[show auth interface](#)  
[show running-config](#)

**Command changes** Version 5.4.8-2.1: Command added to AR2050V, AR3050S, AR4050S

# auth-mac static

**Overview** This command configures MAC authentication to use static entries in the FDB. Static entries persist in the FDB, even if there is no traffic flow from the supplicant.

When static FDB entries are configured, the [auth roaming disconnected](#) command is supported for MAC authentication. This command allows a supplicant to move to another authenticating interface without re-authentication.

Use the **no** variant of this command to revert to dynamic FDB entries.

**Syntax** `auth-mac static`  
`no auth-mac static`

**Default** By default MAC authentication supplicants are added to the FDB dynamically.

**Mode** Global Configuration

**Example** To configure MAC authentication to use static FDB entries, use the following commands:

```
awplus# configure terminal
awplus(config)# auth-mac static
```

To configure MAC authentication to use dynamic FDB entries, use the following commands:

```
awplus# configure terminal
awplus(config)# no auth-mac static
```

**Related commands** [auth roaming disconnected](#)  
[show auth](#)  
[show dot1x](#)

**Command changes** Version 5.4.7-2.4: Command added  
Version 5.4.8-2.1: Command added to AR2050V, AR3050S, AR4050S



# auth-mac username

**Overview** Use this command to specify the format of the MAC address in the username and password field when a request for MAC-based authorization is sent to a RADIUS server.

**Syntax** `auth-mac username {ietf|unformatted} {lower-case|upper-case}`

Parameter	Description
ietf	The MAC address includes a hyphen between each 2 bytes. (Example: xx-xx-xx-xx-xx-xx)
unformatted	The MAC address does not include hyphens. (Example: xxxxxxxxxxxx)
lower-case	The MAC address uses lower-case characters (a-f)
upper-case	The MAC address uses upper-case characters (A-F)

**Default** `auth-mac username ietf lower-case`

**Mode** Global Configuration

**Usage** This command is provided to allow other vendors', AlliedWare, and AlliedWare Plus switches to share the same format on the RADIUS server.

**Example** To configure the format of the MAC address in the username and password field to be changed to IETF and upper-case, use the following commands:

```
awplus# configure terminal
awplus(config)# auth-mac username ietf upper-case
```

**Related commands** [auth-mac username](#)  
[show running-config](#)

**Command changes** Version 5.4.8-2.1: Command added to AR2050V, AR3050S, AR4050S

# auth-web accounting

**Overview** This command overrides the default RADIUS accounting method for web-based authentication on an interface by allowing you to apply a user-defined named list.

Use the **no** variant of this command to remove the named list from the interface and apply the default method.

**Syntax** `auth-web accounting {default|<list-name>}`  
`no auth-web accounting`

Parameter	Description
default	Apply the default accounting method list
<list-name>	Apply a named accounting method list

**Default** The **default** method list is applied to an interface by default.

**Mode** Interface Configuration for a static channel, a dynamic (LACP) channel group, or a switch port; or Authentication Profile mode.

**Example** To apply the named list 'vlan10\_acct' on the vlan10 interface, use the commands:

```
awplus# configure terminal
awplus(config)# interface vlan10
awplus(config-if)# auth-web accounting vlan10_acct
```

To remove the named list from the vlan10 interface and set the accounting method back to default, use the commands:

```
awplus# configure terminal
awplus(config)# interface vlan10
awplus(config-if)# no auth-web accounting
```

**Related commands** [aaa accounting auth-web](#)

# auth-web authentication

**Overview** Use this command to override the default web-based authentication method on an interface by allowing you to apply a user-defined named list.

Use the **no** variant of this command to remove the named list from the interface and apply the default method.

**Syntax** `auth-web authentication {default | <list-name>}`  
`no auth-web authentication`

Parameter	Description
default	Apply the default authentication method list
<list-name>	Apply the user-defined named list

**Default** The **default** method list is applied to an interface by default.

**Mode** Interface Configuration for a static channel, a dynamic (LACP) channel group, or a switch port; or Authentication Profile mode.

**Example** To apply the named list 'vlan10\_auth' on the vlan10 interface, use the commands:

```
awplus# configure terminal
awplus(config)# interface vlan10
awplus(config-if)# auth-web authentication vlan10_auth
```

To remove the named list from the vlan10 interface and set the authentication method back to default, use the commands:

```
awplus# configure terminal
awplus(config)# interface vlan10
awplus(config-if)# no auth-web authentication
```

**Related commands** [aaa authentication auth-web](#)

# auth-web enable

**Overview** Use this command to enable web-based authentication in Interface mode on the interface specified.

Use the **no** variant of this command to apply its default.

**Syntax** `auth-web enable`  
`no auth-web enable`

**Default** Web authentication is disabled by default.

**Mode** Interface Configuration for a static channel, a dynamic (LACP) channel group, or a switch port; or Authentication Profile mode.

**Usage notes** Web-based authentication cannot be enabled if DHCP snooping is enabled by using the [service dhcp-snooping](#) command, and vice versa. You need to configure an IPv4 address for the VLAN interface on which web authentication is running.

**Examples** To enable web authentication on static-channel-group 2, use the following commands:

```
awplus# configure terminal
awplus(config)# interface port1.0.2
awplus(config-if)# static-channel-group 2
awplus(config-if)# exit
awplus(config)# interface sa2
awplus(config-if)# auth-web enable
```

To disable web authentication on static-channel-group 2, use the following commands:

```
awplus# configure terminal
awplus(config)# interface sa2
awplus(config-if)# no auth-web enable
```

To enable web authentication on authentication profile 'student', use the commands:

```
awplus# configure terminal
awplus(config)# auth profile student
awplus(config-auth-profile)# auth-web enable
```

To disable web authentication on authentication profile 'student', use the commands:

```
awplus# configure terminal
awplus(config)# auth profile student
awplus(config-auth-profile)# no auth-web enable
```

**Related  
commands**    auth profile (global)  
                  show auth  
                  show auth interface  
                  show running-config

# auth-web forward

**Overview** Use this command to enable the web authentication packet forwarding feature on the interface specified. This command also enables ARP forwarding, and adds forwarded packets to the **tcp** or **udp** port number specified.

Use the **no** variant of this command to disable the specified packet forwarding feature on the interface.

**Syntax** `auth-web forward [<ip-address>|<ip-address/prefix-length>]  
{dns|tcp <1-65535>|udp <1-65535>}`

or

`auth-web forward {arp|dhcp|dns|tcp <1-65535>|udp <1-65535>}`

The **no** variants of this command are:

`no auth-web forward [<ip-address>|<ip-address/prefix-length>]  
{dns|tcp <1-65535>|udp <1-65535>}`

or

`no auth-web forward {arp|dhcp|dns|tcp <1-65535>|udp <1-65535>}`

Parameter	Description
<code>&lt;ip-address&gt;</code> <code>&lt;ip-address/ prefix-length&gt;</code>	The IP address or subnet on which the web authentication is to be enabled.
<code>arp</code>	Enable forwarding of ARP.
<code>dhcp</code>	Enable forwarding of DHCP (67/udp).
<code>dns</code>	Enable forwarding of DNS (53/udp).
<code>tcp</code>	Enable forwarding of TCP specified port number.
<code>&lt;1-65535&gt;</code>	TCP Port number.
<code>udp</code>	Enable forwarding of UDP specified port number.
<code>&lt;1-65535&gt;</code>	UDP Port number.

**Default** Packet forwarding for port authentication is enabled by default for "arp", "dhcp" and "dns".

**Mode** Interface Configuration for a static channel, a dynamic (LACP) channel group, or a switch port; or Authentication Profile mode.

**Usage notes** For more information about the `<ip-address>` parameter, and an example, see the "auth-web forward" section in the [AlliedWare Plus Technical Tips and Tricks](#).

**Examples** To enable the ARP forwarding feature on interface port1.0.2, use the following commands:

```
awplus# configure terminal
awplus(config)# interface port1.0.2
awplus(config-if)# auth-web forward arp
```

To add TCP forwarding port 137 on interface port1.0.2, use the following commands:

```
awplus# configure terminal
awplus(config)# interface port1.0.2
awplus(config-if)# auth-web forward tcp 137
```

To add the DNS Server IP address 192.168.1.10 on interface port1.0.2, use the following commands:

```
awplus# configure terminal
awplus(config)# interface port1.0.2
awplus(config-if)# switchport mode access
awplus(config-if)# auth-web enable
awplus(config-if)# auth dynamic-vlan-creation
awplus(config-if)# auth-web forward 192.168.1.10 dns
```

To disable the ARP forwarding feature on interface port1.0.2, use the following commands:

```
awplus# configure terminal
awplus(config)# interface port1.0.2
awplus(config-if)# no auth-web forward arp
```

To delete TCP forwarding port 137 on interface port1.0.2, use the following commands:

```
awplus# configure terminal
awplus(config)# interface port1.0.2
awplus(config-if)# no auth-web forward tcp 137
```

To delete all TCP forwarding on interface port1.0.2, use the following commands:

```
awplus# configure terminal
awplus(config)# interface port1.0.2
awplus(config-if)# no auth-web forward tcp
```

To enable the ARP forwarding feature on authentication profile 'student', use the commands:

```
awplus# configure terminal
awplus(config)# auth profile student
awplus(config-auth-profile)# auth-web forward arp
```

To add TCP forwarding port 137 on authentication profile 'student', use the commands:

```
awplus# configure terminal
awplus(config)# auth profile student
awplus(config-auth-profile)# auth-web forward tcp 137
```

To disable the ARP forwarding feature on authentication profile 'student', use the commands:

```
awplus# configure terminal
awplus(config)# auth profile student
awplus(config-auth-profile)# no auth-web forward arp
```

To delete TCP forwarding port 137 on authentication profile 'student', use the commands:

```
awplus# configure terminal
awplus(config)# auth profile student
awplus(config-auth-profile)# no auth-web forward tcp 137
```

To delete all TCP forwarding on authentication profile 'student', use the commands:

```
awplus# configure terminal
awplus(config)# auth profile student
awplus(config-auth-profile)# no auth-web forward tcp
```

**Related  
commands**

[auth profile \(global\)](#)  
[show auth](#)  
[show auth interface](#)



# auth-web max-auth-fail

**Overview** Use this command to set the number of authentication failures allowed before rejecting further authentication requests. When the supplicant (client device) fails more than the specified number of times, then login requests are refused during the quiet period.

Use the **no** variant of this command to reset the maximum number of authentication failures to the default.

**Syntax** `auth-web max-auth-fail <0-10>`  
`no auth-web max-auth-fail`

Parameter	Description
<code>&lt;0-10&gt;</code>	The maximum number of authentication failures allowed before login requests are refused.

**Default** The maximum number of authentication failures is set to 3.

**Mode** Interface Configuration for a static channel, a dynamic (LACP) channel group, or a switch port; or Authentication Profile mode.

**Examples** To set the lock count to 5 on interface port1.0.2, use the following commands:

```
awplus# configure terminal
awplus(config)# interface port1.0.2
awplus(config-if)# auth-web max-auth-fail 5
```

To set the lock count to the default on interface port1.0.2, use the following commands:

```
awplus# configure terminal
awplus(config)# interface port1.0.2
awplus(config-if)# no auth-web max-auth-fail
```

To set the lock count to 5 on authentication profile 'student', use the commands:

```
awplus# configure terminal
awplus(config)# auth profile student
awplus(config-auth-profile)# auth-web max-auth-fail 5
```

To set the lock count to the default on authentication profile 'student', use the commands:

```
awplus# configure terminal
awplus(config)# auth profile student
awplus(config-auth-profile)# no auth-web max-auth-fail
```

**Related commands**

- auth profile (global)
- auth timeout quiet-period
- show auth
- show auth interface
- show running-config

# auth-web method

**Overview** Use this command to set the web authentication access method that is used with RADIUS on the interface specified.

Use the **no** variant of this command to set the authentication method to PAP for the interface specified when web authentication is also used with the RADIUS authentication method.

**Syntax** `auth-web method { eap-md5 | pap }`  
`no auth-web method`

Parameter	Description
<code>eap-md5</code>	Enable EAP-MD5 as the authentication method.
<code>pap</code>	Enable PAP as the authentication method.

**Default** The web authentication method is set to PAP by default.

**Mode** Interface Configuration for a static channel, a dynamic (LACP) channel group, or a switch port; or Authentication Profile mode.

**Example** To set the web authentication method to EAP-MD5 on interface port1.0.2, use the following commands:

```
awplus# configure terminal
awplus(config)# interface port1.0.2
awplus(config-if)# auth-web method eap-md5
```

To set the web authentication method to EAP-MD5 for authentication profile 'student', use the commands:

```
awplus# configure terminal
awplus(config)# auth profile student
awplus(config-auth-profile)# auth-web method eap-md5
```

**Related commands** [auth profile \(global\)](#)

[show auth](#)

[show auth interface](#)

[show running-config](#)

# auth-web-server blocking-mode

**Overview** Use this command to enable blocking mode for the Web-Authentication server. The blocking mode displays an authentication success or failure screen immediately from the response result from a RADIUS server.

Use the **no** variant of this command to disable blocking mode for the Web-Authentication server.

**Syntax** `auth-web-server blocking-mode`  
`no auth-web-server blocking-mode`

**Default** By default, blocking mode is disabled for the Web-Authentication server.

**Mode** Global Configuration

**Example** To enable blocking mode for the Web-Authentication server, use the following commands:

```
awplus# configure terminal
awplus(config)# auth-web-server blocking-mode
```

To disable blocking mode for the Web-Authentication server, use the following commands:

```
awplus# configure terminal
awplus(config)# no auth-web-server blocking-mode
```

**Related commands** [auth-web-server redirect-delay-time](#)  
[show auth-web-server](#)  
[show running-config](#)

# auth-web-server dhcp ipaddress

**Overview** Use this command to assign an IP address and enable the DHCP service on the Web-Authentication server for supplicants (client devices).

Use the **no** variant of this command to remove an IP address and disable the DHCP service on the Web-Authentication server for supplicants.

**Syntax** `auth-web-server dhcp ipaddress <ip-address/prefix-length>`  
`no auth-web-server dhcp ipaddress`

Parameter	Description
<code>&lt;ip-addr/prefix-length&gt;</code>	The IPv4 address and prefix length assigned for the DHCP service on the Web-Authentication server for supplicants.

**Default** No IP address for the Web-Authentication server is set by default.

**Mode** Global Configuration

**Usage notes** See the [AAA and Port Authentication Feature Overview and Configuration Guide](#) for information about:

- using DHCP with web authentication, and
- restrictions regarding combinations of authentication enhancements working together

You cannot use the IPv4 address assigned to the device's interface as the Web-Authentication server address.

**Examples** To assign the IP address 10.0.0.1 to the Web-Authentication server, use the following commands:

```
awplus# configure terminal
awplus(config)# auth-web-server dhcp ipaddress 10.0.0.1/8
```

To remove an IP address on the Web-Authentication server, use the following commands:

```
awplus# configure terminal
awplus(config)# no auth-web-server dhcp ipaddress
```

**Related commands** [auth-web-server dhcp lease](#)  
[show auth-web-server](#)  
[show running-config](#)

# auth-web-server dhcp lease

**Overview** Use this command to set the DHCP lease time for supplicants (client devices) using the DHCP service on the Web-Authentication server.

Use the **no** variant of this command to reset to the default DHCP lease time for supplicants using the DHCP service on the Web-Authentication server.

**Syntax** `auth-web-server dhcp lease <20-60>`  
`no auth-web-server dhcp lease`

Parameter	Description
<20-60>	DHCP lease time for supplicants using the DHCP service on the Web-Authentication server in seconds.

**Default** The default DHCP lease time for supplicants using the DHCP service on the Web-Authentication server is set to 30 seconds.

**Mode** Global Configuration

**Usage notes** See the [AAA and Port Authentication Feature Overview and Configuration Guide](#) for information about:

- using DHCP with web authentication, and
- restrictions regarding combinations of authentication enhancements working together

**Examples** To set the DHCP lease time to 1 minute for supplicants using the DHCP service on the Web-Authentication server, use the following commands:

```
awplus# configure terminal
awplus(config)# auth-web-server dhcp lease 60
```

To reset the DHCP lease time to the default setting (30 seconds) for supplicants using the DHCP service on the Web-Authentication server, use the following commands:

```
awplus# configure terminal
awplus(config)# no auth-web-server dhcp lease
```

**Validation Commands** `show running-config`

**Related commands** `show auth-web-server`  
`auth-web-server dhcp ipaddress`

# auth-web-server dhcp-wpad-option

**Overview** This command sets the DHCP WPAD (Web Proxy Auto-Discovery) option for the Web-Authentication temporary DHCP service.

For more information and examples, see the “Web Auth Proxy” section in the [AlliedWare Plus Technical Tips and Tricks](#).

Use the **no** variant of this command to disable the DHCP WPAD function.

**Syntax** `auth-web-server dhcp wpad-option <url>`  
`no auth-web-server dhcp wpad-option`

Parameter	Description
<code>&lt;url&gt;</code>	URL to the server which gets a .pac file.

**Default** The Web-Authentication server DHCP WPAD option is not set.

**Mode** Global Configuration

**Usage notes** If the supplicant is configured to use WPAD, the supplicant’s web browser will use TCP port 80 as usual. Therefore, the packet can be intercepted by Web-Authentication as normal, and the Web-Authentication Login page can be sent. However, after authentication, the browser does not know where to get the WPAD file and so cannot access external web pages. The WPAD file is usually named proxy.pac file and tells the browser what web proxy to use.

Use this command to tell the supplicant where it can get this file from. The switch itself can be specified as the source for this file, and it can deliver it to the supplicant on request.

**Example** To specify that the proxy.pac file is found on the server at 192.168.1.100, use the following commands:

```
awplus# configure terminal
awplus(config)# auth-web-server dhcp wpad-option
http://192.168.1.100/proxy/proxy.pac
```

**Related commands** [show auth-web-server](#)

# auth-web-server host-name

**Overview** This command assigns a hostname to the web authentication server.  
Use the **no** variant of this command to remove the hostname from the web authentication server.

**Syntax** `auth-web-server host-name <hostname>`  
`no auth-web-server host-name`

Parameter	Description
<code>&lt;hostname&gt;</code>	URL string of the hostname

**Default** The web authentication server has no hostname.

**Mode** Global Configuration

**Usage notes** When the web authentication server uses HTTPS protocol, the web browser will validate the certificate. If the certificate is invalid, the web page gives a warning message before displaying server content. However, the web page will not give warning message if the server has a hostname same as the one stored in the installed certificate.

**Examples** To set the `auth.example.com` as the hostname of the web authentication server, use the commands:

```
awplus# configure terminal
awplus(config)# auth-web-server host-name auth.example.com
```

To remove hostname `auth.example.com` from the web authentication server, use the commands:

```
awplus# configure terminal
awplus(config)# no auth-web-server host-name
```

**Related commands** [aaa authentication auth-web](#)  
[auth-web enable](#)



# auth-web-server intercept-port

**Overview** This command specifies any additional TCP port numbers that the Web-Authentication server is to intercept.

Use the **no** variant of this command to stop intercepting the TCP port numbers.

**Syntax** `auth-web-server intercept-port {<1-65535>|any}`  
`no auth-web-server intercept-port {<1-65535>|any}`

Parameter	Description
<1-65535>	TCP port number.
any	Intercept all TCP packets

**Default** No additional TCP port numbers are intercepted by default.

**Mode** Global Configuration

**Usage notes** If this command is not specified, AlliedWare Plus Web-Authentication intercepts the supplicant's initial TCP port 80 connection to a web page and sends it the Web-Authentication Login page. However, if the supplicant is configured to use a web proxy, then it will usually be using TCP port 8080 (or another user configured port number). In this case Web-Authentication cannot intercept the connection.

To overcome this limitation you can use this command to tell the switch which additional port it should intercept, and then send the Web-Authentication Login page to the supplicant.

When the web authentication switch is in a guest network, the switch does not know the proxy server's port number in the supplicant's proxy setting. To overcome this limitation, you can use the **any** option in this command to intercept all TCP packets.

When you use this command in conjunction with a proxy server configured in the web browser, you must add the proxy server's network as a 'No Proxy' network. You can specify 'No Proxy' networks in the proxy settings in your web browser. For more information, see the "Web Auth Proxy" section in the [Alliedware Plus Technical Tips and Tricks](#).

**Example** To additionally intercept port number 3128, use the following commands:

```
awplus# configure terminal
awplus(config)# auth-web-server intercept-port 3128
```

**Related commands** [show auth-web-server](#)

# auth-web-server ipaddress

**Overview** This command sets the IP address for the Web-Authentication server.  
Use the **no** variant of this command to delete the IP address for the Web-Authentication server.  
You cannot use the IPv4 address assigned to the device's interface as the Web-Authentication server address.

**Syntax** `auth-web-server ipaddress <ip-address>`  
`no auth-web-server ipaddress`

Parameter	Description
<code>&lt;ip-address&gt;</code>	Web-Authentication server dotted decimal IP address in A.B.C.D format.

**Default** The Web-Authentication server address on the system is not set by default.

**Mode** Global Configuration

**Examples** To set the IP address 10.0.0.1 to the Web-Authentication server, use the following commands:

```
awplus# configure terminal
awplus(config)# auth-web-server ipaddress 10.0.0.1
```

To delete the IP address from the Web-Authentication server, use the following commands:

```
awplus# configure terminal
awplus(config)# no auth-web-server ipaddress
```

**Validation Commands** `show auth`  
`show auth-web-server`  
`show running-config`

# auth-web-server page language

**Overview** Use this command to set the presentation language of Web authentication pages. Titles and subtitles of Web authentication pages will be set accordingly. Note that presently only English or Japanese are offered.

Use the **no** variant of this command to set the presentation language of Web authentication pages to its default (English).

**Syntax** `auth-web-server page language {english|japanese}`  
`no auth-web-server page language`

Parameter	Description
english	Web authentication pages are presented in English.
japanese	Web authentication pages are presented in Japanese.

**Default** Web authentication pages are presented in English by default.

**Mode** Global Configuration

**Examples** To set Japanese as the presentation language of Web authentication pages, use the following commands:

```
awplus# configure terminal
awplus(config)# auth-web-server page language japanese
```

To set English as the presentation language of Web authentication pages, use the following commands:

```
awplus# configure terminal
awplus(config)# auth-web-server page language english
```

To unset the presentation language of Web authentication pages and use English as the default presentation language, use the following commands:

```
awplus# configure terminal
awplus(config)# no auth-web-server page language
```

**Related commands** [auth-web-server page title](#)  
[auth-web-server page sub-title](#)  
[show auth-web-server page](#)

# auth-web-server login-url

**Overview** This command sets the web-authentication login page URL. This lets you replace the login page with your own page. See “Customising the Login Page” in the [AAA and Port Authentication Feature Overview and Configuration Guide](#) for details.

Use the **no** variant of this command to delete the URL.

**Syntax** `auth-web-server login-url <URL>`  
`no auth-web-server login-url`

Parameter	Description
<URL>	Set login page URL

**Default** The built-in login page is set by default.

**Mode** Global Configuration

**Examples** To set `http://example.com/login.html` as the login page, use the commands:

```
awplus# configure terminal
awplus(config)# auth-web-server login-url
http://example.com/login.html
```

To unset the login page URL, use the commands:

```
awplus# configure terminal
awplus(config)# no auth-web-server login-url
```

**Related commands** [show running-config](#)

# auth-web-server page logo

**Overview** This command sets the type of logo that will be displayed on the web authentication page.

Use the **no** variant of this command to set the logo type to **auto**.

Note that if you need to customize the login page extensively, you can instead replace it with your own page. See “Customising the Login Page” in the [AAA and Port Authentication Feature Overview and Configuration Guide](#).

**Syntax** `auth-web-server page logo {auto|default|hidden}`  
`no auth-web-server page logo`

Parameter	Description
auto	Display the custom logo if installed; otherwise display the default logo
default	Display the default logo
hidden	Hide the logo

**Default** Logo type is **auto** by default.

**Mode** Global Configuration

**Examples** To display the default logo with ignoring installed custom logo, use the commands:

```
awplus# configure terminal
awplus(config)# auth-web-server page logo default
```

To set back to the default logo type **auto**, use the commands:

```
awplus# configure terminal
awplus(config)# no auth-web-server page logo
```

**Validation Commands** `show auth-web-server page`

# auth-web-server page sub-title

**Overview** This command sets the custom sub-title on the web authentication page.

Use the **no** variant of this command to reset the sub-title to its default.

Note that if you need to customize the login page extensively, you can instead replace it with your own page. See “Customising the Login Page” in the [AAA and Port Authentication Feature Overview and Configuration Guide](#).

**Syntax** `auth-web-server page sub-title {hidden|text <sub-title>}`  
`no auth-web-server page sub-title`

Parameter	Description
hidden	Hide the sub-title
<sub-title>	Text string of the sub-title

**Default** “Allied-Telesis” is displayed by default.

**Mode** Global Configuration

**Examples** To set the custom sub-title, use the commands:

```
awplus# configure terminal
awplus(config)# auth-web-server page sub-title text Web
Authentication
```

To hide the sub-title, use the commands:

```
awplus# configure terminal
awplus(config)# auth-web-server page sub-title hidden
```

To change back to the default title, use the commands:

```
awplus# configure terminal
awplus(config)# no auth-web-server page sub-title
```

**Validation Commands** `show auth-web-server page`

# auth-web-server page success-message

**Overview** This command sets the success message on the web-authentication page.

Use the **no** variant of this command to remove the success message.

Note that if you need to customize the login page extensively, you can instead replace it with your own page. See “Customising the Login Page” in the [AAA and Port Authentication Feature Overview and Configuration Guide](#).

**Syntax** `auth-web-server page success-message text <success-message>`  
`no auth-web-server page success-message`

Parameter	Description
<code>&lt;success-message&gt;</code>	Text string of the success message

**Default** No success message is set by default.

**Mode** Global Configuration

**Examples** To set the success message on the web-authentication page, use the commands:

```
awplus# configure terminal
awplus(config)# auth-web-server page success-message text Your
success message
```

To unset the success message on the web-authentication page, use the commands:

```
awplus# configure terminal
awplus(config)# no auth-web-server page success-message
```

**Validation Commands** `show auth-web-server page`

# auth-web-server page title

**Overview** This command sets the custom title on the web authentication page.

Use the **no** variant of this command to remove the custom title.

Note that if you need to customize the login page extensively, you can instead replace it with your own page. See “Customising the Login Page” in the [AAA and Port Authentication Feature Overview and Configuration Guide](#).

**Syntax** `auth-web-server page title {hidden|text <title>}`  
`no auth-web-server page title`

Parameter	Description
hidden	Hide the title
<title>	Text string of the title

**Default** “Web Access Authentication Gateway” is displayed by default.

**Mode** Global Configuration

**Examples** To set the custom title on the web authentication page, use the commands:

```
awplus# configure terminal
awplus(config)# auth-web-server page title text Login
```

To hide the title on the web authentication page, use the commands:

```
awplus# configure terminal
awplus(config)# auth-web-server page title hidden
```

To unset the custom title on the web authentication page, use the commands:

```
awplus# configure terminal
awplus(config)# no auth-web-server page title
```

**Validation Commands** `show auth-web-server page`



# auth-web-server page welcome-message

**Overview** This command sets the welcome message on the web-authentication login page.

Use the **no** variant of this command to remove the welcome message.

Note that if you need to customize the login page extensively, you can instead replace it with your own page. See “Customising the Login Page” in the [AAA and Port Authentication Feature Overview and Configuration Guide](#).

**Syntax** `auth-web-server page welcome-message text <welcome-message>`  
`no auth-web-server page welcome-message`

Parameter	Description
<code>&lt;welcome-message&gt;</code>	Text string of the welcome message

**Default** No welcome message is set by default.

**Mode** Global Configuration

**Examples** To set the welcome message on the web-authentication page, use the commands:

```
awplus# configure terminal
awplus(config)# auth-web-server page welcome-message text Your
welcome message
```

To remove the welcome message on the web-authentication page, use the commands:

```
awplus# configure terminal
awplus(config)# no auth-web-server page welcome-message
```

**Validation Commands** `show auth-web-server page`

# auth-web-server ping-poll enable

**Overview** This command enables the ping polling to the supplicant (client device) that is authenticated by Web-Authentication.

The **no** variant of this command disables the ping polling to the supplicant that is authenticated by Web-Authentication.

**Syntax** `auth-web-server ping-poll enable`  
`no auth-web-server ping-poll enable`

**Default** The ping polling feature for Web-Authentication is disabled by default.

**Mode** Global Configuration

**Examples** To enable the ping polling feature for Web-Authentication, use the following commands:

```
awplus# configure terminal
awplus(config)# auth-web-server ping-poll enable
```

To disable the ping polling feature for Web-Authentication, use the following commands:

```
awplus# configure terminal
awplus(config)# no auth-web-server ping-poll enable
```

**Validation  
Commands** `show auth`  
`show auth-web-server`  
`show running-config`

# auth-web-server ping-poll failcount

**Overview** This command sets a fail count for the ping polling feature when used with Web-Authentication. The **failcount** parameter specifies the number of unanswered pings. A supplicant (client device) is logged off when the number of unanswered pings are greater than the failcount set with this command.

Use the **no** variant of this command to resets the fail count for the ping polling feature to the default (5 pings).

**Syntax** `auth-web-server ping-poll failcount <1-100>`  
`no auth-web-server ping-poll failcount`

Parameter	Description
<1-100>	Count.

**Default** The default failcount for ping polling is 5 pings.

**Mode** Global Configuration

**Examples** To set the failcount of ping polling to 10 pings, use the following commands:

```
awplus# configure terminal
awplus(config)# auth-web-server ping-poll failcount 10
```

To set the failcount of ping polling to default, use the following commands:

```
awplus# configure terminal
awplus(config)# no auth-web-server ping-poll failcount
```

**Validation Commands** `show auth`  
`show auth-web-server`  
`show running-config`

# auth-web-server ping-poll interval

**Overview** This command is used to change the ping poll interval. The interval specifies the time period between pings when the supplicant (client device) is reachable.

Use the **no** variant of this command to reset to the default period for ping polling (30 seconds).

**Syntax** `auth-web-server ping-poll interval <1-65535>`  
`no auth-web-server ping-poll interval`

Parameter	Description
<1-65535>	Seconds.

**Default** The interval for ping polling is 30 seconds by default.

**Mode** Global Configuration

**Examples** To set the interval of ping polling to 60 seconds, use the following commands:

```
awplus# configure terminal
awplus(config)# auth-web-server ping-poll interval 60
```

To set the interval of ping polling to the default (30 seconds), use the following commands:

```
awplus# configure terminal
awplus(config)# no auth-web-server ping-poll interval
```

**Validation Commands** `show auth`  
`show auth-web-server`  
`show running-config`

# auth-web-server ping-poll reauth-timer-refresh

**Overview** This command modifies the **reauth-timer-refresh** parameter for the Web-Authentication feature. The **reauth-timer-refresh** parameter specifies whether a re-authentication timer is reset and when the response from a supplicant (a client device) is received.

Use the **no** variant of this command to reset the **reauth-timer-refresh** parameter to the default setting (disabled).

**Syntax** `auth-web-server ping-poll reauth-timer-refresh`  
`no auth-web-server ping-poll reauth-timer-refresh`

**Default** The `reauth-timer-refresh` parameter is disabled by default.

**Mode** Global Configuration

**Examples** To enable the `reauth-timer-refresh` timer, use the following commands:

```
awplus# configure terminal
awplus(config)# auth-web-server ping-poll reauth-timer-refresh
```

To disable the `reauth-timer-refresh` timer, use the following commands:

```
awplus# configure terminal
awplus(config)# no auth-web-server ping-poll
reauth-timer-refresh
```

**Validation  
Commands** `show auth`  
`show auth-web-server`  
`show running-config`

# auth-web-server ping-poll timeout

**Overview** This command modifies the ping poll **timeout** parameter for the Web-Authentication feature. The **timeout** parameter specifies the time in seconds to wait for a response to a ping packet.

Use the **no** variant of this command to reset the timeout of ping polling to the default (1 second).

**Syntax** `auth-web-server ping-poll timeout <1-30>`  
`no auth-web-server ping-poll timeout`

Parameter	Description
<1-30>	Seconds.

**Default** The default timeout for ping polling is 1 second.

**Mode** Global Configuration

**Examples** To set the timeout of ping polling to 2 seconds, use the command:

```
awplus# configure terminal  
awplus(config)# auth-web-server ping-poll timeout 2
```

To set the timeout of ping polling to the default (1 second), use the command:

```
awplus# configure terminal  
awplus(config)# no auth-web-server ping-poll timeout
```

**Validation Commands** `show auth`  
`show auth-web-server`  
`show running-config`

# auth-web-server port

**Overview** This command sets the HTTP port number for the Web-Authentication server. Use the **no** variant of this command to reset the HTTP port number to the default (80).

**Syntax** `auth-web-server port <port-number>`  
`no auth-web-server port`

Parameter	Description
<code>&lt;port-number&gt;</code>	Set the local Web-Authentication server port within the TCP port number range 1 to 65535.

**Default** The Web-Authentication server HTTP port number is set to 80 by default.

**Mode** Global Configuration

**Examples** To set the HTTP port number 8080 for the Web-Authentication server, use the following commands:

```
awplus# configure terminal
awplus(config)# auth-web-server port 8080
```

To reset to the default HTTP port number 80 for the Web-Authentication server, use the following commands:

```
awplus# configure terminal
awplus(config)# no auth-web-server port
```

**Validation Commands** `show auth`  
`show auth-web-server`  
`show running-config`

# auth-web-server redirect-delay-time

**Overview** Use this command to set the delay time in seconds before redirecting the supplicant to a specified URL when the supplicant is authorized.

Use the variant **no** to reset the delay time set previously.

**Syntax** `auth-web-server redirect-delay-time <5-60>`  
`no auth-web-server redirect-delay-time`

Parameter	Description
<code>redirect-delay-time</code>	Set the delay time before jumping to a specified URL after the supplicant is authorized.
<code>&lt;5-60&gt;</code>	The time in seconds.

**Default** The default redirect delay time is 5 seconds.

**Mode** Global Configuration

**Examples** To set the delay time to 60 seconds for the Web-Authentication server, use the following commands:

```
awplus# configure terminal  
awplus(config)# auth-web-server redirect-delay-time 60
```

To reset the delay time, use the following commands:

```
awplus# configure terminal  
awplus(config)# no auth-web-server redirect-delay-time
```

**Related commands** [auth-web-server blocking-mode](#)  
[auth-web-server redirect-url](#)  
[show auth-web-server](#)  
[show running-config](#)



# auth-web-server redirect-url

**Overview** This command sets a URL for supplicant (client device) authentication. When a supplicant is authorized it will be automatically redirected to the specified URL. Note that if the http redirect feature is used then this command is ignored.

Use the **no** variant of this command to delete the URL string set previously.

**Syntax** `auth-web-server redirect-url <url>`  
`no auth-web-server redirect-url`

Parameter	Description
<code>&lt;url&gt;</code>	URL (hostname or dotted IP notation).

**Default** The redirect URL for the Web-Authentication server feature is not set by default (null).

**Mode** Global Configuration

**Examples** To enable and set redirect a URL string `www.alliedtelesis.com` for the Web-Authentication server, use the following commands:

```
awplus# configure terminal
awplus(config)# auth-web-server redirect-url
http://www.alliedtelesis.com
```

To delete a redirect URL string, use the following commands:

```
awplus# configure terminal
awplus(config)# no auth-web-server redirect-url
```

**Related commands** [auth-web-server redirect-delay-time](#)  
[show auth](#)  
[show auth-web-server](#)  
[show running-config](#)

# auth-web-server session-keep

**Overview** This command enables the session-keep feature to jump to the original URL after being authorized by Web-Authentication.

Use the **no** variant of this command to disable the session keep feature.

**Syntax** `auth-web-server session-keep`  
`no auth-web-server session-keep`

**Default** The session-keep feature is disabled by default.

**Mode** Global Configuration

**Usage notes** This function doesn't ensure to keep session information in all cases. Authenticated supplicant may be redirected to unexpected page when session-keep is enabled. This issue occurred by supplicant sending HTTP packets automatically after authentication page is displayed and the URL is written.

**Examples** To enable the session-keep feature, use the following commands:

```
awplus# configure terminal
awplus(config)# auth-web-server session-keep
```

To disable the session-keep feature, use the following commands:

```
awplus# configure terminal
awplus(config)# no auth-web-server session-keep
```

**Validation Commands** `show auth`  
`show auth-web-server`  
`show running-config`

# auth-web-server ssl

**Overview** This command enables HTTPS functionality for the Web-Authentication server feature.

Use the **no** variant of this command to disable HTTPS functionality for the Web-Authentication server.

**Syntax** `auth-web-server ssl`  
`no auth-web-server ssl`

**Default** HTTPS functionality for the Web-Authentication server feature is disabled by default.

**Mode** Global Configuration

**Examples** To enable HTTPS functionality for the Web-Authentication server feature, use the following commands:

```
awplus# configure terminal
awplus(config)# auth-web-server ssl
```

To disable HTTPS functionality for the Web-Authentication server feature, use the following commands:

```
awplus# configure terminal
awplus(config)# no auth-web-server ssl
```

**Validation Commands** `show auth`  
`show auth-web-server`  
`show running-config`

# auth-web-server ssl intercept-port

**Overview** Use this command to register HTTPS intercept port numbers when the HTTPS server uses custom port number (not TCP port number 443).

Note that you need to use the **auth-web-server intercept-port** command to register HTTP intercept port numbers.

Use the **no** variant of this command to delete registered port number.

**Syntax** `auth-web-server ssl intercept-port <1-65535>`  
`no auth-web-server ssl intercept-port <1-65535>`

Parameter	Description
<code>&lt;1-65535&gt;</code>	TCP port number in the range from 1 through 65535

**Default** 443/TCP is registered by default.

**Mode** Global Configuration

**Examples** To register HTTPS port number 3128, use the commands:

```
awplus# configure terminal
awplus(config)# auth-web-server ssl intercept-port 3128
```

To delete HTTPS port number 3128, use the commands:

```
awplus# configure terminal
awplus(config)# no auth-web-server ssl intercept-port 3128
```

**Validation Commands** `show auth-web-server`

**Related commands** `auth-web-server intercept-port`

# copy proxy-autoconfig-file

**Overview** Use this command to download the proxy auto configuration (PAC) file to your switch. The Web-Authentication supplicant can get the downloaded file from the system web server.

**Syntax** `copy <filename> proxy-autoconfig-file`

Parameter	Description
<code>&lt;filename&gt;</code>	The URL of the PAC file.

**Mode** Privileged Exec

**Example** To download the PAC file to this device, use the command:

```
awplus# copy tftp://server/proxy.pac proxy-autoconfig-file
```

**Related commands** [show proxy-autoconfig-file](#)  
[erase proxy-autoconfig-file](#)

# copy web-auth-https-file

**Overview** Use this command to download the SSL server certificate for web-based authentication. The file must be in PEM (Privacy Enhanced Mail) format, and contain the private key and the server certificate.

**Syntax** `copy <filename> web-auth-https-file`

Parameter	Description
<code>&lt;filename&gt;</code>	The URL of the server certificate file.

**Mode** Privileged Exec

**Example** To download the server certificate file `verisign_cert.pem` from the TFTP server directory `server`, use the command:

```
awplus# copy tftp://server/verisign_cert.pem  
web-auth-https-file
```

**Related commands**

- [auth-web-server ssl](#)
- [erase web-auth-https-file](#)
- [show auth-web-server](#)

# description (auth-profile)

**Overview** Use this command to add a description to an authentication profile in Authentication Profile mode.  
Use the **no** variant of this command to remove the current description.

**Syntax** `description <description>`

Parameter	Description
<code>&lt;description&gt;</code>	Text describing the selected authentication profile.

**Default** No description configured by default.

**Mode** Authentication Profile

**Example** To add a description to the authentication profile 'student', use the following commands:

```
awplus# configure terminal
awplus(config)# auth profile student
awplus(config-auth-profile)# description student room setting
```

To remove a description from the authentication profile 'student', use the following commands:

```
awplus# configure terminal
awplus(config)# auth profile student
awplus(config-auth-profile)# no description
```

**Related commands** [auth profile \(global\)](#)

# erase proxy-autoconfig-file

**Overview** Use this command to remove the proxy auto configuration file.

**Syntax** `erase proxy-autoconfig-file`

**Mode** Privileged Exec

**Example** To remove the proxy auto configuration file, use the command:

```
awplus# erase proxy-autoconfig-file
```

**Related commands** [show proxy-autoconfig-file](#)  
[copy proxy-autoconfig-file](#)



# erase web-auth-https-file

**Overview** Use this command to remove the SSL server certificate for web-based authentication.

**Syntax** `erase web-auth-https-file`

**Mode** Privileged Exec

**Example** To remove the SSL server certificate file for web-based authentication use the command:

```
awplus# erase web-auth-https-file
```

**Related commands**

- [auth-web-server ssl](#)
- [copy web-auth-https-file](#)
- [show auth-web-server](#)

# platform l3-vlan-hashing-algorithm

**Overview** This command enables you to change the L3 VLAN hash-key-generating algorithm.

The **no** variant of this command returns the hash-key algorithm to the default of `crc32l`.

**Syntax** `platform l3-vlan-hashing-algorithm`  
`{crc16l|crc16u|crc32l|crc32u}`  
`no platform l3-vlan-hashing-algorithm`

Parameter	Description
<code>crc16l</code>	The algorithm that will apply to the lower bits of CRC-16
<code>crc16u</code>	The algorithm that will apply to the upper bits of CRC-16
<code>crc32l</code>	The algorithm that will apply to the lower bits of CRC-32
<code>crc32u</code>	The algorithm that will apply to the upper bits of CRC-32

**Default** The hash-key algorithm is `crc32l` by default.

**Mode** Global configuration

**Usage notes** Occasionally, when using the Multiple Dynamic VLAN feature, a supplicant cannot be authenticated because a collision occurs within the VLAN L3 table. This can happen when more than four different IP addresses produce the same hash-key.

When this situation occurs, collisions can sometimes be avoided by changing the hashing algorithm from its default of `crc32l`. Several different algorithms may need to be tried to rectify the problem.

You must restart the switch for this command to take effect.

Note that this command is intended for technical support staff, or advanced end users.

**Example** To change the hash-key generating algorithm applying to the lower bits of CRC-16, use the command:

```
awplus# configure terminal
awplus(config)# platform l3-vlan-hashing-algorithm crc16l
```

**Related commands** [platform mac-vlan-hashing-algorithm](#)  
[show platform](#)

# platform mac-vlan-hashing-algorithm

**Overview** This command enables you to change the MAC VLAN hash-key-generating algorithm.

The **no** variant of this command returns the hash-key algorithm to the default of `crc32l`.

**Syntax** `platform mac-vlan-hashing-algorithm`  
`{crc16l | crc16u | crc32l | crc32u}`  
`no platform mac-vlan-hashing-algorithm`

Parameter	Description
<code>crc16l</code>	The algorithm that will apply to the lower bits of CRC-16
<code>crc16u</code>	The algorithm that will apply to the upper bits of CRC-16
<code>crc32l</code>	The algorithm that will apply to the lower bits of CRC-32
<code>crc32u</code>	The algorithm that will apply to the upper bits of CRC-32

**Default** The hash-key algorithm is `crc32l` by default.

**Mode** Global configuration

**Usage notes** Occasionally, when using the Multiple Dynamic VLAN feature, a supplicant cannot be authenticated because a collision occurs within the VLAN MAC table. This can happen when more than four different MAC addresses produce the same hash-key.

When this situation occurs, collisions can sometimes be avoided by changing the hashing algorithm from its default of `crc32l`. Several different algorithms may need to be tried to rectify the problem.

You must restart the switch for this command to take effect.

Note that this command is intended for technical support staff, or advanced end users.

**Example** To change the hash-key generating algorithm applying to the lower bits of CRC-16, use the command:

```
awplus# configure terminal
awplus(config)# platform mac-vlan-hashing-algorithm crc16l
```

**Related commands** [platform l3-vlan-hashing-algorithm](#)  
[show platform](#)

# show auth

**Overview** This command shows the configuration state of authentication.

**Syntax** show auth [all]

Parameter	Description
all	Display all authentication information for each authenticated interface. This can be a static channel (or static aggregator), or a dynamic (or LACP) channel group, or a switch port.

**Mode** Privileged Exec

**Example** To display all authentication information, enter the command:

```
awplus# show auth all
```

**Output** Figure 31-1: Example output from the **show auth** command

```
awplus# show auth all
802.1X Port-Based Authentication Enabled
MAC-based Port Authentication Disabled
WEB-based Port Authentication Enabled
  RADIUS server address (auth): 150.87.17.192:1812
  Last radius message id: 4
Authentication Info for interface port1.0.1
  portEnabled: true - portControl: Auto
  portStatus: Authorized
  reAuthenticate: disabled
  reAuthPeriod: 3600
  PAE: quietPeriod: 60 - maxReauthReq: 2 - txPeriod: 30
  BE: suppTimeout: 30 - serverTimeout: 30
  CD: adminControlledDirections: in
  KT: keyTxEnabled: false
  critical: disabled
  guestVlan: disabled
  authFailVlan: disabled
  dynamicVlanCreation: disabled
  multiVlanCreation: disabled
  hostMode: single-host
  dot1x: enabled
    protocolVersion: 1
  authMac: disabled
  authWeb: enabled
    method: PAP
    maxAuthFail: 3
  packetForwarding:
    10.0.0.1 80/tcp
    dns
    dhcp
```

```
twoStepAuthentication:
  configured: enabled
  actual: enabled
supplicantMac: none
Supplicant name: oha
Supplicant address: 000d.6013.5398
  authenticationMethod: WEB-based Authentication
Two-Step Authentication:
  firstAuthentication: Pass - Method: dot1x
  secondAuthentication: Pass - Method: web
portStatus: Authorized - currentId: 3
abort:F fail:F start:F timeout:F success:T
PAE: state: Authenticated - portMode: Auto
PAE: reAuthCount: 0 - rxRespId: 0
PAE: quietPeriod: 60 - maxReauthReq: 2
BE: state: Idle - reqCount: 0 - idFromServer: 2
CD: adminControlledDirections: in - operControlledDirections: in
CD: bridgeDetected: false
KR: rxKey: false
KT: keyAvailable: false - keyTxEnabled: false
```

**Related** [show dot1x](#)  
**commands**

# show auth diagnostics

**Overview** This command shows authentication diagnostics, optionally for the specified interface, which may be a static channel (or static aggregator) or a dynamic (or LACP) channel group or a switch port.

If no interface is specified then authentication diagnostics are shown for all interfaces.

**Syntax** `show auth diagnostics [interface <interface-list>]`

Parameter	Description
<code>interface</code>	Specify ports to show.
<code>&lt;interface-list&gt;</code>	The interfaces or ports to configure. An interface-list can be: <ul style="list-style-type: none"><li>• an interface (e.g. <code>vlan2</code>), a switch port (e.g. <code>port1.0.6</code>), a static channel group (e.g. <code>sa2</code>) or a dynamic (LACP) channel group (e.g. <code>po2</code>)</li><li>• a continuous range of interfaces, ports, static channel groups or dynamic (LACP) channel groups separated by a hyphen; e.g. <code>vlan2-8</code>, or <code>port1.0.1-1.0.4</code>, or <code>sa1-2</code>, or <code>po1-2</code></li><li>• a comma-separated list of the above; e.g. <code>port1.0.1, port1.0.4-1.0.6</code>. Do not mix interface types in a list</li></ul> The specified interfaces must exist.

**Mode** Privileged Exec

**Example** To display authentication diagnostics for port1.0.6, enter the command:

```
awplus# show auth diagnostics interface port1.0.6
```

**Output** Figure 31-2: Example output from the **show auth diagnostics** command

```
Authentication Diagnostics for interface port1.0.6
  Supplicant address: 00d0.59ab.7037
  authEnterConnecting: 2
  authEaplogoffWhileConnecting: 1
  authEnterAuthenticating: 2
  authSuccessWhileAuthenticating: 1
  authTimeoutWhileAuthenticating: 1
  authFailWhileAuthenticating: 0
  authEapstartWhileAuthenticating: 0
  authEaplogoggWhileAuthenticating: 0
  authReauthsWhileAuthenticated: 0
  authEapstartWhileAuthenticated: 0
  authEaplogoffWhileAuthenticated: 0
  BackendResponses: 2
  BackendAccessChallenges: 1
  BackendOtherrequestToSupplicant: 3
  BackendAuthSuccess: 1
```

**Related commands** [show dot1x interface](#)

# show auth interface

**Overview** This command shows the status of port authentication on the specified interface.

**Syntax** `show auth interface <interface-list>`

Parameter	Description
<code>&lt;interface-list&gt;</code>	The interfaces to display information about. An interface-list can be: <ul style="list-style-type: none"><li>• a VLAN (e.g. vlan2)</li><li>• a switchport (e.g. port1.0.4)</li><li>• a static channel group (e.g. sa2)</li><li>• a dynamic (LACP) channel group (e.g. po2)</li><li>• a continuous range of interfaces separated by a hyphen (e.g. port1.0.1-port1.0.3)</li><li>• a comma-separated list (e.g. port1.0.1, port1.0.3-port1.0.4). Do not mix interface types in a list.</li></ul>

**Mode** Privileged Exec

**Example** To display the Web based authentication status for port1.0.4, enter the command:

```
awplus# show auth interface port1.0.4
```

If web-based authentication is not configured, the output will be

```
% Port-Control not configured on port1.0.4
```

To display the Web based authentication status for port1.0.4, enter the command:

```
awplus# show auth interface port1.0.4
```



```
awplus# show auth interface port1.0.4
Authentication Info for interface port1.0.4
portEnabled: true - portControl: Auto
portStatus: Authorized
reAuthenticate: disabled
reAuthPeriod: 3600
PAE: quietPeriod: 60 - maxReauthReq: 2 - txPeriod: 30
BE: suppTimeout: 30 - serverTimeout: 30
CD: adminControlledDirections: in
KT: keyTxEnabled: false
critical: disabled
guestVlan: disabled
guestVlanForwarding:none
authFailVlan: disabled
dynamicVlanCreation: disabled
multiVlanCreation: disabled
hostMode: single-host
dot1x: enabled
    protocolVersion: 1
authMac: disabled
authWeb: enabled
    method: PAP
    maxAuthFail: 3
    packetForwarding:
        10.0.0.1 80/tcp
        dns
        dhcp
twoStepAuthentication:
    configured: enabled
    actual: enabled
supplicantMac: none
```

**Related commands**

- [show auth diagnostics](#)
- [show dot1x sessionstatistics](#)
- [show dot1x statistics interface](#)
- [show dot1x supplicant interface](#)

# show auth sessionstatistics

**Overview** This command shows authentication session statistics for the specified interface, which may be a static channel (or static aggregator) or a dynamic (or LACP) channel group or a switch port.

**Syntax** `show auth sessionstatistics [interface <interface-list>]`

Parameter	Description
<code>interface</code>	Specify ports to show.
<code>&lt;interface-list&gt;</code>	The interfaces or ports to configure. An interface-list can be: <ul style="list-style-type: none"><li>• an interface (e.g. <code>vlan2</code>), a switch port (e.g. <code>port1.0.6</code>), a static channel group (e.g. <code>sa2</code>) or a dynamic (LACP) channel group (e.g. <code>po2</code>)</li><li>• a continuous range of interfaces, ports, static channel groups or dynamic (LACP) channel groups separated by a hyphen; e.g. <code>vlan2-8</code>, or <code>port1.0.1-1.0.4</code>, or <code>sa1-2</code>, or <code>po1-2</code></li><li>• a comma-separated list of the above; e.g. <code>port1.0.1,port1.0.4-1.0.6</code>. Do not mix interface types in a list</li></ul> The specified interfaces must exist.

**Mode** Privileged Exec

**Example** To display authentication statistics for port1.0.6, enter the command:

```
awplus# show auth sessionstatistics interface port1.0.6
```

**Output** Figure 31-3: Example output from the **show auth sessionstatistics** command

```
Authentication session statistics for interface port1.0.6
  session user name: manager
    session authentication method: Remote server
    session time: 19440 secs
    session terminat cause: Not terminated yet
```

# show auth statistics interface

**Overview** Use this command to show the authentication statistics for the specified interface.

**Syntax** `show auth statistics interface <interface-list>`

Parameter	Description
<code>&lt;interface-list&gt;</code>	The interfaces to display information about. An interface-list can be: <ul style="list-style-type: none"><li>• a VLAN (e.g. vlan2)</li><li>• a switchport (e.g. port1.0.4)</li><li>• a static channel group (e.g. sa2)</li><li>• a dynamic (LACP) channel group (e.g. po2)</li><li>• a continuous range of interfaces separated by a hyphen (e.g. port1.0.1-port1.0.3)</li><li>• a comma-separated list (e.g. port1.0.1, port1.0.3-port1.0.4). Do not mix interface types in a list.</li></ul>

**Mode** Privileged Exec

**Example** To display authentication statistics for port1.0.2, enter the command:

```
awplus# show auth statistics interface port1.0.2
```

**Output** Figure 31-4: Example output from **show auth statistics interface** for a port

```
awplus# show auth statistics interface port1.0.2
802.1X statistics for interface port1.0.2
  EAPOL Frames Rx: 5 - EAPOL Frames Tx: 16
  EAPOL Start Frames Rx: 0 - EAPOL Logoff Frames Rx: 0
  EAP Rsp/Id Frames Rx: 3 - EAP Response Frames Rx: 2
  EAP Req/Id Frames Tx: 8 - EAP Request Frames Tx: 2
  Invalid EAPOL Frames Rx: 0 - EAP Length Error Frames Rx: 0
  EAPOL Last Frame Version Rx: 1 - EAPOL Last Frame
Src:00d0.59ab.7037
```

**Related commands** [show dot1x interface](#)

# show auth supplicant

**Overview** Use this command to show the supplicant (client device) state when authentication is configured for the switch. Use the optional **brief** parameter to show a summary of the supplicant state.

**Syntax** show auth supplicant [*<macadd>*] [brief]

Parameter	Description
<i>&lt;macadd&gt;</i>	Mac (hardware) address of the supplicant. Entry format is HHHH.HHHH.HHHH (hexadecimal).
brief	Brief summary of the supplicant state.

**Mode** Privileged Exec

**Examples** To display a summary of authenticated supplicant information on the device, enter the command:

```
awplus# show auth supplicant brief
```

To display authenticated supplicant information on the device, enter the command:

```
awplus# show auth supplicant
```

To display authenticated supplicant information for device with MAC address 0000.5E00.5301, enter the command:

```
awplus# show auth supplicant 0000.5E00.5301
```

**Output** Figure 31-5: Example output from **show auth supplicant brief**

```
awplus#show auth supplicant brief
Interface port1.0.3
  authenticationMethod: dot1x/mac/web
  Two-Step Authentication
    firstMethod: mac
    secondMethod: dot1x/web
  totalSupplicantNum: 1
  authorizedSupplicantNum: 1
    macBasedAuthenticationSupplicantNum: 0
    dot1xAuthenticationSupplicantNum: 0
    webBasedAuthenticationSupplicantNum: 1
    otherAuthenticationSupplicantNum: 0RADIUS Group Configuration

Interface  VID  Mode  MAC Address      Status              IP Address          Username
-----  ---  ---  -----  -----  -----
port1.0.3  1    W     001c.233e.e15a  Authenticated      192.168.1.181      test
```

Figure 31-6: Example output from **show auth supplicant**

```
awplus#show auth supplicant
Interface port1.0.3
  authenticationMethod: dot1x/mac/web
  Two-Step Authentication
    firstMethod: mac
    secondMethod: dot1x/web
  totalSupplicantNum: 1
  authorizedSupplicantNum: 1
    macBasedAuthenticationSupplicantNum: 0
    dot1xAuthenticationSupplicantNum: 0
    webBasedAuthenticationSupplicantNum: 1
    otherAuthenticationSupplicantNum: 0

  Supplicant name: test
  Supplicant address: 0000.5E00.5301
    authenticationMethod: WEB-based Authentication
    Two-Step Authentication:
      firstAuthentication: Pass - Method: mac
      secondAuthentication: Pass - Method: web
    portStatus: Authorized - currentId: 1
    abort:F fail:F start:F timeout:F success:T
    PAE: state: Authenticated - portMode: Auto
    PAE: reAuthCount: 0 - rxRespId: 0
    PAE: quietPeriod: 60 - maxReauthReq: 2
    BE: state: Idle - reqCount: 0 - idFromServer: 0
    CD: adminControlledDirections: in - operControlledDirections: in
    CD: bridgeDetected: false
    KR: rxKey: false
    KT: keyAvailable: false - keyTxEnabled: false
    RADIUS server group (auth): radius
    RADIUS server (auth): 192.168.1.40
```

Figure 31-7: Example output from **show auth supplicant 0000.5E00.5301**

```
awplus#show auth supplicant 0000.5E00.5301
Interface port1.0.3
  Supplicant name: test
  Supplicant address: 0000.5E00.5301
    authenticationMethod: WEB-based Authentication
    Two-Step Authentication:
      firstAuthentication: Pass - Method: mac
      secondAuthentication: Pass - Method: web
    portStatus: Authorized - currentId: 1
    abort:F fail:F start:F timeout:F success:T
    PAE: state: Authenticated - portMode: Auto
    PAE: reAuthCount: 0 - rxRespId: 0
    PAE: quietPeriod: 60 - maxReauthReq: 2
    BE: state: Idle - reqCount: 0 - idFromServer: 0
    CD: adminControlledDirections: in - operControlledDirections: in
    CD: bridgeDetected: false
    KR: rxKey: false
    KT: keyAvailable: false - keyTxEnabled: false
    RADIUS server group (auth): radius
    RADIUS server (auth): 192.168.1.40
```

**Related  
commands**

aaa accounting auth-mac  
aaa accounting auth-web  
aaa accounting dot1x  
aaa authentication auth-mac  
aaa authentication auth-web  
aaa authentication dot1x

# show auth supplicant interface

**Overview** This command shows the supplicant (client device) state for the authentication mode set for the interface. Use the optional **brief** parameter to show a summary of the supplicant state.

**Syntax** `show auth-web supplicant interface <interface-list> [brief]`

Parameter	Description
<code>&lt;interface-list&gt;</code>	The interfaces or ports to configure. An interface-list can be: <ul style="list-style-type: none"><li>• an interface (e.g. <code>vlan2</code>), a switch port (e.g. <code>port1.0.6</code>), a static channel group (e.g. <code>sa2</code>) or a dynamic (LACP) channel group (e.g. <code>po2</code>)</li><li>• a continuous range of interfaces, ports, static channel groups or dynamic (LACP) channel groups separated by a hyphen; e.g. <code>vlan2-8</code>, or <code>port1.0.1-1.0.4</code>, or <code>sa1-2</code>, or <code>po1-2</code></li><li>• a comma-separated list of the above; e.g. <code>port1.0.1, port1.0.4-1.0.6</code>. Do not mix interface types in a list</li></ul> The specified interfaces must exist.
<code>brief</code>	Brief summary of the supplicant state.

**Mode** Privileged Exec

**Examples** To display the authenticated supplicant on the interface `port1.0.2`, enter the command:

```
awplus# show auth supplicant interface port1.0.2
```

To display brief summary output for the authenticated supplicant on the interface `port1.0.2`, enter the command:

```
awplus# show auth supplicant interface port1.0.2 brief
```

# show auth two-step supplicant brief

**Overview** This command displays the supplicant state of the two-step authentication feature on the interface.

**Syntax** show auth two-step supplicant [interface <interface-list>]  
brief

Parameter	Description
interface	The interface selected for display.
<interface-list>	The interfaces to display information about. An interface-list can be: <ul style="list-style-type: none"><li>• a VLAN (e.g. vlan2)</li><li>• a switchport (e.g. port1.0.4)</li><li>• a static channel group (e.g. sa2)</li><li>• a dynamic (LACP) channel group (e.g. po2)</li><li>• a continuous range of interfaces separated by a hyphen (e.g. port1.0.1-port1.0.3)</li><li>• a comma-separated list (e.g. port1.0.1, port1.0.3-port1.0.4). Do not mix interface types in a list.</li></ul>

**Mode** Privileged Exec

**Usage notes** Do not mix interface types in a list. The specified interfaces must exist.

**Example** To display the supplicant state of the two-step authentication feature, enter the command:

```
awplus# show two-step supplicant interface port1.0.2 brief
```

**Output** Figure 31-8: Example output from **show auth two-step supplicant brief**

```
interface port1.0.2

authenticationMethod: dot1x/mac

Two-Step Authentication:
  firstMethod:mac
  secondMethod:dot1x
totalSupplicantNum: 1
authorizedSupplicantNum: 1
  macBasedAuthenticationSupplicantNum: 0
  dot1xAuthenticationSupplicantNum: 1
  webBasedAuthenticationSupplicantNum: 0
  otherAuthenticationSupplicantNum: 0

Interface  VID Mode  MAC Address      Status           FirstStep        SecondStep
=====  ===  =====  =====
port1.0.8  1    D        000b..db67.00f7  Authenticated   Pass             Pass
```



**Related commands** [auth two-step enable](#)

**Command changes** Version 5.4.9-2.1: command added to AR2050V, AR3050S, and AR4050S

# show auth-web-server

**Overview** This command shows the Web-Authentication server configuration and status on the switch.

**Syntax** show auth-web-server

**Mode** Privileged Exec

**Example** To display Web-Authentication server configuration and status, enter the command:

```
awplus# show auth-web-server
```

**Output** Figure 31-9: Example output from the **show auth-web-server** command

```
Web authentication server
  Server status: enabled
  Server mode: none
  Server address: 192.168.1.1/24
    DHCP server enabled
    DHCP lease time: 20
    DHCP WPAD Option URL: http://192.168.1.1/proxy.pac
  HTTP Port No: 80
  Security: disabled
  Certification: default
  SSL Port No: 443
  Redirect URL: --
  Redirect Delay Time: 5
  HTTP Redirect: enabled
  Session keep: disabled
  PingPolling: disabled
  PingInterval: 30
  Timeout: 1
  FailCount: 5
  ReauthTimerReFresh: disabled
```

**Related commands**

- [auth-web-server ipaddress](#)
- [auth-web-server port](#)
- [auth-web-server redirect-delay-time](#)
- [auth-web-server redirect-url](#)
- [auth-web-server session-keep](#)
- [auth-web-server ssl](#)

# show auth-web-server page

**Overview** This command displays the web-authentication page configuration and status.

**Syntax** show auth-web-server page

**Mode** Privileged Exec

**Examples** To show the web-authentication page information, use the command:

```
awplus# show auth-web-server page
```

Figure 31-10: Example output from the **show auth-web-server page** command

```
awplus#show auth-web-server page
Web authentication page
  Logo: auto
  Title: default
  Sub-Title: Web Authentication
  Welcome message: Your welcome message
  Success message: Your success message
```

**Related  
commands**

[auth-web forward](#)

[auth-web-server page logo](#)

[auth-web-server page sub-title](#)

[auth-web-server page success-message](#)

[auth-web-server page title](#)

[auth-web-server page welcome-message](#)

# show proxy-autoconfig-file

**Overview** This command displays the contents of the proxy auto configuration (PAC) file.

**Syntax** show proxy-autoconfig-file

**Mode** Privileged Exec

**Example** To display the contents of the proxy auto configuration (PAC) file, enter the command:

```
awplus# show auth proxy-autoconfig-file
```

**Output** Figure 31-11: Example output from **show proxy-autoconfig-file**

```
function FindProxyForURL(url,host)
{
  if (isPlainHostName(host) ||
      isInNet(host, "192.168.1.0", "255.255.255.0")) {
    return "DIRECT";
  }
  else {
    return "PROXY 192.168.110.1:8080";
  }
}
```

**Related commands** [copy proxy-autoconfig-file](#)  
[erase proxy-autoconfig-file](#)

# 32

# AAA Commands

## Introduction

**Overview** AAA is the collective title for the three related functions of Authentication, Authorization and Accounting. These function can be applied in a variety of methods with a variety of servers.

The purpose of the AAA commands is to map instances of the AAA functions to sets of servers. The Authentication function can be performed in multiple contexts, such as authentication of users logging in at a console, or 802.1X-Authentication of devices connecting to Ethernet ports.

For each of these contexts, you may want to use different sets of servers for examining the proffered authentication credentials and deciding if they are valid. AAA Authentication commands enable you to specify which servers will be used for different types of authentication.

This chapter provides an alphabetical reference for AAA commands for Authentication, Authorization and Accounting. For more information, see the [AAA and Port\\_Authentication Feature Overview and Configuration Guide](#).

- Command List**
- [“aaa accounting auth-mac”](#) on page 1191
  - [“aaa accounting auth-web”](#) on page 1193
  - [“aaa accounting commands”](#) on page 1195
  - [“aaa accounting dot1x”](#) on page 1197
  - [“aaa accounting login”](#) on page 1199
  - [“aaa accounting update”](#) on page 1202
  - [“aaa authentication auth-mac”](#) on page 1204
  - [“aaa authentication auth-web”](#) on page 1206
  - [“aaa authentication dot1x”](#) on page 1208
  - [“aaa authentication enable default group tacacs+”](#) on page 1210
  - [“aaa authentication enable default local”](#) on page 1212

- [“aaa authentication login”](#) on page 1213
- [“aaa authorization commands”](#) on page 1215
- [“aaa authorization config-commands”](#) on page 1217
- [“aaa group server”](#) on page 1218
- [“aaa local authentication attempts lockout-time”](#) on page 1220
- [“aaa local authentication attempts max-fail”](#) on page 1221
- [“aaa login fail-delay”](#) on page 1222
- [“accounting login”](#) on page 1223
- [“authorization commands”](#) on page 1224
- [“clear aaa local user lockout”](#) on page 1226
- [“debug aaa”](#) on page 1227
- [“login authentication”](#) on page 1228
- [“proxy-port”](#) on page 1229
- [“radius-secure-proxy aaa”](#) on page 1230
- [“server \(radsecproxy-aaa\)”](#) on page 1231
- [“server mutual-authentication”](#) on page 1233
- [“server name-check”](#) on page 1234
- [“server trustpoint”](#) on page 1235
- [“show aaa local user locked”](#) on page 1237
- [“show aaa server group”](#) on page 1238
- [“show debugging aaa”](#) on page 1239
- [“show radius server group”](#) on page 1240
- [“undebug aaa”](#) on page 1242

# aaa accounting auth-mac

**Overview** This command configures an accounting method list for MAC-based authentication. An accounting method list specifies what type of accounting messages are sent and which RADIUS servers the accounting messages are sent to. Use this command to configure either the default method list, which is automatically applied to interfaces with MAC-based authentication enabled, or a named method list, which can be applied to an interface with the [auth-mac accounting](#) command.

Use the **no** variant of this command to disable either the default or a named accounting method list for MAC-based authentication. Once all method lists are disabled, AAA accounting for MAC-based authentication is disabled globally.

**Syntax**

```
aaa accounting auth-mac {default | <list-name>}  
{start-stop | stop-only | none} group {<group-name> | radius}  
no aaa accounting auth-mac {default | <list-name>}
```

Parameter	Description
default	Configure the default accounting method list
<list-name>	Configure a named accounting method list
start-stop	Sends a start accounting message at the beginning of the session and a stop accounting message at the end of the session.
stop-only	Only sends a stop accounting message at the end of the session.
none	No accounting record sent.
group	Use a server group
<group-name>	Server group name.
radius	Use all RADIUS servers.

**Default** RADIUS accounting for MAC-based Authentication is disabled by default

**Mode** Global Configuration

**Usage notes** This command can be used to configure either the default accounting method list or a named accounting method list:

- **default:** the default accounting method list which is automatically applied to all interfaces with MAC-based authentication enabled.
- **<list-name>:** a user named list which can be applied to an interface using the [auth-mac accounting](#) command.

There are two ways to define servers where RADIUS accounting messages are sent:

- **group radius:** use all RADIUS servers configured by [radius-server host](#) command

- **group** <group-name>: use the specified RADIUS server group configured with the [aaa group server](#) command

The accounting event to send to the RADIUS server is configured with the following options:

- **start-stop**: sends a **start** accounting message at the beginning of a session and a **stop** accounting message at the end of the session.
- **stop-only**: sends a **stop** accounting message at the end of a session.
- **none**: disables accounting.

**Examples** To enable the default RADIUS accounting for MAC-based authentication, and use all available RADIUS servers, use the commands:

```
awplus# configure terminal
awplus(config)# aaa accounting auth-mac default start-stop
group radius
```

To disable RADIUS accounting for MAC-based Authentication, use the commands:

```
awplus# configure terminal
awplus(config)# no aaa accounting auth-mac default
```

To enable a named RADIUS accounting method list 'vlan10\_acct' for MAC-based authentication, with the RADIUS server group 'rad\_group\_vlan10', use the commands:

```
awplus# configure terminal
awplus(config)# aaa accounting auth-mac vlan10_acct start-stop
group rad_group_vlan10
```

To disable a named RADIUS accounting method list 'vlan10\_acct' for MAC-based authentication, use the commands:

```
awplus# configure terminal
awplus(config)# no aaa accounting auth-mac vlan10_acct
```

**Related commands**

- [aaa authentication auth-mac](#)
- [aaa group server](#)
- [auth-mac accounting](#)
- [auth-mac enable](#)
- [radius-server host](#)
- [show aaa server group](#)



# aaa accounting auth-web

**Overview** This command configures an accounting method list for Web-based authentication. An accounting method list specifies what type of accounting messages are sent and which RADIUS servers the accounting messages are sent to. Use this command to configure either the default method list, which is automatically applied to interfaces with Web-based authentication enabled, or a named method list, which can be applied to an interface with the [auth-web accounting](#) command.

Use the **no** variant of this command to disable either the default or a named accounting method list for Web-based authentication. Once all method lists are disabled, AAA accounting for Web-based authentication is disabled globally.

**Syntax**

```
aaa accounting auth-web {default | <list-name>}  
{start-stop | stop-only | none} group {<group-name> | radius}  
no aaa accounting auth-web {default | <list-name>}
```

Parameter	Description
default	Configure the default accounting method list
<list-name>	Configure a named accounting method list
start-stop	Sends a start accounting message at the beginning of the session and a stop accounting message at the end of the session.
stop-only	Only sends a stop accounting message at the end of the session.
none	No accounting record sent.
group	Use a server group
<group-name>	Server group name.
radius	Use all RADIUS servers.

**Default** RADIUS accounting for Web-based authentication is disabled by default.

**Mode** Global Configuration

**Usage notes** This command can be used to configure either the default accounting method list or a named accounting method list:

- **default:** the default accounting method list which is automatically applied to all interfaces with Web-based authentication enabled.
- **<list-name>:** a user named list which can be applied to an interface using the [auth-web accounting](#) command.

There are two ways to define servers where RADIUS accounting messages are sent:

- **group radius:** use all RADIUS servers configured by [radius-server host](#) command

- **group** <group-name>: use the specified RADIUS server group configured with the `aaa group server` command

Configure the accounting event to be sent to the RADIUS server with the following options:

- **start-stop**: sends a start accounting message at the beginning of a session and a stop accounting message at the end of the session.
- **stop-only**: sends a stop accounting message at the end of a session.
- **none**: disables accounting.

**Examples** To enable the default RADIUS accounting method for Web-based authentication, and use all available RADIUS servers, use the commands:

```
awplus# configure terminal
awplus(config)# aaa accounting auth-web default start-stop
group radius
```

To disable the default RADIUS accounting method for Web-based authentication, use the commands:

```
awplus# configure terminal
awplus(config)# no aaa accounting auth-web default
```

To enable a named RADIUS accounting method list 'vlan10\_acct' for Web-based authentication, with the RADIUS server group 'rad\_group\_vlan10', use the commands:

```
awplus# configure terminal
awplus(config)# aaa accounting auth-web vlan10_acct start-stop
group rad_group_vlan10
```

To disable a named RADIUS accounting method list 'vlan10\_acct' for Web-based authentication, use the commands:

```
awplus# configure terminal
awplus(config)# no aaa accounting auth-web vlan10_acct
```

**Related commands**

- [aaa authentication auth-web](#)
- [aaa group server](#)
- [auth-web accounting](#)
- [auth-web enable](#)
- [radius-server host](#)
- [show aaa server group](#)

# aaa accounting commands

**Overview** This command configures and enables TACACS+ accounting on commands entered at a specified privilege level. Once enabled for a privilege level, accounting messages for commands entered at that privilege level will be sent to a TACACS+ server.

In order to account for all commands entered on a device, configure command accounting for each privilege level separately.

The command accounting message includes, the command as entered, the date and time the command finished executing, and the user-name of the user who executed the command.

Use the **no** variant of this command to disable command accounting for a specified privilege level.

**Syntax** `aaa accounting commands <1-15> default stop-only group tacacs+`  
`no aaa accounting commands <1-15> default`

Parameter	Description
<1-15>	The privilege level being configured, in the range 1 to 15.
default	Use the default method list, this means the command is applied globally to all user exec sessions.
stop-only	Send accounting message when the commands have stopped executing.
group	Specify the server group where accounting messages are sent. Only the tacacs+ group is available for this command.
tacacs+	Use all TACACS+ servers configured by the <code>tacacs-server host</code> command.

**Default** TACACS+ command accounting is disabled by default.

**Mode** Global Configuration

**Usage notes** This command only supports a **default** method list, this means that it is applied to every console and VTY line.

The **stop-only** parameter indicates that the command accounting messages are sent to the TACACS+ server when the commands have stopped executing.

The **group tacacs+** parameters signifies that the command accounting messages are sent to the TACACS+ servers configured by the `tacacs-server host` command.

Note that up to four TACACS+ servers can be configured for accounting. The servers are checked for reachability in the order they are configured with only the first reachable server being used. If no server is found, the accounting message is dropped.

Command accounting cannot coexist with triggers. An error message is displayed if you attempt to enable command accounting while a trigger is configured. Likewise, an error message is displayed if you attempt to configure a trigger while command accounting is configured.

**Examples** To configure command accounting for privilege levels 1, 7, and 15, use the following commands:

```
awplus# configure terminal
awplus(config)# aaa accounting commands 1 default stop-only
group tacacs+
awplus(config)# aaa accounting commands 7 default stop-only
group tacacs+
awplus(config)# aaa accounting commands 15 default stop-only
group tacacs+
```

To disable command accounting for privilege levels 1, 7, and 15, use the following commands:

```
awplus# configure terminal
awplus(config)# no aaa accounting commands 1 default
awplus(config)# no aaa accounting commands 7 default
awplus(config)# no aaa accounting commands 15 default
```

**Related commands**

- [aaa authentication login](#)
- [aaa accounting login](#)
- [accounting login](#)
- [tacacs-server host](#)

# aaa accounting dot1x

**Overview** Use this command to configure an accounting method list for IEEE 802.1X-based authentication. An accounting method list specifies what type of accounting messages are sent and which RADIUS servers the accounting messages are sent to. Use this command to configure either the default method list, which is automatically applied to interfaces with IEEE 802.1X-based authentication enabled, or a named method list, which can be applied to an interface with the [dot1x accounting](#) command.

Use the **no** variant of this command to disable either the default or a named accounting method list for 802.1X-based authentication. Once all method lists are disabled, AAA accounting for 802.1x-based authentication is disabled globally.

**Syntax**

```
aaa accounting dot1x {default | <list-name>}  
{start-stop | stop-only | none} group {<group-name> | radius}  
no aaa accounting dot1x {default | <list-name>}
```

Parameter	Description
default	Configure the default accounting method list
<list-name>	Configure a named accounting method list
start-stop	Sends a start accounting message at the beginning of the session and a stop accounting message at the end of the session.
stop-only	Only sends a stop accounting message at the end of the session.
none	No accounting record sent.
group	Use a server group
<group-name>	Server group name.
radius	Use all RADIUS servers.

**Default** RADIUS accounting for 802.1X-based authentication is disabled by default (there is no default server set by default).

**Mode** Global Configuration

**Usage notes** This command can be used to configure either the default accounting method list or a named accounting method list:

- **default:** the default accounting method list which is automatically applied to all interfaces with 802.1X-based authentication enabled.
- **<list-name>:** a user named list which can be applied to an interface using the [dot1x accounting](#) command.

There are two ways to define servers where RADIUS accounting messages will be sent:

- **group radius:** use all RADIUS servers configured by `radius-server host` command.
- **group <group-name>:** use the specified RADIUS server group configured with the `aaa group server` command.

The accounting event to send to the RADIUS server is configured by the following options:

- **start-stop:** sends a **start** accounting message at the beginning of a session and a **stop** accounting message at the end of the session.
- **stop-only:** sends a **stop** accounting message at the end of a session.
- **none:** disables accounting.

**Examples** To enable RADIUS accounting for 802.1X-based authentication, and use all available RADIUS Servers, use the commands:

```
awplus# configure terminal
awplus(config)# aaa accounting dot1x default start-stop group
radius
```

To disable RADIUS accounting for 802.1X-based authentication, use the commands:

```
awplus# configure terminal
awplus(config)# no aaa accounting dot1x default
```

To enable a named RADIUS accounting method list 'vlan10\_acct' for 802.1X-based authentication, with the RADIUS server group 'rad\_group\_vlan10', use the commands:

```
awplus# configure terminal
awplus(config)# aaa accounting dot1x vlan10_acct start-stop
group rad_group_vlan10
```

To disable a named RADIUS accounting method list 'vlan10\_acct' for 802.1X-based authentication, use the commands:

```
awplus# configure terminal
awplus(config)# no aaa accounting dot1x vlan10_acct
```

**Related  
commands**

[aaa accounting update](#)  
[aaa authentication dot1x](#)  
[aaa group server](#)  
[dot1x accounting](#)  
[dot1x port-control](#)  
[radius-server host](#)  
[show aaa server group](#)

**Command  
changes**

Version 5.4.9-2.1: command added to AR2050V, AR3050S, and AR4050S

# aaa accounting login

**Overview** This command configures RADIUS and TACACS+ accounting for login shell sessions. The specified method list name can be used by the **accounting login** command in the Line Configuration mode. If the **default** parameter is specified, then this creates a default method list that is applied to every console and VTY line, unless another accounting method list is applied on that line.

Note that unlimited RADIUS servers and up to four TACACS+ servers can be configured and consulted for accounting. The first server configured is regarded as the primary server and if the primary server fails then the backup servers are consulted in turn. A backup server is consulted if the primary server fails, i.e. is unreachable.

Use the **no** variant of this command to remove an accounting method list for login shell sessions configured by an **aaa accounting login** command. If the method list being deleted is already applied to a console or VTY line, accounting on that line will be disabled. If the default method list name is removed by this command, it will disable accounting on every line that has the default accounting configuration.

**Syntax**

```
aaa accounting login  
{default | <list-name>} {start-stop | stop-only | none} {group  
{radius | tacacs+ | <group-name>}}  
  
no aaa accounting login {default | <list-name>}
```

Parameter	Description
default	Default accounting method list.
<list-name>	Named accounting method list.
start-stop	Start and stop records to be sent.
stop-only	Stop records to be sent.
none	No accounting record to be sent.
group	Specify the servers or server group where accounting packets are sent.
radius	Use all RADIUS servers configured by the <a href="#">radius-server host</a> command.
tacacs+	Use all TACACS+ servers configured by the <a href="#">tacacs-server host</a> command.
<group-name>	Use the specified RADIUS server group, as configured by the <a href="#">aaa group server</a> command.

**Default** Accounting for login shell sessions is disabled by default.

**Mode** Global Configuration

**Usage notes** This command enables you to define a named accounting method list. The items that you define in the accounting options are:

- the types of accounting packets that will be sent
- the set of servers to which the accounting packets will be sent

You can define a default method list with the name **default** and any number of other named method lists. The name of any method list that you define can then be used as the *<list-name>* parameter in the [accounting login](#) command.

If the method list name already exists, the command will replace the existing configuration with the new one.

There are two ways to define servers where RADIUS accounting messages are sent:

- **group radius** : use all RADIUS servers configured by [radius-server host](#) command
- **group <group-name>** : use the specified RADIUS server group configured with the [aaa group server](#) command

There is one way to define servers where TACACS+ accounting messages are sent:

- **group tacacs+** : use all TACACS+ servers configured by [tacacs-server host](#) command

The accounting event to send to the RADIUS or TACACS+ server is configured with the following options:

- **start-stop** : sends a **start** accounting message at the beginning of a session and a **stop** accounting message at the end of the session.
- **stop-only** : sends a **stop** accounting message at the end of a session.
- **none** : disables accounting.

**Examples** To configure RADIUS accounting for login shell sessions, use the following commands:

```
awplus# configure terminal
awplus(config)# aaa accounting login default start-stop group
radius
```

To configure TACACS+ accounting for login shell sessions, use the following commands:

```
awplus# configure terminal
awplus(config)# aaa accounting login default start-stop group
tacacs+
```

To reset the configuration of the default accounting list, use the following commands:

```
awplus# configure terminal
awplus(config)# no aaa accounting login default
```



**Related commands**

- [aaa accounting commands](#)
- [aaa authentication login](#)
- [aaa accounting login](#)
- [aaa accounting update](#)
- [accounting login](#)
- [radius-server host](#)
- [tacacs-server host](#)

# aaa accounting update

**Overview** This command enables periodic accounting reporting to either the RADIUS or TACACS+ accounting server(s) wherever login accounting has been configured.

Note that unlimited RADIUS servers and up to four TACACS+ servers can be configured and consulted for accounting. The first server configured is regarded as the primary server and if the primary server fails then the backup servers are consulted in turn. A backup server is consulted if the primary server fails, i.e. is unreachable.

Use the **no** variant of this command to disable periodic accounting reporting to the accounting server(s).

**Syntax** `aaa accounting update [periodic <1-65535>]`  
`no aaa accounting update`

Parameter	Description
<code>periodic</code>	Send accounting records periodically.
<code>&lt;1-65535&gt;</code>	The interval to send accounting updates (in minutes). The default is 30 minutes.

**Default** Periodic accounting update is disabled by default.

**Mode** Global Configuration

**Usage notes** Use this command to enable the device to send periodic AAA login accounting reports to the accounting server. When periodic accounting report is enabled, interim accounting records are sent according to the interval specified by the **periodic** parameter. The accounting updates are start messages.

If the **no** variant of this command is used to disable periodic accounting reporting, any interval specified by the **periodic** parameter is reset to the default of 30 minutes when accounting reporting is reenabled, unless this interval is specified.

**Examples** To configure the switch to send period accounting updates every 30 minutes, the default period, use the following commands:

```
awplus# configure terminal
awplus(config)# aaa accounting update
```

To configure the switch to send period accounting updates every 10 minutes, use the following commands:

```
awplus# configure terminal
awplus(config)# aaa accounting update periodic 10
```

To disable periodic accounting update wherever accounting has been configured, use the following commands:

```
awplus# configure terminal  
awplus(config)# no aaa accounting update
```

**Related  
commands**

[aaa accounting auth-mac](#)  
[aaa accounting auth-web](#)  
[aaa accounting dot1x](#)  
[aaa accounting login](#)

# aaa authentication auth-mac

**Overview** This command enables MAC-based authentication globally and allows you to enable either the default authentication method list (in this case, a list of RADIUS servers), which is automatically applied to every interface running MAC-based authentication, or a user named authentication method list, which is applied to an interface with the [auth-mac authentication](#) command.

Use the **no** variant of this command to disable either the default or a named method list for MAC-based authentication. Once all method lists are disabled MAC-based authentication is disabled globally.

**Syntax**

```
aaa authentication auth-mac {default|<list-name>} group  
{<group-name>|radius}  
  
no aaa authentication auth-mac {default|<list-name>}
```

Parameter	Description
default	Configure the default authentication method list
<list-name>	Configure a named authentication method list
group	Use a server group
<group-name>	Server group name.
radius	Use all RADIUS servers.

**Default** MAC-based Port Authentication is disabled by default.

**Mode** Global Configuration

**Usage notes** This command can be used to configure either the default authentication method list or a named authentication method list:

- **default:** the default authentication method list which is automatically applied to all interfaces with Web-based authentication enabled.
- **<list-name>:** a user named list which can be applied to an interface using the [auth-web authentication](#) command.

There are two ways to define servers where RADIUS accounting messages are sent:

- **group radius:** use all RADIUS servers configured by [radius-server host](#) command
- **group <group-name>:** use the specified RADIUS server group configured with the [aaa group server](#) command

All configured RADIUS Servers are automatically members of the server group **radius**. If a server is added to a named group **<group-name>**, it also remains a member of the group **radius**.

**Examples** To enable MAC-based authentication globally for all RADIUS servers, and use all available RADIUS servers, use the commands:

```
awplus# configure terminal
awplus(config)# aaa authentication auth-mac default group
radius
```

To disable MAC-based authentication, use the commands:

```
awplus# configure terminal
awplus(config)# no aaa authentication auth-mac default
```

To enable MAC-based authentication for named list 'vlan10\_auth', with RADIUS server group 'rad\_group\_vlan10, use the commands:

```
awplus# configure terminal
awplus(config)# aaa authentication auth-mac vlan10_auth group
rad_group_vlan10
```

To disable MAC-based authentication for named list 'vlan10\_auth', use the commands:

```
awplus# configure terminal
awplus(config)# no aaa authentication auth-mac vlan10_acct
```

**Related commands**

- [aaa accounting auth-mac](#)
- [aaa group server](#)
- [auth-mac authentication](#)
- [auth-mac enable](#)
- [radius-server host](#)
- [show aaa server group](#)

# aaa authentication auth-web

**Overview** This command enables Web-based authentication globally and allows you to enable either the default authentication method list (in this case, a list of RADIUS servers), which is automatically applied to every interface running Web-based authentication, or a user named authentication method list, which is applied to an interface with the [auth-web authentication](#) command.

Use the **no** variant of this command to disable either the default or a named method list for Web-based authentication. Once all method lists are disabled Web-based authentication is disabled globally.

**Syntax**

```
aaa authentication auth-web {default|<list-name>} group  
{<group-name>|radius}  
  
no aaa authentication auth-web {default|<list-name>}
```

Parameter	Description
default	Configure the default authentication method list
<list-name>	Configure a named authentication method list
group	Use a server group
<group-name>	Server group name.
radius	Use all RADIUS servers.

**Default** Web-based authentication is disabled by default.

**Mode** Global Configuration

**Usage notes** This command can be used to configure either the default authentication method list or a named authentication method list:

- **default:** the default authentication method list which is automatically applied to all interfaces with Web-based authentication enabled.
- **<list-name>:** a user named list which can be applied to an interface using the [auth-web authentication](#) command.

There are two ways to define servers where RADIUS accounting messages are sent:

- **group radius:** use all RADIUS servers configured by [radius-server host](#) command
- **group <group-name>:** use the specified RADIUS server group configured with the [aaa group server](#) command

Note that you need to configure an IPv4 address for the VLAN interface on which Web authentication is running.

**Examples** To enable Web-based authentication globally for all RADIUS servers, and use all available RADIUS servers, use the commands:

```
awplus# configure terminal
awplus(config)# aaa authentication auth-web default group
radius
```

To disable Web-based authentication, use the commands:

```
awplus# configure terminal
awplus(config)# no aaa authentication auth-web default
```

To enable Web-based authentication for named list 'vlan10\_auth', with RADIUS server group 'rad\_group\_vlan10, use the commands:

```
awplus# configure terminal
awplus(config)# aaa authentication auth-web vlan10_auth group
rad_group_vlan10
```

To disable Web-based authentication for named list 'vlan10\_auth', use the commands:

```
awplus# configure terminal
awplus(config)# no aaa authentication vlan10_auth
```

**Related commands**

- [aaa accounting auth-web](#)
- [aaa group server](#)
- [auth-web authentication](#)
- [auth-web enable](#)
- [radius-server host](#)

# aaa authentication dot1x

**Overview** Use this command to enable IEEE 802.1X-based authentication globally and to allow you to enable either the default authentication method list (in this case, a list of RADIUS servers), which is automatically applied to every interface running IEEE 802.1X-based authentication, or a user named authentication method list, which is applied to an interface with the [dot1x authentication](#) command.

Use the **no** variant of this command to disable either the default or a named method list for 802.1X-based authentication. Once all method lists are disabled 802.1x-based authentication is disabled globally.

**Syntax**

```
aaa authentication dot1x {default|<list-name>} group  
{<group-name>|radius}  
  
no aaa authentication dot1x {default|<list-name>}
```

Parameter	Description
default	Configure the default authentication method list
<list-name>	Configure a named authentication method list
group	Use a server group
<group-name>	Server group name.
radius	Use all RADIUS servers.

**Default** 802.1X-based Port Authentication is disabled by default.

**Mode** Global Configuration

**Usage notes** This command can be used to configure either the default authentication method list or a named authentication method list:

- **default:** the default authentication method list which is automatically applied to all interfaces with 802.1X-based authentication enabled.
- **<list-name>:** a user named list which can be applied to an interface using the [aaa authentication dot1x](#) command.

There are two ways to define servers where RADIUS accounting messages are sent:

- **group radius:** use all RADIUS servers configured by [radius-server host](#) command
- **group <group-name>:** use the specified RADIUS server group configured with the [aaa group server](#) command

**Examples** To enable 802.1X-based authentication globally with all RADIUS servers, and use all available RADIUS servers, use the command:

```
awplus# configure terminal  
awplus(config)# aaa authentication dot1x default group radius
```



To disable 802.1X-based authentication, use the command:

```
awplus# configure terminal
awplus(config)# no aaa authentication dot1x default
```

To enable 802.1X-based authentication for named list 'vlan10\_auth', with RADIUS server group 'rad\_group\_vlan10', use the commands:

```
awplus# configure terminal
awplus(config)# aaa authentication dot1x vlan10_auth group
rad_group_vlan10
```

To disable 802.1X-based authentication for named list 'vlan10\_auth' use the commands:

```
awplus# configure terminal
awplus(config)# no aaa authentication dot1x vlan10_acct
```

**Related  
commands**

[aaa accounting dot1x](#)  
[aaa group server](#)  
[dot1x authentication](#)  
[dot1x port-control](#)  
[radius-server host](#)  
[show aaa server group](#)

**Command  
changes**

Version 5.4.9-2.1: command added to AR2050V, AR3050S, and AR4050S

# aaa authentication enable default group tacacs+

**Overview** This command enables privilege level authentication against a TACACS+ server. Use the **no** variant of this command to disable privilege level authentication.

**Syntax** `aaa authentication enable default group tacacs+ [local] [none]`  
`no aaa authentication enable default`

Parameter	Description
local	Use the locally configured enable password ( <b>enable password</b> command) for authentication.
none	No authentication.

**Default** Local privilege level authentication is enabled by default (`aaa authentication enable default local` command).

**Mode** Global Configuration

**Usage notes** A user is configured on a TACACS+ server with a maximum privilege level. When they enter the `enable (Privileged Exec mode)` command they are prompted for an enable password which is authenticated against the TACACS+ server. If the password is correct and the specified privilege level is equal to or less than the users maximum privilege level, then they are granted access to that level. If the user attempts to access a privilege level that is higher than their maximum configured privilege level, then the authentication session will fail and they will remain at their current privilege level.

**NOTE:** If both **local** and **none** are specified, you must always specify **local** first.

If the TACACS+ server goes offline, or is not reachable during enable password authentication, and command level authentication is configured as:

- **aaa authentication enable default group tacacs+**  
then the user is never granted access to Privileged Exec mode.
- **aaa authentication enable default group tacacs+ local**  
then the user is authenticated using the locally configured enable password, which if entered correctly grants the user access to Privileged Exec mode. If no enable password is locally configured (**enable password** command), then the enable authentication will fail until the TACACS+ server becomes available again.

- **aaa authentication enable default group tacacs+ none**  
then the user is granted access to Privileged Exec mode with no authentication. This is true even if a locally configured enable password is configured.
- **aaa authentication enable default group tacacs+ local none**  
then the user is authenticated using the locally configured enable password. If no enable password is locally configured, then the enable authentication will grant access to Privileged Exec mode with no authentication.

If the password for the user is not successfully authenticated by the server, then the user is again prompted for an enable password when they enter **enable** via the CLI.

**Examples** To enable a privilege level authentication method that will not allow the user to access Privileged Exec mode if the TACACS+ server goes offline, or is not reachable during enable password authentication, use the following commands:

```
awplus# configure terminal
```

```
awplus(config)# aaa authentication enable default group tacacs+
```

To enable a privilege level authentication method that will allow the user to access Privileged Exec mode if the TACACS+ server goes offline, or is not reachable during enable password authentication, and a locally configured enable password is configured, use the following commands:

```
awplus# configure terminal
```

```
awplus(config)# aaa authentication enable default group tacacs+  
local
```

To disable privilege level authentication, use the following commands:

```
awplus# configure terminal
```

```
awplus(config)# no aaa authentication enable default
```

**Related commands**

- [aaa authentication login](#)
- [aaa authentication enable default local](#)
- [enable \(Privileged Exec mode\)](#)
- [enable password](#)
- [enable secret](#)
- [tacacs-server host](#)

# aaa authentication enable default local

**Overview** This command enables local privilege level authentication.  
Use the **no** variant of this command to disable local privilege level authentication.

**Syntax** `aaa authentication enable default local`  
`no aaa authentication enable default`

**Default** Local privilege level authentication is enabled by default.

**Mode** Global Configuration

**Usage notes** The privilege level configured for a particular user in the local user database is the privilege threshold above which the user is prompted for an [enable \(Privileged Exec mode\)](#) command.

**Examples** To enable local privilege level authentication, use the following commands:

```
awplus# configure terminal
awplus(config)# aaa authentication enable default local
```

To disable local privilege level authentication, use the following commands:

```
awplus# configure terminal
awplus(config)# no aaa authentication enable default
```

**Related commands** [aaa authentication login](#)  
[enable \(Privileged Exec mode\)](#)  
[enable password](#)  
[enable secret](#)

# aaa authentication login

**Overview** Use this command to create an ordered list of methods to use to authenticate user login, or to replace an existing method list with the same name. Specify one or more of the options **local** or **group**, in the order you want them to be applied. If the **default** method list name is specified, it is applied to every console and VTY line immediately unless another method list is applied to that line by the [login authentication](#) command. To apply a non-default method list, you must also use the [login authentication](#) command.

Use the **no** variant of this command to remove an authentication method list for user login. The specified method list name is deleted from the configuration. If the method list name has been applied to any console or VTY line, user login authentication on that line will fail.

Note that the **no aaa authentication login default** command does not remove the default method list. This will return the default method list to its default state (**local** is the default).

**Syntax**

```
aaa authentication login {default | <list-name>} {[local] [group  
{radius | tacacs+ | <group-name>}]}  
no aaa authentication login {default | <list-name>}
```

Parameter	Description
default	Set the default authentication server for user login.
<list-name>	Name of authentication server.
local	Use the local username database.
group	Use server group.
radius	Use all RADIUS servers configured by the <a href="#">radius-server host</a> command.
tacacs+	Use all TACACS+ servers configured by the <a href="#">tacacs-server host</a> command.
<group-name>	Use the specified RADIUS server group, as configured by the <a href="#">aaa group server</a> command.

**Default** If the default server is not configured using this command, user login authentication uses the local user database only.

If the **default** method list name is specified, it is applied to every console and VTY line immediately unless a named method list server is applied to that line by the **login authentication** command.

**local** is the default state for the default method list unless a named method list is applied to that line by the **login authentication** command. Reset to the default method list using the **no aaa authentication login default** command.

**Mode** Global Configuration

**Usage notes** When a user attempts to log in, the switch sends an authentication request to the first authentication server in the method list. If the first server in the list is reachable and it contains a username and password matching the authentication request, the user is authenticated and the login succeeds. If the authentication server denies the authentication request because of an incorrect username or password, the user login fails. If the first server in the method list is unreachable, the switch sends the request to the next server in the list, and so on.

For example, if the method list specifies **group tacacs+ local**, and a user attempts to log in with a password that does not match a user entry in the first TACACS+ server, if this TACACS+ server denies the authentication request, then the switch does not try any other TACACS+ servers not the local user database; the user login fails.

**Examples** To configure the default authentication method list for user login to first use all available RADIUS servers for user login authentication, and then use the local user database, use the following commands:

```
awplus# configure terminal
awplus(config)# aaa authentication login default group radius
local
```

To configure a user login authentication method list called **USERS** to first use the RADIUS server group RAD\_GROUP1 for user login authentication, and then use the local user database, use the following commands:

```
awplus# configure terminal
awplus(config)# aaa authentication login USERS group RAD_GROUP1
local
```

To configure a user login authentication method list called USERS to first use the TACACS+ servers for user login authentication, and then use the local user database, use the following commands:

```
awplus# configure terminal
awplus(config)# aaa authentication login USERS group tacacs+
local
```

To return to the default method list (**local** is the default server), use the following commands:

```
awplus# configure terminal
awplus(config)# no aaa authentication login default
```

To delete an existing authentication method list USERS created for user login authentication, use the following commands:

```
awplus# configure terminal
awplus(config)# no aaa authentication login USERS
```

**Related commands** [aaa accounting commands](#)  
[aaa authentication enable default group tacacs+ login authentication](#)

# aaa authorization commands

**Overview** This command configures a method list for commands authorization that can be applied to console or VTY lines. When command authorization is enabled for a privilege level, only authorized users can executed commands in that privilege level.

Use the **no** variant of this command to remove a named method list or disable the default method list for a privilege level.

**Syntax**

```
aaa authorization commands <privilege-level>
{default|<list-name>} group tacacs+ [none]

no aaa authorization commands <privilege-level>
{default|<list-name>}
```

Parameter	Description
<privilege-level>	The privilege level of the set of commands the method list will be applied to. AlliedWare Plus defines three sets of commands, that are indexed by a level value: <b>Level = 1:</b> All commands that can be accessed by a user with privilege level between 1 and 6 inclusive <b>Level = 7:</b> All commands that can be accessed by a user with privilege level between 7 and 14 inclusive <b>Level = 15:</b> All commands that can be accessed by a user with privilege level 15
group	Specify the server group where authorization messages are sent. Only the <code>tacacs+</code> group is available for this command.
tacacs+	Use all TACACS+ servers configured by the <code>tacacs-server host</code> command.
default	Configure the default authorization commands method list.
<list-name>	Configure a named authorization commands method list
none	If specified, this provides a local fallback to command authorization so that if authorization servers become unavailable then the device will accept all commands normally allowed for the privilege level of the user.

**Mode** Global Configuration

**Usage notes** TACACS+ command authorization provides centralized control of the commands available to a user of an AlliedWare Plus device. Once enabled:

- The command string and username are encrypted and sent to the first available configured TACACS+ server (the first server configured) for authorization.

- The TACACS+ server decides if the user is authorized to execute the command and returns the decision to the AlliedWare Plus device.
- Depending on this decision the device will then either execute the command or notify the user that authorization has failed.

If multiple TACACS+ servers are configured, and the first server is unreachable or does not respond, the other servers will be queried, in turn, for an authorization decision. If all servers are unreachable and a local fallback has been configured, with the **none** parameter, then commands are authorized based on the user's privilege level; the same behavior as if command authorization had not been configured. If, however, the local fallback is not configured and all servers become unreachable then all commands except **logout**, **exit**, and **quit** will be denied.

The **default** method list is defined with a local fallback unless configured differently using this command.

**Example** To configure a commands authorization method list, named TAC15, using all TACACS+ servers to authorize commands for privilege level 15, with a local fallback, use the following commands:

```
awplus# configure terminal
awplus(config)# aaa authorization commands 15 TAC15 group
tacacs+ none
```

To configure the default method list to authorize commands for privilege level 7, with no local fallback, use the following commands:

```
awplus# configure terminal
awplus(config)# aaa authorization commands 7 default group
tacacs+
```

To remove the authorization method list TAC15, use the following commands:

```
awplus# configure terminal
awplus(config)# no aaa authorization commands 15 TAC15
```

**Related commands** [aaa authorization config-commands](#)  
[authorization commands](#)  
[tacacs-server host](#)

**Command changes** Version 5.4.6-2.1: command added



# aaa authorization config-commands

**Overview** Use this command to enable command authorization on configuration mode commands. By default, command authorization applies to commands in exec mode only.

Use the **no** variant of this command to disable command authorization on configuration mode commands.

**Syntax** `aaa authorization config-commands`  
`no aaa authorization config-commands`

**Default** By default, command authorization is disabled on configuration mode commands.

**Mode** Global Configuration

**Usage notes** If authorization of configuration mode commands is not enabled then all configuration commands are accepted by default, including command authorization commands.

**NOTE:** *Authorization of configuration commands is required for a secure TACACS+ command authorization configuration as it prevents the feature from being disabled to gain access to unauthorized exec mode commands.*

**Example** To enable command authorization for configuration mode commands, use the commands:

```
awplus# configure terminal
awplus(config)# aaa authorization config-commands
```

To disable command authorization for configuration mode commands, use the commands:

```
awplus# configure terminal
awplus(config)# no aaa authorization config-commands
```

**Related commands** [aaa authorization commands](#)  
[authorization commands](#)  
[tacacs-server host](#)

**Command changes** Version 5.4.6-2.1: command added

# aaa group server

**Overview** This command configures a RADIUS server group. A server group can be used to specify a subset of RADIUS servers in **aaa** commands. The group name **radius** is predefined, which includes all RADIUS servers configured by the **radius-server host** command.

RADIUS servers are added to a server group using the **server** command. Each RADIUS server should be configured using the **radius-server host** command.

Use the **no** variant of this command to remove an existing RADIUS server group.

**Syntax** `aaa group server radius <group-name>`  
`no aaa group server radius <group-name>`

Parameter	Description
<code>&lt;group-name&gt;</code>	Server group name.

**Mode** Global Configuration

**Usage notes** Use this command to create an AAA group of RADIUS servers, and to enter Server Group Configuration mode, in which you can add servers to the group. Use a server group to specify a subset of RADIUS servers in AAA commands. Each RADIUS server must be configured by the **radius-server host** command. To add RADIUS servers to a server group, use the **server** command.

**Examples** To create a RADIUS server group named GROUP1 with hosts 192.168.1.1, 192.168.2.1 and 192.168.3.1, use the commands:

```
awplus(config)# aaa group server radius GROUP1
awplus(config-sg)# server 192.168.1.1 auth-port 1812 acct-port 1813
awplus(config-sg)# server 192.168.2.1 auth-port 1812 acct-port 1813
awplus(config-sg)# server 192.168.3.1 auth-port 1812 acct-port 1813
```

To remove a RADIUS server group named GROUP1 from the configuration, use the command:

```
awplus(config)# no aaa group server radius GROUP1
```

**Related  
commands**

aaa accounting auth-mac  
aaa accounting auth-web  
aaa accounting dot1x  
aaa accounting login  
aaa authentication auth-mac  
aaa authentication auth-web  
aaa authentication dot1x  
aaa authentication login  
radius-server host  
server (server group)  
show radius server group

# aaa local authentication attempts lockout-time

**Overview** This command configures the duration of the user lockout period.

Use the **no** variant of this command to restore the duration of the user lockout period to its default of 300 seconds (5 minutes).

**Syntax** `aaa local authentication attempts lockout-time <lockout-time>`  
`no aaa local authentication attempts lockout-time`

Parameter	Description
<code>&lt;lockout-time&gt;</code>	<code>&lt;0-10000&gt;</code> . Time in seconds to lockout the user.

**Mode** Global Configuration

**Default** The default for the lockout-time is 300 seconds (5 minutes).

**Usage notes** While locked out all attempts to login with the locked account will fail. The lockout can be manually cleared by another privileged account using the [clear aaa local user lockout](#) command.

**Examples** To configure the lockout period to 10 minutes (600 seconds), use the commands:

```
awplus# configure terminal
awplus(config)# aaa local authentication attempts lockout-time
600
```

To restore the default lockout period of 5 minutes (300 seconds), use the commands:

```
awplus# configure terminal
awplus(config)# no aaa local authentication attempts
lockout-time
```

**Related commands** [aaa local authentication attempts max-fail](#)

# aaa local authentication attempts max-fail

**Overview** This command configures the maximum number of failed login attempts before a user account is locked out. Every time a login attempt fails the failed login counter is incremented.

Use the **no** variant of this command to restore the maximum number of failed login attempts to the default setting (five failed login attempts).

**Syntax** `aaa local authentication attempts max-fail <failed-logins>`  
`no aaa local authentication attempts max-fail`

Parameter	Description
<code>&lt;failed-logins&gt;</code>	<code>&lt;1-32&gt;</code> . Number of login failures allowed before locking out a user.

**Mode** Global Configuration

**Default** The default for the maximum number of failed login attempts is five failed login attempts.

**Usage** When the failed login counter reaches the limit configured by this command that user account is locked out for a specified duration configured by the [aaa local authentication attempts lockout-time](#) command.

When a successful login occurs the failed login counter is reset to 0. When a user account is locked out all attempts to login using that user account will fail.

**Examples** To configure the number of login failures that will lock out a user account to two login attempts, use the commands:

```
awplus# configure terminal
awplus(config)# aaa local authentication attempts max-fail 2
```

To restore the number of login failures that will lock out a user account to the default number of login attempts (five login attempts), use the commands:

```
awplus# configure terminal
awplus(config)# no aaa local authentication attempts max-fail
```

**Related commands** [aaa local authentication attempts lockout-time](#)  
[clear aaa local user lockout](#)

# aaa login fail-delay

**Overview** Use this command to configure the minimum time period between failed login attempts. This setting applies to login attempts via the console, SSH and Telnet. Use the **no** variant of this command to reset the minimum time period to its default value.

**Syntax** `aaa login fail-delay <1-10>`  
`no aaa login fail-delay`

Parameter	Description
<1-10>	The minimum number of seconds required between login attempts

**Default** 1 second

**Mode** Global configuration

**Example** To apply a delay of at least 5 seconds between login attempts, use the following commands:

```
awplus# configure terminal
awplus(config)# aaa login fail-delay 5
```

**Related commands** [aaa authentication login](#)  
[aaa local authentication attempts lockout-time](#)  
[clear aaa local user lockout](#)

# accounting login

**Overview** This command applies a login accounting method list to console or VTY lines for user login. When login accounting is enabled using this command, logging events generate an accounting record to the accounting server.

The accounting method list must be configured first using this command. If an accounting method list is specified that has not been created by this command then accounting will be disabled on the specified lines.

The **no** variant of this command resets AAA Accounting applied to console or VTY lines for local or remote login. **default** login accounting is applied after issuing the **no accounting login** command. Accounting is disabled with **default**.

**Syntax** `accounting login {default|<list-name>}`  
`no accounting login`

Parameter	Description
default	Default accounting method list.
<list-name>	Named accounting method list.

**Default** By default login accounting is disabled in the **default** accounting server. No accounting will be performed until accounting is enabled using this command.

**Mode** Line Configuration

**Examples** To apply the accounting server USERS to all VTY lines, use the following commands:

```
awplus# configure terminal
awplus(config)# line vty 0 32
awplus(config-line)# accounting login USERS
```

To reset accounting for login sessions on the console, use the following commands:

```
awplus# configure terminal
awplus(config)# line console 0
awplus(config-line)# no accounting login
```

**Related commands** [aaa accounting commands](#)  
[aaa accounting login](#)

# authorization commands

**Overview** This command applies a command authorization method list, defined using the [aaa authorization commands](#) command, to console and VTY lines.

Use the **no** variant of this command to reset the command authorization configuration on the console and VTY lines.

**Syntax** `authorization commands <privilege-level> {default|<list-name>}`  
`no authorization commands <privilege-level>`

Parameter	Description
<code>&lt;privilege-level&gt;</code>	The privilege level of the set of commands the method list will be applied to. AlliedWare Plus defines three sets of commands, that are indexed by a level value: <b>Level = 1:</b> All commands that can be accessed by a user with privilege level between 1 and 6 inclusive <b>Level = 7:</b> All commands that can be accessed by a user with privilege level between 7 and 14 inclusive <b>Level = 15:</b> All commands that can be accessed by a user with privilege level 15
<code>default</code>	Configure the default authorization commands method list.
<code>&lt;list-name&gt;</code>	Configure a named authorization commands method list

**Default** The **default** method list is applied to each console and VTY line by default.

**Mode** Line Configuration

**Usage notes** If the specified method list does not exist users will not be able to execute any commands in the specified method list on the specified VTY lines.

**Example** To apply the TAC15 command authorization method list with privilege level 15 to VTY lines 0 to 5, use the following commands:

```
awplus# configure terminal
awplus(config)# line vty 0 5
awplus(config-line)# authorization commands 15 TAC15
```

To reset the command authorization configuration with privilege level 15 on VTY lines 0 to 5, use the following commands:

```
awplus# configure terminal
awplus(config)# line vty 0 5
awplus(config-line)# no authorization commands 15
```

**Related commands** [aaa authorization commands](#)



aaa authorization config-commands

tacacs-server host

**Command changes** Version 5.4.6-2.1: command added

# clear aaa local user lockout

**Overview** Use this command to clear the lockout on a specific user account or all user accounts.

**Syntax** `clear aaa local user lockout {username <username>|all}`

Parameter	Description
username	Clear lockout for the specified user.
<username>	Specifies the user account.
all	Clear lockout for all user accounts.

**Mode** Privileged Exec

**Examples** To unlock the user account 'bob' use the following command:

```
awplus# clear aaa local user lockout username bob
```

To unlock all user accounts use the following command:

```
awplus# clear aaa local user lockout all
```

**Related commands** [aaa local authentication attempts lockout-time](#)

# debug aaa

**Overview** This command enables AAA debugging.

Use the **no** variant of this command to disable AAA debugging.

**Syntax** debug aaa [accounting|all|authentication|authorization]  
no debug aaa [accounting|all|authentication|authorization]

Parameter	Description
accounting	Accounting debugging.
all	All debugging options are enabled.
authentication	Authentication debugging.
authorization	Authorization debugging.

**Default** AAA debugging is disabled by default.

**Mode** Privileged Exec

**Examples** To enable authentication debugging for AAA, use the command:

```
awplus# debug aaa authentication
```

To disable authentication debugging for AAA, use the command:

```
awplus# no debug aaa authentication
```

**Related commands** [show debugging aaa](#)  
[undebug aaa](#)

# login authentication

**Overview** Use this command to apply an AAA server for authenticating user login attempts from a console or remote logins on these console or VTY lines. The authentication method list must be specified by the **aaa authentication login** command. If the method list has not been configured by the **aaa authentication login** command, login authentication will fail on these lines.

Use the **no** variant of this command to reset AAA Authentication configuration to use the default method list for login authentication on these console or VTY lines.

**Command Syntax**

```
login authentication {default|<list-name>}  
no login authentication
```

Parameter	Description
default	The default authentication method list. If the default method list has not been configured by the <a href="#">aaa authentication login</a> command, the local user database is used for user login authentication.
<list-name>	Named authentication server.

**Default** The default login authentication method list, as specified by the [aaa authentication login](#) command, is used to authenticate user login. If this has not been specified, the default is to use the local user database.

**Mode** Line Configuration

**Examples** To apply the authentication method list called `CONSOLE` to the console port terminal line (asyn 0), use the following commands:

```
awplus# configure terminal  
awplus(config)# line console 0  
awplus(config-line)# login authentication CONSOLE
```

To reset user authentication configuration on all VTY lines, use the following commands:

```
awplus# configure terminal  
awplus(config)# line vty 0 32  
awplus(config-line)# no login authentication
```

**Related commands** [aaa authentication login](#)  
[line](#)

# proxy-port

**Overview** Use this command to change the local UDP port used for communication between local RADIUS client applications and the RadSecProxy AAA application. Any unused UDP port may be selected. The default port is 1645.

Use the **no** variant of this command to change the UDP port back to the default of 1645.

**Syntax** `proxy-port <port>`  
`no proxy-port`

Parameter	Description
<code>&lt;port&gt;</code>	UDP Port Number, 1-65536.

**Default** The default port is 1645.

**Mode** RadSecProxy AAA Configuration Mode

**Usage notes** It is not necessary to change the value from the default unless UDP port 1645 is required for another purpose. RADIUS requests received on this port from external devices will be ignored. The port is only used for local (intra-device) communication.

**Example** To configure change the UDP port to 7001, use the following commands:

```
awplus# configure terminal
awplus(config)# radius-secure-proxy aaa
awplus(config-radsecproxy-aaa)# proxy-port 7001
```

**Related commands** [radius-secure-proxy aaa](#)  
[server \(radsecproxy-aaa\)](#)  
[server name-check](#)  
[server trustpoint](#)

# radius-secure-proxy aaa

**Overview** Use this command to enter the RadSecProxy AAA (authentication, authorization, and accounting) application configuration mode. This application allows local RADIUS-based clients on system to communicate with remote RadSec servers via a secure (TLS) proxy.

**Syntax** `radius-secure-proxy aaa`

**Mode** Global Configuration Mode

**Example** To change mode from User Exec mode to the RadSecProxy AAA configuration mode, use the commands:

```
awplus# configure terminal
awplus(config)# radius-secure-proxy aaa
awplus(config-radsecproxy-aaa)#
```

**Related commands**

- [proxy-port](#)
- [server \(radsecproxy-aaa\)](#)
- [server name-check](#)
- [server trustpoint](#)

# server (radsecproxy-aaa)

**Overview** Use this command to add a server to the RadSecProxy AAA application. Local RADIUS client applications will attempt, via the proxy, to communicate with any RadSec servers that are operational (in addition to any non-TLS RADIUS servers that are configured).

Use the **no** variant of this command to delete a previously-configured server from the RadSecProxy AAA application.

**Syntax** `server {<hostname>|<ip-addr>} [timeout <1-1000>] [name-check {on|off}]`  
`no server {<hostname>|<ip-addr>}`

Parameter	Description
<code>&lt;hostname&gt;</code>	Hostname of RadSec server
<code>&lt;ip-addr&gt;</code>	Specify the client IPv4 address, in dotted decimal notation (A.B.C.D).
<code>timeout</code>	Specify the amount of time that the RadSecProxy AAA application should wait for replies from this server. RADIUS server timeout (which defaults to 5 seconds).
<code>&lt;1-1000&gt;</code>	Time in seconds to wait for a server reply.
<code>name-check</code>	Specify whether or not to enforce certificate name checking for this client. If the parameter is not specified then the global behavior, which defaults to <b>on</b> , is used.
<code>on</code>	Enable name checking for this client.
<code>off</code>	Disable name checking for this client.

**Mode** RadSecProxy AAA Configuration Mode

**Usage notes** The server may be specified by its domain name or by its IPv4 address. If a domain name is used, it must be resolvable using a configured DNS name server.

Each server may be configured with a timeout; if not specified, the global timeout value for RADIUS servers will be used. The global timeout may be changed using the **radius-server timeout** command. The default global timeout is 5 seconds.

Each server may be configured to use certificate name-checking; if not specified, the global behavior defined by **server name-check** or **no server name-check** will be used. If name checking is enabled, the Common Name portion of the subject field of the server's X.509 certificate must match the domain name or IP address specified in this command.

**Example** To add a server 'mynas.local' with a timeout of 3 seconds, and name checking off, use the commands:

```
awplus# configure terminal
awplus(config)# radius-secure-proxy aaa
awplus(config-radsecproxy-aaa)# server mynas.local name-check
off
```

**Related commands**

- [proxy-port](#)
- [radius-secure-proxy aaa](#)
- [server name-check](#)
- [server trustpoint](#)



# server mutual-authentication

**Overview** This command enables or disables mutual certificate authentication for all RadSecProxy servers. When enabled, the RadSecProxy AAA application will send a local X.509 certificate to the server when establishing a TLS connection.

Use the **no** variant of this command to disable mutual certificate validation causing the RadSecProxy AAA application to not transmit a certificate to the server.

**NOTE:** *If mutual authentication is disabled on the client (AAA) application but enabled on the server, a connection will not be established.*

**Syntax** server mutual-authentication  
no server mutual-authentication

**Default** Mutual authentication is enabled by default.

**Mode** RadSecProxy AAA Configuration Mode

**Example** Disable mutual certificate validation with the following command:

```
awplus# configure terminal
awplus(config)# radius-secure-proxy aaa
awplus(config-radsecproxy-aaa)# no server
mutual-authentication
```

**Related commands** radius-secure-proxy aaa  
server name-check  
server (radsecproxy-aaa)

**Command changes** Version 5.4.6-2.1: command added

# server name-check

**Overview** This command sets the global behavior for certificate name-checking for the RadSecProxy AAA application to **on**. This behavior will be used for all servers associated with the application that do not specify a behavior on a per-server basis. If name-checking is enabled, the Common Name portion of the subject field of the client's X.509 certificate must match the domain name or IP address specified in the **server (radsecproxy-aaa)** command.

Use the **no** variant of this command to set the global behavior for certificate name checking to **off**

**Syntax** `server name-check`  
`no server name-check`

**Default** Certificate name checking is on by default.

**Mode** RadSecProxy AAA Configuration Mode

**Example** Disable certificate name checking globally with the following command:

```
awplus# configure terminal
awplus(config)# radius-secure-proxy aaa
awplus(config-radsecproxy-aaa)# no server name-check
```

**Related commands** [proxy-port](#)  
[radius-secure-proxy aaa](#)  
[server \(radsecproxy-aaa\)](#)  
[server trustpoint](#)

# server trustpoint

**Overview** This command adds one or more trustpoints to be used with the RadSecProxy AAA application. Multiple trustpoints may be specified, or the command may be executed more than once, to add multiple trustpoints to the application.

The **no** version of this command removes one or more trustpoints from the list of trustpoints associated with the application.

**Syntax** `server trustpoint [<trustpoint-list>]`  
`no server trustpoint [<trustpoint-list>]`

Parameter	Description
<trustpoint-list>	Specify one or more trustpoints to be added or deleted.

**Default** By default, no trustpoints are associated with the application.

**Mode** RadSecProxy AAA Configuration Mode

**Usage notes** The device certificate associated with first trustpoint added to the application will be transmitted to remote servers. The certificate received from the remote server must have an issuer chain that terminates with the root CA certificate for any of the trustpoints that are associated with the application.

If no trustpoints are specified in the command, the trustpoint list will be unchanged.

If **no server trustpoint** is issued without specifying any trustpoints, then all trustpoints will be disassociated from the application.

**Example** You can add multiple trustpoints to the RadSecProxy AAA application by executing the command multiple times:

```
awplus# configure terminal
awplus(config)# radius-secure-proxy aaa
awplus(config-radsecproxy-aaa)# server trustpoint example_1
awplus(config-radsecproxy-aaa)# server trustpoint example_2
```

Alternatively, add multiple trustpoints with a single command:

```
awplus(config-radsecproxy-aaa)# server trustpoint example_3
example_4
```

Disassociate all trustpoints from the RadSecProxy AAA application using the command:

```
awplus(config-radsecproxy-aaa)# no server trustpoint
```

**Related commands** [proxy-port](#)  
[radius-secure-proxy aaa](#)

server (radsecproxy-aaa)  
server name-check

# show aaa local user locked

**Overview** This command displays the current number of failed attempts, last failure time and location against each user account attempting to log into the device.

Note that once the lockout count has been manually cleared by another privileged account using the [clear aaa local user lockout](#) command or a locked account successfully logs into the system after waiting for the lockout time, this command will display nothing for that particular account.

**Syntax** show aaa local user locked

**Mode** User Exec and Privileged Exec

**Example** To display the current failed attempts for local users, use the command:

```
awplus# show aaa local user locked
```

**Output** Figure 32-1: Example output from the **show aaa local user locked** command

```
awplus# show aaa local user locked
Login          Failures Latest failure      From
bob            3      05/23/14 16:21:37    ttyS0
manager       5      05/23/14 16:31:44    192.168.1.200
```

**Related commands**

- [aaa local authentication attempts lockout-time](#)
- [aaa local authentication attempts max-fail](#)
- [clear aaa local user lockout](#)

# show aaa server group

**Overview** Use this command to list AAA users and any method lists applied to them.

**Syntax** show aaa server group

**Mode** Privileged Exec

**Example** To show the AAA configuration on a device, use the command:

```
awplus# show aaa server group
```

**Output** Figure 32-2: Example output from **show aaa server group**

```
awplus#show aaa server group
```

User	List Name	Method	Acct-Event
login	auth default	-	local -
cmd-1	auth -	-	-
cmd-7	auth -	-	-
cmd-15	auth -	-	-
login	acct -	-	-
dot1x	auth default	radius	group -
dot1x	acct vlan30_acct	rad_group_4	group start-stop
auth-mac	auth default	radius	group -
auth-mac	acct vlan10_acct	rad_group_vlan10	group start-stop
auth-web	auth default	radius	group -
auth-web	acct default	rad_group_3	group start-stop
openvpn	auth -	-	-
isakmp	auth default	radius	group -

- Related commands**
- [aaa accounting auth-mac](#)
  - [aaa accounting auth-web](#)
  - [aaa accounting dot1x](#)
  - [aaa accounting auth-mac](#)
  - [aaa authentication auth-web](#)
  - [aaa authentication dot1x](#)

# show debugging aaa

**Overview** Use this command to see what debugging is turned on for AAA (Authentication, Authorization, Accounting).

**Syntax** `show debugging aaa`

**Mode** User Exec and Privileged Exec

**Example** To display the current debugging status of AAA, use the command:

```
awplus# show debug aaa
```

**Output** Figure 32-3: Example output from the **show debug aaa** command

```
AAA debugging status:  
Authentication debugging is on  
Accounting debugging is off
```

# show radius server group

**Overview** Use this command to show the RADIUS server group configuration.

**Syntax** show radius server group [*<group-name>*]

Parameter	Description
<i>&lt;group-name&gt;</i>	RADIUS server group name.

**Default** Command name is set to something by default.

**Mode** Privileged Exec

**Usage** Use this command with the *<group-name>* parameter to display information for a specific RADIUS server group, or without the parameter to display information for all RADIUS server groups.

**Example** To display information for all RADIUS server groups, use the command:

```
awplus# show radius server group
```

To display a information for a RADIUS server group named 'rad\_group\_list1', use the command:

```
awplus# show radius server group rad_group_list1
```

**Output** Figure 32-4: Example output from **show radius server group**

```
awplus#show radius server group
RADIUS Group Configuration
  Group Name : radius?
  Server Host/   Auth  Acct  Auth  Acct
  IP Address     Port  Port  Status Status
  -----
  192.168.1.101  1812 1813  Active Active
  192.168.1.102  1812 1813  Active Active

  Group Name : rad_group_list1
  Server Host/   Auth  Acct  Auth  Acct
  IP Address     Port  Port  Status Status
  -----
  192.168.1.101  1812 1813  Active Active

  Group Name : rad_group_list2
  Server Host/   Auth  Acct  Auth  Acct
  IP Address     Port  Port  Status Status
  -----
  192.168.1.102  1812 1813  Active Active
```



Figure 32-5: Example output from **show radius server group rad\_group\_list1**

```
awplus#show radius server group rad_group_list1
RADIUS Group Configuration
  Group Name : rad_group_list1
  Server Host/   Auth  Acct  Auth  Acct
  IP Address     Port  Port  Status Status
  -----
  192.168.1.101  1812 1813  Active Active
```

**Related commands** [aaa group server](#)

# undebbug aaa

**Overview** This command applies the functionality of the **no debug aaa** command.

# 33

# RADIUS Commands

## Introduction

**Overview** This chapter provides an alphabetical reference for commands used to configure the device to use RADIUS servers. For more information, see the [RADIUS Feature Overview and Configuration Guide](#).

- Command List**
- [“auth radius send nas-identifier”](#) on page 1244
  - [“auth radius send service-type”](#) on page 1245
  - [“deadtime \(RADIUS server group\)”](#) on page 1246
  - [“debug radius”](#) on page 1247
  - [“ip radius source-interface”](#) on page 1248
  - [“radius-server deadtime”](#) on page 1249
  - [“radius-server host”](#) on page 1250
  - [“radius-server key”](#) on page 1253
  - [“radius-server retransmit”](#) on page 1254
  - [“radius-server timeout”](#) on page 1256
  - [“server \(server group\)”](#) on page 1258
  - [“show debugging radius”](#) on page 1260
  - [“show radius”](#) on page 1261
  - [“show radius statistics”](#) on page 1264
  - [“undebug radius”](#) on page 1265

# auth radius send nas-identifier

**Overview** Use this command to enable the device to include the NAS-Identifier(32) attribute in RADIUS authentication requests.

Use the **no** variant of this command to stop including the NAS-Identifier attribute.

**Syntax** `auth radius send nas-identifier [<name>|vlan-id]`  
`no auth radius send nas-identifier`

Parameter	Description
<code>&lt;name&gt;</code>	Send this user-defined text as the NAS-Identifier. You can specify up to 253 characters.
<code>vlan-id</code>	Send the VLAN ID of the authentication port as the NAS-Identifier. This is the configured VLAN ID, not the dynamic VLAN ID or guest VLAN ID.

**Mode** Global Configuration

**Example** To use a user-defined identifier of NASID100 as the NAS-Identifier attribute, use the commands:

```
awplus# configure terminal
awplus(config)# auth radius send nas-identifier NASID100
```

To use the VLAN ID as the NAS-Identifier attribute, use the commands:

```
awplus# configure terminal
awplus(config)# auth radius send nas-identifier vlan-id
```

To stop sending the NAS-Identifier attribute, use the commands:

```
awplus# configure terminal
awplus(config)# no auth radius send nas-identifier
```

**Related commands** [auth radius send service-type](#)

# auth radius send service-type

**Overview** Use this command to enable the device to include the Service-Type(6) attribute in RADIUS authentication requests. The Service-Type attribute has a value of:

- Framed(2) for 802.1x
- Call-Check(10) for MAC authentication
- Unbound(5) for Web authentication.

Use the **no** variant of this command to stop including the Service-Type attribute.

**Syntax** `auth radius send service-type`  
`no auth radius send service-type`

**Mode** Global Configuration

**Example** To send the Service-Type attribute, use the commands:

```
awplus# configure terminal
awplus(config)# auth radius send service-type
```

**Related commands** [auth radius send nas-identifier](#)

# deadtime (RADIUS server group)

**Overview** Use this command to configure the **deadtime** parameter for the RADIUS server group. This command overrides the global dead-time configured by the [radius-server deadtime](#) command. The configured deadtime is the time period in minutes to skip a RADIUS server for authentication or accounting requests if the server is “dead”. Note that a RADIUS server is considered “dead” if there is no response from the server within a defined time period.

Use the **no** variant of this command to reset the deadtime configured for the RADIUS server group. If the global deadtime for RADIUS server is configured the value will be used for the servers in the group. The global deadtime for the RADIUS server is set to 0 minutes by default.

**Syntax** `deadtime <0-1440>`  
`no deadtime`

Parameter	Description
<code>&lt;0-1440&gt;</code>	Amount of time in minutes.

**Default** The deadtime is set to 0 minutes by default.

**Mode** Server Group Configuration

**Usage** If the RADIUS server does not respond to a request packet, the packet is retransmitted the number of times configured for the **retransmit** parameter (after waiting for a **timeout** period to expire). The server is then marked “dead”, and the time is recorded. The **deadtime** parameter configures the amount of time to skip a dead server; if a server is dead, no request message is sent to the server for the **deadtime** period.

**Examples** To configure the deadtime for 5 minutes for the RADIUS server group “GROUP1”, use the command:

```
awplus(config)# aaa group server radius GROUP1
awplus(config-sg)# server 192.168.1.1
awplus(config-sg)# deadtime 5
```

To remove the deadtime configured for the RADIUS server group “GROUP1”, use the command:

```
awplus(config)# aaa group server radius GROUP1
awplus(config-sg)# no deadtime
```

**Related commands** [aaa group server](#)  
[radius-server deadtime](#)

# debug radius

**Overview** This command enables RADIUS debugging. If no option is specified, all debugging options are enabled.

Use the **no** variant of this command to disable RADIUS debugging. If no option is specified, all debugging options are disabled.

**Syntax** debug radius [packet|event|all]  
no debug radius [packet|event|all]

Parameter	Description
packet	Debugging for RADIUS packets is enabled or disabled.
event	Debugging for RADIUS events is enabled or disabled.
all	Enable or disable all debugging options.

**Default** RADIUS debugging is disabled by default.

**Mode** Privileged Exec

**Examples** To enable debugging for RADIUS packets, use the command:

```
awplus# debug radius packet
```

To enable debugging for RADIUS events, use the command:

```
awplus# debug radius event
```

To disable debugging for RADIUS packets, use the command:

```
awplus# no debug radius packet
```

To disable debugging for RADIUS events, use the command:

```
awplus# no debug radius event
```

**Related commands** [show debugging radius](#)  
[undebug radius](#)

# ip radius source-interface

**Overview** This command configures the source IP address of every outgoing RADIUS packet to use a specific IP address or the IP address of a specific interface. If the specified interface is down or there is no IP address on the interface, then the source IP address of outgoing RADIUS packets depends on the interface the packets leave.

Use the **no** variant of this command to remove the source interface configuration. The source IP address in outgoing RADIUS packets will be the IP address of the interface from which the packets are sent.

**Syntax** `ip radius source-interface {<interface>|<ip-address>}`  
`no ip radius source-interface`

Parameter	Description
<code>&lt;interface&gt;</code>	Interface name.
<code>&lt;ip-address&gt;</code>	IP address in the dotted decimal format A.B.C.D.

**Default** Source IP address of outgoing RADIUS packets depends on the interface the packets leave.

**Mode** Global Configuration

**Examples** To configure all outgoing RADIUS packets to use the IP address of the interface "vlan1" for the source IP address, use the following commands:

```
awplus# configure terminal  
awplus(config)# ip radius source-interface vlan1
```

To configure the source IP address of all outgoing RADIUS packets to use 192.168.1.10, use the following commands:

```
awplus# configure terminal  
awplus(config)# ip radius source-interface 192.168.1.10
```

To reset the source interface configuration for all outgoing RADIUS packets, use the following commands:

```
awplus# configure terminal  
awplus(config)# no ip radius source-interface
```

**Related commands** [radius-server host](#)  
[show radius statistics](#)



# radius-server deadtime

**Overview** Use this command to specify the global **deadtime** for all RADIUS servers. If a RADIUS server is considered dead, it is skipped for the specified deadtime. This command specifies for how many minutes a RADIUS server that is not responding to authentication requests is passed over by requests for RADIUS authentication.

Use the **no** variant of this command to reset the global deadtime to the default of 0 seconds, so that RADIUS servers are not skipped even if they are dead.

**Syntax** `radius-server deadtime <minutes>`  
`no radius-server deadtime`

Parameter	Description
<code>&lt;minutes&gt;</code>	RADIUS server deadtime in minutes in the range 0 to 1440 (24 hours).

**Default** The default RADIUS deadtime configured on the system is 0 seconds.

**Mode** Global Configuration

**Usage** The RADIUS client considers a RADIUS server to be dead if it fails to respond to a request after it has been retransmitted as often as specified globally by the `radius-server retransmit` command or for the server by the `radius-server host` command. To improve RADIUS response times when some servers may be unavailable, set a **deadtime** to skip dead servers.

**Examples** To set the dead time of the RADIUS server to 60 minutes, use the following commands:

```
awplus# configure terminal
awplus(config)# radius-server deadtime 60
```

To disable the dead time of the RADIUS server, use the following commands:

```
awplus# configure terminal
awplus(config)# no radius-server deadtime
```

**Related commands**

- `deadtime (RADIUS server group)`
- `radius-server host`
- `radius-server retransmit`
- `show radius statistics`

# radius-server host

**Overview** Use this command to specify a remote RADIUS server host for authentication or accounting, and to set server-specific parameters. The parameters specified with this command override the corresponding global parameters for RADIUS servers. This command specifies the IP address or host name of the remote RADIUS server host and assigns authentication and accounting destination UDP port numbers.

This command adds the RADIUS server address and sets parameters to the RADIUS server. The RADIUS server is added to the running configuration after you issue this command. If parameters are not set using this command then common system settings are applied.

Use the **no** variant of this command to remove the specified server host as a RADIUS authentication and/or accounting server and set the destination port to the default RADIUS server port number (1812).

**Syntax** `radius-server host {<host-name>|<ip-address>} [acct-port <0-65535>] [auth-port <0-65535>] [key <key-string>] [retransmit <0-100>] [timeout <1-1000>]`

`no radius-server host {<host-name>|<ip-address>} [acct-port <0-65535>] [auth-port <0-65535>]`

Parameter	Description
<code>&lt;host-name&gt;</code>	Server host name. The DNS name of the RADIUS server host.
<code>&lt;ip-address&gt;</code>	The IP address of the RADIUS server host.
<code>acct-port</code>	Accounting port. Specifies the UDP destination port for RADIUS accounting requests. If 0 is specified, the server is not used for accounting. The default UDP port for accounting is 1813.
<code>&lt;0-65535&gt;</code>	UDP port number (Accounting port number is set to 1813 by default) Specifies the UDP destination port for RADIUS accounting requests. If 0 is specified, the host is not used for accounting.
<code>auth-port</code>	Authentication port. Specifies the UDP destination port for RADIUS authentication requests. If 0 is specified, the server is not used for authentication. The default UDP port for authentication is 1812.
<code>&lt;0-65535&gt;</code>	UDP port number (Authentication port number is set to 1812 by default) Specifies the UDP destination port for RADIUS authentication requests. If 0 is specified, the host is not used for authentication.
<code>timeout</code>	Specifies the amount of time to wait for a response from the server. If this parameter is not specified the global value configured by the <b>radius-server timeout</b> command is used.

Parameter	Description
<1-1000>	Time in seconds to wait for a server reply (timeout is set to 5 seconds by default) The time interval (in seconds) to wait for the RADIUS server to reply before retransmitting a request or considering the server dead. This setting overrides the global value set by the <b>radius-server timeout</b> command. If no timeout value is specified for this server, the global value is used.
retransmit	Specifies the number of retries before skip to the next server. If this parameter is not specified the global value configured by the <b>radius-server retransmit</b> command is used.
<0-100>	Maximum number of retries (maximum number of retries is set to 3 by default) The maximum number of times to resend a RADIUS request to the server, if it does not respond within the timeout interval, before considering it dead and skipping to the next RADIUS server. This setting overrides the global setting of the <b>radius-server retransmit</b> command. If no retransmit value is specified, the global value is used.
key	Set shared secret key with RADIUS servers
<key-string>	Shared key string applied Specifies the shared secret authentication or encryption key for all RADIUS communications between this device and the RADIUS server. This key must match the encryption used on the RADIUS daemon. All leading spaces are ignored, but spaces within and at the end of the string are used. If spaces are used in the string, do not enclose the string in quotation marks unless the quotation marks themselves are part of the key. This setting overrides the global setting of the <b>radius-server key c</b> command. If no key value is specified, the global value is used.

**Default** The RADIUS client address is not configured (null) by default. No RADIUS server is configured.

**Mode** Global Configuration

**Usage** Multiple **radius-server host** commands can be used to specify multiple hosts. The software searches for hosts in the order they are specified. If no host-specific timeout, retransmit, or key values are specified, the global values apply to that host. If there are multiple RADIUS servers for this client, use this command multiple times—once to specify each server.

If you specify a host without specifying the auth port or the acct port, it will by default be configured for both authentication and accounting, using the default UDP ports. To set a host to be a RADIUS server for authentication requests only, set the **acct-port** parameter to 0; to set the host to be a RADIUS server for accounting requests only, set the auth-port parameter to 0.

A RADIUS server is identified by IP address, authentication port and accounting port. A single host can be configured multiple times with different authentication or accounting ports. All the RADIUS servers configured with this command are

included in the predefined RADIUS server group radius, which may be used by AAA authentication, authorization and accounting commands. The client transmits (and retransmits, according to the **retransmit** and **timeout** parameters) RADIUS authentication or accounting requests to the servers in the order you specify them, until it gets a response.

**Examples** To add the RADIUS server 10.0.0.20, use the following commands:

```
awplus# configure terminal
awplus(config)# radius-server host 10.0.0.20
```

To set the secret key to **allied** on the RADIUS server 10.0.0.20, use the following commands:

```
awplus# configure terminal
awplus(config)# radius-server host 10.0.0.20 key allied
```

To delete the RADIUS server 10.0.0.20, use the following commands:

```
awplus# configure terminal
awplus(config)# no radius-server host 10.0.0.20
```

To configure rad1.company.com for authentication only, use the following commands:

```
awplus# configure terminal
awplus(config)# radius-server host rad1.company.com acct-port 0
```

To remove the RADIUS server rad1.company.com configured for authentication only, use the following commands:

```
awplus# configure terminal
awplus(config)# no radius-server host rad1.company.com
acct-port 0
```

To configure rad2.company.com for accounting only, use the following commands:

```
awplus# configure terminal
awplus(config)# radius-server host rad2.company.com auth-port 0
```

To configure 192.168.1.1 with authentication port 1000, accounting port 1001 and retransmit count 5, use the following commands:

```
awplus# configure terminal
awplus(config)# radius-server host 192.168.1.1 auth-port 1000
acct-port 1001 retransmit 5
```

**Related commands**

- [aaa group server](#)
- [radius-server key](#)
- [radius-server retransmit](#)
- [radius-server timeout](#)
- [show radius statistics](#)

# radius-server key

**Overview** This command sets a global secret key for RADIUS authentication on the device. The shared secret text string is used for RADIUS authentication between the device and a RADIUS server.

Note that if no secret key is explicitly specified for a RADIUS server, the global secret key will be used for the shared secret for the server.

Use the **no** variant of this command to reset the secret key to the default (null).

**Syntax** `radius-server key <key>`  
`no radius-server key`

Parameter	Description
<key>	Shared secret among radius server and 802.1X client.

**Default** The RADIUS server secret key on the system is not set by default (null).

**Mode** Global Configuration

**Usage** Use this command to set the global secret key shared between this client and its RADIUS servers. If no secret key is specified for a particular RADIUS server using the **radius-server host c** command, this global key is used.

After enabling AAA authentication with the **aaa authentication login** command, set the authentication and encryption key using the **radius-server key** command so the key entered matches the key used on the RADIUS server.

**Examples** To set the global secret key to **allied** for RADIUS server, use the following commands:

```
awplus# configure terminal
awplus(config)# radius-server key allied
```

To set the global secret key to **secret** for RADIUS server, use the following commands:

```
awplus# configure terminal
awplus(config)# radius-server key secret
```

To delete the global secret key for RADIUS server, use the following commands:

```
awplus# configure terminal
awplus(config)# no radius-server key
```

**Related commands** [radius-server host](#)  
[show radius statistics](#)

# radius-server retransmit

**Overview** This command sets the retransmit counter to use RADIUS authentication on the device. This command specifies how many times the device transmits each RADIUS request to the RADIUS server before giving up.

This command configures the **retransmit** parameter for RADIUS servers globally. If the **retransmit** parameter is not specified for a RADIUS server by the **radius-server host** command then the global configuration set by this command is used for the server instead.

Use the **no** variant of this command to reset the re-transmit counter to the default (3).

**Syntax** `radius-server retransmit <retries>`  
`no radius-server retransmit`

Parameter	Description
<code>&lt;retries&gt;</code>	RADIUS server retries in the range <0-100>. The number of times a request is resent to a RADIUS server that does not respond, before the server is considered dead and the next server is tried. If no retransmit value is specified for a particular RADIUS server using the <b>radius-server host</b> command, this global value is used.

**Default** The default RADIUS retransmit count on the device is 3.

**Mode** Global Configuration

**Examples** To set the RADIUS **retransmit** count to 1, use the following commands:

```
awplus# configure terminal
awplus(config)# radius-server retransmit 1
```

To set the RADIUS **retransmit** count to the default (3), use the following commands:

```
awplus# configure terminal
awplus(config)# no radius-server retransmit
```

To configure the RADIUS **retransmit** count globally with 5, use the following commands:

```
awplus# configure terminal
awplus(config)# radius-server retransmit 5
```

To disable retransmission of requests to a RADIUS server, use the following commands:

```
awplus# configure terminal
awplus(config)# radius-server retransmit 0
```

**Related  
commands** radius-server deadtime  
radius-server host  
show radius statistics

# radius-server timeout

**Overview** Use this command to specify the RADIUS global timeout value. This is how long the device waits for a reply to a RADIUS request before retransmitting the request, or considering the server to be dead. If no timeout is specified for the particular RADIUS server by the **radius-server host** command, it uses this global timeout value.

Note that this command configures the **timeout** parameter for RADIUS servers globally.

The **no** variant of this command resets the transmit timeout to the default (5 seconds).

**Syntax** `radius-server timeout <seconds>`  
`no radius-server timeout`

Parameter	Description
<code>&lt;seconds&gt;</code>	RADIUS server timeout in seconds in the range 1 to 1000. The global time in seconds to wait for a RADIUS server to reply to a request before retransmitting the request, or considering the server to be dead (depending on the <b>radius-server retransmit</b> command).

**Default** The default RADIUS transmit timeout on the system is 5 seconds.

**Mode** Global Configuration

**Examples** To globally set the device to wait 20 seconds before retransmitting a RADIUS request to unresponsive RADIUS servers, use the following commands:

```
awplus# configure terminal
awplus(config)# radius-server timeout 20
```

To set the RADIUS **timeout** parameter to 1 second, use the following commands:

```
awplus# configure terminal
awplus(config)# radius-server timeout 1
```

To set the RADIUS **timeout** parameter to the default (5 seconds), use the following commands:

```
awplus# configure terminal
awplus(config)# no radius-server timeout
```

To configure the RADIUS server **timeout** period globally with 3 seconds, use the following commands:

```
awplus# configure terminal
awplus(config)# radius-server timeout 3
```



To reset the global **timeout** period for RADIUS servers to the default, use the following command:

```
awplus# configure terminal  
awplus(config)# no radius-server timeout
```

**Related  
commands**

[radius-server deadtime](#)  
[radius-server host](#)  
[radius-server retransmit](#)  
[show radius statistics](#)

# server (server group)

**Overview** This command adds a RADIUS server to a server group in Server-Group Configuration mode. The RADIUS server should be configured by the [radius-server host](#) command.

The server is appended to the server list of the group and the order of configuration determines the precedence of servers. If the server exists in the server group already, it will be removed before added as a new server.

The server is identified by IP address and authentication and accounting UDP port numbers. So a RADIUS server can have multiple entries in a group with different authentication and/or accounting UDP ports. The **auth-port** specifies the UDP destination port for authentication requests to the server. To disable authentication for the server, set `auth-port` to 0. If the authentication port is missing, the default port number is 1812. The **acct-port** specifies the UDP destination port for accounting requests to the server. To disable accounting for the server, set `acct-port` to 0. If the accounting port is missing, the default port number is 1812.

Use the **no** variant of this command to remove a RADIUS server from the server group.

**Syntax** `server {<hostname>|<ip-address>} [auth-port <0-65535>][acct-port <0-65535>]`  
`no server {<hostname>|<ip-address>} [auth-port <0-65535>][acct-port <0-65535>]`

Parameter	Description
<code>&lt;hostname&gt;</code>	Server host name
<code>&lt;ip-address&gt;</code>	Server IP address The server is identified by IP address, authentication and accounting UDP port numbers. So a RADIUS server can have multiple entries in a group with different authentication and/or accounting UDP ports.
<code>auth-port</code>	Authentication port The <b>auth-port</b> specifies the UDP destination port for authentication requests to the server. To disable authentication for the server, set <b>auth-port</b> to 0. If the authentication port is missing, the default port number is 1812.
<code>&lt;0-65535&gt;</code>	UDP port number (default: 1812)
<code>acct-port</code>	Accounting port The <b>acct-port</b> specifies the UDP destination port for accounting requests to the server. To disable accounting for the server, set <b>acct-port</b> to 0. If the accounting port is missing, the default port number is 1813.
<code>&lt;0-65535&gt;</code>	UDP port number (default: 1813)

**Default** The default Authentication port number is 1812 and the default Accounting port number is 1813.

**Mode** Server Group Configuration

**Usage notes** The RADIUS server to be added must be configured by the **radius-server host** command. In order to add or remove a server, the **auth-port** and **acct-port** parameters in this command must be the same as the corresponding parameters in the **radius-server host** command.

**Examples** To create a RADIUS server group RAD\_AUTH1 for authentication, use the following commands:

```
awplus# configure terminal
awplus(config)# aaa group server radius RAD_AUTH1
awplus(config-sg)# server 192.168.1.1 acct-port 0
awplus(config-sg)# server 192.168.2.1 auth-port 1000 acct-port 0
```

To create a RADIUS server group RAD\_ACCT1 for accounting, use the following commands:

```
awplus# configure terminal
awplus(config)# aaa group server radius RAD_ACCT1
awplus(config-sg)# server 192.168.2.1 auth-port 0 acct-port 1001
awplus(config-sg)# server 192.168.3.1 auth-port 0
```

To remove server 192.168.3.1 from the existing server group **GROUP1**, use the following commands:

```
awplus# configure terminal
awplus(config)# aaa group server radius GROUP1
awplus(config-sg)# no server 192.168.3.1
```

**Related commands**

- [aaa accounting auth-mac](#)
- [aaa accounting auth-web](#)
- [aaa accounting dot1x](#)
- [aaa accounting login](#)
- [aaa authentication auth-mac](#)
- [aaa authentication auth-web](#)
- [aaa authentication login](#)
- [aaa group server](#)
- [radius-server host](#)

# show debugging radius

**Overview** This command displays the current debugging status for the RADIUS servers.

**Syntax** show debugging radius

**Mode** User Exec and Privileged Exec

**Example** To display the current debugging status of RADIUS servers, use the command:

```
awplus# show debugging radius
```

**Output** Figure 33-1: Example output from the **show debugging radius** command

```
RADIUS debugging status:  
RADIUS event debugging is off  
RADIUS packet debugging is off
```

# show radius

**Overview** This command displays the current RADIUS server configuration and status.

**Syntax** show radius

**Mode** User Exec and Privileged Exec

**Example** To display the current status of RADIUS servers, use the command:

```
awplus# show radius
```

**Output** Figure 33-2: Example output from the **show radius** command showing RADIUS servers

```
RADIUS Global Configuration
Source Interface : not configured
Secret Key : secret
Timeout : 5 sec
Retransmit Count : 3
Deadtime : 20 min
Server Host : 192.168.1.10
Authentication Port : 1812
Accounting Port : 1813
Secret Key : secret
Timeout : 3 sec
Retransmit Count : 2
Server Host : 192.168.1.11
Authentication Port : 1812
Accounting Port : not configured

Server Name/   Auth   Acct   Auth   Acct
IP Address    Port   Port   Status Status
-----
192.168.1.10  1812   1813   Alive  Alive
192.168.1.11  1812   N/A    Alive  N/A
```

**Example** See the sample output below showing RADIUS client status and RADIUS configuration:

```
awplus# show radius
```

**Output** Figure 33-3: Example output from the **show radius** command showing RADIUS client status

```

RADIUS global interface name: awplus
  Secret key:
  Timeout: 5
  Retransmit count: 3
  Deadtime: 0

Server Address: 150.87.18.89
  Auth destination port: 1812
  Accounting port: 1813
  Secret key: swg
  Timeout: 5
  Retransmit count: 3
  Deadtime: 0
show radius local-server group
  
```

Output Parameter	Meaning
Source Interface	The interface name or IP address to be used for the source address of all outgoing RADIUS packets.
Secret Key	A shared secret key to a radius server.
Timeout	A time interval in seconds.
Retransmit Count	The number of retry count if a RADIUS server does not response.
Deadtime	A time interval in minutes to mark a RADIUS server as "dead".
Interim-Update	A time interval in minutes to send Interim-Update Accounting report.
Group Deadtime	The deadtime configured for RADIUS servers within a server group.
Server Host	The RADIUS server hostname or IP address.
Authentication Port	The destination UDP port for RADIUS authentication requests.
Accounting Port	The destination UDP port for RADIUS accounting requests.

Output Parameter	Meaning
Auth Status	The status of the authentication port. The status ("dead", "error", or "alive") of the RADIUS authentication server and, if dead, how long it has been dead for.
	Alive      The server is alive.
	Error      The server is not responding.
	Dead      The server is detected as dead and it will not be used for deadtime period. The time displayed in the output shows the server is in dead status for that amount of time.
	Unknown    The server is never used or the status is unknown.
Acct Status	The status of the accounting port. The status ("dead", "error", or "alive") of the RADIUS accounting server and, if dead, how long it has been dead for.

# show radius statistics

**Overview** This command shows the RADIUS client statistics for the device.

**Syntax** show radius statistics

**Mode** User Exec and Privileged Exec

**Example** See the sample output below showing RADIUS client statistics and RADIUS configuration:

```
awplus# show radius statistics
```

**Output** Figure 33-4: Example output from the **show radius statistics** command:

```
RADIUS statistics for Server: 150.87.18.89
Access-Request Tx : 5 - Retransmit : 0
Access-Accept Rx : 1 - Access-Reject Rx : 2
Access-Challenge Rx : 2
Unknown Type : 0 - Bad Authenticator : 0
Malformed Access-Resp : 0 - Wrong Identifier : 0
Bad Attribute : 0 - Packet Dropped : 0
TimeOut : 0 - Dead count : 0
Pending Request : 0
```



# undebug radius

**Overview** This command applies the functionality of the **no debug radius** command.

# 34

# Local RADIUS Server Commands

## Introduction

**Overview** This chapter provides an alphabetical reference for commands used to configure the local RADIUS server on the device. For more information, see the [Local RADIUS Server Feature Overview and Configuration Guide](#).

- Command List**
- ["attribute"](#) on page 1268
  - ["authentication"](#) on page 1271
  - ["client \(radsecproxy-srv\)"](#) on page 1272
  - ["client mutual-authentication"](#) on page 1274
  - ["client name-check"](#) on page 1275
  - ["client trustpoint"](#) on page 1276
  - ["clear radius local-server statistics"](#) on page 1277
  - ["copy fdb-radius-users \(to file\)"](#) on page 1278
  - ["copy local-radius-user-db \(from file\)"](#) on page 1280
  - ["copy local-radius-user-db \(to file\)"](#) on page 1281
  - ["crypto pki enroll local \(deleted\)"](#) on page 1282
  - ["crypto pki enroll local local-radius-all-users \(deleted\)"](#) on page 1283
  - ["crypto pki enroll local user \(deleted\)"](#) on page 1284
  - ["crypto pki export local pem \(deleted\)"](#) on page 1285
  - ["crypto pki export local pkcs12 \(deleted\)"](#) on page 1286
  - ["crypto pki trustpoint local \(deleted\)"](#) on page 1287
  - ["debug crypto pki \(deleted\)"](#) on page 1288
  - ["domain-style"](#) on page 1289
  - ["egress-vlan-id"](#) on page 1290

- [“egress-vlan-name”](#) on page 1292
- [“group”](#) on page 1294
- [“nas”](#) on page 1295
- [“radius-secure-proxy local-server”](#) on page 1296
- [“radius-server local”](#) on page 1297
- [“server auth-port”](#) on page 1298
- [“server enable”](#) on page 1299
- [“show radius local-server group”](#) on page 1300
- [“show radius local-server nas”](#) on page 1301
- [“show radius local-server statistics”](#) on page 1302
- [“show radius local-server user”](#) on page 1303
- [“user \(RADIUS server\)”](#) on page 1305
- [“vlan \(RADIUS server\)”](#) on page 1307

# attribute

**Overview** Use this command to define a RADIUS attribute for the local RADIUS server user group.

For a complete list of defined RADIUS attributes and values, see the [Local RADIUS Server Feature Overview and Configuration Guide](#).

When used with the **help** parameter the **attribute** command displays a list of standard and vendor specific valid RADIUS attributes that are supported by the local RADIUS server.

If an attribute name is specified with the **help** parameter, then the **attribute** command displays a list of predefined attribute names. Note that you can only use the defined RADIUS attribute names and not define your own.

When used with the **value** parameter the **attribute** command configures RADIUS attributes to the user group. If the specified attribute is already defined then it is replaced with the new value.

Use the **no** variant of this command to delete an attribute from the local RADIUS server user group.

**Syntax**

```
attribute [<attribute-name>|<attribute-id>] help  
attribute {<attribute-name>|<attribute-id>} <value>  
no attribute {<attribute-name>|<attribute-id>}
```

Parameter	Description
<attribute-name>	RADIUS attribute name for standard attributes or Vendor-Specific attributes (see the <a href="#">Local RADIUS Server Feature Overview and Configuration Guide</a> for tables of attributes).
<attribute-id>	RADIUS attribute numeric identifier for standard attributes.
<value>	RADIUS attribute value.
help	Display a list of available attribute types.

**Default** By default, no attributes are configured.

**Mode** RADIUS Server Group Configuration

**Usage notes** For the Standard attributes, the attribute may be specified using either the attribute name, or its numeric identifier. For example, the command:

```
awplus(config-radsrv-group)# attribute acct-terminate-cause  
help
```

will produce the same results as the command:

```
awplus(config-radsrv-group)# attribute 49 help
```

In the same way, where the specific attribute has a pre-defined value, the parameter *<value>* may be substituted with the Value Name or with its numeric value, for example the command:

```
awplus(config-radsrv-group)# attribute acct-terminate-cause  
user-request
```

will produce the same results as the command:

```
awplus(config-radsrv-group)# attribute 49 1
```

or the command:

```
awplus(config-radsrv-group)# attribute acct-terminate-cause 1
```

**Examples** To check a list of all available defined RADIUS attribute names, use the following commands:

```
awplus# configure terminal  
awplus(config)# radius-server local  
awplus(config-radsrv)# group Admin  
awplus(config-radsrv-group)# attribute help
```

A list of Vendor-specific Attributes displays after the list of defined Standard Attributes.

To get help for valid RADIUS attribute values for the attribute *Service-Type*, use the following commands:

```
awplus# configure terminal  
awplus(config)# radius-server local  
awplus(config-radsrv)# group Admin  
awplus(config-radsrv-group)# attribute Service-Type help
```

This results in the following output:

```
Service-Type : integer (Integer number)  
  
Pre-defined values :  
  Administrative-User (6)  
  Authenticate-Only (8)  
  Authorize-Only (17)  
  Callback-Administrative (11)  
  Callback-Framed-User (4)  
  Callback-Login-User (3)  
  Callback-NAS-Prompt (9)  
  Call-Check (10)  
  Framed-User (2)  
  Login-User (1)  
  NAS-Prompt-User (7)  
  Outbound-User (5)
```

To define the attribute name 'Service-Type' with Administrative User (6) to the RADIUS User Group 'Admin', use the following commands:

```
awplus# configure terminal
awplus(config)# radius-server local
awplus(config-radsrv)# group Admin
awplus(config-radsrv-group)# attribute Service-Type 6
```

To delete the attribute 'Service-Type' from the RADIUS User Group 'Admin', use the following commands:

```
awplus# configure terminal
awplus(config)# radius-server local
awplus(config-radsrv)# group Admin
awplus(config-radsrv-group)# no attribute Service-Type
```

**Related commands**

- [egress-vlan-id](#)
- [egress-vlan-name](#)

# authentication

**Overview** Use this command to enable the specified authentication methods on the local RADIUS server.

Use the **no** variant of this command to disable specified authentication methods on the local RADIUS server.

**Syntax** authentication {mac | eapmd5 | eaptls | peap}  
no authentication {mac | eapmd5 | eaptls | peap}

Parameter	Description
mac	Enable MAC authentication method.
eapmd5	Enable EAP-MD5 authentication method.
eaptls	Enable EAP-TLS authentication method.
peap	Enable EAP-PEAP authentication method.

**Default** All authentication methods are enabled by default.

**Mode** RADIUS Server Configuration

**Examples** The following commands enable EAP-MD5 authentication methods on the local RADIUS server.

```
awplus# configure terminal
awplus(config)# radius-server local
awplus(config-radsrv)# authentication eapmd5
```

The following commands disable EAP-MD5 authentication methods on Local RADIUS server.

```
awplus# configure terminal
awplus(config)# radius-server local
awplus(config-radsrv)# no authentication eapmd5
```

**Related commands** [server enable](#)  
[show radius local-server statistics](#)

# client (radsecproxy-srv)

**Overview** Use this command to add a RadSec client (for example, a NAS device) to the RadSecProxy local-server application. The application will accept RADIUS requests from all configured clients.

Use the **no** variant of this command to delete a previously-configured client from the RadSecProxy local-server application.

**Syntax** `client {<hostname>|<ip-addr>} [name-check {on|off}]`  
`no client {<hostname>|<ip-addr>}`

Parameter	Description
<code>&lt;hostname&gt;</code>	Hostname of client.
<code>&lt;ip-addr&gt;</code>	Specify the client IPv4 address, in dotted decimal notation (A.B.C.D).
<code>name-check</code>	Specify whether or not to enforce certificate name checking for this client. If the parameter is not specified then the global behavior, which defaults to <b>on</b> , is used.
<code>on</code>	Enable name checking for this client.
<code>off</code>	Disable name checking for this client.

**Mode** RadSecProxy Local Server Configuration

**Usage notes** The client may be specified by its domain name or by its IPv4 address. If a domain name is used, it must be resolvable using a configured DNS name server.

Each client may be configured to use certificate name-checking; if not specified, the global behavior defined by **client name-check** or **no client name-check** will be used. If name checking is enabled, the Common Name portion of the subject field of the client's X.509 certificate must match the domain name or IP address specified in this command.

**NOTE:** *If mutual authentication is disabled then this parameter has no effect, see the [client mutual-authentication](#) command.*

**Example** To add a client called 'mynas.local' with certificate name checking **off**, use the commands:

```
awplus# configure terminal
awplus(config)# radius-secure-proxy local-server
awplus(config-radsecproxy-srv)# client mynas.local name-check
off
```

**Related commands** [client mutual-authentication](#)  
[client name-check](#)



client trustpoint  
radius-secure-proxy local-server

# client mutual-authentication

**Overview** This command enables or disables mutual certificate authentication for all RadSecProxy clients. When enabled, the RadSecProxy local-server application will request and validate an X.509 certificate from the client when establishing a connection.

The **no** variant of this command disables mutual certificate validation. The local-server application will still transmit the local server certificate to the client, but will not expect or validate a certificate from the client.

**Syntax** `client mutual-authentication`  
`no client mutual-authentication`

**Default** Mutual authentication is enabled by default.

**Mode** RadSecProxy Local Server Configuration

**Example** Disable mutual certificate validation with the following command:

```
awplus# configure terminal
awplus(config)# radius-secure-proxy local-server
awplus(config-radsecproxy-srv)# no client
mutual-authentication
```

**Related commands** [client \(radsecproxy-srv\)](#)  
[client name-check](#)  
[radius-secure-proxy local-server](#)

**Command changes** Version 5.4.6-2.1: command added

# client name-check

**Overview** This command sets the global behavior for certificate name-checking for the RadSecProxy localserver application to **on**. This behavior will be used for all clients associated with the application that do not specify a behavior on a per-client basis. If name-checking is enabled, the Common Name portion of the subject field of the client's X.509 certificate must match the domain name or IP address specified in the **client (radsecproxy-aaa)** command.

Use the **no** variant of this command to set the global behavior for certificate name checking to **off**

**Syntax** `client name-check`  
`no client name-check`

**Default** Certificate name checking is on by default.

**Mode** RadSecProxy Local Server Configuration

**Example** Disable certificate name checking globally with the following command:

```
awplus# configure terminal
awplus(config)# radius-secure-proxy local-server
awplus(config-radsecproxy-srv)# no client name-check
```

**Related commands** [client \(radsecproxy-srv\)](#)  
[client trustpoint](#)  
[radius-secure-proxy local-server](#)

# client trustpoint

**Overview** This command adds one or more trustpoints to be used with the RadSecProxy local-server application. Multiple trustpoints may be specified, or the command may be executed more than once, to add multiple trustpoints to the application.

The **no** version of this command removes one or more trustpoints from the list of trustpoints associated with the application.

**Syntax** `client trustpoint [<trustpoint-list>]`  
`no client trustpoint [<trustpoint-list>]`

Parameter	Description
<trustpoint-list>	Specify one or more trustpoints to be added or deleted.

**Mode** RadSecProxy Local Server Configuration

**Usage notes** The device certificate associated with first trustpoint added to the application will be transmitted to remote servers. The certificate received from the remote server must have an issuer chain that terminates with the root CA certificate for any of the trustpoints that are associated with the application.

If no trustpoints are specified in the command, the trustpoint list will be unchanged.

If **no client trustpoint** is issued without specifying any trustpoints, then all trustpoints will be disassociated from the application.

**Example** You can add multiple trustpoints to the RadSecProxy local-server by executing the command multiple times:

```
awplus# configure terminal
awplus(config)# radius-secure-proxy local-server
awplus(config-radsecproxy-srv)# client trustpoint example_1
awplus(config-radsecproxy-srv)# client trustpoint example_2
```

Alternatively, add multiple trustpoints with a single command:

```
awplus(config-radsecproxy-srv)# client trustpoint example_3
example_4
```

Disassociate all trustpoints from the RadSecProxy local-server application using the command:

```
awplus(config-radsecproxy-srv)# no client trustpoint
```

**Related commands** [client \(radsecproxy-srv\)](#)  
[client name-check](#)  
[radius-secure-proxy local-server](#)

# clear radius local-server statistics

**Overview** Use this command to clear the statistics stored on the device for the local RADIUS server.

Use this command without any parameters to clear all types of local RADIUS server statistics.

**Syntax** `clear radius local-server statistics [nas|server|user]`

Parameter	Description
nas	Clear the NAS (Network Access Server) statistics on the device. For example, clearing statistics stored for NAS server invalid passwords.
server	Clear the Local RADIUS Server statistics on the device. For example, clearing Local RADIUS Servers statistics for all failed login attempts.
user	Clear the Local RADIUS Server user statistics. For example, clearing statistics stored for the number of successful user logins.

**Mode** Privileged Exec

**Usage** Refer to the sample output for the [show radius local-server statistics](#) for further information about the type of statistics each parameter option for this command clears. Both the **nas** and **server** parameters clear unknown username and invalid passwords statistics, while the **user** parameter clears the number of successful and failed logins for each local RADIUS server user.

**Examples** To clear the NAS (Network Access Server) statistics stored on the device, use the command:

```
awplus# clear radius local-server statistics nas
```

To clear the local RADIUS server statistics stored on the device, use the command:

```
awplus# clear radius local-server statistics server
```

To clear the local RADIUS server user statistics stored on the device, use the command:

```
awplus# clear radius local-server statistics user
```

**Related commands** [show radius local-server statistics](#)

# copy fdb-radius-users (to file)

**Overview** Use this command to create a set of local RADIUS server users from MAC addresses in the local FDB. A local RADIUS server user created using this command can be used for MAC authentication.

**Syntax** `copy fdb-radius-users  
{local-radius-user-db|flash|card|debug|tftp|scp|  
fserver|<url>} [interface <port>] [vlan <vid>] [group <name>]  
[export-vlan [<radius-group-name>]]`

Parameter	Description
local-radius-user-db	Copy the local RADIUS server users created to the local RADIUS server.
flash	Copy the local RADIUS server users created to Flash memory.
card	Copy the local RADIUS server users created to SD card.
debug	Copy the local RADIUS server users created to debug.
tftp	Copy the local RADIUS server users created to the TFTP destination.
scp	Copy the local RADIUS server users created to the SCP destination.
fserver	Copy the local RADIUS server users created to the remote file server.
<url>	Copy the local RADIUS server users created to the specified URL.
interface <port>	Copy only MAC addresses learned on a specified device port. Wildcards may be used when specifying an interface name.
vlan <vid>	Copy only MAC addresses learned on a specified VLAN.
group <name>	Assign a group name to the local RADIUS server users created.
export-vlan	Export VLAN ID assigned to exported FDB entry.
<radius-group-name>	Prefix for Radius group name storing VLAN ID

**Mode** Privileged Exec

**Usage notes** The local RADIUS server users created are written to a specified destination file in local RADIUS user CSV (Comma Separated Values) format. The local RADIUS server users can then be imported to a local RADIUS server using the [copy local-radius-user-db \(from file\)](#) command.

The name and password of the local RADIUS server users created use a MAC address, which can be used for MAC authentication.

This command does not copy a MAC address learned by the CPU or the management port.

This command can filter FDB entries by the interface name and the VLAN ID. When the interface name and the VLAN ID are specified, this command generates local RADIUS server users from only the MAC address learned on the specified interface and on the specified VLAN.

**Examples** To register the local RADIUS server users from the local FDB directly to the local RADIUS server, use the command:

```
awplus# copy fdb-radius-users local-radius-user-db
```

To register the local RADIUS server users from the interface port1.0.1 to the local RADIUS server, use the command:

```
awplus# copy fdb-radius-users local-radius-user-db interface port1.0.1
```

To copy output generated as local RADIUS server user data from MAC addresses learned on vlan10 on interface port1.0.1 to the file radius-user.csv, use the command:

```
awplus# copy fdb-radius-users radius-user.csv interface port1.0.1 vlan10
```

To copy output generated as local RADIUS server user data from MAC addresses learned on vlan10 on interface port1.0.1 to a file on the remote file server, use the command:

```
awplus# copy fdb-radius-users fserver interface port1.0.1 vlan10
```

**Related commands** [copy local-radius-user-db \(to file\)](#)  
[copy local-radius-user-db \(from file\)](#)

# copy local-radius-user-db (from file)

**Overview** Use this command to copy the Local RADIUS server user data from a file. The file, including the RADIUS user data in the file, must be in the CSV (Comma Separated Values) format.

You can select **add** or **replace** as the copy method. The **add** parameter option copies the contents of specified file to the local RADIUS server user database. If the same user exists then the old user is removed before adding a new user. The **replace** parameter option deletes all contents of the local RADIUS server user database before copying the contents of specified file.

**Syntax** `copy <source-url> local-radius-user-db [add|replace]`

Parameter	Description
<code>&lt;source-url&gt;</code>	URL of the source file.
<code>add</code>	Add file contents to local RADIUS server user database.
<code>replace</code>	Replace current local RADIUS server user database with file contents.

**Default** When no copy method is specified with this command the **replace** option is applied.

**Mode** Privileged Exec

**Examples** To replace the current local RADIUS server user data to the contents of `http://datahost/user.csv`, use the following command:

```
awplus# copy http://datahost/user.csv local-radius-user-db
```

To add the contents of `http://datahost/user.csv` to the current local RADIUS server user database, use the following command:

```
awplus# copy http://datahost/user.csv local-radius-user-db add
```

**Related commands** [copy fdb-radius-users \(to file\)](#)  
[copy local-radius-user-db \(to file\)](#)



# copy local-radius-user-db (to file)

**Overview** Use this command to copy the local RADIUS server user data to a file. The output file produced is CSV (Comma Separated Values) format.

**Syntax** `copy local-radius-user-db  
{flash|card|tftp|scp|<destination-url>}`

Parameter	Description
flash	Copy to Flash memory.
card	Copy to SD card.
tftp	Copy to TFTP destination.
scp	Copy to SCP destination.
<destination-url>	URL of the Destination file.

**Mode** Privileged Exec

**Example** Copy the current local RADIUS server user data to http://datahost/user.csv.  
`awplus# copy local-radius-user-db http://datahost/user.csv`

**Related commands** [copy fdb-radius-users \(to file\)](#)  
[copy local-radius-user-db \(from file\)](#)

# crypto pki enroll local (deleted)

**Overview** This command is no longer available. Please use the following command instead:

```
crypto pki enroll <trustpoint>
```

Note that “local” is a valid name for a trustpoint, so you do not need to modify existing configurations or scripts.

# crypto pki enroll local local-radius-all-users (deleted)

**Overview** This command is no longer available. Please use the following command instead:

```
crypto pki enroll <trustpoint> local-radius-all-users
```

Note that "local" is a valid name for a trustpoint, so you do not need to modify existing configurations or scripts.

# crypto pki enroll local user (deleted)

**Overview** This command is no longer available. Please use the following command instead:

```
crypto pki enroll <trustpoint> user <username>
```

Note that “local” is a valid name for a trustpoint, so you do not need to modify existing configurations or scripts.

# crypto pki export local pem (deleted)

**Overview** This command is no longer available. Please use the [crypto pki export pem](#) command instead:

```
crypto pki export <trustpoint> pem [terminal|<url>]
```

Note that "local" is a valid name for a trustpoint, so you do not need to modify existing configurations or scripts.

# crypto pki export local pkcs12 (deleted)

**Overview** This command is no longer available. Please use the [crypto pki export pkcs12](#) command instead:

```
crypto pki export <trustpoint> pkcs12 {ca|server|<username>}  
<url>
```

Note that "local" is a valid name for a trustpoint, so you do not need to modify existing configurations or scripts.

# crypto pki trustpoint local (deleted)

**Overview** This command is no longer available. Please use the following command instead:

```
crypto pki trustpoint <trustpoint>
```

Note that "local" is a valid name for a trustpoint, so you do not need to modify existing configurations or scripts.

# debug crypto pki (deleted)

**Overview** This command is no longer available.



# domain-style

**Overview** Use this command to enable a specified domain style on the local RADIUS server. The local RADIUS server decodes the domain portion of a username login string when this command is enabled.

Use the **no** variant of this command to disable the specified domain style on the local RADIUS server.

**Syntax** `domain-style {suffix-atsign|ntdomain}`  
`no domain-style {suffix-atsign|ntdomain}`

Parameter	Description
<code>suffix-atsign</code>	Enable at sign "@" delimited suffix style, i.e. "user@domain".
<code>ntdomain</code>	Enable NT domain style, i.e. "domain\user".

**Default** This feature is disabled by default.

**Mode** RADIUS Server Configuration

**Usage notes** When both domain styles are enabled, the first domain style configured has the highest priority. A username login string is matched against the first domain style enabled. Then, if the username login string is not decoded, it is matched against the second domain style enabled.

**Examples** To enable NT domain style on the local RADIUS server, use the commands:

```
awplus# configure terminal
awplus(config)# radius-server local
awplus(config-radsrv)# domain-style ntdomain
```

To disable NT domain style on the local RADIUS server, use the commands:

```
awplus# configure terminal
awplus(config)# radius-server local
awplus(config-radsrv)# no domain-style ntdomain
```

**Related commands** [server enable](#)

# egress-vlan-id

**Overview** Use this command to configure the standard RADIUS attribute “Egress-VLANID (56)” for the local RADIUS Server user group.

Use the **no** variant of this command to remove the Egress-VLANID attribute from the local RADIUS server user group.

**Syntax** `egress-vlan-id <vid> [tagged|untagged]`  
`no egress-vlan-id`

Parameter	Description
<vid>	The VLAN identifier to be used for the Egress VLANID attribute, in the range 1 to 4094.
tagged	Set frames on the VLAN as tagged. This sets the tag indication field to indicate that all frames on this VLAN are tagged.
untagged	Set all frames on the VLAN as untagged. This sets the tag indication field to indicate that all frames on this VLAN are untagged.

**Default** By default, no Egress-VLANID attributes are configured.

**Mode** RADIUS Server Group Configuration

**Usage** When a Voice VLAN is configured for dynamic VLAN allocation ([switchport voice vlan](#) command), the RADIUS server must be configured to send the VLAN information when an IP phone is successfully authenticated. Use either the [egress-vlan-id](#) command or the [egress-vlan-name](#) command, and specify the **tagged** parameter.

**Examples** To set the “Egress-VLANID” attribute for the *NormalUsers* local RADIUS server user group to VLAN identifier 200, with tagged frames, use the commands:

```
awplus# configure terminal
awplus(config)# radius-server local
awplus(config-radsrv)# group NormalUsers
awplus(config-radsrv-group)# egress-vlan-id 200 tagged
```

To remove the “Egress-VLANID” attribute for the *NormalUsers* local RADIUS server user group, use the commands:

```
awplus# configure terminal
awplus(config)# radius-server local
awplus(config-radsrv)# group NormalUsers
awplus(config-radsrv-group)# no egress-vlan-id
```

**Related commands** attribute  
egress-vlan-name  
switchport voice vlan

# egress-vlan-name

**Overview** Use this command to configure the standard RADIUS attribute "Egress-VLAN-Name (58)" for the local RADIUS server user group.

Use the **no** variant of this command to remove the Egress-VLAN-Name attribute from the local RADIUS server user group.

**Syntax** `egress-vlan-name <vlan-name> [tagged|untagged]`  
`no egress-vlan-name`

Parameter	Description
<code>&lt;vlan-name&gt;</code>	The VLAN name to be configured as the Egress-VLAN-Name attribute.
<code>tagged</code>	Set frames on the VLAN as tagged. This sets the tag indication field to indicate that all frames on this VLAN are tagged.
<code>untagged</code>	Set all frames on the VLAN as untagged. This sets the tag indication field to indicate that all frames on this VLAN are untagged.

**Default** By default, no Egress-VLAN-Name attributes are configured.

**Mode** RADIUS Server Group Configuration

**Usage** When a Voice VLAN is configured for dynamic VLAN allocation ([switchport voice vlan](#) command), the RADIUS server must be configured to send the VLAN information when an IP phone is successfully authenticated. Use either the [egress-vlan-id](#) command or the [egress-vlan-name](#) command, and specify the **tagged** parameter.

**Examples** To configure the "Egress-VLAN-Name" attribute for the RADIUS server user group *NormalUsers* with the VLAN name *vlan2* and all frames on this VLAN tagged, use the commands:

```
awplus# configure terminal
awplus(config)# radius-server local
awplus(config-radsrv)# group NormalUsers
awplus(config-radsrv-group)# egress-vlan-name vlan2 tagged
```

To delete the "Egress-VLAN-Name" attribute for the *NormalUsers* group, use the commands:

```
awplus# configure terminal
awplus(config)# radius-server local
awplus(config-radsrv)# group NormalUsers
awplus(config-radsrv-group)# no egress-vlan-name
```

**Related  
commands**    attribute  
                  egress-vlan-id  
                  switchport voice vlan

# group

**Overview** Use this command to create a local RADIUS server user group, and enter local RADIUS Server User Group Configuration mode.

Use the **no** variant of this command to delete the local RADIUS server user group.

**Syntax** `group <user-group-name>`  
`no group <user-group-name>`

Parameter	Description
<code>&lt;user-group-name&gt;</code>	User group name string.

**Mode** RADIUS Server Configuration

**Examples** The following command creates the user group NormalUsers.

```
awplus# configure terminal
awplus(config)# radius-server local
awplus(config-radsrv)# group NormalUsers
```

The following command deletes user group NormalUsers.

```
awplus# configure terminal
awplus(config)# radius-server local
awplus(config-radsrv)# no group NormalUsers
```

**Related commands** [user \(RADIUS server\)](#)  
[show radius local-server user](#)  
[vlan \(RADIUS server\)](#)

# nas

**Overview** This command adds a client device (the Network Access Server or the NAS) to the list of devices that are able to send authentication requests to the local RADIUS server. The NAS is identified by its IP address and a shared secret (also referred to as a shared key) must be defined that the NAS will use to establish its identity.

Use the **no** variant of this command to remove a NAS client from the list of devices that are allowed to send authentication requests to the local RADIUS server.

**Syntax** `nas <ip-address> key <nas-keystring>`  
`no nas <ip-address>`

Parameter	Description
<code>&lt;ip-address&gt;</code>	RADIUS NAS IP address.
<code>&lt;nas-keystring&gt;</code>	NAS shared keystring.

**Mode** RADIUS Server Configuration

**Examples** The following commands add the NAS with an IP address of 192.168.1.2 to the list of clients that may send authentication requests to the local RADIUS server. Note the shared key that this NAS will use to establish its identify is NAS\_PASSWORD.

```
awplus# configure terminal
awplus(config)# radius-server local
awplus(config-radsrv)# nas 192.168.1.2 key NAS_PASSWORD
```

The following commands remove the NAS with an IP address of 192.168.1.2 from the list of clients that are allowed to send authentication requests to the local RADIUS server:

```
awplus# configure terminal
awplus(config)# radius-server local
awplus(config-radsrv)# no nas 192.168.1.2
```

**Related commands** [show radius local-server nas](#)

# radius-secure-proxy local-server

**Overview** Use this command to enter the RadSecProxy local-server application configuration mode. This application allows remote RadSec clients to communicate with the local RADIUS server process via a secure (TLS) proxy.

**Syntax** `radius-secure-proxy local-server`

**Mode** Global Configuration Mode

**Example** To change mode from User Exec mode to the RadSecProxy local-server configuration mode, use the commands:

```
awplus# configure terminal
awplus(config)# radius-secure-proxy local-server
awplus(config-radsecproxy-srv)#
```

**Related commands**

- [client \(radsecproxy-srv\)](#)
- [client name-check](#)
- [client trustpoint](#)



# radius-server local

**Overview** Use this command to navigate to the Local RADIUS server configuration mode (`config-radsrv`) from the Global Configuration mode (`config`).

**Syntax** `radius-server local`

**Mode** Global Configuration

**Example** Local RADIUS Server commands are available from `config-radsrv` configuration mode. To change mode from User Exec mode to the Local RADIUS Server mode (`config-radsrv`), use the commands:

```
awplus# configure terminal
awplus(config)# radius-server local
awplus(config-radsrv)#
```

## Output

```
awplus(config)#radius-server local
Creating Local CA repository.....OK
Enrolling Local System to local trustpoint..OK
awplus(config-radsrv)#
```

**Related commands**

- [server enable](#)
- [show radius local-server group](#)
- [show radius local-server nas](#)
- [show radius local-server statistics](#)
- [show radius local-server user](#)

# server auth-port

**Overview** Use this command to change the UDP port number for local RADIUS server authentication.

Use the **no** variant of this command to reset the RADIUS server authentication port back to the default.

**Syntax** `server auth-port <1-65535>`  
`no server auth-port`

Parameter	Description
<1-65535>	UDP port number.

**Default** The default local RADIUS server UDP authentication port number is 1812.

**Mode** RADIUS Server Configuration

**Examples** The following commands set the RADIUS server authentication port to 10000.

```
awplus# configure terminal
awplus(config)# radius-server local
awplus(config-radsrv)# server auth-port 10000
```

The following commands reset the RADIUS server authentication port back to the default UDP port of 1812.

```
awplus# configure terminal
awplus(config)# radius-server local
awplus(config-radsrv)# no server auth-port
```

**Related commands** [server enable](#)  
[show radius local-server statistics](#)

# server enable

**Overview** This command enables the local RADIUS server. The local RADIUS server feature is started immediately when this command is issued.

The **no** variant of this command disables local RADIUS server. When this command is issued, the local RADIUS server stops operating.

**Syntax** `server enable`  
`no server enable`

**Default** The local RADIUS server is disabled by default and must be enabled for use with this command.

**Mode** RADIUS Server Configuration

**Examples** To enable the local RADIUS server, use the following commands:

```
awplus# configure terminal
awplus(config)# radius-server local
awplus(config-radsrv)# server enable
```

To disable the local RADIUS server, use the command:

```
awplus# configure terminal
awplus(config)# radius-server local
awplus(config-radsrv)# no server enable
```

**Related commands** [server auth-port](#)  
[show radius local-server statistics](#)

# show radius local-server group

**Overview** Use this command to display information about the local RADIUS server user group.

For information on filtering and saving command output, see the [“Getting Started with AlliedWare Plus” Feature Overview and Configuration Guide](#).

**Syntax** `show radius local-server group [<user-group-name>]`

Parameter	Description
<user-group-name>	User group name string.

**Mode** User Exec and Privileged Exec

**Example** The following command displays Local RADIUS server user group information.

```
awplus# show radius local-server group
```

## Output

**Table 1:** Example output from the **show radius local-server group** command

Group-Name	Vlan
-----	
NetworkOperators	ManagementNet
NormalUsers	CommonNet

**Table 2:** Parameters in the output of the **show radius local-server group** command

Parameter	Description
Group-Name	Group name.
Vlan	VLAN name assigned to the group.

**Related commands** [group](#)

# show radius local-server nas

**Overview** Use this command to display information about NAS (Network Access Servers) registered to the local RADIUS server.

For information on filtering and saving command output, see the [“Getting Started with AlliedWare Plus” Feature Overview and Configuration Guide](#).

**Syntax** `show radius local-server nas [<ip-address>]`

Parameter	Description
<ip-address>	Specify NAS IP address for show output.

**Mode** User Exec and Privileged Exec

**Example** The following command displays NAS information.

```
awplus# show radius local-server nas
```

## Output

**Table 3:** Example output from the **show radius local-server nas** command

NAS-Address	Shared-Key
127.0.0.1	awplus-local-radius-server

**Table 4:** Parameters in the output of the **show radius local-server nas** command

Parameter	Description
NAS-Address	IP address of NAS.
Shared-Key	Shared key used for RADIUS connection.

**Related commands** `nas`

# show radius local-server statistics

**Overview** Use this command to display statistics about the local RADIUS server.

For information on filtering and saving command output, see the [“Getting Started with AlliedWare Plus” Feature Overview and Configuration Guide](#).

**Syntax** show radius local-server statistics

**Mode** User Exec and Privileged Exec

**Usage notes** Both unknown usernames and invalid passwords will display as failed logins in the show output.

**Example** The following command displays Local RADIUS server statistics.

```
awplus# show radius local-server statistics
```

## Output

**Table 5:** Example output from the **show radius local-server statistics** command

```
Server status : Run (administrative status is enable)
Enabled methods: MAC EAP-MD5 EAP-TLS EAP-PEAP

Successes :1 Unknown NAS :0
Failed Logins :0 Invalid packet from NAS :0
Internal Error :0 Unknown Error :0

NAS : 127.0.0.1
Successes :0 Shared key mismatch :0
Failed Logins :0 Unknown RADIUS message :0
Unknown EAP message :0 Unknown EAP auth type :0
Corrupted packet :0

NAS : 192.168.1.61
Successes :0 Shared key mismatch :0
Failed Logins :0 Unknown RADIUS message :0
Unknown EAP message :0 Unknown EAP auth type :0
Corrupted packet :0

Username Successes Failures
a 1 0
admin 0 0
```

**Related commands**

- [clear radius local-server statistics](#)
- [radius-server local](#)
- [server enable](#)
- [server auth-port](#)

# show radius local-server user

**Overview** Use this command to display information about the local RADIUS server user.

For information on filtering and saving command output, see the [“Getting Started with AlliedWare Plus” Feature Overview and Configuration Guide](#).

**Syntax**

```
show radius local-server user [<user-name>]  
show radius local-server user [<user-name>] format csv  
show radius local-server user [<user-name>] detail
```

Parameter	Description
<user-name>	RADIUS user name. If no user name is specified, information for all users is displayed.
format csv	Format output as CSV.
detail	Display detailed information about the user.

**Mode** User Exec and Privileged Exec

**Examples** The following command displays Local RADIUS server user information for user Tom.

```
awplus# show radius local-server user Tom
```

**Table 6:** Example output from the **show radius local-server user** command

User-Name	Password	Group	Vlan
Tom	abcd	NetworkOperators	ManagementNet

The following command displays all Local RADIUS server information for all users.

```
awplus# show radius local-server user
```

The following command displays Local RADIUS server user information for Tom in CSV format.

```
awplus# show radius local-server user Tom format csv
```

**Table 7:** Example output from the **show radius local-server user Tom format csv** command

true,"NetworkOperators","Tom","abcd",0,2099/01/01,1,"","","ManagementNet",false,3600,false,0,"",false,"
---

The following command displays detailed Local RADIUS server user information for all users.

```
awplus# show radius local-server detail
```

**Table 8:** Example output from the **show radius local-server detail** command

```
awplus# show radius local-server user detail
-----
Username   : 00-00-cd-38-00-68
Password   : mssv+c7URUgtfltKy46Rt0VgPefRdihWOXEUEcM8Bw=
Group      : GroupName
Vlan       : VlanName
Username   : Tom:port1.0.5:00-00-cd-38-00-68
Password   : 0cVvLd4+oyQlO2eckFXtV9d9JO/lXbqlDiRvyTOd+Wk=
Group      : GroupName
Vlan       : VlanName
```

**Table 9:** Parameters in the output from the **show radius local-server user** command

Parameter	Description
User-Name	User name.
Password	User password.
Group	Group name assigned to the user.
Vlan	VLAN name assigned to the user.

**Related commands**

group  
user (RADIUS server)

**Command changes**

Version 5.4.9-0.1: **detail** parameter added



# user (RADIUS server)

**Overview** Use this command to register a user to the local RADIUS server.  
Use the **no** variant of this command to delete a user from the local RADIUS server.

**Syntax** `user <radius-user-name> [encrypted] password <user-password>  
[group <user-group>]`  
`no user <radius-user-name>`

Parameter	Description
<code>&lt;radius-user-name&gt;</code>	RADIUS user name. This can also be a MAC address in the IEEE standard format of HH-HH-HH-HH-HH-HH if you are configuring MAC authentication to use local RADIUS server.
<code>encrypted</code>	Specifies that the password is being entered in its encrypted form, so that it is not further encrypted. When creating a new user, enter the password in plaintext, and do not use the <b>encrypted</b> parameter. Use the <b>encrypted</b> parameter only when referring to a user that has previously been created. For instance, when adding an existing user from another RADIUS server, use the <b>encrypted</b> parameter, and enter the encrypted version of the password that appears in the output of <b>show</b> commands for the user.
<code>&lt;user-password&gt;</code>	User password. This can also be a MAC address in the IEEE standard format of HH-HH-HH-HH-HH-HH if you are configuring MAC authentication to use local RADIUS server.
<code>group</code>	Specify the group for the user.
<code>&lt;user-group&gt;</code>	User group name.

**Mode** RADIUS Server Configuration

**Usage notes** RADIUS user names cannot contain question mark (?), space ( ), or quote (" ") characters. RADIUS user names containing the below characters cannot use certificate authentication:

`/ \ '$ &()*!< > `|`

Certificates cannot be created and exported for RADIUS user names that contain the above characters. We advise you to avoid using these characters in RADIUS user names if you need to use certificate authentication, because you will not be able to create and export certificates.

You also can use the IEEE standard format hexadecimal notation (HH-HH-HH-HH-HH-HH) to specify a supplicant MAC address to configure the user name and user password parameters to use local RADIUS server for MAC Authentication. See the [AAA and Port\\_Authentication Feature Overview and Configuration\\_Guide](#) for a sample MAC configuration. See also the command **user**

**00-db-59-ab-70-37 password 00-db-59-ab-70-37** as shown in the command examples.

**Examples** The following commands add user "Tom" to the local RADIUS server and sets his password to "QwerSD".

```
awplus# configure terminal
awplus(config)# radius-server local
awplus(config-radsrv)# user Tom password QwerSD
```

The following commands add user "Tom" to the local RADIUS server user group "NormalUsers" and sets his password "QwerSD".

```
awplus# configure terminal
awplus(config)# radius-server local
awplus(config-radsrv)# user Tom password QwerSD group
NormalUsers
```

The following commands remove user "Tom" from the local RADIUS server:

```
awplus# configure terminal
awplus(config)# radius-server local
awplus(config-radsrv)# no user Tom
```

The following commands add the supplicant MAC address 00-d0-59-ab-70-37 to the local RADIUS server:

```
awplus# configure terminal
awplus(config)# radius-server local
awplus(config-radsrv)# user 00-db-59-ab-70-37 password
00-db-59-ab-70-37
```

The following commands remove the supplicant MAC address 00-d0-59-ab-70-37 from the local RADIUS server:

```
awplus# configure terminal
awplus(config)# radius-server local
awplus(config-radsrv)# no user 00-db-59-ab-70-37
```

**Related commands** [group](#)  
[show radius local-server user](#)

## vlan (RADIUS server)

**Overview** Use this command to set the VLAN ID or name for the local RADIUS server user group. The VLAN information is used for authentication with the dynamic VLAN feature.

Use the **no** variant of this command to clear the VLAN ID or VLAN name for the local RADIUS server user group.

**Syntax** `vlan {<vid>|<vlan-name>}`  
`no vlan`

Parameter	Description
<code>&lt;vid&gt;</code>	VLAN ID.
<code>&lt;vlan-name&gt;</code>	VLAN name.

**Default** VLAN information is not set by default.

**Mode** RADIUS Server Group Configuration

**Examples** The following commands set VLAN ID 200 to the group named *NormalUsers*:

```
awplus# configure terminal
awplus(config)# radius-server local
awplus(config-radsrv)# group NormalUsers
awplus(config-radsrv-group)# vlan 200
```

The following commands remove VLAN ID 200 from the group named *NormalUsers*:

```
awplus# configure terminal
awplus(config)# radius-server local
awplus(config-radsrv)# group NormalUsers
awplus(config-radsrv-group)# no vlan
```

**Related commands** [group](#)  
[show radius local-server user](#)

# 35

# Public Key Infrastructure Commands

## Introduction

**Overview** This chapter provides an alphabetical reference of commands used to configure the Public Key Infrastructure (PKI) capabilities on an AlliedWare Plus device. For more information about PKI, see the [Public Key Infrastructure \(PKI\) Feature Overview and Configuration Guide](#).

- Command List**
- [“crypto key generate rsa”](#) on page 1309
  - [“crypto key zeroize”](#) on page 1310
  - [“crypto pki authenticate”](#) on page 1311
  - [“crypto pki enroll”](#) on page 1312
  - [“crypto pki enroll user”](#) on page 1313
  - [“crypto pki export pem”](#) on page 1315
  - [“crypto pki export pkcs12”](#) on page 1316
  - [“crypto pki import pem”](#) on page 1318
  - [“crypto pki import pkcs12”](#) on page 1320
  - [“crypto pki trustpoint”](#) on page 1321
  - [“enrollment \(ca-trustpoint\)”](#) on page 1322
  - [“fingerprint \(ca-trustpoint\)”](#) on page 1323
  - [“no crypto pki certificate”](#) on page 1325
  - [“rsakeypair \(ca-trustpoint\)”](#) on page 1326
  - [“show crypto key mypubkey rsa”](#) on page 1327
  - [“show crypto pki certificates”](#) on page 1328
  - [“show crypto pki enrollment user”](#) on page 1330
  - [“show crypto pki trustpoint”](#) on page 1331
  - [“subject-name \(ca-trustpoint\)”](#) on page 1332

# crypto key generate rsa

**Overview** Use this command to generate a cryptographic public/private key pair for the Rivest-Shamir-Adleman (RSA) encryption algorithm.

**Syntax** `crypto key generate rsa [label <keylabel>] [<1024-4096>]`

Parameter	Description
<keylabel>	The name of the key to be created. The name must start with an alphanumeric character, and may only contain alphanumeric characters, underscores, dashes, or periods. The maximum length of the name is 63 characters. If no label is specified the default value "server-default" is used.
<1024-4096>	The bit length for the key. If no bit length is specified the default of 2048 is used.

**Mode** Privileged Exec

**Usage notes** The generated key may be used for multiple server certificates in the system. A key is referenced by its label. A bit length between 1024 and 4096 bits may be specified. Larger bit lengths are more secure, but require more computation time. The specified key must not already exist.

**Example** To create a key with the label "example-server-key" and a bit length of 2048, use the commands:

```
awplus> enable  
awplus# crypto key generate rsa label example-server-key 2048
```

**Related commands** [crypto key zeroize](#)  
[rsakeypair \(ca-trustpoint\)](#)  
[show crypto key mypubkey rsa](#)

# crypto key zeroize

**Overview** Use this command to delete one or all cryptographic public/private key pairs.

**Syntax** `crypto key zeroize rsa <keylabel>`  
`crypto key zeroize all`

Parameter	Description
<code>rsa &lt;keylabel&gt;</code>	Delete a single key pair for the Rivest-Shamir-Adleman (RSA) encryption algorithm.
<code>all</code>	Delete all keys.

**Mode** Privileged Exec

**Usage notes** Note that this command has the same effect as using the **delete** command (it deletes the file from Flash memory but does not overwrite it with zeros).

The specified key must exist but must not be in use for any existing server certificates.

A key may not be deleted if it is associated with the server certificate or server certificate signing request for an existing trustpoint. To remove a server certificate so that the key may be deleted, use the **no crypto pki enroll** command to de-enroll the server.

**Example** To delete an RSA key named "example-server-key", use the following command:

```
awplus# crypto key zeroize rsa example-server-key
```

**Related commands** [crypto key generate rsa](#)  
[show crypto key mypubkey rsa](#)

**Command changes** Version 5.4.6-1.1: zeroize functionality added to x930 Series  
Version 5.4.8-1.2: zeroize functionality added to x220, XS900MX, x550 Series  
Version 5.4.8-2.1: zeroize functionality added to SBx908 GEN2, x950 Series

# crypto pki authenticate

**Overview** Use this command to authenticate a trustpoint by generating or importing the root CA certificate. This must be done before the server can be enrolled to the trustpoint.

**Syntax** `crypto pki authenticate <trustpoint>`

Parameter	Description
<code>&lt;trustpoint&gt;</code>	The name of the trustpoint to be authenticated.

**Mode** Privileged Exec

**Usage notes** If the trustpoint's **enrollment** setting is "selfsigned", then this command causes a private key to be generated for the root CA, and a self-signed certificate to be generated based on that key.

If the trustpoint's **enrollment** setting is "terminal", then this command prompts the user to paste a certificate Privacy Enhanced Mail (PEM) file at the CLI terminal. If the certificate is a valid selfsigned CA certificate, then it will be stored as the trustpoint's root CA certificate.

The specified trustpoint must already exist, and its enrollment mode must have been defined.

**Example** To show the **enrollment** setting of a trustpoint named "example" and then generate a certificate from it, use the commands:

```
awplus> enable
awplus# configure terminal
awplus(config)# crypto pki trustpoint example
awplus(ca-trustpoint)# enrollment selfsigned
awplus(config)# exit
awplus# exit
awplus# crypto pki authenticate example
```

**Related commands**

- [crypto pki import pem](#)
- [crypto pki trustpoint](#)
- [enrollment \(ca-trustpoint\)](#)

# crypto pki enroll

**Overview** Use this command to enroll the local server to the specified trustpoint.  
Use the **no** variant of this command to de-enroll the server by removing its certificate

**Syntax** `crypto pki enroll <trustpoint>`  
`no crypto pki enroll <trustpoint>`

Parameter	Description
<code>&lt;trustpoint&gt;</code>	The name of the trustpoint to be enrolled

**Mode** Privileged Exec

**Usage notes** For the local server, “enrollment” is the process of creating of a certificate for the server that has been signed by a CA associated with the trustpoint. The public portion of the RSA key pair specified using the `rsa` parameter for the trustpoint will be included in the server certificate.

If the trustpoint represents a locally self-signed certificate authority, then this command results in the direct generation of the server certificate, signed by the root CA for the trustpoint.

If the trustpoint represents an external certificate authority, then this command results in the generation of a Certificate Signing Request (CSR) file, which is displayed at the terminal in Privacy-Enhanced Mail (PEM) format, suitable for copying and pasting into a file or message. The CSR must be sent to the external CA for processing. When the CA replies with the signed certificate, that certificate should be imported using the `crypto pki import pem` command, to complete the enrollment process.

The specified trustpoint must already exist, and it must already be authenticated.

**Example** To enroll the local server with the trustpoint “example”, use the following commands:

```
awplus> enable  
awplus# crypto pki enroll example
```

**Related commands** [crypto pki enroll user](#)  
[crypto pki import pem](#)  
[crypto pki trustpoint](#)  
[enrollment \(ca-trustpoint\)](#)



# crypto pki enroll user

**Overview** Use this command to enroll a single RADIUS user or all RADIUS users to the specified trustpoint.

Use the **no** variant of this command to remove the PKCS#12 file from the system. Note that the PKCS#12 files are generated in a temporary (volatile) file system, so a system restart also results in removal of all of the files.

**Syntax**

```
crypto pki enroll <trustpoint>
{user <username>|local-radius-all-users}

no crypto pki enroll <trustpoint>
{user <username>|local-radius-all-users}
```

Parameter	Description
<trustpoint>	The name of the trustpoint to which users are to be enrolled.
<username>	The name of the user to enroll to the trustpoint.

**Mode** Privileged Exec

**Usage notes** For RADIUS users, “enrollment” is the process of generating a private key and a corresponding client certificate for each user, with the certificate signed by the root CA for the trustpoint. The resulting certificates may be exported to client devices, for use with PEAP or EAP-TLS authentication with the local RADIUS server.

The specified trustpoint must represent a locally self-signed certificate authority.

The private key and certificate are packaged into a PKCS#12-formatted file, suitable for export using the **crypto pki export pkcs12** command. The private key is encrypted for security, with a passphrase that is entered at the command line. The passphrase is required when the PKCS#12 file is imported on the client system. The passphrase is not stored anywhere on the device, so users are responsible for remembering it until the export-import process is complete.

If **local-radius-all-users** is specified instead of an individual user, then keys and certificates for all RADIUS users will be generated at once. All the keys will be encrypted using the same passphrase.

The specified trustpoint must already exist, it must represent a locally self-signed CA, and it must already have been authenticated.

**Example** To enroll the user “example-user” with the trustpoint “example”, use the following commands:

```
awplus> enable
awplus# crypto pki enroll example user example-user
```

To enroll all local RADIUS users with the trustpoint "example", use the following commands:

```
awplus> enable
```

```
awplus# crypto pki enroll example local-radius-all-users
```

**Related commands**

- [crypto pki export pkcs12](#)
- [crypto pki trustpoint](#)

# crypto pki export pem

**Overview** Use this command to export the root CA certificate for the given trustpoint to a file in Privacy-Enhanced Mail (PEM) format. The file may be transferred to the specified destination URL, or displayed at the terminal.

**Syntax** `crypto pki export <trustpoint> pem [terminal|<url>]`

Parameter	Description
<trustpoint>	The name of the trustpoint for which the root CA certificate is to be exported.
terminal	Display the PEM file to the terminal.
<url>	Transfer the PEM file to the specified URL.

**Default** The PEM will be displayed to the terminal by default.

**Mode** Privileged Exec

**Usage notes** The specified trustpoint must already exist, and it must already be authenticated.

**Example** To display the PEM file for the trustpoint "example" to the terminal, use the following commands:

```
awplus> enable
awplus# crypto pki export example pem terminal
```

To export the PEM file "example.pem" for the trustpoint "example" to the URL "tftp://server\_a/", use the following commands:

```
awplus> enable
awplus# crypto pki export example pem
tftp://server_a/example.pem
```

**Related commands**

- [crypto pki authenticate](#)
- [crypto pki import pem](#)
- [crypto pki trustpoint](#)

# crypto pki export pkcs12

**Overview** Use this command to export a certificate and private key for an entity in a trustpoint to a file in PKCS#12 format at the specified URL. The private key is encrypted with a passphrase for security.

**Syntax** `crypto pki export <trustpoint> pkcs12 {ca|server|<username>} <url>`

Parameter	Description
<trustpoint>	The name of the trustpoint for which the certificate and key are to be exported.
ca	If this option is specified, the command exports the root CA certificate and corresponding key.
server	If this option is specified, the command exports the server certificate and corresponding key.
<username>	If a RADIUS username is specified, the command exports the PKCS#12 file that was previously generated using the <code>crypto pki enroll user</code> command. To avoid ambiguity with keywords, the username may be prefixed by the string "user:".
<url>	The destination URL for the PKCS#12 file. The format of the URL is the same as any valid destination for a file copy command.

**Mode** Privileged Exec

**Usage notes** If the **ca** option is specified, this command exports the root CA certificate and the corresponding private key, if the trustpoint has been authenticated as a locally selfsigned CA. (If the trustpoint represents an external CA, then there is no private key on the system corresponding to the root CA certificate. Use the **crypto pki export pem** file to export the certificate by itself.) The command prompts for a passphrase to encrypt the private key.

If the **server** option is specified, this command exports the server certificate and the corresponding private key, if the server has been enrolled to the trustpoint. The command prompts for a passphrase to encrypt the private key.

If a RADIUS username is specified, this command exports the PKCS#12 file that was generated using the **crypto pki enroll user** command. (The key within the file was already encrypted as part of the user enrollment process.)

In the event that there is a RADIUS user named "ca" or "server", enter "user:ca" or "user:server" as the username.

The key and certificate must already exist.

**Example** To export the PKCS#12 file "example.pk12" for the trustpoint "example" to the URL "tftp://backup/", use the following commands:

```
awplus> enable  
  
awplus# crypto pki export example pkcs12 ca  
tftp://backup/example.pk12
```

**Related commands**

- crypto pki enroll user
- crypto pki export pem
- crypto pki import pkcs12

# crypto pki import pem

**Overview** This command imports a certificate for the given trustpoint from a file in Privacy-Enhanced Mail (PEM) format. The file may be transferred from the specified destination URL, or entered at the terminal.

**Syntax** `crypto pki import <trustpoint> pem [terminal|<url>]`

Parameter	Description
<trustpoint>	The name of the trustpoint for which the root CA certificate is to be imported.
terminal	Optional parameter, If specified, the command prompts the user to enter (or paste) the PEM file at the terminal. If parameter is specified terminal is assumed by default.
<url>	Optional parameter, If specified, the PEM file is transferred from the specified URL

**Default** The PEM will be imported from the terminal by default.

**Mode** Privileged Exec

**Usage notes** The command is generally used for trustpoints representing external certificate authorities. It accepts root CA certificates, intermediate CA certificates, and server certificates. The system automatically detects the certificate type upon import.

Using this command to import root CA certificates at the terminal is identical to the functionality provided by the `crypto pki authenticate` command, for external certificate authorities. The imported certificate is validated to ensure it is a proper CA certificate.

Intermediate CA certificates are validated to ensure they are proper CA certificates, and that the issuer chain ends in a root CA certificate already installed for the trustpoint. If there is no root CA certificate for the trustpoint (i.e., if the trustpoint is unauthenticated) then intermediate CA certificates may not be imported.

Server certificates are validated to ensure that the issuer chain ends in a root CA certificate already installed for the trustpoint. If there is no root CA certificate for the trustpoint (i.e., if the trustpoint is unauthenticated) then server certificates may not be imported.

The specified trustpoint must already exist. If the imported certificate is self-signed, then no certificates may exist for the trustpoint. Otherwise, the issuer's certificate must already be present for the trustpoint.

**Example** To import the PEM file for the trustpoint "example" from the terminal, use the following commands:

```
awplus> enable
awplus# crypto pki import example pem
```

To import the PEM file for the trustpoint "example" from the URL "tftp://server\_a/", use the following commands:

```
awplus> enable  
  
awplus# crypto pki import example pem  
tftp://server_a/example.pem
```

**Related commands**

- [crypto pki authenticate](#)
- [crypto pki export pem](#)
- [crypto pki trustpoint](#)

# crypto pki import pkcs12

**Overview** This command imports a certificate and private key for an entity in a trustpoint from a file in PKCS#12 format at the specified URL. The command prompts for a passphrase to decrypt the private key within the file.

**Syntax** `crypto pki import <trustpoint> pkcs12 {ca|server} <url>`

Parameter	Description
<trustpoint>	The name of the trustpoint for which the certificate and key are to be imported.
ca	If this option is specified, the command imports the root CA certificate and corresponding key.
server	If this option is specified, the command imports the server certificate and corresponding key.
<url>	The source URL for the PKCS#12 file. The format of the URL is the same as any valid destination for a file copy command.

**Mode** Privileged Exec

**Usage notes** If the **ca** option is specified, this command imports the root CA certificate and the corresponding private key. This is only valid if the root CA certificate does not already exist for the trustpoint (i.e., if the trustpoint is unauthenticated).

If the **server** option is specified, this command imports the server certificate and the corresponding private key. The imported private key is given a new unique label of the form "localN", where N is a non-negative integer. This operation is only valid if the server certificate does not already exist for the trustpoint (i.e., if the server is not enrolled to the trustpoint).

PKCS#12 files for RADIUS users may not be imported with this command. (There is no value in doing so, as the files are not needed on the local system.)

The specified trustpoint must already exist. The key and certificate must not already exist.

**Example** To import the PKCS#12 file "example.pk12" for the trustpoint "example" to the URL "tftp://backup/", use the following commands:

```
awplus> enable
awplus# crypto pki import example pkcs12 ca
tftp://backup/example.pk12
```

**Related commands** [crypto pki export pkcs12](#)  
[crypto pki import pem](#)



# crypto pki trustpoint

**Overview** Use this command to declare the named trustpoint and enter trustpoint configuration mode.

Use the **no** variant of this command to destroy the trustpoint.

**Syntax** `crypto pki trustpoint <trustpoint>`  
`no crypto pki trustpoint <trustpoint>`

Parameter	Description
<code>&lt;trustpoint&gt;</code>	The name of the trustpoint. The name must start with an alphanumeric character, and may only contain alphanumeric characters, underscores, dashes, or periods. The maximum length of the name is 63 characters.

**Mode** Global Configuration

**Usage notes** If the trustpoint did not previously exist, it is created as a new trustpoint. The trustpoint will be empty (unauthenticated) unless the name "local" is selected, in which case the system will automatically authenticate the trustpoint as a local self-signed certificate authority.

The **no** variant of this command destroys the trustpoint by removing all CA and server certificates associated with the trustpoint, as well as the private key associated with the root certificate (if the root certificate was locally self-signed). This is a destructive and irreversible operation, so this command should be used with caution.

**Example** To configure a trustpoint named "example", use the following commands:

```
awplus> enable
awplus# configure terminal
awplus(config)# crypto pki trustpoint example
```

**Related commands** [show crypto pki certificates](#)  
[show crypto pki trustpoint](#)

**Command changes** Version 5.4.6-1.1: command added to x930 Series  
Version 5.4.8-1: command added to x220, XS900MX, x550 Series  
Version 5.4.8-2.1: command added to SBx908 GEN2, x950 Series

# enrollment (ca-trustpoint)

**Overview** Use this command to declare how certificates will be added to the system for the current trustpoint.

**Syntax** `enrollment {selfsigned|terminal}`

Parameter	Description
<code>selfsigned</code>	Sets the enrollment mode for the current trustpoint to selfsigned.
<code>terminal</code>	Sets the enrollment mode for the current trustpoint to terminal.

**Mode** Trustpoint Configuration

**Usage notes** If the enrollment is set to **selfsigned**, then the system will generate a root CA certificate and its associated key when the **crypto pki authenticate** command is issued. It will generate a server certificate (signed by the root CA certificate) when the **crypto pki enroll** command is issued.

If the enrollment is set to **terminal**, then the system will prompt the user to paste the root CA certificate Privacy Enhanced Mail (PEM) file at the terminal, when the **crypto pki authenticate** command is issued. It will create a Certificate Signing Request (CSR) file for the local server when the **crypto pki enroll** command is issued. The server certificate received from the external CA should be imported using the **crypto pki import pem** command.

The trustpoint named "local" may only use the **selfsigned** enrollment setting.

If no enrollment mode is specified, the **crypto pki authenticate** command will fail for the trustpoint.

**Example** To configure the trustpoint named "example" and set its enrollment to **selfsigned**, use the following commands:

```
awplus> enable
awplus# configure terminal
awplus(config)# crypto pki trustpoint example
awplus(ca-trustpoint)# enrollment selfsigned
```

**Related commands** [crypto pki enroll](#)

# fingerprint (ca-trustpoint)

**Overview** Use this command to declare that certificates with the specified fingerprint should be automatically accepted, when importing certificates from an external certificate authority. This can affect the behavior of the **crypto pki authenticate** and **crypto pki import pem** commands.

Use the **no** variant of this command to remove the specified fingerprint from the pre-accepted list.

**Syntax** fingerprint <word>  
no fingerprint <word>

Parameter	Description
<word>	The fingerprint as a series of 40 hexadecimal characters, optionally separated into multiple character strings.

**Default** By default, no fingerprints are pre-accepted for the trustpoint.

**Mode** Trustpoint Configuration

**Usage notes** Specifying a fingerprint adds it to a list of pre-accepted fingerprints for the trustpoint. When a certificate is imported, if it matches any of the pre-accepted values, then it will be saved in the system automatically. If the imported certificate's fingerprint does not match any pre-accepted value, then the user will be prompted to verify the certificate contents and fingerprint visually.

This command is useful when certificates from an external certificate authority are being transmitted over an insecure channel. If the certificate fingerprint is delivered via a separate messaging channel, then pre-entering the fingerprint value via cut-and-paste may be less errorprone than attempting to verify the fingerprint value visually.

The fingerprint is a series of 40 hexadecimal characters. It may be entered as a continuous string, or as a series of up to multiple strings separated by spaces. The input format is flexible because different certificate authorities may provide the fingerprint string in different formats.

**Example** To configure a fingerprint "5A81D34C 759CC4DA CFCA9F65 0303AD83 410B03AF" for the trustpoint named "example", use the following commands:

```
awplus> enable
awplus# configure terminal
awplus(config)# crypto pki trustpoint example
awplus(ca-trustpoint)# fingerprint 5A81D34C 759CC4DA CFCA9F65
0303AD83 410B03AF
```

**Related commands** [crypto pki authenticate](#)

`crypto pki import pem`

# no crypto pki certificate

**Overview** Use this command to delete a certificate with the specified fingerprint from the specified trustpoint.

**Syntax** `no crypto pki certificate <trustpoint> <word>`

Parameter	Description
<code>&lt;trustpoint&gt;</code>	The name of the trustpoint.
<code>&lt;word&gt;</code>	The fingerprint as a series of 40 hexadecimal characters, optionally separated into multiple character strings.

**Default** By default, no fingerprints are pre-accepted for the trustpoint.

**Mode** Privileged Exec

**Usage notes** The fingerprint can be found in the output of the **show crypto pki certificates** command. If there are dependent certificates in the trustpoint (i.e., if other certificates were signed by the specified certificate), the command will be rejected. If the specified certificate is the root CA certificate and the trustpoint represents a locally selfsigned CA, then the corresponding private key is also deleted from the system. Deleting the root CA certificate effectively resets the trustpoint to an unauthenticated state.

**Example** To delete a certificate with the fingerprint "594EDEF9 C7C4308C 36D408E0 77E784F0 A59E8792" from the trustpoint "example", use the following commands:

```
awplus> enable
awplus# no crypto pki certificate example
594EDEF9 C7C4308C 36D408E0 77E784F0 A59E8792
```

**Related commands** [no crypto pki trustpoint](#)  
[show crypto pki certificates](#)

# rsakeypair (ca-trustpoint)

**Overview** Use this command to declare which RSA key pair should be used to enroll the local server with the trustpoint. Note that this defines the key pair used with the server certificate, not the key pair used with the root CA certificate.

Use the **no** variant of this command to restore the default value, "server-default".

**Syntax** `rsakeypair <keylabel> [<1024-4096>]`  
`no rsakeypair`

Parameter	Description
<code>&lt;keylabel&gt;</code>	The key to be used with the server certificate for this trustpoint. The name must start with an alphanumeric character, and may only contain alphanumeric characters, underscores, dashes, or periods. The maximum length of the name is 63 characters.
<code>&lt;1024-4096&gt;</code>	The bit length for the key, to be used if the key is implicitly generated during server enrollment.

**Default** The default value for **keylabel** is "server-default".  
The default value for the key bit length is 2048.

**Mode** Trustpoint Configuration

**Usage notes** If the label specified does not refer to an existing key created by the **crypto key generate rsa** command, the key will be implicitly generated when the **crypto pki enroll** command is issued to generate the server certificate or the server certificate signing request. The optional numeric parameter defines the bit length for the key, and is only applicable for keys that are implicitly created during enrollment.

This command does not affect server certificates or server certificate signing requests that have already been generated. The trustpoint's server certificate is set to use whatever key pair was specified for the trustpoint at the time the **crypto pki enroll** command is issued.

The default key pair is "server-default". The default bit length is 2048 bits.

**Example** To configure trustpoint "example" to use the key pair "example-server-key" with a bit length of 2048, use the following commands:

```
awplus> enable
awplus# configure terminal
awplus(config)# crypto pki trustpoint example
awplus(ca-trustpoint)# rsakeypair example-server-key 2048
```

**Related commands** [crypto key generate rsa](#)

# show crypto key mypubkey rsa

**Overview** Use this command to display information about the specified Rivest-Shamir-Adleman encryption key.

**Syntax** `show crypto key mypubkey rsa [<keylabel>]`

Parameter	Description
<keylabel>	The name of the key to be shown, if specified.

**Default** By default, all keys will be shown.

**Mode** Privileged Exec

**Usage notes** If no key label is specified, information about all keys is shown. The command displays the bit length of the key, a key fingerprint (a hash of the key contents to help uniquely identify a key), and a list of trustpoints in which the server certificate is using the key.

The specified keys must exist.

**Example** To show all keys, use the following commands:

```
awplus> enable
awplus# show crypto key mypubkey rsa
```

**Output** Figure 35-1: Example output from **show crypto key mypubkey rsa**

```
awplus#show crypto key mypubkey rsa
-----
RSA Key Pair "example-server-key":
  Key size      : 2048 bits
  Fingerprint  : 1A605D73 C2274CB7 853886B3 1C802FC6 7CDE45FB
  Trustpoints   : example
-----
RSA Key Pair "server-default":
  Key size      : 2048 bits
  Fingerprint  : 34AC4D2D 5249A168 29D426A3 434FFC59 C4A19901
  Trustpoints   : local
```

**Related commands** [crypto key generate rsa](#)

# show crypto pki certificates

**Overview** Use this command to display information about existing certificates for the specified trustpoint.

**Syntax** `show crypto pki certificates [<trustpoint>]`

Parameter	Description
<code>&lt;trustpoint&gt;</code>	The trustpoint for which the certificates are to be shown.

**Default** By default, the certificates for all trustpoints are shown.

**Mode** Privileged Exec

**Usage notes** If no trustpoint is specified, certificates for all trustpoints are shown. The command displays the certificates organized into certificate chains. It starts with the server certificate and then displays its issuer, and continues up the issuer chain until the root CA certificate is reached.

For each certificate, the command displays the certificate type, the subject's distinguished name (the entity identified by the certificate), the issuer's distinguished name (the entity that signed the certificate), the validity dates for the certificate, and the fingerprint of the certificate. The fingerprint is a cryptographic hash of the certificate contents that uniquely identifies the certificate.

The specified trustpoints must already exist.

**Example** To show the certificates for the trustpoint "example", use the following command:

```
awplus> enable
awplus# show crypto pki certificates example
```



**Output** Figure 35-2: Example output from **show crypto pki certificates**

```
awplus>enable
awplus#show crypto pki certificates example
-----
Trustpoint "example" Certificate Chain
-----
Server certificate
  Subject      : /O=local/CN=local.loc.lc
  Issuer       : /C=NZ/CN=local_Signing_CA
  Valid From   : Nov 11 15:35:21 2015 GMT
  Valid To     : Aug 31 15:35:21 2018 GMT
  Fingerprint  : 5A81D34C 759CC4DA CFCA9F65 0303AD83 410B03AF
Intermediate CA certificate
  Subject      : /C=NZ/CN=example_Signing_CA
  Issuer       : /C=NZ/CN=example_Root_CA
  Valid From   : Sep 3 18:45:01 2015 GMT
  Valid To     : Oct 10 18:45:01 2020 GMT
  Fingerprint  : AE2D5850 9867D258 ABBEE95E 2E0E3D81 60714920
Imported root certificate
  Subject      : /C=NZ/CN=example_Root_CA
  Issuer       : /C=NZ/CN=example_Root_CA
  Valid From   : Jul 23 18:12:10 2015 GMT
  Valid To     : May 12 18:12:10 2025 GMT
  Fingerprint  : 594EDEF9 C7C4308C 36D408E0 77E784F0 A59E8792
```

**Related commands** [crypto pki trustpoint](#)

# show crypto pki enrollment user

**Overview** Use this command to display a list of trustpoints for which RADIUS user enrollments have been performed, using the **crypto pki enroll user** command. This indicates that PKCS#12 files for the user are available for export for the given trustpoints, using the **crypto pki export pkcs12** command.

**Syntax** `crypto pki enrollment user <username>`

Parameter	Description
<code>&lt;username&gt;</code>	The user for which enrollments are to be shown.

**Mode** Privileged Exec

**Example** To show the list of trustpoints to which user "exampleuser1" is enrolled, use the following commands:

```
awplus> enable
awplus(config)# show crypto pki enrollment user exampleuser1
```

**Output** Figure 35-3: Example output from **show crypto pki enrollment user**

```
awplus> enable
awplus# show crypto pki enrollment user exampleuser1
User "exampleuser1" is enrolled to the following trustpoints:
local,example
```

**Related commands** [crypto pki enroll user](#)  
[crypto pki export pkcs12](#)

# show crypto pki trustpoint

**Overview** Use this command to display information about the specified trustpoint.

**Syntax** show crypto pki trustpoint [*<trustpoint>*]

Parameter	Description
<i>&lt;trustpoint&gt;</i>	The name of the trustpoint to be shown

**Default** By default, all trustpoints are shown.

**Mode** Privileged Exec

**Usage notes** If no trustpoint is specified, information about all trustpoints is shown. The command displays the authentication status of the trustpoint, the fingerprint of the root CA certificate (if it exists), the enrollment status of the local server with the trustpoint, a list of any applications that are configured to use the trustpoint, and the trustpoint parameters that were configured from trustpoint-configuration mode.

The specified trustpoints must already exist.

**Example** To show the details of the trustpoint "example", use the following commands:

```
awplus> enable
awplus# show crypto pki trustpoint example
```

**Output** Figure 35-4: Example output from **show crypto pki trustpoint**

```
awplus> enable
awplus# show crypto pki trustpoint example
-----
Trustpoint "example"
  Type           : Self-signed certificate authority
  Root Certificate: 50C1856B EEC7555A 0F3A61F6 690D9463 67DF74D1
  Local Server   : The server is enrolled to this trustpoint.
  Server Key     : example-server-key
  Applications   : RADIUS

Authentication and Enrollment Parameters:
  Enrollment     : selfsigned
  RSA Key Pair   : example-server-key (2048 bits)
-----
```

**Related commands** [crypto pki trustpoint](#)  
[show crypto pki certificates](#)

# subject-name (ca-trustpoint)

**Overview** Use this command to specify the distinguished name string that should be used for the subject field in the server certificate, when enrolling the server (generating the server certificate or server certificate signing request).

**Syntax** `subject-name <word>`

Parameter	Description
<code>&lt;word&gt;</code>	Specify the subject name as a distinguished name string. Complex strings (e.g., strings containing spaces) should be surrounded with double-quote characters.

**Default** If no subject name is specified for the trustpoint, then the system automatically builds a name of the form `/O=AlliedWare Plus/CN=xxxx.yyyy.zzz`, where `xxxx` is the hostname of the system and `yyyy.zzz` is the default search domain for the system.

**Mode** Trustpoint Configuration

**Usage notes** The subject name is specified as a variable number of fields, where each field begins with a forward-slash character (`/`). Each field is of the form `XX=value`, where `XX` is the abbreviation of the node type in the tree.

Common values include:

- `"C"` (country),
- `"ST"` (state),
- `"L"` (locality),
- `"O"` (organization),
- `"OU"` (organizational unit), and
- `"CN"` (common name).

Of these fields, `"CN"` is usually the most important.

**NOTE:** For a server certificate, many applications require that the network name of the server matches the common name in the server's certificate.

**Example** To configure the trustpoint named "example" and set its subject name, use the following commands:

```
awplus> enable
awplus# configure terminal
awplus(config)# crypto pki trustpoint example
awplus(ca-trustpoint)# subject-name "/O=My
Company/CN=192.168.1.1
```

**Related  
commands** `crypto pki enroll`

# 36

# TACACS+ Commands

## Introduction

**Overview** This chapter provides an alphabetical reference for commands used to configure the device to use TACACS+ servers. For more information about TACACS+, see the [TACACS+ Feature Overview and Configuration Guide](#).

- Command List**
- [“authorization commands”](#) on page 1335
  - [“aaa authorization commands”](#) on page 1337
  - [“aaa authorization config-commands”](#) on page 1339
  - [“ip tacacs source-interface”](#) on page 1340
  - [“show tacacs+”](#) on page 1341
  - [“tacacs-server host”](#) on page 1343
  - [“tacacs-server key”](#) on page 1345
  - [“tacacs-server timeout”](#) on page 1346

# authorization commands

**Overview** This command applies a command authorization method list, defined using the [aaa authorization commands](#) command, to console and VTY lines.

Use the **no** variant of this command to reset the command authorization configuration on the console and VTY lines.

**Syntax** `authorization commands <privilege-level> {default|<list-name>}`  
`no authorization commands <privilege-level>`

Parameter	Description
<code>&lt;privilege-level&gt;</code>	The privilege level of the set of commands the method list will be applied to. AlliedWare Plus defines three sets of commands, that are indexed by a level value: <b>Level = 1:</b> All commands that can be accessed by a user with privilege level between 1 and 6 inclusive <b>Level = 7:</b> All commands that can be accessed by a user with privilege level between 7 and 14 inclusive <b>Level = 15:</b> All commands that can be accessed by a user with privilege level 15
<code>default</code>	Configure the default authorization commands method list.
<code>&lt;list-name&gt;</code>	Configure a named authorization commands method list

**Default** The **default** method list is applied to each console and VTY line by default.

**Mode** Line Configuration

**Usage notes** If the specified method list does not exist users will not be able to execute any commands in the specified method list on the specified VTY lines.

**Example** To apply the TAC15 command authorization method list with privilege level 15 to VTY lines 0 to 5, use the following commands:

```
awplus# configure terminal
awplus(config)# line vty 0 5
awplus(config-line)# authorization commands 15 TAC15
```

To reset the command authorization configuration with privilege level 15 on VTY lines 0 to 5, use the following commands:

```
awplus# configure terminal
awplus(config)# line vty 0 5
awplus(config-line)# no authorization commands 15
```

**Related commands** [aaa authorization commands](#)

aaa authorization config-commands

tacacs-server host

**Command changes** Version 5.4.6-2.1: command added



# aaa authorization commands

**Overview** This command configures a method list for commands authorization that can be applied to console or VTY lines. When command authorization is enabled for a privilege level, only authorized users can executed commands in that privilege level.

Use the **no** variant of this command to remove a named method list or disable the default method list for a privilege level.

**Syntax** `aaa authorization commands <privilege-level>  
{default|<list-name>} group tacacs+ [none]`  
`no aaa authorization commands <privilege-level>  
{default|<list-name>}`

Parameter	Description
<code>&lt;privilege-level&gt;</code>	The privilege level of the set of commands the method list will be applied to. AlliedWare Plus defines three sets of commands, that are indexed by a level value: <b>Level = 1:</b> All commands that can be accessed by a user with privilege level between 1 and 6 inclusive <b>Level = 7:</b> All commands that can be accessed by a user with privilege level between 7 and 14 inclusive <b>Level = 15:</b> All commands that can be accessed by a user with privilege level 15
<code>group</code>	Specify the server group where authorization messages are sent. Only the <code>tacacs+</code> group is available for this command.
<code>tacacs+</code>	Use all TACACS+ servers configured by the <code>tacacs-server host</code> command.
<code>default</code>	Configure the default authorization commands method list.
<code>&lt;list-name&gt;</code>	Configure a named authorization commands method list
<code>none</code>	If specified, this provides a local fallback to command authorization so that if authorization servers become unavailable then the device will accept all commands normally allowed for the privilege level of the user.

**Mode** Global Configuration

**Usage notes** TACACS+ command authorization provides centralized control of the commands available to a user of an AlliedWare Plus device. Once enabled:

- The command string and username are encrypted and sent to the first available configured TACACS+ server (the first server configured) for authorization.

- The TACACS+ server decides if the user is authorized to execute the command and returns the decision to the AlliedWare Plus device.
- Depending on this decision the device will then either execute the command or notify the user that authorization has failed.

If multiple TACACS+ servers are configured, and the first server is unreachable or does not respond, the other servers will be queried, in turn, for an authorization decision. If all servers are unreachable and a local fallback has been configured, with the **none** parameter, then commands are authorized based on the user's privilege level; the same behavior as if command authorization had not been configured. If, however, the local fallback is not configured and all servers become unreachable then all commands except **logout**, **exit**, and **quit** will be denied.

The **default** method list is defined with a local fallback unless configured differently using this command.

**Example** To configure a commands authorization method list, named TAC15, using all TACACS+ servers to authorize commands for privilege level 15, with a local fallback, use the following commands:

```
awplus# configure terminal
awplus(config)# aaa authorization commands 15 TAC15 group
tacacs+ none
```

To configure the default method list to authorize commands for privilege level 7, with no local fallback, use the following commands:

```
awplus# configure terminal
awplus(config)# aaa authorization commands 7 default group
tacacs+
```

To remove the authorization method list TAC15, use the following commands:

```
awplus# configure terminal
awplus(config)# no aaa authorization commands 15 TAC15
```

**Related commands** [aaa authorization config-commands](#)  
[authorization commands](#)  
[tacacs-server host](#)

**Command changes** Version 5.4.6-2.1: command added

# aaa authorization config-commands

**Overview** Use this command to enable command authorization on configuration mode commands. By default, command authorization applies to commands in exec mode only.

Use the **no** variant of this command to disable command authorization on configuration mode commands.

**Syntax** `aaa authorization config-commands`  
`no aaa authorization config-commands`

**Default** By default, command authorization is disabled on configuration mode commands.

**Mode** Global Configuration

**Usage notes** If authorization of configuration mode commands is not enabled then all configuration commands are accepted by default, including command authorization commands.

**NOTE:** *Authorization of configuration commands is required for a secure TACACS+ command authorization configuration as it prevents the feature from being disabled to gain access to unauthorized exec mode commands.*

**Example** To enable command authorization for configuration mode commands, use the commands:

```
awplus# configure terminal
awplus(config)# aaa authorization config-commands
```

To disable command authorization for configuration mode commands, use the commands:

```
awplus# configure terminal
awplus(config)# no aaa authorization config-commands
```

**Related commands** [aaa authorization commands](#)  
[authorization commands](#)  
[tacacs-server host](#)

**Command changes** Version 5.4.6-2.1: command added

# ip tacacs source-interface

**Overview** This command sets the source interface, or IP address, to use for all TACACS+ packets sent from the device. By default, TACACS+ packets use the source IP address of the egress interface.

Use the **no** variant of this command to remove the source interface configuration and use the source IP address of the egress interface.

**Syntax** `ip tacacs source-interface {<interface>|<ip-address>}`  
`no ip tacacs source-interface`

Parameter	Description
<code>&lt;interface&gt;</code>	Interface name.
<code>&lt;ip-address&gt;</code>	IP address in the dotted decimal format A.B.C.D.

**Default** The source IP address of outgoing TACACS+ packets default to the IP address of the egress interface.

**Mode** Global Configuration

**Usage notes** Setting the source interface ensures that all TACACS+ packets sent from the device will have the same source IP address. Once configured this affects all TACACS+ packets, namely accounting, authentication, and authorization.

If the specified interface is down or there is no IP address on the interface, then the source IP address of outgoing TACACS+ packets will default to the IP address of the egress interface.

**Example** To configure all outgoing TACACS+ packets to use the IP address of the loop-back "lo" interface as the source IP address, use the following commands:

```
awplus# configure terminal
awplus(config)# ip tacacs source-interface lo
```

To reset the source interface configuration for all TACACS+ packets, use the following commands:

```
awplus# configure terminal
awplus(config)# no ip tacacs source-interface
```

**Related commands** [tacacs-server host](#)  
[show tacacs+](#)

**Command changes** Version 5.4.6-2.1: command added

# show tacacs+

**Overview** This command displays the current TACACS+ server configuration and status.

**Syntax** show tacacs+

**Mode** User Exec and Privileged Exec

**Example** To display the current status of TACACS+ servers, use the command:

```
awplus# show tacacs+
```

**Output** Figure 36-1: Example output from the **show tacacs+** command

```
TACACS+ Global Configuration
  Source Interface      : not configured
  Timeout              : 5 sec

Server Host/          Server
IP Address            Status
-----
192.168.1.10         Alive
192.168.1.11         Unknown
```

**Table 1:** Parameters in the output of the **show tacacs+** command

Output Parameter	Meaning	
Source Interface	IP address of source interface if set with <code>ip tacacs source-interface</code> .	
Timeout	A time interval in seconds.	
Server Host/IP Address	TACACS+ server hostname or IP address.	
Server Status	The status of the authentication port.	
	Alive	The server is alive.
	Dead	The server has timed out.
	Error	The server is not responding or there is an error in the key string entered.
	Unknown	The server is never used or the status is unknown.
	Unreachable	The server is unreachable.
	Unresolved	The server name can not be resolved.

**Command changes** Version 5.4.6-2.1: **Source Interface** parameter added

# tacacs-server host

**Overview** Use this command to specify a remote TACACS+ server host for authentication, authorization and accounting, and to set the shared secret key to use with the TACACS+ server. The parameters specified with this command override the corresponding global parameters for TACACS+ servers.

Use the **no** variant of this command to remove the specified server host as a TACACS+ authentication and authorization server.

**Syntax** `tacacs-server host {<host-name>|<ip-address>} [key [8]<key-string>]`  
`no tacacs-server host {<host-name>|<ip-address>}`

Parameter	Description
<code>&lt;host-name&gt;</code>	Server host name. The DNS name of the TACACS+ server host.
<code>&lt;ip-address&gt;</code>	The IP address of the TACACS+ server host, in dotted decimal notation A.B.C.D.
<code>key</code>	Set shared secret key with TACACS+ servers.
<code>8</code>	Specifies that you are entering a password as a string that has already been encrypted instead of entering a plain text password. The running config displays the new password as an encrypted string even if password encryption is turned off.
<code>&lt;key-string&gt;</code>	Shared key string applied, a value in the range 1 to 64 characters. Specifies the shared secret authentication or encryption key for all TACACS+ communications between this device and the TACACS+ server. This key must match the encryption used on the TACACS+ server. This setting overrides the global setting of the <code>tacacs-server key</code> command. If no key value is specified, the global value is used.

**Default** No TACACS+ server is configured by default.

**Mode** Global Configuration

**Usage** A TACACS+ server host cannot be configured multiple times like a RADIUS server.

As many as four TACACS+ servers can be configured and consulted for login authentication, enable password authentication and accounting. The first server configured is regarded as the primary server and if the primary server fails then the backup servers are consulted in turn. A backup server is consulted if the primary server fails, not if a login authentication attempt is rejected. The reasons a server would fail are:

- it is not network reachable
- it is not currently TACACS+ capable

- it cannot communicate with the switch properly due to the switch and the server having different secret keys

**Examples** To add the server `tacl.company.com` as the TACACS+ server host, use the following commands:

```
awplus# configure terminal
awplus(config)# tacacs-server host tacl.company.com
```

To set the secret key to `secret` on the TACACS+ server `192.168.1.1`, use the following commands:

```
awplus# configure terminal
awplus(config)# tacacs-server host 192.168.1.1 key secret
```

To remove the TACACS+ server `tacl.company.com`, use the following commands:

```
awplus# configure terminal
awplus(config)# no tacacs-server host tacl.company.com
```

**Related commands**

- [aaa accounting commands](#)
- [aaa authentication login](#)
- [tacacs-server key](#)
- [tacacs-server timeout](#)
- [show tacacs+](#)



# tacacs-server key

**Overview** This command sets a global secret key for TACACS+ authentication, authorization and accounting. The shared secret text string is used for TACACS+ communications between the switch and all TACACS+ servers.

Note that if no secret key is explicitly specified for a TACACS+ server with the [tacacs-server host](#) command, the global secret key will be used for the shared secret for the server.

Use the **no** variant of this command to remove the global secret key.

**Syntax** `tacacs-server key [8] <key-string>`  
`no tacacs-server key`

Parameter	Description
8	Specifies a string in an encrypted format instead of plain text. The running config will display the new password as an encrypted string even if password encryption is turned off.
<key-string>	Shared key string applied, a value in the range 1 to 64 characters. Specifies the shared secret authentication or encryption key for all TACACS+ communications between this device and all TACACS+ servers. This key must match the encryption used on the TACACS+ server.

**Mode** Global Configuration

**Usage notes** Use this command to set the global secret key shared between this client and its TACACS+ servers. If no secret key is specified for a particular TACACS+ server using the [tacacs-server host](#) command, this global key is used.

**Examples** To set the global secret key to `secret` for TACACS+ server, use the following commands:

```
awplus# configure terminal  
awplus(config)# tacacs-server key secret
```

To delete the global secret key for TACACS+ server, use the following commands:

```
awplus# configure terminal  
awplus(config)# no tacacs-server key
```

**Related commands** [tacacs-server host](#)  
[show tacacs+](#)

# tacacs-server timeout

**Overview** Use this command to specify the TACACS+ global timeout value. The timeout value is how long the device waits for a reply to a TACACS+ request before considering the server to be dead.

Note that this command configures the **timeout** parameter for TACACS+ servers globally.

The **no** variant of this command resets the transmit timeout to the default (5 seconds).

**Syntax** tacacs-server timeout <seconds>  
no tacacs-server timeout

Parameter	Description
<seconds>	TACACS+ server timeout in seconds, in the range 1 to 1000.

**Default** The default timeout value is 5 seconds.

**Mode** Global Configuration

**Examples** To set the timeout value to 3 seconds, use the following commands:

```
awplus# configure terminal  
awplus(config)# tacacs-server timeout 3
```

To reset the timeout period for TACACS+ servers to the default, use the following commands:

```
awplus# configure terminal  
awplus(config)# no tacacs-server timeout
```

**Related commands** tacacs-server host  
show tacacs+

# 37

# DHCP Snooping Commands

## Introduction

**Overview** This chapter gives detailed information about the commands used to configure DHCP snooping. For detailed descriptions of related ACL commands, see [IPv4 Hardware Access Control List \(ACL\) Commands](#). For more information about DHCP snooping, see the [DHCP Snooping Feature Overview and Configuration Guide](#).

DHCP snooping can operate on static link aggregators (e.g. sa2) and dynamic link aggregators (e.g. po2), as well as on switch ports (e.g. port1.0.2).

- Command List**
- “[arp security](#)” on page 1349
  - “[arp security drop link-local-arps](#)” on page 1350
  - “[arp security violation](#)” on page 1351
  - “[clear arp security statistics](#)” on page 1353
  - “[clear ip dhcp snooping binding](#)” on page 1354
  - “[clear ip dhcp snooping statistics](#)” on page 1355
  - “[debug arp security](#)” on page 1356
  - “[debug ip dhcp snooping](#)” on page 1357
  - “[ip dhcp snooping](#)” on page 1358
  - “[ip dhcp snooping agent-option](#)” on page 1360
  - “[ip dhcp snooping agent-option allow-untrusted](#)” on page 1361
  - “[ip dhcp snooping agent-option circuit-id vlantriple](#)” on page 1362
  - “[ip dhcp snooping agent-option remote-id](#)” on page 1363
  - “[ip dhcp snooping binding](#)” on page 1364
  - “[ip dhcp snooping database](#)” on page 1365
  - “[ip dhcp snooping delete-by-client](#)” on page 1366
  - “[ip dhcp snooping delete-by-linkdown](#)” on page 1367

- [“ip dhcp snooping max-bindings”](#) on page 1368
- [“ip dhcp snooping trust”](#) on page 1369
- [“ip dhcp snooping verify mac-address”](#) on page 1370
- [“ip dhcp snooping violation”](#) on page 1371
- [“ip source binding”](#) on page 1372
- [“service dhcp-snooping”](#) on page 1374
- [“show arp security”](#) on page 1376
- [“show arp security interface”](#) on page 1377
- [“show arp security statistics”](#) on page 1379
- [“show debugging arp security”](#) on page 1381
- [“show debugging ip dhcp snooping”](#) on page 1382
- [“show ip dhcp snooping”](#) on page 1383
- [“show ip dhcp snooping acl”](#) on page 1384
- [“show ip dhcp snooping agent-option”](#) on page 1387
- [“show ip dhcp snooping binding”](#) on page 1389
- [“show ip dhcp snooping interface”](#) on page 1391
- [“show ip dhcp snooping statistics”](#) on page 1393
- [“show ip source binding”](#) on page 1396

# arp security

**Overview** Use this command to enable ARP security on untrusted ports in the VLANs, so that the switch only responds to/forwards ARP packets if they have recognized IP and MAC source addresses.

Use the **no** variant of this command to disable ARP security on the VLANs.

**Syntax** `arp security`  
`no arp security`

**Default** Disabled

**Mode** Interface Configuration (VLANs)

**Usage** Enable ARP security to provide protection against ARP spoofing. DHCP snooping must also be enabled on the switch ([service dhcp-snooping](#) command), and on the VLANs ([ip dhcp snooping](#) command).

**Example** To enable ARP security on VLANs 2 to 4, use the commands:

```
awplus# configure terminal
awplus(config)# interface vlan2-vlan4
awplus(config-if)# arp security
```

**Related commands** [arp security violation](#)  
[show arp security](#)  
[show arp security interface](#)  
[show arp security statistics](#)

# arp security drop link-local-arps

**Overview** Use this command to enable ARP security on a per-port basis. This means that IPv4 link-local ARPs will be dropped without causing an ARP security violation when received.

Use the **no** variant of this command to return to the default setting of disabled.

**Syntax** `arp security drop link-local-arps`  
`no arp security drop link-local-arps`

**Default** Disabled by default.

**Mode** Interface Configuration

**Usage notes** Hosts that implement RFC 3927 may automatically assign themselves link-local IPv4 addresses in the subnet 169.254.0.0/16, if they are configured to learn their IP addresses via DHCP but are unable to contact a DHCP server. This is common behavior for all versions of Microsoft Windows since Windows XP. In an attempt to avoid IP address collision with other devices on the local network, the host will broadcast ARP probes for its randomly selected link-local IP address.

By default, ARP security will treat these ARP probes as violations and carry out the configured violation action on the port they are received on. If the violation action is configured as link-down, this will result in the host being disconnected from the network, which will interrupt any DHCP IP address discovery that was in progress.

Use this command to configure ARP Security to drop these ARP probes, and any other ARPs that contain link-local IP addresses, without raising a violation on the affected port. The count of ARPs dropped in this manner can be seen in the output of **show arp security statistics detail**.

**Example** To configure ARP security to drop IPv4 link local ARPs on port1.0.1 to port1.0.4, use the commands:

```
awplus# configure terminal
awplus(config)# interface port1.0.1-port1.0.4
awplus(config-if)# arp security drop link-local-arps
```

**Related commands** [arp security](#)  
[arp security violation](#)  
[show arp security statistics](#)

**Command changes** Version 5.4.9-1.1: command added.

# arp security violation

**Overview** Use this command to specify an additional action to perform if an ARP security violation is detected on the ports. ARP security must also be enabled ([arp security](#) command).

Use the **no** variant of this command to remove the specified action, or all actions. Traffic violating ARP security will be dropped, but no other action will be taken.

**Syntax** `arp security violation {log|trap|link-down} ...`  
`no arp security violation [log|trap|link-down] ...`

Parameter	Description
log	Generate a log message. To display these messages, use the <a href="#">show log</a> command.
trap	Generate an SNMP notification (trap). To send SNMP notifications, SNMP must also be configured, and DHCP snooping notifications must be enabled using the <a href="#">snmp-server enable trap</a> command. Notifications are limited to one per second and to one per source MAC and violation reason. Additional violations within a second of a notification being sent will not result in further notifications. Default: disabled.
link-down	Shut down the port that received the packet. Default: disabled.

**Default** When the switch detects an ARP security violation, it drops the packet. By default, it does not perform any other violation actions.

**Mode** Interface Configuration (switch ports, static or dynamic aggregated links)

**Usage notes** When the switch detects an ARP security violation on an untrusted port in a VLAN that has ARP security enabled, it drops the packet. This command sets the switch to perform additional actions in response to ARP violations.

If a port has been shut down in response to a violation, to bring it back up again after any issues have been resolved, use the [shutdown](#) command.

**Example** To send SNMP notifications for ARP security violations on ports 1.0.1 to 1.0.6, use the commands:

```
awplus# configure terminal
awplus(config)# snmp-server enable trap dhcpsnooping
awplus(config)# interface port1.0.1-port1.0.6
awplus(config-if)# arp security violation trap
```

**Related commands**

- arp security
- show arp security interface
- show arp security statistics
- show log
- snmp-server enable trap



# clear arp security statistics

**Overview** Use this command to clear ARP security statistics for the specified ports, or for all ports.

**Syntax** `clear arp security statistics [interface <port-list>]`

Parameter	Description
<code>&lt;port-list&gt;</code>	The ports to clear statistics for. If no ports are specified, statistics are cleared for all ports. The ports may be switch ports, or static or dynamic link aggregators.

**Mode** Privileged Exec

**Example** To clear statistics for ARP security on interface port1.0.1, use the command:

```
awplus# clear arp security statistics interface port1.0.1
```

**Related commands**

- [arp security violation](#)
- [show arp security](#)
- [show arp security statistics](#)

# clear ip dhcp snooping binding

**Overview** Use this command to remove one or more DHCP Snooping dynamic entries from the DHCP Snooping binding database. If no options are specified, all entries are removed from the database.

**CAUTION:** *If you remove entries from the database for current clients, they will lose IP connectivity until they request and receive a new DHCP lease. If you clear all entries, all clients connected to untrusted ports will lose connectivity.*

**Syntax** `clear ip dhcp snooping binding [<ipaddr>] [interface <port-list>] [vlan <vid-list>]`

Parameter	Description
<ipaddr>	Remove the entry for this client IP address.
<port-list>	Remove all entries for these ports. The port list may contain switch ports, and static or dynamic link aggregators (channel groups).
<vid-list>	Remove all entries associated with these VLANs.

**Mode** Privileged Exec

**Usage** This command removes dynamic entries from the database. Note that dynamic entries can also be deleted by using the **no** variant of the [ip dhcp snooping binding](#) command.

Dynamic entries can individually be restored by using the [ip dhcp snooping binding](#) command.

To remove static entries, use the **no** variant of the [ip source binding](#) command.

**Example** To remove a dynamic lease entry from the DHCP snooping database for a client with the IP address 192.168.1.2, use the command:

```
awplus# clear ip dhcp snooping binding 192.168.1.2
```

**Related commands**

- [ip dhcp snooping binding](#)
- [ip source binding](#)
- [show ip dhcp snooping binding](#)

# clear ip dhcp snooping statistics

**Overview** Use this command to clear DHCP snooping statistics for the specified ports, or for all ports.

**Syntax** `clear ip dhcp snooping statistics [interface <port-list>]`

Parameter	Description
<code>&lt;port-list&gt;</code>	The ports to clear statistics for. If no ports are specified, statistics are cleared for all ports. The port list can contain switch ports, or static or dynamic link aggregators.

**Mode** Privileged Exec

**Example** To clear statistics for the DHCP snooping on interface port1.0.1, use the command:

```
awplus# clear ip dhcp snooping statistics interface port1.0.1
```

**Related commands**

- [clear arp security statistics](#)
- [show ip dhcp snooping](#)
- [show ip dhcp snooping statistics](#)

# debug arp security

**Overview** Use this command to enable ARP security debugging.  
Use the **no** variant of this command to disable debugging for ARP security.

**Syntax** `debug arp security`  
`no debug arp security`

**Default** Disabled

**Mode** Privileged Exec

**Example** To enable ARP security debugging, use the commands:

```
awplus# debug arp security
```

**Related commands** [show debugging arp security](#)  
[show log](#)  
[terminal monitor](#)

# debug ip dhcp snooping

**Overview** Use this command to enable the specified types of debugging for DHCP snooping. Use the **no** variant of this command to disable the specified types of debugging.

**Syntax** `debug ip dhcp snooping {all|acl|db|packet [detail]}`  
`no debug ip dhcp snooping {all|acl|db|packet [detail]}`

Parameter	Description
all	All DHCP snooping debug.
acl	DHCP snooping access list debug.
db	DHCP snooping binding database debug.
packet	DHCP snooping packet debug. For the <b>no</b> variant of this command, this option also disables detailed packet debug, if it was enabled.
detail	Detailed packet debug.

**Default** Disabled

**Mode** Privileged Exec

**Example** To enable access list debugging for DHCP snooping, use the commands:

```
awplus# debug ip dhcp snooping acl
```

**Related commands** [debug arp security](#)  
[show debugging ip dhcp snooping](#)  
[show log](#)  
[terminal monitor](#)

# ip dhcp snooping

**Overview** Use this command to enable DHCP snooping on one or more VLANs.  
Use the **no** variant of this command to disable DHCP snooping on the VLANs.

**Syntax** `ip dhcp snooping`  
`no ip dhcp snooping`

**Default** DHCP snooping is disabled on VLANs by default.

**Mode** Interface Configuration (VLANs)

**Usage notes** **Enabling DHCP snooping**

For DHCP snooping to operate on a VLAN, you must:

- enable the service on the switch by using the [service dhcp-snooping](#) command, and
- enable DHCP snooping on the particular VLAN by using the [ip dhcp snooping](#) command, and
- if there is an external DHCP server, configure the port connected to the server as a trusted port, by using the [ip dhcp snooping trust](#) command

**Disabling DHCP snooping**

Use **no service dhcp-snooping** to disable DHCP snooping.

Disabling DHCP snooping removes all DHCP snooping configuration from the running configuration, except for:

- any DHCP snooping maximum bindings settings ([ip dhcp snooping max-bindings](#)), and
- any additional DHCP snooping-based ACLs you have created for filtering on untrusted ports.

You must remove any such additional DHCP snooping-based ACLs, using the **no access-group** command. This is because these ACLs block all traffic except for traffic that matches DHCP snooping entries. Once you have disabled DHCP snooping, these ACLs will block all traffic. Note that if you disable DHCP snooping on particular VLANs (using the **no ip dhcp snooping** command), you need to make sure you remove any such additional ACLs that apply to those VLANs.

If you re-enable the service, the switch repopulates the DHCP snooping database from the dynamic lease entries in the database backup file (see the [ip dhcp snooping database](#) command). It also updates the lease expiry times.

**Examples** To enable DHCP snooping on VLANs 2 to 4, use the commands:

```
awplus# configure terminal
awplus(config)# interface vlan2-vlan4
awplus(config-if)# ip dhcp snooping
```

To disable DHCP snooping on the switch, use the command:

```
awplus# configure terminal
awplus(config)# interface vlan2-vlan4
awplus(config-if)# no ip dhcp snooping
```

**Related  
commands**

[ip dhcp snooping trust](#)  
[service dhcp-snooping](#)  
[show ip dhcp snooping](#)

# ip dhcp snooping agent-option

**Overview** Use this command to enable DHCP Relay Agent Option 82 information insertion on the switch. When this is enabled, the switch:

- inserts DHCP Relay Agent Option 82 information into DHCP packets that it receives on untrusted ports
- removes DHCP Relay Agent Option 82 information from DHCP packets that it sends to untrusted ports.

Use the **no** variant of this command to disable DHCP Relay Agent Option 82 insertion.

**Syntax** `ip dhcp snooping agent-option`  
`no ip dhcp snooping agent-option`

**Default** DHCP Relay Agent Option 82 insertion is enabled by default when DHCP snooping is enabled.

**Mode** Global Configuration

**Usage notes** DHCP snooping must also be enabled on the switch ([service dhcp-snooping](#) command), and on the VLANs ([ip dhcp snooping](#) command).

**Example** To disable DHCP Relay Agent Option 82 on the switch, use the commands:

```
awplus# configure terminal
awplus(config)# no ip dhcp snooping agent-option
```

**Related commands** [ip dhcp snooping](#)  
[ip dhcp snooping agent-option allow-untrusted](#)  
[service dhcp-snooping](#)  
[show ip dhcp snooping](#)



# ip dhcp snooping agent-option allow-untrusted

**Overview** Use this command to enable DHCP Relay Agent Option 82 information reception on untrusted ports. When this is enabled, the switch accepts incoming DHCP packets that contain DHCP Relay Agent Option 82 information on untrusted ports. Use the **no** variant of this command to disable DHCP Relay Agent Option 82 information reception on untrusted ports.

**Syntax** `ip dhcp snooping agent-option allow-untrusted`  
`no ip dhcp snooping agent-option allow-untrusted`

**Default** Disabled

**Mode** Global Configuration

**Usage notes** If the switch is connected via untrusted ports to edge switches that insert DHCP Relay Agent Option 82 information into DHCP packets, you may need to allow these DHCP packets through the untrusted ports, by using this command. When this is disabled (default), the switch treats incoming DHCP packets on untrusted ports that contain DHCP Relay Agent Option 82 information as DHCP snooping violations: it drops them and applies any violation action specified by the [ip dhcp snooping violation](#) command. The switch stores statistics for packets dropped; to display these statistics, use the [show ip dhcp snooping statistics](#) command.

**Example** To enable DHCP snooping Option 82 information reception on untrusted ports, use the commands:

```
awplus# configure terminal
awplus(config)# ip dhcp snooping agent-option allow-untrusted
```

**Related commands** [ip dhcp snooping agent-option](#)  
[ip dhcp snooping violation](#)  
[show ip dhcp snooping](#)  
[show ip dhcp snooping statistics](#)

# ip dhcp snooping agent-option circuit-id vlantriplet

**Overview** Use this command to specify the Circuit ID sub-option of the DHCP Relay Agent Option 82 field as the VLAN ID and port number. The Circuit ID specifies the switch port and VLAN ID that the client-originated DHCP packet was received on.

Use the **no** variant of this command to set the Circuit ID to the default, the VLAN ID and Ifindex (interface number).

**Syntax** `ip dhcp snooping agent-option circuit-id vlantriplet`  
`no ip dhcp snooping agent-option circuit-id`

**Default** By default, the Circuit ID is the VLAN ID and Ifindex (interface number).

**Mode** Interface Configuration for a VLAN interface.

**Usage** The Circuit ID sub-option is included in the DHCP Relay Agent Option 82 field of forwarded client DHCP packets:

- DHCP snooping Option 82 information insertion is enabled ([ip dhcp snooping agent-option](#) command; enabled by default), and
- DHCP snooping is enabled on the switch ([service dhcp-snooping](#)) and on the VLAN to which the port belongs ([ip dhcp snooping](#))

**Examples** To set the Circuit ID to `vlantriplet` for client DHCP packets received on `vlan1`, use the commands:

```
awplus# configure terminal
awplus(config)# interface vlan1
awplus(config-if)# ip dhcp snooping agent-option circuit-id
vlantriplet
```

To return the Circuit ID format to the default for `vlan1`, use the commands:

```
awplus# configure terminal
awplus(config)# interface vlan1
awplus(config-if)# no ip dhcp snooping agent-option circuit-id
```

**Related commands** [ip dhcp snooping agent-option](#)  
[ip dhcp snooping agent-option remote-id](#)  
[show ip dhcp snooping](#)  
[show ip dhcp snooping agent-option](#)

# ip dhcp snooping agent-option remote-id

**Overview** Use this command to specify the Remote ID sub-option of the DHCP Relay Agent Option 82 field. The Remote ID identifies the device that inserted the Option 82 information. If a Remote ID is not specified, the Remote ID sub-option is set to the switch's MAC address.

Use the **no** variant of this command to set the Remote ID to the default, the switch's MAC address.

**Syntax** `ip dhcp snooping agent-option remote-id <remote-id>`  
`no ip dhcp snooping agent-option remote-id`

Parameter	Description
<code>&lt;remote-id&gt;</code>	An alphanumeric (ASCII) string, 1 to 63 characters in length. If the Remote ID contains spaces, it must be enclosed in double quotes. Wildcards are not allowed.

**Default** The Remote ID is set to the switch's MAC address by default.

**Mode** Interface Configuration for a VLAN interface.

**Usage** The Remote ID sub-option is included in the DHCP Relay Agent Option 82 field of forwarded client DHCP packets:

- DHCP snooping Option 82 information insertion is enabled ([ip dhcp snooping agent-option](#) command; enabled by default), and
- DHCP snooping is enabled on the switch ([service dhcp-snooping](#)) and on the VLAN to which the port belongs ([ip dhcp snooping](#))

**Examples** To set the Remote ID to `myid` for client DHCP packets received on `vlan1`, use the commands:

```
awplus# configure terminal
awplus(config)# interface vlan1
awplus(config-if)# ip dhcp snooping agent-option remote-id myid
```

To return the Remote ID format to the default for `vlan1`, use the commands:

```
awplus# configure terminal
awplus(config)# interface vlan1
awplus(config-if)# no ip dhcp snooping agent-option remote-id
```

**Related commands** [ip dhcp snooping agent-option](#)  
[ip dhcp snooping agent-option circuit-id vlantriplet](#)  
[show ip dhcp snooping](#)  
[show ip dhcp snooping agent-option](#)

# ip dhcp snooping binding

**Overview** Use this command to manually add a dynamic-like entry (with an expiry time) to the DHCP snooping database. Once added to the database, this entry is treated as a dynamic entry, and is stored in the DHCP snooping database backup file. This command is not stored in the switch's running configuration.

Use the **no** variant of this command to delete a dynamic entry for an IP address from the DHCP snooping database, or to delete all dynamic entries from the database.

**CAUTION: If you remove entries from the database for current clients, they will lose IP connectivity until they request and receive a new DHCP lease. If you clear all entries, all clients connected to untrusted ports will lose connectivity.**

**Syntax** ip dhcp snooping binding <ipaddr> [<macaddr>] vlan <vid>  
interface <port> expiry <expiry-time>  
no ip dhcp snooping binding [<ipaddr>]

Parameter	Description
<ipaddr>	Client's IP address.
<macaddr>	Client's MAC address in HHHH.HHHH.HHHH format.
<vid>	The VLAN ID for the entry, in the range 1 to 4094.
<port>	The port the client is connected to. The port can be a switch port, or a static or dynamic link aggregation (channel group).
<expiry-time>	The expiry time for the entry, in the range 5 to 2147483647 seconds.

**Mode** Privileged Exec

**Usage notes** Note that dynamic entries can also be deleted from the DHCP snooping database by using the [clear ip dhcp snooping binding](#) command.

To add or remove static entries from the database, use the [ip source binding](#) command.

**Example** To restore an entry in the DHCP snooping database for a DHCP client with the IP address 192.168.1.2, MAC address 0001.0002.0003, on port1.0.6 of vlan6, and with an expiry time of 1 hour, use the commands:

```
awplus# ip dhcp snooping binding 192.168.1.2 0001.0002.0003  
vlan 6 interface port1.0.6 expiry 3600
```

**Related commands** [clear ip dhcp snooping binding](#)  
[ip source binding](#)  
[show ip dhcp snooping binding](#)

# ip dhcp snooping database

**Overview** Use this command to set the location of the file to which the dynamic entries in the DHCP snooping database are written. This file provides a backup for the DHCP snooping database.

Use the **no** variant of this command to set the database location back to the default, a folder named nvs within Flash memory.

**Syntax** `ip dhcp snooping database {nvs|flash|card}`  
`no ip dhcp snooping database`

Parameter	Description
nvs	The switch checks the database and writes the file to a folder named nvs within Flash memory on the switch at 2 second intervals if it has changed.
flash	The switch checks the database and writes the file to Flash memory on the switch at 60 second intervals if it has changed.
card	The switch checks the database and writes the file to an SD card installed in the switch at 2 second intervals if it has changed. Note that a current DHCP snooping backup database file is essential to maintain connectivity for DHCP clients after a switch reboot. If you configure the switch to save this file to an SD card, we recommend that you ensure the card is always present.

**Default** nvs

**Mode** Global Configuration

**Usage notes** If the location of the backup file is changed by using this command, a new file is created in the new location, and the old version of the file remains in the old location. This can be removed if necessary (hidden file: **.dhcp.dsn.gz**).

**Example** To set the location of the DHCP snooping database to Flash memory, use the commands:

```
awplus# configure terminal
awplus(config)# ip dhcp snooping database flash
```

**Related commands** [show ip dhcp snooping](#)

# ip dhcp snooping delete-by-client

**Overview** Use this command to set the switch to remove a dynamic entry from the DHCP snooping database when it receives a valid DHCP release message with matching IP address, VLAN ID, and client hardware address on an untrusted port, and to discard release messages that do not match an entry in the database.

Use the **no** variant of this command to set the switch to forward DHCP release messages received on untrusted ports without removing any entries from the database.

**Syntax** `ip dhcp snooping delete-by-client`  
`no ip dhcp snooping delete-by-client`

**Default** Enabled: by default, DHCP lease entries are deleted from the DHCP snooping database when matching DHCP release messages are received.

**Mode** Global Configuration

**Usage** DHCP clients send a release message when they no longer wish to use the IP address they have been allocated by a DHCP server. Use this command to enable DHCP snooping to use the information in these messages to remove entries from its database immediately. Use the **no** variant of this command to ignore these release messages. Lease entries corresponding to ignored DHCP release messages eventually time out when the lease expires.

**Examples** To set the switch to delete DHCP snooping lease entries from the DHCP snooping database when a matching release message is received, use the commands:

```
awplus# configure terminal
awplus(config)# ip dhcp snooping delete-by-client
```

To set the switch to forward and ignore the content of any DHCP release messages it receives, use the commands:

```
awplus# configure terminal
awplus(config)# no ip dhcp snooping delete-by-client
```

**Related commands** [show ip dhcp snooping](#)

# ip dhcp snooping delete-by-linkdown

**Overview** Use this command to set the switch to remove a dynamic entry from the DHCP snooping database when its port goes down. If the port is part of an aggregated link, the entries in the database are only deleted if all the ports in the aggregated link are down.

Use the **no** variant of this command to set the switch not to delete entries when ports go down.

**Syntax** `ip dhcp snooping delete-by-linkdown`  
`no ip dhcp snooping delete-by-linkdown`

**Default** Disabled: by default DHCP Snooping bindings are not deleted when an interface goes down.

**Mode** Global Configuration

**Examples** To set the switch to delete DHCP snooping lease entries from the DHCP snooping database when links go down, use the commands:

```
awplus# configure terminal
awplus(config)# ip dhcp snooping delete-by-linkdown
```

To set the switch not to delete DHCP snooping lease entries from the DHCP snooping database when links go down, use the commands:

```
awplus# configure terminal
awplus(config)# no ip dhcp snooping delete-by-linkdown
```

**Related commands** [show ip dhcp snooping](#)

# ip dhcp snooping max-bindings

**Overview** Use this command to set the maximum number of DHCP lease entries that can be stored in the DHCP snooping database for each of the ports. Once this limit has been reached, no further DHCP lease allocations made to devices on the port are stored in the database.

Use the **no** variant of this command to reset the maximum to the default, 1.

**Syntax** `ip dhcp snooping max-bindings <0-520>`  
`no ip dhcp snooping max-bindings`

Parameter	Description
<0-520>	The maximum number of bindings that will be stored for the port in the DHCP snooping binding database. If 0 is specified, no entries will be stored in the database for the port.

**Default** The default for maximum bindings is 1.

**Mode** Interface Configuration (port)

**Usage notes** The maximum number of leases cannot be changed for a port while there are DHCP snooping Access Control Lists (ACL) associated with the port. Before using this command, remove any DHCP snooping ACLs associated with the ports. To display ACLs used for DHCP snooping, use the [show ip dhcp snooping acl](#) command.

In general, the default (1) will work well on an edge port with a single directly connected DHCP client. If the port is on an aggregation switch that is connected to an edge switch with multiple DHCP clients connected through it, then use this command to increase the number of lease entries for the port.

If there are multiple VLANs configured on the port, the limit is shared between all the VLANs on this port. For example, the default only allows one lease to be stored for one VLAN. To allow connectivity for the other VLANs, use this command to increase the number of lease entries for the port.

**Example** To set the maximum number of bindings to be stored in the DHCP snooping database to 10 per port for ports 1.0.1 to 1.0.6, use the commands:

```
awplus# configure terminal
awplus(config)# interface port1.0.1-port1.0.6
awplus(config-if)# ip dhcp snooping max-bindings 10
```

**Related commands** [access-group](#)  
[show ip dhcp snooping acl](#)  
[show ip dhcp snooping interface](#)



# ip dhcp snooping trust

**Overview** Use this command to set the ports to be DHCP snooping trusted ports. Use the **no** variant of this command to return the ports to their default as untrusted ports.

**Syntax** `ip dhcp snooping trust`  
`no ip dhcp snooping trust`

**Default** All ports are untrusted by default.

**Mode** Interface Configuration (port)

**Usage notes** Typically, ports connecting the switch to trusted elements in the network (towards the core) are set as trusted ports, while ports connecting untrusted network elements are set as untrusted. Configure ports connected to DHCP servers as trusted ports.

**Example** To set switch ports 1.0.1 and 1.0.2 to be trusted ports, use the commands:

```
awplus# configure terminal
awplus(config)# interface port1.0.1-port1.0.2
awplus(config-if)# ip dhcp snooping trust
```

**Related commands** [show ip dhcp snooping interface](#)

# ip dhcp snooping verify mac-address

**Overview** Use this command to verify that the source MAC address and client hardware address match in DHCP packets received on untrusted ports.

Use the **no** variant of this command to disable MAC address verification.

**Syntax** `ip dhcp snooping verify mac-address`  
`no ip dhcp snooping verify mac-address`

**Default** Enabled—source MAC addresses are verified by default.

**Mode** Global Configuration

**Usage** When MAC address verification is enabled, the switch treats DHCP packets with source MAC address and client hardware address that do not match as DHCP snooping violations: it drops them and applies any other violation action specified by the [ip dhcp snooping violation](#) command. To bring the port back up again after any issues have been resolved, use the [shutdown](#) command.

**Example** To disable MAC address verification on the switch, use the commands:

```
awplus# configure terminal
awplus(config)# no ip dhcp snooping verify mac-address
```

**Related commands** [ip dhcp snooping violation](#)  
[show ip dhcp snooping](#)  
[show ip dhcp snooping statistics](#)

# ip dhcp snooping violation

**Overview** Use this command to specify the action the switch will take when it detects a DHCP snooping violation by a DHCP packet on the ports.

Use the **no** variant of this command to disable the specified violation actions, or all violation actions.

**Syntax** `ip dhcp snooping violation {log|trap|link-down} ...`  
`no ip dhcp snooping violation [{log|trap|link-down} ...]`

Parameter	Description
log	Generate a log message. To display these messages, use the <a href="#">show log</a> command. Default: disabled.
trap	Generate an SNMP notification (trap). To send SNMP notifications, SNMP must also be configured, and DHCP snooping notifications must be enabled using the <a href="#">snmp-server enable trap</a> command. Notifications are limited to one per second and to one per source MAC and violation reason. Default: disabled.
link-down	Set the port status to link-down. Default: disabled.

**Default** By default, DHCP packets that violate DHCP snooping are dropped, but no other violation action is taken.

**Mode** Interface Configuration (port)

**Usage notes** If a port has been shut down in response to a violation, to bring it back up again after any issues have been resolved, use the [shutdown](#) command.

IP packets dropped by DHCP snooping filters do not result in other DHCP snooping violation actions.

**Example** To set the switch to send an SNMP notification and set the link status to link-down if it detects a DHCP snooping violation on switch ports 1.0.1 to 1.0.4, use the commands:

```
awplus# configure terminal
awplus(config)# snmp-server enable trap dhcpsnooping
awplus(config)# interface port1.0.1-port1.0.4
awplus(config-if)# ip dhcp snooping violation trap link-down
```

**Related commands** [show ip dhcp snooping interface](#)  
[show log](#)  
[snmp-server enable trap](#)

# ip source binding

**Overview** Use this command to add or replace a static entry in the DHCP snooping database. Use the **no** variant of this command to delete the specified static entry or all static entries from the database.

**Syntax** `ip source binding <ipaddr> [<macaddr>] vlan <vid> interface <port>`  
`no ip source binding [<ipaddr>]`

Parameter	Description
<ipaddr>	Client's IP address. If there is already an entry in the DHCP snooping database for this IP address, then this command replaces it with the new entry.
<macaddr>	Client's MAC address in HHHH.HHHH.HHHH format.
<vid>	The VLAN ID associated with the entry.
<port>	The port the client is connected to.

**Mode** Global Configuration

**Usage notes** This command removes static entries from the database. To remove dynamic entries, use the [clear ip dhcp snooping binding](#) command or the **no** variant of the [ip dhcp snooping binding](#) command.

**Examples** To add a static entry to the DHCP snooping database for a client with the IP address 192.168.1.2, MAC address 0001.0002.0003, on port1.0.6 of vlan6, use the command:

```
awplus# configure terminal
awplus(config)# ip source binding 192.168.1.2 0001.0002.0003
vlan 6 interface port1.0.6
```

To remove the static entry for IP address 192.168.1.2 from the database, use the commands:

```
awplus# configure terminal
awplus(config)# no ip source binding 192.168.1.2
```

To remove all static entries from the database, use the commands:

```
awplus# configure terminal
awplus(config)# no ip source binding
```

**Related commands**

- clear ip dhcp snooping binding
- ip dhcp snooping binding
- show ip dhcp snooping binding
- show ip source binding

# service dhcp-snooping

**Overview** Use the **service dhcp-snooping** command to enable the DHCP snooping service globally on the switch. As well, you need to enable it on the desired VLANs, using the **ip dhcp snooping** command. The switch creates a global DHCP snooping Access Control list (ACL) the first time you use the **ip dhcp snooping** command, to send DHCP packets to the CPU for processing. Note that the switch will forward all DHCP traffic to the CPU, no matter what VLAN it belongs to.

Use the **no** variant of this command to disable the DHCP snooping service on the switch.

**Syntax** `service dhcp-snooping`  
`no service dhcp-snooping`

**Default** Disabled

**Mode** Global Configuration

**Usage notes** **Enabling DHCP snooping**

For DHCP snooping to operate on a VLAN, you must:

- enable the service on the switch by using this command, and
- enable DHCP snooping on the particular VLAN by using the **ip dhcp snooping** command, and
- if there is an external DHCP server, configure the port connected to the server as a trusted port, by using the **ip dhcp snooping trust** command

**Disabling DHCP snooping**

Use **no service dhcp-snooping** to disable DHCP snooping.

Disabling DHCP snooping removes all DHCP snooping configuration from the running configuration, except for:

- any DHCP snooping maximum bindings settings (**ip dhcp snooping max-bindings**), and
- any additional DHCP snooping-based ACLs you have created for filtering on untrusted ports.

You must remove any such additional DHCP snooping-based ACLs, using the **no access-group** command. This is because these ACLs block all traffic except for traffic that matches DHCP snooping entries. Once you have disabled DHCP snooping, these ACLs will block all traffic. Note that if you disable DHCP snooping on particular VLANs (using the **no ip dhcp snooping** command), you need to make sure you remove any such additional ACLs that apply to those VLANs.

If you re-enable the service, the switch repopulates the DHCP snooping database from the dynamic lease entries in the database backup file (see the **ip dhcp snooping database** command). It also updates the lease expiry times.

**Examples** To enable the DHCP snooping service on only the VLANs that have DHCP snooping enabled, use the command:

```
awplus# configure terminal  
awplus(config)# service dhcp-snooping
```

To disable the DHCP snooping service on the switch, use the command:

```
awplus# configure terminal  
awplus(config)# no service dhcp-snooping
```

**Related commands**

- [access-group](#)
- [ip dhcp snooping](#)
- [ip dhcp snooping database](#)
- [ip dhcp snooping max-bindings](#)
- [show ip dhcp snooping](#)

**Command changes** Version 5.4.9-2.1: **per-vlan** parameter added for IE510, IE340, IE300, SBx908 GEN2, x950, x930, x510.

# show arp security

**Overview** Use this command to display ARP security configuration.

**Syntax** show arp security

**Mode** User Exec and Privileged Exec

**Example** To display ARP security configuration on the switch use the command:

```
awplus# show arp security
```

**Table 1:** Example output from the **show arp security** command

```
awplus# show arp security

ARP Security Information:
  Total VLANs enabled ..... 2
  Total VLANs disabled ..... 11
  vlan1 ..... Disabled
  vlan2 ..... Disabled
  vlan3 ..... Disabled
  vlan4 ..... Disabled
  vlan5 ..... Disabled
  vlan100 ..... Disabled
  vlan101 ..... Disabled
  vlan102 ..... Disabled
  vlan103 ..... Disabled
  vlan104 ..... Disabled
  vlan105 ..... Enabled
  vlan1000 ..... Disabled
  vlan1001 ..... Enabled
```

**Table 2:** Parameters in the output from the **show arp security** command

Parameter	Description
Total VLANs enabled	The number of VLANs that have ARP security enabled.
Total VLANs disabled	The number of VLANs that have ARP security disabled.

**Related commands**

- [arp security](#)
- [show arp security interface](#)
- [show arp security statistics](#)



# show arp security interface

**Overview** Use this command to display ARP security configuration for the specified ports or all ports.

**Syntax** `show arp security interface [<port-list>]`

Parameter	Description
<code>&lt;port-list&gt;</code>	The ports to display ARP security information about. The port list can include switch ports, and static or dynamic aggregated links.

**Mode** User Exec and Privileged Exec

**Example** To display ARP security configuration for ports, use the command:

```
awplus# show arp security interface
```

**Table 3:** Example output from the **show arp security interface** command

```
awplus#show arp security interface

Arp Security Port Status and Configuration:

Port: Provisioned ports marked with brackets, e.g. (portx.y.z)
KEY:  LG = Log
      TR = Trap
      LD = Link down

Port          Action
-----
port1.0.1    -- -- --
port1.0.2    -- -- --
port1.0.3    LG TR LD
port1.0.4    LG -- --
port1.0.5    LG -- --
port1.0.6    LG TR --
port1.0.7    LG -- LD
...
```

**Table 4:** Parameters in the output from the **show arp security interface** command

Parameter	Description
Action	The action the switch takes when it detects an ARP security violation on the port.
Port	The port. Parentheses indicate that ports are configured for provisioning.
LG, Log	Generate a log message
TR, Trap	Generate an SNMP notification (trap).
LD, Link down	Shut down the link.

**Related commands**

- arp security violation
- show arp security
- show arp security statistics
- show log
- snmp-server enable trap

# show arp security statistics

**Overview** Use this command to display ARP security statistics for the specified ports or all ports.

**Syntax** `show arp security statistics [detail] [interface <port-list>]`

Parameter	Description
detail	Display detailed statistics.
interface <port-list>	Display statistics for the specified ports. The port list can include switch ports, and static or dynamic aggregated links

**Mode** User Exec and Privileged Exec

**Example** To display the brief statistics for the ARP security, use the command:

```
awplus# show arp security statistics
```

**Table 5:** Example output from the **show arp security statistics** command

```
awplus# show arp security statistics

DHCP Snooping ARP Security Statistics:
  Interface      In      In
                Packets Discards
-----
port1.0.3       20      20
port1.0.4       30      30
port1.0.12     120      0
```

**Table 6:** Parameters in the output from the **show arp security statistics** command

Parameter	Description
Interface	A port name. Parentheses indicate that ports are configured for provisioning.
In Packets	The total number of incoming ARP packets that are processed by DHCP Snooping ARP Security
In Discards	The total number of ARP packets that are dropped by DHCP Snooping ARP Security.

**Table 7:** Example output from the **show arp security statistics detail** command

```
awplus#show arp security statistics detail

DHCP Snooping ARP Security Statistics:
Interface ..... port1.0.3
  In Packets ..... 20
  In Discards ..... 20
    No Lease ..... 20
    Bad Vlan ..... 0
    Bad Port ..... 0
    Source Ip Not Allocated .... 0
Interface ..... port1.0.4
  In Packets ..... 30
  In Discards ..... 30
    No Lease ..... 30
    Bad Vlan ..... 0
    Bad Port ..... 0
    Source Ip Not Allocated .... 0
Interface ..... port1.0.12
  In Packets ..... 120
  In Discards ..... 0
    No Lease ..... 0
    Bad Vlan ..... 0
    Bad Port ..... 0
    Source Ip Not Allocated .... 0
```

**Related  
commands**

- [arp security](#)
- [arp security violation](#)
- [clear arp security statistics](#)
- [show arp security](#)
- [show arp security interface](#)
- [show log](#)

# show debugging arp security

**Overview** Use this command to display the ARP security debugging configuration.

**Syntax** show debugging arp security

**Mode** User and Privileged Exec

**Example** To display the debugging settings for ARP security on the switch, use the command:

```
awplus# show debugging arp security
```

**Table 8:** Example output from the **show debugging arp security** command

```
awplus# show debugging arp security

ARP Security debugging status:
  ARP Security debugging is off
```

**Related commands** [arp security violation](#)  
[debug arp security](#)

# show debugging ip dhcp snooping

**Overview** Use this command to display the DHCP snooping debugging configuration.

**Syntax** show debugging ip dhcp snooping

**Mode** User Exec and Privileged Exec

**Example** To display the DHCP snooping debugging configuration, use the command:

```
awplus# show debugging ip dhcp snooping
```

**Table 9:** Example output from the **show debugging ip dhcp snooping** command

```
awplus# show debugging ip dhcp snooping

DHCP snooping debugging status:
  DHCP snooping debugging is off
  DHCP snooping all debugging is off
  DHCP snooping acl debugging is off
  DHCP snooping binding DB debugging is off
  DHCP snooping packet debugging is off
  DHCP snooping detailed packet debugging is off
```

**Related commands** [debug ip dhcp snooping](#)  
[show log](#)

# show ip dhcp snooping

**Overview** Use this command to display DHCP snooping global configuration on the switch.

**Syntax** show ip dhcp snooping

**Mode** User Exec and Privileged Exec

**Example** To display global DHCP snooping configuration on the switch, use the command:

```
awplus# show ip dhcp snooping
```

Table 37-1: Example output from **show ip dhcp snooping**

```
DHCP Snooping Information:
  DHCP Snooping service ..... Enabled
  Binding delete by client ..... Disabled
  Binding delete by link down ..... Disabled
  Verify MAC address ..... Disabled
  SNMP DHCP Snooping trap ..... Disabled

DHCP Snooping database:
  Database location ..... nvs   Number of entries in
  database ..... 2

DHCP Snooping VLANs:
  Total VLANs enabled ..... 1
  Total VLANs disabled ..... 9
  vlan1 ..... Enabled
  vlan2 ..... Disabled
  vlan3 ..... Disabled
  vlan4 ..... Disabled
  vlan5 ..... Disabled
  vlan100 ..... Disabled
  vlan101 ..... Disabled
  vlan105 ..... Disabled
  vlan1000 ..... Disabled
  vlan1001 ..... Disabled
```

- Related commands**
- [service dhcp-snooping](#)
  - [show arp security](#)
  - [show ip dhcp snooping acl](#)
  - [show ip dhcp snooping binding](#)
  - [show ip dhcp snooping interface](#)

# show ip dhcp snooping acl

**Overview** Use this command to display information about the Access Control Lists (ACL) that are using the DHCP snooping database.

**Syntax** `show ip dhcp snooping acl`  
`show ip dhcp snooping acl [detail|hardware] [interface`  
`[<interface-list>]]`

Parameter	Description
detail	Detailed DHCP Snooping ACL information.
hardware	DHCP Snooping hardware ACL information.
interface	ACL Interface information.
<interface-list>	The interfaces to display information about.

**Mode** User Exec and Privileged Exec

**Example** To display DHCP snooping ACL information, use the command:

```
awplus# show ip dhcp snooping acl
```

**Table 38:** Example output from the **show ip dhcp snooping acl** command

```
awplus#show ip dhcp snooping acl
```

DHCP Snooping Based Filters Summary:

Interface	Bindings	Maximum Bindings	Template Filters	Attached Hardware Filters
port1.0.1	1	520	0	0
port1.0.2	1	3	2	6
port1.0.3	1	2	4	8
port1.0.4	1	2	7	14
port1.0.5	0	2	6	12
port1.0.6	0	1	0	0
port1.0.7	0	1	0	0
port1.0.8	0	1	0	0
port1.0.9	0	1	0	0
port1.0.10	0	1	0	0
port1.0.11	0	1	0	0
port1.0.12	0	1	0	0
(port2.0.1 )	0	520	0	0
(port2.0.2 )	0	1	0	0

To display DHCP snooping hardware ACL information, use the command:

```
awplus# show ip dhcp snooping acl hardware
```



**Table 39:** Example output from the **show ip dhcp snooping acl hardware** command

```
awplus#show ip dhcp snooping acl hardware
```

DHCP Snooping Based Filters in Hardware:

Interface	Access-list(/ClassMap)	Source IP	Source MAC
port1.0.2	dhcpsn1	10.10.10.10	aaaa.bbbb.cccc
port1.0.2	dhcpsn1	20.20.20.20	0000.aaaa.bbbb
port1.0.2	dhcpsn1	0.0.0.0	0000.0000.0000
port1.0.2	dhcpsn1	0.0.0.0	0000.0000.0000
port1.0.2	dhcpsn1	0.0.0.0	0000.0000.0000
port1.0.2	dhcpsn1	0.0.0.0	0000.0000.0000
port1.0.3	dhcpsn2/cmap1	30.30.30.30	aaaa.bbbb.dddd
port1.0.3	dhcpsn2/cmap1	40.40.40.40	0000.aaaa.cccc
port1.0.3	dhcpsn2/cmap1	50.50.50.50	0000.aaaa.dddd
port1.0.3	dhcpsn2/cmap1	60.60.60.60	0000.aaaa.eeee
port1.0.3	dhcpsn2/cmap1	0.0.0.0	0000.0000.0000
port1.0.3	dhcpsn2/cmap1	0.0.0.0	0000.0000.0000
port1.0.3	dhcpsn2/cmap1	0.0.0.0	0000.0000.0000
port1.0.3	dhcpsn2/cmap1	0.0.0.0	0000.0000.0000
port1.0.4	dhcpsn3/cmap2	70.70.70.70	
port1.0.4	dhcpsn3/cmap2	80.80.80.80	
port1.0.4	dhcpsn2/cmap1	70.70.70.70	
port1.0.4	dhcpsn2/cmap1	80.80.80.80	
port1.0.4	dhcpsn1	70.70.70.70	
port1.0.4	dhcpsn1	80.80.80.80	

To display detailed DHCP snooping ACL information for port 1.0.4, use the command:

```
awplus# show ip dhcp snooping acl detail interface port1.0.4
```

**Table 40:** Example output from the **show ip dhcp snooping acl detail interface** command

```
awplus#show ip dhcp snooping acl detail interface port1.0.4

DHCP Snooping Based Filters Information:

port1.0.4 : Maximum Bindings ..... 2
port1.0.4 : Template filters ..... 7
port1.0.4 : Attached hardware filters .. 14
port1.0.4 : Current bindings ..... 1, 1 free
port1.0.4   Client 1 ..... 120.120.120.120
port1.0.4 : Templates: cheese (via class-map: cmap2)
port1.0.4 : 10 permit ip dhcpsnooping 100.0.0.0/8
port1.0.4 : Template: dhcpsn2 (via class-map: cmap1)
port1.0.4 : 10 permit ip dhcpsnooping any
port1.0.4 : 20 permit ip dhcpsnooping 10.0.0.0/8
port1.0.4 : 30 permit ip dhcpsnooping 20.0.0.0/8
port1.0.4 : 40 permit ip dhcpsnooping 30.0.0.0/8
port1.0.4 : Template: dhcpsn1 (via access-group)
port1.0.4 : 10 permit ip dhcpsnooping any mac dhcpsnooping abcd.0000.0000 00
00.ffff.ffff
port1.0.4 : 20 permit ip dhcpsnooping any
```

**Related commands** [access-list hardware \(named hardware ACL\)](#)  
[show access-list \(IPv4 Hardware ACLs\)](#)

# show ip dhcp snooping agent-option

**Overview** Use this command to display DHCP snooping Option 82 information for all interfaces, a specific interface or a range of interfaces.

**Syntax** `show ip dhcp snooping agent-option [interface <interface-list>]`

Parameter	Description
interface	Specify the interface.
<interface-list>	The name of the interface or interfaces.

**Mode** User Exec and Privileged Exec

**Examples** To display DHCP snooping Option 82 information for all interfaces, use the command:

```
awplus# show ip dhcp snooping agent-option
```

To display DHCP snooping Option 82 information for vlan1, use the command:

```
awplus# show ip dhcp snooping agent-option interface vlan1
```

To display DHCP snooping Option 82 information for port1.0.1, use the command:

```
awplus# show ip dhcp snooping agent-option interface port1.0.1
```

**Output** Figure 37-1: Example output from the **show ip dhcp snooping agent-option** command

```
awplus#show ip dhcp snooping agent-option

DHCP Snooping Option 82 Configuration:

Key:      C Id = Circuit Id Format
          R Id = Remote Id
          S Id = Subscriber Id

Option 82 insertion ..... Enabled
Option 82 on untrusted ports ..... Not allowed

-----

vlan1     C Id = vlanifindex
          R Id = Access-Island-01-M1
vlan2     C Id = vlantriplet
          R Id = Access-Island-01-M1
vlan3     C Id = vlantriplet
          R Id = Access-Island-01-M3
vlan4     C Id = vlantriplet
          R Id = 0000.cd28.074c
vlan5     C Id = vlantriplet
          R Id = 0000.cd28.074c
vlan6     C Id = vlantriplet
          R Id = 0000.cd28.074c
port1.0.1 S Id =
port1.0.2 S Id =
port1.0.3 S Id = phone_1
port1.0.4 S Id =
port1.0.5 S Id = PC_1
port1.0.6 S Id = phone_2
```

**Related commands**

- [ip dhcp snooping agent-option](#)
- [ip dhcp snooping agent-option circuit-id vlantriplet](#)
- [ip dhcp snooping agent-option remote-id](#)
- [show ip dhcp snooping](#)
- [show ip dhcp snooping interface](#)

# show ip dhcp snooping binding

**Overview** Use this command to display all dynamic and static entries in the DHCP snooping binding database.

**Syntax** show ip dhcp snooping binding

**Mode** User Exec and Privileged Exec

**Example** To display entries in the DHCP snooping database, use the command:

```
awplus# show ip dhcp snooping binding
```

**Table 41:** Example output from the **show ip dhcp snooping binding** command

```
awplus# show ip dhcp snooping binding
DHCP Snooping Bindings:
```

Client IP Address	MAC Address	Server IP Address	VLAN	Port	Expires (sec)	Type
1.2.3.4	aaaa.bbbb.cccc	--	7	1.0.6	Infinite	Stat
1.2.3.6	any	--	4077	1.0.6	Infinite	Stat
1.3.4.5	any	--	1	sa1	Infinite	Stat
111.111.100.101	0000.0000.0001	111.112.1.1	1	1.0.6	4076	Dyna
111.111.101.108	0000.0000.0108	111.112.1.1	1	1.0.6	4084	Dyna
111.111.101.109	0000.0000.0109	111.112.1.1	1	1.0.6	4085	Dyna
111.211.100.101	--	--	1	1.0.2	2147483325	Dyna
111.211.100.109	00b0.0000.0009	111.112.111.111	1	1.0.2	21	Dyna
111.211.101.101	00b0.0000.0101	111.112.111.111	1	1.0.2	214	Dyna

Total number of bindings in database: 9

**Table 42:** Parameters in the output from the **show ip dhcp snooping binding** command

Parameter	Description
Client IP	The IP address of the DHCP client.
MAC Address	The MAC address of the DHCP client.
Server IP	The IP address of the DHCP server.
VLAN	The VLAN associated with this entry.
Port	The port the client is connected to.
Expires (sec)	The time in seconds until the lease expires.

**Table 42:** Parameters in the output from the **show ip dhcp snooping binding** command (cont.)

Parameter	Description
Type	The source of the entry: <ul style="list-style-type: none"><li>• Dyna: dynamically entered by snooping DHCP traffic, configured by the <a href="#">ip dhcp snooping binding</a> command, or loaded from the database backup file.</li><li>• Stat: added statically by the <a href="#">ip source binding</a> command</li></ul>
Total number of bindings in database	The total number of dynamic and static lease entries in the DHCP snooping database.

**Related commands**

- [ip dhcp snooping binding](#)
- [ip dhcp snooping max-bindings](#)
- [show ip source binding](#)

# show ip dhcp snooping interface

**Overview** Use this command to display information about DHCP snooping configuration and leases for the specified ports, or all ports.

**Syntax** `show ip dhcp snooping interface [<port-list>]`

Parameter	Description
<code>&lt;port-list&gt;</code>	The ports to display DHCP snooping configuration information for. If no ports are specified, information for all ports is displayed.

**Mode** User Exec and Privileged Exec

**Example** To display DHCP snooping information for all ports, use the command:

```
awplus# show ip dhcp snooping interface
```

**Table 43:** Example output from the **show ip dhcp snooping interface** command

```
awplus#show ip dhcp snooping interface

DHCP Snooping Port Status and Configuration:

Port: Provisioned ports marked with brackets, e.g. (portx.y.z)
Action: LG = Log
        TR = Trap
        LD = Link down
```

Port	Status	Full Leases	Max Leases	Action	Subscriber-ID
port1.0.1	Untrusted	1	1	LG -- --	
port1.0.2	Untrusted	0	50	LG TR LD	Building 1 Level 1
port1.0.3	Untrusted	0	50	LG -- --	
port1.0.4	Untrusted	0	50	LG -- --	Building 1 Level 2
port1.0.5	Untrusted	0	50	LG -- LD	Building 2 Level 1
port1.0.6	Untrusted	0	1	LG -- --	
port1.0.7	Untrusted	0	1	LG -- --	
port1.0.8	Untrusted	0	1	LG -- --	
port1.0.9	Untrusted	0	1	-- TR --	
port1.0.10	Untrusted	0	1	-- -- LD	
port1.0.11	Trusted	0	1	-- -- --	
port1.0.12	Trusted	0	1	-- -- --	

**Table 44:** Parameters in the output from the **show ip dhcp snooping interface** command

Parameter	Description
Port	The port interface name.
Status	The port status: untrusted (default) or trusted.
Full Leases	The number of entries in the DHCP snooping database for the port.
Max Leases	The maximum number of entries that can be stored in the database for the port.
Action	The DHCP snooping violation actions for the port.
Subscriber ID	The subscriber ID for the port. If the subscriber ID is longer than 34 characters, only the first 34 characters are displayed. To display the whole subscriber ID, use the command <b>show running-config dhcp</b> .

**Related commands**

- [show ip dhcp snooping](#)
- [show ip dhcp snooping statistics](#)
- [show running-config dhcp](#)



# show ip dhcp snooping statistics

**Overview** Use this command to display DHCP snooping statistics.

**Syntax** `show ip dhcp snooping statistics [detail] [interface <interface-list>]`

Parameter	Description
detail	Display detailed statistics.
interface <interface-list>	Display statistics for the specified interfaces. The interface list can contain switch ports, static or dynamic link aggregators (channel groups), or VLANs.

**Mode** User Exec and Privileged Exec

**Example** To show the current DHCP snooping statistics for all interfaces, use the command:

```
awplus# show ip dhcp snooping statistics
```

**Table 45:** Example output from the **show ip dhcp snooping statistics** command

```
awplus# show ip dhcp snooping statistics
```

DHCP Snooping Statistics:				
Interface	In BOOTP Packets	In BOOTP Requests	In Replies	In Discards
vlan1	444	386	58	223
port1.0.1	386	386	0	223
port1.0.2	0	0	0	0
port1.0.3	0	0	0	0
port1.0.4	0	0	0	0
port1.0.5	0	0	0	0
port1.0.6	58	0	58	0

**Table 46:** Example output from the **show ip dhcp snooping statistics detail** command

```
awplus# show ip dhcp snooping statistics detail

DHCP Snooping Statistics:
Interface ..... port1.0.1, All counters 0
Interface ..... port1.0.2, All counters 0
Interface ..... port1.0.3, All counters 0
Interface ..... port1.0.4
  In Packets ..... 50
    In BOOTP Requests ..... 25
    In BOOTP Replies ..... 25
  In Discards ..... 1
    Invalid BOOTP Information ..... 0
    Invalid DHCP ACK ..... 0
    Invalid DHCP Release or Decline ..... 0
    Invalid IP/UDP Header ..... 0
    Max Bindings Exceeded ..... 1
    Reply Received On Untrusted Port ..... 0
    Source MAC/CHADDR Mismatch ..... 0
    Static Entry Already Exists ..... 0
Interface ..... port1.0.5, All counters 0
Interface ..... port1.0.6, All counters 0
```

**Table 47:** Parameters in the output from the **show ip dhcp snooping statistics** command

Parameter	Description
Interface	The interface name.
In Packets	The total number of incoming packets that are processed by DHCP Snooping.
In BOOTP Requests	The total number of incoming BOOTP Requests.
In BOOTP Replies	The total number of incoming BOOTP Replies.
In Discards	The total number of incoming packets that have been discarded.
Invalid BOOTP Information	Packet contained invalid BOOTP information, such as an invalid BOOTP.OPCode.
Invalid DHCP ACK	A DHCP ACK message was discarded, for reasons such as missing Server Option or Lease Option.
Invalid DHCP Release or Decline	A DHCP Release or Decline message was discarded, for reasons such as mismatch between received interface and current binding information.
Invalid IP/UDP Header	A problem was detected in the IP or UDP header of the packet.

**Table 47:** Parameters in the output from the **show ip dhcp snooping statistics** command (cont.)

Parameter	Description
Max Bindings Exceeded	Accepting the packet would cause the maximum number of bindings on a port to be exceeded.
Reply Received On Untrusted Port	A BOOTP reply was received on an untrusted port.
Source MAC/CHADDR Mismatch	The L2 Source MAC address of the packet did not match the client hardware address field (BOOTP.CHADDR).
Static Entry Already Exists	An entry could not be added as a static entry already exists.

**Related commands**

- [clear ip dhcp snooping statistics](#)
- [ip dhcp snooping](#)
- [ip dhcp snooping violation](#)

# show ip source binding

**Overview** Use this command to display static entries in the DHCP snooping database. These are the entries that have been added by using the [ip source binding](#) command.

**Syntax** `show ip source binding`

**Mode** User Exec and Privileged Exec

**Example** To display static entries in the DHCP snooping database information, use the command:

```
awplus# show ip source binding
```

**Table 48:** Example output from the **show ip source binding** command

```
awplus# show ip source binding

IP Source Bindings:

Client      MAC
IP Address  Address          VLAN  Port           Expires
(sec)      Type
-----
1.1.1.1     0000.1111.2222  1     port1.0.1     Infinite  Static
```

**Table 49:** Parameters in the output from the **show ip source binding** command

Parameter	Description
Client IP Address	The IP address of the DHCP client.
MAC Address	The MAC address of the DHCP client.
VLAN	The VLAN ID the packet is received on.
Port	The Layer 2 port name the packet is received on.
Expires (sec)	Always infinite for static bindings, or when the leave time in the DHCP message was 0xffffffff (infinite).
Type	DHCP Snooping binding type: Static

**Related commands** [ip source binding](#)  
[show ip dhcp snooping binding](#)

# Part 6: Network Availability

# 38

# Ethernet Protection Switched Ring (EPSRing™) Commands

## Introduction

**Overview** This chapter provides an alphabetical reference for commands used to configure Ethernet Protection Switched Ring (EPSRing™). For more information, see the [EPSR Feature Overview and Configuration Guide](#).

For information on filtering and saving command output, see the [“Getting Started with AlliedWare Plus” Feature Overview and Configuration Guide](#).

- Command List**
- [“debug epsr”](#) on page 1400
  - [“epsr”](#) on page 1401
  - [“epsr configuration”](#) on page 1403
  - [“epsr datavlan”](#) on page 1404
  - [“epsr enhancedrecovery enable”](#) on page 1405
  - [“epsr flush-type”](#) on page 1406
  - [“epsr mode master controlvlan primary port”](#) on page 1408
  - [“epsr mode transit controlvlan”](#) on page 1409
  - [“epsr priority”](#) on page 1410
  - [“epsr state”](#) on page 1411
  - [“epsr topology-change”](#) on page 1412
  - [“epsr trap”](#) on page 1413
  - [“show debugging epsr”](#) on page 1414
  - [“show epsr”](#) on page 1415
  - [“show epsr common segments”](#) on page 1419
  - [“show epsr config-check”](#) on page 1420
  - [“show epsr <epsr-instance>”](#) on page 1421
  - [“show epsr <epsr-instance> counters”](#) on page 1422

- [“show epsr counters”](#) on page 1423
- [“show epsr summary”](#) on page 1424
- [“undebug epsr”](#) on page 1425

# debug epsr

**Overview** This command enables EPSR debugging.  
The **no** variant of this command disables EPSR debugging.

**Syntax** `debug epsr {info|msg|pkt|state|timer|all}`  
`no debug epsr {info|msg|pkt|state|timer|all}`

Parameter	Description
info	Send general EPSR information to the console. Using this parameter with the <b>no debug epsr</b> command will explicitly exclude the above information from being sent to the console.
msg	Send the decoded received and transmitted EPSR packets to the console. Using this parameter with the <b>no debug epsr</b> command will explicitly exclude the above packets from being sent to the console.
pkt	Send the received and transmitted EPSR packets as raw ASCII text to the console. Using this parameter with the <b>no debug epsr</b> command will explicitly exclude the above packets from being sent to the console.
state	Send EPSR state transitions to the console. Using this parameter with the <b>no debug epsr</b> command will explicitly exclude state transitions from being sent to the console.
timer	Send EPSR timer information to the console. Using this parameter with the <b>no debug epsr</b> command will explicitly exclude timer information from being sent to the console.
all	Send all EPSR debugging information to the console. Using this parameter with the <b>no debug epsr</b> command will explicitly exclude any debugging information from being sent to the console.

**Mode** Privileged Exec and Global Configuration

**Examples** To enable state transition debugging, use the command:

```
awplus# debug epsr state
```

To disable EPSR packet debugging, use the command:

```
awplus# no debug epsr pkt
```

**Related commands** [undebug epsr](#)



# epsr

**Overview** This command sets the timer values for an EPSR instance. These are only valid for master nodes.

**NOTE:** This command will only run on switches that are capable of running as an EPSR master node. However, even if your switch cannot function as an EPSR master node, you still may need to configure this command on whatever switch is the master within your EPSR network.

**Syntax** `epsr <epsr-instance> {hellotime <1-32767>|failovertime <2-65535> ringflaptime <0-65535>}`  
`no epsr <epsr-instance>`

**CAUTION:** Using the no variant of this command will remove the specified EPSR instance.

Parameter	Description
<code>&lt;epsr-instance&gt;</code>	Name of the EPSR instance.
<code>hellotime &lt;1-32767&gt;</code>	The number of seconds between the transmission of health check messages.
<code>failovertime &lt;2-65535&gt;</code>	The number of seconds that a master waits for a returning health check message before entering the failed state. <b>The failover time should be greater than twice the hellotime.</b> This is to force the master node to wait until it detects the absence of two sequential healthcheck messages before entering the failed state.
<code>ringflaptime &lt;0-65535&gt;</code>	The minimum number of seconds that a master must remain in the failed state.

**Mode** EPSR Configuration

**Examples** To set the hellotimer to 5 seconds for the EPSR instance called blue, use the command:

```
awplus(config-epsr)# epsr blue hellotime 5
```

To delete the EPSR instance called blue, use the command:

```
awplus(config-epsr)# no epsr blue
```

**Related commands** [epsr mode master controlvlan primary port](#)  
[epsr mode transit controlvlan](#)  
[epsr configuration](#)  
[epsr datavlan](#)  
[epsr state](#)

`epsr trap`

`show epsr`

# epsr configuration

**Overview** Use this command to enter EPSR Configuration mode so that EPSR can be configured.

**Syntax** `epsr configuration`

**Mode** Global Configuration

**Example** To change to EPSR mode, use the command:

```
awplus(config)# epsr configuration
```

**Related commands** `epsr mode master controlvlan primary port`  
`epsr`  
`show epsr`

# epsr datavlan

**Overview** This command adds a data VLAN or a range of VLAN identifiers to a specified EPSR instance.

The **no** variant of this command removes a data VLAN or data VLAN range from an EPSR instance.

**Syntax** `epsr <epsr-instance> datavlan {<vlanid>|<vlanid-range>}`  
`no epsr <epsr-instance> datavlan {<vlanid>|<vlanid-range>}`

Parameter	Description
<code>&lt;epsr-instance&gt;</code>	Name of the EPSR instance.
<code>datavlan</code>	Adds a data VLAN to be protected by the EPSR instance.
<code>&lt;vlanid&gt;</code>	The VLAN's VID - a number between 1 and 4094 excluding the number selected for the control VLAN.
<code>&lt;vlanid-range&gt;</code>	Specify a range of VLAN identifiers using a hyphen to separate identifiers.

**Mode** EPSR Configuration

**Usage notes** We recommend you

- set the EPSR control VLAN to `vlan2`, using the [epsr mode master controlvlan primary port](#) and [epsr mode transit controlvlan](#) commands, then
- set the EPSR data VLAN between to be a value between 3 and 4094, using the [epsr datavlan](#) command.

**Examples** To add `vlan3` to the EPSR instance called `blue`, use the command:

```
awplus(config-epsr)# epsr blue datavlan vlan3
```

To add `vlan2` and `vlan3` to the EPSR instance called `blue`, use the command:

```
awplus(config-epsr)# epsr blue datavlan vlan2-vlan3
```

To remove `vlan3` from the EPSR instance called `blue`, use the command:

```
awplus(config-epsr)# no epsr blue datavlan vlan3
```

To remove `vlan2` and `vlan3` from the EPSR instance called `blue`, use the command:

```
awplus(config-epsr)# no epsr blue datavlan vlan2-vlan3
```

**Related commands** [epsr mode master controlvlan primary port](#)  
[epsr mode transit controlvlan](#)  
[show epsr](#)

# epsr enhancedrecovery enable

**Overview** This command enables EPSR's enhanced recovery mode. Enhanced recovery mode enables a ring to apply additional recovery procedures when a ring with more than one break partially mends. For more information, see the [EPSR Feature Overview and Configuration Guide](#).

The **no** variant of this command disables the enhanced recovery mode.

**Syntax** `epsr <epsr-instance> enhancedrecovery enable`  
`no epsr <epsr-instance> enhancedrecovery enable`

Parameter	Description
<code>&lt;epsr-instance&gt;</code>	Name of the EPSR instance.

**Default** Default is that enhanced recovery mode disabled.

**Mode** EPSR Configuration

**Example** To apply enhanced recovery on the EPSR instance called `blue`, use the command:

```
awplus(config-epsr)# epsr blue enhancedrecovery enable
```

**Related commands** `show epsr`

# epsr flush-type

**Overview** Use this command to set how EPSR flushes Layer 2 entries when a topology change occurs. It can be configured to flush all Layer 2 entries on its EPSR interfaces or only flush the Layer 2 entries on its EPSR data VLANs.

Use the **no** variant of this command to revert to the default setting.

**Syntax** `epsr <epsr-name> flush-type {interface|vlan}`  
`no epsr <epsr-name> flush-type`

Parameter	Description
<epsr-name>	The name of the EPSR instance to set the flush-type for.
interface	Flush all Layer 2 entries from the EPSR interface on a topology change.
vlan	Flush the Layer 2 entries on the EPSR interface and data VLANs on a topology change.

**Default** The default flush-type is vlan

**Mode** EPSR Configuration

**Usage notes** To flush all entries on the EPSR interface (including non-EPSR data VLANs) the flush-type command must be explicitly configured on the EPSR ring with the **interface** parameter.

Select **interface** as the flush-type to help reduce latency caused during EPSR topology changes. This type of flushing is quicker and less granular than flushing per data vlan, as flushing on a data **vlan** may incur a higher overhead, reducing EPSR responsiveness to ring topology changes.

Interface flushing can be used to optimize EPSR rings with a large number of VLANs. It will however also require relearning on any VLANs that are on an EPSR interface but not part of the EPSR configuration.

**Example** To configure the behavior of EPSR ring 'red' transit node on topology changes to flush all Layer 2 entries on its EPSR ring interfaces, use the following commands:

```
awplus# configure terminal
awplus(config)# epsr configuration
awplus(config-epsr)# epsr red mode transit controlvlan 10
awplus(config-epsr)# epsr red datavlan 20-29
awplus(config-epsr)# epsr red flush-type interface
awplus(config-epsr)# epsr red state enable
```

**Related commands** [show epsr](#)

**Command changes** Version 5.4.9-1.1: command added

# epsr mode master controlvlan primary port

**Overview** This command creates a master EPSR instance. Your switch is unable to run this command because it cannot function as an EPSR master node. To include these switches in an EPSR ring you will need to use an alternative Allied Telesis switch, such as an x550 Series switch, as the master node. For more information on this command, refer to the manual of your master EPSR node's switch.

**NOTE:** This command will only run on switches that are capable of running as an EPSR master node. However, even if your switch cannot function as an EPSR master node, you still need to configure this command on whatever switch is the master within your EPSR network.

**Syntax** `epsr <epsr-instance> mode master controlvlan <2-4094>  
primaryport <port>`

Parameter	Description
<epsr-instance>	Name of the EPSR instance.
mode	Determines the node is acting as a master.
master	Sets switch to be the master node for the named EPSR ring.
controlvlan	The VLAN that will transmit EPSR control frames.
<2-4094>	VLAN id.
primaryport	Primary port for the EPSR instance.
<port>	The primary port. The port may be a switch port (e.g. port1.0.4) or a static channel group (e.g. sa3). It cannot be a dynamic (LACP) channel group.

**NOTE:** The software allows you to configure more than two ports or static channel groups to the control VLAN within a single switch. However, we advise against this because in certain situations it can produce unpredictable results.

**Mode** EPSR Configuration

**Example** To create a master EPSR instance called blue with vlan2 as the control VLAN and port1.0.1 as the primary port, use the command:

```
awplus(config-epsr)# epsr blue mode master controlvlan vlan2  
primaryport port1.0.1
```

**Related commands** [epsr mode transit controlvlan](#)  
[show epsr](#)



# epsr mode transit controlvlan

**Overview** This command creates a transit EPSR instance.

**Syntax** `epsr <epsr-instance> mode transit controlvlan <2-4094>`

Parameter	Description
<epsr-instance>	Name of the EPSR instance.
mode	Determines the node is acting as a transit node.
transit	Sets switch to be the transit node for the named EPSR ring.
controlvlan	The VLAN that will transmit EPSR control frames.
<2-4094>	VLAN id.

**NOTE:** The software allows you to configure more than two ports or static channel groups to the control VLAN within a single switch. However, we advise against this because in certain situations it can produce unpredictable results.

If the control VLAN contains more than two ports (or static channels) an algorithm selects the two ports or channels with the lowest number to be the ring ports. However if the switch has only one channel group is defined to the control vlan, EPSR will not operate on the secondary port.

EPSR does not support Dynamic link aggregation (LACP).

**Mode** EPSR Configuration

**Example** To create a transit EPSR instance called `blue` with `vlan2` as the control VLAN, use the command:

```
awplus(config-epsr)# epsr blue mode transit controlvlan vlan2
```

**Related commands**

- [epsr mode master controlvlan primary port](#)
- [epsr mode transit controlvlan](#)
- [show epsr](#)

# epsr priority

**Overview** This command sets the priority of an EPSR instance on an EPSR node. Priority is used to prevent “superloops” forming under fault conditions with particular ring configurations. Setting a node to have a priority greater than one, also has the effect of turning on **superloop protection**.

The **no** variant of this command returns the priority of the EPSR instance back to its default value of 0, which also disables EPSR Superloop prevention.

**Syntax** `epsr <epsr-instance> priority <0-127>`  
`no <epsr-instance> priority`

Parameter	Description
<code>&lt;epsr-instance&gt;</code>	Name of the EPSR instance.
<code>priority</code>	The priority of the ring instance selected by the <code>epsr-name</code> parameter.
<code>&lt;0-127&gt;</code>	The priority to be applied (0 is the lowest priority and represents no superloop protection).

**Default** The default priority of an EPSR instance on an EPSR node is 0. The negated form of this command resets the priority of an EPSR instance on an EPSR node to the default value.

**Mode** EPSR Configuration

**Example** To set the priority of the EPSR instance called `blue` to the highest priority (127), use the command:

```
awplus(config-epsr)# epsr blue priority 127
```

To reset the priority of the EPSR instance called `blue` to the default (0), use the command:

```
awplus(config-epsr)# no epsr blue priority
```

**Related commands** [epsr configuration](#)

## epsr state

**Overview** This command enables or disables an EPSR instance.

**Syntax** `epsr <epsr-instance> state {enabled|disabled}`

Parameter	Description
<code>&lt;epsr-instance&gt;</code>	The name of the EPSR instance.
<code>state</code>	The operational state of the ring.
<code>enabled</code>	EPSR instance is enabled.
<code>disabled</code>	EPSR instance is disabled.

**Mode** EPSR Configuration

**Example** To enable the EPSR instance called `blue`, use the command:

```
awplus(config-epsr)# epsr blue state enabled
```

**Related commands** [epsr mode master controlvlan primary port](#)  
[epsr mode transit controlvlan](#)

# epsr topology-change

**Overview** Use this command to allow the given EPSR instance to accept notifications from other topology protocols, namely G.8032, for Topology Change Notifications (TCN).

Use the **no** variant of this command to return the EPSR instance to where it does not accept TCNs from the other specified protocol, and as a result does not send out a “flush FDB” message.

**Syntax** `epsr <epsr-name> topology-change g8032`  
`no epsr <epsr-name> topology-change g8032`

Parameter	Description
<code>&lt;epsr-name&gt;</code>	The name of the EPSR instance for which the topology-change applies to.
<code>topology-change</code>	The topology-change value to be set for the instance.
<code>g8032</code>	Specify that G.8032 is the other protocol that the topology-change notifications are allowed to be accepted from in order to send "flush FDB" messages to other EPSR nodes in the ring.

**Default** The default value is no notifications are accepted and in turn no “flush FDB” messages are sent.

**Mode** EPSR Configuration

**Usage notes** The purpose of this command is to allow EPSR to accept notifications from other topology protocols, namely G.8032, about Topology Change Notifications (TCN). Once EPSR accepts the TCN, it will in turn notify the other nodes on the EPSR ring to perform an FDB flush.

**Example** To configure an EPSR instance named “red” to accept G.8032 TCNs, use the following command:

```
awplus(config-epsr)# epsr red topology-change g8032
```

To configure an EPSR instance named “red” to no longer accept G.8032 TCNs, use the following command:

```
awplus(config-epsr)# no epsr red topology-change g8032
```

**Related commands** [show epsr](#)

**Command changes** Version 5.4.7-1.1: command added

## epsr trap

**Overview** This command enables SNMP traps for an EPSR instance. The traps will be sent when the EPSR instance changes state.

The **no** variant of this command disables SNMP traps for an EPSR instance. The traps will no longer be sent when the EPSR instance changes state.

**Syntax** `epsr <epsr-instance> trap`  
`no epsr <epsr-instance> trap`

Parameter	Description
<code>&lt;epsr-instance&gt;</code>	Name of the EPSR instance.
<code>trap</code>	SNMP trap for the EPSR instance.

**Mode** EPSR Configuration

**Example** To enable traps for the EPSR instance called `blue`, use the command:

```
awplus(config-epsr)# epsr blue trap
```

To disable traps for the EPSR instance called `blue`, use the command:

```
awplus(config-epsr)# no epsr blue trap
```

**Related commands** [epsr mode master controlvlan primary port](#)  
[epsr mode transit controlvlan](#)  
[show epsr](#)

# show debugging epsr

**Overview** This command shows the debugging modes enabled for EPSR.

**Syntax** `show debugging epsr`

**Mode** User Exec and Privileged Exec

**Example** To show the enabled debugging modes, use the command:

```
awplus# show debugging epsr
```

**Related commands** [debug epsr](#)

# show epsr

**Overview** This command displays information about all EPSR instances.

**Syntax** show epsr

**Mode** User Exec and Privileged Exec

**Example** To show the current settings of all EPSR instances, use the command:

```
awplus# show epsr
```

**Output:** The following examples show the output display for a non-superloop topology network.  
**non-superloop topology**

**Table 1:** Example output from the **show epsr** command run on a transit node

EPSR Information	
Name .....	test2
Mode .....	Transit
Status .....	Enabled
State .....	Links-Up
Control Vlan .....	2
Data VLAN(s) .....	10
Interface Mode .....	Ports Only
First Port .....	port1.0.1
First Port Status .....	Down
First Port Direction .....	Unknown
Second Port .....	port1.0.2
Second Port Status .....	Down
Second Port Direction .....	Unknown
Trap .....	Enabled
Master Node .....	Unknown
Enhanced Recovery .....	Disabled

**NOTE:** The above output is only displayed on an EPSR master.

**Output:** The following examples show the output display for superloop topology network  
**superloop topology** **NOTE:** The above output is only displayed on an EPSR master.

**Table 2:** Example output from the **show epsr** command run on a Transit Node

```

EPSR Information
-----
Name ..... test4
Mode ..... Transit
Status ..... Enabled
State ..... Complete
Control Vlan ..... 4
Data VLAN(s) ..... 20
Interface Mode ..... Ports Only
Primary Port ..... port1.0.3
  Status ..... Forwarding (logically blocking)
  Is On Common Segment ..... No
  Blocking Control ..... Physical
Secondary Port ..... port1.0.4
  Status ..... Blocked
  Is On Common Segment ..... No
  Blocking Control ..... Physical
Hello Time ..... 1 s
Failover Time ..... 2 s
Ring Flap Time ..... 0 s
Trap ..... Enabled
Enhanced Recovery ..... Disabled
SLP Priority ..... 12
-----
    
```

**Table 3:** Parameters displayed in the output of the **show epsr** command

Parameter on Master Node	Parameter on Transit Node	Description
Name	Name	The name of the EPSR instance.
Mode	Mode	The mode in which the EPSR instance is configured - either Master or Transit
Status	Status	Indicates whether the EPSR instance is enabled or disabled
State	State	Indicates state of the EPSR instance's state machine. Master states are: Idle, Complete, and Failed. Transit states are Links-Up, Links-Down, and Pre-Forwarding.
Control Vlan	Control Vlan	Displays the VID of the EPSR instance's control VLAN.
Data VLAN(s)	Data VLAN(s)	The VID(s) of the instance's data VLANs.
Interface Mode	Interface Mode	Whether the EPSR instance's ring ports are both physical ports (Ports Only) or are both static aggregators (Channel Groups Only).
Primary Port	First Port	The EPSR instance's primary ring port.



**Table 3:** Parameters displayed in the output of the **show epsr** command (cont.)

Parameter on Master Node	Parameter on Transit Node	Description
- Status	- Status	Whether the ring port is forwarding (Forwarding) or blocking (Blocked), or has link down (Down), and if forwarding or blocking, "(logical)" indicates the instance has only logically set the blocking state of the port because it does not have physical control of it.
	- Direction	The ring port on which the last EPSR control packet was received is indicated by "Upstream". The other ring port is then "Downstream"
- Is On Common Segment	- Is On Common Segment	Whether the ring port is on a shared common segment link to another node, and if so, "(highest rank)" indicates it is the highest priority instance on that common segment.
- Blocking Control	- Blocking Control	Whether the instance has "physical" or "logical" control of the ring port's blocking in the instance's data VLANs.
Secondary Port	Second Port	The EPSR instance's secondary port.
- Status	- Status	Whether the ring port is forwarding (Forwarding) or blocking (Blocked), or has link down (Down), and if forwarding or blocking, "(logical)" indicates the instance has only logically set the blocking state of the port, because it does not have physical control of it. Note that on a master configured for SuperLoop Prevention (non-zero priority) its secondary ring port can be physically forwarding, but logically blocking. This situation arises when it is not the highest priority node in the topology (and so does not receive LINKS-DOWN messages upon common segment breaks) and a break on a common segment in its ring is preventing reception of its own health messages.
	- Direction	The ring port on which the last EPSR control packet was received is indicated by "Upstream". The other ring port is then "Downstream"
- Is On Common Segment	- Is On Common Segment	Whether the ring port is on a shared common segment link to another node, and if so, "(highest rank)" indicates it is the highest priority instance on that common segment
- Blocking Control	- Blocking Control	Whether the instance has "physical" or "logical" control of the ring port's blocking in the instance's data VLANs
Hello Time		The EPSR instance's setting for the interval between transmissions of health check messages (in seconds)
Failover Time		The time (in seconds) the EPSR instance waits to receive a health check message before it decides the ring is down
Ring Flap Time		The minimum time the EPSR instance must remain in the failed state
Trap	Trap	Whether the EPSR instance has EPSR SNMP traps enabled

**Table 3:** Parameters displayed in the output of the **show epsr** command (cont.)

Parameter on Master Node	Parameter on Transit Node	Description
Enhanced Recovery	Enhanced Recovery	Whether the EPSR instance has enhanced recovery mode enabled
SLP Priority	SLP Priority	The EPSR instance's priority (for SuperLoop Prevention)

**Related commands**

- [epsr mode master controlvlan primary port](#)
- [epsr mode transit controlvlan](#)
- [show epsr counters](#)

# show epsr common segments

**Overview** This command displays information about all the superloop common segment ports on the switch.

**Syntax** `show epsr common segments`

**Example** To display information about all the superloop common segment ports on the switch, use the command:

```
awplus# show epsr common segments
```

**Table 4:** Example output from the **show epsr common segments** command

EPSR Common Segments						
Common Seg	EPSR			Port	Phys Ctrl	Ring
Ring Port	Instance	Mode	Prio	Type	of Port?	Port Status
port1.0.4	test_inst_Red	Transit	127	Second	Yes	Fwding
	test_inst_Blue	Transit	126	Second	No	Fwding (logical)
	test_inst_Green	Transit	125	First	No	Fwding (logical)
sa4	testA	Master	15	Primary	Yes	Blocking
	testB	Transit	14	Second	No	Fwding (logical)
sa5	test_55	Transit	8	First	Yes	Down
	test_77	Transit	7	First	No	Down

**Related commands**

- [show epsr](#)
- [show epsr summary](#)
- [show epsr counters](#)

# show epsr config-check

**Overview** This command checks the configuration of a specified EPSR instance, or all EPSR instances.

If an instance is enabled, this command will check for the following errors or warnings:

- The control VLAN has the wrong number of ports.
- There are no data VLANs.
- Some of the data VLANs are not assigned to the ring ports.
- The instance is a master with its secondary port on a common segment.

**Syntax** `show epsr [<instance>] config-check`

Parameter	Description
<instance>	Name of the EPSR instance to check on.

**Mode** User Exec and Privileged Exec

**Example** To check the configuration of all EPSR instances and display the results, use the command:

```
awplus# show epsr config-check
```

Table 38-1: Example output from **show epsr config-check**

EPSR Instance	Status	Description
red	OK.	
white	OK.	
blue	Warning	Primary port is not in data VLANs 29-99.
orange	OK.	

Don't forget to check that this node's configuration is consistent with all other nodes in the ring.

**Related commands** [show epsr](#)

# show epsr <epsr-instance>

**Overview** This command displays information about the specified EPSR instance.

**Syntax** `show epsr <epsr-instance>`

Parameter	Description
<code>&lt;epsr-instance&gt;</code>	Name of the EPSR instance.

**Mode** User Exec and Privileged Exec

**Example** To show the current settings of the EPSR instance called `blue`, use the command:

```
awplus# show epsr blue
```

**Related commands**

- `epsr mode master controlvlan primary port`
- `epsr mode transit controlvlan`
- `show epsr counters`

# show epsr <epsr-instance> counters

**Overview** This command displays counter information about the specified EPSR instance.

**Syntax** `show epsr <epsr-instance> counters`

Parameter	Description
<code>&lt;epsr-instance&gt;</code>	Name of the EPSR instance.

**Mode** User Exec and Privileged Exec

**Example** To show the counters of the EPSR instance called `blue`, use the command:

```
awplus# show epsr blue counters
```

**Related commands**

- `epsr mode master controlvlan primary port`
- `epsr mode transit controlvlan`
- `show epsr`

# show epsr counters

**Overview** This command displays counter information about all EPSR instances.

**Syntax** `show epsr counters`

**Mode** User Exec and Privileged Exec

**Example** To show the counters of all EPSR instances, use the command:

```
awplus# show epsr counters
```

**Related commands**

- [epsr mode master controlvlan primary port](#)
- [epsr mode transit controlvlan](#)
- [show epsr](#)

# show epsr summary

**Overview** This command displays summary information about all EPSR instances on the switch

**Syntax** show epsr summary

**Mode** User Exec and Privileged Exec

**Example** To display EPSR summary information, use the command:

```
awplus# show epsr summary
```

**Table 39:** Example output from the **show epsr summary** command

```
EPSR Summary Information

Abbreviations:
M = Master node
T = Transit node
C = is on a common segment with other instances
P = instance on a common segment has physical control of the shared port's
  data VLAN blocking
LB = ring port is Logically Blocking - applicable to master only
```

EPSR Instance	Mode	Status	State	Ctrl VLAN	Prio	Primary/1st Port Status	Secondary/2nd Port Status
test-12345	T	Enabled	Links-Down	6	127	Blocking (C,P)	Blocking (C,P)
test1	M	Enabled	Complete	5	12	Fwding	Fwding (LB)
test2	T	Enabled	Pre-Fwding	4	126	Fwding (C)	Blocking (C)
localB	T	Disabled	Idle	40	0	Unknown	Unknown
localC	T	Disabled	Idle	41	0	Unknown	Unknown



# undebbug epsr

**Overview** This command applies the functionality of the **no** variant of the [debug epsr](#) command.

# Part 7: Network Management

# 39

# Allied Telesis Management Framework™ (AMF) Commands

## Introduction

**Overview** This chapter provides an alphabetical reference for Allied Telesis Management Framework™ (AMF) commands.

**AMF master nodes** Every AMF network must have at least one master node, which acts as the core of the AMF network. Not all AlliedWare Plus devices are capable of acting as an AMF master. See the [AMF Feature Overview and Configuration Guide](#) for information about AMF master support.

**AMF edge** AlliedWare Plus CentreCOM® Series switches can only be used as edge switches in an AMF network. The full management power and convenience of AMF is available on these switches, but they can only link to one other AMF node. They cannot form cross-links or virtual links.

**AMF naming convention** When AMF is enabled on a device, it will automatically be assigned a host name. If a host name has already been assigned, by using the command [hostname](#) on page 215, this will remain. If however, no host name has been assigned, then the name applied will be the prefix, **host\_** followed (without a space) by the MAC address of the device. For example, a device whose MAC address is **0016.76b1.7a5e** will have the name **host\_0016\_76b1\_7a5e** assigned to it.

To efficiently manage your network using AMF, we strongly advise that you devise a naming convention for your network devices, and apply an appropriate hostname to each device in your AMF network.

**AMF and STP** On AR-Series UTM firewalls and Secure VPN routers, you cannot use STP at the same time as AMF.

- Command List**
- [“application-proxy ip-filter”](#) on page 1432
  - [“application-proxy quarantine-vlan”](#) on page 1433
  - [“application-proxy redirect-url”](#) on page 1434
  - [“application-proxy threat-protection”](#) on page 1435
  - [“application-proxy threat-protection send-summary”](#) on page 1436

- [“application-proxy whitelist enable”](#) on page 1437
- [“application-proxy whitelist server”](#) on page 1438
- [“area-link”](#) on page 1440
- [“atmf area”](#) on page 1442
- [“atmf area password”](#) on page 1444
- [“atmf authorize”](#) on page 1446
- [“atmf authorize provision”](#) on page 1448
- [“atmf backup”](#) on page 1450
- [“atmf backup area-masters delete”](#) on page 1451
- [“atmf backup area-masters enable”](#) on page 1452
- [“atmf backup area-masters now”](#) on page 1453
- [“atmf backup area-masters synchronize”](#) on page 1454
- [“atmf backup bandwidth”](#) on page 1455
- [“atmf backup delete”](#) on page 1456
- [“atmf backup enable”](#) on page 1457
- [“atmf backup guests delete”](#) on page 1458
- [“atmf backup guests enable”](#) on page 1459
- [“atmf backup guests now”](#) on page 1460
- [“atmf backup guests synchronize”](#) on page 1461
- [“atmf backup now”](#) on page 1462
- [“atmf backup redundancy enable”](#) on page 1464
- [“atmf backup server”](#) on page 1465
- [“atmf backup stop”](#) on page 1467
- [“atmf backup synchronize”](#) on page 1468
- [“atmf cleanup”](#) on page 1469
- [“atmf container”](#) on page 1470
- [“atmf container login”](#) on page 1471
- [“atmf controller”](#) on page 1472
- [“atmf distribute firmware”](#) on page 1473
- [“atmf domain vlan”](#) on page 1475
- [“atmf enable”](#) on page 1478
- [“atmf group \(membership\)”](#) on page 1479
- [“atmf guest-class”](#) on page 1481
- [“atmf log-verbose”](#) on page 1483
- [“atmf management subnet”](#) on page 1484

- [“atmf management vlan”](#) on page 1487
- [“atmf master”](#) on page 1489
- [“atmf mtu”](#) on page 1490
- [“atmf network-name”](#) on page 1491
- [“atmf provision \(interface\)”](#) on page 1492
- [“atmf provision node”](#) on page 1493
- [“atmf reboot-rolling”](#) on page 1495
- [“atmf recover”](#) on page 1499
- [“atmf recover guest”](#) on page 1501
- [“atmf recover led-off”](#) on page 1502
- [“atmf recovery-server”](#) on page 1503
- [“atmf remote-login”](#) on page 1505
- [“atmf restricted-login”](#) on page 1507
- [“atmf secure-mode”](#) on page 1509
- [“atmf secure-mode certificate expire”](#) on page 1511
- [“atmf secure-mode certificate expiry”](#) on page 1512
- [“atmf secure-mode certificate renew”](#) on page 1513
- [“atmf secure-mode enable-all”](#) on page 1514
- [“atmf select-area”](#) on page 1516
- [“atmf topology-gui enable”](#) on page 1517
- [“atmf trustpoint”](#) on page 1518
- [“atmf virtual-crosslink”](#) on page 1520
- [“atmf virtual-link”](#) on page 1522
- [“atmf virtual-link protection”](#) on page 1525
- [“atmf working-set”](#) on page 1527
- [“bridge-group”](#) on page 1529
- [“clear application-proxy threat-protection”](#) on page 1530
- [“clear atmf links”](#) on page 1531
- [“clear atmf links virtual”](#) on page 1532
- [“clear atmf links statistics”](#) on page 1533
- [“clear atmf recovery-file”](#) on page 1534
- [“clear atmf secure-mode certificates”](#) on page 1535
- [“clear atmf secure-mode statistics”](#) on page 1536
- [“clone \(amf-provision\)”](#) on page 1537
- [“configure boot config \(amf-provision\)”](#) on page 1539

- “[configure boot system \(amf-provision\)](#)” on page 1541
- “[copy \(amf-provision\)](#)” on page 1543
- “[create \(amf-provision\)](#)” on page 1544
- “[debug atmf](#)” on page 1546
- “[debug atmf packet](#)” on page 1548
- “[delete \(amf-provision\)](#)” on page 1551
- “[discovery](#)” on page 1553
- “[description \(amf-container\)](#)” on page 1555
- “[erase factory-default](#)” on page 1556
- “[http-enable](#)” on page 1557
- “[identity \(amf-provision\)](#)” on page 1559
- “[license-cert \(amf-provision\)](#)” on page 1561
- “[locate \(amf-provision\)](#)” on page 1563
- “[log event-host](#)” on page 1565
- “[modeltype](#)” on page 1566
- “[service atmf-application-proxy](#)” on page 1567
- “[show application-proxy threat-protection](#)” on page 1568
- “[show application-proxy whitelist interface](#)” on page 1570
- “[show application-proxy whitelist server](#)” on page 1572
- “[show application-proxy whitelist supplicant](#)” on page 1573
- “[show atmf](#)” on page 1575
- “[show atmf area](#)” on page 1579
- “[show atmf area guests](#)” on page 1582
- “[show atmf area guests-detail](#)” on page 1584
- “[show atmf area nodes](#)” on page 1586
- “[show atmf area nodes-detail](#)” on page 1588
- “[show atmf area summary](#)” on page 1590
- “[show atmf authorization](#)” on page 1591
- “[show atmf backup](#)” on page 1594
- “[show atmf backup area](#)” on page 1598
- “[show atmf backup guest](#)” on page 1600
- “[show atmf container](#)” on page 1602
- “[show atmf detail](#)” on page 1605
- “[show atmf group](#)” on page 1607
- “[show atmf group members](#)” on page 1609

- “show atmf guests” on page 1611
- “show atmf guests detail” on page 1613
- “show atmf links” on page 1616
- “show atmf links detail” on page 1618
- “show atmf links guest” on page 1627
- “show atmf links guest detail” on page 1629
- “show atmf links statistics” on page 1633
- “show atmf nodes” on page 1636
- “show atmf provision nodes” on page 1638
- “show atmf recovery-file” on page 1640
- “show atmf secure-mode” on page 1641
- “show atmf secure-mode audit” on page 1643
- “show atmf secure-mode audit link” on page 1644
- “show atmf secure-mode certificates” on page 1645
- “show atmf secure-mode sa” on page 1648
- “show atmf secure-mode statistics” on page 1651
- “show atmf tech” on page 1653
- “show atmf virtual-links” on page 1656
- “show atmf working-set” on page 1658
- “show debugging atmf” on page 1659
- “show debugging atmf packet” on page 1660
- “show running-config atmf” on page 1661
- “state” on page 1662
- “switchport atmf-agentlink” on page 1664
- “switchport atmf-arealink remote-area” on page 1665
- “switchport atmf-crosslink” on page 1667
- “switchport atmf-guestlink” on page 1669
- “switchport atmf-link” on page 1671
- “type atmf node” on page 1672
- “undebg atmf” on page 1675
- “username” on page 1676

# application-proxy ip-filter

**Overview** Use this command to enable global IP filtering on a device. Once enabled the device will add a global ACL in response to a threat message from an AMF Security (AMF-Sec) Controller.

Use the **no** variant of this command to disable global IP filtering.

**Syntax** `application-proxy ip-filter`  
`no application-proxy ip-filter`

**Default** Global IP filtering is disabled by default.

**Mode** Global Configuration

**Usage notes** For this feature to work, the AMF Application Proxy service needs to be enabled on your network, using the command `service atmf-application-proxy`.

**Example** To enable global IP filtering, use the commands:

```
awplus# configure terminal
awplus(config)# application-proxy ip-filter
```

To disable global IP filtering, use the commands:

```
awplus# configure terminal
awplus(config)# no application-proxy ip-filter
```

**Related commands** `application-proxy redirect-url`  
`application-proxy threat-protection`  
`clear application-proxy threat-protection`  
`service atmf-application-proxy`  
`show application-proxy threat-protection`

**Command changes** Version 5.4.7-2.5: command added



# application-proxy quarantine-vlan

**Overview** Use this command to set the quarantine VLAN to use when an AMF Security (AMF-Sec) Controller detects a threat. The port/s on which the threat is detected are moved to this VLAN if the [application-proxy threat-protection](#) action is set to **quarantine**.

Use the **no** variant of this command to delete the quarantine VLAN. If no quarantine VLAN is specified then no quarantine action will be performed.

**Syntax** `application-proxy quarantine-vlan <vlan-id>`  
`no application-proxy quarantine-vlan`

Parameter	Description
<code>&lt;vlan-id&gt;</code>	The ID of the VLAN to use. In the range 1-4094.

**Default** By default, no quarantine VLAN is configured.

**Mode** Global Configuration

**Example** To configure VLAN 100 as the quarantine VLAN, use the commands:

```
awplus# configure terminal
awplus(config)# application-proxy quarantine-vlan 100
```

To delete the quarantine VLAN, use the commands:

```
awplus# configure terminal
awplus(config)# no application-proxy quarantine-vlan
```

**Related commands** [application-proxy threat-protection](#)  
[clear application-proxy threat-protection](#)  
[application-proxy threat-protection send-summary](#)  
[service atmf-application-proxy](#)  
[show application-proxy threat-protection](#)

**Command changes** Version 5.4.7-2.2: command added

# application-proxy redirect-url

**Overview** Use this command to redirect a user to a helpful URL when they are blocked because of an [application-proxy ip-filter](#).

Use the **no** variant of this command to remove the URL redirect.

**Syntax** `application-proxy redirect-url <url>`  
`no application-proxy redirect-url`

Parameter	Description
<code>&lt;url&gt;</code>	URL to redirect the user to.

**Default** No URL is configured by default.

**Mode** Global Configuration

**Example** To configure a redirect URL, use the command:

```
awplus# application-proxy redirect-url http://my.dom/help.html
```

To remove a redirect URL, use the command:

```
awplus# no application-proxy redirect-url
```

**Related commands** [application-proxy ip-filter](#)  
[application-proxy threat-protection](#)  
[clear application-proxy threat-protection](#)  
[service atmf-application-proxy](#)  
[show application-proxy threat-protection](#)

**Command changes** Version 5.4.9-0.1: command added

# application-proxy threat-protection

**Overview** Use this command to set the blocking action to take when a threat detected message is received from an AMF Security (AMF-Sec) Controller.

Use the **no** variant of this command to disable threat protection blocking actions on the port.

**Syntax** application-proxy threat-protection {drop|link-down|  
quarantine|log-only}  
no application-proxy threat-protection

Parameter	Description
drop	Apply a Layer 2 drop for traffic generating the threat reports.
link-down	Set the link to error disabled in response to threats.
quarantine	Move the offending port to a quarantine VLAN.
log-only	Log when a threat is detected.

**Default** Threat protection is disabled by default.

**Mode** Interface Configuration

**Example** To set the threat protection blocking action on port1.0.4 to drop, use the commands:

```
awplus# configure terminal
awplus(config)# interface port1.0.4
awplus(config-if)# application-proxy threat-protection drop
```

To disable threat protection blocking actions on port1.0.4, use the commands:

```
awplus# configure terminal
awplus(config)# interface port1.0.4
awplus(config-if)# no application-proxy threat-protection
```

**Related commands**

- [application-proxy quarantine-vlan](#)
- [application-proxy threat-protection send-summary](#)
- [clear application-proxy threat-protection](#)
- [service atmf-application-proxy](#)
- [show application-proxy threat-protection](#)

**Command changes**

- Version 5.4.7-2.2: command added
- Version 5.4.9-0.1: **log-only** parameter added

# application-proxy threat-protection send-summary

**Overview** Use this command to send a summary of all current threat-protection blocking requests to all AMF Application Proxy service nodes. This command can only be performed on an AMF master.

**Syntax** `application-proxy threat-protection send-summary`

**Mode** Privileged Exec

**Example** To send a summary of all current threat-protection blocking requests to all AMF Application Proxy service nodes, use the command:

```
awplus# application-proxy threat-protection send-summary
```

**Related commands**

- [application-proxy quarantine-vlan](#)
- [application-proxy threat-protection](#)
- [clear application-proxy threat-protection](#)
- [service atmf-application-proxy](#)
- [show application-proxy threat-protection](#)

**Command changes** Version 5.4.7-2.2: command added

# application-proxy whitelist enable

**Overview** Use this command to enable application-proxy whitelist based authentication on an interface.

Use the **no** variant of this command to disable the whitelist authentication.

**Syntax** application-proxy whitelist enable  
no application-proxy whitelist enable

**Default** Application-proxy whitelist is disabled by default.

**Mode** Interface Configuration

**Example** To enable application-proxy whitelist authentication on the interface port1.0.4, use the commands:

```
awplus# configure terminal
awplus(config)# interface port1.0.4
awplus(config-if)# application-proxy whitelist enable
```

To disable application-proxy whitelist authentication on the interface port1.0.4, use the commands:

```
awplus# configure terminal
awplus(config)# interface port1.0.4
awplus(config-if)# no application-proxy whitelist enable
```

**Related commands** application-proxy whitelist server  
show application-proxy whitelist interface  
show application-proxy whitelist server  
show application-proxy whitelist supplicant

**Command changes** Version 5.4.9-0.1: command added

# application-proxy whitelist server

**Overview** Use this command to set an AMF master to act as a whitelist authentication proxy between AMF members, acting as Network Access Servers, and an external whitelist RADIUS server.

Use the **no** variant of this command to disable the whitelist proxy functionality.

**Syntax** `application-proxy whitelist server <ip-address> key <key>`  
`[auth-port <1-65535>]`  
`no application-proxy whitelist server`

Parameter	Description
<code>&lt;ip-address&gt;</code>	IPv4 address of the upstream RADIUS server in dotted decimal format A.B.C.D.
<code>key &lt;key&gt;</code>	Set the shared secret encryption key for communication with the upstream RADIUS server.
<code>auth-port &lt;1-65535&gt;</code>	Set the RADIUS server UDP port. This is only necessary if you don't want to use the default port 1812.

**Default** Disabled by default.

**Mode** Global Configuration

**Example** To configure an AMF master to work as a proxy to the external RADIUS server 192.168.1.10, with shared secret 'mysecurekey', on port 1822, use the commands:

```
awplus# configure terminal
awplus(config)# application-proxy whitelist server 192.168.1.10
key mysecurekey auth-port 1822
```

To configure an AMF master to work as a proxy to the external RADIUS server 192.168.1.10, with shared secret 'mysecurekey', on the default port (1812), use the commands:

```
awplus# configure terminal
awplus(config)# application-proxy whitelist server 192.168.1.10
key mysecurekey
```

To disable the whitelist proxy, use the commands:

```
awplus# configure terminal
awplus(config)# no application-proxy whitelist server
```

**Related commands**

- [application-proxy whitelist enable](#)
- [service atmf-application-proxy](#)
- [show application-proxy whitelist interface](#)
- [show application-proxy whitelist server](#)

show application-proxy whitelist supplicant

**Command changes** Version 5.4.9-0.1: command added

# area-link

**Overview** Use this command to create an area-link between a Virtual AMF Appliance (VAA) host controller and an AMF container.

An AMF container is an isolated instance of AlliedWare Plus with its own network interfaces, configuration, and file system. The features available inside an AMF container are a sub-set of the features available on the host VAA. These features enable the AMF container to function as a uniquely identifiable AMF master and allows for multiple tenants (up to 60) to run on a single VAA host. See the [AMF Feature Overview and Configuration Guide](#) for more information on running multiple tenants on a single VAA host.

Use the **no** variant of this command to remove an area-link from a container.

**Syntax** `area-link <area-name>`  
`no area-link`

Parameter	Description
<code>&lt;area-name&gt;</code>	AMF area name of the container's area.

**Mode** AMF Container Configuration

**Usage notes** The AMF area-link connects the AMF controller on a VAA host to the AMF container. Once a container has been created with the [atmf container](#) command and an area-link configured with the **area-link** command, it can be enabled using the [state](#) command.

You can only configure a single area-link on a container. You will see the following message if you try and configure a second one:

```
% AreaLink already configured for this container
```

Each container has two virtual interfaces:

- Interface eth0, used to connect to the AMF controller on the VAA host via an AMF area-link, configured using this area-link command.
- Interface eth1, used to connect to the outside world using a bridged L2 network link, configured using the [bridge-group](#) command.

See the [AMF Feature Overview and Configuration\\_Guide](#) for more information on these virtual interfaces and links.

**Example** To create the area-link to "wlg" on container "vac-wlg-1", use the commands:

```
awplus# configure terminal
awplus(config)# atmf container vac-wlg-1
awplus(config-atmf-container)# area-link wlg
```



To remove an area-link from container “vac-wlg-1”, use the commands:

```
awplus# configure terminal
awplus(config)# atmf container vac-wlg-1
awplus(config-atmf-container)# no area-link
```

**Related  
commands**

[atmf container](#)  
[show atmf container](#)

**Command  
changes**

Version 5.4.7-0.1: command added

# atmf area

**Overview** This command creates an AMF area and gives it a name and ID number. Use the **no** variant of this command to remove the AMF area. This command is only valid on AMF controllers, master nodes and gateway nodes.

**Syntax** `atmf area <area-name> id <1-126> [local]`  
`no atmf area <area-name>`

Parameter	Description
<area-name>	The AMF area name. The area name can be up to 15 characters long. Valid characters are: a..z A..Z 0..9 - _ Names are case sensitive and must be unique within an AMF network. The name cannot be the word "local" or an abbreviation of the word "local" (such as "l", "lo" etc.).
<1-126>	An ID number that uniquely identifies this area.
local	Set the area to be the local area. The local area contains the device you are configuring.

**Mode** Global Configuration

**Usage notes** This command enables you to divide your AMF network into areas. Each area is managed by at least one AMF master node. Each area can have up to 120 nodes, depending on the license installed on that area's master node.

The whole AMF network is managed by up to 8 AMF controllers. Each AMF controller can communicate with multiple areas. The number of areas supported on a controller depends on the license installed on that controller.

You must give each area in an AMF network a unique name and ID number.

Only one local area can be configured on a device. You must specify a local area on each controller, remote AMF master, and gateway node.

**Example** To create the AMF area named *New-Zealand*, with an ID of 1, and specify that it is the local area, use the command:

```
controller-1(config)# atmf area New-Zealand id 1 local
```

To configure a remote area named *Auckland*, with an ID of 100, use the command:

```
controller-1(config)# atmf area Auckland id 100
```

**Related commands**

- atmf area password
- show atmf area
- show atmf area summary
- show atmf area nodes
- switchport atmf-arealink remote-area

# atmf area password

**Overview** This command sets a password on an AMF area.

Use the **no** variant of this command to remove the password.

This command is only valid on AMF controllers, master nodes and gateway nodes. The area name must have been configured first.

**Syntax** `atmf area <area-name> password [8] <password>`  
`no atmf area <area-name> password`

Parameter	Description
<code>&lt;area-name&gt;</code>	The AMF area name.
8	This parameter is displayed in <b>show running-config</b> output to indicate that it is displaying the password in encrypted form. You should not enter <b>8</b> on the CLI yourself.
<code>&lt;password&gt;</code>	The password is between 8 and 32 characters long. It can include spaces.

**Mode** Global Configuration

**Usage notes** You must configure a password on each area that an AMF controller communicates with, except for the controller's local area. The areas must already have been created using the `atmf area` command.

Enter the password identically on both of:

- the area that locally contains the controller, and
- the remote AMF area masters

The command **show running-config atmf** will display the encrypted version of this password. The encryption keys will match between the controller and the remote AMF master.

If multiple controller and masters exist in an area, they must all have the same area configuration.

**Example** To give the AMF area named *Auckland* a password of "secure#1" use the following command on the controller:

```
controller-1(config)# atmf area Auckland password secure#1
```

and also use the following command on the master node for the Auckland area:

```
auck-master(config)# atmf area Auckland password secure#1
```

**Related commands**

- atmf area
- show atmf area
- show atmf area summary
- show atmf area nodes
- switchport atmf-arealink remote-area

# atmf authorize

**Overview** On an AMF network, with secure mode enabled, use this command on an AMF master to authorize an AMF node to join the network. AMF nodes waiting to be authorized appear in the pending authorization queue, which can be examined using the [show atmf authorization](#) command with the **pending** parameter.

Use the **no** variant of this command to revoke authorization for an AMF node on an AMF master.

**Syntax** `atmf authorize {<node-name> [area <area-name>]|all-pending}`  
`no atmf authorize <node-name> [area <area-name>]`

Parameter	Description
<code>&lt;node-name&gt;</code>	The name of the node to be authorized or have its authorization revoked.
<code>area</code>	Specify an AMF area.
<code>&lt;area-name&gt;</code>	This is the name of the area the node belongs to.
<code>all-pending</code>	Authorize all nodes in the pending queue.

**Mode** Privileged Exec

**Usage notes** On an AMF controller, AMF remote-area masters must be authorized by the controller, and the AMF remote-area masters will also need to authorized access from the AMF controller.

**Example** To authorize all AMF nodes in the pending authorization queue on an AMF master, use the command:

```
awplus# atmf authorize all-pending
```

To authorize a node called "node2" in remote AMF area "area3", use the command:

```
awplus# atmf authorize node2 area "area3"
```

To authorize a node called "node4" on an AMF master, use the command:

```
awplus# atmf authorize node4
```

To revoke authorization for a node called "node4" on an AMF master, use the command:

```
awplus# no atmf authorize node4
```

**Related commands**

- [atmf secure-mode](#)
- [clear atmf secure-mode certificates](#)
- [show atmf authorization](#)
- [show atmf secure-mode](#)

show atmf secure-mode certificates

show atmf secure-mode statistics

**Command changes** Version 5.4.7-0.3: command added

# atmf authorize provision

**Overview** Use this command from an AMF controller or AMF master to pre-authorize a node on an AMF network running in secure mode. This allows a node to join the AMF network the moment the `atmf secure-mode` command is run on that node.

Use the **no** variant of this command to remove a provisional authorization from and AMF controller or AMF master.

**Syntax**

```
atmf authorize provision [timeout <minutes>] node <node-name>
interface <interface-name> [area <area-name>]

atmf authorize provision [timeout <minutes>] mac <mac-address>

atmf authorize provision [timeout <minutes>] all

no atmf authorize provision node <node-name> interface
<interface-name> [area <area-name>]

no atmf authorize provision mac <mac-address>

no atmf authorize provision all
```

Parameter	Description
timeout	Timeout for provisional authorization. Authorization for provisioned nodes expires after the timeout period specified.
<minutes>	Timeout in minutes. A value between 1 and 6000 is permissible with the default being 60 minutes.
node	Specify a node to provision by node name.
<node-name>	The name of the node to provisionally authorize.
interface	Specify the interface the node will connect on.
<interface-name>	The name of the interface, this can be a switchport, link aggregator, LACP link, or virtual link.
area	Specify the AMF area.
<area-name>	This is the name of the area the node belongs to.
mac	Specify a node to provision by MAC address.
<mac-address>	Enter a MAC address to provisionally authorize in the format HHHH.HHHH.HHHH.
all	Provision authorization for all secure mode capable nodes.

**Default** The default timeout is 60 minutes.

**Mode** Privileged Exec

**Example** To provisionally authorize all non-secure AMF nodes, use the command:

```
awplus# atmf authorize provision all
```



To authorize a node with a MAC address of 0000.cd28.0880 for 2 hours, use the command:

```
awplus# authorize provision timeout 120 mac 0000.cd28.0880
```

To remove all provisional authorization, on an AMF master, use the command:

```
awplus# no atmf authorize provision all
```

**Related commands** [show atmf authorization](#)  
[show atmf secure-mode](#)

**Command changes** Version 5.4.7-0.3: command added

# atmf backup

**Overview** This command can only be applied to a master node. It manually schedules an AMF backup to start at a specified time and to execute a specified number of times per day.

Use the **no** variant of this command to disable the schedule.

**Syntax** `atmf backup {default|<hh:mm> frequency <1-24>}`

Parameter	Description
default	Restore the default backup schedule.
<hh:mm>	Sets the time of day to apply the first backup, in hours and minutes. Note that this parameter uses the 24 hour clock.
backup	Enables AMF backup to external media.
frequency <1-24>	Sets the number of times within a 24 hour period that backups will be taken.

**Default** Backups run daily at 03:00 AM, by default

**Mode** Global Configuration

**Usage notes** Running this command only configures the schedule. To enable the schedule, you should then apply the command [atmf backup enable](#).

We recommend using the ext3 or ext4 filesystem on external media that are used for AMF backups.

**Example** To schedule backup requests to begin at 11 am and execute twice per day (11 am and 11 pm), use the following command:

```
node_1# configure terminal
node_1(config)# atmf backup 11:00 frequency 2
```

**CAUTION:** File names that comprise identical text, but with differing case, such as *Test.txt* and *test.txt*, will not be recognized as being different on FAT32 based backup media such as a USB storage device. However, these filenames will be recognized as being different on your Linux based device. Therefore, for good practice, ensure that you apply a consistent case structure for your back-up file names.

**Related commands**

- [atmf backup enable](#)
- [atmf backup stop](#)
- [show atmf backup](#)

# atmf backup area-masters delete

**Overview** Use this command to delete from external media, a backup of a specified node in a specified area.

Note that this command can only be run on an AMF controller.

**Syntax** `atmf backup area-masters delete area <area-name> node <node-name>`

Parameter	Description
<code>&lt;area-name&gt;</code>	The area that contains the node whose backup will be deleted.
<code>&lt;node-name&gt;</code>	The node whose backup will be deleted.

**Mode** Privileged Exec

**Example** To delete the backup of the remote area-master named “well-gate” in the AMF area named Wellington, use the command:

```
controller-1# atmf backup area-masters delete area Wellington  
node well-gate
```

**Related commands** [show atmf backup area](#)

# atmf backup area-masters enable

**Overview** Use this command to enable backup of remote area-masters from the AMF controller. This command is only valid on AMF controllers.

Use the **no** form of the command to stop backups of remote area-masters.

**Syntax** `atmf backup area-masters enable`  
`no atmf backup area-masters enable`

**Mode** Global configuration

**Default** Remote area backups are disabled by default

**Usage notes** Use the following commands to configure the remote area-master backups:

- [atmf backup](#) to configure when the backups begin and how often they run
- [atmf backup server](#) to configure the backup server.

We recommend using the ext3 or ext4 filesystem on external media that are used for AMF backups.

**Example** To enable scheduled backups of AMF remote area-masters, use the commands:

```
controller-1# configure terminal
controller-1(config)# atmf backup area-masters enable
```

To disable scheduled backups of AMF remote area-masters, use the commands:

```
controller-1# configure terminal
controller-1(config)# no atmf backup area-masters enable
```

**Related commands** [atmf backup server](#)  
[atmf backup](#)  
[show atmf backup area](#)

# atmf backup area-masters now

**Overview** Use this command to run an AMF backup of one or more remote area-masters from the AMF controller immediately.

This command is only valid on AMF controllers.

**Syntax** `atmf backup area-masters now [area <area-name> | area <area-name> node <node-name>]`

Parameter	Description
<code>&lt;area-name&gt;</code>	The area whose area-masters will be backed up.
<code>&lt;node-name&gt;</code>	The node that will be backed up.

**Mode** Privileged Exec

**Example** To back up all local master nodes in all areas controlled by controller-1, use the command

```
controller-1# atmf backup area-masters now
```

To back up all local masters in the AMF area named Wellington, use the command

```
controller-1# atmf backup area-masters now area Wellington
```

To back up the local master "well-master" in the Wellington area, use the command

```
controller-1# atmf backup area-masters now area Wellington node well-master
```

**Related commands**

- [atmf backup area-masters enable](#)
- [atmf backup area-masters synchronize](#)
- [show atmf backup area](#)

# atmf backup area-masters synchronize

**Overview** Use this command to synchronize backed-up area-master files between the active remote file server and the backup remote file server. Files are copied from the active server to the remote server.

Note that this command is only valid on AMF controllers.

**Syntax** `atmf backup area-masters synchronize`

**Mode** Privileged Exec

**Example** To synchronize backed-up files between the remote file servers for all area-masters, use the command:

```
controller-1# atmf backup area-masters synchronize
```

**Related commands**

- [atmf backup area-masters enable](#)
- [atmf backup area-masters now](#)
- [show atmf backup area](#)

# atmf backup bandwidth

**Overview** This command sets the maximum bandwidth in kilobytes per second (kBps) available to the AMF backup process. This command enables you to restrict the bandwidth that is utilized for downloading file contents during a backup.

**NOTE:** *This command will only run on an AMF master. An error message will be generated if the command is attempted on node that is not a master.*

*Also note that setting the bandwidth value to zero will allow the transmission of as much bandwidth as is available, which can exceed the maximum configurable speed of 1000 kBps. In effect, zero means unlimited.*

Use the **no** variant of this command to reset (to its default value of zero) the maximum bandwidth in kilobytes per second (kBps) available when initiating an AMF backup. A value of zero tells the backup process to transfer files using unlimited bandwidth.

**Syntax** `atmf backup bandwidth <0-1000>`  
`no atmf backup bandwidth`

Parameter	Description
<code>&lt;0-1000&gt;</code>	Sets the bandwidth in kilobytes per second (kBps)

**Default** The default value is zero, allowing unlimited bandwidth when executing an AMF backup.

**Mode** Global Configuration

**Examples** To set an atmf backup bandwidth of 750 kBps, use the commands:

```
node2# configure terminal
node2(config)# atmf backup bandwidth 750
```

To set the AMF backup bandwidth to the default value for unlimited bandwidth, use the commands:

```
node2# configure terminal
node2(config)# no atmf backup bandwidth
```

**Related commands** [show atmf backup](#)

# atmf backup delete

**Overview** This command removes the backup file from the external media of a specified AMF node.

Note that this command can only be run from an AMF master node.

**Syntax** `atmf backup delete <node-name>`

Parameter	Description
<code>&lt;node-name&gt;</code>	The AMF node name of the backup file to be deleted.

**Mode** Privileged Exec

**Example** To delete the backup file from node2, use the following command:

```
Node_1# atmf backup delete node2
```

**Related commands**

- `show atmf backup`
- `atmf backup now`
- `atmf backup stop`



# atmf backup enable

**Overview** This command enables automatic AMF backups on the AMF master node that you are connected to. By default, automatic backup starts at 3:00 AM. However, this schedule can be changed by the [atmf backup](#) command. Note that backups are initiated and stored only on the master nodes.

Use the **no** variant of this command to disable any AMF backups that have been scheduled and previously enabled.

**Syntax** `atmf backup enable`  
`no atmf backup enable`

**Default** Automatic AMF backup functionality is enabled on the AMF master when it is configured and external media, i.e. an SD card or a USB storage device or remote server, is detected.

**Mode** Global Configuration

**Usage notes** A warning message will appear if you run the [atmf backup enable](#) command with either insufficient or marginal memory availability on your external storage device.

You can use the command [show atmf backup](#) on page 1594 to check the amount of space available on your external storage device.

We recommend using the ext3 or ext4 filesystem on external media that are used for AMF backups.

**Example** To turn on automatic AMF backup, use the following command:

```
AMF_Master_1# configure terminal
AMF_Master_1(config)# atmf backup enable
```

**Related commands** [show atmf](#)  
[show atmf backup](#)  
[atmf backup](#)  
[atmf backup now](#)  
[atmf enable](#)

# atmf backup guests delete

**Overview** This command removes a guest node's backup files from external media such as a USB drive, SD card, or an external file server.

**Syntax** `atmf backup guests delete <node-name> <guest-port>`

Parameter	Description
<code>&lt;node-name&gt;</code>	The name of the guest's parent node.
<code>&lt;guest-port&gt;</code>	The port number on the parent node.

**Mode** User Exec/Privileged Exec

**Example** On a parent node named "node1" (which, in this case, the user has a direct console connection to) use the following command to remove the backup files of the guest node that is directly connected to port1.0.3.

```
node1# atmf backup guests delete node1 port1.0.3
```

**Related Command** [atmf backup delete](#)  
[atmf backup area-masters delete](#)  
[show atmf backup guest](#)

# atmf backup guests enable

**Overview** Use this command to enable backups of remote guest nodes from an AMF master. Use the **no** variant of this command to disable the ability of the guest nodes to be backed up.

**Syntax** `atmf backup guests enable`  
`no atmf backup guests enable`

**Default** Guest node backups are enabled by default.

**Mode** Global Config

**Usage notes** We recommend using the ext3 or ext4 filesystem on external media that are used for AMF backups.

**Example** On the AMF master node, enable all scheduled guest node backups:

```
atmf-master# configure terminal
atmf-master(config)# atmf backup guests enable
```

**Related commands** [atmf backup area-masters enable](#)  
[show atmf backup guest](#)  
[atmf backup guests synchronize](#)

# atmf backup guests now

**Overview** This command manually triggers an AMF backup of guest nodes on a AMF Master.

**Syntax** `atmf backup guests now [<node-name>] [<guest-port>]`

Parameter	Description
<code>&lt;node-name&gt;</code>	The name of the guest's parent node.
<code>&lt;guest-port&gt;</code>	The port number that connects to the guest node.

**Default** n/a

**Mode** Privileged Exec

**Example** Use the following command to manually trigger the backup of all guests in the AMF network

```
awplus# atmf backup guests now
```

**Example** To manually trigger the backup of a guest node connected to port 1.0.23 of node1, use the following command:

```
awplus# atmf backup guests now node1 port1.0.23
```

**Related commands** [show atmf backup guest](#)

# atmf backup guests synchronize

**Overview** This command initiates a manual synchronization of all guest backup file-sets across remote file servers and various redundancy backup media, such as USB storage devices. This facility ensures that each device contains the same backup image files. Note that this backup synchronization process will occur as part of the regular backups scheduled by the [atmf backup](#) command.

**Syntax** `atmf backup guests synchronize`

**Default** n/a

**Mode** User Exec/Privileged Exec

**Example** To synchronize backups across remote file servers and storage devices, use the command:

```
Node1#atmf backup guests synchronize
```

**Related commands** [atmf backup redundancy enable](#)  
[show atmf guests](#)  
[atmf backup guests enable](#)

# atmf backup now

**Overview** This command initiates an immediate AMF backup of either all AMF members, or a selected AMF member. Note that this backup information is stored in the external media on the master node of the device on which this command is run, even though the selected AMF member may not be a master node.

Note that this command can only be run on an AMF master node.

**Syntax** `atmf backup now [<nodename>]`

Parameter	Description
<nodename> or <hostname>	The name of the AMF member to be backed up, as set by the command <code>hostname</code> on page 215. Where no name has been assigned to this device, then you must use the default name, which is the word "host", then an underscore, then (without a space) the MAC address of the device to be backed up. For example <code>host_0016_76b1_7a5e</code> . Note that the node-name appears as the command Prompt when in Privileged Exec mode.

**Default** A backup is initiated for all nodes on the AMF (but stored on the master nodes).

**Mode** Privileged Exec

**Usage notes** Although this command will select the AMF node to be backed-up, it can only be run from any AMF master node.

**NOTE:** *The backup produced will be for the selected node but the backed-up config will reside on the external media of the AMF master node on which the command was run. However, this process will result in the information on one master being more up-to-date. To maintain concurrent backups on both masters, you can apply the backup now command to the master working-set. This is shown in Example 4 below.*

**Example 1** In this example, an AMF member has not been assigned a host name. The following command is run on the AMF\_Master\_2 node to immediately backup the device that is identified by its MAC address of 0016.76b1.7a5e:

```
AMF_Master_2# atmf backup now host_0016_76b1_7a5e
```

**NOTE:** *When a host name is derived from its MAC address, the syntax format entered changes from XXXX.XXXX.XXXX to XXXX\_XXXX\_XXXX.*

**Example 2** In this example, an AMF member has the host name, **office\_annex**. The following command will immediately backup this device:

```
AMF_Master_2# atmf backup now office_annex
```

This command is initiated on the device's master node named **AMF\_Master\_2** and initiates an immediate backup on the device named **office\_annex**.

**Example 3** To initiate from AMF\_master\_1 an immediate backup of all AMF member nodes, use the following command:

```
AMF_Master_1# amf backup now
```

**Example 4** To initiate an immediate backup of the node with the host-name “office\_annex” and store the configuration on both masters, use the following process:

From the AMF\_master\_1, set the working-set to comprise only of the automatic group, master nodes.

```
AMF_Master_1# atmf working-set group master
```

This command returns the following display:

```
=====
AMF_Master_1, AMF_Master_2
=====

Working set join
```

Backup the AMF member with the host name, **office\_annex** on both the master nodes as defined by the working set.

```
AMF_Master[2]# atmf backup now office_annex
```

Note that the [2] shown in the command prompt indicates a 2 node working-set.

- Related commands**
- [atmf backup](#)
  - [atmf backup stop](#)
  - [hostname](#)
  - [show atmf backup](#)

# atmf backup redundancy enable

**Overview** This command is used to enable or disable AMF backup redundancy.

**Syntax** `atmf backup redundancy enable`  
`no atmf backup redundancy enable`

**Default** Disabled

**Mode** Global Configuration

**Usage notes** If the AMF Master or Controller supports any removable media (SD card/USB), it uses the removable media as the redundant backup for the AMF data backup.

This feature is valid only if remote file servers are configured on the AMF Master or Controller.

We recommend using the ext3 or ext4 filesystem on external media that are used for AMF backups.

**Example** To enable AMF backup redundancy, use the commands:

```
awplus# configure terminal
awplus(config)# atmf backup redundancy enable
```

To disable AMF backup redundancy, use the commands:

```
awplus# configure terminal
awplus(config)# no atmf backup redundancy enable
```

**Related commands** [atmf backup synchronize](#)  
[show atmf backup](#)  
[show atmf backup area](#)



# atmf backup server

**Overview** This command configures remote file servers as the destination for AMF backups.

Use the **no** variant of this command to remove the destination server(s). When all servers are removed the system will revert to backup from external media.

**Syntax** `atmf backup server id {1|2} <hostlocation> username <username> [path <path>|port <1-65535>]`  
`no atmf backup server id {1|2}`

Parameter	Description
id	Remote server backup server identifier.
{1 2}	The backup server identifier number (1 or 2). Note that there can be up to two backup servers, numbered 1 and 2 respectively, and you would need to run this command separately for each server.
<hostlocation>	Either the name or the IP address (IPv4 or IPv6) of the selected backup server (1 or 2).
username	Configure the username to log in with on the selected remote file server.
<username>	The selected remote file server's username.
path	The location of the backup files on the selected remote file server. By default this will be the home directory of the username used to log in with.
<path>	The directory path utilized to store the backup files on the selected remote file server. No spaces are allowed in the path.
port	The connection to the selected remote backup file server using SSH. By default SSH connects to a device on TCP port 22 but this can be changed with this command.
<1-65535>	A TCP port within the specified range.

**Defaults** Remote backup servers are not configured. The default SSH TCP port is 22. The path utilized on the remote file server is the home directory of the username.

**Mode** Global Exec

**Usage notes** The hostname and username parameters must both be configured.

**Examples** To configure server 1 with an IPv4 address and a username of *backup1*, use the commands:

```
AMF_Master_1# configure terminal
AMF_Master_1(config)# atmf backup server id 1 192.168.1.1
username backup1
```

To configure server 1 with an IPv6 address and a username of *backup1*, use the command:

```
AMF_backup1_1# configure terminal
AMF_Master_1(config)# atmf backup server id 1 FFEE::01 username
backup1
```

To configure server 2 with a hostname and username, use the command:

```
AMF_Master_1# configure terminal
AMF_Master_1(config)# atmf backup server id 2 www.example.com
username backup2
```

To configure server 2 with a hostname and username in addition to the optional path and port parameters, use the command:

```
AMF_Master_1# configure terminal
AMF_Master_1(config)# atmf backup server id 2 www.example.com
username backup2 path tokyo port 1024
```

To unconfigure the AMF remote backup file server 1, use the command:

```
AMF_Master_1# configure terminal
AMF_Master_1(config)# no atmf backup server id 1
```

**Related commands** [show atmf backup](#)

# atmf backup stop

**Overview** Running this command stops a backup that is currently running on the master node you are logged onto. Note that if you have two masters and want to stop both, then you can either run this command separately on each master node, or add both masters to a working set, and issue this command to the working set.

Note that this command can only be run on a master node.

**Syntax** `atmf backup stop`

**Mode** Privileged Exec

**Usage notes** This command is used to halt an AMF backup that is in progress. In this situation the backup process will finish on its current node and then stop.

**Example** To stop a backup that is currently executing on master node node-1, use the following command:

```
AMF_Master_1# amf backup stop
```

**Related commands**

- [atmf backup](#)
- [atmf backup enable](#)
- [atmf backup now](#)
- [show atmf backup](#)

# atmf backup synchronize

**Overview** For the master node you are connected to, this command initiates a system backup of files from the node's active remote file server to its backup remote file server. Note that this process happens automatically each time the network is backed up.

Note that this command can only be run from a master node.

**Syntax** `atmf backup synchronize`

**Mode** Privileged Exec

**Example** When connected to the master node `AMF_Master_1`, the following command will initiate a backup of all system related files from its active remote file server to its backup remote file server.

```
AMF_Master_1# atmf backup synchronize
```

**Related commands**

- [atmf backup enable](#)
- [atmf backup redundancy enable](#)
- [show atmf](#)
- [show atmf backup](#)

# atmf cleanup

**Overview** This command erases all data from Flash **excluding** the following:

- the boot release file (a .rel file) and its release setting file
- all license files
- the latest GUI release file

It then reboots to put the device in a clean state ready to be used as a replacement node on a provisioned port.

**Syntax** atmf cleanup

**Mode** Privileged Exec

**Usage notes** This command is an alias to the [erase factory-default](#) command.

**Example** To erase data, use the command:

```
Node_1# atmf cleanup
```

```
This command will erase all NVS, all flash contents except for  
the boot release, a GUI resource file, and any license files, and  
then reboot the switch. Continue? (y/n):y
```

**Related commands** [erase factory-default](#)

# atmf container

**Overview** Use this command to create or update an AMF container on a Virtual AMF Appliance (VAA) virtual machine.

An AMF container is an isolated instance of AlliedWare Plus with its own network interfaces, configuration, and file system. The features available inside an AMF container are a sub-set of the features available on the host VAA. These features enable the AMF container to function as a uniquely identifiable AMF master and allows for multiple tenants (up to 60) to run on a single VAA host. See the [AMF Feature Overview and Configuration Guide](#) for more information on running multiple tenants on a single VAA host.

Use the **no** variant of this command to remove an AMF container.

**Syntax** `atmf container <container-name>`  
`no atmf container <container-name>`

Parameter	Description
<code>&lt;container-name&gt;</code>	The name of the AMF container to create, update, or remove.

**Mode** AMF Container Configuration

**Usage notes** You cannot delete a container while it is still running. First use the **state disable** command to stop the container.

**Examples** To create or update the AMF container "vac-wlg-1", use the commands:

```
awplus# configure terminal
awplus(config)# atmf container vac-wlg-1
awplus(config-atmf-container)#
```

To remove the AMF container "vac-wlg-1", use the commands:

```
awplus# configure terminal
awplus(config)# no atmf container vac-wlg-1
```

**Related commands**

- [area-link](#)
- [atmf container login](#)
- [bridge-group](#)
- [description \(amf-container\)](#)
- [show atmf container](#)
- [state](#)

**Command changes** Version 5.4.7-0.1: command added

# atmf container login

**Overview** Use this command to login to an AMF container on a Virtual AMF Appliance (VAA).

An AMF container is an isolated instance of AlliedWare Plus with its own network interfaces, configuration, and file system. The features available inside an AMF container are a sub-set of the features available on the host VAA. These features enable the AMF container to function as a uniquely identifiable AMF master and allows for multiple tenants (up to 60) to run on a single VAA host. See the [AMF Feature Overview and Configuration Guide](#) for more information on running multiple tenants on a single VAA host.

**Syntax** `atmf container login <container-name>`

Parameter	Description
<code>&lt;container-name&gt;</code>	The name of the AMF container you wish to login into.

**Mode** Privileged Exec

**Usage notes** If you try to login to a AMF container that has not been created, or is not running, you will see the following message:

```
% Container does not exist or is not running.
```

To exit from a container and return to the host VAA press `<Ctrl+a q>`.

**Example** To login to container “vac-wlg-1”, use the command:

```
awplus# atmf container login vac-wlg-1
```

You will then be presented with a login screen for that container:

```
Connected to tty 1
Type <Ctrl+a q> to exit the console, <Ctrl+a Ctrl+a> to enter Ctrl+a itself

vac-wlg-1 login: manager
Password: friend

AlliedWare Plus (TM) 5.4.7 02/03/17 08:46:12

vac-wlg-1>
```

**Related commands** [atmf container](#)  
[show atmf container](#)

**Command changes** Version 5.4.7-0.1: command added

# atmf controller

**Overview** Use this command to configure the device as an AMF controller. This enables you to split a large AMF network into multiple areas.

AMF controller is a licensed feature. The number of areas supported on a controller depends on the license installed on that controller.

Use the **no** variant of this command to remove the AMF controller functionality.

**Syntax** `atmf controller`  
`no atmf controller`

**Mode** Global configuration

**Usage notes** If a valid AMF controller license is not available on the device, the device will accept this command but will not act as a controller until you install a valid license. The following message will warn you of this:

“An AMF Controller license must be installed before this feature will become active”

**NOTE:** *If the AMF controller functionality is removed from a device using the **no atmf controller** command then the device must be rebooted if it is to function properly as an AMF master.*

**Example** To configure the node named *controller-1* as an AMF controller, use the commands:

```
controller-1# configure terminal
controller-1(config)# atmf controller
```

To stop the node named *controller-1* from being an AMF controller, use the commands:

```
controller-1# configure terminal
controller-1(config)# no atmf controller
```

**Related commands** `atmf area`  
`show atmf`



# atmf distribute firmware

**Overview** This command can be used to upgrade software one AMF node at a time. A URL can be selected from any media location. The latest compatible release for a node will be selected from this location.

Several procedures are performed to ensure the upgrade will succeed. This includes checking the current node release boots from flash. If there is enough space on flash the software release is copied to flash on the new location.

The new release name is updated using the [boot system](#) command. The old release will become the backup release file. If a release file exists in a remote device (such as TFTP or HTTP, for example) then the URL should specify the exact release filename without using a wild card character.

The command will continue to upgrade software until all nodes are upgraded. At the end of the upgrade cycle the command should be used on the working-set.

**Syntax** `atmf distribute firmware <filename>`

Parameter	Description
<code>&lt;filename&gt;</code>	The filename and path of the file. See the <a href="#">File Management Feature Overview and Configuration Guide</a> for valid syntax.

**Mode** Privileged Exec

**Examples** To upgrade nodes in a AMF network with a predefined AMF group called "teams", use the following commands:

```
Team1# atmf working-set group teams
```

```
=====
Team1, Team2, Team3:
=====
Working set join
```

```
ATMF_NETWORK[3]# atmf distribute firmware card:*.rel
```

```
Retrieving data from Team1
Retrieving data from Team2
Retrieving data from Team3

ATMF Firmware Upgrade:

Node Name          New Release File          Status
-----
Team1              x510-5.4.7-1.1.rel       Release ready
Team2              x930-5.4.7-1.1.rel       Release ready
Team3              x930-5.4.7-1.1.rel       Release ready
Continue the rolling reboot ? (y/n):y
=====
Copying Release    : x510-5.4.7-1.1.rel to Team1
Updating Release   : x510-5.4.7-1.1.rel information on Team1
=====
Copying Release    : x930-5.4.7-1.1.rel to Team2
Updating Release   : x930-5.4.7-1.1.rel information on Team2
=====
Copying Release    : x930-5.4.7-1.1.rel to Team3
Updating Release   : x930-5.4.7-1.1.rel information on Team3
=====
New firmware will not take effect until nodes are rebooted.
=====

ATMF_NETWORK[3]#
```

**Related commands** [atmf working-set](#)

# atmf domain vlan

**Overview** The AMF domain VLAN is created when the AMF network is first initiated and is assigned a default VID of 4091. This command enables you to change the VID from this default value on this device.

The AMF domain VLAN is one of AMF's internal VLANs (the management VLAN is the other internal VLAN). AMF uses these internal VLANs to communicate network status information between nodes. These VLANs must be reserved for AMF and not used for other purposes.

An important point conceptually is that although the domain VLAN exists globally across the AMF network, it is assigned separately to each domain. The AMF network therefore can be thought of as comprising a series of domain VLANs each having the same VID and each being applied to a horizontal slice (domain) of the AMF. It follows therefore that the domain VLANs are only applied to ports that form cross-links and not to ports that form uplinks/downlinks.

**CAUTION:** Every member of your AMF network must have the same domain VLAN, management VLAN, and management subnet.

**CAUTION:** If you change the domain VLAN, management VLAN, or management subnet of a node, that change takes effect immediately and the node will immediately leave the AMF network and try to rejoin it. The AMF network will not be complete until you have given all devices the same setting, so they can all rejoin the AMF network.

Use the **no** variant of this command to reset the VLAN ID to its default value of 4091.

**Syntax** atmf domain vlan <2-4090>  
no atmf domain vlan

Parameter	Description
<2-4090>	The VLAN number in the range 2 to 4090.

**Default** VLAN 4091

**Mode** Global Configuration

**Usage notes** We recommend you only change the domain VLAN when first creating the AMF network, and only if VLAN 4091 is already being used in your network.

However, if you do need to change the VLAN on an existing AMF network, use the following steps:

- 1) Create a working set of the whole of your AMF network, using the commands:

```
master# atmf working-set group all
```

You must use **working-set group all** if changing the domain VLAN. If you use a different working-set, nodes that are not in that working-set will lose contact with the AMF network.

- 2) The prompt will display the number of nodes in the AMF network. Record this number. In this example, the network is named "test" and has 10 nodes:

```
test[10]#
```

- 3) Enter the new VLAN ID, using the commands:

```
test[10]# configure terminal
```

```
test(config)[10]# atmf domain vlan <2-4090>
```

The nodes will execute the command in parallel, leave the AMF network, and attempt to rejoin through the new VLAN.

- 4) Create the working set again, using the commands:

```
master(config)# exit
```

```
master# atmf working-set group all
```

- 5) Save the configuration, using the command:

```
test[10]# write
```

- 6) The prompt will display the number of nodes in the AMF network. Check that this is the same as the number in step 1. If it is not, you will need to change the VLAN on missing devices by logging into their consoles directly.

**NOTE:** The domain VLAN will automatically be assigned an IP subnet address based on the value configured by the command *atmf management subnet*.

The default VLAN ID lies outside the user-configurable range. If you need to reset the VLAN to the default VLAN ID, use the **no** variant of this command to do so.

**Examples** To change the AMF domain VLAN to 4090 in an existing AMF network, use the following commands:

```
master# atmf working-set group all
```

```
test[10]# configure terminal
```

```
test(config)[10]# atmf domain vlan 4090
```

```
master(config)# exit
```

```
master# atmf working-set group all
```

```
test[10]# write
```

To reset the AMF domain VLAN to its default of 4091 in an existing AMF network, use the following commands:

```
master# atmf working-set group all
test[10]# configure terminal
test(config)[10]# no atmf domain vlan
master(config)# exit
master# atmf working-set group all
test[10]# write
```

**Related commands** [atmf management subnet](#)  
[atmf management vlan](#)

# atmf enable

**Overview** This command manually enables (turns on) the AMF feature for the device being configured.

Use the **no** variant of this command to disable (turn off) the AMF feature on the member node.

**Syntax** atmf enable  
no atmf enable

**Default** Once AMF is configured, the AMF feature starts automatically when the device starts up.

**Mode** Global Configuration

**Usage notes** The device does not auto negotiate AMF domain specific settings such as the Network Name. You should therefore, configure your device with any domain specific (non default) settings before enabling AMF.

**Examples** To turn off AMF, use the command:

```
MyNode# config terminal
MyNode(config)# no atmf enable
```

To turn on AMF, use the command:

```
MyNode(config)# atmf enable
```

This command returns the following display:

```
% Warning: The ATMF network config has been set to enable
% Save the config and restart the system for this change to take
effect.
```

# atmf group (membership)

**Overview** This command configures a device to be a member of one or more AMF groups. Groups exist in three forms: Implicit Groups, Automatic Groups, and User-defined Groups.

- Implicit Groups
  - all: All nodes in the AMF
  - current: The current working-set
  - local: The originating node.

Note that the Implicit Groups do not appear in show group output.

- Automatic Groups - These are defined by hardware architecture, e.g. x510, x230, x8100, AR3050S, AR4050S.
- User-defined Groups - These enable you to define arbitrary groups of AMF members based on your own criteria.

Each node in the AMF is automatically assigned membership to the implicit groups, and the automatic groups that are appropriate to its node type, e.g. x230, PoE. Similarly, nodes that are configured as masters are automatically assigned to the master group.

Use the **no** variant of this command to remove the membership.

**Syntax** `atmf group <group-list>`  
`no atmf group <group-list>`

Parameter	Description
<code>&lt;group-list&gt;</code>	A list of group names. These should be entered as a comma delimited list without spaces. Names can contain alphanumeric characters, hyphens and underscores.

**Mode** Global Configuration

**Usage notes** You can use this command to define your own arbitrary groups of AMF members based on your own network's configuration requirements. Applying a node to a non existing group will result in the group automatically being created.

Note that the master nodes are automatically assigned to be members of the pre-existing master group.

The following example configures the device to be members of three groups; two are company departments, and one comprises all devices located in building\_2. To avoid having to run this command separately on each device that is to be added to these groups, you can remotely assign all of these devices to a working-set, then use the capabilities of the working-set to apply the [atmf group \(membership\)](#) command to all members of the working set.

**Example 1** To specify the device to become a member of AMF groups named *marketing*, *sales*, and *building\_2*, use the following commands:

```
node-1# configure terminal
node-1(config)# atmf group marketing,sales,building_2
```

**Example 2** To add the nodes *member\_node\_1* and *member\_node\_2* to groups *building1* and *sales*, first add the nodes to the working-set:

```
master_node# atmf working-set member_node_1,member_node_2
```

This command returns the following output confirming that the nodes *member\_node\_1* and *member\_node\_2* are now part of the working-set:

```
=====
member_node_1, member_node_2
=====

Working set join
```

Then add the members of the working set to the groups:

```
atmf-net[2]# configure terminal
atmf-net[2](config)# atmf group building1,sales
atmf-net[2](config)# exit
atmf-net[2]# show atmf group
```

This command returns the following output displaying the groups that are members of the working-set.

```
=====
member_node_1
=====

AMF group information

building1, sales
```

**Related commands** [show atmf group](#)  
[show atmf group members](#)



# atmf guest-class

**Overview** This modal command creates a guest-class. Guest-classes are modal templates that can be applied to selected guest types. Once you have created a guest-class, you can select it by entering its mode. From here, you can then configure a further set of operational settings specifically for the new guest-class. These settings can then all be applied to a guest link by running the [switchport atmf-guestlink](#) command. The following settings can be configured from each guest class mode:

- discovery method
- model type
- http-enable setting
- guest port, user name, and password

The **no** variant of this command removes the guest-class. Note that you cannot remove a guest-class that is assigned to a port.

**Syntax** `atmf guest-class <guest-class-name>`  
`no atmf guest-class`

Parameter	Description
<code>&lt;guest-class-name&gt;</code>	The name assigned to the guest-class type. This can be chosen from an arbitrary string of up to 15 characters.

**Mode** Interface

**Example 1** To create a guest-class named **camera** use the following commands:

```
node1# configure terminal
node1(config)# atmf guest-class camera
node1(config-atmf-guest)# end
```

**Example 2** To remove the guest-class named **phone** use the following commands:

```
node1# configure terminal
node1(config)# no atmf guest-class phone
node1(config-atmf-guest)# end
```

**Related commands**

- [show atmf area guests](#)
- [discovery](#)
- [http-enable](#)
- [username](#)
- [modeltype](#)
- [switchport atmf-guestlink](#)

show atmf links guest

show atmf guests

# atmf log-verbose

**Overview** This command limits the number of log messages displayed on the console or permanently logged.

Use the **no** variant of this command to reset to the default.

**Syntax** `atmf log-verbose <1-3>`  
`no atmf log-verbose`

Parameter	Description
<1-3>	The verbose limitation (3 = noisiest, 1 = quietest)

**Default** The default log display is 3.

**Usage** This command is intended for use in large networks where verbose output can make the console unusable for periods of time while nodes are joining and leaving.

**Mode** Global Configuration

**Example** To set the log-verbose to noise level 2, use the command:

```
node-1# configure terminal
node-1(config)# atmf log-verbose 2
```

**Validation Command** `show atmf`

# atmf management subnet

**Overview** This command is used to assign a subnet that will be allocated to the AMF management and domain management VLANs. From the address space defined by this command, two subnets are created, a management subnet component and a domain component, as explained in the Usage section below.

AMF uses these internal IPv4 subnets to communicate network status information between nodes. These subnet addresses must be reserved for AMF and not used for other purposes.

**CAUTION:** Every member of your AMF network must have the same domain VLAN, management VLAN, and management subnet.

**CAUTION:** If you change the domain VLAN, management VLAN, or management subnet of a node, that change takes effect immediately and the node will immediately leave the AMF network and try to rejoin it. The AMF network will not be complete until you have given all devices the same setting, so they can all rejoin the AMF network.

Use the **no** variant of this command to remove the assigned subnet.

**Syntax** atmf management subnet <a.b.0.0>  
no atmf management subnet

Parameter	Description
<a.b.0.0>	The IP address selected for the management subnet. Because a mask of 255.255.0.0 (i.e. /16) will be applied automatically, an IP address in the format a.b.0.0 must be selected. Usually this subnet address is selected from an appropriate range from within the private address space of 172.16.0.0 to 172.31.255.255, or 192.168.0.0, as defined in RFC1918.

**Default** 172.31.0.0. A subnet mask of 255.255.0.0 will automatically be applied.

**Mode** Global Configuration

**Usage notes** Running this command will result in the creation of a further two subnets (within the class B address space assigned) and the mask will extend from /16 to /17.

For example, if the management subnet is assigned the address 172.31.0.0/16, this will result in the automatic creation of the following two subnets:

- 172.31.0.0/17 assigned to the [atmf management vlan](#)
- 172.31.128.0/17 assigned to the [atmf domain vlan](#).

We recommend you only change the management subnet when first creating the AMF network, and only if 172.31.0.0 is already being used in your network.

However, if you do need to change the subnet on an existing AMF network, use the following steps:

- 1) Create a working set of the whole of your AMF network, using the commands:

```
master# atmf working-set group all
```

You must use **working-set group all** if changing the domain VLAN, management VLAN, or management subnet. If you use a different working-set, nodes that are not in that working-set will lose contact with the AMF network.

- 2) The prompt will display the number of nodes in the AMF network. Record this number. In this example, the network is named "test" and has 10 nodes:

```
test[10]#
```

- 3) Enter the new subnet address, using the commands:

```
test[10]# configure terminal
```

```
test(config)[10]# atmf management subnet <a.b.0.0>
```

The nodes will execute the command in parallel, leave the AMF network, and attempt to rejoin through the new subnet.

- 4) Create the working set again, using the commands:

```
master(config)# exit
```

```
master# atmf working-set group all
```

- 5) Save the configuration, using the command:

```
test[10]# write
```

- 6) The prompt will display the number of nodes in the AMF network. Check that this is the same as the number in step 1. If it is not, you will need to change the subnet on missing devices by logging into their consoles directly.

**Examples** To change the AMF management subnet address to 172.25.0.0 in an existing AMF network, use the following commands:

```
master# atmf working-set group all
```

```
test[10]# configure terminal
```

```
test(config)[10]# atmf management subnet 172.25.0.0
```

```
master(config)# exit
```

```
master# atmf working-set group all
```

```
test[10]# write
```

To reset the AMF management subnet address to its default of 172.31.0.0 in an existing AMF network, use the following commands:

```
master# atmf working-set group all
test[10]# configure terminal
test(config)[10]# no atmf management subnet
master(config)# exit
master# atmf working-set group all
test[10]# write
```

**Related commands**

- [atmf domain vlan](#)
- [atmf management vlan](#)

# atmf management vlan

**Overview** The AMF management VLAN is created when the AMF network is first initiated and is assigned a default VID of 4092. This command enables you to change the VID from this default value on this device.

The AMF management VLAN is one of AMF's internal VLANs (the domain VLAN is the other internal VLAN). AMF uses these internal VLANs to communicate network status information between nodes. These VLANs must be reserved for AMF and not used for other purposes.

**CAUTION:** Every member of your AMF network must have the same domain VLAN, management VLAN, and management subnet.

**CAUTION:** If you change the domain VLAN, management VLAN, or management subnet of a node, that change takes effect immediately and the node will immediately leave the AMF network and try to rejoin it. The AMF network will not be complete until you have given all devices the same setting, so they can all rejoin the AMF network.

Use the **no** variant of this command to restore the VID to the default of 4092.

**Syntax** `atmf management vlan <2-4090>`  
`no atmf management vlan`

Parameter	Description
<code>&lt;2-4090&gt;</code>	The VID assigned to the AMF management VLAN.

**Default** VLAN 4092

**Mode** Global Configuration

**Usage notes** We recommend you only change the management VLAN when first creating the AMF network, and only if VLAN 4092 is already being used in your network.

However, if you do need to change the VLAN on an existing AMF network, use the following steps to ensure you change it on all nodes simultaneously:

- 1) Create a working set of the whole of your AMF network, using the commands:

```
master# atmf working-set group all
```

You must use **working-set group all** if changing the management VLAN. If you use a different working-set, nodes that are not in that working-set will lose contact with the AMF network.

- 2) The prompt will display the number of nodes in the AMF network. Record this number. In this example, the network is named "test" and has 10 nodes:

```
test[10]#
```

- 3) Enter the new VLAN ID, using the commands:

```
test[10]# configure terminal
test(config)[10]# atmf management vlan <2-4090>
```

The nodes will execute the command in parallel, leave the AMF network, and attempt to rejoin through the new VLAN.

- 4) Create the working set again, using the commands:

```
master(config)# exit
master# atmf working-set group all
```

- 5) Save the configuration, using the command:

```
test[10]# write
```

- 6) The prompt will display the number of nodes in the AMF network. Check that this is the same as the number in step 1. If it is not, you will need to change the VLAN on missing devices by logging into their consoles directly.

**NOTE:** The management VLAN will automatically be assigned an IP subnet address based on the value configured by the command [atmf management subnet](#).

The default VLAN ID lies outside the user-configurable range. If you need to reset the VLAN to the default VLAN ID, use the **no** variant of this command to do so.

**Examples** To change the AMF management VLAN to 4090 in an existing AMF network, use the following commands:

```
master# atmf working-set group all
test[10]# configure terminal
test(config)[10]# atmf management vlan 4090
master(config)# exit
master# atmf working-set group all
test[10]# write
```

To reset the AMF management VLAN to its default of 4092 in an existing AMF network, use the following commands:

```
master# atmf working-set group all
test[10]# configure terminal
test(config)[10]# no atmf management vlan
master(config)# exit
master# atmf working-set group all
test[10]# write
```

**Related commands** [atmf domain vlan](#)  
[atmf management subnet](#)



# atmf master

**Overview** This command configures the device to be an AMF master node and automatically creates an AMF master group. The master node is considered to be the core of the AMF network, and must be present for the AMF to form. The AMF master has its node depth set to 0. Note that the node depth vertical distance is determined by the number of uplinks/downlinks that exist between the node and its master.

An AMF master node must be present for an AMF network to form. Up to two AMF master nodes may exist in a network, and they **must** be connected by an AMF crosslink.

**NOTE:** Master nodes are an essential component of an AMF network. In order to run AMF, an AMF License is required for each master node.

If the crosslink between two AMF masters fails, then one of the masters will become isolated from the rest of the AMF network.

Use the **no** variant of this command to remove the device as an AMF master node. The node will retain its node depth of 0 until the network is rebooted.

**NOTE:** Node depth is the vertical distance (or level) from the master node (whose depth value is 0).

**Syntax** atmf master  
no atmf master

**Default** The device is not configured to be an AMF master node.

**Mode** Global Configuration

**Example** To specify that this node is an AMF master, use the following command:

```
node-1# configure terminal
node-1(config)# atmf master
```

**Related commands** [show atmf](#)  
[show atmf group](#)

# atmf mtu

**Overview** This command configures the AMF network Maximum Transmission Unit (MTU). The MTU value will be applied to the AMF Management VLAN, the AMF Domain VLAN and AMF Area links.

Use the **no** variant of this command to restore the default MTU.

**Syntax** `atmf mtu <1300-1442>`  
`no atmf mtu`

Parameter	Description
<1300-1442>	The value of the maximum transmission unit for the AMF network, which sets the maximum size of all AMF packets generated from the device.

**Default** 1300

**Mode** Global Configuration

**Usage notes** The default value of 1300 will work for all AMF networks (including those that involve virtual links over IPsec tunnels). If there are virtual links over IPsec tunnels anywhere in the AMF network, we recommend not changing this default. If there are no virtual links over IPsec tunnels, then this AMF MTU value may be increased for network efficiency.

**Example** To change the ATMF network MTU to 1442, use the command:

```
awplus(config)# atmf mtu 1442
```

**Related commands** [show atmf detail](#)

# atmf network-name

**Overview** This command applies an AMF network name to a (prospective) AMF node. In order for an AMF network to be valid, its network-name must be configured on at least two nodes, one of which must be configured as a master and have an AMF License applied. These nodes may be connected using either AMF downlinks or crosslinks.

For more information on configuring an AMF master node, see the command [atmf master](#).

Use the **no** variant of this command to remove the AMF network name.

**Syntax** `atmf network-name <name>`  
`no atmf network-name`

Parameter	Description
<code>&lt;name&gt;</code>	The AMF network name. Up to 15 printable characters can be entered for the network-name.

**Mode** Global Configuration

**Usage notes** This is one of the essential commands when configuring AMF and must be entered on each node that is to be part of the AMF.

A switching node (master or member) may be a member of only one AMF network.

**CAUTION:** *Ensure that you enter the correct network name. Entering an incorrect name will cause the AMF network to fragment (at the next reboot).*

**Example** To set the AMF network name to `amf_net` use the command:

```
Node_1(config)# atmf network-name amf_net
```

# atmf provision (interface)

**Overview** This command configures a specified port on an AMF node to accept a provisioned node, via an AMF link, some time in the future.

Use the **no** variant of this command to remove the provisioning on the node.

**Syntax** `atmf provision <nodename>`  
`no atmf provision`

Parameter	Description
<code>&lt;nodename&gt;</code>	The name of the provisioned node that will appear on the AMF network in the future.

**Mode** Interface Configuration for a switchport, a static aggregator or a dynamic channel group.

**Usage notes** The port should be configured as an AMF link or cross link and should be “down” to add or remove a provisioned node.

**Example** To provision an AMF node named node1 for port1.0.1, use the command:

```
host1(config)# interface port1.0.1
host1(config-if)# atmf provision node1
```

**Related commands**

- atmf provision node
- clone (amf-provision)
- configure boot config (amf-provision)
- configure boot system (amf-provision)
- copy (amf-provision)
- create (amf-provision)
- delete (amf-provision)
- identity (amf-provision)
- license-cert (amf-provision)
- locate (amf-provision)
- show atmf provision nodes
- show atmf links
- switchport atmf-link
- switchport atmf-crosslink

# atmf provision node

**Overview** Use this command to provision a replacement node for a specified interface. Node provisioning is effectively the process of creating a backup file-set on a master node that can be loaded onto a provisioned node some time in the future. This file-set is created just as if the provisioned node really existed and was connected to the network. Typically these comprise configuration, operating system, and license files etc.

You can optionally provision a node with multiple device-type backups. When a device is then attached to the network, AMF uses its device-type to find the correct configuration to use. For example you can create an x510 and an x530 provisioning configuration for a node called 'node1' and if either an x510 or an x530 is attached to that node the appropriate configuration will be used.

Use the **no** variant of this command to remove a provisioned node.

**Syntax** `atmf provision node <nodename> [device <device-type>]`  
`no atmf provision node <nodename> [device <device-type>]`

Parameter	Description
<nodename>	The name of the provisioned node that will appear on the AMF network.
device	Optionally specify a device type.
<device-type>	Any valid device type e.g. AR3050s, ie200, x950. For a full list of valid device types use the command <b>atmf provision node &lt;nodename&gt; device ?</b> .

**Mode** Privileged Exec

**Usage notes** This command creates the directory structure for the provisioned node's file-set. It also switches to the AMF provision node prompt so that the nodes backup file-set can be created or updated. This is typically done with the [create \(amf-provision\)](#) or [clone \(amf-provision\)](#) commands.

For more information on AMF provisioning, see the [AMF Feature Overview and Configuration Guide](#)..

**Example** To configure node named 'node1', use the command:

```
awplus# atmf provision node node1  
awplus(atmf-provision)#
```

To configure a node named 'node1' for device type 'x530', use the command:

```
awplus# atmf provision node node1 device x530  
awplus(atmf-provision)#
```

**Related commands**

- atmf provision (interface)
- clone (amf-provision)
- configure boot config (amf-provision)
- configure boot system (amf-provision)
- copy (amf-provision)
- create (amf-provision)
- delete (amf-provision)
- identity (amf-provision)
- license-cert (amf-provision)
- locate (amf-provision)
- show atmf provision nodes

**Command changes** Version 5.4.9-0.1: command added

# atmf reboot-rolling

**Overview** This command enables you to reboot the nodes in an AMF working-set, one at a time, as a rolling sequence in order to minimize downtime. Once a rebooted node has finished running its configuration and its ports are up, it re-joins the AMF network and the next node is rebooted.

By adding the *url* parameter, you can also upgrade your devices' software one AMF node at a time.

The **force** parameter forces the rolling reboot to continue even if a previous node does not rejoin the AMF network. Without the **force** parameter, the unsuitable node will time-out and the rolling reboot process will stop. However, with the **force** parameter applied, the process will ignore the timeout and move on to reboot the next node in the sequence.

This command can take a significant amount of time to complete.

**Syntax** `atmf reboot-rolling [force] [<url>]`

Parameter	Description
<code>force</code>	Ignore a failed node and move on to the next node. Where a node fails to reboot a timeout is applied based on the time taken during the last reboot.
<code>&lt;url&gt;</code>	The path to the software upgrade file.

**Mode** Privileged Exec

**Usage notes** You can load the software from a variety of locations. The latest compatible release for a node will be selected from your selected location, based on the parameters and URL you have entered.

For example `card:/5.4.6/x*-5.4.6-*.rel` will select from the folder `card:/5.4.6` the latest file that matches the selection `x` (wildcard) `-5.4.6-` (wildcard).`rel`. Because `x*` is applied, each device type will be detected and its appropriate release file will be installed.

Other allowable entries are:

Entry	Used when loading software
<code>card:*.rel:</code>	from an SD card
<code>tftp:&lt;ip-address&gt;:</code>	from a TFTP server
<code>usb:</code>	from a USB flash drive
<code>flash:</code>	from flash memory, e.g. from one x930 switch to another
<code>scp:</code>	using secure copy
<code>http:</code>	from an HTTP file server

Several checks are performed to ensure the upgrade will succeed. These include checking the current node release boots from flash. If there is enough space on flash, the software release is copied to flash to a new location on each node as it is processed. The new release name will be updated using the **boot system**<release-name> command, and the old release will become the backup release file.

**NOTE:** If you are using TFTP or HTTP, for example, to access a file on a remote device then the URL should specify the exact release filename without using wild card characters.

On bootup the software release is verified. Should an upgrade fail, the upgrading unit will revert back to its previous software version. At the completion of this command, a report is run showing the release upgrade status of each node.

**NOTE:** Take care when removing external media or rebooting your devices. Removing an external media while files are being written entails a significant risk of causing a file corruption.

**Example 1** To reboot all x510 nodes in an AMF network, use the following command:

```
Bld2_Floor_1# atmf working-set group x510
```

This command returns the following type of screen output:

```
=====
node1, node2, node3:
=====

Working set join

AMF_NETWORK[3]#
```

```
ATMF_NETWORK[3]# atmf reboot-rolling
```

When the reboot has completed, a number of status screens appear. The selection of these screens will depend on the parameters set.



```
Bld2_Floor_1#atmf working-set group x510

=====
SW_Team1, SW_Team2, SW_Team3:
=====

Working set join

ATMF_NETWORK[3]#atmf reboot-rolling
ATMF Rolling Reboot Nodes:

Node Name                Timeout
                        (Minutes)
-----
SW_Team1                  14
SW_Team2                   8
SW_Team3                   8
Continue the rolling reboot ? (y/n):y
=====
ATMF Rolling Reboot: Rebooting SW_Team1
=====

% SW_Team1 has left the working-set
Reboot of SW_Team1 has completed
=====
ATMF Rolling Reboot: Rebooting SW_Team2
=====

% SW_Team2 has left the working-set
Reboot of SW_Team2 has completed
=====
ATMF Rolling Reboot: Rebooting SW_Team3
=====

% SW_Team3 has left the working-set
Reboot of SW_Team3 has completed

=====
ATMF Rolling Reboot Complete
Node Name                Reboot Status
-----
SW_Team1                  Rebooted
SW_Team2                  Rebooted
SW_Team3                  Rebooted
=====
```

**Example 2** To update firmware releases, use the following command:

```
Node_1# atmf working-set group all

ATMF_NETWORK[9]# atmf reboot-rolling
card:/5.4.6/x*-5.4.6-*.rel
```

```
ATMF Rolling Reboot Nodes:
```

Node Name	Timeout (Minutes)	New Release File	Status
SW_Team1	8	x510-5.4.6-0.1.rel	Release Ready
SW_Team2	10	x510-5.4.6-0.1.rel	Release Ready
SW_Team3	8	---	Not Supported
HW_Team1	6	---	Incompatible
Bld1_Floor_2	2	x930-5.4.6-0.1.rel	Release Ready
Bld1_Floor_1	4	---	Incompatible
Building_1	2	---	Incompatible
Building_2	2	x908-5.4.6-0.1.rel	Release Ready

Continue upgrading releases ? (y/n):

# atmf recover

**Overview** This command is used to manually initiate the recovery (or replication) of an AMF node, usually when a node is being replaced.

**Syntax** `atmf recover [<node-name> master <node-name>]`  
`atmf recover [<node-name> controller <node-name>]`

Parameter	Description
<i>&lt;node-name&gt;</i>	The name of the device whose configuration is to be recovered or replicated.
master <i>&lt;node-name&gt;</i>	The name of the master device that holds the required configuration information. Note that although you can omit both the node name and the master name; you cannot specify a master name unless you also specify the node name.
controller <i>&lt;node-name&gt;</i>	The name of the controller that holds the required configuration information. Note that although you can omit both the node name and the controller name; you cannot specify a controller name unless you also specify the node name.

**Mode** Privileged Exec

**Usage notes** The recovery/replication process involves loading the configuration file for a node that is either about to be replaced or has experienced some problem. You can specify the configuration file of the device being replaced by using the *<node-name>* parameter, and you can specify the name of the master node or controller holding the configuration file.

If the *<node-name>* parameter is not entered then the node will attempt to use one that has been previously configured. If the replacement node has no previous configuration (and has no previously used node-name), then the recovery will fail.

If the master or controller name is not specified then the device will poll all known AMF masters and controllers and execute an election process (based on the last successful backup and its timestamp) to determine which to use. If no valid backup master or controller is found, then this command will fail.

No error checking occurs when this command is run. Regardless of the last backup status, the recovering node will attempt to load its configuration from the specified master node or controller.

If the node has previously been configured, we recommend that you suspend any AMF backup before running this command. This is to prevent corruption of the backup files on the AMF master as it attempts to both backup and recover the node at the same time.

**Example** To recover the AMF node named Node\_10 from the AMF master node named Master\_2, use the following command:

```
Master_2# atmf recover Node_10 master Master_2
```

**Related commands**

- atmf backup stop
- show atmf backup
- show atmf

# atmf recover guest

**Overview** Use this command to initiate a guest node recovery or replacement by reloading its backup file-set that is located within the AMF backup system. Note that this command must be run on the edge node device that connects to the guest node.

**Syntax** `atmf recover guest [<guest-port>]`

Parameter	Description
<code>&lt;guest-port&gt;</code>	The port number that connects to the guest node.

**Mode** User Exec/Privileged Exec

**Example** To recover a guest on node1 port1.0.1, use the following command

```
node1# atmf recover guest port1.0.1
```

**Related commands** [show atmf backup guest](#)

# atmf recover led-off

**Overview** This command turns off the recovery failure flashing port LEDs. It reverts the LED's function to their normal operational mode, and in doing so assists with resolving the recovery problem. You can repeat this process until the recovery failure has been resolved. For more information, see the [AMF Feature Overview and Configuration Guide](#).

**Syntax** `atmf recover led-off`

**Default** Normal operational mode

**Mode** Privileged Exec

**Example** To revert the LEDs on Node1 from recovery mode display to their normal operational mode, use the command:

```
Node1# atmf recover led-off
```

**Related commands** [atmf recover](#)

# atmf recovery-server

**Overview** Use this command on an AMF master to process recovery requests from isolated AMF nodes. An isolated node is an AMF member that is only connected to the rest of the AMF network via a virtual-link.

This option allows these nodes, which have no AMF neighbors, to be identified for recovery or provisioning purposes. They are identified using an identity token which is stored on the AMF master.

Use the **no** variant of this command to disable processing of recovery requests from isolated AMF nodes.

**Syntax** `atmf recovery-server`  
`no atmf recovery-server`

**Default** Recovery-server is disabled by default.

**Mode** Global Configuration

**Usage notes** Once **recovery-server** is enabled on an AMF network, the next time an isolated node is backed up its identity token will be stored in the AMF master's database. Should the device fail it can then be replaced and auto-recovery will occur as long as:

- the AMF master is accessible to the isolated node, and
- either, a DHCP server is configured to send the Uniform Resource Identifier (URI) of the AMF master to the recovering node, or
- a DNS server is configured to resolve the default recovery URI (`https://amfrecovery.alliedtelesis.com`) to the IP address of the AMF master.

Provisioning of isolated nodes is achieved by creating an identity token for the new node using the [identity \(amf-provision\)](#) command.

See the [AMF Feature Overview and Configuration Guide](#) for information on preparing your network for recovering or provisioning isolated nodes.

**Example** To enable recovery-server on an AMF master, use the commands:

```
awplus# configure terminal
awplus(config)# atmf recovery-server
```

To disable recovery-server on an AMF master, use the commands:

```
awplus# configure terminal
awplus(config)# no atmf recovery-server
```

**Related commands**

- [atmf backup](#)
- [atmf cleanup](#)
- [identity \(amf-provision\)](#)
- [atmf virtual-link](#)

**Command changes** Version 5.4.7-2.1: command added



# atmf remote-login

**Overview** Use this command to remotely login to other AMF nodes in order to run commands as if you were a local user of that node.

**Syntax** `atmf remote-login [user <name>] <nodename>`

Parameter	Description
<name>	The name of a user on the remote node.
<nodename>	The name of the remote AMF node you are connecting to.

**Mode** Privileged Exec (This command will only run at privilege level 15)

**Usage notes** You do not need a valid login on the local device in order to run this command. The session will take you to the enable prompt on the new device. If the remote login session exits for any reason (e.g. device reboot) you will be returned to the originating node.

You can create additional user accounts on nodes. AMF's goal is to provide a uniform management plane across the whole network, so we recommend you use the same user accounts on all the nodes in the network.

In reality, though, it is not essential to have the same accounts on all the nodes. Users can remote login from one node to a second node even if they are logged into the first node with a user account that does not exist on the second node (provided that `atmf restricted-login` is disabled and the user account on the first node has privilege level 15).

Moreover, it is possible to use a RADIUS or TACACS+ server to manage user authentication, so users can log into AMF nodes using user accounts that are present on the RADIUS or TACACS+ server, and not present in the local user databases of the AMF nodes.

The software will not allow you to run multiple remote login sessions. You must exit an existing session before starting a new one.

If you disconnect from the VTY session without first exiting from the AMF remote session, the device will keep the AMF remote session open until the `exec-timeout` time expires (10 minutes by default). If the `exec-timeout` time is set to infinity (`exec-timeout 0 0`), then the device is unable to ever close the remote session. To avoid this, we recommend you use the `exit` command to close AMF remote sessions, instead of closing the associated VTY sessions. We also recommend you avoid setting the `exec-timeout` to infinity.

**Example** To remotely login from node Node10 to Node20, use the following command:

```
Node10# atmf remote-login node20
Node20>
```

To close the session on Node20 and return to Node10's command line, use the following command:

```
Node20# exit  
Node10#
```

In this example, user User1 is a valid user of node5. They can remotely login from node5 to node3 by using the following commands:

```
node5# atmf remote-login user User1 node3  
node3> enable
```

**Related commands** [atmf restricted-login](#)

**Command changes** Version 5.4.6-2.1: changes to AMF user account requirements

# atmf restricted-login

**Overview** By default, users who are logged into any node on an AMF network are able to manage any other node by using either working-sets or an AMF remote login. If the access provided by this feature is too wide, or contravenes network security restrictions, it can be limited by running this command, which changes the access so that:

- users who are logged into non-master nodes cannot execute any commands that involve working-sets, and
- from non-master nodes, users can use remote-login, but only to login to a user account that is valid on the remote device (via a statically configured account or RADIUS/TACACS+). Users are also required to enter the password for that user account.

Once entered on any AMF master node, this command will propagate across the network.

Use the **no** variant of this command to disable restricted login on the AMF network. This allows access to the **atmf working-set** command from any node in the AMF network.

**Syntax** `atmf restricted-login`  
`no atmf restricted-login`

**Mode** Privileged Exec

**Default** Master nodes operate with **atmf restricted-login** disabled.  
Member nodes operate with **atmf restricted-login** enabled.

**NOTE:** *The default conditions of this command vary from those applied by its “no” variant. This is because the restricted-login action is only applied by **master** nodes, and in the absence of a master node, the default is to apply the restricted action to all **member** nodes with AMF configured.*

**Usage notes** In the presence of a **master** node, its default of **atmf restricted-login disabled** will propagate to all its member nodes. Similarly, any change in this command’s status that is made on a master node, will also propagate to all its member nodes

Note that once you have run this command, certain other commands that utilize the AMF working-set command, such as the **include**, **atmf reboot-rolling** and **show atmf group members** commands, will operate only on master nodes.

Restricted-login must be enabled on AMF areas with more than 120 nodes.

**Example** To enable restricted login, use the command

```
Node_20(config)# atmf restricted-login node20
```

**Related commands** [atmf remote-login](#)  
[show atmf](#)

**Command changes** Version 5.4.6-2.1: changes to AMF user account requirements

# atmf secure-mode

**Overview** Use this command to enable AMF secure mode on an AMF node. AMF secure mode makes an AMF network more secure by:

- Adding an authorization mechanism before and AMF member is allowed to join an AMF network.
- The encryption of all AMF packets sent between AMF nodes.
- Adding support for user login authentication by RADIUS or TACACS+, and removing the requirement to have the same privileged user account in the local user database on all devices in the AMF network.
- Adding additional logging which enables network administrators to monitor attempts to gain unauthorized access to the AMF network.

Once the secure mode command is run on all nodes on an AMF network, the AMF masters and AMF controllers manage the addition of AMF nodes and AMF areas to the AMF network.

Use the **no** variant of this command to disable AMF secure mode on an AMF node.

**Syntax** `atmf secure-mode`  
`no atmf secure-mode`

**Default** Secure mode is disabled by default.

**Mode** Global Configuration

**Usage notes** When an AMF network is running in AMF secure mode the [atmf restricted-login](#) feature is automatically enabled. This restricts the [atmf working-set](#) command to users that are logged on to an AMF master. This feature cannot be disabled independently of secure mode.

When AMF secure mode is enabled the AMF controllers and masters in the AMF network form a group of certificate authorities. A node may only join a secure AMF network once it has been authorized by a master or controller. When enabled, all devices in the AMF network must be running in secure mode. Unsecured devices will not be able to join a secure AMF network.

**Example** To enable AMF secure mode on an AMF node, use the commands:

```
awplus# configure terminal
awplus(config)# atmf secure-mode
```

To disable AMF secure mode on an AMF node, use the commands:

```
awplus# configure terminal
awplus(config)# no atmf secure-mode
```

**Related commands** [atmf authorize](#)  
[atmf secure-mode certificate expiry](#)

clear atmf secure-mode certificates  
clear atmf secure-mode statistics  
show atmf  
show atmf authorization  
show atmf secure-mode  
show atmf secure-mode certificates  
show atmf secure-mode sa  
show atmf secure-mode statistics

**Command changes** Version 5.4.7-0.3: command added

# atmf secure-mode certificate expire

**Overview** Use this command on an AMF master to expire a secure mode certificate. Running this command will force the removal of the AMF node from the network.

**Syntax** `atmf secure-mode certificate expire <node-name> [area <area-name>]`

Parameter	Description
<code>&lt;node-name&gt;</code>	Name of the AMF node you want to expire the certificate for.
<code>area</code>	Specify an AMF area.
<code>&lt;area-name&gt;</code>	Name of the AMF area you want to expire the AMF nodes certificate for.

**Mode** Privileged Exec

**Example** To remove an AMF node named "node3" from an AMF network, use the following command on the AMF master:

```
awplus# atmf secure-mode certificate expire node3
```

To remove an AMF node named "node2" in an area named "area2", use the following command on the AMF master:

```
awplus# atmf secure-mode certificate expire node2 area area2
```

**Related commands**

- [atmf secure-mode](#)
- [show atmf secure-mode](#)
- [show atmf secure-mode certificates](#)

**Command changes** Version 5.4.7-0.3: command added

# atmf secure-mode certificate expiry

**Overview** Use this command to set the expiry time of AMF secure mode certificates. Once an AMF node's certificate expires it must re-authorize and obtain a new certificate from the AMF master.

Use the **no** variant of this command to reset the expiry time to 180 days.

**Syntax** `atmf secure-mode certificate expiry {<days>|infinite}`  
`no atmf secure-mode certificate expiry`

Parameter	Description
<code>&lt;days&gt;</code>	Length of time, in days, that an AMF secure mode certificate remains valid. A value between 1 and 365.
<code>infinite</code>	The authorization certificate does not expire, in other words AMF nodes stay authorized indefinitely.

**Default** The default expiry time is 180 days.

**Mode** Global Configuration

**Example** To set AMF secure mode certificate expiry to 7 days, use the commands:

```
awplus# configure terminal  
awplus(config)# atmf secure-mode certificate expiry 7
```

To set AMF secure mode certificates to never expire, use the commands:

```
awplus# configure terminal  
awplus(config)# atmf secure-mode certificate expiry infinite
```

To reset the certificate expiry to 180 days, use the commands:

```
awplus# configure terminal  
awplus(config)# no atmf secure-mode certificate expiry
```

**Related commands** [atmf secure-mode](#)  
[show atmf secure-mode](#)  
[show atmf secure-mode certificates](#)

**Command changes** Version 5.4.7-0.3: command added



# atmf secure-mode certificate renew

**Overview** Use this command to force all local certificates to expire and be renewed on an AMF secure mode network.

Secure mode certificates renew automatically but this command could be used to renew a certificate in a situation where the automatic renewal may happen while the device is not attached to the AMF network.

**Syntax** `atmf secure-mode certificate renew`

**Mode** Privileged Exec

**Example** To renew a local certificate on a AMF member or AMF master, use the command:

```
awplus# atmf secure-mode certificate renew
```

**Related commands** [show atmf secure-mode certificates](#)  
[show atmf secure-mode statistics](#)

**Command changes** Version 5.4.7-0.3: command added

# atmf secure-mode enable-all

**Overview** Use this command to enable AMF secure mode on an entire network. AMF secure mode makes an AMF network more secure by:

- Adding an authorization mechanism before an AMF member is allowed to join an AMF network.
- The encryption of all AMF packets sent between AMF nodes.
- Adding support for user login authentication by RADIUS or TACACS+, and removing the requirement to have the same privileged user account in the local user database on all devices in the AMF network.
- Adding additional logging which enables network administrators to monitor attempts to gain unauthorized access to the AMF network.

Once this command is run on an AMF network, the AMF masters and AMF controllers manage the addition of AMF nodes and AMF areas to the AMF network.

This command can only be run on an AMF master.

Use the **no** variant of this command to disable AMF secure mode on an entire network.

**Syntax** `atmf secure-mode enable-all`  
`no atmf secure-mode enable-all`

**Default** Secure mode is disabled by default.

**Mode** Privileged Exec

**Usage notes** When an AMF network is running in AMF secure mode the [atmf restricted-login](#) feature is automatically enabled. This restricts the [atmf working-set](#) command to users that are logged on to an AMF master. This feature cannot be disabled independently of secure mode.

When AMF secure mode is enabled the AMF controllers and masters in the AMF network form a group of certificate authorities. A node may only join a secure AMF network once it has been authorized by a master or controller. When enabled, all devices in the AMF network must be running in secure mode. Unsecured devices will not be able to join a secure AMF network.

Running **atmf secure-mode enable-all**:

- Groups all AMF members in a working set.
- Executes [clear atmf secure-mode certificates](#) on the working set of members, which removes existing secure mode certificates from all the nodes.
- Groups all the AMF masters in a working set.
- Executes [atmf authorize provision all](#) on the working set of masters, so all masters provision all nodes.
- Groups all AMF nodes in a working set.

- Runs a script which executes `atmf secure-mode` and then writes the configuration file on each node.
- Starts a timer that ticks every 10 seconds, for a maximum of 10 times, and checks if all the secure mode capable nodes rejoin the AMF network.

Running **no atmf secure-mode enable-all**:

- Groups all AMF nodes in a working set.
- Runs a script which executes **no atmf secure-mode** and then writes the configuration file on each node.
- Starts a timer that ticks every 10 seconds, for a maximum of 10 times, and checks if all the secure mode capable nodes rejoin the AMF network.

**NOTE:** Enabling or disabling secure mode on the network saves the running-config on every device.

**Example** To enable AMF secure mode on the entire network, use the command:

```
awplus# atmf secure-mode enable-all
```

You will be prompted to confirm the action:

```
Total number of nodes 21
21 nodes support secure-mode

Enable secure-mode across the AMF network ? (y/n): y
```

To disable AMF secure mode on the entire network, use the command:

```
awplus# no atmf secure-mode enable-all
```

You will be prompted to confirm the action:

```
% Warning: All security certificates will be deleted.
Disable secure-mode across the AMF network ? (y/n): y
```

**Related commands** [aaa authentication auth-web](#)  
[show atmf](#)

**Command changes** Version 5.4.7-0.3: command added

# atmf select-area

**Overview** Use this command to access devices in an area outside the core area on the controller network. This command will connect you to the remote area-master of the specified area.

This command is only valid on AMF controllers.

The **no** variant of this command disconnects you from the remote area-master.

**Syntax** `atmf select-area {<area-name>|local}`  
`no atmf select-area`

Parameter	Description
<code>&lt;area-name&gt;</code>	Connect to the remote area-master of the area with this name.
<code>local</code>	Return to managing the local controller area.

**Mode** Privileged Exec

**Usage notes** After running this command, use the [atmf working-set](#) command to select the set of nodes you want to access in the remote area.

**Example** To access nodes in the area Canterbury, use the command

```
controller-1# atmf select-area Canterbury
```

This displays the following output:

```
Test_network[3]#atmf select-area Canterbury
=====
Connected to area Canterbury via host Avensis:
=====
```

To return to the local area for controller-1, use the command

```
controller-1# atmf select-area local
```

Alternatively, to return to the local area for controller-1, use the command

```
controller-1# no atmf select-area
```

**Related commands** [atmf working-set](#)

# atmf topology-gui enable

**Overview** Use this command to enable the operation of Vista Manager EX on the Master device.

Vista Manager EX delivers state-of-the-art monitoring and management for your Autonomous Management Framework™ (AMF) network, by automatically creating a complete topology map of switches, firewalls and wireless access points (APs). An expanded view includes third-party devices such as security cameras.

Use the **no** variant of this command to disable operation of Vista Manager EX.

**Syntax** atmf topology-gui enable  
no atmf topology-gui enable

**Default** Disabled by default on AMF Master and member nodes. Enabled by default on Controllers.

**Mode** Global Configuration mode

**Usage notes** To use Vista Manager EX, you must also enable the HTTP service on all AMF nodes, including all AMF masters and controllers. The HTTP service is enabled by default on AlliedWare Plus switches and disabled by default on AR-Series firewalls. To enable it, use the commands:

```
Node1# configure terminal
Node1(config)# service http
```

On one master in each AMF area in your network, you also need to configure the master to send event notifications to Vista Manager EX. To do this, use the commands:

```
Node1# configure terminal
Node1(config)# log event-host <ip-address> atmf-topology-event
```

**Example** To enable Vista Manager EX on Node1, use the following commands:

```
Node1# configure terminal
Node1(config)# atmf topology-gui enable
```

To disable Vista Manager EX on Node1, use the following commands:

```
Node1# configure terminal
Node1(config)# no atmf topology-gui enable
```

**Related commands** [atmf enable](#)  
[gui-timeout](#)  
[log event-host](#)  
[service http](#)

# atmf trustpoint

**Overview** Use this command to set a PKI trustpoint for an AMF network. This command needs to be run on an AMF master or controller.

The self-signed certificate authority (CA) certificate is distributed to every node on the AMF network. It is used to verify client certificates signed by the trustpoint.

Use the **no** variant of this command to remove an AMF trustpoint.

**Syntax** `atmf trustpoint <trustpoint-name>`  
`no atmf trustpoint <trustpoint-name>`

Parameter	Description
<code>&lt;trustpoint-name&gt;</code>	Name of the trustpoint.

**Default** No trustpoint is configured by default.

**Mode** Global Configuration

**Usage notes** Before using the **atmf trustpoint** command you will need to establish a trustpoint. For example, you can create a local self-signed trustpoint using the procedure outlined below.

Create a self-signed trustpoint called 'our\_trustpoint' with keypair 'our\_key':

```
awplus# configure terminal
awplus(config)# crypto pki trustpoint our_trustpoint
awplus(ca-trustpoint)# enrollment selfsigned
awplus(ca-trustpoint)# rsakeypair our_key
awplus(ca-trustpoint)# exit
awplus(config)# exit
```

Create the root and server certificates for this trustpoint:

```
awplus# crypto pki authenticate our_trustpoint
awplus# crypto pki enroll our_trustpoint
```

For more information about the AlliedWare Plus implementation of Public Key Infrastructure (PKI), see the [Public Key Infrastructure \(PKI\) Feature Overview and Configuration Guide](#)

**Example** To configure an AMF trustpoint for the trustpoint 'our\_trustpoint', use the commands:

```
awplus# configure terminal
awplus(config)# atmf trustpoint our_trustpoint
```

To remove an AMF trustpoint for the trustpoint 'our\_trustpoint', use the commands:

```
awplus# configure terminal
awplus(config)# no atmf trustpoint our_trustpoint
```

**Related commands** [crypto pki trustpoint](#)  
[show atmf](#)

**Command changes** Version 5.4.7-2.1: command added

# atmf virtual-crosslink

**Overview** Use this command to create a virtual crosslink. A virtual crosslink connects an AMF master or controller on a physical device to a Virtual AMF Appliance (VAA) master or controller.

All AMF master nodes must reside in the same AMF domain and are required to be directly connected using AMF crosslinks. In order to be able to meet this requirement for AMF masters running on VAAs, a virtual crosslink connects the AMF master or controller on the physical device to the master or controller on the VAA.

Use the **no** variant of this command to remove a virtual crosslink.

**Syntax** `atmf virtual-crosslink id <local-id> ip <local-ip> remote-id <remote-id> remote-ip <remote-ip>`  
`no atmf virtual-crosslink id <local-id>`

Parameter	Description
<local-id>	ID of the local tunnel port, a value between 1 and 4094.
<local-ip>	IPv4 address of the local tunnel port in a.b.c.d format.
<remote-id>	ID of the remote tunnel port, a value between 1 and 4094.
<remote-ip>	IPv4 address of the remote tunnel port in a.b.c.d format.

**Default** No AMF virtual crosslinks are created by default.

**Mode** Global Configuration

**Usage notes** This command allows a virtual tunnel to be created between two remote sites over a layer 3 link. The tunnel encapsulates AMF packets and allows them to be sent transparently across a Wide Area Network (WAN) such as the Internet.

Configuration involves creating a local tunnel ID, a local IP address, a remote tunnel ID and a remote IP address. Each side of the tunnel must be configured with the same, but mirrored parameters.

**NOTE:** *Virtual crosslinks are not supported on AMF container masters, therefore if multiple tenants on a single VAA host are configured for secure mode, only a single AMF master is supported per area.*

**Example** To setup a virtual link from a local site, "siteA", to a remote site, "siteB", (assuming there is already IP connectivity between the sites), run the following commands at the local site:

```
siteA# configure terminal
siteA(config)# atmf virtual-crosslink id 5 ip 192.168.100.1
remote-id 10 remote-ip 192.168.200.1
```



At the remote site, run the commands:

```
siteB# configure terminal
siteB(config)# atmf virtual-crosslink id 10 ip 192.168.200.1
remote-id 5 remote-ip 192.168.100.1
```

To remove this virtual crosslink, run the following commands on the local site:

```
siteA# configure terminal
siteA(config)# no atmf virtual-crosslink id 5
```

On the remote site, run the commands:

```
siteB# configure terminal
siteB(config)# no atmf virtual-crosslink id 10
```

**Related  
commands**

[atmf virtual-crosslink](#)  
[show atmf links](#)  
[switchport atmf-crosslink](#)

**Command  
changes**

Version 5.4.7-0.3: command added

# atmf virtual-link

**Overview** This command creates one or more Layer 2 tunnels that enable AMF nodes to transparently communicate across a wide area network using Layer 2 connectivity protocols.

Once connected through the tunnel, the remote member will have the same AMF capabilities as a directly connected AMF member.

Use the **no** variant of this command to remove the specified virtual link.

**Syntax**

```
atmf virtual-link id <1-4094> ip <a.b.c.d> remote-id <1-4094>  
remote-ip <a.b.c.d> [remote-area <area-name>]  
  
atmf virtual-link id <1-4094> interface <interface-name>  
remote-id <1-4094> remote-ip <a.b.c.d> [remote-area  
<area-name>]  
  
no atmf virtual-link id <1-4094>
```

Parameter	Description
id <1-4094>	ID of the local tunnel point, in the range 1 to 4094.
ip <a.b.c.d>	Specify the local IP address of the local interface for the virtual-link (alternatively you can specify the interface's name, see below).
interface <interface-name>	Specify the local interface name for the virtual-link. This allows you to use a dynamic, rather than a static, local IP address.
remote-id<1-4094>	The ID of the (same) tunnel that will be applied by the remote node. Note that this must match the local-id that is defined on the remote node. This means that (for the same tunnel) the local and remote tunnel IDs are reversed on the local and remote nodes.
remote-ip <a.b.c.d>	The IP address of the remote node.
remote-area <area-name>	The name of the remote area connected to this virtual-link

**Mode** Global Configuration

**Usage notes** The Layer 2 tunnel that this command creates enables a local AMF session to appear to pass transparently across a Wide Area Network (WAN) such as the Internet. The addresses configured as the local and remote tunnel IP addresses must have IP connectivity to each other. If the tunnel is configured to connect a head office and branch office over the Internet, typically this would involve using some type of managed WAN service such as a site-to-site VPN. Tunnels are only supported using IPv4.

Configuration involves creating a local tunnel ID, a local IP address, a remote tunnel ID and a remote IP address. A reciprocal configuration is also required on the corresponding remote device. The local tunnel ID must be unique to the device on which it is configured.

If an interface acquires its IP address dynamically then the local side of the tunnel can be specified by using the interface's name instead of using its IP address. When using a dynamic local address the remote address of the other side of the virtual-link must be configured with either:

- the IP address of the NAT device the dynamically configured interface is behind, or
- 0.0.0.0, if the virtual-link is configured as a secure virtual-link.

For instructions on how to configure dynamic IP addresses on virtual-links, see the [AMF Feature Overview and Configuration Guide](#).

The tunneled link may operate via external (non AlliedWare Plus) routers in order to provide wide area network connectivity. However in this configuration, the routers perform a conventional router to router connection. The protocol tunneling function is accomplished by the AMF nodes.

**NOTE:** AMF cannot achieve zero touch replacement of the remote device that terminates the tunnel connection, because you must pre-configure the local IP address and tunnel ID on that remote device.

**Example 1** Use the following commands to create the tunnel shown in the figure below.

Figure 39-1: AMF virtual link example

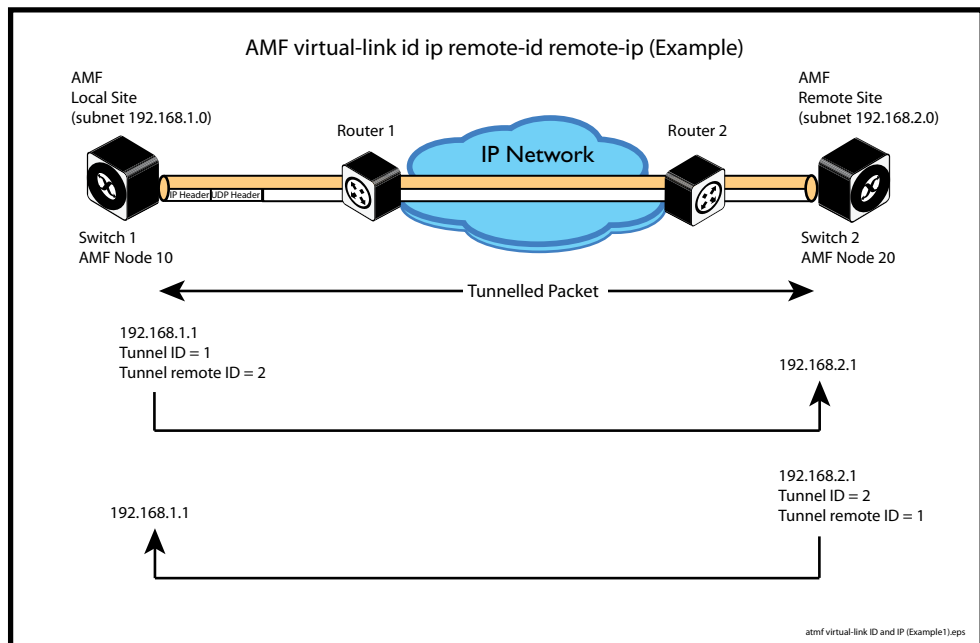

```
Node_10(config)# atmf virtual-link id 1 ip 192.168.1.1  
remote-id 2 remote-ip 192.168.2.1
```

```
Node_20(config)# atmf virtual-link id 2 ip 192.168.2.1  
remote-id 1 remote-ip 192.168.1.1
```

**Example 2** To set up an area virtual link to a remote site (assuming IP connectivity between the sites already), one site must run the following commands:

```
SiteA# configure terminal
SiteA(config)# atmf virtual-link id 5 ip 192.168.100.1
remote-id 10 remote-ip 192.168.200.1 remote-area SiteB-AREA
```

The second site must run the following commands:

```
SiteB# configure terminal
SiteB(config)# atmf virtual-link id 10 ip 192.168.200.1
remote-id 5 remote-ip 192.168.100.1 remote-area SiteA-AREA
```

Before you can apply the above **atmf virtual-link** command, you must configure the area names *SiteB-AREA* and *SiteA-AREA*.

**Related commands**

- [atmf virtual-link protection](#)
- [show atmf](#)
- [show atmf links](#)
- [show atmf virtual-links](#)

**Command changes** Version 5.4.9-0.1: **interface** parameter added

# atmf virtual-link protection

**Overview** Use this command to add protection to an existing AMF virtual-link. Secure AMF virtual-links encapsulate the L2TPv3 frames of the virtual-link with IPsec.

Use the **no** variant of this command to remove protection from an AMF virtual-link.

**Syntax** `atmf virtual-link id <1-4094> protection ipsec key [8]  
<key-string>`  
`no atmf virtual-link id <1-4094> protection`

Parameter	Description
id	Specify the link ID.
<1-4094>	Link ID in the range 1 to 4094,
protection	Protection is on for this link.
ipsec	Security provided using IPsec.
key	Set the shared key.
8	Specifies a string in an encrypted format instead of plain text. The running config will display the new password as an encrypted string even if password encryption is turned off.
<key-string>	Specify the shared key for the link.

**Default** Protection is off by default.

**Mode** Global Configuration

**Usage notes** The following limitations need to be considered when creating secure virtual-links.

- Switch devices support a maximum of 20 downstream AMF nodes when using a secure virtual-link as an uplink.
- When there are two or more AMF members behind a shared NAT device, only one of the members will be able to use secure virtual-links.
- An AMF Multi-tenant environment supports a maximum cumulative total of 1200 secure virtual-links across all AMF containers.

Secure virtual-links are only supported on the following device listed in the table below. There is also a limit to the number of links these devices support.

Device	Virtual-link Limit
AMF Cloud/ VAA	300
AR4050S AR3050S AR2050V AR2010V	60
x220 x230/x230L x310 x510/x510L IX5-28GPX	2

**Example** To create and configure a virtual link with protection first create the virtual-link:

```
Host-A# configure terminal
```

```
Host-A(config)# atmf virtual-link id 1 ip 192.168.1.1 remote-id  
2 remote-ip 192.168.2.1
```

Enable protection on the virtual link:

```
Host-A(config)# atmf virtual-link id 1 protection ipsec key  
securepassword
```

Repeat these steps on the other side of the link:

```
Host-B(config)# atmf virtual-link id 2 ip 192.168.2.1 remote-id  
1 remote-ip 192.168.1.1
```

```
Host-B(config)# atmf virtual-link id 2 protection ipsec key  
securepassword
```

**Related  
commands** [atmf virtual-link](#)  
[show atmf](#)

[show atmf links](#)

[show atmf virtual-links](#)

**Command  
changes** Version 5.4.9-0.1: command added

# atmf working-set

**Overview** Use this command to execute commands across an individually listed set of AMF nodes or across a named group of nodes.

Note that this command can only be run on a master node.

Use the **no** variant of this command to remove members or groups from the current working-set.

**Syntax** `atmf working-set { [<node-list> ] | [group <group-list> | all | local | current] }`  
`no atmf working-set { [<node-list> ] | [group <group-list> ] }`

Parameter	Description
<code>&lt;node-list&gt;</code>	A comma delimited list (without spaces) of nodes to be included in the working-set.
<code>group</code>	The AMF group.
<code>&lt;group-list&gt;</code>	A comma delimited list (without spaces) of groups to be included in the working-set. Note that this can include either defined groups, or any of the Automatic, or Implicit Groups shown earlier in the bulleted list of groups.
<code>all</code>	All nodes in the AMF.
<code>local</code>	Local node Running this command with the parameters <b>group local</b> will return you to the local prompt and local node connectivity.
<code>current</code>	Nodes in current list.

**Mode** Privileged Exec

**Usage notes** You can put AMF nodes into groups by using the [atmf group \(membership\)](#) command.

This command opens a session on multiple network devices. When you change the working set to anything other than the local device, the prompt will change to the AMF network name, followed by the size of the working set, shown in square brackets. This command has to be run at privilege level 15.

In addition to the user defined groups, the following system assigned groups are automatically created:

- Implicit Groups
  - local: The originating node.
  - current: All nodes that comprise the current working-set.
  - all: All nodes in the AMF.

- Automatic Groups - These can be defined by hardware architecture, e.g. x510, x610, x8100, AR3050S or AR4050S, or by certain AMF nodal designations such as master.

Note that the Implicit Groups do not appear in `show atmf group` command output. If a node is an AMF master it will be automatically added to the master group.

**Example 1** To add all nodes in the AMF to the working-set, use the command:

```
node1# atmf working-set group all
```

**NOTE:** This command adds the implicit group "all" to the working set, where "all" comprises all nodes in the AMF.

This command displays an output screen similar to the one shown below:

```
=====
node1, node2, node3, node4, node5, node6:
=====

Working set join

ATMF_NETWORK_Name[6]#
```

**Example 2** To return to the local prompt, and connect to only the local node, use the command:

```
ATMF_Network_Name[6]# atmf working-set group local
node1#
```

The following table describes the meaning of the prompts in this example.

Parameter	Description
ATMF_Network_Name	The name of the AMF network, as set by the <code>atmf network-name</code> command.
[ 6 ]	The number of nodes in the working-set.
node1	The name of the local node, as set by the <code>hostname</code> command.



# bridge-group

**Overview** Use this command to connect an AMF container to a bridge created on a Virtual AMF Appliance (VAA) virtual machine. This allows the AMF container to connect to a physical network.

An AMF container is an isolated instance of AlliedWare Plus with its own network interfaces, configuration, and file system. The features available inside an AMF container are a sub-set of the features available on the host VAA. These features enable the AMF container to function as a uniquely identifiable AMF master and allows for multiple tenants (up to 60) to run on a single VAA host. See the [AMF Feature Overview and Configuration Guide](#) for more information on running multiple tenants on a single VAA host.

Use the **no** variant of this command to remove a bridge-group from an AMF container.

**Syntax** `bridge-group <bridge-id>`  
`no bridge-group`

Parameter	Description
<code>&lt;bridge-id&gt;</code>	The ID of the bridge group to join, a number between 1 and 64.

**Mode** AMF Container Configuration

**Usage notes** Each container has two virtual interfaces:

- 1) Interface eth0, used to connect to the AMF controller on the VAA host via an AMF area-link, and configured using this [area-link](#) command.
- 2) Interface eth1, used to connect to the outside world using a bridged L2 network link, and configured using the **bridge-group** command.

Before using this command, a bridge must be created with the same bridge-id on the VAA host using the **bridge <bridge-id>** command.

See the [AMF Feature Overview and Configuration Guide](#) for more information on configuring the bridge.

**Example** To create a bridge group for AMF container "vac-wlg-1" and , use the commands:

```
awplus# configure terminal
awplus(config)# atmf container vac-wlg-1
awplus(config-atmf-container)# bridge-group 1
```

**Related commands** [atmf container](#)  
[show atmf container](#)

**Command changes** Version 5.4.7-0.1: command added

# clear application-proxy threat-protection

**Overview** Use this command to clear the threat protection for a specified address.

**Syntax** clear application-proxy threat-protection {<ip-address>|<mac-address>|all}

Parameter	Description
<ip-address>	The IPv4 address you wish to clear the threat for, in A.B.C.D format.
<mac-address>	The MAC address you wish to clear the threat for, in HHHH.HHHH.HHHH format.
all	Clear the threat for all IPv4 and MAC addresses.

**Mode** Privileged Exec

**Example** To clear the threat for 10.34.199.117, use the command:

```
awplus# clear application-proxy threat-protection 10.34.199.117
```

**Related commands**

- [application-proxy quarantine-vlan](#)
- [application-proxy threat-protection](#)
- [application-proxy threat-protection send-summary](#)
- [service atmf-application-proxy](#)
- [show application-proxy threat-protection](#)

**Command changes** Version 5.4.7-2.2: command added

# clear atmf links

**Overview** Use this command with no parameters to manually reset all the AMF links on a device. You can optionally specify an interface or range of interfaces to reset the links on.

Certain events or topology changes can cause AMF links to be incorrect or outdated. Clearing the links forces AMF to relearn the information from neighboring nodes and create a fresh, correct, view of the network.

**Syntax** `clear atmf links [<interface-list>]`

Parameter	Description
<code>&lt;interface-list&gt;</code>	<p>The interfaces or ports to perform the reset on. An interface-list can be:</p> <ul style="list-style-type: none"><li>• a switchport (e.g. port1.0.1)</li><li>• a static channel group (e.g. sa2)</li><li>• a dynamic (LACP) channel group (e.g. po2)</li><li>• a local port (e.g. of0)</li><li>• You can specify a continuous range of interfaces separated by a hyphen, or a comma-separated list (e.g. port1.0.1, port1.0.4-port1.0.18).</li></ul> <p>The specified interfaces must exist. If this parameter is left out then all links of the specified type will be reset on the device.</p>

**Mode** Privileged Exec

**Example** To clear all AMF links on a device, use the following command:

```
awplus# clear atmf links
```

To clear all AMF links on port1.0.1 to port1.0.4 and static aggregator sa1, use the following command:

```
awplus# clear atmf links port1.0.1-port1.0.4,sa1
```

**Related commands** [clear atmf links virtual](#)  
[show atmf links](#)

**Command changes** Version 5.4.8-2.1: command added

# clear atmf links virtual

**Overview** Use this command with no parameters to manually reset all the AMF virtual links on a device. You can, optionally, specify a comma separated list of virtual links to reset.

Certain events or topology changes can cause AMF links to be incorrect or outdated. Clearing the links forces AMF to relearn the information from neighboring nodes and create a fresh, correct view of the network.

**Syntax** `clear atmf links virtual [<virtuallink-list>]`

Parameter	Description
<code>&lt;virtuallink-list&gt;</code>	A single, or list, of AMF virtual link identifiers to reset. This must be a comma separated list of links e.g. <code>vlink1, vlink2, vlink3</code> . Specifying a link range e.g. <code>vlink1-vlink3</code> is not supported.

**Mode** Privileged Exec

**Example** To clear all AMF virtual links on a device, use the following command:

```
awplus# clear atmf links virtual
```

To clear AMF virtual links vlink11 and vlink21, use the following command:

```
awplus# clear atmf links virtual vlink11,vlink22
```

**Related commands** [clear atmf links](#)  
[show atmf links](#)

**Command changes** Version 5.4.8-2.1: command added

# clear atmf links statistics

**Overview** This command resets the values of all AMF link, port, and global statistics to zero.

**Syntax** `clear atmf links statistics`

**Mode** Privilege Exec

**Example** To reset the AMF link statistics values, use the command:

```
node_1# clear atmf links statistics
```

**Related commands** [show atmf links statistics](#)

# clear atmf recovery-file

**Overview** Use this command to delete all of a node's recovery files. It deletes the recovery files stored on:

- the local node,
- neighbor nodes, and
- external media (USB or SD card).

**Syntax** `clear atmf recovery-file`

**Mode** Privileged Exec

**Usage notes** AMF recovery files are created for nodes with special links. Special links include:

- virtual links,
- area links terminating on an AMF master, and
- area virtual links terminating on an AMF master.

An AMF node with one of these special links pushes its startup configuration to its neighbors and to any attached external media. It then fetches and applies this configuration at recovery time. This configuration enables it to contact the AMF master and initiate a recovery.

Recovery files can become out of date if:

- a node's neighbor is off line when changes are made to its configuration, or
- when a node no longer contains a special link.

**Example** To clear a node's recovery files, use the command:

```
node1# clear atmf recovery-file
```

**Output** Figure 39-2: If AlliedWare Plus detects that a node contains a special link then the following message is displayed

```
node1#clear atmf recovery-file
% Warning: ATMF recovery files have been removed.
ATMF recovery may fail. Please save running-configuration.
```

**Related commands** [show atmf recovery-file](#)

**Command changes** Version 5.4.8-0.2: command added

# clear atmf secure-mode certificates

**Overview** Use this command to remove all certificates from an AMF member or master. AMF nodes will need to be re-authorized once this command has been run.

**Syntax** `clear atmf secure-mode certificates`

**Mode** Privileged Exec

**Example** To clear all certificates from an AMF node, use the command:

```
awplus# clear atmf secure-mode certificates
```

If this is the only master on the network you will see the following warning:

```
% Warning: This node is the only master in the network!  
All the nodes will become isolated and refuse to join any ATMF  
network. The certificates on all the isolated nodes must be  
cleared before rejoining an ATMF network will be possible.  
  
To clear certificates a reboot of the device is required.  
Clear certificates and Reboot ? (y/n):
```

On an AMF member you will see the following message:

```
To clear certificates a reboot of the device is required.  
Clear certificates and Reboot ? (y/n):
```

**Related commands**

- [atmf authorize](#)
- [atmf secure-mode](#)
- [show atmf authorization](#)
- [show atmf secure-mode certificates](#)

**Command changes** Version 5.4.7-0.3: command added

# clear atmf secure-mode statistics

**Overview** Use this command to reset all secure mode statistics to 0.

**Syntax** `clear atmf secure-mode statistics`

**Mode** Privileged Exec

**Example** To reset the AMF secure mode statistics information, use the command:

```
awplus# clear atmf secure-mode statistic
```

**Related commands** [show atmf secure-mode](#)  
[show atmf secure-mode statistics](#)

**Command changes** Version 5.4.7-0.3: command added



# clone (amf-provision)

**Overview** This command sets up a space on the backup media for use with a provisioned node and copies into it almost all files and directories from a chosen backup or provisioned node.

Alternatively, you can set up a new, unique provisioned node by using the command [create \(amf-provision\)](#).

**Syntax** `clone <source-nodename>`

Parameter	Description
<code>&lt;source-nodename&gt;</code>	The name of the node whose configuration is to be copied for loading to the clone.

**Mode** AMF Provisioning

**Usage notes** This command is only available on master nodes in the AMF network.

When using this command it is important to be aware of the following:

- A copy of `<media>:atmf/<atmf_name>/nodes/<source_node>/flash` will be made for the provisioned node and stored in the backup media.
- The directory `<node_backup_dir>/flash/.config/ssh` is excluded from the copy.
- All contents of `<root_backup_dir>/nodes/<nodename>` will be deleted or overwritten.
- Settings for the expected location of other provisioned nodes are excluded from the copy.

The active and backup configuration files are automatically modified in the following ways:

- The **hostname** command is modified to match the name of the provisioned node.
- The **stack virtual-chassis-id** command is removed, if present.

**Example** To copy from the backup of 'device2' to create backup files for the new provisioned node 'device3' use the following command:

```
device1# atmf provision node device3  
device1(atmf-provision)# clone device2
```

Figure 39-3: Sample output from the **clone** command

```
device1# atmf provision node device3  
device1(atmf-provision)#clone device2  
Copying...  
Successful operation
```

To confirm that a new provisioned node has been cloned, use the command:

```
device1# show atmf backup
```

The output from this command is shown in the following figure, and shows the details of the new provisioned node 'device3'.

Figure 39-4: Sample output from the **show atmf backup** command

```
device1#show atmf backup

Scheduled Backup ..... Enabled
  Schedule ..... 1 per day starting at 03:00
  Next Backup Time ... 01 Oct 2018 03:00
Backup Bandwidth ..... Unlimited
Backup Media ..... USB (Total 7446.0MB, Free 7297.0MB)
Server Config .....
  Synchronization .... Unsynchronized
  Last Run ..... -
  1 ..... Unconfigured
  2 ..... Unconfigured
Current Action ..... Idle
Started ..... -
Current Node ..... -

-----
Node Name      Date          Time          In ATMF  On Media  Status
-----
device3        -             -             No       Yes       Prov
device1        30 Sep 2018  00:05:49     No       Yes       Good
device2        30 Sep 2018  00:05:44     Yes      Yes       Good
```

**Related commands**

- atmf provision (interface)
- atmf provision node
- configure boot config (amf-provision)
- configure boot system (amf-provision)
- copy (amf-provision)
- create (amf-provision)
- delete (amf-provision)
- identity (amf-provision)
- license-cert (amf-provision)
- locate (amf-provision)
- show atmf provision nodes

**Command changes**

Version 5.4.9-0.1: syntax change due to new AMF provisioning mode

# configure boot config (amf-provision)

**Overview** This command sets the configuration file to use during the next boot cycle. This command can also set a backup configuration file to use if the main configuration file cannot be accessed for an AMF provisioned node. To unset the boot configuration or the backup boot configuration use the **no boot** command.

**Syntax** `configure boot config [backup] <file-path|URL>`  
`configure no boot config [backup]`

Parameter	Description
backup	Specify that this is the backup configuration file.
<file-path URL>	The path or URL and name of the configuration file.

**Default** No boot configuration files or backup configuration files are specified for the provisioned node.

**Mode** AMF Provisioning

**Usage notes** When using this command to set a backup configuration file, the specified AMF provisioned node must exist. The specified file must exist in the flash directory created for the provisioned node in the AMF remote backup media.

**Examples** To set the configuration file 'branch.cfg' on the AMF provisioned node 'node1', use the command:

```
MasterNodeName# atmf provision node node1
MasterNodeName(atmf-provision)# configure boot config
branch.cfg
```

To set the configuration file 'backup.cfg' as the backup to the main configuration file on the AMF provisioned node 'node1', use the command:

```
MasterNodeName(atmf-provision)# configure boot config backup
usb:/atmf/amf_net/nodes/node1/config/backup.cfg
```

To unset the boot configuration, use the command:

```
MasterNodeName(atmf-provision)# configure no boot config
```

To unset the backup boot configuration, use the command:

```
MasterNodeName(atmf-provision)# configure no boot config backup
```

**Related commands**

- [atmf provision \(interface\)](#)
- [atmf provision node](#)
- [clone \(amf-provision\)](#)
- [configure boot system \(amf-provision\)](#)
- [create \(amf-provision\)](#)

delete (amf-provision)  
identity (amf-provision)  
license-cert (amf-provision)  
locate (amf-provision)  
show atmf provision nodes

**Command  
changes**

Version 5.4.9-0.1: syntax change due to new AMF provisioning mode

# configure boot system (amf-provision)

**Overview** This command sets the release file that will load onto a specified provisioned node during the next boot cycle. This command can also set the backup release file to be loaded for an AMF provisioned node. To unset the boot system release file or the backup boot release file use the **no boot** command.

Use the **no** variant of this command to return to the default.

This command can only be run on AMF master nodes.

**Syntax** `configure boot system [backup] <file-path|URL>`  
`configure no boot system [backup]`

Parameter	Description
<code>&lt;file-path URL&gt;</code>	The path or URL and name of the release file.

**Default** No boot release file or backup release files are specified for the provisioned node.

**Mode** AMF Provisioning

**Usage notes** When using this command to set a backup release file, the specified AMF provisioned node must exist. The specified file must exist in the flash directory created for the provisioned node in the AMF remote backup media.

**Examples** To set the release file x930-5.4.9-0.1.rel on the AMF provisioned node 'node1', use the command:

```
MasterNodeName# atmf provision node node1
MasterNodeName(atmf-provision)# configure boot system
x930-5.4.9-0.1.rel
```

To set the backup release file x930-5.4.8-2.5.rel as the backup to the main release file on the AMF provisioned node 'node1', use the command:

```
MasterNodeName# atmf provision node node1
MasterNodeName(atmf-provision)# configure boot system backup
card:/atmf/amf_net/nodes/node1/flash/x930-5.4.8-2.5.rel
```

To unset the boot release, use the command:

```
MasterNodeName# atmf provision node node1
MasterNodeName(atmf-provision)# configure no boot system
```

To unset the backup boot release, use the command:

```
MasterNodeName# atmf provision node node1
MasterNodeName(atmf-provision)# configure no boot system backup
```

**Related commands** [atmf provision \(interface\)](#)

atmf provision node  
clone (amf-provision)  
configure boot config (amf-provision)  
create (amf-provision)  
delete (amf-provision)  
identity (amf-provision)  
license-cert (amf-provision)  
locate (amf-provision)  
show atmf provision nodes

**Command changes** Version 5.4.9-0.1: syntax change due to new AMF provisioning mode

# copy (amf-provision)

**Overview** Use this command to copy configuration and release files for the node you are provisioning.

For more information about using the copy command see [copy \(filename\)](#) in the File and Configuration Management chapter.

**Syntax** `copy [force] <source-name> <destination-name>`

Parameter	Description
<code>force</code>	This parameter forces the copy command to overwrite the destination file, if it already exists, without prompting the user for confirmation.
<code>&lt;source-name&gt;</code>	The filename and path of the source file. See the <a href="#">Introduction</a> of the File and Configuration Management chapter for valid syntax.
<code>&lt;destination-name&gt;</code>	The filename and path for the destination file. See <a href="#">Introduction</a> of the File and Configuration Management chapter for valid syntax.

**Mode** AMF Provisioning

**Example** To copy a configuration file named `current.cfg` from Node\_4's Flash into the `future_node` directory, and set that configuration file to load onto `future_node`, use the following commands:

```
node_4# atmf provision node future_node
node_4(atmf-provision)# create
node_4(atmf-provision)# locate
node_4(atmf-provision)# copy flash:current.cfg
./future_node.cfg
node_4(atmf-provision)# configure boot config future_node.cfg
```

**Related commands**

- [atmf provision \(interface\)](#)
- [atmf provision node](#)
- [clone \(amf-provision\)](#)
- [create \(amf-provision\)](#)
- [delete \(amf-provision\)](#)
- [locate \(amf-provision\)](#)
- [show atmf provision nodes](#)

**Command changes** Version 5.4.9-2.1: command added

# create (amf-provision)

**Overview** This command sets up an empty directory on the backup media for use with a provisioned node. This directory can have configuration and release files copied to it from existing devices. Alternatively, the configuration files can be created by the user.

An alternative way to create a new provisioned node is with the command [clone \(amf-provision\)](#).

This command can only run on AMF master nodes.

**Syntax** create

**Mode** AMF Provisioning

**Usage notes** This command is only available on master nodes in the AMF network.

A date and time is assigned to the new provisioning directory reflecting when this command was executed. If there is a backup or provisioned node with the same name on another AMF master then the most recent one will be used.

**Example** To create a new provisioned node named "device2" use the command:

```
device1# atmf provision node device2  
device1(atmf-provision)# create
```

Running this command will create the following directories:

- `<media>:atmf/<atmf_name>/nodes/<node>`
- `<media>:atmf/<atmf_name>/nodes/<node>/flash`

To confirm the new node's settings, use the command:

```
device1# show atmf backup
```

The output for the **show atmf backup** command is shown in the following figure, and shows details for the new provisioned node 'device2'.



Figure 39-5: Sample output from the **show atmf backup** command

```
device1#show atmf backup

Scheduled Backup ..... Enabled
  Schedule ..... 1 per day starting at 03:00
  Next Backup Time .... 01 Oct 2018 03:00
Backup Bandwidth ..... Unlimited
Backup Media ..... USB (Total 7446.0MB, Free 7315.2MB)
Server Config .....
  Synchronization ..... Unsynchronized
  Last Run ..... -
  1 ..... Unconfigured
  2 ..... Unconfigured
Current Action ..... Idle
  Started ..... -
  Current Node ..... -

-----
Node Name      Date           Time           In ATMF  On Media  Status
-----
device2        -              -              No       Yes       Prov
device1        30 Sep 2018   00:05:49      No       Yes       Good
```

For instructions on how to configure on a provisioned node, see the [AMF Feature Overview and Configuration Guide](#).

**Related commands**

- [atmf provision \(interface\)](#)
- [atmf provision node](#)
- [clone \(amf-provision\)](#)
- [copy \(amf-provision\)](#)
- [configure boot config \(amf-provision\)](#)
- [configure boot system \(amf-provision\)](#)
- [delete \(amf-provision\)](#)
- [identity \(amf-provision\)](#)
- [license-cert \(amf-provision\)](#)
- [locate \(amf-provision\)](#)
- [show atmf provision nodes](#)

**Command changes**

Version 5.4.9-0.1: syntax change due to new AMF provisioning mode

# debug atmf

**Overview** This command enables the AMF debugging facilities, and displays information that is relevant (only) to the current node. The detail of the debugging displayed depends on the parameters specified.

If no additional parameters are specified, then the command output will display all AMF debugging information, including link events, topology discovery messages and all notable AMF events.

The **no** variant of this command disables either all AMF debugging information, or only the particular information as selected by the command's parameters.

**Syntax**

```
debug atmf  
[link | crosslink | arealink | database | neighbor | error | all]  
  
no debug atmf  
[link | crosslink | arealink | database | neighbor | error | all]
```

Parameter	Description
link	Output displays debugging information relating to uplink or downlink information.
crosslink	Output displays all crosslink events.
arealink	Output displays all arealink events.
database	Output displays only notable database events.
neighbor	Output displays only notable AMF neighbor events.
error	Output displays AMF error events.
all	Output displays all AMF events.

**Default** All debugging facilities are disabled.

**Mode** User Exec and Global Configuration

**Usage notes** If no additional parameters are specified, then the command output will display all AMF debugging information, including link events, topology discovery messages and all notable AMF events.

**NOTE:** An alias to the **no** variant of this command is [undebg atmf](#) on page 1675.

**Examples** To enable all AMF debugging, use the command:

```
node_1# debug atmf
```

To enable AMF uplink and downlink debugging, use the command:

```
node_1# debug atmf link
```

To enable AMF error debugging, use the command:

```
node_1# debug atmf error
```

**Related** no debug all  
**commands**

# debug atmf packet

**Overview** This command configures AMF Packet debugging parameters. The debug only displays information relevant to the current node. The command has following parameters:

**Syntax** debug atmf packet [direction {rx|tx|both}] [level {1|2|3}]  
 [timeout <seconds>] [num-pkts <quantity>]  
 [filter {node <name>|interface <ifname>}]  
 [pkt-type [1][2][3][4][5][6][7][8][9][10][11][12][13]]

## Simplified Syntax

debug atmf packet	[direction {rx tx both}]
	[level {[1][2][3]}]
	[timeout <seconds>]
	[num-pkts <quantity>]
debug atmf packet filter	[node <name>]
	[interface <ifname>]
	[pkt-type [1][2][3][4][5][6][7][8][9][10][11][12][13]]

**NOTE:** You can combine the syntax components shown, but when doing so, you must retain their original order.

**Default** Level 1, both Tx and Rx, a timeout of 60 seconds with no filters applied.

**NOTE:** An alias to the **no** variant of this command - *undebbug atmf* - can be found elsewhere in this chapter.

**Mode** User Exec and Global Configuration

**Usage notes** If no additional parameters are specified, then the command output will apply a default selection of parameters shown below:

Parameter	Description
direction	Sets debug to packet received, transmitted, or both
rx	packets received by this node
tx	Packets sent from this node
1	AMF Packet Control header Information, Packet Sequence Number. Enter 1 to select this level.
2	AMF Detailed Packet Information. Enter 2 to select this level.
3	AMF Packet HEX dump. Enter 3 to select this level.
timeout	Sets the execution timeout for packet logging

Parameter	Description
<seconds>	Seconds
num-pkts	Sets the number of packets to be dumped
<quantity>	The actual number of packets
filter	Sets debug to filter packets
node	Sets the filter on packets for a particular Node
<name>	The name of the remote node
interface	Sets the filter to dump packets from an interface (portx.x.x) on the local node
<ifname>	Interface port or virtual-link
pkt-type	Sets the filter on packets with a particular AMF packet type
1	Crosslink Hello BPDU packet with crosslink links information. Enter 1 to select this packet type.
2	Crosslink Hello BPDU packet with downlink domain information. Enter 2 to select this packet type.
3	Crosslink Hello BPDU packet with uplink information. Enter 3 to select this packet type.
4	Downlink and uplink hello BPDU packets. Enter 4 to select this packet type.
5	Non broadcast hello unicast packets. Enter 5 to select this packet type.
6	Stack hello unicast packets. Enter 6 to select this packet type.
7	Database description. Enter 7 to select this packet type.
8	DBE request. Enter 8 to select this packet type.
9	DBE update. Enter 9 to select this packet type.
10	DBE bitmap update. Enter 10 to select this packet type.
11	DBE acknowledgment. Enter 11 to select this packet type.
12	Area Hello Packets. Enter 12 to select this packet type.
13	Gateway Hello Packets. Enter 13 to select this packet type.

**Examples** To set a packet debug on node 1 with level 1 and no timeout, use the command:

```
node_1# debug atmf packet direction tx timeout 0
```

To set a packet debug with level 3 and filter packets received from AMF node 1:

```
node_1# debug atmf packet direction tx level 3 filter node_1
```

To enable send and receive 500 packets only on vlink1 for packet types 1, 7, and 11, use the command:

```
node_1# debug atmf packet num-pkts 500 filter interface vlink1  
pkt-type 1 7 11
```

This example applies the **debug atmf packet** command and combines many of its options:

```
node_1# debug atmf packet direction rx level 1 num-pkts 60  
filter node x930 interface port1.0.1 pkt-type 4 7 10
```

# delete (amf-provision)

**Overview** This command deletes files that have been created for loading onto a provisioned node. It can only be run on master nodes.

**Syntax** delete

**Mode** AMF Provisioning

**Usage notes** This command is only available on master nodes in the AMF network. The command will only work if the provisioned node specified in the command has already been set up (although the device itself is still yet to be installed). Otherwise, an error message is shown when the command is run.

You may want to use the **delete** command to delete a provisioned node that was created in error or that is no longer needed.

This command cannot be used to delete backups created by the AMF backup procedure. In this case, use the command [atmf backup delete](#) to delete the files.

**NOTE:** *This command allows provisioned entries to be deleted even if they have been referenced by the [atmf provision \(interface\)](#) command, so take care to only delete unwanted entries.*

**Example** To delete backup files for a provisioned node named device3 use the command:

```
device1# atmf provision node device3  
device1(atmf-provision)# delete
```

To confirm that the backup files for provisioned node device3 have been deleted use the command:

```
device1# show atmf backup
```

The output should show that the provisioned node device3 no longer exists in the backup file, as shown in the figure below:

Figure 39-6: Sample output showing the **show atmf backup** command

```
device1#show atmf backup

Scheduled Backup ..... Enabled
  Schedule ..... 1 per day starting at 03:00
  Next Backup Time .... 01 Oct 2016 03:00
Backup Bandwidth ..... Unlimited
Backup Media ..... USB (Total 7446.0MB, Free 7297.0MB)
Server Config .....
  Synchronization ..... Unsynchronized
  Last Run ..... -
  1 ..... Unconfigured
  2 ..... Unconfigured
Current Action ..... Idle
  Started ..... -
  Current Node ..... -

-----
Node Name      Date           Time           In ATMF  On Media  Status
-----
device1        30 Sep 2016   00:05:49      No        Yes       Good
device2        30 Sep 2016   00:05:44      Yes       Yes       Good
```

**Related commands**

- atmf provision (interface)
- atmf provision node
- clone (amf-provision)
- configure boot config (amf-provision)
- configure boot system (amf-provision)
- create (amf-provision)
- identity (amf-provision)
- license-cert (amf-provision)
- locate (amf-provision)
- show atmf provision nodes

**Command changes**

Version 5.4.9-0.1: syntax change due to new AMF provisioning mode



# discovery

**Overview** Use this command to specify how AMF learns about guest nodes.

AMF nodes gather information about guest nodes by using one of two internally defined discovery methods: static or dynamic.

With dynamic learning (the default method), AMF learns IP address and MAC addresses of guest nodes from LLDP or DHCP snooping. Dynamic learning is only supported when using IPv4. For IPv6, use static learning.

With dynamic learning, ensure that the command [ip dhcp snooping delete-by-linkdown](#) is set.

With static learning, you use the [switchport atmf-guestlink](#) command to specify the guest class name and IP address of the guest node attached to each individual switch port. AMF then learns the MAC addresses of each of the guests of that class from ARP or Neighbor discovery tables.

If you are using the static method, ensure that you have configured the appropriate class type for each of your statically discovered guest nodes.

The **no** variant of this command returns the discovery method to **dynamic**.

**Syntax** `discovery [static|dynamic]`  
`no discovery`

Parameter	Description
<code>static</code>	Statically assigned.
<code>dynamic</code>	Learned from DCHCP Snooping or LLDP.

**Default** Dynamic.

**Mode** ATMF Guest Configuration Mode.

**Usage notes** This command is one of several modal commands that are configured and applied for a specific guest-class (mode). Its settings are automatically applied to a guest-node link by the [switchport atmf-guestlink](#) command.

**NOTE:** *AMF guest nodes are not supported on ports using the OpenFlow protocol.*

**Example 1** To configure the discovery of the guest-class camera to operate statically, use the following commands:

```
Nodel# configure terminal
Nodel(config)# atmf guest-class camera
Nodel(config-guest)# discovery static
```

**Example 2** To return the discovery method for the guest class TQ4600-1 to its default of **dynamic**, use the following commands:

```
Node1# configure terminal
Node1(config)# atmf guest-class TQ4600-1
Node1(config-guest)# no discovery
```

**Related commands**

- atmf guest-class
- switchport atmf-guestlink
- show atmf links guest
- show atmf nodes

# description (amf-container)

**Overview** Use this command to set the description on an AMF container on a Virtual AMF Appliance (VAA).

An AMF container is an isolated instance of AlliedWare Plus with its own network interfaces, configuration, and file system. The features available inside an AMF container are a sub-set of the features available on the host VAA. These features enable the AMF container to function as a uniquely identifiable AMF master and allows for multiple tenants (up to 60) to run on a single VAA host. See the [AMF Feature Overview and Configuration Guide](#) for more information on running multiple tenants on a single VAA host.

Use the **no** variant of this command to remove the description from an AMF container.

**Syntax** `description <description>`  
`no description`

Parameter	Description
<code>&lt;description&gt;</code>	Enter up to 128 characters of text describing the AMF container.

**Mode** AMF Container Configuration

**Example** To set the description for AMF container “vac-wlg-1” to “Wellington area”, use the commands:

```
awplus# configure terminal
awplus(config)# atmf container vac-wlg-1
awplus(config-atmf-container)# description Wellington area
```

To remove the description for AMF container “vac-wlg-1”, use the commands:

```
awplus# configure terminal
awplus(config)# atmf container vac-wlg-1
awplus(config-atmf-container)# no description
```

**Related commands** [atmf container](#)  
[show atmf container](#)

**Command changes** Version 5.4.7-0.1: command added

# erase factory-default

**Overview** This command erases all data from Flash **except** the following:

- the boot release file (a .rel file) and its release setting file
- all license files
- the latest GUI release file

The device is then rebooted and returned to its factory default condition. The device can then be used for AMF automatic node recovery.

**Syntax** `erase factory-default`

**Mode** Privileged Exec.

**Usage notes** This command is an alias to the [atmf cleanup](#) command.

**Example** To erase data, use the command:

```
Node_1# erase factory-default
```

```
This command will erase all NVS, all flash contents except for  
the boot release, a GUI resource file, and any license files,  
and then reboot the switch. Continue? (y/n):y
```

**Related commands** [atmf cleanup](#)

# http-enable

**Overview** This command is used to enable GUI access to a guest node. When http-enable is configured the port number is set to its default of 80. If the guest node is using a different port for HTTP, you can configure this using the port *<PORTNO>* attribute.

This command is used to inform the GUI that this device has an HTTP interface at the specified port number so that a suitable URL can be provided to the user.

Use the **no** variant of this command to disable HTTP.

**Syntax** http-enable [port *<port-number>*]  
no http-enable

Parameter	Description
port	TCP port number.
<i>&lt;port-number&gt;</i>	The port number to be configured.

**Default** http-enable is off.  
If http-enable is selected without a port parameter the port number will default to 80.

**Mode** ATMF Guest Configuration Mode

**Example 1** To enable HTTP access to a guest node on port 80 (the default), use the following commands:

```
node1# conf t
node1(config)#atmf guest-class Camera
node1(config-atmf-guest)#http-enable
node1(config-atmf-guest)#
```

**Example 2** To enable HTTP access to a guest node on port 400, use the following commands:

```
node1# conf t
node1(config)#atmf guest-class Camera
node1(config-atmf-guest)#http-enable port 400
node1(config-atmf-guest)#
```

**Example 3** To disable HTTP access to a guest node, use the following commands:

```
node1# conf t
node1(config)#atmf guest-class Camera
node1(config-atmf-guest)#no http-enable
node1(config-atmf-guest)#
```

**Related  
commands**    `atmf guest-class`  
                  `switchport atmf-guestlink`  
                  `show atmf links guest`  
                  `show atmf nodes`

# identity (amf-provision)

**Overview** Use this command to create an identity token for provisioning an isolated AMF node. An isolated node is an AMF member that is only connected to the rest of the AMF network via a virtual-link.

This command allows these nodes, which have no AMF neighbors, to be identified for provisioning purposes. They are identified using an identity token which is based on either the next-hop MAC address of the provisioned node, or the serial number of the device being provisioned. This identity token is stored on the AMF master.

Use the **no** variant of this command to remove the identity token for a node.

**Syntax**

```
identity mac-address <mac-address> prefix  
<ip-address/prefix-length>  
  
identity serial-number <serial-number> prefix  
<ip-address/prefix-length>  
  
no identity
```

Parameter	Description
mac-address	Specify the next-hop MAC address of the device being provisioned.
<mac-address>	MAC address of the port the provisioned node is connected to, in the format xxxx.xxxx.xxxx.
serial-number	Specify the serial number of the device to be provisioned.
<serial-number>	Serial number of the device that is being provisioned.
prefix	IPv4 address, and prefix length, of the virtual-link interface on the isolated node
<ip-address/ prefix-length>	IPv4 address, and prefix length, in A.B.C.D/M format.

**Mode** AMF Provisioning

**Usage notes** To provision an isolated node, first create a configuration for the node using the [create \(amf-provision\)](#) and/or the [clone \(amf-provision\)](#) commands.

Then create an identity token for the provisioned node by either specifying its next-hop MAC address or by specifying the serial number of the replacement device. The advantage of using the next-hop MAC address is that any device, regardless of its serial number, can be added to the network but using the serial number maybe preferred in situations where the next-hop MAC address is not easy to obtain.

The [atmf recovery-server](#) option must be enabled on the AMF master before attempting to provision the device. This option allows the AMF master to process recovery requests from isolated AMF nodes.

See the [AMF Feature Overview and Configuration Guide](#) for information on preparing your network for recovering or provisioning isolated nodes.

**Example** To create a identity token on your AMF master for a device named “my-x930” with serial number “A10064A172100008”, use the command:

```
awplus# atmf provision node my-x930  
awplus(atmf-provision)# identity serial-number  
A10064A172100008 prefix 192.168.2.25/24
```

To create a identity token on your AMF master for a device named “my-x930” with next-hop MAC address “0000.cd28.0880”, use the command:

```
awplus# atmf provision node my-x930  
awplus(atmf-provision)# identity mac-address 0000.cd28.0880  
prefix 192.168.2.25/24
```

To delete the identity token from your AMF master for a device named “my-x930”, use the command:

```
awplus# atmf provision node my-x930  
awplus(atmf-provision)# no identity
```

**Related  
commands**

- [atmf cleanup](#)
- [atmf provision \(interface\)](#)
- [atmf provision node](#)
- [atmf recovery-server](#)
- [atmf virtual-link](#)
- [clone \(amf-provision\)](#)
- [configure boot config \(amf-provision\)](#)
- [configure boot system \(amf-provision\)](#)
- [create \(amf-provision\)](#)
- [delete \(amf-provision\)](#)
- [license-cert \(amf-provision\)](#)
- [locate \(amf-provision\)](#)
- [show atmf provision nodes](#)

**Command  
changes**

Version 5.4.9-0.1: syntax change due to new AMF provisioning mode  
Version 5.4.7-2.1: command added



# license-cert (amf-provision)

**Overview** This command is used to set up the license certificate for a provisioned node.

The certificate file usually has all the license details for the network, and can be stored anywhere in the network. This command makes a hidden copy of the certificate file and stores it in the space set up for the provisioned node on AMF backup media.

For node provisioning, the new device has not yet been part of the AMF network, so the user is unlikely to know its product ID or its MAC address. When such a device joins the network, assuming that this command has been applied successfully, the copy of the certificate file will be applied automatically to the provisioned node.

Once the new device has been resurrected on the network and the certificate file has been downloaded to the provisioned node, the hidden copy of the certificate file is deleted from AMF backup media.

Use the **no** variant of this command to set it back to the default.

This command can only be run on AMF master nodes.

**Syntax** `license-cert <file-path/URL>`  
`no license-cert`

Parameter	Description
<code>&lt;file-path/URL&gt;</code>	The name of the certificate file. This can include the file-path of the file.

**Default** No license certificate file is specified for the provisioned node.

**Mode** AMF Provisioning

**Usage notes** This command is only available on master nodes in the AMF network. It will only operate if the provisioned node specified in the command has already been set up, and if the license certification is present in the backup file. Otherwise, an error message is shown when the command is run.

**Example 1** To apply the license certificate 'cert1.txt' stored on a TFTP server for AMF provisioned node "device2", use the command:

```
device1# atmf provision node device2
device1(atmf-provision)# license-cert
tftp://192.168.1.1/cert1.txt
```

**Example 2** To apply the license certificate 'cert2.txt' stored in the AMF master's flash directory for AMF provisioned node 'host2', use the command:

```
device1# atmf provision node host2
device1(atmf-provision)# license-cert /cert2.txt
```

To confirm that the license certificate has been applied to the provisioned node, use the command `show atmf provision nodes`. The output from this command is shown below, and displays license certification details in the last line.

Figure 39-7: Sample output from the `show atmf provision nodes` command

```
device1#show atmf provision nodes

ATMF Provisioned Node Information:

Backup Media .....: SD (Total 3827.0MB, Free 3481.1MB)

Node Name           : device2
Date & Time         : 06-Oct-2016 & 23:25:44
Provision Path      : card:/atmf/nodes

Boot configuration :
Current boot image  : x510-5.4.6-1.4.rel (file exists)
Backup boot image   : x510-5.4.6-1.3.rel (file exists)
Default boot config : flash:/default.cfg (file exists)
Current boot config : flash:/abc.cfg (file exists)
Backup boot config  : flash:/xyz.cfg (file exists)

Software Licenses :
Repository file     : ../configs/.sw_v2.lic
                   : ../configs/.swfeature.lic
Certificate file    : card:/atmf/lok/nodes/awplus1/flash/.atmf-lic-cert
```

- Related commands**
- [atmf provision \(interface\)](#)
  - [atmf provision node](#)
  - [clone \(amf-provision\)](#)
  - [configure boot config \(amf-provision\)](#)
  - [configure boot system \(amf-provision\)](#)
  - [create \(amf-provision\)](#)
  - [delete \(amf-provision\)](#)
  - [identity \(amf-provision\)](#)
  - [locate \(amf-provision\)](#)
  - [show atmf provision nodes](#)

**Command changes** Version 5.4.9-0.1: syntax change due to new AMF provisioning mode

# locate (amf-provision)

**Overview** This command changes the present working directory to the directory of a provisioned node. This makes it easier to edit files and create a unique provisioned node in the backup.

This command can only be run on AMF master nodes.

**NOTE:** We advise that after running this command, you return to a known working directory, typically flash.

**Syntax** locate

**Mode** AMF Provisioning

**Example** To change the working directory that happens to be on device1 to the directory of provisioned node device2, use the following command:

```
device1# atmf provision node device2  
device1[atmf-provision]# locate
```

The directory of the node device2 should now be the working directory. You can use the command `pwd` to check this, as shown in the following figure.

Figure 39-8: Sample output from the `pwd` command

```
device2#pwd  
card:/atmf/building_2/nodes/device2/flash
```

The output above shows that the working directory is now the flash of device2.

**Related commands**

- [atmf provision \(interface\)](#)
- [atmf provision node](#)
- [clone \(amf-provision\)](#)
- [configure boot config \(amf-provision\)](#)
- [configure boot system \(amf-provision\)](#)
- [copy \(amf-provision\)](#)
- [create \(amf-provision\)](#)
- [delete \(amf-provision\)](#)
- [identity \(amf-provision\)](#)
- [license-cert \(amf-provision\)](#)
- [locate \(amf-provision\)](#)
- [pwd](#)
- [show atmf provision nodes](#)

**Command changes** Version 5.4.9-0.1: syntax change due to new AMF provisioning mode

# log event-host

**Overview** Use this command to set up an external host to log AMF topology events through Vista Manager. This command is run on the Master device.

Use the **no** variant of this command to disable log events through Vista Manager.

**Syntax** `log event-host [<ipv4-addr>|<ipv6-addr>] atmf-topology-event`  
`no log event-host [<ipv4-addr>|<ipv6-addr>] atmf-topology-event`

Parameter	Description
<code>&lt;ipv4-addr&gt;</code>	ipv4 address of the event host
<code>&lt;ipv6-addr&gt;</code>	ipv6 address of the event host

**Default** Log events are disabled by default.

**Mode** Global Configuration

**Usage notes** Event hosts are set so syslog sends the messages out as they come.

Note that there is a difference between log event and log host messages:

- Log event messages are sent out as they come by syslog
- Log host messages are set to wait for a number of messages (20) to send them out together for traffic optimization.

**Example** To enable Node 1 to log event messages from host IP address 192.0.2.31, use the following commands:

```
Node1# configure terminal
```

```
Node1(config)# log event-host 192.0.2.31 atmf-topology-event
```

To disable Node 1 to log event messages from host IP address 192.0.2.31, use the following commands:

```
Node1# configure terminal
```

```
Node1(config)# no log event-host 192.0.2.31 atmf-topology-event
```

**Related commands** [atmf topology-gui enable](#)

# modeltype

**Overview** This command sets the expected model type of the guest node. The model type will default to **other** if nothing is set.

Use the **no** variant of this command to reset the model type to **other**.

**Syntax** `modeltype [alliedware|aw+|onvif|tq|other]`  
`no modeltype`

Parameter	Description
alliedware	A legacy Allied Telesis operating system.
aw+	The Allied Telesis AlliedWare Plus operating system.
onvif	ONVIF (Open Network Video Interface Forum) Profile Q devices
tq	An Allied Telesis TQ Series wireless access point.
other	Used where the model type is outside the above definitions.

**Default** Default to **other**

**Mode** ATMF Guest Configuration Mode

**Example 1** To assign the model type **tq** to the guest-class called 'tq\_device', use the following commands:

```
node1# conf t
node1(config)# atmf guest-class tq_device
node1(config-atmf-guest)# modeltype tq
node1(config-atmf-guest)# end
```

**Example 2** To remove the model type **tq** from the guest-class called 'tq\_device', and reset it to the default of **other**, use the following commands:

```
node1# conf t
node1(config)# atmf guest-class tq_device
node1(config-atmf-guest)# no modeltype
node1(config-atmf-guest)# end
```

**Related commands** [atmf guest-class](#)  
[switchport atmf-guestlink](#)  
[show atmf links guest](#)

**Command changes** Version 5.4.9-2.1: **onvif** parameter added

# service atmf-application-proxy

**Overview** Use this command to enable the AMF Application Proxy service. This service distributes messages across all AMF nodes.

Currently this is used for threat protection. When an AMF Security (AMF-Sec) Controller detects a threat, it issues a request to block the address the threat originated from. The AMF Application Proxy service distributes this message to all AMF nodes. An AMF master accepts this block request and instructs the subordinate AMF node to block the relevant device.

Use the **no** variant of this command to disable the AMF Application Proxy service.

**Syntax** `service atmf-application-proxy`  
`no service atmf-application-proxy`

**Default** The AMF Application Proxy service is disabled by default.

**Mode** Global Configuration

**Usage notes** The AMF master maintains a list of all threats and will send this list to any AMF node, or VCS member, when it boots and joins the AMF network.

In order for this to work the follow must be configured:

- the AMF Application Proxy service on all AMF nodes that need to receive the messages.
- the Hypertext Transfer Protocol (HTTP) service on all nodes that are running the AMF Application Proxy service (see [service http](#)).

**Example** To enable the AMF Application Proxy service, use the commands

```
awplus# configure terminal
awplus(config)# service atmf-application-proxy
```

To disable the AMF Application Proxy service, use the commands

```
awplus# configure terminal
awplus(config)# no service atmf-application-proxy
```

**Related commands** [application-proxy threat-protection](#)  
[application-proxy whitelist server](#)  
[clear application-proxy threat-protection](#)  
[show application-proxy threat-protection](#)

**Command changes** Version 5.4.7-2.2: command added

# show application-proxy threat-protection

**Overview** Use this command to list all the IP addresses blocked by the AMF Application Proxy service. It also shows the global threat-detection configuration.

**Syntax** `show application-proxy threat-protection [all]`

Parameter	Description
all	Include information for non-local blocks.

**Mode** Privileged Exec

**Example** To list the addresses blocked by the AMF Application Proxy service, use the command:

```
awplus# show application-proxy threat-protection
```

**Output** Figure 39-9: Example output from **show application-proxy threat-protection**

```
awplus#show application-proxy threat-protection
Quarantine Vlan      : vlan200
Global IP-Filter     : Enabled
IP-Filter Limit Exceeded : 0
Redirect-URL        : http://my.dom/help.html

Client IP           Interface      MAC Address    VLAN    Action
-----
10.34.199.110      -             -             -       link-down
10.34.199.116      port1.0.3     001a.eb93.ec5d 1       drop
10.1.179.1         *             *             *       ip-filter
...
```

Table 39-1: Parameters in the output from **show application-proxy threat-protection**

Parameter	Description
Quarantine Vlan	The name of the quarantine VLAN.
Global IP-Filter	The status of global IP filtering.
IP-Filter Limit Exceeded	The number of times an ACL failed to be installed due to insufficient space.
Redirect-URL	The URL a blocked user is redirected to.

**Related commands** [application-proxy quarantine-vlan](#)  
[application-proxy threat-protection](#)



clear application-proxy threat-protection  
service atmf-application-proxy

**Command changes** Version 5.4.7-2.2: command added

# show application-proxy whitelist interface

**Overview** Use this command to display the status of port authentication on the specified interface.

**Syntax** `show application-proxy whitelist interface [<interface-list>]`

Parameter	Description
<code>&lt;interface-list&gt;</code>	<p>The interfaces or ports to display information about. An interface-list can be:</p> <ul style="list-style-type: none"><li>• a switchport (e.g. port1.0.4)</li><li>• a static channel group (e.g. sa2)</li><li>• a dynamic (LACP) channel group (e.g. po2)</li><li>• a continuous range of ports separated by a hyphen (e.g. port1.0.1-1.0.4)</li><li>• a comma-separated list (e.g. port1.0.1,port1.0.3-1.0.4). Do not mix port types in the same list.</li></ul> <p>The specified interface must exist.</p>

**Mode** Privileged Exec

**Example** To display the port authentication information for all interfaces, use the command:

```
awplus# show application-proxy whitelist interface
```

To display the port authentication information for port1.0.4, use the command

```
awplus# show application-proxy whitelist interface port1.0.4
```

**Output** Figure 39-10: Example output from **show application-proxy whitelist interface**

```
awplus#sh application-proxy whitelist interface
Authentication Info for interface port1.0.1
  portEnabled: false - portControl: Auto
  portStatus: Unknown
  reAuthenticate: disabled
  reAuthPeriod: 3600
  PAE: quietPeriod: 60 - maxReauthReq: 2 - txPeriod: 30
  PAE: connectTimeout: 30
  BE: suppTimeout: 30 - serverTimeout: 30
  CD: adminControlledDirections: in
  KT: keyTxEnabled: false
  critical: disabled
  guestVlan: disabled
  guestVlanForwarding:
    none
  authFailVlan: disabled
  dynamicVlanCreation: disabled
  multiVlanSession: disabled
  hostMode: single-host
  dot1x: disabled
  authMac: enabled
    method: PAP
    scheme: mac
    reauthRelearning: disabled
  authWeb: disabled
  twoStepAuthentication:
    configured: disabled
    actual: disabled
  supplicantMac: none
  supplicantIpv4: none
Authentication Info for interface port1.0.2
...
```

- Related commands**
- [application-proxy whitelist enable](#)
  - [application-proxy whitelist server](#)
  - [show application-proxy whitelist server](#)
  - [show application-proxy whitelist supplicant](#)

**Command changes** Version 5.4.9-0.1: command added

# show application-proxy whitelist server

**Overview** Use this command to display the external RADIUS server details for the application-proxy whitelist feature.

**Syntax** `show application-proxy whitelist server`

**Mode** Privileged Exec

**Example** To display the external RADIUS server details for the application-proxy whitelist feature, use the command:

```
awplus# show application-proxy whitelist server
```

**Output** Figure 39-11: Example output from **show application-proxy whitelist server**

```
awplus#show application-proxy whitelist server
Application Proxy Whitelist Details:

External Server Details:
  IP: 192.168.1.10
  Port: 1812

Proxy Details:
  IP: 172.31.0.5
  Status: Alive
```

**Related commands**

- [application-proxy whitelist enable](#)
- [application-proxy whitelist server](#)
- [show application-proxy whitelist interface](#)
- [show application-proxy whitelist supplicant](#)

**Command changes** Version 5.4.9-0.1: command added

# show application-proxy whitelist supplicant

**Overview** Use this command to display the current configuration and status for each supplicant attached to an application-proxy whitelist port.

**Syntax** `show application-proxy whitelist supplicant [interface <interface-list> | <mac-addr> | brief]`

Parameter	Description
<code>interface</code> <code>&lt;interface-list&gt;</code>	The interfaces or ports to display information about. An interface-list can be: <ul style="list-style-type: none"><li>• a switchport (e.g. port1.0.4)</li><li>• a static channel group (e.g. sa2)</li><li>• a dynamic (LACP) channel group (e.g. po2)</li><li>• a continuous range of ports separated by a hyphen (e.g. port1.0.1-1.0.4)</li><li>• a comma-separated list (e.g. port1.0.1,port1.0.3-1.0.4). Do not mix port types in the same list.</li></ul> The specified interface must exist.
<code>&lt;mac-addr&gt;</code>	MAC (hardware) address of the supplicant. Entry format is HHHH.HHHH.HHHH (hexadecimal)
<code>brief</code>	Brief summary of the supplicant state.

**Mode** Privileged Exec

**Example** To display the supplicant information for all ports, use the command:

```
awplus# show application-proxy whitelist supplicant
```

To display the supplicant information for port1.0.4, use the command:

```
awplus# show application-proxy whitelist supplicant interface port1.0.4
```

**Output** Figure 39-12: Example output from **show application-proxy whitelist supplicant**

```
awplus#show application-proxy whitelist supplicant
Interface port1.0.4
 authenticationMethod: dot1x/mac/web
  Two-Step Authentication
    firstMethod: mac
    secondMethod: dot1x/web
 totalSupplicantNum: 1
 authorizedSupplicantNum: 1
   macBasedAuthenticationSupplicantNum: 0
   dot1xAuthenticationSupplicantNum: 0
   webBasedAuthenticationSupplicantNum: 1
   otherAuthenticationSupplicantNum: 0

Supplicant name: test
Supplicant address: 001c.233e.e15a
 authenticationMethod: WEB-based Authentication
  Two-Step Authentication:
    firstAuthentication: Pass - Method: mac
    secondAuthentication: Pass - Method: web
 portStatus: Authorized - currentId: 1
 abort:F fail:F start:F timeout:F success:T
 PAE: state: Authenticated - portMode: Auto
 PAE: reAuthCount: 0 - rxRespId: 0
 PAE: quietPeriod: 60 - maxReauthReq: 2
 BE: state: Idle - reqCount: 0 - idFromServer: 0
 CD: adminControlledDirections: in operControlledDirections: in
 CD: bridgeDetected: false
 KR: rxKey: false
 KT: keyAvailable: false - keyTxEnabled: false
 RADIUS server group (auth): radius
 RADIUS server (auth): 192.168.1.40
...
```

**Related commands**

- [application-proxy whitelist enable](#)
- [application-proxy whitelist server](#)
- [show application-proxy whitelist interface](#)
- [show application-proxy whitelist server](#)

**Command changes** Version 5.4.9-0.1: command added

# show atmf

**Overview** Displays information about the current AMF node.

**Syntax** `show atmf [summary|tech|nodes|session]`

Parameter	Description
summary	Displays summary information about the current AMF node.
tech	Displays global AMF information.
nodes	Displays a list of AMF nodes together with brief details.
session	Displays information on an AMF session.

**Default** Only summary information is displayed.

**Mode** User Exec and Privileged Exec

**Usage notes** AMF uses internal VLANs to communicate between nodes about the state of the AMF network. Two VLANs have been selected specifically for this purpose. Once these have been assigned, they are reserved for AMF and cannot be used for other purposes

For information on filtering and saving command output, see the [“Getting Started with AlliedWare Plus” Feature Overview and Configuration Guide](#).

**Example 1** To show summary information on AMF node\_1 use the following command:

```
node_1# show atmf summary
```

**Table 40:** Output from the **show atmf summary** command

```
node_1#show atmf summary
ATMF Summary Information:

ATMF Status           : Enabled
Network Name          : Test_network
Node Name              : node_1
Role                   : Master
Restricted login       : Disabled
Current ATMF Nodes    : 3
```

**Example 2** To show information specific to AMF nodes use the following command:

```
node_1# show atmf nodes
```

**Example 3** The **show amf session** command displays all CLI (Command Line Interface) sessions for users that are currently logged in and running a CLI session.

To display AMF active sessions, use the following command:

```
node_1# show atmf session
```

For example, in the output below, node\_1 and node\_5 have active users logged in.

**Table 41:** Output from the **show atmf session** command

```
node_1#show atmf session

CLI Session Neighbors

Session ID           : 73518
Node Name            : node_1
PID                  : 7982
Link type            : Broadcast-cli
MAC Address          : 0000.0000.0000
Options              : 0
Our bits             : 0
Link State           : Full
Domain Controller    : 0
Backup Domain Controller : 0
Database Description Sequence Number : 00000000
First Adjacency      : 1
Number Events        : 0
DBE Retransmit Queue Length : 0
DBE Request List Length : 0
Session ID           : 410804
Node Name            : node_5
PID                  : 17588
Link type            : Broadcast-cli
MAC Address          : 001a.eb56.9020
Options              : 0
Our bits             : 0
Link State           : Full
Domain Controller    : 0
Backup Domain Controller : 0
Database Description Sequence Number : 00000000
First Adjacency      : 1
Number Events        : 0
DBE Retransmit Queue Length : 0
DBE Request List Length : 0
```

**Example 4** The AMF tech command collects all the AMF commands, and displays them. You can use this command when you want to see an overview of the AMF network.

To display AMF technical information, use the following command:

```
node_1# show atmf tech
```



**Table 42:** Output from the **show atmf tech** command

```

node_1#show atmf tech
ATMF Summary Information:

ATMF Status           : Enabled
Network Name         : ATMF_NET
Node Name            : node_1
Role                 : Master
Current ATMF Nodes   : 8

ATMF Technical information:

Network Name           : ATMF_NET
Domain                : node_1's domain
Node Depth            : 0
Domain Flags          : 0
Authentication Type   : 0
MAC Address           : 0014.2299.137d
Board ID              : 287
Domain State          : DomainController
Domain Controller     : node_1
Backup Domain Controller : node2
Domain controller MAC : 0014.2299.137d
Parent Domain         : -
Parent Domain Controller : -
Parent Domain Controller MAC : 0000.0000.0000
Number of Domain Events : 0
Crosslink Ports Blocking : 0
Uplink Ports Waiting on Sync : 0
Crosslink Sequence Number : 7
Domains Sequence Number : 28
Uplink Sequence Number : 2
Number of Crosslink Ports : 1
Number of Domain Nodes : 2
Number of Neighbors : 5
Number of Non Broadcast Neighbors : 3
Number of Link State Entries : 1
Number of Up Uplinks : 0
Number of Up Uplinks on This Node : 0
DBE Checksum          : 84fc6
Number of DBE Entries : 0
Management Domain Ifindex : 4391
Management Domain VLAN : 4091
Management ifindex : 4392
Management VLAN : 4092
    
```

**Table 43:** Parameter definitions from the **show atmf tech** command

Parameter	Definition
ATMF Status	The Node's AMF status, either Enabled or Disabled.
Network Name	The AMF network that a particular node belongs to.

**Table 43:** Parameter definitions from the **show atmf tech** command (cont.)

Parameter	Definition
Node Name	The name assigned to a particular node.
Role	The role configured for this AMF device, either Master or Member.
Current ATMF Nodes	The count of AMF nodes in an AMF Network.
Node Address	An address used to access a remotely located node (.atmf).
Node ID	A unique identifier assigned to a Node on an AMF network.
Node Depth	The number of nodes in path from this node to level of the AMF root node. It can be thought of as the vertical depth of the AMF network from a particular node to the zero level of the AMF root node.
Domain State	The state of Node in a Domain in AMF network as Controller/Backup.
Recovery State	The AMF node recovery status. Indicates whether a node recovery is in progress on this device - Auto, Manual, or None.
Management VLAN	The VLAN created for traffic between Nodes of different domain (up/down links). <ul style="list-style-type: none"> <li>• VLAN ID - In this example VLAN 4092 is configured as the Management VLAN.</li> <li>• Management Subnet - Network prefix for the subnet.</li> <li>• Management IP Address - The IP address allocated for this traffic.</li> <li>• Management Mask - The subnet mask used to create a subnet for this traffic (255.255.128.0).</li> </ul>
Domain VLAN	The VLAN assigned for traffic between Nodes of same domain (crosslink). <ul style="list-style-type: none"> <li>• VLAN ID - In this example VLAN 4091 is configured as the domain VLAN.</li> <li>• Domain Subnet. The subnet address used for this traffic.</li> <li>• Domain IP Address. The IP address allocated for this traffic.</li> <li>• Domain Mask. The subnet mask used to create a subnet for this traffic (255.255.128.0).</li> </ul>
Device Type	The Product Series name.
ATMF Master	Whether the node is an AMF master node for its area ('Y' if it is and 'N' if it is not).
SC	The device configuration, one of C - Chassis (SBx8100 Series), S - Stackable (VCS) or N - Standalone.
Parent	The node to which the current node has an active uplink.
Node Depth	The number of nodes in the path from this node to the master node.

**Related commands** [show atmf detail](#)

# show atmf area

**Overview** Use this command to display information about an AMF area. On AMF controllers, this command displays all areas that the controller is aware of. On remote AMF masters, this command displays the controller area and the remote local area. On gateways, this command displays the controller area and remote master area.

**Syntax** `show atmf area [detail] [<area-name>]`

Parameter	Description
detail	Displays detailed information
<area-name>	Displays information about master and gateway nodes in the specified area only.

**Mode** Privileged Exec

**Example 1** To show information about all areas, use the command:

```
controller-1# show atmf area
```

The following figure shows example output from running this command on a controller.

**Table 44:** Example output from the **show atmf area** command on a Controller.

```
controller-1#show atmf area

ATMF Area Information:

* = Local area

Area          Area  Local  Remote  Remote  Node
Name          ID    Gateway Gateway Master   Count
-----
* NZ          1     Reachable  N/A     N/A     3
Wellington   2     Reachable  Reachable  Auth OK  120
Canterbury   3     Reachable  Reachable  Auth Error  -
SiteA-AREA   14    Unreachable  Unreachable  Unreachable  -
Auckland     100   Reachable  Reachable  Auth Start  -
Southland    120   Reachable  Reachable  Auth OK    54

Area count:      6                      Area node count:      177
```

The following figure shows example output from running this command on a remote master.

**Table 45:** Example output from the **show atmf area** command on a remote master.

```

Canterbury#show atmf area

ATMF Area Information:

* = Local area

Area          Area  Local      Remote      Remote      Node
Name          ID    Gateway    Gateway     Master      Count
-----
NZ            1     Reachable  N/A         N/A         -
* Canterbury  3     Reachable  N/A         N/A         40

Area count:      2                               Local area node count:  40
    
```

**Table 46:** Parameter definitions from the **show atmf area** command

Parameter	Definition
*	Indicates the area of the device on which the command is being run.
Area Name	The name of each area.
Area ID	The ID of the area.
Local Gateway	Whether the local gateway node is reachable or not.
Remote Gateway	Whether the remote gateway node is reachable or not. This is one of the following: <ul style="list-style-type: none"> <li>Reachable, if the link has been established.</li> <li>Unreachable, if a link to the remote area has not been established. This could mean that a port or vlan is down, or that inconsistent VLANs have been configured using the <a href="#">switchport atmf-arealink remote-area</a> command.</li> <li>N/A for the area of the controller or remote master on which the command is being run, because the gateway node on that device is local.</li> <li>Auth Start, which may indicate that the area names match on the controller and remote master, but the IDs do not match.</li> <li>Auth Error, which indicates that the areas tried to authenticate but there is a problem. For example, the passwords configured on the controller and remote master may not match, or a password may be missing on the remote master.?</li> <li>Auth OK, which indicates that area authentication was successful and you can now use the <a href="#">atmf select-area</a> command.</li> </ul>
Remote Master	Whether the remote master node is reachable or not. This is N/A for the area of the controller or remote master on which the command is being run, because the master node on that device is local.
Node Count	The number of nodes in the area.
Area Count	The number of areas controlled by the controller.
Area Node Count	The total number of nodes in the area.

**Example 2** To show detailed information about the areas, use the command:

```
controller-1# show atmf area detail
```

The following figure shows example output from running this command.

**Table 47:** Output from the **show atmf area detail** command

```
controller-1#show atmf area detail

ATMF Area Detail Information:

Controller distance      : 0

Controller Id           : 21
Backup Available        : FALSE

Area Id                 : 2
Gateway Node Name       : controller-1
Gateway Node Id         : 342
Gateway Ifindex         : 6013
Masters Count           : 1
Master Node Name        : well-master (329)
Node Count              : 2

Area Id                 : 3
Gateway Node Name       : controller-1
Gateway Node Id         : 342
Gateway Ifindex         : 4511
Masters Count           : 2
Master Node Name        : cant1-master (15)
Master Node Name        : cant2-master (454)
Node Count              : 2
```

**Related commands**

- [show atmf area summary](#)
- [show atmf area nodes](#)
- [show atmf area nodes-detail](#)

# show atmf area guests

**Overview** This command will display details of all guests that the controller is aware of.

**Syntax** show atmf area guests [*<area-name>*] [*<node-name>*]

Parameter	Description
<i>&lt;area-name&gt;</i>	The area name for guest information
<i>&lt;node-name&gt;</i>	The name of the node that connects to the guests.

**Default** n/a

**Mode** User Exec/Privileged Exec

**Example 1** To display atmf area guest nodes on a controller, use the command,

```
GuestNode[1]#show atmf area guests
```

**Output** Figure 39-13: Example output from the **show atmf area guests** command

```
main-building Area Guest Node Information:
Device      MAC                               IP/IPv6
Type        Address          Parent          Port          Address
-----
-           0008.5d10.7635  x230            1.0.3         192.168.5.4
AT-TQ4600   eccd.6df2.da60  wireless-node1  1.0.4         192.168.5.3
-           0800.239e.f1fe  x230            1.0.4         192.168.4.8
AT-TQ4600   001a.eb3b.dc80  wireless-node2  1.0.7         192.168.4.12

main-building guest node count 4

GuestNode[1]#
```

**Table 48:** Parameters in the output from **show atmf area guests** command

Parameter	Description
Device Type	The device type as read from the guest node.
MAC Address	The MAC address of the guest-node
Parent	The device that directly connects to the guest-node
Port	The port number on the parent node that connects to the guest node.
IP/IPv6	The IP or IPv6 address of the guest node.

**Related commands**

- show atmf area
- show atmf area nodes
- show atmf backup guest
- show atmf area guests-detail

# show atmf area guests-detail

**Overview** This command displays the local and remote guest information from an AMF controller.

**Syntax** `show atmf area guests-detail [<area-name> [<node-name>]]`

Parameter	Description
<i>&lt;area-name&gt;</i>	The name assigned to the AMF area. An area is an AMF network that is under the control of an AMF Controller.
<i>&lt;node-name&gt;</i>	The name assigned to the network node.

**Default** n/a.

**Mode** Privileged Exec

**Example** To display detailed information for all guest nodes attached to “node1”, which is located within the area named “northern”, use the following command:

```
AMF_controller#show atmf area guests-detail northern node1
```

**Output** Figure 39-14: Example output from the **show atmf guest detail** command.

```
#show atmf guest detail

Node Name           : Node1
Port Name           : port1.0.5
Ifindex             : 5005
Guest Description   : tq4600
Device Type         : AT-TQ4600
Configuration Mismatch : No
Backup Supported    : Yes
MAC Address         : ecd.6df2.da60
IP Address          : 192.168.4.50
IPv6 Address        : Not Set
HTTP Port           : 80
Firmware Version    :
Node Name           : poe
Port Name           : port1.0.6
Ifindex             : 5006
Guest Description   : tq3600
Device Type         : AT-TQ2450
Configuration Mismatch : No
Backup Supported    : Yes
MAC Address         : 001a.eb3b.cb80
IP Address          : 192.168.4.9
IPv6 Address        : Not Set
HTTP Port           : 80
Firmware Version    :
```



**Table 49:** Parameters shown in the output of the **show atmf guest detail** command

Parameter	Description
Node Name	The name of the guest's parent node.
Port Name	The port on the parent node that connects to the guest.
IFindex	An internal index number that maps to the port number on the parent node.
Guest Description	A brief description of the guest node as manually entered into the <code>description (interface)</code> command for the guest node port on the parent node.
Device Type	The device type as supplied by the guest node itself.
Backup Supported	Indicates whether AMF supports backup of this guest node.
MAC Address	The MAC address of the guest node.
IP Address	The IP address of the guest node.
IPv6 Address	The IPv6 address of the guest node.
HTTP Port	The HTTP port enables you to specify a port when enabling http to allow a URL for the http user interface of a Guest Node. This is determined by the <code>http-enable</code> command.
Firmware Version	The firmware version that the guest node is currently running.

**Related commands** [show atmf area nodes-detail](#)  
[show atmf area guests](#)

# show atmf area nodes

**Overview** Use this command to display summarized information about an AMF controller's remote nodes.

Note that this command can only be run from a controller node.

**Syntax** `show atmf area nodes <area-name> [<node-name>]`

Parameter	Description
<area-name>	Displays information about nodes in the specified area.
<node-name>	Displays information about the specified node.

**Mode** Privileged Exec

**Usage notes** If you do not limit the output to a single area or node, this command lists all remote nodes that the controller is aware of. This can be a very large number of nodes.

**Example** To show summarized information for all the nodes in area 'Wellington', use the command:

```
controller-1# show atmf area nodes Wellington
```

The following figure shows partial example output from running this command.

**Table 50:** Output from the **show atmf area nodes Wellington** command

```
controller-1#show atmf area nodes Wellington

Wellington Area Node Information:

Node          Device          ATMF          Node
Name          Type            Master  SC    Parent          Depth
-----
well-gate     x230-18GP       N         N    well-master     1
well-master   AT-x930-28GPX   Y         N    none             0

Wellington node count 2

...
```

**Table 51:** Parameter definitions from the **show atmf area nodes** command

Parameter	Definition
Node Name	The name assigned to a particular node.
Device Type	The Product series name.

**Table 51:** Parameter definitions from the **show atmf area nodes** command (cont.)

Parameter	Definition
ATMF Master	Whether the node is an AMF master node for its area ('Y' if it is and 'N' if it is not).
SC	The device configuration, one of C - Chassis (SBx8100 series), S - Stackable (VCS) or N - Standalone.
Parent	The node to which the current node has an active uplink.
Node Depth	The number of nodes in the path from this node to the master node.

**Related commands** [show atmf area](#)  
[show atmf area nodes-detail](#)

# show atmf area nodes-detail

**Overview** Use this command to display detailed information about an AMF controller's remote nodes.

Note that this command can only be run from a controller node.

**Syntax** `show atmf area nodes-detail <area-name> [<node-name>]`

Parameter	Description
<code>&lt;area-name&gt;</code>	Displays detailed information about nodes in the specified area.
<code>&lt;node-name&gt;</code>	Displays detailed information about the specified node.

**Mode** Privileged Exec

**Usage notes** If you do not limit the output to a single area or node, this command displays information about all remote nodes that the controller is aware of. This can be a very large number of nodes.

**Example** To show information for all the nodes in area 'Wellington', use the command:

```
controller-1# show atmf area nodes-detail Wellington
```

The following figure shows partial example output from running this command.

**Table 52:** Output from the `show atmf area nodes-detail Wellington` command

```
controller-1#show atmf area nodes-detail Wellington

Wellington Area Node Information:
Node name well-gate
Parent node name : well-master
Domain id       : well-gate's domain
Board type      : 368
Distance to core : 1
Flags           : 50
Extra flags     : 0x00000006
MAC Address     : 001a.eb56.9020

Node name well-master
Parent node name : none
Domain id       : well-master's domain
Board type      : 333
Distance to core : 0
Flags           : 51
Extra flags     : 0x0000000c
MAC Address     : eccd.6d3f.fef7

...
```

**Table 53:** Parameter definitions from the **show atmf area nodes-detail** command

Parameter	Definition
Node name	The name assigned to a particular node.
Parent node name	The node to which the current node has an active uplink.
Domain id	The name of the domain the node belongs to.
Board type	The Allied Telesis code number for the device.
Distance to core	The number of nodes in the path from the current node to the master node in its area.
Flags	Internal AMF information
Extra flags	Internal AMF information
MAC Address	The MAC address of the current node

**Related commands** [show atmf area](#)  
[show atmf area nodes](#)

# show atmf area summary

**Overview** Use this command to display a summary of IPv6 addresses used by AMF, for one or all of the areas controlled by an AMF controller.

**Syntax** `show atmf area summary [<area-name>]`

Parameter	Description
<code>&lt;area-name&gt;</code>	Displays information for the specified area only.

**Mode** Privileged Exec

**Example 1** To show a summary of IPv6 addresses used by AMF, for all of the areas controlled by controller-1, use the command:

```
controller-1# show atmf area summary
```

The following figure shows example output from running this command.

**Table 54:** Output from the **show atmf area summary** command

```
controller-1#show atmf area summary

ATMF Area Summary Information:

Management Information
Local IPv6 Address           : fd00:4154:4d46:1::15

Area Information
Area Name                    : NZ (Local)
Area ID                      : 1
Area Master IPv6 Address     : -

Area Name                    : Wellington
Area ID                      : 2
Area Master IPv6 Address     : fd00:4154:4d46:2::149

Area Name                    : Canterbury
Area ID                      : 3
Area Master IPv6 Address     : fd00:4154:4d46:3::f

Area Name                    : Auckland
Area ID                      : 100
Area Master IPv6 Address     : fd00:4154:4d46:64::17
Interface                    : vlink2000
```

**Related commands**

- [show atmf area](#)
- [show atmf area nodes](#)
- [show atmf area nodes-detail](#)

# show atmf authorization

**Overview** Use this command on an AMF master to display the authorization status of other AMF members and masters on the network.

On an AMF controller this command will show the authorization status of remote area AMF masters.

**Syntax** `show atmf authorization {current|pending|provisional}`

Parameter	Description
current	Show the status of all authorized nodes.
pending	Show the status of unauthorized nodes in the pending queue. These are nodes that enabled secure mode with <code>atmf secure-mode</code> but have not yet been authorized with <code>atmf authorize</code> .
provisional	Show the status of provisionally authorized nodes. These are nodes that have been provisioned with <code>atmf authorize provision</code> .

**Mode** Privileged Exec

**Example** To display all authorized AMF nodes on an AMF controller or AMF master, use the command:

```
awplus# show atmf authorization current
```

To display AMF nodes which are requesting authorization on an AMF controller or AMF master, use the command:

```
awplus# show atmf authorization pending
```

To display AMF nodes which have provisional authorization, use the command:

```
awplus# show atmf authorization provisional
```

**Output** Figure 39-15: Example output from **show atmf authorization current**

NZ Authorized Nodes:		
Node Name	Signer	Expires
-----	-----	-----
master_1	master_1	4 Mar 2017
area_1_node_1	master_1	4 Mar 2017
area_1_node_2	master_1	4 Mar 2017

Table 39-1: Parameters in the output from **show atmf authorization current**

Parameter	Description
Node Name	AMF node name of the authorized node.
Signer	Name of the AMF master that authorized the node.
Expires	Expiry date of the authorization. Authorization expiry time is set using <code>atmf secure-mode certificate expiry</code> .

**Output** Figure 39-16: Example output from **show atmf authorization pending**

```

Pending Authorizations:

NZ Requests:
Node Name           Product           Parent Node       Interface
-----
area_1_node_3      x230-18GP        master_1          port1.2.9
area_1_node_4      x510-52GTX       master_1          sal
    
```

Table 39-2: Parameters in the output from **show atmf authorization pending**

Parameter	Description
Node Name	Name of the node that is requesting authorization.
Product	Product name.
Parent Node	Authorization authority of the requesting node.
Interface	Interface that the authorization request came in on.

**Output** Figure 39-17: Example output from **show atmf authorization provisional**

```

ATMF Provisional Authorization:

Area - Node Name           Start           Timeout
or MAC Address           Interface       Time           Minutes
-----
3333.4444.5555             5 Sep 2016 02:35:54   3
1111.2222.3333             5 Sep 2016 02:35:24   60
NZ - blue                   port1.0.3       5 Sep 2016 02:35:06   60
    
```



Table 39-3: Parameters in the output from **show atmf authorization provisional**

Parameter	Description
Area - Node Name or MAC Address	MAC address or node name of the node that has been provisionally authorized.
Interface	Interface that the node has been provisioned on.
Start Time	Time the node was provisioned.
Timeout Minutes	Length of time from Start Time until the provisional authorization expires.

**Related  
commands**

[atmf authorize](#)  
[atmf authorize provision](#)  
[atmf secure-mode](#)  
[clear atmf secure-mode certificates](#)  
[show atmf](#)  
[show atmf secure-mode](#)  
[show atmf secure-mode certificates](#)

**Command  
changes**

Version 5.4.7-0.3: command added

# show atmf backup

**Overview** This command displays information about AMF backup status for all the nodes in an AMF network. It can only be run on AMF master and controller nodes.

**Syntax**

```
show atmf backup
show atmf backup logs
show atmf backup server-status
show atmf backup synchronize [logs]
```

Parameter	Description
logs	Displays detailed log information.
server-status	Displays connectivity diagnostics information for each configured remote file server.
synchronize	Display the file server synchronization status
logs	For each remote file server, display the logs for the last synchronization

**Mode** Privileged Exec

**Example 1** To display the AMF backup information, use the command:

```
node_1# show atmf backup
```

To display log messages to do with backups, use the command:

```
node_1# show atmf backup logs
```

Table 39-4: Output from **show atmf backup**

```
Node_1# show atmf backup
ScheduledBackup .....Enabled
  Schedule.....1 per day starting at 03:00
  Next Backup Time...04 May 2019 03:00
Backup Bandwidth ....Unlimited
Backup Media.....SD (Total 1974.0 MB, Free197.6MB)
Current Action.....Starting manual backup
Started.....04 May 2019 10:08
CurrentNode.....atmf_testbox1
Backup Redundancy ...Enabled
  Local media .....SD (Total 3788.0MB, Free 3679.5MB)
  State .....Active
```

Node Name	Date	Time	In ATMF	On Media	Status
atmf_testbox1	04 May 2019	09:58:59	Yes	Yes	In Progress
atmf_testbox2	04 May 2019	10:01:23	Yes	Yes	Good

Table 39-5: Output from **show atmf backup logs**

```
Node_1#show atmf backup logs

Backup Redundancy ..... Enabled
Local media ..... SD (Total 3788.0MB, Free 1792.8MB)
State ..... Inactive (Remote file server is not available)

Log File Location: card:/atmf/ATMF/logs/rsync_<node name>.log

Node
Name Log Details
-----
atmf_testbox
2019/05/04 18:16:51 [9045] receiving file list
2019/05/04 18:16:51 [9047] .d..t.... flash/
2019/05/04 18:16:52 [9047] >f+++++++ flash/a.rel
```

**Example 2** To display the AMF backup synchronization status, use the command:

```
node_1# show atmf backup synchronize
```

To display log messages to do with synchronization of backups, use the command:

```
node_1# show atmf backup synchronize logs
```

Table 39-6: Output from **show atmf backup synchronize**

```
Node_1#show atmf backup synchronize

ATMF backup synchronization:

* = Active file server

  Id  Date          Time          Status
-----
  1   04 May 2016   22:25:57     Synchronized
* 2   -             -             Active
```

Table 39-7: Output from **show atmf backup synchronize logs**

```
Node_1#show atmf backup synchronize logs

Id    Log Details
-----
1     2019/05/04 22:25:54 [8039] receiving file list
      2019/05/04 22:25:54 [8039] >f..t.... backup_Box1.info
      2019/05/04 22:25:54 [8039] sent 46 bytes received 39 bytes total size 40
```

**Example 3** To display the AMF backup information with the optional parameter **server-status**, use the command:

```
Node_1# show atmf backup server-status
```

```

Node1#sh atmf backup server-status

Id    Last Check    State
-----
1     186 s        File server ready
2     1 s          SSH no route to host
    
```

**Table 40:** Parameter definitions from the **show atmf backup** command

Parameter	Definition
Scheduled Backup	Indicates whether AMF backup scheduling is enabled or disabled.
Schedule	Displays the configured backup schedule.
Next Backup Time	Displays the date and time of the next scheduled.
Backup Media	The current backup medium in use. This will be one of USB, SD, or NONE. Utilized and available memory (MB) will be indicated if backup media memory is present.
Current Action	The task that the AMF backup mechanism is currently performing. This will be a combination of either (Idle, Starting, Doing, Stopping), or (manual, scheduled).
Started	The date and time that the currently executing task was initiated in the format DD MMM YYYY HH:MM
Current Node	The name of the node that is currently being backed up.
Backup Redundancy	Whether backup redundancy is enabled or disabled.
Local media	The local media to be used for backup redundancy; SD, USB, INTERNAL, or NONE, and total and free memory available on the media.
State	Whether SD or USB media is installed and available for backup redundancy. May be Active (if backup redundancy is functional—requires both the local redundant backup media and a remote server to be configured and available) or Inactive.
Node Name	The name of the node that is storing backup data - on its backup media.
Date	The data of the last backup in the format DD MMM YYYY.
Time	The time of the last backup in the format HH:MM:SS.
In ATMF	Whether the node shown is active in the AMF network, (Yes or No).
On Media	Whether the node shown has a backup on the backup media (Yes or No).

**Table 40:** Parameter definitions from the **show atmf backup** command (cont.)

Parameter	Definition
Status	The output can contain one of four values: <ul style="list-style-type: none"><li>• “-” meaning that the status file cannot be found or cannot be read.</li><li>• “Errors” meaning that there are issues - note that the backup may still be deemed successful depending on the errors.</li><li>• “Stopped” meaning that the backup attempt was manually aborted.</li><li>• “Good” meaning that the backup was completed successfully.</li><li>• “In Progress” meaning that the backup is currently running on that node.</li></ul>
Log File Location	All backup attempts will generate a result log file in the identified directory based on the node name. In the above example this would be: card:/amf/office/logs/rsync_amf_testbox1.log.
Log Details	The contents of the backup log file.
server-status	Displays connectivity diagnostics information for each configured remove file server.

For information on filtering and saving command output, see the [“Getting Started with AlliedWare Plus” Feature Overview and Configuration Guide](#).

**Related commands** [show atmf](#)  
[atmf network-name](#)

# show atmf backup area

**Overview** Use this command to display backup status information for the master nodes in one or more areas.

Note that this command is only available on AMF controllers.

**Syntax** `show atmf backup area [<area-name> [<node-name>]] [logs]`

Parameter	Description
logs	Displays the logs for the last backup of each node.
<area-name>	Displays information about nodes in the specified area.
<node-name>	Displays information about the specified node.

**Mode** Privileged Exec

**Example** To show information about backups for an area, use the command:

```
controller-1# show atmf backup area
```

**Table 41:** Output from the **show atmf backup area** command

```

controller-1#show atmf backup area

Scheduled Backup ..... Enabled
  Schedule ..... 12 per day starting at 14:30
  Next Backup Time .... 15 Oct 2016 04:30
Backup Bandwidth ..... Unlimited
Backup Media ..... FILE SERVER 1 (Total 128886.5MB, Free 26234.2MB)
Server Config .....
 * 1 ..... Configured (Mounted, Active)
   Host ..... 10.37.74.1
   Username ..... root
   Path ..... /tftpboot/backups_from_controller-1
   Port ..... -
  2 ..... Configured (Unmounted)
   Host ..... 10.37.142.1
   Username ..... root
   Path ..... -
   Port ..... -
Current Action ..... Idle
Started ..... -
Current Node ..... -

Backup Redundancy ..... Enabled
  Local media ..... USB (Total 7604.0MB, Free 7544.0MB)
  State ..... Active

Area Name          Node Name          Id   Date           Time           Status
-----
Wellington         camry              1    14 Oct 2016    02:30:22      Good
Canterbury         corona             1    14 Oct 2016    02:30:23      Good
Canterbury         Avensis           1    14 Oct 2016    02:30:22      Good
Auckland           RAV4              1    14 Oct 2016    02:30:23      Good
Southland          MR2               1    14 Oct 2016    02:30:24      Good
    
```

- Related commands**
- [atmf backup area-masters enable](#)
  - [show atmf area](#)
  - [show atmf area nodes-detail](#)
  - [switchport atmf-arealink remote-area](#)

# show atmf backup guest

**Overview** This command displays backup status information of guest nodes in an AMF network. This command can only be run on a device configured as an AMF Master and has an AMF guest license.

**Syntax** `show atmf backup guest [<node-name>] [<guest-port>]] [logs]`

Parameter	Description
<i>&lt;node-name&gt;</i>	The name of parent guest node
<i>&lt;guest-port&gt;</i>	The port number on the parent node

**Mode** User Exec/Privileged Exec

**Example** On the switch named x930-master, to display information about the AMF backup guest status, use the command:

```
x930-master# show atmf backup guest
```

**Output** Figure 39-18: Example output from **show atmf backup guest**

```
x930-master#sh atmf backup guest
Guest Backup ..... Enabled
Scheduled Backup ..... Disabled
  Schedule ..... 1 per day starting at 03:00
  Next Backup Time ... 20 Jan 2016 03:00
Backup Bandwidth ..... Unlimited
Backup Media ..... FILE SERVER 2 (Total 655027.5MB,
                          Free 140191.5MB)

Server Config
  1 ..... Configured (Mounted)
  Host ..... 11.0.24.1
  Username ..... bob
  Path ..... guest-project
  Port ..... -
* 2 ..... Configured (Mounted, Active)
  Host ..... 11.0.24.1
  Username ..... bob
  Path ..... guest-project-second
  Port.....-
Current Action .....Idle
Started ..... -
Current Node ..... -
Backup Redundancy ...Enabled
Local media ..... USB (Total 7376.0MB, Free 7264.1MB)
State ..... Active
```



Parent Node Name	Port Name	Id	Date	Time	Status
x230	port1.0.4	2	19 Jan 2016	22:21:46	Good
		1	19 Jan 2016	22:21:46	Good
		USB	19 Jan 2016	22:21:46	Good

Table 39-1: Parameters in the output from **show atmf backup guest**

Parameter	Description
Guest Backup	The status of the guest node backup process
Scheduled Backup	The timing configured for guest backups.
Schedule	Displays the configured backup schedule.
Next Backup Time	The time the next backup process will be initiated.
Backup Bandwidth	The bandwidth limit applied to the backup data flow measured in kilo Bytes /second. Note that unlimited means there is no limit set specifically for the backup data flow.
Backup Media	Detail of the memory media used to store the backup files and the current memory capacity available.

- Related commands**
- show atmf backup area
  - show atmf backup
  - show atmf links guest
  - show atmf nodes
  - show atmf backup guest
  - atmf backup guests delete
  - atmf backup guests enable

# show atmf container

**Overview** Use this command to display information about the AMF containers created on a Virtual AMF Appliance (VAA).

An AMF container is an isolated instance of AlliedWare Plus with its own network interfaces, configuration, and file system. The features available inside an AMF container are a sub-set of the features available on the host VAA. These features enable the AMF container to function as a uniquely identifiable AMF master and allows for multiple tenants (up to 60) to run on a single VAA host. See the [AMF Feature Overview and Configuration Guide](#) for more information on running multiple tenants on a single VAA host.

**Syntax** `show atmf container [detail] [<container-name>]`

Parameter	Description
detail	Show detailed information.
<container-name>	The name of the AMF container you wish to display information for.

**Mode** Privileged Exec

**Output** Figure 39-19: Example output from **show atmf container**

```
awplus#show atmf container
ATMF Container Information:
  Container      Area      Bridge   State    Memory    CPU%
-----
  vac-wlg-1     wlg       br1      running  70.3 MB   1.2
  vac-akl-1     ak1       br2      stopped  0 bytes   0.0
  vac-nsn-1     nsn       br3      running  53.2 MB   0.7
Current ATMF Container count: 3
```

Figure 39-20: Example output from **show atmf container vac-wlg-1**

```
awplus#show atmf container vac-wlg-1
ATMF Container Information:
  Container      Area      Bridge   State    Memory    CPU%
-----
  vac-wlg-1     wlg       br1      running  70.3 MB   1.2
Current ATMF Container count: 1
```

Table 39-2: Parameters in the output from **show atmf container**

Parameter	Description
Container	Name of the AMF container.
Area	Name of the area the container is in.
Bridge	Name of the bridge connecting the container to the physical network.
State	Container state, <code>running</code> or <code>stopped</code> . This is set with the <code>state</code> command.
Memory	The amount of memory the container is using on the VAA host.
CPU%	The percentage of CPU time the container is using on the VAA, at the time the show command is run.

Figure 39-21: Example output from **show atmf container detail vac-wlg-1**

```
awplus#show atmf container detail vac-wlg-1

ATMF Container Information:

Name: vac-wlg-1
State: RUNNING
PID: 980
IP: 172.31.0.1
IP: 192.168.0.2
IP: fd00:4154:4d46:3c::1
CPU use: 3.95 seconds
Memory use: 67.07 MiB
Memory use: 0 bytes
Link: vethP31UFA
TX bytes: 166.01 KiB
RX bytes: 141.44 KiB
Total bytes: 307.45 KiB
Link: vethYCT7BB
TX bytes: 674.27 KiB
RX bytes: 698.27 KiB
Total bytes: 1.34 MiB
```

Table 39-3: Parameters in the output from **show atmf container detail**

Parameter	Description
Name	Name of the AMF container.
State	Container state, <code>RUNNING</code> or <code>STOPPED</code> . This is set with the <code>state</code> command.

Table 39-3: Parameters in the output from **show atmf container detail** (cont.)

Parameter	Description
PID	Internal container id.
IP	This lists the IP addresses used by the container. These include the eth1 IP address and the AMF management IP address.
CPU use	The CPU usage of the container since it was enabled.
Memory use	Container memory usage.
Link	Each container has two links: <ol style="list-style-type: none"><li>1 An AMF area-link, this connects the container to the AMF controller and uses virtual interface eth0 on the AMF container.</li><li>2 A bridged L2 network link, this connects the container to the outside world and uses the virtual interface eth1 on the AMF container.</li></ol> See the <a href="#">AMF Feature Overview and Configuration_Guide</a> for more information on these links.
TX/RX bytes	Bytes sent and received on a link.
Total bytes	Total bytes transferred on a link.

**Related commands**

[area-link](#)  
[atmf area](#)  
[atmf area password](#)  
[atmf container](#)  
[atmf container login](#)  
[bridge-group](#)  
[description \(amf-container\)](#)  
[state](#)

**Command changes**

Version 5.4.7-0.1: command added

# show atmf detail

**Overview** This command displays details about an AMF node. It can only be run on AMF master and controller nodes.

**Syntax** show atmf detail

Parameter	Description
detail	Displays output in greater depth.

**Mode** Privileged Exec

**Example 1** To display the AMF node1 information in detail, use the command:

```
controller-1# show atmf detail
```

A typical output screen from this command is shown below:

```
atmf-1#show atmf detail
ATMF Detail Information:

Network Name           : Test_network
Network Mtu           : 1300
Node Name              : controller-1
Node Address           : controller-1.atmf
Node ID               : 342
Node Depth             : 0
Domain State          : BackupDomainController
Recovery State        : None
Log Verbose Setting   : Verbose

Management VLAN
VLAN ID               : 4000
Management Subnet     : 172.31.0.0
Management IP Address : 172.31.1.86
Management Mask       : 255.255.128.0
Management IPv6 Address : fd00:4154:4d46:1::156
Management IPv6 Prefix Length : 64

Domain VLAN
VLAN ID               : 4091
Domain Subnet         : 172.31.128.0
Domain IP Address     : 172.31.129.86
Domain Mask           : 255.255.128.0
```

**Table 40:** Parameter definitions from the **show atmf detail** command

Parameter	Definition
Network MTU	The network MTU for the ATMF network.
Network Name	The AMF network that a particular node belongs to.
Node Name	The name assigned to a particular node.
Node Address	An Address used to access a remotely located node. This is simply the Node Name plus the dotted suffix atmf (.atmf).
Node ID	A Unique identifier assigned to a Node on an AMF network.
Node Depth	The number of nodes in path from this node to level of the AMF root node. It can be thought of as the vertical depth of the AMF network from a particular node to the zero level of the AMF root node.
Domain State	The state of Node in a Domain in AMF network as Controller/Backup.
Recovery State	The AMF node recovery status. Indicates whether a node recovery is in progress on this device - Auto, Manual, or None.
Management VLAN	The VLAN created for traffic between Nodes of different domain (up/down links). <ul style="list-style-type: none"> <li>• VLAN ID - In this example VLAN 4092 is configured as the Management VLAN.</li> <li>• Management Subnet - Network prefix for the subnet.</li> <li>• Management IP Address - The IP address allocated for this traffic.</li> <li>• Management Mask - The subnet mask used to create a subnet for this traffic (255.255.128.0).</li> </ul>
Domain VLAN	The VLAN assigned for traffic between Nodes of same domain (crosslink). <ul style="list-style-type: none"> <li>• VLAN ID - In this example VLAN 4091 is configured as the domain VLAN.</li> <li>• Domain Subnet. The subnet address used for this traffic.</li> <li>• Domain IP Address. The IP address allocated for this traffic.</li> <li>• Domain Mask. The subnet mask used to create a subnet for this traffic (255.255.128.0).</li> </ul>
Node Depth	The number of nodes in the path from this node to the Core domain.

# show atmf group

**Overview** This command can be used to display the group membership within to a particular AMF node. It can also be used with the working-set command to display group membership within a working set.

Each node in the AMF is automatically added to the group that is appropriate to its hardware architecture, e.g. x510, x230. Nodes that are configured as masters are automatically assigned to the master group.

You can create arbitrary groups of AMF members based on your own selection criteria. You can then assign commands collectively to any of these groups.

**Syntax** `show atmf group [user-defined|automatic]`

Parameter	Description
<code>user-defined</code>	User-defined-group information display.
<code>automatic</code>	Automatic group information display.

**Default** All groups are displayed

**Mode** Privileged Exec

**Example 1** To display group membership of node2, use the following command:

```
node2# show atmf group
```

A typical output screen from this command is shown below:

```
ATMF group information

master, x510

node2#
```

This screen shows that node2 contains the groups **master** and **x510**. Note that although the node also contains the implicit groups, these do not appear in the show output.

**Example 2** The following commands (entered on *node2*) will display all the automatic groups within the working set containing *node1* and all nodes that have been pre-defined to contain the *sysadmin* group:

First define the working-set:

```
node1# #atmf working-set node1 group sysadmin
```

A typical output screen from this command is shown below:

```

ATMF group information

master, poe, x8100

=====
node1, node2, node3, node4, node5, node6:
=====

ATMF group information

sysadmin, x8100

AMF_NETWORK[6]#
    
```

This confirms that the six nodes (*node1* to *node6*) are now members of the working-set and that these nodes reside within the *AMF-NETWORK*.

Note that to run this command, you must have previously entered the command [atmf working-set](#) on page 1527. This can be seen from the network level prompt, which in this case is *AMF\_NETWORK[6]#*.

**Table 41:** Sample output from the **show atmf group** command for a working set.

```

AMF_NETWORK[6]#show atmf group
=====
node3, node4, node5, node6:
=====

ATMF group information

edge_switches, x510
    
```

**Table 42:** Parameter definitions from the **show atmf group** command for a working set

Parameter	Definition
ATMF group information	Displays a list of nodes and the groups that they belong to, for example: <ul style="list-style-type: none"> <li>• master - Shows a common group name for Nodes configured as AMF masters.</li> <li>• Hardware Arch - Shows a group for all Nodes sharing a common Hardware architecture, e.g. x8100, x230, for example.</li> <li>• User-defined - Arbitrary groups created by the user for AMF nodes.</li> </ul>



# show atmf group members

**Overview** This command will display all group memberships within an AMF working-set. Each node in the AMF working set is automatically added to automatic groups which are defined by hardware architecture, e.g. x510, x230. Nodes that are configured as masters are automatically assigned to the master group. Users can define arbitrary groupings of AMF members based on their own criteria, which can be used to select groups of nodes.

**Syntax** `show atmf group members [user-defined|automatic]`

Parameter	Description
user-defined	User defined group membership display.
automatic	Automatic group membership display.

**Mode** Privileged Exec

**Example** To display group membership of all nodes in a working-set, use the command:

```
ATMF_NETWORK[9]# show atmf group members
```

**Table 43:** Sample output from the **show atmf group members** command

```
ATMF Group membership
Automatic          Total
Groups            Members  Members
-----
master            1         Building_1
poe               1         HW_Team1
x510              3         SW_Team1 SW_Team2 SW_Team3
x930              1         HW_Team1
x8100             2         Building_1 Building_2

ATMF Group membership
User-defined       Total
Groups            Members  Members
-----
marketing         1         Bld1_Floor_1
software          3         SW_Team1 SW_Team2 SW_Team3
```

**Table 44:** Parameter definitions from the **show atmf group members** command

Parameter	Definition
Automatic Groups	Lists the Automatic Groups and their nodal composition. The sample output shows AMF nodes based on the same Hardware type or belonging to the same Master group.
User-defined Groups	Shows the grouping of AMF nodes in user defined groups.
Total Members	Shows the total number of members in each group.
Members	Shows the list of AMF nodes in each group.

**Related commands**

- [show atmf group](#)
- [show atmf](#)
- [atmf group \(membership\)](#)

# show atmf guests

**Overview** This command is available on any AMF master or controller in the network. It displays a summary of the AMF guest nodes that exist in the AMF network, including device type, parent node, and IP address.

**Syntax** show atmf guests

**Mode** User Exec/Privileged Exec

**Usage notes** Use this command to display all guest nodes in a network. If you want to see only the guests attached to a single node, use the [show atmf links guest](#) command, which shows information about the guest nodes and also about their link to their parent node.

**Example** To display the AMF guest output, use the command:

```
awplus# show atmf guests
```

**Output** Figure 39-22: Example output from the **show atmf guests** command

```
master#show atmf guests

Guest Information:

Device      Device      Parent      Guest      IP/IPv6
Name        Type        Node        Port        Address
-----
node1-2.0.1 x600-24Ts   node1       2.0.1       192.168.2.10
wireless-zone1 AT-TQ4600   node2       1.0.1       192.168.1.10
wireless-zone2 AT-TQ4600   node2       1.0.2       192.168.1.12

Current ATMF guest node count 3
```

**Table 45:** Parameters shown in the output of the **show atmf guests** command

Parameter	Description
Device Name	The name that is discovered from the device, or failing that, a name that is auto-assigned by AMF. The auto-assigned name consists of: <parent node name>-<attached port number> You can change this by configuring a description on the port.
Device Type	The product name of the guest node, which is discovered from the device. If no device type can be discovered, this shows the name of the AMF guest-class that has been assigned to the guest node by the <a href="#">atmf guest-class</a> command.

**Table 45:** Parameters shown in the output of the **show atmf guests** command

Parameter	Description
Parent Node	The name of the AMF node that directly connects to the guest node.
Guest Port	The port on the parent node that directly connects to the guest node.
IP/IPv6 Address	The address discovered from the node, or statically configured on the parent node's attached port.

**Related  
commands**

[atmf guest-class](#)  
[switchport atmf-guestlink](#)  
[show atmf backup guest](#)  
[show atmf links guest](#)

# show atmf guests detail

**Overview** This command is available on any AMF master in the network. It displays details about the AMF guest nodes that exist in the AMF network, such as device type, IP address, MAC address etc.

**Syntax** `show atmf guests detail [<node-name>] [<guest-port>]`

Parameter	Description
<code>&lt;node-name&gt;</code>	The name of the guest node's parent.
<code>&lt;guest-port&gt;</code>	The port name on the parent node.

**Mode** User Exec/Privileged Exec

**Usage notes** If you want to see only the guests attached to a single node, you can use either:

- this command and specify the node name, or
- [show atmf links guest detail](#), which shows information about the guest nodes and also about their link to their parent node.

Note that the parameters that are displayed depend on the guest node's model.

**Example** To display the AMF guest output, use the command:

```
awplus# show atmf guests detail
```

**Output** Figure 39-23: Example output from **show atmf guests detail**

```
master#show atmf guests detail

ATMF Guest Node Information:

Node Name           : master
Port Name           : port1.0.9
Ifindex             : 5009
Guest Description   : red-1.0.9
Device Type         : x600-24Ts
Backup Supported    : No
MAC Address         : 0000.cd38.0c4d
IP Address          : 192.168.1.5
IPv6 Address        : Not Set
HTTP Port           : 0
Firmware Version    : 5.4.2-0.1
```

Node Name	: node1
Port Name	: port1.0.13
Ifindex	: 5013
Guest Description	: node1-1.0.13
Device Type	: AT-TQ4600
Backup Supported	: Yes
MAC Address	: ecd.6df2.daa0
IP Address	: 192.168.5.6
IPv6 Address	: Not Set
HTTP Port	: 80
Firmware Version	: 3.1.0 B01

**Table 46:** Parameters in the output from **show atmf guests detail**.

Parameter	Description
Node Name	The name of the parent node, which is the AMF node that directly connects to the guest node.
Port Name	The port on the parent node that connects to the guest.
IfIndex	An internal index number that maps to the port number on the parent node.
Guest Description	A description that is discovered from the device, or failing that, auto-assigned by AMF. The auto-assigned name consists of: <parent node name>-<attached port number>. You can change this by configuring a description on the port.
Device Type	The product name of the guest node, which is discovered from the device. If no device type can be discovered, this shows the name of the AMF guest-class that has been assigned to the guest node by the <a href="#">atmf guest-class</a> command.
Username	The user name configured on the guest node.
Backup Supported	Whether the guest node supports AMF backup functionality.
MAC Address	The MAC address of the guest node.
IP Address	The IP address of the guest node.
IPv6 Address	The IPv6 address of the guest node.
Firmware Version	The version of the firmware operating on the guest node.
HTTP port	The HTTP port as specified with the <a href="#">http-enable</a> command when defining a guest class. You can set this if the guest node provides an HTTP user interface on a non-standard port (any port other than port 80).

**Related  
commands**    [atmf guest-class](#)  
                  [switchport atmf-guestlink](#)  
                  [show atmf backup guest](#)

# show atmf links

**Overview** This command displays information about AMF links on a switch. The display output contains link status state information.

**Syntax** `show atmf links [brief]`

Parameter	Description
brief	A brief summary of AMF links, their configuration and status.

**Mode** User Exec and Privileged Exec

**Usage notes** The **show atmf links** and **show atmf links brief** commands both produce a table of summarized link information. For a more detailed view use the [show atmf links detail](#) command.

This command does not show links that are configured on provisioned ports.

**Example** To display a brief summary of the AMF links, use the following command:

```
node-1# show atmf links brief
```

Figure 39-24: Example output from **show atmf links brief**

```
Example-core# show atmf links
ATMF Link Brief Information:
Local   Link   Link   ATMF   Adjacent   Adjacent   Link
Port   Type   Status State   Node       Ifindex    State
-----
1.0.10  Crosslink Down   Init   *crosslink1 -          Blocking
1.0.14  Crosslink Down   Init   *crosslink2 -          Blocking
1.0.1   Downlink Down   Init   -         -          Blocking
1.0.2   Downlink Up     Full   Node2    5001      Forwarding
1.0.8   Downlink Up     Full   downlink1 5001      Forwarding

* = Provisioned.
```

Table 39-1: Parameter in the output from **show atmf links brief**

Parameter	Definition
Local Port	Shows the local port on the selected node.
Link Type	Shows link type as Uplink or Downlink (parent and child) or Cross-link (nodes in same domain).
Link Status	Shows the link status of the local port on the node as either Up or Down.



Table 39-1: Parameter in the output from **show atmf links brief** (cont.)

Parameter	Definition
ATMF State	Shows AMF state of the local port: <ul style="list-style-type: none"> <li>• Init - Link is down.</li> <li>• Hold - Link transitioned to up state, but waiting for hold period to ensure link is stable.</li> <li>• Incompatible - Neighbor rejected the link because of inconsistency in AMF configurations.</li> <li>• OneWay - Link is up and has waited the hold down period and now attempting to link to another unit in another domain.</li> <li>• OneWaySim - Device is running in secure mode and link is up but waiting for authorization from an AMF master.</li> <li>• Full - Link hello packets are sent and received from its neighbor with its own node id.</li> <li>• Shutdown - Link has been shut down by user configuration.</li> </ul>
Adjacent Node	Shows the Adjacent AMF Node to the one being configured.
Adjacent IF Index	Shows the IF index for the Adjacent AMF Node connected to the node being configured.
Link State	Shows the state of the AMF link. Valid states are either Forwarding or Blocking.

For information on filtering and saving command output, see the [“Getting Started with AlliedWare\\_Plus” Feature Overview and Configuration Guide](#).

- Related commands**
- no debug all
  - clear atmf links statistics
  - show atmf
  - show atmf links detail
  - show atmf links guest
  - show atmf links guest detail
  - show atmf links statistics
  - show atmf nodes

# show atmf links detail

**Overview** This command displays detailed information on all the links configured in the AMF network. It can only be run on AMF master and controller nodes.

**Syntax** `show atmf links detail`

Parameter	Description
detail	Detailed AMF links information.

**Mode** User Exec

**Usage notes** For summarized link information see the [show atmf links](#) command.  
This command does not show links that are configured on provisioned ports.

**Example** To display the AMF link details use this command:

```
device1# show atmf links detail
```

The output from this command will display all the internal data held for AMF links. The following example gives details of the links that are summarized in the example in [show atmf links](#).

**Table 40:** Sample output from the **show atmf links detail** command

```
device1# show atmf links detail
-----
Crosslink Ports Information
-----
Port                : sa1
Ifindex             : 4501
Port Status         : Down
Port State          : Init
Last event          :
Port BPDU Receive Count : 0
Port                : po10
Ifindex             : 4610
Port Status         : Up
Port State          : Full
Last event          : AdjNodeLSEPresent
Port BPDU Receive Count : 140
Adjacent Node Name  : Building-B
Adjacent Ifindex    : 4610
Adjacent MAC        : eccd.6ddl.64d0
Port Last Message Response : 0
```

**Table 40:** Sample output from the **show atmf links detail** command (cont.)

```

Port : po30
Ifindex : 4630
Port Status : Up
Port State : Full
Last event : AdjNodeLSEPresent
Port BPDU Receive Count : 132
Adjacent Node Name : Building-A
Adjacent Ifindex : 4630
Adjacent MAC : eccd.6daa.c861
Port Last Message Response : 0

Link State Entries:

Crosslink Ports Blocking : False
Node.Ifindex : Building-A.4630 - Example-core.4630
Transaction ID : 2 - 2
MAC Address : eccd.6daa.c861 - 0000.cd37.054b
Link State : Full - Full

Node.Ifindex : Building-B.4610 - Example-core.4610
Transaction ID : 2 - 2
MAC Address : eccd.6ddl.64d0 - 0000.cd37.054b
Link State : Full - Full

Domain Nodes Tree:

Node : Building-A
  Links on Node : 1
  Link 0 : Building-A.4630 - Example-core.4630
  Forwarding State : Forwarding
Node : Building-B
  Links on Node : 1
  Link 0 : Building-B.4610 - Example-core.4610
  Forwarding State : Forwarding
Node : Example-core
  Links on Node : 2
  Link 0 : Building-A.4630 - Example-core.4630
  Forwarding State : Forwarding
  Link 1 : Building-B.4610 - Example-core.4610
  Forwarding State : Forwarding

Crosslink Transaction Entries:

Node : Building-B
Transaction ID : 2
Uplink Transaction ID : 6
Node : Building-A
Transaction ID : 2
Uplink Transaction ID : 6

Uplink Information:

Waiting for Sync : 0
Transaction ID : 6
Number of Links : 0
Number of Local Uplinks : 0
  
```

**Table 40:** Sample output from the **show atmf links detail** command (cont.)

```

Originating Node      : Building-A
Domain                : -'s domain
Node                  : Building-A
Ifindex               : 0
Node Depth            : 0
Transaction ID        : 6
Flags                 : 32
Domain Controller     : -
Domain Controller MAC : 0000.0000.0000

Originating Node      : Building-B
Domain                : -'s domain
Node                  : Building-B
Ifindex               : 0
Node Depth            : 0
Transaction ID        : 6
Flags                 : 32
Domain Controller     : -
Domain Controller MAC : 0000.0000.0000

Downlink Domain Information:

Domain                : Dept-A's domain
  Domain Controller    : Dept-A
  Domain Controller MAC : eccd.6d20.c1d9
  Number of Links      : 2
  Number of Links Up   : 2
  Number of Links on This Node : 2
  Links are Blocked    : 0
  Node Transaction List
    Node                : Building-B
    Transaction ID      : 8
    Node                : Building-A
    Transaction ID      : 8
  Domain List
    Domain              : Dept-A's domain
    Node                : Example-core
    Ifindex             : 4621
    Transaction ID      : 8
    Flags               : 1
    Domain              : Dept-A's domain
    Node                : Example-core
    Ifindex             : 4622
    Transaction ID      : 8
    Flags               : 1
  
```

**Table 40:** Sample output from the **show atmf links detail** command (cont.)

```

Domain : Dorm-D's domain
  Domain Controller : Dorm-D
  Domain Controller MAC : 0000.cd37.082c
  Number of Links : 2
  Number of Links Up : 2
  Number of Links on This Node : 2
  Links are Blocked : 0
  Node Transaction List
    Node : Building-B
    Transaction ID : 20
    Node : Building-A
    Transaction ID : 20
  Domain List
    Domain : Dorm-D's domain
    Node : Building-A
    Ifindex : 0
    Transaction ID : 20
    Flags : 32
    Domain : Dorm-D's domain
    Node : Building-B
    Ifindex : 0
    Transaction ID : 20
    Flags : 32
    Domain : Dorm-D's domain
    Node : Example-core
    Ifindex : 4510
    Transaction ID : 20
    Flags : 1
    Domain : Dorm-D's domain
    Node : Example-core
    Ifindex : 4520
    Transaction ID : 20
    Flags : 1

Domain : Example-edge's domain
  Domain Controller : Example-edge
  Domain Controller MAC : 001a.eb93.7aa6
  Number of Links : 1
  Number of Links Up : 1
  Number of Links on This Node : 0
  Links are Blocked : 0
  Node Transaction List
    Node : Building-B
    Transaction ID : 9
    Node : Building-A
    Transaction ID : 9
  
```

**Table 40:** Sample output from the **show atmf links detail** command (cont.)

```

Domain List
  Domain          : Example-edge's domain
  Node            : Building-A
  Ifindex         : 0
  Transaction ID  : 9
  Flags           : 32
  Domain          : Example-edge's domain
  Node            : Building-B
  Ifindex         : 5027
  Transaction ID  : 9
  Flags           : 1
-----
Up/Downlink Ports Information
-----
Port              : sa10
Ifindex           : 4510
Port Status       : Up
Port State        : Full
Last event        : LinkComplete
Adjacent Node     : Dorm-A
Adjacent Internal ID : 211
Adjacent Ifindex  : 4510
Adjacent Board ID : 387
Adjacent MAC      : eccd.6ddf.6cdf
Adjacent Domain Controller : Dorm-D
Adjacent Domain Controller MAC : 0000.cd37.082c
Port Forwarding State : Forwarding
Port BPDU Receive Count : 95
Port Sequence Number : 11
Port Adjacent Sequence Number : 7
Port Last Message Response : 0
Port              : po21
Ifindex           : 4621
Port Status       : Up
Port State        : Full
Last event        : LinkComplete
Adjacent Node     : Dept-A
Adjacent Internal ID : 29
Adjacent Ifindex  : 4621
Adjacent Board ID : 340
Adjacent MAC      : eccd.6d20.c1d9
Adjacent Domain Controller : Dept-A
Adjacent Domain Controller MAC : eccd.6d20.c1d9
Port Forwarding State : Forwarding
Port BPDU Receive Count : 96
Port Sequence Number : 8
Port Adjacent Sequence Number : 9
Port Last Message Response : 0
Special Link Present : FALSE
  
```

**Table 41:** Parameter definitions from the **show atmf links detail** command output

Parameter	Definition
Crosslink Ports Information	<p>Show details of all Crosslink ports on this Node:</p> <ul style="list-style-type: none"> <li>• Port - Name of the Port or static aggregation (sa&lt;*&gt;).</li> <li>• Ifindex - Interface index for the crosslink port.</li> <li>• VR ID - Virtual router id for the crosslink port.</li> <li>• Port Status - Status of the local port on the Node as UP or DOWN.</li> <li>• Port State - AMF State of the local port.               <ul style="list-style-type: none"> <li>– Init - Link is down.</li> <li>– Hold - Link transitioned to up state, but waiting for hold period to ensure link is stable.</li> <li>– Incompatible - Neighbor rejected the link because of inconsistency in AMF configurations.</li> <li>– OneWay - Link is up and has waited the hold down period and now attempting to link to another unit in another domain</li> <li>– Full - Link hello packets are sent and received from its neighbor with its own node id.</li> <li>– Shutdown - Link has been shut down by user configuration.</li> </ul> </li> </ul> <p>Port BPDU Receive Count - The number of AMF protocol PDU's received.</p> <ul style="list-style-type: none"> <li>• Adjacent Node Name - The name of the adjacent node connected to this node.</li> <li>• Adjacent Ifindex - Adjacent AMF Node connected to this Node.</li> <li>• Adjacent VR ID - Virtual router id of the adjacent node in the domain.</li> <li>• Adjacent MAC - MAC address of the adjacent node in the domain.</li> <li>• Port Last Message Response - Response from the remote neighbor to our AMF last hello packet.</li> </ul>
Link State Entries	<p>Shows all the link state database entries:</p> <ul style="list-style-type: none"> <li>• Node.Ifindex - Shows adjacent Node names and Interface index.</li> <li>• Transaction ID - Shows transaction id of the current crosslink transaction.</li> <li>• MAC Address - Shows adjacent Node MAC addresses.</li> <li>• Link State - Shows AMF states of adjacent nodes on the link.</li> </ul>
Domain Nodes Tree	<p>Shows all the nodes in the domain:</p> <ul style="list-style-type: none"> <li>• Node - Name of the node in the domain.</li> <li>• Links on Node - Number of crosslinks on a vertex/node.</li> <li>• Link no - Shows adjacent Node names and Interface index.</li> <li>• Forwarding State - Shows state of AMF link Forwarding/Blocking.</li> </ul>
Crosslink Transaction Entries	<p>Shows all the transaction entries:</p> <ul style="list-style-type: none"> <li>• Node - Name of the AMF node.</li> <li>• Transaction ID - transaction id of the node.</li> <li>• Uplink Transaction ID - transaction id of the remote node.</li> </ul>

**Table 41:** Parameter definitions from the **show atmf links detail** command output (cont.)

Parameter	Definition
Uplink Information	<p>Show all uplink entries.</p> <ul style="list-style-type: none"> <li>• Waiting for Sync - Flag if uplinks are currently waiting for synchronization.</li> <li>• Transaction ID - Shows transaction id of the local node.</li> <li>• Number of Links - Number of up downlinks in the domain.</li> <li>• Number of Local Uplinks - Number of uplinks on this node to the parent domain.</li> <li>• Originating Node - Node originating the uplink information.</li> <li>• Domain - Name of the parent uplink domain.</li> <li>• Node - Name of the node in the parent domain, that is connected to the current domain.</li> <li>• Ifindex - Interface index of the parent node's link to the current domain.</li> <li>• VR ID - Virtual router id of the parent node's link to the current domain.</li> <li>• Transaction ID - Transaction identifier for the neighbor in crosslink.</li> <li>• Flags - Used in domain messages to exchange the state:                      ATMF_DOMAIN_FLAG_DOWN = 0                      ATMF_DOMAIN_FLAG_UP = 1                      ATMF_DOMAIN_FLAG_BLOCK = 2                      ATMF_DOMAIN_FLAG_NOT_PRESENT = 4                      ATMF_DOMAIN_FLAG_NO_NODE = 8                      ATMF_DOMAIN_FLAG_NOT_ACTIVE_PARENT = 16                      ATMF_DOMAIN_FLAG_NOT_LINKS = 32                      ATMF_DOMAIN_FLAG_NO_CONFIG = 64</li> <li>• Domain Controller - Domain Controller in the uplink domain</li> <li>• Domain Controller MAC - MAC address of Domain Controller in uplink domain</li> </ul>
Downlink Domain Information	<p>Shows all the downlink entries:</p> <ul style="list-style-type: none"> <li>• Domain - Name of the downlink domain.</li> <li>• Domain Controller - Controller of the downlink domain.</li> <li>• Domain Controller MAC - MAC address of the domain controller.</li> <li>• Number of Links - Total number of links to this domain from the Node.</li> <li>• Number of Links Up - Total number of links that are in UP state.</li> <li>• Number of Links on This Node - Number of links terminating on this node.</li> <li>• Links are Blocked - 0 links are not blocked to the domain. 1 All links are blocked to the domain.</li> </ul>



**Table 41:** Parameter definitions from the **show atmf links detail** command output (cont.)

Parameter	Definition
Node Transaction List	<p>List of transactions from this downlink domain node.</p> <ul style="list-style-type: none"> <li>• Node - 0 links are not blocked to the domain. 1 All links are blocked to the domain.</li> <li>• Transaction ID - Transaction id for this node.</li> <li>• Domain List: Shows list of nodes in the current domain and their links to the downlink domain.:</li> <li>• Domain - Domain name of the downlink node.</li> <li>• Node - Name of the node in the current domain.</li> <li>• Ifindex - Interface index for the link from the node to the downlink domain.</li> <li>• Transaction ID - Transaction id of the node in the current domain.</li> <li>• Flags - As mentioned above.</li> </ul>
Up/Downlink Ports Information	<p>Shows all the configured up and down link ports on this node:</p> <ul style="list-style-type: none"> <li>• Port - Name of the local port.</li> <li>• Ifindex - Interface index of the local port.</li> <li>• VR ID - Virtual router id for the local port.</li> <li>• Port Status - Shows status of the local port on the Node as UP/DOWN.</li> <li>• Port State - AMF state of the local port.</li> <li>• Adjacent Node - nodename of the adjacent node.</li> <li>• Adjacent Internal ID - Unique node identifier of the remote node.</li> <li>• Adjacent Ifindex - Interface index for the port of adjacent AMF node.</li> <li>• Adjacent Board ID - Product identifier for the adjacent node.</li> <li>• Adjacent VR ID - Virtual router id for the port on adjacent AMF node.</li> <li>• Adjacent MAC - MAC address for the port on adjacent AMF node.</li> <li>• Adjacent Domain Controller - nodename of the Domain controller for Adjacent AMF node.</li> <li>• Adjacent Domain Controller MAC - MAC address of the Domain controller for Adjacent AMF node.</li> <li>• Port Forwarding State - Local port forwarding state Forwarding or Blocking.</li> <li>• Port BPDU Receive Count - count of AMF protocol PDU's received.</li> <li>• Port Sequence Number - hello sequence number, incremented every time the data in the hello packet changes.</li> <li>• Port Adjacent Sequence Number - remote ends sequence number used to check if we need to process this packet or just note it arrived.</li> <li>• Port Last Message Response - response from the remote neighbor to our last hello packet.</li> </ul>

For information on filtering and saving command output, see the [“Getting Started with AlliedWare Plus” Feature Overview and Configuration Guide](#).

**Related commands** no debug all  
clear atmf links statistics  
show atmf

# show atmf links guest

**Overview** This command displays information about guest nodes visible to an AMF device.

**Syntax** `show atmf links guest [interface <interface-range>]`

Parameter	Description
interface <interface-range>	Select a specific range of ports to display information about guest nodes.

**Default** With no parameters specified this command will display its standard output for all ports with guest nodes connected.

**Mode** User Exec/Privileged Exec

**Usage notes** Use this command to display the guest nodes connected to a single parent node. If you want to see a list of all the guests in the AMF network, use [show atmf guests](#).

**Example 1** To display information about AMF guests that are connectible from node1, use the command:

```
node1# show atmf links guest
```

**Output** Figure 39-25: Example output from **show atmf links guest**

```
node1#sh atmf links guest

Guest Link Information:

DC = Discovery configuration
   S = static D = dynamic

Local   Guest      Model      MAC      IP / IPv6
Port    Class       Type       DC Address Address
-----
1.0.1   -           other      D 0013.1a1e.4589 192.168.1.2
1.0.2   aastra-phone other      D 0008.5d10.7635 192.168.1.3
1.0.3   cisco-phone2 other      S -              192.168.2.1
1.0.4   panasonic... other      D 0800.239e.f1fe 192.168.1.5
```

Table 39-1: Parameters in the output from **show atmf links guest**

Parameter	Description
Local Port	The port on the parent node that connects to the guest.
Guest Class	The name of the ATMF guest-class that has been assigned to the guest node by the <a href="#">atmf guest-class</a> command.

Table 39-1: Parameters in the output from **show atmf links guest** (cont.)

Parameter	Description
Model Type	The model type of the guest node, as entered by the <code>modeltype</code> command. Can be one of the following: <ul style="list-style-type: none"><li>• alliedware</li><li>• aw+</li><li>• tq</li><li>• other</li></ul>
DC	The discovery method as applied by the <code>discovery</code> command. This can be either dynamic (D) or static (S).
MAC Address	The MAC address of the guest node.
IP / IPv6 Address	The IP address of the guest node.

**Related commands**

- `atmf guest-class`
- `discovery`
- `http-enable`
- `username`
- `modeltype`
- `switchport atmf-guestlink`
- `show atmf backup guest`

# show atmf links guest detail

**Overview** This command displays detailed information about guest nodes visible to an AMF device.

**Syntax** `show atmf links guest detail [interface <interface-range>]`

Parameter	Description
interface <interface-range>	Select a specific range of ports to display information about guest nodes.

**Mode** User Exec/Privileged Exec

**Usage notes** Use this command to display the guest nodes connected to a single parent node. If you want to see a list of all the guests in the AMF network, use [show atmf guests detail](#).

Note that the parameters that are displayed depend on the guest node's model and state.

**Example** To display detailed information about AMF guests, use the command:

```
node1# show atmf links guest detail
```

**Output** Figure 39-26: Example output from **show atmf links guest detail**

```
node1#show atmf links guest detail

Detailed Guest Link Information:

Interface : port1.0.13
Link State : Down
Class Name : test
Model Type : Other
Discovery Method : Static
IP Address : 192.168.1.13
Node State : Down

Interface : port1.0.17
Link State : Full
Class Name : access
Model Type : TQ
Discovery Method : Dynamic
IP Address : 192.168.5.8
Username : manager
Node State : Full
Backup Supported : Yes
MAC address : 001a.ebad.ce60
Device Type : AT-TQ3400
Description : node1-1.0.17
Firmware Version : 3.2.1 A02
```

Table 39-2: Parameters in the output from **show atmf links guest detail**

Parameter	Description
Interface	The port on the parent node that connects to the guest.
Link State	The state of the link to the guest node; one of: <ul style="list-style-type: none"> <li>• Down: The physical link is down.</li> <li>• Up: The physical link has come up, but it is still during a timeout period that is enforced to allow other links to come up.</li> <li>• Learn: The timeout period described above has elapsed, and the link is now learning information from the AMF guest node. You can see what information it is learning from the "Node State" field below.</li> <li>• Full: The node connected by this link has joined the AMF network.</li> <li>• Fail: The port is physically up but something has prevented the guest node from joining the AMF network.</li> </ul>
Class Name	The name of the ATMF guest-class that has been assigned to the guest node by the <code>atmf guest-class</code> command.
Model Type	The model type of the guest node, as entered by the <code>modeltype</code> command. Can be one of the following: <ul style="list-style-type: none"> <li>• alliedware</li> <li>• aw+</li> <li>• onvif</li> <li>• tq</li> <li>• other</li> </ul>
Discovery Method	The discovery method as applied by the <code>discovery</code> command. This can be either dynamic or static.
IP Address	The IP address of the guest node.
Username	The user name configured on the guest node.

Table 39-2: Parameters in the output from **show atmf links guest detail** (cont.)

Parameter	Description
Node state	<p>The state of the guest node; one of:</p> <ul style="list-style-type: none"> <li>• Down: The initial state when a link to a guest node is first configured. This is also the state if the physical link goes down.</li> <li>• Getting IP: The AMF device is in the process of retrieving the IP address of the guest node.</li> <li>• Getting Mac: The AMF device is in the process of retrieving the MAC address of the guest node.</li> <li>• Getting Info: The AMF device is in the process of retrieving any other available information from the guest (firmware version etc). The information available depends on what device the guest node is.</li> <li>• Full: The AMF device has retrieved all necessary information and the guest node has joined the AMF network. Once this state is reached, the Link State also changes to "Full".</li> <li>• Failure: The physical link is up but the AMF member has failed to retrieve enough information to allow the guest node to join the AMF network.</li> </ul>
Backup Supported	Whether the guest node supports AMF backup functionality.
MAC Address	The MAC address of the guest node.
Device Type	Model information for the guest node. This field shows the model information that AMF retrieved from the guest node. In contrast, the Model Type shows what a user entered as the type of device they intended this guest node to be.
Description	By default, this is a concatenation of the guest node's parent node and the port to which it is attached. You can change it by configuring a description on the port.
Serial Number	The serial number of the guest node.
Firmware Name	The name of the firmware operating on the guest node.
Firmware Version	The version of the firmware operating on the guest node.
HTTP port	The HTTP port as specified with the <a href="#">http-enable</a> command when defining a guest class. You can set this if the guest node provides an HTTP user interface on a non-standard port (any port other than port 80).

**Related commands**

- [atmf guest-class](#)
- [discovery](#)
- [http-enable](#)

username  
modeltype  
switchport atmf-guestlink  
show atmf backup guest



# show atmf links statistics

**Overview** This command displays details of the AMF links configured on the device and also displays statistics about the AMF packet exchanges between the devices.

It is also possible to display the AMF link configuration and packet exchange statistics for a specified interface.

This command can only be run on AMF master and controller nodes

**Syntax** `show atmf links statistics [interface [<port-number>]]`

Parameter	Description
interface	Specifies that the command applies to a specific interface (port) or range of ports. Where both the interface and port number are unspecified, full statistics (not just those relating to ports) will be displayed.
<port-number>	Enter the port number for which statistics are required. A port range, a static channel or LACP link can also be specified. Where no port number is specified, statistics will be displayed for all ports on the device.

**Mode** User Exec

**Example 1** To display AMF link statistics for the whole device, use the command:

```
device1# show atmf links statistics
```

**Table 40:** Sample output from the **show atmf links statistics** command

ATMF Statistics:		
	Receive	Transmit
-----	-----	-----
Arealink Hello	318	327
Crosslink Hello	164	167
Crosslink Hello Domain	89	92
Crosslink Hello Uplink	86	88
Hello Link	0	0
Hello Neighbor	628	630
Hello Stack	0	0
Hello Gateway	1257	1257
Database Description	28	28
Database Request	8	6
Database Update	66	162
Database Update Bitmap	0	29
Database Acknowledge	144	51

**Table 40:** Sample output from the **show atmf links statistics** command (cont.)

```

Transmit Fails          0          1
Discards                0          0
Total ATMF Packets     2788      2837

ATMF Database Statistics:

Database Entries        18
Database Full Ages     0
ATMF Virtual Link Statistics:

Virtual                Receive      Receive      Transmit      Transmit
link                  Receive      Dropped      Transmit      Dropped
-----
vlink2000             393         0            417          0

ATMF Packet Discards:
Type0  0      : Gateway hello msg received from unexpected neighbor
Type1  0      : Stack hello msg received from unexpected neighbor
Type2  0      : Discard TX update bitmap packet - bad checksum
Type3  0      : Discard TX update packet - neighbor not in correct state
Type4  0      : Discard update packet - bad checksum or type
Type5  0      : Discard update packet - neighbor not in correct state
Type6  0      : Discard update bitmap packet - bad checksum or type
Type7  0      : Incarnation is not possible with the data received
Type8  0      : Discard crosslink hello received - not correct state
Type9  0      : Discard crosslink domain hello received on non crosslink
Type10 0      : Discard crosslink domain hello - not in correct state
Type11 0      : Crosslink uplink hello received on non crosslink port
Type12 0      : Discard crosslink uplink hello - not in correct state
Type13 0      : Wrong network-name for this ATMF
Type14 0      : Packet received on port is too long
Type15 0      : Bad protocol version, received on port
Type16 0      : Bad packet checksum calculation
Type17 0      : Bad authentication type
Type18 0      : Bad simple password
Type19 0      : Unsupported authentication type
Type20 0      : Discard packet - unknown neighbor
Type21 0      : Discard packet - port is shutdown
Type22 0      : Non broadcast hello msg received from unexpected neighbor
Type23 0      : Arealink hello msg received on non arealink port
Type24 0      : Discard arealink hello packet - not in correct state
Type25 0      : Discard arealink hello packet - failed basic processing
Type26 0      : Discard unicast packet - MAC address does not match node
Type27 0      : AMF Master license node limit exceeded
    
```

**Example 2** To display the AMF links statistics on interface port1.0.4, use the command:

```
device1# show atmf links statistics interface port1.0.4
```

Figure 39-27: Sample output from the **show atmf links statistics** command for interface port1.0.4

```
device1# show atmf links statistics interface port1.0.4

ATMF Port Statistics:

-----
port1.0.4  Crosslink Hello           231      232
port1.0.4  Crosslink Hello Domain     116      116
port1.0.4  Crosslink Hello Uplink     116      115
port1.0.4  Hello Link                  0         0
port1.0.4  Arealink Hello              0         0
```

Figure 39-28: Parameter definitions from the **show atmf links statistics** command output

Parameter	Definition
Receive	Shows a count of AMF protocol packets received per message type.
Transmit	Shows the number of AMF protocol packets transmitted per message type.
Database Entries	Shows the number of AMF elements existing in the distributed database.
Database Full Ages	Shows the number of times the entries aged in the database.
ATMF Packet Discards	Shows the number of discarded packets of each type.

For information on filtering and saving command output, see the [“Getting Started with AlliedWare Plus” Feature Overview and Configuration Guide](#).

- Related commands**
- no debug all
  - clear atmf links statistics
  - show atmf

# show atmf nodes

**Overview** This command displays nodes currently configured within the AMF network.

Note that the output also tells you whether or not node map exchange is active. Node map exchange improves the tracking of nodes joining and leaving an AMF network. This improves the efficiency of AMF networks. Node map exchange is only available if every node in your AMF network is running version 5.4.6-2.1 or later. We recommend running the latest version on all nodes in your network, so you receive the advantages of node map exchange and other improvements.

**Syntax** `show atmf nodes [guest|all]`

Parameter	Description
guest	Display only guest nodes in the AMF network.
all	Display all nodes in the AMF network, including guest nodes.

**Mode** Privileged Exec

**Usage notes** You can use this command to display one of three sets of nodes:

- all nodes except guest nodes, by specifying **show atmf nodes**
- all nodes including guest nodes, by specifying **show atmf nodes all**
- only guest nodes, by specifying **show atmf nodes guest**

**Examples** To display AMF information for all nodes except guest nodes, use the command:

```
node1# show atmf nodes
```

Table 39-1: Sample output from **show atmf nodes**

```
node1#show atmf nodes guest

Node Information:

* = Local device

SC = Switch Configuration:
C = Chassis   S = Stackable   N = Standalone

Node          Device          ATMF          Parent          Node
Name         Type            Master  SC    Domain          Depth
-----
* M1          x510-28GTX      Y         S     none            0
N3           x230-18GP       N         N     M1              1
N1           AR4050S         N         N     M1              1

Node map exchange is active
Current ATMF node count 3
```

To display AMF information for all nodes, including guest nodes, use the command:

```
node1# show atmf nodes all
```

**Table 40:** Sample output from **show atmf nodes all**. In this example, not all nodes support node map exchange, as shown by the message at the end

```
node1#show atmf nodes all

Node and Guest Information:

* = Local device

SC = Switch Configuration:
C = Chassis  S = Stackable  N = Standalone G = Guest

Node/Guest      Device          ATMF          Parent          Node
Name            Type            Master SC    Domain          Depth
-----
* M1             x510-28GTX     Y      S    none           0
N3              x230-18GP     N      N    M1             1
N1              AR4050S       N      N    M1             1
N3-1.0.24       AT-TQ4600     N      G    N3             -

Node map exchange is inactive
Firmware on some nodes does not support node map exchange, eg AR4050S
Current ATMF node count 4 (guests 1)
```

To display AMF information for guest nodes only, use the command:

```
node1# show atmf nodes guest
```

**Table 39-1:** Sample output from **show atmf nodes guest**

```
node1#show atmf nodes guest

Guest Information:
Device      MAC
Name        Address      Parent          Port          IP/IPv6
Address
-----
aastra-...  0008.5d10.7635 Node-1          1.0.2         192.168.4.7
poe-1.0.1   0013.1a1e.4589 Node-1          1.0.1         192.168.4.6
ip-camera   0800.239e.f1fe Node-1          1.0.4         192.168.4.8
tq4600      eccd.6df2.da60 Node-1          1.0.5         192.168.4.50
```

- Related commands**
- [show atmf](#)
  - [show atmf area nodes](#)
  - [discovery](#)
  - [http-enable](#)
  - [show atmf backup guest](#)

# show atmf provision nodes

**Overview** This command displays information about each provisioned node with details about date and time of creation, boot and configuration files available in the backup, and license files present in the provisioned backup. This includes nodes that have joined the network but are yet to run their first backup.

This command can only be run on AMF master and controller nodes.

**Syntax** `show atmf provision nodes`

**Mode** Privileged Exec

**Usage notes** This command will only work if provisioned nodes have already been set up. Otherwise, an error message is shown when the command is run.

**Example** To show the details of all the provisioned nodes in the backup use the command:

```
NodeName# show atmf provision nodes
```

Figure 39-29: Sample output from the **show atmf provision nodes** command

```
device1#show atmf provision nodes

ATMF Provisioned Node Information:

Backup Media .....: SD (Total 3827.0MB, Free 3481.1MB)

Node Name           : device2
Date& Time          : 06-Oct-2016 & 23:25:44
Provision Path      : card:/atmf/provision_nodes

Boot configuration :
Current boot image  : x510-5.4.9-0.1.rel (file exists)
Backup boot image   : x510-5.4.8-2.3.rel (file exists)
Default boot config : flash:/default.cfg (file exists)
Current boot config : flash:/abc.cfg (file exists)
Backup boot config  : flash:/xyz.cfg (file exists)

Software Licenses :
Repository file     : ../configs/.sw_v2.lic
                   : ../configs/.swfeature.lic
Certificate file    : card:/atmf/nodes/awplus1/flash/.atmf-lic-cert
```

- Related commands**
- [atmf provision \(interface\)](#)
  - [atmf provision node](#)
  - [clone \(amf-provision\)](#)
  - [configure boot config \(amf-provision\)](#)
  - [configure boot system \(amf-provision\)](#)
  - [create \(amf-provision\)](#)

delete (amf-provision)  
identity (amf-provision)  
license-cert (amf-provision)  
locate (amf-provision)

# show atmf recovery-file

**Overview** Use this command to display the recovery file information for an AMF node. AMF recovery files are created for nodes with special links. Special links include:

- virtual links,
- area links terminating on an AMF master, and
- area virtual links terminating on an AMF master.

**Syntax** `show atmf recovery-file`

**Mode** Privileged Exec

**Example** To display recovery file information for an AMF node, use the command:

```
node1# show atmf recovery-file
```

**Output** Figure 39-30: Example output from **show atmf recovery-file**

```
node1#show atmf recovery-file

ATMF Recovery File Info: Special Link Present
Location                               Date           Time
USB storage device                     30 Apr 2018   14:50:32
Master                                  30 Apr 2018   14:56:45
node1                                    30 Apr 2018   14:56:45
node3                                    30 Apr 2018   14:56:45
```

**Related commands** [clear atmf recovery-file](#)  
[show atmf backup](#)

**Command changes** Version 5.4.8-0.2: command added



# show atmf secure-mode

**Overview** Use this command to display an overview of the secure mode status of an AMF network.

**Syntax** show atmf secure-mode

**Mode** Privileged Exec

**Example** To display an overview of AMF secure mode on an AMF master or member node, use the command:

```
awplus# show atmf secure-mode
```

**Output** Figure 39-31: Example output from **show atmf secure-mode** on an AMF master

```
ATMF Secure Mode:

Secure Mode Status           : Enabled
Certificate Expiry           : 180 Days
Certificates Total            : 8
Certificates Revoked          : 0
Certificates Rejected         : 0
Certificates Active          : 8

Provisional Authorization    : 0
Pending Requests             : 0

Trusted Master                : master_1
Trusted Master                : master_2

Key Fingerprint:
 48:37:d9:a0:37:32:22:9b:5c:22:da:a2:62:49:a7:e5:a9:bc:12:88
```

Figure 39-32: Example output from **show atmf secure-mode** on an AMF node

```
ATMF Secure Mode:

Secure Mode Status           : Enabled
Trusted Master                : master_1
Trusted Master                : master_2

Key Fingerprint:
 93:f0:52:a9:74:8f:ae:ea:5b:e2:ee:62:cb:6b:21:22:5a:08:db:98
```

Table 39-2: Parameters in the output from **show atmf secure-mode**

Parameter	Description
Secure Mode Status	Shows the status of secure mode, Enabled or Disabled.
Certificate Expiry	Certificate expiry time. Set with <a href="#">atmf secure-mode certificate expiry</a>
Certificates Total	Total number of certificates.
Certificates Revoked	Certificates that have been revoked by the AMF master.
Certificates Rejected	Certificates that have been rejected by the AMF master.
Certificates Active	Certificates that are currently active.
Provisional Authorization	Number of nodes with provisional authorization. For more information use the <a href="#">show atmf authorization provisional</a> command.
Pending Requests	Number of nodes waiting for authorization on the AMF master. For more information use the <a href="#">show atmf authorization pending</a> command.
Trusted Master	List of trusted masters in the AMF area.
Key Fingerprint	The AMF node's key fingerprint.

**Related commands**

- [atmf authorize](#)
- [atmf secure-mode](#)
- [atmf secure-mode certificate expiry](#)
- [show atmf authorization](#)
- [show atmf secure-mode audit link](#)

**Command changes**

Version 5.4.7-0.3: command added

# show atmf secure-mode audit

**Overview** Use this command to detect security vulnerabilities on a node.

**Syntax** show atmf secure-mode audit

**Mode** Privileged Exec

**Example** To display AMF secure mode link audits for a node, use the command  
awplus# show atmf secure-mode audit

**Output** Figure 39-33: Example output from **show atmf secure-mode audit**

```
ATMF Secure Mode Audit:

Warning   : The default username and password is enabled.
Good      : SNMP V1 or V2 is disabled.
Warning   : Telnet server is enabled.
Good      : ATMF is enabled. Secure-Mode is on.
Good      : ATMF Topology-GUI is disabled. No trustpoints configured.

ATMF Secure Mode Log Events:

-----
2017 Feb 2 00:59:25 user.notice node1 ATMF[848]: Sec_Audit - ATMF Secure
Mode is enabled.
2017 Feb 2 01:30:00 user.notice node1 ATMF[848]: Sec_Audit - Established
secure connection to area_1_node_1 on interface vlink1.
```

Table 39-3: Parameters in the output from **show atmf secure-mode audit link**

Parameter	Description
ATMF Secure Mode Audit	A list of security recommendations to secure the AMF network. Items prefaced with <code>Warning</code> need to be fixed. In the sample above the default username and password, and telnet, should be disabled.
ATMF Secure Mode Log Events	A list of recorded secure mode log events.

**Related commands** [show atmf secure-mode](#)

**Command changes** Version 5.4.7-0.3: command added

# show atmf secure-mode audit link

**Overview** Use this command to detect security vulnerabilities by identifying devices that are connected to a secure mode node that are not in secure mode or are not authorized.

**Syntax** `show atmf secure-mode audit link`

**Mode** Privileged Exec

**Example** To display AMF secure mode link audits for a node, use the command  
`awplus# show atmf secure-mode audit link`

**Output** Figure 39-34: Example output from **show atmf secure-mode audit link**

```
ATMF Secure Mode Audit Link:

* ATMF links connected to devices which are not authorized
  or are not in secure-mode.

Port          Link Type   Discovered          Node/Area Name
-----
vlink1       Downlink   16/02/2017 09:28:22 Member3
```

Table 39-4: Parameters in the output from **show atmf secure-mode audit link**

Parameter	Description
Port	Port name on local device.
Link Type	Link type.
Discovered	Date discovered
Node/Area Name	Node or area name of remote device.

**Related commands** [show atmf](#)  
[show atmf secure-mode](#)

**Command changes** Version 5.4.7-0.3: command added

# show atmf secure-mode certificates

**Overview** Use this command to display the certificate status details when secure mode is enabled on an AMF network.

**Syntax** `show atmf secure-mode certificates [detail] [area <area-name>] [node <node-name>]`

Parameter	Description
detail	Display detailed certificate information.
area	Specify an AMF area.
<area-name>	The AMF area you want to see the certificate information for.
node	Specify an AMF node.
<node-name>	The AMF node you want to see information for.

**Mode** Privileged Exec

**Example** To display AMF secure mode certificates on a master or member node, use the command:

```
awplus# show atmf secure-mode certificates
```

To display detailed information about AMF secure mode certificates for a node named "area\_2\_node\_1" in an area named "area-2", use the command:

```
awplus# show atmf secure-mode certificates detail area area-2 node area_2_node_1
```

**Output** Figure 39-35: Example output from **show atmf secure-mode certificates**

```
Area-1 Certificates:
Node Name          Signer             Expires            Status
-----
area_1_node_1     master_1           11 Mar 2017
                  master_2           4 Mar 2017        Active
area_1_node_2     master_1           11 Mar 2017
                  master_2           4 Mar 2017        Revoked

Area-2 Certificates:
Node Name          Signer             Expires            Status
-----
area_2_node_1     master_1           18 Mar 2017        Active
area_2_node_2     master_1           18 Mar 2017        Rejected
```

Table 39-5: Parameters in the output from **show atmf secure-mode certificates**

Parameter	Description
Node Name	Name of AMF node the certificate was issued to.
Signer	Name of AMF master that issued the certificate.
Expires	Certificate expiry date.
Status	The status column will display <i>Active</i> before a member node is trusted, and can be accessed using AMF commands. Valid statuses are <i>Active</i> , <i>Revoked</i> , and <i>Rejected</i> .

**Output** Figure 39-36: Example output from **show atmf secure-mode certificates detail area area-2 node area\_2\_node\_1**

```
Certificates Detail:
-----
area_2_node_1 (area:area-2)
  MAC Address      : 0000.cd37.0003
  Status           : Active
  Serial Number    : A24SC8001
  Product          : x510-28GTX
  Key Fingerprint  : cd:b4:c9:cd:7b:87:6a:30:98:25:d7:3c:89:8e:cb:74:e8:91:56:9d
  Flags            : 00000011
  Signer           : master_1
  Expiry Date      : 18 Mar 2017 21:17:42
```

Table 39-6: Parameters in the output from **show atmf secure-mode certificates detail**

Parameter	Description
MAC Address	MAC address of AMF node.
Status	The device status will show <i>Active</i> if a member node is trusted, and can be accessed using AMF commands. Valid statuses are <i>Active</i> , <i>Revoked</i> , and <i>Rejected</i> .
Serial Number	Device serial number.
Product	Device product type.
Key Fingerprint	AMF node key fingerprint.
Flags	Internal AMF information.
Signer	Name of AMF master that issued the certificate.
Expiry Date	Certificate expiry date.

**Related commands**

- atmf authorize
- atmf secure-mode
- atmf secure-mode certificate expire
- atmf secure-mode certificate renew
- clear atmf secure-mode certificates
- show atmf secure-mode sa

**Command changes** Version 5.4.7-0.3: command added

# show atmf secure-mode sa

**Overview** Use this command to display the security associations on the network. This is the list of links and neighbors that are trusted.

**Syntax** `show atmf secure-mode sa [detail] [link|neighbor|broadcast]`

Parameter	Description
detail	Display detailed security association information.
link	Display security associations for type links.
neighbor	Display security associations for type neighbors.
broadcast	Display security associations for type broadcast.

**Mode** Privileged Exec

**Example** To display an overview of AMF secure mode security associations on a master or member node, use the command:

```
awplus# show atmf secure-mode sa
```

To display a detailed overview of AMF secure mode neighbor security associations on a master or member node, use the command:

```
awplus# show atmf secure-mode sa detail neighbor
```

**Output** Figure 39-37: Example output from **show atmf secure-mode sa**

```
ATMF Security Associations:
```

Type	State	ID	Details
Neighbor Node	Complete	175	master_1
Broadcast	Complete	4095	
CrossLink	Complete	4501	sa1
AreaLink	Cert Exchg	4511	sa11
Link	Complete	6009	port1.2.9
AreaLink	CA Exchg Init	6013	port1.2.13
AreaLink	Cert Exchg	13001	port1.9.1
Link	CA Exchg Init	16779521	vlink3
Neighbor Gateway	Complete	83	master_2
Neighbor Gateway	Complete	175	master_1
Neighbor Cntl-Master	Complete	83	master_2
Neighbor Cntl-Master	Complete	175	master_1



Figure 39-38: Example output from **show atmf secure-mode sa detail neighbor**

```
Security Associations Detail:
-----
Id           : 175 (af)
  Type       : Neighbor Node
  State      : Complete
  Remote MAC Address : eccd.6d82.6c16
  Flags      : 000003c0

Id           : 83 (40000053)
  Type       : Neighbor Gateway
  State      : Complete
  Remote MAC Address : 001a.eb54.e53b
  Flags      : 000003c0

Id           : 175 (400000af)
  Type       : Neighbor Gateway
  State      : Complete
  Remote MAC Address : eccd.6d82.6c16
  Flags      : 000003c0

Id           : 83 (80000053)
  Type       : Neighbor Cntl-Master
  State      : Complete
  Remote MAC Address : 001a.eb54.e53b
  Flags      : 000003c0

Id           : 175 (800000af)
  Type       : Neighbor Cntl-Master
  State      : Complete
  Remote MAC Address : eccd.6d82.6c16
  Flags      : 000003c0

Id           : 321 (80000141)
  Type       : Neighbor Cntl-Master
  State      : Complete
  Remote MAC Address : 0000.f427.93da
  Flags      : 000003c0
```

Table 39-7: Parameters in the output from **show atmf secure-mode sa**

Parameter	Description
Type	Security Association (SA) types: <ul style="list-style-type: none"> <li>• Link - SA for link</li> <li>• CrossLink - SA for crosslink</li> <li>• AreaLink - SA for area link</li> <li>• Neighbor Node - SA for node neighbor relationship</li> <li>• Neighbor Gateway - SA for gateway neighbor relationship</li> <li>• Neighbor Cntl-Master - SA for controller/master neighbor relationship</li> <li>• Broadcast - SA for working-set broadcast requests</li> </ul>
State	Current state of the Security Association. The state must be Complete before a member node is trusted, and can be accessed using AMF commands. <ul style="list-style-type: none"> <li>• CA Exchg Init - SA is ready to begin the SA exchange process</li> <li>• CA Exchg - SA is currently exchanging CAs</li> <li>• Cert Exchg - SA is currently exchanging certificates</li> <li>• Key Exchg - SA is currently exchanging ephemeral keys</li> <li>• Complete - SA exchange has completed</li> </ul>
ID	Security Association ID. <ul style="list-style-type: none"> <li>• For Neighbor types this is the remote node ID.</li> <li>• For Link types this is the local ifindex.</li> <li>• For Broadcast type this is always 4095.</li> </ul>
Details	Human readable translation of ID. <ul style="list-style-type: none"> <li>• For Neighbor types this is the node name</li> <li>• For Link types this is the interface name</li> </ul>
Remote MAC Address	MAC address of the remote partner of the security association.
Flags	Internal AMF information.

**Related commands**

- [atmf secure-mode](#)
- [show atmf secure-mode](#)
- [show atmf secure-mode certificates](#)

**Command changes**

Version 5.4.7-0.3: command added

# show atmf secure-mode statistics

**Overview** Use this command to display AMF secure mode statistics. These statistics are from when AMF secure mode was first enabled or the statistics were cleared with the `clear atmf secure-mode statistics` command.

**Syntax** `show atmf secure-mode statistics`

**Mode** Privileged Exec

**Example** To display AMF secure mode statistics on a master or member node, use the command:

```
awplus# show atmf secure-mode statistics
```

**Output** Figure 39-39: Example output from `show atmf secure-mode statistics` on an AMF master.

```
ATMF Secure Mode Statistics:

Certificates:
New ..... 7                Expired ..... 0
Updated ..... 7            Deleted ..... 0
Revoked ..... 1           Renewed ..... 2
Rejected ..... 1          Re-authorized .... 1
Authorized ..... 0

Local Certificates:
Valid ..... 4                Invalid ..... 0
Certificates Validation:
Request Valid ..... 2
Request Invalid ..... 0
Common Valid ..... 13
Common Invalid ..... 0
Issuer Valid ..... 14
Issuer Invalid ..... 0
Signature Verified ..... 29
Signature Invalid ..... 0
Signature Purpose Invalid ..... 0

Signatures Signed ..... 12
Master Certificates:
Re-issued ..... 3
Downgraded to member ..... 0

Public key change ..... 2
Invalid SA public key ..... 0
```

**Output** Figure 39-40: Example output from **show atmf secure-mode statistics** on an AMF node.

```
ATMF Secure Mode Statistics:

Local Certificates:
Valid ..... 3          Invalid ..... 0

Certificates Validation:
Request Valid ..... 0
Request Invalid ..... 0
Common Valid ..... 0
Common Invalid ..... 0
Issuer Valid ..... 12
Issuer Invalid ..... 0
Signature Verified ..... 12
Signature Invalid ..... 3
Signature Purpose Invalid ..... 0

Signatures Signed ..... 0

Master Certificates:
Re-issued ..... 0
Downgraded to member ..... 0

Public key change ..... 2
Invalid SA public key ..... 0
```

- Related commands**
- [atmf authorize](#)
  - [atmf secure-mode](#)
  - [atmf secure-mode certificate renew](#)
  - [clear atmf secure-mode statistics](#)
  - [show atmf secure-mode](#)

**Command changes** Version 5.4.7-0.3: command added

# show atmf tech

**Overview** This command collects and displays all the AMF command output. The command can thus be used to display a complete picture of an AMF network.

**Syntax** show atmf tech

**Mode** Privileged Exec

**Example** To display output for all AMF commands, use the command:

```
NodeName# show atmf tech
```

**Table 40:** Sample output from the **show atmf tech** command.

```
node1#show atmf tech
ATMF Summary Information:

ATMF Status           : Enabled
Network Name          : ATMF_NET
Node Name              : node1
Role                   : Master
Current ATMF Nodes    : 8

ATMF Technical information:

Network Name           : ATMF_NET
Domain                 : node1's domain
Node Depth             : 0
Domain Flags           : 0
Authentication Type    : 0
MAC Address            : 0014.2299.137d
Board ID               : 287
Domain State           : DomainController
Domain Controller      : node1
Backup Domain Controller : node2
Domain controller MAC  : 0014.2299.137d
Parent Domain          : -
Parent Domain Controller : -
Parent Domain Controller MAC : 0000.0000.0000
Number of Domain Events : 0
Crosslink Ports Blocking : 0
Uplink Ports Waiting on Sync : 0
```

**Table 40:** Sample output from the **show atmf tech** command. (cont.)

Crosslink Sequence Number	: 7
Domains Sequence Number	: 28
Uplink Sequence Number	: 2
Number of Crosslink Ports	: 1
Number of Domain Nodes	: 2
Number of Neighbors	: 5
Number of Non Broadcast Neighbors	: 3
Number of Link State Entries	: 1
Number of Up Uplinks	: 0
Number of Up Uplinks on This Node	: 0
DBE Checksum	: 84fc6
Number of DBE Entries	: 0
...	

**Table 41:** Parameter definitions from the **show atmf tech** command

Parameter	Definition
ATMF Status	Shows status of AMF feature on the Node as Enabled/Disabled.
Network Name	The name of the AMF network to which this node belongs.
Node Name	The name assigned to the node within the AMF network.
Role	The role configured on the device within the AMF - either master or member.
Current ATMF Nodes	A count of the AMF nodes in the AMF network.
Node Address	The identity of a node (in the format name.atmf) that enables its access it from a remote location.
Node ID	A unique identifier assigned to an AMF node.
Node Depth	The number of nodes in the path from this node to the core domain.
Domain State	A node's state within an AMF Domain - either controller or backup.
Recovery State	The AMF node recovery status. Indicates whether a node recovery is in progress on this device - either Auto, Manual, or None.
Management VLAN	The VLAN created for traffic between nodes of different domains (up/down links). VLAN ID - In this example VLAN 4092 is configured as the Management VLAN. Management Subnet - the Network prefix for the subnet. Management IP Address - the IP address allocated for this traffic. Management Mask - the Netmask used to create a subnet for this traffic 255.255.128.0 (= prefix /17)

**Table 41:** Parameter definitions from the **show atmf tech** command (cont.)

Parameter	Definition
Domain VLAN	The VLAN assigned for traffic between Nodes of same domain (crosslink). VLAN ID - In this example VLAN 4091 is configured as the domain VLAN. Domain Subnet - the Subnet address used for this traffic. Domain IP Address - the IP address allocated for this traffic. Domain Mask - the Netmask used to create a subnet for this traffic 255.255.128.0 (= prefix /17)
Device Type	Shows the Product Series Name.
ATMF Master	Indicates the node's membership of the core domain (membership is indicated by Y)
SC	Shows switch configuration: <ul style="list-style-type: none"><li>• C - Chassis (such as SBx8100 series)</li><li>• S - Stackable (VCS)</li><li>• N - Standalone</li></ul>
Parent	A node that is connected to the present node's uplink, i.e. one layer higher in the hierarchy.
Node Depth	Shows the number of nodes in path from the current node to the Core domain.

**NOTE:** The **show atmf tech** command can produce very large output. For this reason only the most significant terms are defined in this table.

# show atmf virtual-links

**Overview** This command displays a summary of all virtual links (L2TP tunnels) currently in the running configuration.

**Syntax** `show atmf virtual-links [macaddr]`

Parameter	Description
macaddr	Display the virtual AMF links' MAC addresses.

**Mode** Privileged Exec

**Example 1** To display AMF virtual links, use the command:

```
node_1# show atmf virtual-links
```

Table 39-1: Example output from **show atmf virtual-links**

```
ATMF Link Remote Information:

Local      Local      Remote      Tunnel      Tunnel
Port      ID   IP          ID   IP          Protect     State
-----
vlink1    1    172.16.24.2  2    1.0.0.2     -           Complete
vlink2    2    172.16.24.2* 10   172.16.24.3* ipsec       Complete
vlink3    3    (eth0)*      1    1.2.3.4     -           AcquireLocal

* = Dynamic Address.

Virtual Links Configured: 3
```

In the above example, a centrally located switch has the IP address space 192.0.2.x/24. It has two VLANs assigned the subnets 192.0.2.33 and 192.0.2.65 using the prefix /27. Each subnet connects to a virtual link. The first link has the IP address 192.168.1.1 and has a Local ID of 1. The second has the IP address 192.168.2.1 and has the Local ID of 2.

**Example 2** To display AMF virtual links' MAC address information, use the command:

```
node_1# show atmf virtual-links macaddr
```



Table 39-2: Example output from **show atmf virtual-links macaddr**

```

ATMF Link Remote Information:

ATMF Management Bridge Information:

Bridge: br-atmfmgmt

port no mac addr                is local?    ageing timer
  1      00:00:cd:27:c2:07        yes          0.00
  2      8e:c7:ae:81:7e:68        yes          0.00
  2      00:00:cd:28:bf:e7        no           0.01
    
```

Table 39-3: Parameters in the output from **show atmf virtual-links**

Parameter	Definition
vlink1	The tunnel named vlink1, equivalent to an L2TP tunnel.
Local ID	The local ID of the virtual link. This matches the vlink<number>
State	The operational state of the vlink (either Up or Down). This state is always displayed once a vlink has been created.
mac addr	AMF virtual links terminate on an internal soft bridge. The “show atmf virtual-links macaddress” command displays MAC Address information.
is local?	Indicates whether the MAC displayed is for a local or a remote device.
ageing timer	Indicates the current aging state for each MAC address.

**Related commands** [atmf virtual-link](#)

# show atmf working-set

**Overview** This command displays the nodes that form the current AMF working-set.

**Syntax** `show atmf working-set`

**Mode** Privileged Exec

**Example** To show current members of the working-set, use the command:

```
ATMF_NETWORK[6]# show atmf working-set
```

**Table 40:** Sample output from the **show atmf working-set** command.

```
ATMF Working Set Nodes:
node1, node2, node3, node4, node5, node6
Working set contains 6 nodes
```

**Related commands**

- [atmf working-set](#)
- [show atmf](#)
- [show atmf group](#)

# show debugging atmf

**Overview** Use this command to see what debugging is turned on for AMF.  
For information on filtering and saving command output, see the [“Getting Started with AlliedWare Plus” Feature Overview and Configuration Guide](#).

**Syntax** `show debugging atmf`

**Mode** Privileged Exec

**Example** To display the AMF debugging status, use the command:

```
node_1# show debugging atmf
```

Table 39-1: Sample output from the **show debugging atmf** command.

```
node_1# show debugging atmf
ATMF debugging status:
ATMF arealink debugging is on
ATMF link debugging is on
ATMF crosslink debugging is on
ATMF database debugging is on
ATMF neighbor debugging is on
ATMF packet debugging is on
ATMF error debugging is on
```

**Related commands** [debug atmf packet](#)

# show debugging atmf packet

**Overview** Use this command to see what debugging is turned on for AMF Packet debug. For information on filtering and saving command output, see the [“Getting Started with AlliedWare Plus” Feature Overview and Configuration Guide](#).

**Syntax** show debugging atmf packet

**Mode** User Exec and Privileged Exec

**Example** To display the AMF packet debugging status, use the command:

```
node_1# show debug atmf packet
```

Table 39-2: Sample output from the **show debugging atmf packet** command.

```
ATMF packet debugging is on
=== ATMF Packet Debugging Parameters===
Node Name: x908
Port name: port1.1.1
Limit: 500 packets
Direction: TX
Info Level: Level 2
Packet Type Bitmap:
2. Crosslink Hello BPDU pkt with downlink domain info
3. Crosslink Hello BPDU pkt with uplink info
4. Down and up link Hello BPDU pkts
6. Stack hello unicast pkts
8. DBE request
9. DBE update
10. DBE bitmap update
```

**Related commands** [debug atmf](#)  
[debug atmf packet](#)

# show running-config atmf

**Overview** This command displays the running system information that is specific to AMF.

**Syntax** `show running-config atmf`

**Mode** User Exec and Global Configuration

**Example** To display the current configuration of AMF, use the following commands:

```
node_1# show running-config atmf
```

For information on filtering and saving command output, see the [“Getting Started with AlliedWare Plus” Feature Overview and Configuration Guide](#).

**Related commands** `show running-config`  
`no debug all`

# state

**Overview** This command sets the running state of an AMF container on a Virtual AMF Appliance (VAA).

An AMF container is an isolated instance of AlliedWare Plus with its own network interfaces, configuration, and file system. The features available inside an AMF container are a sub-set of the features available on the host VAA. These features enable the AMF container to function as a uniquely identifiable AMF master and allows for multiple tenants (up to 60) to run on a single VAA host. See the [AMF Feature Overview and Configuration Guide](#) for more information on running multiple tenants on a single VAA host.

**Syntax** `state {enable|disable}`

Parameter	Description
disable	Stop the AMF container. The container's state changes to stopped.
enable	Start the AMF container. The container's state changes to running.

**Default** By default, **state** is disabled.

**Mode** AMF Container Configuration

**Usage notes** The first time the **state enable** command is executed on a container it assigns the container to an area and configures it as an AMF master. This is achieved by automatically adding the following configuration to the AMF container:

```
atmf network-name <AMF network-name>
atmf master
atmf area <container area-name> <container area-id> local
atmf area <container area-name> password <container area-password>
atmf area <host area-name> <host area-id>

interface eth0
  atmf-arealink remote-area <host area-name> vlan 4094
```

For this reason the **state enable** command should be run after the container has been created with the `atmf container` command and an area-link configured with the `area-link` command.

Once the start-up configuration has been saved from within the AMF container, all further configuration changes need to be made manually.

**Example** To start the AMF container “vac-wlg-1” use the commands:

```
awplus# configure terminal
awplus(config)# atmf container vac-wlg-1
awplus(config-atmf-container)# state enable
```

To stop the AMF container “vac-wlg-1” use the commands:

```
awplus# configure terminal
awplus(config)# atmf container vac-wlg-1
awplus(config-atmf-container)# state disable
```

**Related commands** [atmf container](#)  
[show atmf container](#)

**Command changes** Version 5.4.7-0.1: command added

# switchport atmf-agentlink

**Overview** Use this command to configure a link between this device and an x600 Series switch, in order to integrate the x600 Series switch into your AMF network. The x600 Series switch is called an “AMF agent”, and the link between the x600 and this device is called an “agent link”.

The x600 Series switch must be running version 5.4.2-3.16 or later.

Use the **no** variant of this command to remove the agent link. If the x600 Series switch is still connected to the switch port, it will no longer be part of the AMF network.

**Syntax** `switchport atmf-agentlink`  
`no switchport atmf-agentlink`

**Default** By default, no agent links exist and x600 Series switches are not visible to AMF networks.

**Mode** Interface mode for a switch port. Note that the link between the x600 and the AMF network must be a single link, not an aggregated link.

**Usage notes** The x600 Series switch provides the following information to the AMF node that it is connected to:

- The MAC address
- The IPv4 address
- The IPv6 address
- The name/type of the device (Allied Telesis x600)
- The name of the current firmware
- The version of the current firmware
- The configuration name

AMF guestnode also makes most of this information available from x600 Series switches, but requires configuration with DHCP and/or LLDP. AMF agent is simpler; as soon the x600 is connected to an appropriately configured port of an AMF node, it is immediately integrated into the AMF network.

To see information about the x600 Series switch, use the **show atmf links guest detail** command.

**Example** To configure port1.0.1 as an agent link, use the commands:

```
awplus# configure terminal
awplus(config)# interface port1.0.1
awplus(config-if)# switchport atmf-agentlink
```

**Related commands** [show atmf links guest](#)



# switchport atmf-arealink remote-area

**Overview** This command enables you to configure a port or aggregator to be an AMF arealink. AMF arealinks are designed to operate between two nodes in different areas in an AMF network.

Use the **no** variant of this command to remove any AMF-arealink that may exist for the selected port or aggregated link.

This command is only available on AMF controllers and master nodes.

**Syntax** `switchport atmf-arealink remote-area <area-name> vlan <2-4094>`  
`no switchport atmf-arealink`

Parameter	Description
<area-name>	The name of the remote area that the port is connecting to.
<2-4094>	The VLAN ID for the link. This VLAN cannot be used for any other purpose, and the same VLAN ID must be used at each end of the link.

**Default** By default, no arealinks are configured

**Mode** Interface Configuration for a switchport, a static aggregator or a dynamic channel group.

**Usage notes** Run this command on the port or aggregator at both ends of the link.

Each area must have the area-name configured, and the same area password must exist on both ends of the link.

Running this command will automatically place the port or static aggregator into trunk mode (i.e. switchport mode trunk) and will synchronize the area information stored on the two nodes.

You can configure multiple arealinks between two area nodes, but only one arealink at any time will be in use. All other arealinks will block information, to prevent network storms.

**Example** To make switchport port1.0.2 an arealink to the *Auckland* area on VLAN 6, use the following commands

```
controller-1# configure terminal
controller-1(config)# interface port1.0.2
controller-1(config-if)# switchport atmf-arealink remote-area
Auckland vlan 6
```

**Related  
commands** [atmf area](#)  
[atmf area password](#)  
[atmf virtual-link](#)  
[show atmf links](#)

# switchport atmf-crosslink

**Overview** This command configures the selected port, statically aggregated link or dynamic channel group (LACP) to be an AMF crosslink. Running this command will automatically place the port or aggregator into trunk mode (i.e. **switchport mode trunk**).

The connection between two AMF masters must utilize a crosslink. Crosslinks are used to carry the AMF control information between master nodes. Multiple crosslinks can be configured between two master nodes, but only one crosslink can be active at any particular time. All other crosslinks between masters will be placed in the blocking state, in order to prevent broadcast storms.

Use the **no** variant of this command to remove any crosslink that may exist for the selected port or aggregated link.

**Syntax** `switchport atmf-crosslink`  
`no switchport atmf-crosslink`

**Mode** Interface Configuration for a switchport, a static aggregator or a dynamic channel group.

**Usage notes** Crosslinks can be used anywhere within an AMF network. They have the effect of separating the AMF network into separate domains.

Where this command is used, it is also good practice to use the **switchport trunk native vlan** command with the parameter **none** selected. This is to prevent a network storm on a topology of ring connected devices.

**Example 1** To make switchport port1.0.1 an AMF crosslink, use the following commands:

```
Node_1# configure terminal
Node_1(config)# interface port1.0.1
Node_1(config-if)# switchport atmf-crosslink
```

**Example 2** This example is shown twice. Example 2A is the most basic command sequence. Example 2B is a good practice equivalent that avoids problems such as broadcast storms that can otherwise occur.

**Example 2A** To make static aggregator sa1 an AMF crosslink, use the following commands:

```
Node_1# configure terminal
Node_1(config)# interface sa1
Node_1(config-if)# switchport atmf-crosslink
```

**Example 2B** To make static aggregator sa1 an AMF crosslink, use the following commands for good practice:

```
Node_1# configure terminal
Node_1(config)# interface sa1
Node_1(config-if)# switchport atmf-crosslink
Node_1(config-if)# switchport trunk allowed vlan add 2
Node_1(config-if)# switchport trunk native vlan none
```

In this example VLAN 2 is assigned to the static aggregator, and the native VLAN (VLAN 1) is explicitly excluded from the aggregated ports and the crosslink assigned to it.

**NOTE:** *The AMF management and domain VLANs are automatically added to the aggregator and the crosslink.*

**Related commands** [show atmf links statistics](#)

# switchport atmf-guestlink

**Overview** Guest links are used to provide basic AMF functionality to non AMF capable devices. Guest links can be configured for either a selected switch port or a range of switch ports and use generic protocols to collect status and configuration information that the guest devices make available.

Use the **no** variant of this command to remove the guest node functionality from the selected port or ports.

**NOTE:** AMF guest nodes are not supported on ports using the OpenFlow protocol.

**Syntax** `switchport atmf-guestlink [class <guest-class>] [ip <A.B.C.D> | ipv6 <X:X::X:X>]`  
`no switchport atmf-guestlink`

Parameter	Description
class	Set a guest class
<guest-class>	The name of the guest class.
ip	Specifies that the address following will have an IPv4 format
<A.B.C.D>	The guest node's IP address in IPv4 format.
ipv6	Specifies that the address following will have an IPv6 format
<X:X::X:X>	The guest node's IP address in IPv6 format.

**Default** No guest links are configured.

**Mode** Interface

**Example 1** To configure switchport port1.0.1 to be a guest link, that will connect to a guest node having a guest class of **camera** and an IPv4 address of **192.168.3.3**, use the following commands:

```
node1# configure terminal
node1(config)# int port1.0.1
node1(config-if)# switchport atmf-guestlink class camera ip
192.168.3.3
```

**Example 2** To configure switchport port1.0.1 to be a guest link, which will connect to a guest node having a guest class of **phone** and an IPv6 address of **2001:db8:21e:10d::5**, use the following commands:

```
node1# configure terminal
node1(config)# int port1.0.1
node1(config-if)# switchport atmf-guestlink class phone ipv6
2000:db8:21e:10d::5
```

**Example 3** To configure switchport port1.0.1 to be a guest link, using the default model type and learning method address, use the following commands:

```
node1# configure terminal
node1(config)# int port1.0.1
node1(config-if)# switchport atmf-guestlink
```

**Example 4** To configure switchports port1.0.1 to port1.0.3 to be guest links, for the guest class **camera**, use the following commands:

```
node1# configure terminal
node1(config)# int port1.0.1-port1.0.3
node1(config-if)# switchport atmf-guestlink class camera
```

**Example 5** To remove the guest-link functionality from switchport port1.0.1, use the following commands:

```
node1# configure terminal
node1(config)# int port1.0.1
node1(config-if)# no switchport atmf-guestlink
```

**Related commands**

- atmf guest-class
- discovery
- http-enable
- username
- modeltype
- show atmf links guest
- show atmf guests

# switchport atmf-link

**Overview** This command enables you to configure a port or aggregator to be an AMF up/down link. Running this command will automatically place the port or aggregator into trunk mode. If the port was previously configured in access mode, the configured access VLAN will be removed.

Use the **no** variant of this command to remove any AMF-link that may exist for the selected port or aggregated link.

**Syntax** `switchport atmf-link`  
`no switchport atmf-link`

**Mode** Interface Configuration for a switchport, a static aggregator or a dynamic channel group.

**Usage notes** Up/down links and virtual links interconnect domains in a vertical hierarchy, with the highest domain being the core domain. In effect, they form a tree of interconnected AMF domains. This tree must be loop-free. Therefore, you must configure your links so that no rings are formed only from up/down links and/or virtual links.

Within each domain, cross-links between AMF nodes define those nodes as siblings within the same domain. You can form rings by combining cross-links with up/down links and/or virtual links, as long as each AMF domain links upwards to only a single parent domain. Each domain may link downwards to multiple child domains.

**Example** To make switchport port1.0.1 an AMF up/down link, use the following commands:

```
Node_1# configure terminal
Node_1(config)# interface port1.0.1
Node_1(config-if)# switchport atmf-link
```

# type atmf node

**Overview** This command configures a trigger to be activated at an AMF node join event or leave event.

**Syntax** `type atmf node {join|leave}`

Parameter	Description
join	AMF node join event.
leave	AMF node leave event.

**Mode** Trigger Configuration

**CAUTION:** Only configure this trigger on one device because it is a network wide event.

**Example 1** To configure trigger 5 to activate at an AMF node leave event, use the following commands. In this example the command is entered on node-1:

```
node1(config)# trigger 5
node1(config-trigger) type atmf node leave
```

**Example 2** The following commands will configure trigger 5 to activate if an AMF node join event occurs on any node within the working set:

```
node1# atmf working-set group all
```

This command returns the following display:

```
=====
node1, node2, node3:
=====

Working set join
```

Note that the running the above command changes the prompt from the name of the local node, to the name of the AMF-Network followed, in square brackets, by the number of member nodes in the working set.

```
AMF-Net[3]# conf t
AMF-Net[3](config)# trigger 5
AMF-Net[3](config-trigger)# type atmf node leave
AMF-Net[3](config-trigger)# description "E-mail on AMF Exit"
AMF-Net[3](config-trigger)# active
```

Enter the name of the script to run at the trigger event.

```
AMF-Net[3](config-trigger)# script 1 email_me.scp
AMF-Net[3](config-trigger)# end
```



### Display the trigger configurations

AMF-Net[3]# show trigger

This command returns the following display:

```
=====
node1:
=====

TR# Type & Details      Description          Ac Te Tr Repeat      #Scr Days/Date
-----
001 Periodic (2 min)    Periodic Status Chk Y  N  Y Continuous    1  smtwtfS
005 ATMF node (leave)  E-mail on ATMF Exit Y  N  Y Continuous    1  smtwtfS
-----

=====
Node2, Node3,
=====

TR# Type & Details      Description          Ac Te Tr Repeat      #Scr Days/Date
-----
005 ATMF node (leave)  E-mail on ATMF Exit Y  N  Y Continuous    1  smtwtfS
-----
```

### Display the triggers configured on each of the nodes in the AMF Network.

AMF-Net[3]# show running-config trigger

This command returns the following display:

```
=====
Node1:
=====

trigger 1
  type periodic 2
  script 1 atmf.scp
trigger 5
  type atmf node leave
  description "E-mail on ATMF Exit"
  script 1 email_me.scp
!

=====
Node2, Node3:
=====

trigger 5
  type atmf node leave
  description "E-mail on ATMF Exit"
  script 1 email_me.scp
!
```

**Related  
commands** [show trigger](#)

# undebbug atmf

**Overview** This command is an alias for the **no** variant of the [debug atmf](#) command.

# username

**Overview** This command enables you to assign a **username** to a guest class. Guests may require a username and possibly also a password. In its non-encrypted form the password must be between 1 and 32 characters and will allow spaces. In its encrypted form the password must be between 1 to 64 characters and will allow any character

**Syntax** `username <NAME> password [8] <USERPASS>`  
`no username`

Parameter	Description
username	Indicates that a user name is to follow
<NAME>	User name of the guest node
password	Indicates that a password (or specifier) is to follow.
8	Specifier indicating that the following password is encrypted. It's primary purpose is to differentiate between the configuration input and the CLI input. You should not specify this for CLI input
<USERPASS>	The password to be entered for the guest node.

**Default** No usernames configured

**Mode** AMF Guest Configuration Mode

**Example 1** To assign the user name **reception** and the password of **secret** to an AMF guest node that has the guest class of **phone1** use the following commands:

```
node1# conf t
node1(config)# amf guest-class phone1
node1(config-atmf-guest)# username reception password secret
node1(config-atmf-guest)# end
```

**Example 2** To remove a guest node username and password for the user guest class **phone1**, use the following commands:

```
node1# conf t
node1(config)# atmf guest-class phone1
node1(config-atmf-guest)# no username
node1(config-atmf-guest)# end
```

**Related commands** [show atmf links detail](#)  
[atmf guest-class](#)  
[switchport atmf-guestlink](#)

show atmf links guest

show atmf nodes

# 40

# Management Stacking Commands

## Introduction

**Overview** This chapter provides an alphabetical reference of commands used to configure management stacking.

For introductory information about management stacking in AlliedWare Plus, including overview and configuration information, see the [Management Stacking Feature Overview and Configuration\\_Guide](#).

- Command List**
- “[mstack command-node](#)” on page 1679
  - “[mstack enable](#)” on page 1680
  - “[mstack remote-login](#)” on page 1681
  - “[show mstack nodes](#)” on page 1683
  - “[switchport mstack-link](#)” on page 1684

# mstack command-node

**Overview** This command configures the device as an management stacking command node. This is considered the core of the management stack.

From the command node, you can use the remote-login command to access and configure other nodes in the management stack.

**Syntax** mstack command-node  
no mstack command-node

**Mode** Global Config

**Usage notes** A management stacking command node has to be present for a management stack to form. Only one device in the management stack can be the command node.

**Example** To make the device called command-node into the management stacking command node, use the commands:

```
command-node#configure terminal  
command-node(config)#mstack command-node
```

To disable the device from being the management stacking command node, use the commands:

```
command-node# configure terminal  
command-node(config)#no mstack command-node
```

# mstack enable

**Overview** This command manually enables (turns on) the management stacking feature for the switch being configured.

Use the no variant of this command to disable (turn off) the management stacking feature on the node.

**Syntax** mstack enable  
no mstack enable

**Mode** Global Configuration

**Usage notes** To use management stacking you need to enable management stacking on each switch in the management stack.

**Examples** To turn on the management stacking feature:

```
MyNode# config terminal
```

```
MyNode(config)# mstack enable
```

To turn off the management stacking feature:

```
MyNode(config)# no mstack enable
```



# mstack remote-login

**Overview** Use this command to remotely log in from the command node to another management stacking node. This lets you run commands as if you were a local user of that node.

**Syntax** `mstack remote-login [user <name>] <nodename>`

Parameter	Description
<name>	User name.
<nodename>	The host name of the node.

**Mode** Privileged Exec (This command will only run at privilege level 15)

**Usage notes** You do not need a valid login on the local device in order to run this command. The session will take you to the enable prompt on the new device. If the remote login session exits for any reason (e.g. device reboot) you will be returned to the originating node.

The software will not allow you to run multiple remote login sessions. You must exit an existing session before starting a new one.

In the remote login command, the hostname is not case sensitive. For example, the following commands all let you log into a host named node-02:

```
command-node# mstack remote-login node-02
command-node# mstack remote-login Node-02
command-node# mstack remote-login NODE-02
```

**Example 1** To remotely login from command-node to node20, use the following command:

```
command-node# mstack remote-login node20
```

The following information is displayed:

Table 40-1:

```
Type 'exit' to return to command-node.
AlliedWare Plus (TM) 0.0.0 01/07/15 20:00:58
node20>
```

You can then enter commands on node20:

```
node20> enable
node20# <other-commands>
```

To close the remote login session, use the following command:

```
node20# exit
```

**Example 2** In this example, user whitney is a valid user of command-node and node3. She can remotely login from command-node to node3 by using the following commands:

```
command-node# mstack remote-login user whitney node3  
node3>
```

# show mstack nodes

**Overview** This command displays all nodes currently configured within the management stacking network.

**Syntax** show mstack nodes

**Mode** Privileged Exec

**Example** To display management stacking information for all nodes in the management stack, use the command:

```
command-node# show mstack nodes
```

Figure 40-1: Sample output from the **show mstack nodes** command.

```
Node Information:

* = Local device

SC = Switch Configuration:
C = Chassis   S = Stackable   N = Standalone

Node          Device      MSTACK
Node Name    Type        C-Node    SC      Parent    Depth
-----
  command-node  GS970M/10  Y         N      none      0
  node-01      GS970M/10  N         N      command-node  1
* node-02      GS970M/10  N         N      node-01   2

Current MSTACK node count 3
```

# switchport mstack-link

**Overview** This command enables you to configure a link to be a management stack link. Use the no variant of this command to remove any mstack-link that may exist for the selected link.

**Syntax** `switchport mstack-link`  
`no switchport mstack-link`

**Mode** Interface Configuration

**Usage notes** Running this command will automatically place the port or aggregator into trunk mode. The link can be a link between switch ports or aggregated ports.

**Example** To make a switchport a management stack link, use the following commands:

```
Node_1# configure terminal
Node_1(config)# interface port1.0.1
Node_1(config-if)# switchport atmf-link
```

# 41

# Dynamic Host Configuration Protocol (DHCP) Commands

## Introduction

**Overview** This chapter provides an alphabetical reference for commands used to configure DHCP.

For more information, see the [DHCP Feature Overview and Configuration Guide](#), which is available at the above link on [alliedtelesis.com](#).

For information on filtering and saving command output, see the [“Getting Started with AlliedWare Plus” Feature Overview and Configuration Guide](#). This guide is available at the above link on [alliedtelesis.com](#).

- Command List**
- [“ip address dhcp”](#) on page 1686
  - [“ip dhcp-client default-route distance”](#) on page 1688
  - [“ip dhcp-client request vendor-identifying-specific”](#) on page 1690
  - [“ip dhcp-client vendor-identifying-class”](#) on page 1691
  - [“show counter dhcp-client”](#) on page 1692
  - [“show dhcp lease”](#) on page 1693

# ip address dhcp

**Overview** This command activates the DHCP client on the interface you are configuring. This allows the interface to use the DHCP client to obtain its IP configuration details from a DHCP server on its connected network.

The **client-id** and **hostname** parameters are identifiers that you may want to set in order to interoperate with your existing DHCP infrastructure. If neither option is needed, then the DHCP server uses the MAC address field of the request to identify the host.

The DHCP client supports the following IP configuration options:

- Option 1 - the subnet mask for your device.
- Option 51 - lease expiration time.

The **no** variant of this command stops the interface from obtaining IP configuration details from a DHCP server.

**Syntax** `ip address dhcp [client-id <interface>] [hostname <hostname>]`  
`no ip address dhcp`

Parameter	Description
<code>client-id</code> <code>&lt;interface&gt;</code>	The name of the interface you are activating the DHCP client on. If you specify this, then the MAC address associated with the specified interface is sent to the DHCP server in the optional identifier field. Default: no default
<code>hostname</code> <code>&lt;hostname&gt;</code>	The hostname for the DHCP client on this interface. Typically this name is provided by the ISP. Default: no default

**Mode** Interface Configuration for a VLAN interface.

**Examples** To set the interface `vlan2` to use DHCP to obtain an IP address, use the commands:

```
awplus# configure terminal
awplus(config)# interface vlan2
awplus(config-if)# ip address dhcp
```

To stop the interface `vlan2` from using DHCP to obtain its IP address, use the commands:

```
awplus# configure terminal
awplus(config)# interface vlan2
awplus(config-if)# no ip address dhcp
```

**Related commands** [ip address \(IP Addressing and Protocol\)](#)  
[show ip interface](#)  
[show running-config](#)

# ip dhcp-client default-route distance

**Overview** Use this command to specify an alternative Administrative Distance (AD) for the current default route (from DHCP) for an interface.

Use the **no** variant of this command to set the AD back to the default of 1.

**Syntax** `ip dhcp-client default-route distance [<1-255>]`  
`no ip dhcp-client default-route distance`

Parameter	Description
<1-255>	Administrative Distance (AD) from the range 1 though 255.

**Default** 1

**Mode** Interface Configuration

**Usage notes** DHCP client interfaces can automatically add a default route with an AD of 1 into the IP Routing Information Base (RIB).

Any pre-existing default route(s) via alternative interfaces (configured with a higher AD) will no longer be selected as the preferred forwarding path for traffic when the DHCP based default route is added to the IP routing table.

This can be problematic if the DHCP client is operating via an interface that is only intended to be used for back-up interface redundancy purposes, such as a VLAN containing a single switchport, or a 4G cellular interface on an AR-Series Firewall.

Use this command to set the AD of the default route (via a specific DHCP client interface) to a non-default (higher cost) value, ensuring any pre-existing default route(s) via any other interface(s) continue to be selected as the preferred forwarding path for network traffic.

When the command is used, the static default route is deleted from the RIB, the distance value of the route is modified to the configured distance value, then it is reinstalled into the RIB.

**Examples** To configure vlan10 as a DHCP client and to set the AD for the default route added by DHCP to 150, use the commands:

```
awplus# configure terminal
awplus(config)# interface vlan10
awplus(config-if)# ip address dhcp
awplus(config-if)# ip dhcp-client default-route distance 150
```



To set the AD for the default route back to the default value of 1, use the commands:

```
awplus# configure terminal
awplus(config)# interface vlan10
awplus(config-if)# no ip dhcp-client default-route distance
```

**Related  
commands**

[show ip route](#)  
[show ip route database](#)

**Command  
changes**

Version 5.4.7-0.2 Command added.

# ip dhcp-client request vendor-identifying-specific

**Overview** Use this command to add vendor-identifying vendor-specific information (option 125) requests to the DHCP discovery packets sent by an interface. This option, along with option 124, can be used to send vendor specific information back to a DHCP client.

See RFC3925 for more information on Vendor-Identifying Vendor Options for DHCPv4.

Use the **no** variant of this command to remove the vendor-identifying-specific request from an interface.

**Syntax** `ip dhcp-client request vendor-identifying-specific`  
`no ip dhcp-client request vendor-identifying-specific`

**Default** The vendor-identifying-specific request is not configured by default.

**Mode** Interface Configuration

**Usage notes** The DHCP client must be activated on the interface, using the [ip address dhcp](#) command, so that DHCP discovery packets are sent.

**Example** To add the vendor-identifying-specific request on vlan2, use the commands:

```
awplus# configure terminal
awplus(config)# interface vlan2
awplus(config-if)# ip dhcp-client request
vendor-identifying-specific
```

To remove the vendor-identifying-specific request on vlan2, use the commands:

```
awplus# configure terminal
awplus(config)# interface vlan2
awplus(config-if)# no ip dhcp-client request
vendor-identifying-specific
```

**Related commands** [ip address dhcp](#)  
[ip dhcp-client vendor-identifying-class](#)

**Command changes** Version 5.4.7-2.1: command added

# ip dhcp-client vendor-identifying-class

**Overview** Use this command to add a vendor-identifying vendor class (option 124) to the DHCP discovery packets sent by an interface. This option places the Allied Telesis Enterprise number (207) into the discovery packet. Option 124, along with option 125, can be used to send vendor specific information back to a DHCP client.

See RFC3925 for more information on Vendor-Identifying Vendor Options for DHCPv4.

Use the **no** variant of this command to remove the vendor-identifying-class from an interface.

**Syntax** `ip dhcp-client vendor-identifying-class`  
`no ip dhcp-client vendor-identifying-class`

**Default** The vendor-identifying-class is not configured by default.

**Mode** Interface Configuration

**Usage notes** The DHCP client must be activated on the interface, using the [ip address dhcp](#) command, so that DHCP discovery packets are sent.

**Example** To remove the vendor-identifying-specific request on vlan2, use the commands:

```
awplus# configure terminal
awplus(config)# interface vlan2
awplus(config-if)# no ip dhcp-client vendor-identifying-class
```

**Related commands** [ip address dhcp](#)  
[ip dhcp-client request vendor-identifying-specific](#)

**Command changes** Version 5.4.7-2.1: command added

# show counter dhcp-client

**Overview** This command shows counters for the DHCP client on your device.  
For information on filtering and saving command output, see the [“Getting Started with AlliedWare Plus” Feature Overview and Configuration Guide](#).

**Syntax** `show counter dhcp-client`

**Mode** User Exec and Privileged Exec

**Example** To display the message counters for the DHCP client on your device, use the command:

```
awplus# show counter dhcp-client
```

**Output** Figure 41-1: Example output from the **show counter dhcp-client** command

```
show counter dhcp-client
DHCPDISCOVER out      ..... 10
DHCPREQUEST out       ..... 34
DHCPCDECLINE out      ..... 4
DHCPRELEASE out       ..... 0
DHCPPOFFER in         ..... 22
DHCPACK in            ..... 18
DHCPNAK in            ..... 0
```

**Table 1:** Parameters in the output of the **show counter dhcp-client** command

Parameter	Description
DHCPDISCOVER out	The number of DHCP Discover messages sent by the client.
DHCPREQUEST out	The number of DHCP Request messages sent by the client.
DHCPCDECLINE out	The number of DHCP Decline messages sent by the client.
DHCPRELEASE out	The number of DHCP Release messages sent by the client.
DHCPPOFFER in	The number of DHCP Offer messages received by the client.
DHCPACK in	The number of DHCP Acknowledgement messages received by the client.
DHCPNAK in	The number of DHCP Negative Acknowledgement messages received by the client.

**Related commands** [ip address dhcp](#)

# show dhcp lease

**Overview** This command shows details about the leases that the DHCP client has acquired from a DHCP server for interfaces on the device.

For information on filtering and saving command output, see “Controlling “show” Command Output” in the “Getting Started with AlliedWare\_Plus” Feature Overview and Configuration Guide.

**Syntax** `show dhcp lease [<interface>]`

Parameter	Description
<code>&lt;interface&gt;</code>	Interface name to display DHCP lease details for.

**Mode** User Exec and Privileged Exec

**Example** To show the current lease expiry times for all interfaces, use the command:

```
awplus# show dhcp lease
```

To show the current lease for vlan1, use the command:

```
awplus# show dhcp lease vlan1
```

**Output** Figure 41-2: Example output from the **show dhcp lease vlan1** command

```
Interface vlan1
-----
IP Address:                192.168.22.4
Expires:                   13 Mar 2017 20:10:19
Renew:                     13 Mar 2017 18:37:06
Rebind:                    13 Mar 2017 19:49:29
Server:
Options:
  subnet-mask              255.255.255.0
  routers                  19.18.2.100,12.16.2.17
  dhcp-lease-time          3600
  dhcp-message-type        5
  domain-name-servers      192.168.100.50,19.88.200.33
  dhcp-server-identifier   192.168.22.1
  domain-name               alliedtelesis.com
```

**Related commands** [ip address dhcp](#)

# 42

# NTP Commands

## Introduction

**Overview** This chapter provides an alphabetical reference for commands used to configure the Network Time Protocol (NTP). For more information, see the [NTP Feature Overview and Configuration Guide](#).

The switch can act as an NTP client to receive time from one or more NTP servers.

For information on filtering and saving command output, see the [“Getting Started with AlliedWare Plus” Feature Overview and Configuration Guide](#).

- Command List**
- [“ntp access-group \(deprecated\)”](#) on page 1695
  - [“ntp authenticate”](#) on page 1696
  - [“ntp authentication-key”](#) on page 1697
  - [“ntp broadcastdelay”](#) on page 1698
  - [“ntp discard”](#) on page 1699
  - [“ntp peer”](#) on page 1700
  - [“ntp rate-limit”](#) on page 1702
  - [“ntp restrict”](#) on page 1703
  - [“ntp server”](#) on page 1705
  - [“ntp source”](#) on page 1707
  - [“ntp trusted-key \(deprecated\)”](#) on page 1709
  - [“show counter ntp \(deprecated\)”](#) on page 1710
  - [“show ntp associations”](#) on page 1711
  - [“show ntp counters”](#) on page 1713
  - [“show ntp counters associations”](#) on page 1714
  - [“show ntp status”](#) on page 1715

# ntp access-group (deprecated)

**Overview** This command has been deprecated in Software Version 5.4.6-1.1. Please use the command `ntp restrict` instead.

# ntp authenticate

**Overview** This command enables NTP authentication. This allows NTP to authenticate the associations with other systems for security purposes.

The **no** variant of this command disables NTP authentication.

**Syntax** ntp authenticate  
no ntp authenticate

**Mode** Global Configuration

**Examples** To enable NTP authentication, use the commands:

```
awplus# configure terminal  
awplus(config)# ntp authenticate
```

To disable NTP authentication, use the commands:

```
awplus# configure terminal  
awplus(config)# no ntp authenticate
```



# ntp authentication-key

**Overview** This command defines each of the authentication keys. Each key has a key number, a type (MD5 or SHA1), and a value.

The **no** variant of this disables the authentication key.

**Syntax** `ntp authentication-key <keynumber> {md5|sha1} <key> [trusted]`  
`no ntp authentication-key <keynumber>`

Parameter	Description
<keynumber>	<1-4294967295> An identification number for the key.
md5	Define an MD5 key.
sha1	Define an SHA1 key.
<key>	The authentication key. For SHA1, this is a 20 hexadecimal character string. For MD5, this is a string of up to 31 ASCII characters.
trusted	Add this key to the list of authentication keys that this server trusts.

**Mode** Global Configuration

**Examples** To define an MD5 authentication key number 134343 and a key value "mystring", use the commands:

```
awplus# configure terminal  
awplus(config)# ntp authentication-key 134343 md5 mystring
```

To disable the authentication key number 134343 with the key value "mystring", use the commands:

```
awplus# configure terminal  
awplus(config)# no ntp authentication-key 134343 md5 mystring
```

# ntp broadcastdelay

**Overview** Use this command to set the estimated round-trip delay for broadcast packets. Use the **no** variant of this command to reset the round-trip delay for broadcast packets to the default offset of 0 microseconds.

**Syntax** `ntp broadcastdelay <delay>`  
`no ntp broadcastdelay`

Parameter	Description
<delay>	<1-999999> The broadcast delay in microseconds.

**Default** 0 microsecond offset, which can only be applied with the **no** variant of this command.

**Mode** Global Configuration

**Examples** To set the estimated round-trip delay to 23464 microseconds for broadcast packets, use these commands:

```
awplus# configure terminal
awplus(config)# ntp broadcastdelay 23464
```

To reset the estimated round-trip delay for broadcast packets to the default setting (0 microseconds), use these commands:

```
awplus# configure terminal
awplus(config)# no ntp broadcastdelay
```

# ntp discard

**Overview** Use this command to limit the time between NTP packets on the host or hosts specified by the command [ntp restrict](#). Packets that arrive at greater frequency than the limits are dropped or sent a kiss-of-death response.

Use the **no** variant of this command to return the limits to their default values.

**Syntax**

```
ntp discard minimum <1-60>
ntp discard average <1-16>
no ntp discard minimum
no ntp discard average
```

Parameter	Description
minimum <1-60>	The minimum time between NTP packets, in seconds.
average <1-16>	A value that determines the minimum average time between NTP packets. The number of seconds is 2 to the power of the specified value (e.g. if you specify 4, the minimum average time is 16 seconds).

**Default** Minimum: 2  
Average: 3 (8 seconds)

**Mode** Global Configuration

**Example** To drop NTP packets from the 192.168.1.0/16 subnet if they arrive more frequently than every 5 seconds, and also send kiss-of-death messages, use the commands:

```
awplus# configure terminal
awplus(config)# ntp discard minimum 5
awplus(config)# ntp restrict 192.168.1.0/16 limited kod
```

To silently drop all NTP packets if they arrive more frequently than once every 4 seconds on average (2 to the power of 2), use the commands:

```
awplus# configure terminal
awplus(config)# ntp discard average 2
awplus(config)# ntp restrict default-v4 limited
awplus(config)# ntp restrict default-v6 limited
```

**Related commands** [ntp restrict](#)

# ntp peer

**Overview** Use this command to configure an NTP peer association. An NTP association is a peer association if this system is willing to either synchronize to the other system, or allow the other system to synchronize to it.

Use the **no** variant of this command to remove the configured NTP peer association.

**Syntax** `ntp peer {<peeraddress>|<peername>}`  
`ntp peer {<peeraddress>|<peername>} [prefer] [key <key>]`  
`[version <version>]`  
`no ntp peer {<peeraddress>|<peername>}`

Parameter	Description
<code>&lt;peeraddress&gt;</code>	Specify the IP address of the peer, entered in the form A.B.C.D for an IPv4 address, or in the form X:X::X:X for an IPv6 address.
<code>&lt;peername&gt;</code>	Specify the peer hostname. The peer hostname can resolve to an IPv4 and an IPv6 address.
<code>prefer</code>	Prefer this peer when possible.
<code>key &lt;key&gt;</code>	<code>&lt;1-4294967295&gt;</code> Configure the peer authentication key.
<code>version &lt;version&gt;</code>	<code>&lt;1-4&gt;</code> Configure for this NTP version.

**Mode** Global Configuration

**Examples** See the following commands for options to configure NTP peer association, key and NTP version for the peer with an IPv4 address of 192.0.2.23:

```
awplus# configure terminal
awplus(config)# ntp peer 192.0.2.23
awplus(config)# ntp peer 192.0.2.23 prefer
awplus(config)# ntp peer 192.0.2.23 prefer version 4
awplus(config)# ntp peer 192.0.2.23 prefer version 4 key 1234
awplus(config)# ntp peer 192.0.2.23 version 4 key 1234
awplus(config)# ntp peer 192.0.2.23 version 4
awplus(config)# ntp peer 192.0.2.23 key 1234
```

To remove an NTP peer association for this peer with an IPv4 address of 192.0.2.23, use the following commands:

```
awplus# configure terminal
awplus(config)# no ntp peer 192.0.2.23
```

See the following commands for options to configure NTP peer association, key and NTP version for the peer with an IPv6 address of 2001:0db8:010d::1:

```
awplus# configure terminal
awplus(config)# ntp peer 2001:0db8:010d::1
awplus(config)# ntp peer 2001:0db8:010d::1 prefer
awplus(config)# ntp peer 2001:0db8:010d::1 prefer version 4
awplus(config)# ntp peer 2001:0db8:010d::1 prefer version 4 key
1234
awplus(config)# ntp peer 2001:0db8:010d::1 version 4 key 1234
awplus(config)# ntp peer 2001:0db8:010d::1 version 4
awplus(config)# ntp peer 2001:0db8:010d::1 key 1234
```

To remove an NTP peer association for this peer with an IPv6 address of 2001:0db8:010d::1, use the following commands:

```
awplus# configure terminal
awplus(config)# no ntp peer 2001:0db8:010d::1
```

**Related  
commands**    [ntp server](#)  
              [ntp source](#)

# ntp rate-limit

**Overview** Use this command to enable NTP server response rate-limiting. Limiting NTP server responses can reduce network traffic when occurrences such as misconfigured or broken NTP clients poll the NTP server too frequently. Excessive polling can lead to network overload.

Use the **no** variant of this command to remove the rate-limit configuration.

**Syntax** `ntp rate-limit {interval<1-4096>|burst <1-255>|leak <2-16>}`  
`no ntp rate-limit`

Parameter	Description
interval	The minimum interval between responses configured in seconds. The default interval is 8 seconds.
burst	The maximum number of responses that can be sent in a burst, temporarily exceeding the limit specified by the interval option. The default burst is 8 responses.
leak	The rate at which responses are randomly allowed even if the limits specified by the interval and burst options are exceeded. The default leak is 4, i.e. on average, every fourth request has a response.

**Mode** Global Configuration

**Default** Interval - 8 seconds.

Burst - 8 responses.

Leak - 4.

**Example** To configure an NTP rate-limiting interval of 30 seconds, use the following commands:

```
awplus# configure terminal  
awplus(config)# ntp rate-limit interval 30
```

**Related commands** [ntp restrict](#)

**Command changes** Version 5.4.8-1.1: command added

# ntp restrict

**Overview** Use this command to configure a restriction (allow or deny) on NTP packets or NTP functionality for a specific host/network or all hosts of a given IP family.

This means you can control host access to NTP service and NTP server status queries.

Use the **no** variant of this command to remove a restriction from one or more hosts.

**Syntax**

```
ntp restrict
{default-v4|default-v6|<host-address>|<host-subnet>}
{allow|deny}

ntp restrict
{default-v4|default-v6|<host-address>|<host-subnet>} query
{allow|deny}

ntp restrict
{default-v4|default-v6|<host-address>|<host-subnet>} serve
{allow|deny}

no ntp restrict
{default-v4|default-v6|<host-address>|<host-subnet>}
```

Parameter	Description
default-v4	Apply this restriction to all IPv4 hosts.
default-v6	Apply this restriction to all IPv6 hosts.
<host-address>	Apply this restriction to the specified IPv4 or IPv6 host. Enter an IPv4 address in the format A.B.C.D. Enter an IPv6 address in the format X::X:X.
<host-subnet>	Apply this restriction to the specified IPv4 subnet or IPv6 prefix. Enter an IPv4 subnet in the format A.B.C.D/M. Enter an IPv6 prefix in the format X::X:X/X.
query	Control NTP server status queries to matching hosts.
serve	Control NTP time service to matching hosts.
allow	Allow the configured restriction.
deny	Deny the configured restriction.

**Default** By default, time service is allowed to all hosts, and NTP server status querying is denied to all hosts.

**Mode** Global Configuration

**Example** To prevent all IPv4 hosts from accessing a device for NTP service, use the commands:

```
awplus# configure terminal
awplus(config)# ntp restrict default-v4 deny
```

To prevent the host 192.168.1.1 from accessing a device for NTP service, use the commands:

```
awplus# configure terminal
awplus(config)# ntp restrict 198.168.1.1 deny
```

To allow all hosts in the 10.10.10.0/24 subnet to access a device for NTP server status, use the commands:

```
awplus# configure terminal
awplus(config)# ntp restrict 10.10.10.0/24 query allow
```

**Related commands** [ntp rate-limit](#)

**Command changes** Version 5.4.8-1.1: command added



# ntp server

**Overview** Use this command to configure an NTP server. This means that this system will synchronize to the other system, and not vice versa.

Use the **no** variant of this command to remove the configured NTP server.

**Syntax** `ntp server {<serveraddress>|<servername>}`  
`ntp server {<serveraddress>|<servername>} [prefer] [key <key>] [version <version>]`  
`no ntp server {<serveraddress>|<servername>}`

Parameter	Description
<serveraddress>	Specify the IP address of the peer, entered in the form A.B.C.D for an IPv4 address, or in the form X:X::X.X for an IPv6 address.
<servername>	Specify the server hostname. The server hostname can resolve to an IPv4 and an IPv6 address.
prefer	Prefer this server when possible.
key <key>	<1-4294967295> Configure the server authentication key.
version <version>	<1-4> Configure for this NTP version.

**Mode** Global Configuration

**Examples** See the following commands for options to configure an NTP server association, key and NTP version for the server with an IPv4 address of 192.0.1.23:

```
awplus# configure terminal
awplus(config)# ntp server 192.0.1.23
awplus(config)# ntp server 192.0.1.23 prefer
awplus(config)# ntp server 192.0.1.23 prefer version 4
awplus(config)# ntp server 192.0.1.23 prefer version 4 key 1234
awplus(config)# ntp server 192.0.1.23 version 4 key 1234
awplus(config)# ntp server 192.0.1.23 version 4
awplus(config)# ntp server 192.0.1.23 key 1234
```

To remove an NTP peer association for this peer with an IPv4 address of 192.0.1.23, use the commands:

```
awplus# configure terminal
awplus(config)# no ntp server 192.0.1.23
```

See the following commands for options to configure an NTP server association, key and NTP version for the server with an IPv6 address of 2001:0db8:010e::2:

```
awplus# configure terminal
awplus(config)# ntp server 2001:0db8:010e::2
awplus(config)# ntp server 2001:0db8:010e::2 prefer
awplus(config)# ntp server 2001:0db8:010e::2 prefer version 4
awplus(config)# ntp server 2001:0db8:010e::2 prefer version 4
key 1234
awplus(config)# ntp server 2001:0db8:010e::2 version 4 key 1234
awplus(config)# ntp server 2001:0db8:010e::2 version 4
awplus(config)# ntp server 2001:0db8:010e::2 key 1234
```

To remove an NTP peer association for this peer with an IPv6 address of 2001:0db8:010e::2, use the commands:

```
awplus# configure terminal
awplus(config)# no ntp server 2001:0db8:010e::2
```

**Related commands**

- [ntp peer](#)
- [ntp source](#)

# ntp source

**Overview** Use this command to configure an IPv4 or an IPv6 address for the NTP source interface. This command defines the socket used for NTP messages, and only applies to NTP client behavior.

Note that you cannot use this command when using AMF (Allied Telesis Management Framework).

Use the **no** variant of this command to remove the configured IPv4 or IPv6 address from the NTP source interface.

**Syntax** `ntp source <source-address>`  
`no ntp source`

Parameter	Description
<code>&lt;source-address&gt;</code>	Specify the IP address of the NTP source interface, entered in the form A.B.C.D for an IPv4 address, or in the form X:X::X.X for an IPv6 address.

**Default** An IP address is selected based on the most appropriate egress interface used to reach the NTP peer if a configured NTP client source IP address is unavailable or invalid.

**Mode** Global Configuration

**Usage notes** Adding an IPv4 or an IPv6 address allows you to select which source interface NTP uses for peering. The IPv4 or IPv6 address configured using this command is matched to the interface.

When selecting a source IP address to use for NTP messages to the peer, if the configured NTP client source IP address is unavailable then default behavior will apply, and an alternative source IP address is automatically selected. This IP address is based on the most appropriate egress interface used to reach the NTP peer. The configured NTP client source IP may be unavailable if the interface is down, or an invalid IP address is configured that does not reside on the device.

Note that this command only applies to NTP client behavior. The egress interface that the NTP messages use to reach the NTP server is determined by the `ntp peer` and `ntp server` commands.

Note that you cannot use this command when using AMF (Allied Telesis Management Framework).

**Examples** To configure the NTP source interface with the IPv4 address 192.0.2.23, enter the commands:

```
awplus# configure terminal
awplus(config)# ntp source 192.0.2.23
```

To configure the NTP source interface with the IPv6 address 2001:0db8:010e::2, enter the commands:

```
awplus# configure terminal
awplus(config)# ntp source 2001:0db8:010e::2
```

To remove a configured address for the NTP source interface, use the following commands:

```
awplus# configure terminal
awplus(config)# no ntp source
```

**Related commands**

- [ntp peer](#)
- [ntp server](#)

## ntp trusted-key (deprecated)

**Overview** This command has been deprecated in Software Version 5.4.6-1.1. Please use the **trusted** parameter of the command [ntp authentication-key](#) instead.

# show counter ntp (deprecated)

**Overview** From version 5.4.6-1.x onwards, this command has been replaced by the command [show ntp counters](#).

# show ntp associations

**Overview** Use this command to display the status of NTP associations.

**Syntax** show ntp associations

**Mode** User Exec and Privileged Exec

**Example** See the sample output of the **show ntp associations** command displaying the status of NTP associations.

Table 42-1: Example output from **show ntp associations**

```
awplus#show ntp associations
remote          refid          st t when poll reach  delay  offset  disp
-----
*server1.example.com
                192.0.2.2      4 u  47  64  377  0.177  0.021  0.001
+192.168.1.10   10.32.16.80   5 u  46  64  377  0.241 -0.045  0.000
* system peer, # backup, + candidate, - outlier, x false ticker
```

Table 42-2: Parameters in the output from **show ntp associations**

Parameter	Description
* system peer	The peer that NTP uses to calculate variables like the offset and root dispersion of this AlliedWare Plus device. NTP passes these variables to the clients using this AlliedWare Plus device.
# backup	Peers that are usable, but are not among the first six peers sorted by synchronization distance. These peers may not be used.
+ candidate	Peers that the NTP algorithm has determined can be used, along with the system peer, to discipline the clock (i.e. to set the time on the AlliedWare Plus device).
- outlier	Peers that are not used because their time is significantly different from the other peers.
x false ticker	Peers that are not used because they are not consider trustworthy.
space	Peers that are not used because they are, for example, unreachable.
remote	The peer IP address
refid	The IP address of the reference clock, or an abbreviation indicating the type of clock (e.g. GPS indicates that the server uses GPS for the reference clock). INIT indicates that the reference clock is initializing, so it is not operational.

Table 42-2: Parameters in the output from **show ntp associations** (cont.)

Parameter	Description
st	The stratum, which is the number of hops between the server and the accurate time source such as an atomic clock.
t	Type, one of: u: unicast or anycast client b: broadcast or multicast client l: local reference clock s: symmetric peer A: anycast server B: broadcast server M: multicast server
when	When last polled (seconds ago, h hours ago, or d days ago).
poll	Time between NTP requests from the device to the server.
reach	An indication of whether or not the NTP server is responding to requests. 0 indicates there has never been a successful poll; 1 indicates that the last poll was successful; 3 indicates that the last two polls were successful; 377 indicates that the last 8 polls were successful.
delay	The round trip communication delay to the remote peer or server, in milliseconds.
offset	The mean offset (phase) in the times reported between this local host and the remote peer or server (root mean square, milliseconds).
disp	The amount of clock error (in milliseconds) of the server due to clock resolution, network congestion, etc.



# show ntp counters

**Overview** This command displays packet counters for NTP.

**Syntax** show ntp counters

**Mode** Privileged Exec

**Example** To display counters for NTP use the command:

```
awplus# show ntp counters
```

Figure 42-1: Example output from **show ntp counters**

```
awplus#show ntp counters
Server Received          4
Server Dropped          0
Client Sent              90
Client Received          76
Client Valid Received    76
```

Table 42-3: Parameters in the output from **show ntp counters**

Parameter	Description
Server Received	Number of NTP packets received from NTP clients.
Server Dropped	Number of NTP packets received from NTP clients but dropped.
Client Sent	Number of NTP packets sent to servers.
Client Received	Number of NTP packets received from servers
Client Valid Received	Number of valid NTP packets received from servers.

# show ntp counters associations

**Overview** Use this command to display NTP packet counters for individual servers and peers.

**Syntax** show ntp counters associations

**Mode** Privileged Exec

**Examples** To display packet counters for each NTP server and peer that is associated with a device, use the command:

```
awplus# show ntp counters associations
```

**Output** Figure 42-2: Example output from **show ntp counters associations**

```
awplus#show ntp counters associations
Peer 2001::1
  sent:          -
  received:      -
Peer 10.37.219.100
  sent:          7
  received:      7
```

Table 42-4: Parameters in the output from **show ntp counters associations**

Parameter	Description
Peer	An NTP peer or server that the device is associated with.
sent	The number of NTP packets that this device sent to the peer.
received	The number of NTP packets that this device received from the peer.

**Related commands** [ntp discard](#)  
[ntp restrict](#)

# show ntp status

**Overview** Use this command to display the status of the Network Time Protocol (NTP).

**Syntax** show ntp status

**Mode** User Exec and Privileged Exec

**Example** To see information about NTP status, use the command:

```
awplus# show ntp status
```

For information about the output displayed by this command, see [ntp.org](http://ntp.org).

Figure 42-3: Example output from **show ntp status**

```
awplus#show ntp status
Reference ID   : COA8010A (192.168.1.10)
Stratum       : 4
Ref time (UTC) : Fri Jun 15 05:32:38 2018
System time   : 0.000002004 seconds fast of NTP time
Last offset   : -0.002578615 seconds
RMS offset    : 0.000928071 seconds
Frequency     : 5.099 ppm slow
Residual freq : -9.120 ppm
Skew          : 17.486 ppm
Precision     : -21 (0.000000477 seconds)
Root delay    : 0.031749818 seconds
Root dispersion : 0.133974627 seconds
Update interval : 65.3 seconds
Leap status   : Normal
```

# 43

# SNMP Commands

## Introduction

**Overview** This chapter provides an alphabetical reference for commands used to configure SNMP. For more information, see:

- the [Support for Allied Telesis Enterprise\\_MIBs in AlliedWare Plus](#), for information about which MIB objects are supported.
- the [SNMP Feature Overview and Configuration\\_Guide](#).

For information on filtering and saving command output, see the [“Getting Started with AlliedWare Plus” Feature Overview and Configuration Guide](#).

- Command List**
- [“alias \(interface\)”](#) on page 1718
  - [“debug snmp”](#) on page 1719
  - [“show counter snmp-server”](#) on page 1720
  - [“show debugging snmp”](#) on page 1724
  - [“show running-config snmp”](#) on page 1725
  - [“show snmp-server”](#) on page 1726
  - [“show snmp-server community”](#) on page 1727
  - [“show snmp-server group”](#) on page 1728
  - [“show snmp-server user”](#) on page 1729
  - [“show snmp-server view”](#) on page 1730
  - [“snmp trap link-status”](#) on page 1731
  - [“snmp trap link-status suppress”](#) on page 1732
  - [“snmp-server”](#) on page 1734
  - [“snmp-server community”](#) on page 1736
  - [“snmp-server contact”](#) on page 1737
  - [“snmp-server enable trap”](#) on page 1738

- [“snmp-server engineID local”](#) on page 1740
- [“snmp-server engineID local reset”](#) on page 1742
- [“snmp-server group”](#) on page 1743
- [“snmp-server host”](#) on page 1745
- [“snmp-server legacy-ifadminstatus”](#) on page 1747
- [“snmp-server location”](#) on page 1748
- [“snmp-server source-interface”](#) on page 1749
- [“snmp-server startup-trap-delay”](#) on page 1750
- [“snmp-server user”](#) on page 1751
- [“snmp-server view”](#) on page 1754
- [“undebg snmp”](#) on page 1755

# alias (interface)

**Overview** Use this command to set an alias name for a port, as returned by the SNMP ifMIB in OID 1.3.6.1.2.1.31.1.1.1.18.

Use the **no** variant of this command to remove an alias name from a port.

**Syntax** `alias <ifAlias>`  
`no alias`

Parameter	Description
<code>&lt;ifAlias&gt;</code>	64 character name for an interface in a network management system. All printable characters are valid.

**Default** Not set.

**Mode** Interface Configuration

**Usage notes** The interface alias can also be set via SNMP.

Third-party management systems often use standard MIBs to access device information. Network managers can specify an alias interface name to provide a non-volatile way to access the interface.

**Example** To configure the alias interface name "uplink\_a" for port1.0.1, use the following commands:

```
awplus# configure terminal
awplus(config)# interface port1.0.1
awplus(config-if)# alias uplink_a
```

To remove an alias interface name from port1.0.1, use the following commands:

```
awplus# configure terminal
awplus(config)# interface port1.0.1
awplus(config-if)# no alias
```

**Command changes** Version 5.4.8-2.1: command added

# debug snmp

**Overview** This command enables SNMP debugging.

The **no** variant of this command disables SNMP debugging.

**Syntax** debug snmp  
[all|detail|error-string|process|receive|send|xdump]  
no debug snmp  
[all|detail|error-string|process|receive|send|xdump]

Parameter	Description
all	Enable or disable the display of all SNMP debugging information.
detail	Enable or disable the display of detailed SNMP debugging information.
error-string	Enable or disable the display of debugging information for SNMP error strings.
process	Enable or disable the display of debugging information for processed SNMP packets.
receive	Enable or disable the display of debugging information for received SNMP packets.
send	Enable or disable the display of debugging information for sent SNMP packets.
xdump	Enable or disable the display of hexadecimal dump debugging information for SNMP packets.

**Mode** Privileged Exec and Global Configuration

**Example** To start SNMP debugging, use the command:

```
awplus# debug snmp
```

To start SNMP debugging, showing detailed SNMP debugging information, use the command:

```
awplus# debug snmp detail
```

To start SNMP debugging, showing all SNMP debugging information, use the command:

```
awplus# debug snmp all
```

**Related commands** [show debugging snmp](#)  
[terminal monitor](#)  
[undebug snmp](#)

# show counter snmp-server

**Overview** This command displays counters for SNMP messages received by the SNMP agent.

**Syntax** show counter snmp-server

**Mode** User Exec and Privileged Exec

**Example** To display the counters for the SNMP agent, use the command:

```
awplus# show counter snmp-server
```

**Output** Figure 43-1: Example output from the **show counter snmp-server** command

SNMP-SERVER counters	
inPkts	11
inBadVersions	0
inBadCommunityNames	0
inBadCommunityUses	0
inASNParseErrs	0
inTooBigs	0
inNoSuchNames	0
inBadValues	0
inReadOnlyls	0
inGenErrs	0
inTotalReqVars	9
inTotalSetVars	0
inGetRequests	2
inGetNexts	9
inSetRequests	0
inGetResponses	0
inTraps	0
outPkts	11
outTooBigs	0
outNoSuchNames	2
outBadValues	0
outGenErrs	0
outGetRequests	0
outGetNexts	0
outSetRequests	0
outGetResponses	11
outTraps	0
UnsupportedSecLevels	0
NotInTimeWindows	0
UnknownUserNames	0
UnknownEngineIDs	0
WrongDigest	0
DecryptionErrors	0
UnknownSecModels	0
InvalidMsgs	0
UnknownPDUHandlers	0



**Table 1:** Parameters in the output of the **show counter snmp-server** command

Parameter	Meaning
inPkts	The total number of SNMP messages received by the SNMP agent.
inBadVersions	The number of messages received by the SNMP agent for an unsupported SNMP version. It drops these messages. The SNMP agent on your device supports versions 1, 2C, and 3.
inBadCommunityNames	The number of messages received by the SNMP agent with an unrecognized SNMP community name. It drops these messages.
inBadCommunityUses	The number of messages received by the SNMP agent where the requested SNMP operation is not permitted from SNMP managers using the SNMP community named in the message.
inASNParseErrs	The number of ASN.1 or BER errors that the SNMP agent has encountered when decoding received SNMP Messages.
inTooBig	The number of SNMP PDUs received by the SNMP agent where the value of the error-status field is 'tooBig'. This is sent by an SNMP manager to indicate that an exception occurred when processing a request from the agent.
inNoSuchNames	The number of SNMP PDUs received by the SNMP agent where the value of the error-status field is 'noSuchName'. This is sent by an SNMP manager to indicate that an exception occurred when processing a request from the agent.
inBadValues	The number of SNMP PDUs received by the SNMP agent where the value of the error-status field is 'badValue'. This is sent by an SNMP manager to indicate that an exception occurred when processing a request from the agent.
inReadOnly	The number of valid SNMP PDUs received by the SNMP agent where the value of the error-status field is 'readOnly'. The SNMP manager should not generate a PDU which contains the value 'readOnly' in the error-status field. This indicates that there is an incorrect implementation of the SNMP.
inGenErrs	The number of SNMP PDUs received by the SNMP agent where the value of the error-status field is 'genErr'.

**Table 1:** Parameters in the output of the **show counter snmp-server** command

Parameter	Meaning
inTotalReqVars	The number of MIB objects that the SNMP agent has successfully retrieved after receiving valid SNMP Get-Request and Get-Next PDUs.
inTotalSetVars	The number of MIB objects that the SNMP agent has successfully altered after receiving valid SNMP Set-Request PDUs.
inGetRequests	The number of SNMP Get-Request PDUs that the SNMP agent has accepted and processed.
inGetNexts	The number of SNMP Get-Next PDUs that the SNMP agent has accepted and processed.
inSetRequests	The number of SNMP Set-Request PDUs that the SNMP agent has accepted and processed.
inGetResponses	The number of SNMP Get-Response PDUs that the SNMP agent has accepted and processed.
inTraps	The number of SNMP Trap PDUs that the SNMP agent has accepted and processed.
outPkts	The number of SNMP Messages that the SNMP agent has sent.
outTooBigs	The number of SNMP PDUs that the SNMP agent has generated with the value 'tooBig' in the error-status field. This is sent to the SNMP manager to indicate that an exception occurred when processing a request from the manager.
outNoSuchNames	The number of SNMP PDUs that the SNMP agent has generated with the value 'noSuchName' in the error-status field. This is sent to the SNMP manager to indicate that an exception occurred when processing a request from the manager.
outBadValues	The number of SNMP PDUs that the SNMP agent has generated with the value 'badValue' in the error-status field. This is sent to the SNMP manager to indicate that an exception occurred when processing a request from the manager.
outGenErrs	The number of SNMP PDUs that the SNMP agent has generated with the value 'genErr' in the error-status field. This is sent to the SNMP manager to indicate that an exception occurred when processing a request from the manager.
outGetRequests	The number of SNMP Get-Request PDUs that the SNMP agent has generated.

**Table 1:** Parameters in the output of the **show counter snmp-server** command

Parameter	Meaning
outGetNexts	The number of SNMP Get-Next PDUs that the SNMP agent has generated.
outSetRequests	The number of SNMP Set-Request PDUs that the SNMP agent has generated.
outGetResponses	The number of SNMP Get-Response PDUs that the SNMP agent has generated.
outTraps	The number of SNMP Trap PDUs that the SNMP agent has generated.
UnsupportedSecurityLevels	The number of received packets that the SNMP agent has dropped because they requested a securityLevel unknown or not available to the SNMP agent.
NotInTimeWindows	The number of received packets that the SNMP agent has dropped because they appeared outside of the authoritative SNMP agent's window.
UnknownUserNames	The number of received packets that the SNMP agent has dropped because they referenced an unknown user.
UnknownEngineIDs	The number of received packets that the SNMP agent has dropped because they referenced an unknown snmpEngineID.
WrongDigest	The number of received packets that the SNMP agent has dropped because they didn't contain the expected digest value.
DecryptionErrors	The number of received packets that the SNMP agent has dropped because they could not be decrypted.
UnknownSecModels	The number of messages received that contain a security model that is not supported by the server. Valid for SNMPv3 messages only.
InvalidMsgs	The number of messages received where the security model is supported but the authentication fails. Valid for SNMPv3 messages only.
UnknownPDUHandlers	The number of times the SNMP handler has failed to process a PDU. This is a system debugging counter.

**Related commands** [show snmp-server](#)

# show debugging snmp

**Overview** This command displays whether SNMP debugging is enabled or disabled.

**Syntax** `show debugging snmp`

**Mode** User Exec and Privileged Exec

**Example** To display the status of SNMP debugging, use the command:

```
awplus# show debugging snmp
```

**Output** Figure 43-2: Example output from the **show debugging snmp** command

```
Sntp (SMUX) debugging status:  
Sntp debugging is on
```

**Related commands** [debug snmp](#)

# show running-config snmp

**Overview** This command displays the current configuration of SNMP on your device.

**Syntax** `show running-config snmp`

**Mode** Privileged Exec

**Example** To display the current configuration of SNMP on your device, use the command:

```
awplus# show running-config snmp
```

**Output** Figure 43-3: Example output from the **show running-config snmp** command

```
snmp-server contact AlliedTelesis
snmp-server location Philippines
snmp-server group grou1 auth read view1 write view1 notify view1
snmp-server view view1 1 included
snmp-server community public
snmp-server user user1 group1 auth md5 password priv des
password
```

**Related commands** [show snmp-server](#)

# show snmp-server

**Overview** This command displays the status and current configuration of the SNMP server.

**Syntax** `show snmp-server`

**Mode** Privileged Exec

**Example** To display the status of the SNMP server, use the command:

```
awplus# show snmp-server
```

**Output** Figure 43-4: Example output from the **show snmp-server** command

```
SNMP Server ..... Enabled
IP Protocol ..... IPv4
SNMPv3 Engine ID (configured name) ... Not set
SNMPv3 Engine ID (actual) ..... 0x80001f888021338e4747b8e607
```

- Related commands**
- [debug snmp](#)
  - [show counter snmp-server](#)
  - [snmp-server](#)
  - [snmp-server engineID local](#)
  - [snmp-server engineID local reset](#)

# show snmp-server community

**Overview** This command displays the SNMP server communities configured on the device. SNMP communities are specific to v1 and v2c.

**Syntax** `show snmp-server community`

**Mode** Privileged Exec

**Example** To display the SNMP server communities, use the command:

```
awplus# show snmp-server community
```

**Output** Figure 43-5: Example output from the **show snmp-server community** command

```
SNMP community information:
Community Name ..... public
Access ..... Read-only
View ..... none
```

**Related commands** [show snmp-server](#)  
[snmp-server community](#)

# show snmp-server group

**Overview** This command displays information about SNMP server groups. This command is used with SNMP version 3 only.

**Syntax** `show snmp-server group`

**Mode** Privileged Exec

**Example** To display the SNMP groups configured on the device, use the command:

```
awplus# show snmp-server group
```

**Output** Figure 43-6: Example output from the **show snmp-server group** command

```
SNMP group information:
  Group name ..... guireadgroup
  Security Level ..... priv
  Read View ..... guiview
  Write View ..... none
  Notify View ..... none

  Group name ..... guiwritegroup
  Security Level ..... priv
  Read View ..... none
  Write View ..... guiview
  Notify View ..... none
```

**Related commands** [show snmp-server](#)  
[snmp-server group](#)



# show snmp-server user

**Overview** This command displays the SNMP server users and is used with SNMP version 3 only.

**Syntax** `show snmp-server user`

**Mode** Privileged Exec

**Example** To display the SNMP server users configured on the device, use the command:

```
awplus# show snmp-server user
```

**Output** Figure 43-7: Example output from the **show snmp-server user** command

Name	Group name	Auth	Privacy
freddy	guireadgroup	none	none

**Related commands** [show snmp-server](#)  
[snmp-server user](#)

# show snmp-server view

**Overview** This command displays the SNMP server views and is used with SNMP version 3 only.

**Syntax** `show snmp-server view`

**Mode** Privileged Exec

**Example** To display the SNMP server views configured on the device, use the command:

```
awplus# show snmp-server view
```

**Output** Figure 43-8: Example output from the **show snmp-server view** command

```
SNMP view information:
View Name ..... view1
OID ..... 1
Type ..... included
```

**Related commands** [show snmp-server](#)  
[snmp-server view](#)

# snmp trap link-status

**Overview** Use this command to enable SNMP to send link status notifications (traps) for the interfaces when an interface goes up (linkUp) or down (linkDown).

Use the **no** variant of this command to disable the sending of link status notifications.

**Syntax** `snmp trap link-status [enterprise]`  
`no snmp trap link-status`

Parameter	Description
enterprise	Send an Allied Telesis enterprise type of link trap.

**Default** By default, link status notifications are disabled.

**Mode** Interface Configuration

**Usage notes** The link status notifications can be enabled for the following interface types:

- switch port (e.g. port1.0.1)
- VLAN (e.g. vlan2)
- static and dynamic link aggregation (e.g. sa2, po2)

To specify where notifications are sent, use the [snmp-server host](#) command. To configure the device globally to send other notifications, use the [snmp-server enable trap](#) command.

**Examples** To enable SNMP to send link status notifications for port1.0.1 to port1.0.3 use the following commands:

```
awplus# configure terminal
awplus(config)# interface port1.0.1-port1.0.3
awplus(config-if)# snmp trap link-status
```

To disable the sending of link status notifications for port1.0.1, use the following commands:

```
awplus# configure terminal
awplus(config)# interface port1.0.1
awplus(config-if)# no snmp trap link-status
```

**Related commands** [show interface](#)  
[snmp trap link-status suppress](#)  
[snmp-server enable trap](#)  
[snmp-server host](#)

# snmp trap link-status suppress

**Overview** Use this command to enable the suppression of link status notifications (traps) for the interfaces beyond the specified threshold, in the specified interval.

Use the **no** variant of this command to disable the suppression of link status notifications for the ports.

**Syntax** `snmp trap link-status suppress {time {<1-60>|default}|threshold {<1-20>|default}}`

`no snmp trap link-status suppress`

Parameter	Description
time	Set the suppression timer for link status notifications.
<1-60>	The suppress time in seconds.
default	The default suppress time in seconds (60).
threshold	Set the suppression threshold for link status notifications. This is the number of link status notifications after which to suppress further notifications within the suppression timer interval.
<1-20>	The number of link status notifications.
default	The default number of link status notifications (20).

**Default** By default, if link status notifications are enabled (they are enabled by default), the suppression of link status notifications is enabled: notifications that exceed the notification threshold (default 20) within the notification timer interval (default 60 seconds) are not sent.

**Mode** Interface Configuration

**Usage notes** An unstable network can generate many link status notifications. When notification suppression is enabled, a suppression timer is started when the first link status notification of a particular type (linkUp or linkDown) is sent for an interface. If the threshold number of notifications of this type is sent before the timer reaches the suppress time, any further notifications of this type generated for the interface during the interval are not sent. At the end of the interval, the sending of link status notifications resumes, until the threshold is reached in the next interval.

**Examples** To suppress link status notifications for port1.0.1 to port1.0.3 after 10 notifications in 40 seconds, use the following commands:

```
awplus# configure terminal
awplus(config)# interface port1.0.1-port1.0.3
awplus(config-if)# snmp trap link-status suppress time 40
threshold 10
```

To stop suppressing link status notifications for port1.0.1, use the following commands:

```
awplus# configure terminal
awplus(config)# interface port1.0.1
awplus(config-if)# no snmp trap link-status suppress
```

**Related commands**

- [show interface](#)
- [snmp trap link-status](#)

# snmp-server

**Overview** Use this command to enable the SNMP agent (server) on the device. The SNMP agent receives and processes SNMP packets sent to the device, and generates notifications (traps) that have been enabled by the [snmp-server enable trap](#) command.

Use the **no** variant of this command to disable the SNMP agent on the device. When SNMP is disabled, SNMP packets received by the device are discarded, and no notifications are generated. This does not remove any existing SNMP configuration.

**Syntax** `snmp-server [ip|ipv6]`  
`no snmp-server [ip|ipv6]`

Parameter	Description
ip	Enable or disable the SNMP agent for IPv4.
ipv6	Enable or disable the SNMP agent for IPv6.

**Default** By default, the SNMP agent is enabled for both IPv4 and IPv6. If neither the **ip** parameter nor the **ipv6** parameter is specified for this command, then SNMP is enabled or disabled for both IPv4 and IPv6.

**Mode** Global Configuration

**Examples** To enable SNMP on the device for both IPv4 and IPv6, use the commands:

```
awplus# configure terminal  
awplus(config)# snmp-server
```

To enable the SNMP agent for IPv4 on the device, use the commands:

```
awplus# configure terminal  
awplus(config)# snmp-server ip
```

To disable the SNMP agent for both IPv4 and IPv6 on the device, use the commands:

```
awplus# configure terminal  
awplus(config)# no snmp-server
```

To disable the SNMP agent for IPv4, use the commands:

```
awplus(config)# no snmp-server ipv4
```

**Related commands**

- show snmp-server
- show snmp-server community
- show snmp-server user
- snmp-server community
- snmp-server contact
- snmp-server enable trap
- snmp-server engineID local
- snmp-server group
- snmp-server host
- snmp-server location
- snmp-server view

# snmp-server community

**Overview** This command creates an SNMP community, optionally setting the access mode for the community. The default access mode is read only. If view is not specified, the community allows access to all the MIB objects. The SNMP communities are only valid for SNMPv1 and v2c and provide very limited security. Communities should not be used when operating SNMPv3.

The **no** variant of this command removes an SNMP community. The specified community must already exist on the device.

**Syntax** `snmp-server community <community-name> {view <view-name>|ro|rw|<access-list>}`  
`no snmp-server community <community-name> [{view <view-name>|<access-list>}]`

Parameter	Description
<code>&lt;community-name&gt;</code>	Community name. The community name is a case sensitive string of up to 20 characters.
<code>view</code>	Configure SNMP view. If view is not specified, the community allows access to all the MIB objects.
<code>&lt;view-name&gt;</code>	View name. The view name is a string up to 20 characters long and is case sensitive.
<code>ro</code>	Read-only community.
<code>rw</code>	Read-write community.
<code>&lt;access-list&gt;</code>	<code>&lt;1-99&gt;</code> Access list number.

**Mode** Global Configuration

**Example** The following command creates an SNMP community called “public” with read only access to all MIB variables from any management station.

```
awplus# configure terminal
awplus(config)# snmp-server community public ro
```

The following command removes an SNMP community called “public”

```
awplus# configure terminal
awplus(config)# no snmp-server community public
```

**Related commands** [show snmp-server](#)  
[show snmp-server community](#)  
[snmp-server view](#)



# snmp-server contact

**Overview** This command sets the contact information for the system. The contact name is:

- displayed in the output of the [show system](#) command
- stored in the MIB object sysContact

The **no** variant of this command removes the contact information from the system.

**Syntax** `snmp-server contact <contact-info>`  
`no snmp-server contact`

Parameter	Description
<code>&lt;contact-info&gt;</code>	The contact information for the system, from 0 to 255 characters long. Valid characters are any printable character and spaces.

**Mode** Global Configuration

**Example** To set the system contact information to “support@alliedtelesis.co.nz”, use the command:

```
awplus# configure terminal
awplus(config)# snmp-server contact
support@alliedtelesis.co.nz
```

**Related commands** [show system](#)  
[snmp-server location](#)  
[snmp-server group](#)

# snmp-server enable trap

**Overview** Use this command to enable the switch to transmit the specified notifications (traps).

Note that the Environmental Monitoring traps defined in the AT-ENVMONv2-MIB are enabled by default.

Use the **no** variant of this command to disable the transmission of the specified notifications.

**Syntax** `snmp-server enable trap <trap-list>`  
`no snmp-server enable trap <trap-list>`

Depending on your device model, you can enable some or all of the traps in the following table:

Parameter	Description
atmf	AMF traps.
atmflink	AMF link traps.
atmfnode	AMF node traps.
atmfrr	AMF reboot-rolling traps.
auth	Authentication failure.
bgp	BGP traps.
chassis	Chassis traps.
dhcpsnooping	DHCP snooping and ARP security traps. These notifications must also be set using the <b>ip dhcp snooping violation</b> command, and/or the arp security violation <b>arp security violation</b> command.
epsr	EPSR traps.
g8032	G.8032 ERP traps.
lldp	Link Layer Discovery Protocol (LLDP) traps. These notifications must also be enabled using the <b>lldp notifications</b> command, and/or the <b>lldp med-notifications</b> command.
loopprot	Loop Protection traps.
mstp	MSTP traps.
nsm	NSM traps.
ospf	OSPF traps.
pim	PIM traps.
power-inline	Power-inline traps (Power Ethernet MIB RFC 3621).
qsp	QoS Storm Protection

Parameter	Description
rmon	RMON traps.
thrash-limit	MAC address Thrash Limiting traps.
vcs	VCS traps.
vrrp	Virtual Router Redundancy (VRRP) traps.
ufo	Upstream Forwarding Only (UFO) traps.

**Default** By default, no notifications are generated.

**Mode** Global Configuration

**Usage notes** This command cannot be used to enable link status notifications globally. To enable link status notifications for particular interfaces, use the [snmp trap link-status](#) command.

To specify where notifications are sent, use the [snmp-server host](#) command.

Note that you can enable (or disable) multiple traps with a single command, by specifying a space-separated list of traps.

**Examples** To enable the device to send a notification if an AMF node changes its status, use the following commands:

```
awplus# configure terminal
awplus(config)# snmp-server enable trap atmfnode
```

To enable the device to send MAC address Thrash Limiting traps, use the following commands:

```
awplus# configure terminal
awplus(config)# snmp-server enable trap thrash-limit
```

To disable the device from sending MAC address Thrash Limiting traps, use the following commands:

```
awplus# configure terminal
awplus(config)# no snmp-server enable trap thrash-limit
```

**Related commands**

- [show snmp-server](#)
- [show ip dhcp snooping](#)
- [snmp trap link-status](#)
- [snmp-server host](#)

**Command changes** Version 5.4.7-2.1: **ufo** parameter added

# snmp-server engineID local

**Overview** Use this command to configure the SNMPv3 engine ID. The SNMPv3 engine ID is used to uniquely identify the SNMPv3 agent on a device when communicating with SNMP management clients. Once an SNMPv3 engine ID is assigned, this engine ID is permanently associated with the device until you change it.

Use the **no** variant of this command to set the user defined SNMPv3 engine ID to a system generated pseudo-random value by resetting the SNMPv3 engine. The **no snmp-server engineID local** command has the same effect as the **snmp-server engineID local default** command.

Note that the [snmp-server engineID local reset](#) command is used to force the system to generate a new engine ID when the current engine ID is also system generated.

**Syntax** `snmp-server engineID local {<engine-id>|default}`  
`no snmp-server engineID local`

Parameter	Description
<code>&lt;engine-id&gt;</code>	Specify SNMPv3 Engine ID value, a string of up to 27 characters.
<code>default</code>	Set SNMPv3 engine ID to a system generated value by resetting the SNMPv3 engine, provided the current engine ID is user defined. If the current engine ID is system generated, use the <a href="#">snmp-server engineID local reset</a> command to force the system to generate a new engine ID.

**Mode** Global Configuration

**Usage notes** All devices must have a unique engine ID which is permanently set unless it is configured by the user.

**Example** To set the SNMPv3 engine ID to 800000cf030000cd123456, use the following commands:

```
awplus# configure terminal
awplus(config)# snmp-server engineID local
800000cf030000cd123456
```

To set a user defined SNMPv3 engine ID back to a system generated value, use the following commands:

```
awplus# configure terminal
awplus(config)# no snmp-server engineID local
```

**Output** The following example shows the engine ID values after configuration:

```
awplus(config)#snmp-server engineid local asdgdh231234d
awplus(config)#exit
awplus#show snmp-server

SNMP Server ..... Enabled
IP Protocol ..... IPv4
SNMPv3 Engine ID (configured name) ... asdgdh231234d
SNMPv3 Engine ID (actual) ..... 0x80001f888029af52e149198483

awplus(config)#no snmp-server engineid local
awplus(config)#exit
awplus#show snmp-server

SNMP Server ..... Enabled
IP Protocol ..... IPv4
SNMPv3 Engine ID (configured name) ... Not set
SNMPv3 Engine ID (actual) ..... 0x80001f888029af52e149198483
```

**Related commands**

- [show snmp-server](#)
- [snmp-server engineID local reset](#)
- [snmp-server group](#)

# snmp-server engineID local reset

**Overview** Use this command to force the device to generate a new pseudo-random SNMPv3 engine ID by resetting the SNMPv3 engine. If the current engine ID is user defined, use the [snmp-server engineID local](#) command to set SNMPv3 engine ID to a system generated value.

**Syntax** `snmp-server engineID local reset`

**Mode** Global Configuration

**Example** To force the SNMPv3 engine ID to be reset to a system generated value, use the commands:

```
awplus# configure terminal
awplus(config)# snmp-server engineID local reset
```

**Related commands** [snmp-server engineID local](#)  
[show snmp-server](#)

# snmp-server group

**Overview** This command is used with SNMP version 3 only, and adds an SNMP group, optionally setting the security level and view access modes for the group. The security and access views defined for the group represent the minimum required of its users in order to gain access.

The **no** variant of this command deletes an SNMP group, and is used with SNMPv3 only. The group with the specified authentication/encryption parameters must already exist.

**Syntax** `snmp-server group <groupname> {auth|noauth|priv} [read <readname>|write <writename>|notify <notifysname>]`  
`no snmp-server group <groupname> {auth|noauth|priv}`

Parameter	Description
<groupname>	Group name. The group name is a string up to 20 characters long and is case sensitive.
auth	Authentication.
noauth	No authentication and no encryption.
priv	Authentication and encryption.
read	Configure read view.
<readname>	Read view name.
write	Configure write view.
<writename>	Write view name. The view name is a string up to 20 characters long and is case sensitive.
notify	Configure notify view.
<notifysname>	Notify view name. The view name is a string up to 20 characters long and is case sensitive.

**Mode** Global Configuration

**Examples** To add SNMP group, for ordinary users, use the following commands:

```
awplus# configure terminal
awplus(config)# snmp-server group usergroup noauth read
useraccess write useraccess
```

To delete SNMP group `usergroup`, use the following commands

```
awplus# configure terminal
awplus(config)# no snmp-server group usergroup noauth
```

**Related commands**

- snmp-server
- show snmp-server
- show snmp-server group
- show snmp-server user



# snmp-server host

**Overview** This command specifies an SNMP trap host destination to which Trap or Inform messages generated by the device are sent.

For SNMP version 1 and 2c you must specify the community name parameter. For SNMP version 3, specify the authentication/encryption parameters and the user name. If the version is not specified, the default is SNMP version 1. Inform messages can be sent instead of traps for SNMP version 2c and 3.

Use the **no** variant of this command to remove an SNMP trap host. The trap host must already exist.

The trap host is uniquely identified by:

- host IP address (IPv4 or IPv6),
- inform or trap messages,
- community name (SNMPv1 or SNMP v2c) or the authentication/encryption parameters and user name (SNMP v3).

**Syntax**

```
snmp-server host {<ipv4-address>/<ipv6-address>} [traps]
[version 1] <community-name>]

snmp-server host {<ipv4-address>/<ipv6-address>}
[informs|traps] version 2c <community-name>

snmp-server host {<ipv4-address>/<ipv6-address>}
[informs|traps] version 3 {auth|noauth|priv} <user-name>

no snmp-server host {<ipv4-address>/<ipv6-address>} [traps]
[version 1] <community-name>

no snmp-server host {<ipv4-address>/<ipv6-address>}
[informs|traps] version 2c <community-name>

no snmp-server host {<ipv4-address>/<ipv6-address>}
[informs|traps] version 3 {auth|noauth|priv} <user-name>
```

Parameter	Description
<ipv4-address>	IPv4 trap host address in the format A . B . C . D, for example, 192 . 0 . 2 . 2.
<ipv6-address>	IPv6 trap host address in the format x : x : : x : x for example, 2001 : db8 : : 8a2e : 7334.
informs	Send Inform messages to this host.
traps	Send Trap messages to this host (default).
version	SNMP version to use for notification messages. Default: version 1.
1	Use SNMPv1 (default).
2c	Use SNMPv2c.
3	Use SNMPv3.

Parameter	Description
auth	Authentication.
noauth	No authentication.
priv	Encryption.
<community-name>	The SNMPv1 or SNMPv2c community name.
<user-name>	SNMPv3 user name.

**Mode** Global Configuration

**Examples** To configure the device to send generated traps to the IPv4 host destination 192.0.2.5 with the SNMPv2c community name public, use the following command:

```
awplus# configure terminal
awplus(config)# snmp-server host version 2c public192.0.2.5
```

To configure the device to send generated traps to the IPv6 host destination 2001:db8::8a2e:7334 with the SNMPv2c community name private, use the following command:

```
awplus# configure terminal
awplus(config)# snmp-server host version 2c
private2001:db8::8a2e:7334
```

To remove a configured trap host of 192.0.2.5 with the SNMPv2c community name public, use the following command:

```
awplus# configure terminal
awplus(config)# no snmp-server host version 2c public192.0.2.5
```

**Related commands**

- [snmp trap link-status](#)
- [snmp-server enable trap](#)
- [snmp-server view](#)

# snmp-server legacy-ifadminstatus

**Overview** Use this command to set the ifAdminStatus to reflect the operational state of the interface, rather than the administrative state.

The **no** variant of this command sets the ifAdminStatus to reflect the administrative state of the interface.

**Syntax** `snmp-server legacy-ifadminstatus`  
`no snmp-server legacy-ifadminstatus`

**Default** Legacy ifAdminStatus is turned off by default, so by default the SNMP ifAdminStatus reflects the administrative state of the interface.

**Mode** Global Configuration

**Usage notes** Note that if you enable Legacy ifAdminStatus, the ifAdminStatus will report a link's status as Down when the link has been blocked by a process such as loop protection.

**Example** To turn on Legacy ifAdminStatus, use the command:

```
awplus#snmp-server legacy-ifadminstatus
```

**Related commands** [show interface](#)

# snmp-server location

**Overview** This command sets the location of the system. The location is:

- displayed in the output of the [show system](#) command
- stored in the MIB object sysLocation

The **no** variant of this command removes the configured location from the system.

**Syntax** `snmp-server location <location-name>`  
`no snmp-server location`

Parameter	Description
<code>&lt;location-name&gt;</code>	The location of the system, from 0 to 255 characters long. Valid characters are any printable character and spaces.

**Mode** Global Configuration

**Example** To set the location to “server room 523”, use the following commands:

```
awplus# configure terminal
awplus(config)# snmp-server location server room 523
```

**Related commands** [show snmp-server](#)  
[show system](#)  
[snmp-server contact](#)

# snmp-server source-interface

**Overview** Use this command to specify the originating interface for SNMP traps or informs. An interface specified by this command must already have an IP address assigned to it.

Use the **no** variant of this command to reset the interface to its default value (the originating egress interface).

**Syntax** `snmp-server source-interface {traps|informs} <interface-name>`  
`no snmp-server source-interface {traps|informs}`

Parameter	Description
traps	SNMP traps.
informs	SNMP informs.
<interface-name>	Interface name (must already have an IP address assigned).

**Default** By default, the source interface is the originating egress interface of the traps and informs messages.

**Mode** Global Configuration

**Usage notes** An SNMP trap or inform message that is sent from an SNMP server carries the notification IP address of its originating interface. Use this command to assign this interface.

**Example** The following commands set vlan2 to be the interface whose IP address is used as the originating address in SNMP informs packets.

```
awplus# configure terminal
awplus(config)# snmp-server source-interface informs vlan2
```

The following commands reset the originating source interface for SNMP trap messages to be the default interface (the originating egress interface):

```
awplus# configure terminal
awplus(config)# no snmp-server source-interface traps
```

**Validation Commands** `show running-config`

# snmp-server startup-trap-delay

**Overview** Use this command to set the time in seconds after following completion of the device startup sequence before the device sends any SNMP traps (or SNMP notifications).

Use the no variant of this command to restore the default startup delay of 30 seconds.

**Syntax** `snmp-server startup-trap-delay <delay-time>`  
`no snmp-server startup-trap-delay`

Parameter	Description
<code>&lt;delay-time&gt;</code>	Specify an SNMP trap delay time in seconds in the range of 30 to 600 seconds.

**Default** The SNMP server trap delay time is 30 seconds. The no variant restores the default.

**Mode** Global Configuration

**Example** To delay the device sending SNMP traps until 60 seconds after device startup, use the following commands:

```
awplus# configure terminal
awplus(config)# snmp-server startup-trap-delay 60
```

To restore the sending of SNMP traps to the default of 30 seconds after device startup, use the following commands:

```
awplus# configure terminal
awplus(config)# no snmp-server startup-trap-delay
```

**Validation Commands** `show snmp-server`

# snmp-server user

**Overview** Use this command to create or move users as members of specified groups. This command is used with SNMPv3 only.

The **no** variant of this command removes an SNMPv3 user. The specified user must already exist.

**Syntax** `snmp-server user <username> <groupname> [encrypted] [auth {md5|sha} <auth-password>] [priv {des|aes} <privacy-password>]`  
`no snmp-server user <username>`

Parameter	Description
<code>&lt;username&gt;</code>	User name. The user name is a string up to 20 characters long and is case sensitive.
<code>&lt;groupname&gt;</code>	Group name. The group name is a string up to 20 characters long and is case sensitive.
<code>encrypted</code>	Use the encrypted parameter when you want to enter encrypted passwords.
<code>auth</code>	Authentication protocol.
<code>md5</code>	MD5 Message Digest Algorithms.
<code>sha</code>	SHA Secure Hash Algorithm.
<code>&lt;auth-password&gt;</code>	Authentication password. The password is a string of 8 to 20 characters long and is case sensitive.
<code>priv</code>	Privacy protocol.
<code>des</code>	DES: Data Encryption Standard.
<code>aes</code>	AES: Advanced Encryption Standards.
<code>&lt;privacy-password&gt;</code>	Privacy password. The password is a string of 8 to 20 characters long and is case sensitive.

**Mode** Global Configuration

**Usage notes** Additionally this command provides the option of selecting an authentication protocol and (where appropriate) an associated password. Similarly, options are offered for selecting a privacy protocol and password.

- Note that each SNMP user must be configured on both the manager and agent entities. Where passwords are used, these passwords must be the same for both entities.
- Use the **encrypted** parameter when you want to enter already encrypted passwords in encrypted form as displayed in the running and startup configs stored on the device. For example, you may need to move a user from one group to another group and keep the same passwords for the user instead of removing the user to apply new passwords.

- User passwords are entered using plaintext without the **encrypted** parameter and are encrypted according to the authentication and privacy protocols selected.
- User passwords are viewed as encrypted passwords in running and startup configs shown from **show running-config** and **show startup-config** commands respectively. Copy and paste encrypted passwords from running-configs or startup-configs to avoid entry errors.

**Examples** To add SNMP user authuser as a member of group “usergroup”, with authentication protocol MD5, authentication password “Authpass”, privacy protocol AES and privacy password “Privpass”, use the following commands:

```
awplus# configure terminal
awplus(config)# snmp-server user authuser usergroup auth md5
Authpass priv aes Privpass
```

Validate the user is assigned to the group using the **show snmp-server user** command:

```
awplus#show snmp-server user
Name                Group name          Auth                Privacy
-----            -
authuser            usergroup           md5                 aes
```

To enter existing SNMP user “authuser” with existing passwords as a member of group “newusergroup” with authentication protocol MD5 with the encrypted authentication password 0x1c74b9c22118291b0ce0cd883f8dab6b74, and privacy protocol AES with the encrypted privacy password 0x0e0133db5453ebd03822b004eeacb6608f, use the following commands:

```
awplus# configure terminal
awplus(config)# snmp-server user authuser newusergroup
encrypted auth md5 0x1c74b9c22118291b0ce0cd883f8dab6b74 priv
aes 0x0e0133db5453ebd03822b004eeacb6608f
```

**NOTE:** Copy and paste the encrypted passwords from the **running-config** or the **startup-config** displayed, using the **show running-config** and **show startup-config** commands respectively, into the command line to avoid key stroke errors issuing this command.

Validate the user has been moved from the first group using the **show snmp-server user** command:

```
awplus#show snmp-server user
Name                Group name          Auth                Privacy
-----            -
authuser            newusergroup        md5                 aes
```

To delete SNMP user “authuser”, use the following commands:

```
awplus# configure terminal
awplus(config)# no snmp-server user authuser
```



**Related  
commands** [show snmp-server user](#)  
[snmp-server view](#)

# snmp-server view

**Overview** Use this command to create an SNMP view that specifies a sub-tree of the MIB. Further sub-trees can then be added by specifying a new OID to an existing view. Views can be used in SNMP communities or groups to control the remote manager's access.

**NOTE:** The object identifier must be specified in a sequence of integers separated by decimal points.

The **no** variant of this command removes the specified view on the device. The view must already exist.

**Syntax** `snmp-server view <view-name> <mib-name> {included|excluded}`  
`no snmp-server view <view-name>`

Parameter	Description
<view-name>	SNMP server view name. The view name is a string up to 20 characters long and is case sensitive.
<mib-name>	Object identifier of the MIB.
included	Include this OID in the view.
excluded	Exclude this OID in the view.

**Mode** Global Configuration

**Examples** The following command creates a view called "loc" that includes the system location MIB sub-tree.

```
awplus(config)# snmp-server view loc 1.3.6.1.2.1.1.6.0 included
```

To remove the view "loc" use the following command

```
awplus(config)# no snmp-server view loc
```

**Related commands** [show snmp-server view](#)  
[snmp-server community](#)

# undebbug snmp

**Overview** This command applies the functionality of the no `debug snmp` command.

# 44

# LLDP Commands

## Introduction

**Overview** LLDP and LLDP-MED can be configured using the commands in this chapter, or by using SNMP with the LLDP-MIB and LLDP-EXT-DOT1-MIB (see the [Support for Allied Telesis Enterprise MIBs in AlliedWare Plus](#)).

The Voice VLAN feature can be configured using commands in [VLAN Commands](#) chapter.

For more information about LLDP, see the [LLDP Feature Overview and Configuration Guide](#).

LLDP can transmit a lot of data about the network. Typically, the network information gathered using LLDP is transferred to a Network Management System by SNMP. For security reasons, we recommend using SNMPv3 for this purpose (see the [SNMP Feature Overview and Configuration Guide](#)).

LLDP operates over physical ports only. For example, it can be configured on switch ports that belong to static or dynamic channel groups, but not on the channel groups themselves.

- Command List**
- [“clear lldp statistics”](#) on page 1758
  - [“clear lldp table”](#) on page 1759
  - [“debug lldp”](#) on page 1760
  - [“lldp faststart-count”](#) on page 1762
  - [“lldp holdtime-multiplier”](#) on page 1763
  - [“lldp management-address”](#) on page 1764
  - [“lldp med-notifications”](#) on page 1765
  - [“lldp med-tlv-select”](#) on page 1766
  - [“lldp non-strict-med-tlv-order-check”](#) on page 1769
  - [“lldp notification-interval”](#) on page 1770
  - [“lldp notifications”](#) on page 1771

- ["lldp port-number-type"](#) on page 1772
- ["lldp reinit"](#) on page 1773
- ["lldp run"](#) on page 1774
- ["lldp timer"](#) on page 1775
- ["lldp tlv-select"](#) on page 1776
- ["lldp transmit receive"](#) on page 1778
- ["lldp tx-delay"](#) on page 1779
- ["location civic-location configuration"](#) on page 1780
- ["location civic-location identifier"](#) on page 1784
- ["location civic-location id"](#) on page 1785
- ["location coord-location configuration"](#) on page 1786
- ["location coord-location identifier"](#) on page 1788
- ["location coord-location id"](#) on page 1789
- ["location elin-location"](#) on page 1791
- ["location elin-location id"](#) on page 1792
- ["show debugging lldp"](#) on page 1793
- ["show lldp"](#) on page 1795
- ["show lldp interface"](#) on page 1797
- ["show lldp local-info"](#) on page 1799
- ["show lldp neighbors"](#) on page 1804
- ["show lldp neighbors detail"](#) on page 1806
- ["show lldp statistics"](#) on page 1810
- ["show lldp statistics interface"](#) on page 1812
- ["show location"](#) on page 1814

# clear lldp statistics

**Overview** This command clears all LLDP statistics (packet and event counters) associated with specified ports. If no port list is supplied, LLDP statistics for all ports are cleared.

**Syntax** `clear lldp statistics [interface <port-list>]`

Parameter	Description
<port-list>	The ports for which the statistics are to be cleared.

**Mode** Privileged Exec

**Examples** To clear the LLDP statistics on ports 1.0.1 and 1.0.6, use the command:

```
awplus# clear lldp statistics interface port1.0.1,port1.0.6
```

To clear all LLDP statistics for all ports, use the command:

```
awplus# clear lldp statistics
```

**Related commands** [show lldp statistics](#)  
[show lldp statistics interface](#)

**Command changes** Version 5.4.8-2.1: Command added to AR2050V, AR3050S, AR4050S

# clear lldp table

**Overview** This command clears the table of LLDP information received from neighbors through specified ports. If no port list is supplied, neighbor information is cleared for all ports.

**Syntax** `clear lldp table [interface <port-list>]`

Parameter	Description
<code>&lt;port-list&gt;</code>	The ports for which the neighbor information table is to be cleared.

**Mode** Privileged Exec

**Examples** To clear the table of neighbor information received on ports 1.0.1 and 1.0.6, use the command:

```
awplus# clear lldp table interface port1.0.1,port1.0.6
```

To clear the entire table of neighbor information received through all ports, use the command:

```
awplus# clear lldp table
```

**Related commands** [show lldp neighbors](#)

# debug lldp

**Overview** This command enables specific LLDP debug for specified ports. When LLDP debugging is enabled, diagnostic messages are entered into the system log. If no port list is supplied, the specified debugging is enabled for all ports.

The **no** variant of this command disables specific LLDP debug for specified ports. If no port list is supplied, the specified debugging is disabled for all ports.

**Syntax** debug lldp {[rx][rxpkt][tx][txpkt]} [interface [<port-list>]]  
 debug lldp operation  
 no debug lldp {[rx][rxpkt][tx][txpkt]} [interface [<port-list>]]  
 no debug lldp operation  
 no debug lldp all

Parameter	Description
rx	LLDP receive debug.
rxpkt	Raw LLDPDUs received in hex format.
tx	LLDP transmit debug.
txpkt	Raw Tx LLDPDUs transmitted in hex format.
<port-list>	The ports for which debug is to be configured.
operation	Debug for LLDP internal operation on the switch.
all	Disables all LLDP debugging for all ports.

**Default** By default no debug is enabled for any ports.

**Mode** Privileged Exec

**Examples** To enable debugging of LLDP receive on ports 1.0.1 and 1.0.6, use the command:

```
awplus# debug lldp rx interface port1.0.1,port1.0.6
```

To enable debugging of LLDP transmit with packet dump on all ports, use the command:

```
awplus# debug lldp tx txpkt
```

To disable debugging of LLDP receive on ports 1.0.1 and 1.0.6, use the command:

```
awplus# no debug lldp rx interface port1.0.1,port1.0.6
```

To turn off all LLDP debugging on all ports, use the command:

```
awplus# no debug lldp all
```



**Related commands** show debugging lldp  
show running-config lldp  
terminal monitor

# lldp faststart-count

**Overview** Use this command to set the fast start count for LLDP-MED. The fast start count determines how many fast start advertisements LLDP sends from a port when it starts sending LLDP-MED advertisements from the port, for instance, when it detects a new LLDP-MED capable device.

The **no** variant of this command resets the LLDP-MED fast start count to the default (3).

**Syntax** `lldp faststart-count <1-10>`  
`no lldp faststart-count`

Parameter	Description
<1-10>	The number of fast start advertisements to send.

**Default** The default fast start count is 3.

**Mode** Global Configuration

**Examples** To set the fast start count to 5, use the command:

```
awplus# configure terminal  
awplus(config)# lldp faststart-count 5
```

To reset the fast start count to the default setting (3), use the command:

```
awplus# configure terminal  
awplus(config)# no lldp faststart-count
```

**Related commands** [show lldp](#)

# Ildp holdtime-multiplier

**Overview** This command sets the holdtime multiplier value. The transmit interval is multiplied by the holdtime multiplier to give the Time To Live (TTL) value that is advertised to neighbors.

The **no** variant of this command sets the multiplier back to its default.

**Syntax** `lldp holdtime-multiplier <2-10>`  
`no lldp holdtime-multiplier`

Parameter	Description
<2-10>	The multiplier factor.

**Default** The default holdtime multiplier value is 4.

**Mode** Global Configuration

**Usage** The Time-To-Live defines the period for which the information advertised to the neighbor is valid. If the Time-To-Live expires before the neighbor receives another update of the information, then the neighbor discards the information from its database.

**Examples** To set the holdtime multiplier to 2, use the commands:

```
awplus# configure terminal
awplus(config)# lldp holdtime-multiplier 2
```

To set the holdtime multiplier back to its default, use the commands:

```
awplus# configure terminal
awplus(config)# no lldp holdtime-multiplier 2
```

**Related commands** [show lldp](#)

# Ildp management-address

**Overview** This command sets the IPv4 address to be advertised to neighbors (in the Management Address TLV) via the specified ports. This address will override the default address for these ports.

The **no** variant of this command clears the user-configured management IP address advertised to neighbors via the specified ports. The advertised address reverts to the default.

**Syntax** `lldp management-address <ipaddr>`  
`no lldp management-address`

Parameter	Description
<code>&lt;ipaddr&gt;</code>	The IPv4 address to be advertised to neighbors, in dotted decimal format. This must be one of the IP addresses already configured on the device.

**Default** The local loopback interface primary IPv4 address if set, else the primary IPv4 interface address of the lowest numbered VLAN the port belongs to, else the MAC address of the device's baseboard if no VLAN IP addresses are configured for the port.

**Mode** Interface Configuration

**Usage notes** To see the management address that will be advertised, use the [show lldp interface](#) command or [show lldp local-info](#) command.

**Examples** To set the management address advertised by port1.0.1 and port1.0.2, to be 192.168.1.6, use the commands:

```
awplus# configure terminal
awplus(config)# interface port1.0.1,port1.0.2
awplus(config-if)# lldp management-address 192.168.1.6
```

To clear the user-configured management address advertised by port1.0.1 and port1.0.2, and revert to using the default address, use the commands:

```
awplus# configure terminal
awplus(config)# interface port1.0.1,port1.0.2
awplus(config-if)# no lldp management-address
```

**Related commands** [show lldp interface](#)  
[show lldp local-info](#)

**Command changes** Version 5.4.8-2.1: Command added to AR2050V, AR3050S, AR4050S

# lldp med-notifications

**Overview** Use this command to enable LLDP to send LLDP-MED Topology Change Detected SNMP notifications relating to the specified ports. The switch sends an SNMP event notification when a new LLDP-MED compliant IP Telephony device is connected to or disconnected from a port on the switch.

Use the **no** variant of this command to disable the sending of LLDP-MED Topology Change Detected notifications relating to the specified ports.

**Syntax** `lldp med-notifications`  
`no lldp med-notifications`

**Default** The sending of LLDP-MED notifications is disabled by default.

**Mode** Interface Configuration

**Examples** To enable the sending of LLDP-MED Topology Change Detected notifications relating to ports port1.0.1 and port1.0.2, use the commands:

```
awplus# configure terminal
awplus(config)# interface port1.0.1,port1.0.2
awplus(config-if)# lldp med-notifications
```

To disable the sending of LLDP-MED notifications relating to port1.0.1 and port1.0.2, use the commands:

```
awplus# configure terminal
awplus(config)# interface port1.0.1,port1.0.2
awplus(config-if)# no lldp med-notifications
```

**Related commands** [lldp notification-interval](#)  
[lldp notifications](#)  
[snmp-server enable trap](#)  
[show lldp interface](#)

**Command changes** Version 5.4.8-2.1: Command added to AR2050V, AR3050S, AR4050S

# lldp med-tlv-select

**Overview** Use this command to enable LLDP-MED Organizationally Specific TLVs for transmission in LLDP advertisements via the specified ports. The LLDP-MED Capabilities TLV must be enabled before any of the other LLDP-MED Organizationally Specific TLVs are enabled.

Use the **no** variant of this command to disable the specified LLDP-MED Organizationally Specific TLVs for transmission in LLDP advertisements via these ports. In order to disable the LLDP-MED Capabilities TLV, you must also disable the rest of these TLVs. Disabling all these TLVs disables LLDP-MED advertisements.

**Syntax**

```
lldp med-tlv-select [capabilities] [network-policy] [location]
[inventory-management]

lldp med-tlv-select all

no lldp med-tlv-select [capabilities] [network-policy]
[location] [inventory-management]

no lldp med-tlv-select all
```

Parameter	Description
capabilities	LLDP-MED Capabilities TLV. When this is enabled, the MAC/PHY Configuration/Status TLV from IEEE 802.3 Organizationally Specific TLVs is also automatically included in LLDP-MED advertisements, whether or not it has been explicitly enabled by the <code>lldp tlv-select</code> command.
network-policy	Network Policy TLV. This TLV is transmitted if Voice VLAN parameters have been configured using the commands: <ul style="list-style-type: none"><li><code>switchport voice dscp</code></li><li><code>switchport voice vlan</code></li><li><code>switchport voice vlan priority</code></li></ul>
location	Location Identification TLV. This TLV is transmitted if location information has been configured using the commands: <ul style="list-style-type: none"><li><code>location elin-location-id</code></li><li><code>location civic-location identifier</code></li><li><code>location civic-location configuration</code></li><li><code>location coord-location identifier</code></li><li><code>location coord-location configuration</code></li><li><code>location elin-location</code></li></ul>

Parameter	Description
inventory-management	Inventory Management TLV Set, including the following TLVs: <ul style="list-style-type: none"> <li>• Hardware Revision</li> <li>• Firmware Revision</li> <li>• Software Revision</li> <li>• Serial Number</li> <li>• Manufacturer Name</li> <li>• Model Name</li> <li>• Asset ID</li> </ul>
all	All LLDP-MED Organizationally Specific TLVs.

**Default** By default LLDP-MED Capabilities, Network Policy, Location Identification and Extended Power-via-MDI TLVs are enabled. Therefore, if LLDP is enabled using the `lldp run` command, by default LLDP-MED advertisements are transmitted on ports that detect LLDP-MED neighbors connected to them.

**Mode** Interface Configuration

**Usage notes** LLDP-MED TLVs are only sent in advertisements via a port if there is an LLDP-MED-capable device connected to it. To see whether there are LLDP-MED capable devices connected to the ports, use the `show lldp neighbors` command.

**Examples** To enable inclusion of the Inventory TLV Set in advertisements transmitted via port1.0.1 and port1.0.2, use the commands:

```
awplus# configure terminal
awplus(config)# interface port1.0.1,port1.0.2
awplus(config-if)# lldp med-tlv-select inventory-management
```

To exclude the Inventory TLV Set in advertisements transmitted via port1.0.1 and port1.0.2, use the commands:

```
awplus# configure terminal
awplus(config)# interface port1.0.1,port1.0.2
awplus(config-if)# no lldp med-tlv-select inventory-management
```

To disable LLDP-MED advertisements transmitted via port1.0.1 and port1.0.2, disable all these TLVs using the commands:

```
awplus# configure terminal
awplus(config)# interface port1.0.1,port1.0.2
awplus(config-if)# no lldp med-tlv-select all
```

**Related commands**

- lldp tlv-select
- location elin-location-id
- location civic-location identifier
- location civic-location configuration
- location coord-location identifier
- location coord-location configuration
- location elin-location
- show lldp interface
- switchport voice dscp
- switchport voice vlan
- switchport voice vlan priority

**Command changes** Version 5.4.8-2.1: Command added to AR2050V, AR3050S, AR4050S



# lldp non-strict-med-tlv-order-check

**Overview** Use this command to enable non-strict order checking for LLDP-MED advertisements it receives. That is, use this command to enable LLDP to receive and store TLVs from LLDP-MED advertisements even if they do not use standard TLV order.

Use the **no** variant of this command to disable non-strict order checking for LLDP-MED advertisements, that is, to set strict TLV order checking, so that LLDP discards any LLDP-MED TLVs that occur before the LLDP-MED Capabilities TLV in an advertisement.

**Syntax** `lldp non-strict-med-tlv-order-check`  
`no lldp non-strict-med-tlv-order-check`

**Default** By default TLV non-strict order checking for LLDP-MED advertisements is disabled. That is, strict order checking is applied to LLDP-MED advertisements, according to ANSI/TIA-1057, and LLDP-MED TLVs in non-standard order are discarded.

**Mode** Global Configuration

**Usage notes** The ANSI/TIA-1057 specifies standard order for TLVs in LLDP-MED advertisements, and specifies that if LLDP receives LLDP advertisements with non-standard LLDP-MED TLV order, the TLVs in non-standard order should be discarded. This implementation of LLDP-MED follows the standard: it transmits TLVs in the standard order, and by default discards LLDP-MED TLVs that occur before the LLDP-MED Capabilities TLV in an advertisement. However, some implementations of LLDP transmit LLDP-MED advertisements with non-standard TLV order. To receive and store the data from these non-standard advertisements, enable non-strict order checking for LLDP-MED advertisements using this command.

**Examples** To enable strict TLV order checking, use the commands:

```
awplus# configure terminal
awplus(config)# lldp tlv-order-check
```

To disable strict TLV order checking, use the commands:

```
awplus# configure terminal
awplus(config)# no lldp tlv-order-check
```

**Related commands** [show running-config lldp](#)

# lldp notification-interval

**Overview** This command sets the notification interval. This is the minimum interval between LLDP SNMP notifications (traps) of each kind (LLDP Remote Tables Change Notification and LLDP-MED Topology Change Notification).

The **no** variant of this command sets the notification interval back to its default.

**Syntax** `lldp notification-interval <5-3600>`  
`no lldp notification-interval`

Parameter	Description
<5-3600>	The interval in seconds.

**Default** The default notification interval is 5 seconds.

**Mode** Global Configuration

**Examples** To set the notification interval to 20 seconds, use the commands:

```
awplus# configure terminal
awplus(config)# lldp notification-interval 20
```

To set the notification interval back to its default, use the commands:

```
awplus# configure terminal
awplus(config)# no lldp notification-interval
```

**Related commands** [lldp notifications](#)  
[show lldp](#)

# Ildp notifications

**Overview** This command enables the sending of LLDP SNMP notifications (traps) relating to specified ports.

The **no** variant of this command disables the sending of LLDP SNMP notifications for specified ports.

**Syntax** `lldp notifications`  
`no lldp notifications`

**Default** The sending of LLDP SNMP notifications is disabled by default.

**Mode** Interface Configuration

**Examples** To enable sending of LLDP SNMP notifications for ports 1.0.1 and 1.0.6, use the commands:

```
awplus# configure terminal
awplus(config)# interface port1.0.1,port1.0.6
awplus(config-if)# lldp notifications
```

To disable sending of LLDP SNMP notifications for ports 1.0.1 and 1.0.6, use the commands:

```
awplus# configure terminal
awplus(config)# interface port1.0.1,port1.0.6
awplus(config-if)# no lldp notifications
```

**Related commands**

- [lldp notification-interval](#)
- [show lldp interface](#)
- [snmp-server enable trap](#)

# lldp port-number-type

**Overview** This command sets the type of port identifier used to enumerate, that is to count, the LLDP MIB local port entries. The LLDP MIB (IEEE Standard 802.1AB-2005, Section 12, LLDP MIB Definitions.) requires the port number value to count LLDP local port entries.

This command also enables you to optionally set an interface index to enumerate the LLDP MIB local port entries, if required by your management system.

The **no** variant of this command resets the type of port identifier back to the default setting (number).

**Syntax** `lldp port-number-type [number|ifindex]`  
`no lldp port-number-type`

Parameter	Description
number	Set the type of port identifier to a port number to enumerate the LLDP MIB local port entries.
ifindex	Set the type of port identifier to an interface index to enumerate the LLDP MIB local port entries.

**Default** The default port identifier type is number. The no variant of this command sets the port identifier type to the default.

**Mode** Global Configuration

**Examples** To set the type of port identifier used to enumerate LLDP MIB local port entries to port numbers, use the commands:

```
awplus# configure terminal
awplus(config)# lldp port-number-type number
```

To set the type of port identifier used to enumerate LLDP MIB local port entries to interface indexes, use the commands:

```
awplus# configure terminal
awplus(config)# lldp port-number-type ifindex
```

To reset the type of port identifier used to enumerate LLDP MIB local port entries the default (port numbers), use the commands:

```
awplus# configure terminal
awplus(config)# no lldp port-number-type
```

**Related commands** [show lldp](#)

# Ildp reinit

**Overview** This command sets the value of the reinitialization delay. This is the minimum time after disabling LLDP on a port before it can reinitialize.

The **no** variant of this command sets the reinitialization delay back to its default setting.

**Syntax** `lldp reinit <1-10>`  
`no lldp reinit`

Parameter	Description
<1-10>	The delay in seconds.

**Default** The default reinitialization delay is 2 seconds.

**Mode** Global Configuration

**Examples** To set the reinitialization delay to 3 seconds, use the commands:

```
awplus# configure terminal
awplus(config)# lldp reinit 3
```

To set the reinitialization delay back to its default, use the commands:

```
awplus# configure terminal
awplus(config)# no lldp reinit
```

**Related commands** [show lldp](#)

# lldp run

**Overview** This command enables the operation of LLDP on the device.  
The **no** variant of this command disables the operation of LLDP on the device. The LLDP configuration remains unchanged.

**Syntax** lldp run  
no lldp run

**Default** LLDP is disabled by default.

**Mode** Global Configuration

**Examples** To enable LLDP operation, use the commands:

```
awplus# configure terminal  
awplus(config)# lldp run
```

To disable LLDP operation, use the commands:

```
awplus# configure terminal  
awplus(config)# no lldp run
```

**Related commands** [show lldp](#)

# lldp timer

**Overview** This command sets the value of the transmit interval. This is the interval between regular transmissions of LLDP advertisements.

The **no** variant of this command sets the transmit interval back to its default.

**Syntax** `lldp timer <5-32768>`  
`no lldp timer`

Parameter	Description
<code>&lt;5-32768&gt;</code>	The transmit interval in seconds. The transmit interval must be at least four times the transmission delay timer ( <a href="#">lldp tx-delay</a> command).

**Default** The default transmit interval is 30 seconds.

**Mode** Global Configuration

**Examples** To set the transmit interval to 90 seconds, use the commands:

```
awplus# configure terminal
awplus(config)# lldp timer 90
```

To set the transmit interval back to its default, use the commands:

```
awplus# configure terminal
awplus(config)# no lldp timer
```

**Related commands** [lldp tx-delay](#)  
[show lldp](#)

# lldp tlv-select

**Overview** This command enables one or more optional TLVs, or all TLVs, for transmission in LLDP advertisements via the specified ports. The TLVs can be specified in any order; they are placed in LLDP frames in a fixed order (as described in IEEE 802.1AB). The mandatory TLVs (Chassis ID, Port ID, Time To Live, End of LLDPDU) are always included in LLDP advertisements.

In LLDP-MED advertisements the MAC/PHY Configuration/Status TLV will be always be included regardless of whether it is selected by this command.

The **no** variant of this command disables the specified optional TLVs, or all optional TLVs, for transmission in LLDP advertisements via the specified ports.

**Syntax** `lldp tlv-select { [<tlv>]... }`  
`lldp tlv-select all`  
`no lldp tlv-select { [<tlv>]... }`  
`no lldp tlv-select all`

Parameter	Description
<tlv>	The TLV to transmit in LLDP advertisements. One of these keywords: <ul style="list-style-type: none"><li>• port-description (specified by the <a href="#">description (interface)</a> command)</li><li>• system-name (specified by the <a href="#">hostname</a> command)</li><li>• system-description</li><li>• system-capabilities</li><li>• management-address</li><li>• port-vlan</li><li>• port-and-protocol-vlans</li><li>• vlan-names</li><li>• protocol-ids</li><li>• mac-phy-config</li><li>• power-management (Power Via MDI TLV)</li><li>• link-aggregation</li><li>• max-frame-size</li></ul>
all	All TLVs.

**Default** By default no optional TLVs are included in LLDP advertisements. The MAC/PHY Configuration/Status TLV ( **mac-phy-config**) is included in LLDP-MED advertisements whether or not it is selected by this command.

**Mode** Interface Configuration



**Examples** To include the management-address and system-name TLVs in advertisements transmitted via ports 1.0.1 and 1.0.6, use the commands:

```
awplus# configure terminal
awplus(config)# interface port1.0.1,port1.0.6
awplus(config-if)# lldp tlv-select management-address
system-name
```

To include all optional TLVs in advertisements transmitted via ports 1.0.1 and 1.0.6, use the commands:

```
awplus# configure terminal
awplus(config)# interface port1.0.1,port1.0.6
awplus(config-if)# lldp tlv-select all
```

To exclude the management-address and system-name TLVs from advertisements transmitted via ports 1.0.1 and 1.0.6, use the commands:

```
awplus# configure terminal
awplus(config)# interface port1.0.1,port1.0.6
awplus(config-if)# no lldp tlv-select management-address
system-name
```

To exclude all optional TLVs from advertisements transmitted via ports 1.0.1 and 1.0.6, use the commands:

```
awplus# configure terminal
awplus(config)# interface port1.0.1,port1.0.6
awplus(config-if)# no lldp tlv-select all
```

**Related commands**

- [description \(interface\)](#)
- [hostname](#)
- [lldp med-tlv-select](#)
- [show lldp interface](#)
- [show lldp local-info](#)

# lldp transmit receive

**Overview** This command enables transmission and/or reception of LLDP advertisements to or from neighbors through the specified ports.

The **no** variant of this command disables transmission and/or reception of LLDP advertisements through specified ports.

**Syntax** `lldp {[transmit] [receive]}`  
`no lldp {[transmit] [receive]}`

Parameter	Description
transmit	Enable or disable transmission of LLDP advertisements via this port or ports.
receive	Enable or disable reception of LLDP advertisements via this port or ports.

**Default** LLDP advertisement transmission and reception are enabled on all ports by default.

**Mode** Interface Configuration

**Examples** To enable transmission of LLDP advertisements on port1.0.1 and port1.0.2, use the commands:

```
awplus# configure terminal
awplus(config)# interface port1.0.1,port1.0.2
awplus(config-if)# lldp transmit
```

To enable LLDP advertisement transmission and reception on port1.0.1 and port1.0.2, use the commands:

```
awplus# configure terminal
awplus(config)# interface port1.0.1,port1.0.2
awplus(config-if)# lldp transmit receive
```

To disable LLDP advertisement transmission and reception on port1.0.1 and port1.0.2, use the commands:

```
awplus# configure terminal
awplus(config)# interface port1.0.1,port1.0.2
awplus(config-if)# no lldp transmit receive
```

**Related commands** [show lldp interface](#)

**Command changes** Version 5.4.8-2.1: Command added to AR2050V, AR3050S, AR4050S

# lldp tx-delay

**Overview** This command sets the value of the transmission delay timer. This is the minimum time interval between transmitting LLDP advertisements due to a change in LLDP local information.

The **no** variant of this command sets the transmission delay timer back to its default setting.

**Syntax** `lldp tx-delay <1-8192>`  
`no lldp tx-delay`

Parameter	Description
<code>&lt;1-8192&gt;</code>	The transmission delay in seconds. The transmission delay cannot be greater than a quarter of the transmit interval ( <a href="#">lldp timer</a> command).

**Default** The default transmission delay timer is 2 seconds.

**Mode** Global Configuration

**Examples** To set the transmission delay timer to 12 seconds, use the commands:

```
awplus# configure terminal
awplus(config)# lldp tx-delay 12
```

To set the transmission delay timer back to its default, use the commands:

```
awplus# configure terminal
awplus(config)# no lldp tx-delay
```

**Related commands** [lldp timer](#)  
[show lldp](#)

# location civic-location configuration

**Overview** Use these commands to configure a civic address location. The country parameter must be specified first, and at least one of the other parameters must be configured before the location can be assigned to a port.

Use the **no** variants of this command to delete civic address parameters from the location.

**Syntax**

```
country <country>
state <state>
no state
county <county>
no county
city <city>
no city
division <division>
no division
neighborhood <neighborhood>
no neighborhood
street-group <street-group>
no street-group
leading-street-direction <leading-street-direction>
no leading-street-direction
trailing-street-suffix <trailing-street-suffix>
no trailing-street-suffix
street-suffix <street-suffix>
no street-suffix
house-number <house-number>
no house-number
house-number-suffix <house-number-suffix>
no house-number-suffix
landmark <landmark>
no landmark
additional-information <additional-information>
no additional-information
```

**Syntax (cont.)** name <name>  
no name  
postalcode <postalcode>  
no postalcode  
building <building>  
no building  
unit <unit>  
no unit  
floor <floor>  
no floor  
room <room>  
no room  
place-type <place-type>  
no place-type  
postal-community-name <postal-community-name>  
no postal-community-name  
post-office-box <post-office-box>  
no post-office-box  
additional-code <additional-code>  
no additional-code  
seat <seat>  
no seat  
primary-road-name <primary-road-name>  
no primary-road-name  
road-section <road-section>  
no road-section  
branch-road-name <branch-road-name>  
no branch-road-name  
sub-branch-road-name <sub-branch-road-name>  
no sub-branch-road-name  
street-name-pre-modifier <street-name-pre-modifier>  
no street-name-pre-modifier  
streetname-post-modifier <streetname-post-modifier>  
no streetname-post-modifier

Parameter	Description
<country>	Upper-case two-letter country code, as specified in ISO 3166.
<state>	State (Civic Address (CA) Type 1): national subdivisions (state, canton, region).
<county>	County (CA Type 2): County, parish, gun (JP), district (IN).
<city>	City (CA Type 3): city, township, shi (JP).
<division>	City division (CA Type 4): City division, borough, city district, ward, chou (JP).
<neighborhood>	Neighborhood (CA Type 5): neighborhood, block.
<street-group>	Street group (CA Type 6): group of streets below the neighborhood level.
<leading-street-direction>	Leading street direction (CA Type 16).
<trailing-street-suffix>	Trailing street suffix (CA Type 17).
<street-suffix>	Street suffix (CA Type 18): street suffix or type.
<house-number>	House number (CA Type 19).
<house-number-suffix>	House number suffix (CA Type 20).
<landmark>	Landmark or vanity address (CA Type 21).
<additional-information>	Additional location information (CA Type 22).
<name>	Name (CA Type 23): residence and office occupant.
<postal-code>	Postal/zip code (CA Type 24).
<building>	Building (CA Type 25): structure.
<unit>	Unit (CA Type 26): apartment, suite.
<floor>	Floor (CA Type 27).
<room>	Room (CA Type 28).
<place-type>	Type of place (CA Type 29).
<postal-community-name>	Postal community name (CA Type 30).
<post-office-box>	Post office box (P.O. Box) (CA Type 31).
<additional-code>	Additional code (CA Type 32).
<seat>	Seat (CA Type 33): seat (desk, cubicle, workstation).
<primary-road-name>	Primary road name (CA Type 34).
<road-section>	Road section (CA Type 35).

Parameter	Description
<code>&lt;branch-road-name&gt;</code>	Branch road name (CA Type 36).
<code>&lt;sub-branch-road-name&gt;</code>	Sub-branch road name (CA Type 37).
<code>&lt;street-name-pre-modifier&gt;</code>	Street name pre-modifier (CA Type 38).
<code>&lt;street-name-post-modifier&gt;</code>	Street name post-modifier (CA Type 39).

**Default** By default no civic address location information is configured.

**Mode** Civic Address Location Configuration

**Usage notes** The **country** parameter must be configured before any other parameters can be configured; this creates the location. The country parameter cannot be deleted. One or more of the other parameters must be configured before the location can be assigned to a port. The country parameter must be entered as an upper-case two-letter country code, as specified in ISO 3166. All other parameters are entered as alpha-numeric strings. Do not configure all the civic address parameters (this would generate TLVs that are too long). Configure a subset of these parameters—enough to consistently and precisely identify the location of the device. If the location is to be used for Emergency Call Service (ECS), the particular ECS application may have guidelines for configuring the civic address location. For more information about civic address format, see the [LLDP Feature Overview and Configuration Guide](#).

To specify the civic address location, use the [location civic-location identifier](#) command. To delete the civic address location, use the **no** variant of the **location civic-location identifier** command. To assign the civic address location to particular ports, so that it can be advertised in TLVs from those ports, use the command [location civic-location-id](#) command.

**Examples** To configure civic address location 1 with location "27 Nazareth Avenue, Christchurch, New Zealand" in civic-address format, use the commands:

```
awplus# configure terminal
awplus(config)# location civic-location identifier 1
awplus(config-civic)# country NZ
awplus(config-civic)# city Christchurch
awplus(config-civic)# primary-road-name Nazareth
awplus(config-civic)# street-suffix Avenue
awplus(config-civic)# house-number 27
```

**Related commands**

- [location civic-location-id](#)
- [location civic-location identifier](#)
- [show lldp local-info](#)
- [show location](#)

# location civic-location identifier

**Overview** Use this command to enter the Civic Address Location Configuration mode to configure the specified location.

Use the **no** variant of this command to delete a civic address location. This also removes the location from any ports it has been assigned to.

**Syntax** `location civic-location identifier <civic-loc-id>`  
`no location civic-location identifier <civic-loc-id>`

Parameter	Description
<code>&lt;civic-loc-id&gt;</code>	A unique civic address location ID, in the range 1 to 4095.

**Default** By default there are no civic address locations.

**Mode** Global Configuration

**Usage notes** To configure the location information for this civic address location identifier, use the [location civic-location configuration](#) command. To associate this civic location identifier with particular ports, use the [location elin-location-id](#) command.

Up to 400 locations can be configured on the switch for each type of location information, up to a total of 1200 locations.

**Examples** To enter Civic Address Location Configuration mode for the civic address location with ID 1, use the commands:

```
awplus# configure terminal
awplus(config)# location civic-location identifier 1
awplus(config-civic)#
```

To delete the civic address location with ID 1, use the commands:

```
awplus# configure terminal
awplus(config)# no location civic-location identifier 1
```

**Related commands**

- [location civic-location-id](#)
- [location civic-location configuration](#)
- [show location](#)
- [show running-config lldp](#)



# location civic-location-id

**Overview** Use this command to assign a civic address location to the ports. The civic address location must already exist. This replaces any previous assignment of civic address location for the ports. Up to one location of each type can be assigned to a port.

Use the **no** variant of this command to remove a location identifier from the ports.

**Syntax** `location civic-location-id <civic-loc-id>`  
`no location civic-location-id [<civic-loc-id>]`

Parameter	Description
<code>&lt;civic-loc-id&gt;</code>	Civic address location ID, in the range 1 to 4095.

**Default** By default no civic address location is assigned to ports.

**Mode** Interface Configuration

**Usage notes** The civic address location associated with a port can be transmitted in Location Identification TLVs via the port.

Before using this command, create the location using the following commands:

- [location civic-location identifier](#) command
- [location civic-location configuration](#) command

If a civic-address location is deleted using the **no** variant of the [location civic-location identifier](#) command, it is automatically removed from all ports.

**Examples** To assign the civic address location 1 to port1.0.1, use the commands:

```
awplus# configure terminal
awplus(config)# interface port1.0.1
awplus(config-if)# location civic-location-id 1
```

To remove a civic address location from port1.0.1, use the commands:

```
awplus# configure terminal
awplus(config)# interface port1.0.1
awplus(config-if)# no location civic-location-id
```

**Related commands** [lldp med-tlv-select](#)  
[location civic-location identifier](#)  
[location civic-location configuration](#)  
[show location](#)

**Command changes** Version 5.4.8-2.1: Command added to AR2050V, AR3050S, AR4050S

# location coord-location configuration

**Overview** Use this command to configure a coordinate-based location. All parameters must be configured before assigning this location identifier to a port.

**Syntax**

```
latitude <latitude>  
lat-resolution <lat-resolution>  
longitude <longitude>  
long-resolution <long-resolution>  
altitude <altitude> {meters|floor}  
alt-resolution <alt-resolution>  
datum {wgs84|nad83-navd|nad83-mllw}
```

Parameter	Description
<lat-resolution>	Latitude resolution, as a number of valid bits, in the range 0 to 34.
<latitude>	Latitude value in degrees in the range -90.0 to 90.0
<long-resolution>	Longitude resolution, as a number of valid bits, in the range 0 to 34.
<longitude>	Longitude value in degrees, in the range -180.0 to 180.0.
<alt-resolution>	Altitude resolution, as a number of valid bits, in the range 0 to 30. A resolution of 0 can be used to indicate an unknown value.
<altitude>	Altitude value, in meters or floors.
meters	The altitude value is in meters.
floors	The altitude value is in floors.
datum	The geodetic system (or datum) that the specified coordinate values are based on.
wgs84	World Geodetic System 1984.
nad83-navd	North American Datum 1983 - North American Vertical Datum.
nad83-mllw	North American Datum 1983 - Mean Lower Low Water vertical datum.

**Default** By default no coordinate location information is configured.

**Mode** Coordinate Configuration

**Usage** Latitude and longitude values are always stored internally, and advertised in the Location Identification TLV, as 34-bit fixed-point binary numbers, with a 25-bit fractional part, irrespective of the number of digits entered by the user. Likewise

altitude is stored as a 30-bit fixed point binary number, with an 8-bit fractional part. Because the user-entered decimal values are stored as fixed point binary numbers, they cannot always be represented exactly—the stored binary number is converted to a decimal number for display in the output of the [show location](#) command. For example, a user-entered latitude value of “2.77” degrees is displayed as “2.7699999809265136718750000”.

The **lat-resolution**, **long-resolution**, and **alt-resolution** parameters allow the user to specify the resolution of each coordinate element as the number of valid bits in the internally-stored binary representation of the value. These resolution values can be used by emergency services to define a search area.

To specify the coordinate identifier, use the [location coord-location identifier](#) command. To remove coordinate information, delete the coordinate location by using the **no** variant of that command. To associate the coordinate location with particular ports, so that it can be advertised in TLVs from those ports, use the [location elin-location-id](#) command.

**Example** To configure the location for the White House in Washington DC, which has the coordinates based on the WGS84 datum of 38.89868 degrees North (with 22 bit resolution), 77.03723 degrees West (with 22 bit resolution), and 15 meters height (with 9 bit resolution), use the commands:

```
awplus# configure terminal
awplus(config)# location coord-location identifier 1
awplus(config-coord)# la-resolution 22
awplus(config-coord)# latitude 38.89868
awplus(config-coord)# lo-resolution 22
awplus(config-coord)# longitude -77.03723
awplus(config-coord)# alt-resolution 9
awplus(config-coord)# altitude 15 meters
awplus(config-coord)# datum wgs84
```

**Related commands**

- [location coord-location-id](#)
- [location coord-location identifier](#)
- [show lldp local-info](#)
- [show location](#)

# location coord-location identifier

**Overview** Use this command to enter Coordinate Location Configuration mode for this coordinate location.

Use the **no** variant of this command to delete a coordinate location. This also removes the location from any ports it has been assigned to.

**Syntax** location coord-location identifier *<coord-loc-id>*  
no location coord-location identifier *<coord-loc-id>*

Parameter	Description
<i>&lt;coord-loc-id&gt;</i>	A unique coordinate location identifier, in the range 1 to 4095.

**Default** By default there are no coordinate locations.

**Mode** Global Configuration

**Usage** Up to 400 locations can be configured on the switch for each type of location information, up to a total of 1200 locations.

To configure this coordinate location, use the [location coord-location configuration](#) command. To associate this coordinate location with particular ports, so that it can be advertised in TLVs from those ports, use the [location coord-location-id](#) command.

**Examples** To enter Coordinate Location Configuration mode to configure the coordinate location with ID 1, use the commands:

```
awplus# configure terminal
awplus(config)# location coord-location identifier 1
awplus(config-coord)#
```

To delete coordinate location 1, use the commands:

```
awplus# configure terminal
awplus(config)# no location coord-location identifier 1
```

**Related commands** [location coord-location-id](#)  
[location coord-location configuration](#)  
[show lldp local-info](#)  
[show location](#)

# location coord-location-id

**Overview** Use this command to assign a coordinate location to the ports. The coordinate location must already exist. This replaces any previous assignment of coordinate location for the ports. Up to one location of each type can be assigned to a port.

Use the **no** variant of this command to remove a location from the ports.

**Syntax** `location coord-location-id <coord-loc-id>`  
`no location coord-location-id [<coord-loc-id>]`

Parameter	Description
<code>&lt;coord-loc-id&gt;</code>	Coordinate location ID, in the range 1 to 4095.

**Default** By default no coordinate location is assigned to ports.

**Mode** Interface Configuration

**Usage notes** The coordinate location associated with a port can be transmitted in Location Identification TLVs via the port.

Before using this command, configure the location using the following commands:

- [location coord-location identifier](#) command
- [location coord-location configuration](#) command

If a coordinate location is deleted using the **no** variant of the [location coord-location identifier](#) command, it is automatically removed from all ports.

**Examples** To assign coordinate location 1 to port1.0.1, use the commands:

```
awplus# configure terminal
awplus(config)# interface port1.0.1
awplus(config-if)# location coord-location-id 1
```

To remove a coordinate location from port1.0.1, use the commands:

```
awplus# configure terminal
awplus(config)# interface port1.0.1
awplus(config-if)# no location coord-location-id
```

**Related commands**

- [lldp med-tlv-select](#)
- [location coord-location identifier](#)
- [location coord-location configuration](#)
- [show location](#)

**Command changes** Version 5.4.8-2.1: Command added to AR2050V, AR3050S, AR4050S

# location elin-location

**Overview** Use this command to create or modify an ELIN location.

Use the **no** variant of this command to delete an ELIN location, and remove it from any ports it has been assigned to.

**Syntax** `location elin-location <elin> identifier <elin-loc-id>`  
`no location elin-location identifier <elin-loc-id>`

Parameter	Description
<code>&lt;elin&gt;</code>	Emergency Location Identification Number (ELIN) for Emergency Call Service (ECS), in the range 10 to 25 digits long. In North America, ELINs are typically 10 digits long.
<code>&lt;elin-loc-id&gt;</code>	A unique ELIN location identifier, in the range 1 to 4095.

**Default** By default there are no ELIN location identifiers.

**Mode** Global Configuration

**Usage** Up to 400 locations can be configured on the switch for each type of location information, up to a total of 1200 locations.

To assign this ELIN location to particular ports, so that it can be advertised in TLVs from those ports, use the [location elin-location-id](#) command.

**Examples** To create a new ELIN location with ID 1, and configure it with ELIN "1234567890", use the commands:

```
awplus# configure terminal
awplus(config)# location elin-location 1234567890 identifier 1
```

To delete existing ELIN location with ID 1, use the commands:

```
awplus# configure terminal
awplus(config)# no location elin-location identifier 1
```

**Related commands** [location elin-location-id](#)  
[show lldp local-info](#)  
[show location](#)

# location elin-location-id

**Overview** Use this command to assign an ELIN location to the ports. The ELIN location must already exist. This replaces any previous assignment of ELIN location for the ports. Up to one location of each type can be assigned to a port.

Use the **no** variant of this command to remove a location identifier from the ports.

**Syntax** `location elin-location-id <elin-loc-id>`  
`no location elin-location-id [<elin-loc-id>]`

Parameter	Description
<code>&lt;elin-loc-id&gt;</code>	ELIN location identifier, in the range 1 to 4095.

**Default** By default no ELIN location is assigned to ports.

**Mode** Interface Configuration

**Usage notes** An ELIN location associated with a port can be transmitted in Location Identification TLVs via the port.  
Before using this command, configure the location using the [location elin-location](#) command.

If an ELIN location is deleted using the **no** variant of one of the [location elin-location](#) command, it is automatically removed from all ports.

**Examples** To assign ELIN location 1 to port1.0.1, use the commands:

```
awplus# configure terminal
awplus(config)# interface port1.0.1
awplus(config-if)# location elin-location-id 1
```

To remove ELIN location 1 from port1.0.1, use the commands:

```
awplus# configure terminal
awplus(config)# interface port1.0.1
awplus(config-if)# no location elin-location-id 1
```

**Related commands** [lldp med-tlv-select](#)  
[location elin-location](#)  
[show location](#)

**Command changes** Version 5.4.8-2.1: Command added to AR2050V, AR3050S, AR4050S



# show debugging lldp

**Overview** This command displays LLDP debug settings for specified ports. If no port list is supplied, LLDP debug settings for all ports are displayed.

**Syntax** `show debugging lldp [interface <port-list>]`

Parameter	Description
<port-list>	The ports for which the LLDP debug settings are shown.

**Mode** User Exec and Privileged Exec

**Examples** To display LLDP debug settings for all ports, use the command:

```
awplus# show debugging lldp
```

To display LLDP debug settings for ports 1.0.1 to 1.0.6, use the command:

```
awplus# show debugging lldp interface port1.0.1-1.0.6
```

**Output** Figure 44-1: Example output from the **show debugging lldp** command

```
LLDP Debug settings:
Debugging for LLDP internal operation is on
Port      Rx      RxPkt   Tx      TxPkt
-----
1.0.1     Yes    Yes     No      No
1.0.2     Yes    No      No      No
1.0.3     No     No      No      No
1.0.4     Yes    Yes     Yes     No
1.0.5     Yes    No      Yes     No
1.0.6     Yes    Yes     Yes     Yes
```

**Table 1:** Parameters in the output of the **show debugging lldp** command

Parameter	Description
Port	Port name.
Rx	Whether debugging of LLDP receive is enabled on the port.
RxPkt	Whether debugging of LLDP receive packet dump is enabled on the port.
Rx	Whether debugging of LLDP transmit is enabled on the port.
RxPkt	Whether debugging of LLDP transmit packet dump is enabled on the port.

**Related  
commands** [debug lldp](#)

# show lldp

**Overview** This command displays LLDP status and global configuration settings.

**Syntax** show lldp

**Mode** User Exec and Privileged Exec

**Example** To display LLDP status and global configuration settings, use the command:

```
awplus# show lldp
```

## Output

**Table 2:** Example output from the **show lldp** command

```
awplus# show lldp

LLDP Global Configuration:                               [Default Values]
LLDP Status ..... Enabled                               [Disabled]
Notification Interval .... 5 secs                       [5]
Tx Timer Interval ..... 30 secs                         [30]
Hold-time Multiplier ..... 4                           [4]
(Computed TTL value ..... 120 secs)
Reinitialization Delay ... 2 secs                       [2]
Tx Delay ..... 2 secs                                   [2]

Port Number Type..... Ifindex                           [Port-Number]
Fast Start Count ..... 5                                [3]

LLDP Global Status:
Total Neighbor Count ..... 47
Neighbors table last updated 0 hrs 0 mins 43 secs ago
```

**Table 3:** Parameters in the output of the **show lldp** command

Parameter	Description
LLDP Status	Whether LLDP is enabled. Default is disabled.
Notification Interval	Minimum interval between LLDP notifications.
Tx Timer Interval	Transmit interval between regular transmissions of LLDP advertisements.
Hold-time Multiplier	The holdtime multiplier. The transmit interval is multiplied by the holdtime multiplier to give the Time To Live (TTL) value that is advertised to neighbors.
Reinitialization Delay	The reinitialization delay. This is the minimum time after disabling LLDP transmit on a port before it can reinitialize again.

**Table 3:** Parameters in the output of the **show lldp** command (cont.)

Parameter	Description
Tx Delay	The transmission delay. This is the minimum time interval between transmitting advertisements due to a change in LLDP local information.
Port Number Type	The type of port identifier used to enumerate LLDP MIB local port entries, as set by the lldp port-number-type command.
Fast Start Count	The number of times fast start advertisements are sent for LLDP-MED.
Total Neighbor Count	Number of LLDP neighbors discovered on all ports.
Neighbors table last updated	The time since the LLDP neighbor table was last updated.

**Related commands** [show lldp interface](#)  
[show running-config lldp](#)

# show lldp interface

**Overview** This command displays LLDP configuration settings for specified ports. If no port list is specified, LLDP configuration for all ports is displayed.

**Syntax** `show lldp interface [<port-list>]`

Parameter	Description
<port-list>	The ports for which the LLDP configuration settings are to be shown.

**Mode** User Exec and Privileged Exec

**Examples** To display LLDP configuration settings for ports 1.0.1 to 1.0.6, use the command:

```
awplus# show lldp interface port1.0.1-1.0.6
```

To display LLDP configuration settings for all ports, use the command:

```
awplus# show lldp interface
```

**Output** Figure 44-2: Example output from the **show lldp interface** command

```
awplus# show lldp interface port1.0.1-1.0.8
LLDP Port Status and Configuration:

* = LLDP is inactive on this port because it is a mirror analyser port
Notification Abbreviations:
  RC = LLDP Remote Tables Change      TC = LLDP-MED Topology Change
TLV Abbreviations:
  Base: Pd = Port Description          Sn = System Name
         Sd = System Description       Sc = System Capabilities
         Ma = Management Address
  802.1: Pv = Port VLAN ID             Pp = Port And Protocol VLAN ID
         Vn = VLAN Name                Pi = Protocol Identity
  802.3: Mp = MAC/PHY Config/Status    Po = Power Via MDI (PoE)
         La = Link Aggregation         Mf = Maximum Frame Size
  MED:  Mc = LLDP-MED Capabilities     Np = Network Policy
         Lo = Location Identification   Pe = Extended PoE      In = Inventory

                                Optional TLVs Enabled for Tx
Port    Rx/Tx  Notif  Management Addr  Base      802.1    802.3    MED
-----
1.0.1   Rx Tx   RC --   192.168.100.123 PdSnSdScMa -----
*1.0.2  -- Tx   RC --   192.168.100.123 PdSnSdScMa -----
1.0.3   Rx Tx   RC --   192.168.100.123 Pd--SdScMa PvPpVnPi -----
1.0.4   -- --   RC --   192.168.100.123 PdSnSd--Ma -----
1.0.5   Rx Tx   RC TC   192.168.100.123 PdSnSdScMa PvPpVnPi -----
1.0.6   Rx Tx   RC TC   192.168.100.123 Pd----ScMa -----
1.0.7   Rx Tx   -- TC   192.168.100.123 PdSnSdScMa PvPpVnPi MpPoLaMf McNpLoPeIn
1.0.8   Rx Tx   -- TC   192.168.1.1    PdSn--ScMa PvPpVnPi ----- McNp-----
```

**Table 4:** Parameters in the output of the **show lldp interface** command

Parameter	Description
Port	Port name.
Rx	Whether reception of LLDP advertisements is enabled on the port.
Tx	Whether transmission of LLDP advertisements is enabled on the port.
Notif	Whether sending SNMP notification for LLDP is enabled on the port: <ul style="list-style-type: none"> <li>RM = Remote Tables Change Notification</li> <li>TP = LLDP-MED Topology Change Notification</li> </ul>
Management Addr	Management address advertised to neighbors.
Base TLVs Enabled for Tx	List of optional Base TLVs enabled for transmission: <ul style="list-style-type: none"> <li>Pd = Port Description</li> <li>Sn =System Name</li> <li>Sd = System Description</li> <li>Sc =System Capabilities</li> <li>Ma = Management Address</li> </ul>
802.1 TLVs Enabled for Tx	List of optional 802.1 TLVs enabled for transmission: <ul style="list-style-type: none"> <li>Pv = Port VLAN ID</li> <li>Pp = Port And Protocol VLAN ID</li> <li>Vn = VLAN Name</li> <li>Pi =Protocol Identity</li> </ul>
802.3 TLVs Enabled for Tx	List of optional 802.3 TLVs enabled for transmission: <ul style="list-style-type: none"> <li>Mp = MAC/PHY Configuration/Status</li> <li>Po = Power Via MDI (PoE)</li> <li>La = Link Aggregation</li> <li>Mf = Maximum Frame Size</li> </ul>
MED TLVs Enabled for Tx	List of optional LLDP-MED TLVs enabled for transmission: <ul style="list-style-type: none"> <li>Mc = LLDP-MED Capabilities</li> <li>Np = Network Policy</li> <li>Lo = Location Information,</li> <li>Pe = Extended Power-Via-MDI</li> <li>In = Inventory</li> </ul>

**Related commands** [show lldp](#)  
[show running-config lldp](#)

# show lldp local-info

**Overview** This command displays local LLDP information that can be transmitted through specified ports. If no port list is entered, local LLDP information for all ports is displayed.

**Syntax** `show lldp local-info [base] [dot1] [dot3] [med] [interface <port-list>]`

Parameter	Description
base	Information for base TLVs.
dot1	Information for 802.1 TLVs.
dot3	Information for 802.3 TLVs.
med	Information for LLDP-MED TLVs.
<port-list>	The ports for which the local information is to be shown.

**Mode** User Exec and Privileged Exec

**Usage notes** Whether and which local information is transmitted in advertisements via a port depends on:

- whether the port is set to transmit LLDP advertisements ([lldp transmit receive](#) command)
- which TLVs it is configured to send ([lldp tlv-select](#) command, [lldp med-tlv-select](#) command)

**Examples** To display local information transmitted via port 1.0.1, use the command:

```
awplus# show lldp local-info interface port1.0.1
```

To display local information transmitted via all ports, use the command:

```
awplus# show lldp local-info
```

**Output** Figure 44-3: Example output from **show lldp local-info**

```
LLDP Local Information:

Local port1.0.1:
  Chassis ID Type ..... MAC address
  Chassis ID ..... 0015.77c9.7453
  Port ID Type ..... Interface alias
  Port ID ..... port1.0.1
  TTL ..... 120
  Port Description ..... [not configured]
```

```
System Name ..... awplus
System Description ..... Allied Telesis router/switch, AW+
                          v5.4.6
System Capabilities - Supported .. Bridge, Router
                    - Enabled .... Bridge, Router
Management Address ..... 192.168.1.6
Port VLAN ID (PVID) ..... 1
Port & Protocol VLAN - Supported . Yes
                    - Enabled ... No
                    - VIDs ..... 0
VLAN Names ..... default
Protocol IDs ..... 9000, 0026424203000000, 888e01, aaaa03,
                    88090101, 00540000e302, 0800, 0806, 86dd
MAC/PHY Auto-negotiation ..... Supported, Enabled
  Advertised Capability ..... 1000BaseTFD, 100BaseTXFD, 100BaseTX,
                              10BaseTFD, 10BaseT
  Operational MAU Type ..... 1000BaseTFD (30)
Power Via MDI (PoE) ..... Supported, Enabled
  Port Class ..... PSE
  Pair Control Ability ..... Disabled
  Power Class ..... Unknown
Link Aggregation ..... Supported, Disabled
Maximum Frame Size ..... 1522
LLDP-MED Device Type ..... Network Connectivity
LLDP-MED Capabilities ..... LLDP-MED Capabilities, Network Policy,
                              Location Identification,
                              Extended Power - PSE, Inventory
Network Policy ..... [not configured]
Location Identification ..... Civic Address
  Country Code ..... NZ
  City ..... Christchurch
  Street Suffix ..... Avenue
  House Number ..... 27
  Primary Road Name ..... Nazareth
Location Identification ..... ELIN
  ELIN ..... 123456789012
LLDP-MED Device Type ..... Network Connectivity
LLDP-MED Capabilities ..... LLDP-MED Capabilities, Network Policy,
                              Location Identification,
                              Extended Power - PSE, Inventory
Extended Power Via MDI (PoE) ..... PSE
  Power Source ..... Primary Power
  Power Priority ..... Low
  Power Value ..... 4.4 Watts
Inventory Management:
  Hardware Revision ..... A-0
  Firmware Revision ..... 1.1.0
  Software Revision ..... v5.4.6
  Serial Number ..... G1Q78900B
  Manufacturer Name ..... Allied Telesis Inc.
  Model Name ..... AT-x930-52GPX
  Asset ID ..... [zero length]
```



Table 44-1: Parameters in the output of **show lldp local-info**

Parameter	Description
Chassis ID Type	Type of the Chassis ID.
Chassis ID	Chassis ID that uniquely identifies the local device.
Port ID Type	Type of the Port ID.
Port ID	Port ID of the local port through which advertisements are sent.
TTL	Number of seconds that the information advertised by the local port remains valid.
Port Description	Port description of the local port, as specified by the <a href="#">description (interface)</a> command.
System Name	System name, as specified by the <a href="#">hostname</a> command.
System Description	System description.
System Capabilities (Supported)	Capabilities that the local port supports.
System Capabilities (Enabled)	Enabled capabilities on the local port.
Management Addresses	Management address associated with the local port. To change this, use the <a href="#">lldp management-address</a> command.
Port VLAN ID (PVID)	VLAN identifier associated with untagged or priority tagged frames received via the local port.
Port & Protocol VLAN (Supported)	Whether Port & Protocol VLANs (PPV) is supported on the local port.
Port & Protocol VLAN (Enabled)	Whether the port is in one or more Port & Protocol VLANs.
Port & Protocol VLAN (VIDs)	List of identifiers for Port & Protocol VLANs that the port is in.
VLAN Names	List of VLAN names for VLANs that the local port is assigned to.
Protocol IDs	List of protocols that are accessible through the local port.
MAC/PHY Auto-negotiation	Auto-negotiation support and current status of the 802.3 LAN on the local port.

Table 44-1: Parameters in the output of **show lldp local-info** (cont.)

Parameter	Description
Power Via MDI (PoE)	PoE-capability and current status on the local port.
Port Class	Whether the device is a PSE (Power Sourcing Entity) or a PD (Powered Device)
Pair Control Ability	Whether power pair selection can be controlled
Power Pairs	Which power pairs are selected for power ("Signal Pairs" or "Spare Pairs") if pair selection can be controlled
Power Class	The power class of the PD device on the port (class 0, 1, 2, 3 or 4)
Link Aggregation	Whether the link is capable of being aggregated and it is currently in an aggregation.
Aggregated Port-ID	Aggregated port identifier.
Maximum Frame Size	The maximum frame size capability of the implemented MAC and PHY.
LLDP-MED Device Type	LLDP-MED device type
LLDP-MED Capabilities	Capabilities LLDP-MED capabilities supported on the local port.
Network Policy	List of network policies configured on the local port.
VLAN ID	VLAN identifier for the port for the specified application type
Tagged Flag	Whether the VLAN ID is to be used as tagged or untagged
Layer-2 Priority:	Layer 2 User Priority (in the range 0 to 7)
DSCP Value	Diffserv codepoint (in the range 0 to 63)
Location Identification	Location configured on the local port.
Extended Power Via MDI (PoE)	PoE-capability and current status of the PoE parameters for Extended Power-Via-MDI TLV on the local port.
Power Source	The power source the switch currently uses; either primary power or backup power.
Power Priority	The power priority configured on the port; either critical, high or low.

Table 44-1: Parameters in the output of **show lldp local-info** (cont.)

Parameter	Description
Power Value	The total power the switch can source over a maximum length cable to a PD device on the port. The value shows the power value in Watts from the PD side.
Inventory Management	Inventory information for the device.

**Related commands**

- [description \(interface\)](#)
- [hostname](#)
- [lldp transmit receive](#)

# show lldp neighbors

**Overview** This command displays a summary of information received from neighbors via specified ports. If no port list is supplied, neighbor information for all ports is displayed.

**Syntax** `show lldp neighbors [interface <port-list>]`

Parameter	Description
<port-list>	The ports for which the neighbor information is to be shown.

**Mode** User Exec and Privileged Exec

**Examples** To display neighbor information received via all ports, use the command:

```
awplus# show lldp neighbors
```

To display neighbor information received via ports 1.0.1 and 1.0.6 with LLDP-MED configuration, use the command:

```
awplus# show lldp neighbors interface port1.0.1,port1.0.6
```

**Output** Figure 44-4: Example output from the **show lldp neighbors** command

```
LLDP Neighbor Information:

Total number of neighbors on these ports .... 4

System Capability Codes:
  O = Other   P = Repeater   B = Bridge           W = WLAN Access Point
  R = Router  T = Telephone   C = DOCSIS Cable Device  S = Station Only
LLDP-MED Device Type and Power Source Codes:
  1 = Class I   3 = Class III   PSE = PoE   Both = PoE&Local   Prim = Primary
  2 = Class II  N = Network Con.  Locl = Local  Unkn = Unknown   Back = Backup

Local  Neighbor      Neighbor      Neighbor      System      MED
Port   Chassis ID    Port ID       Sys Name      Cap.        Ty Pwr
-----
1.0.1  002d.3044.7ba6  port1.0.2     awplus        OPBWRTCs
1.0.1  0011.3109.e5c6  port1.0.3     AT-9924 switch/route... --B-R---
1.0.6  0000.10cf.8590  port3         AR-442S       --B-R---
1.0.6  00ee.4352.df51  192.168.1.2   Jim's desk phone --B--T--    3 PSE
```

**Table 45:** Parameters in the output of the **show lldp neighbors** command

Parameter	Description
Local Port	Local port on which the neighbor information was received.
Neighbor Chassis ID	Chassis ID that uniquely identifies the neighbor.
Neighbor Port Name	Port ID of the neighbor.
Neighbor Sys Name	System name of the LLDP neighbor.
Neighbor Capability	Capabilities that are supported and enabled on the neighbor.
System Capability	System Capabilities of the LLDP neighbor.
MED Device Type	LLDP-MED Device class (Class I, II, III or Network Connectivity)
MED Power Source	LLDP-MED Power Source

**Related commands** [show lldp neighbors detail](#)

# show lldp neighbors detail

**Overview** This command displays in detail the information received from neighbors via specified ports. If no port list is supplied, detailed neighbor information for all ports is displayed.

**Syntax** `show lldp neighbors detail [base] [dot1] [dot3] [med] [interface <port-list>]`

Parameter	Description
base	Information for base TLVs.
dot1	Information for 802.1 TLVs.
dot3	Information for 803.1 TLVs.
med	Information for LLDP-MED TLVs.
<port-list>	The ports for which the neighbor information is to be shown.

**Mode** User Exec and Privileged Exec

**Examples** To display detailed neighbor information received via all ports, use the command:

```
awplus# show lldp neighbors detail
```

To display detailed neighbor information received via ports 1.0.1, use the command:

```
awplus# show lldp neighbors detail interface port1.0.1
```

**Output** Figure 44-5: Example output from the **show lldp neighbors detail** command

```
awplus#show lldp neighbors detail interface port1.0.1
LLDP Detailed Neighbor Information:

Local port1.0.1:
  Neighbors table last updated 0 hrs 0 mins 40 secs ago
  Chassis ID Type ..... MAC address
  Chassis ID ..... 0004.cd28.8754
  Port ID Type ..... Interface alias
  Port ID ..... port1.0.6
  TTL ..... 120 (secs)
  Port Description ..... [zero length]
  System Name ..... awplus
  System Description ..... Allied Telesis router/switch, AW+ v5.4.6
  System Capabilities - Supported .. Bridge, Router
                    - Enabled .... Bridge, Router
  Management Addresses ..... 0004.cd28.8754
  Port VLAN ID (PVID) ..... 1
  Port & Protocol VLAN - Supported . Yes
                    - Enabled ... Yes
                    - VIDs ..... 5
  VLAN Names ..... default, vlan5
  Protocol IDs ..... 9000, 0026424203000000, 888e01, 8100,
                    88090101, 00540000e302, 0800, 0806, 86dd
  MAC/PHY Auto-negotiation ..... Supported, Enabled
    Advertised Capability ..... 1000BaseTFD, 100BaseTXFD, 100BaseTX,
    10BaseTFD, 10BaseT
    Operational MAU Type ..... 1000BaseTFD (30)
  Power Via MDI (PoE) ..... [not advertised]
  Link Aggregation ..... Supported, Disabled
  Maximum Frame Size ..... 1522 (Octets)
  LLDP-MED Device Type ..... Network Connectivity
  LLDP-MED Capabilities ..... LLDP-MED Capabilities, Network Policy,
    Location Identification,
    Extended Power - PSE, Inventory
  Network Policy ..... [not advertised]
  Location Identification ..... [not advertised]
  Extended Power Via MDI (PoE) .... PD
    Power Source ..... PSE
    Power Priority ..... High
    Power Value ..... 4.4 Watts
  Inventory Management:
    Hardware Revision ..... X1-0
    Firmware Revision ..... 1.1.0
    Software Revision ..... v5.4.6
    Serial Number ..... M1NB73008
    Manufacturer Name ..... Allied Telesis Inc.
    Model Name ..... x230-28GP
    Asset ID ..... [zero length]
```

**Table 46:** Parameters in the output of the **show lldp neighbors detail** command

Parameter	Description
Chassis ID Type	Type of the Chassis ID.
Chassis ID	Chassis ID that uniquely identifies the neighbor.
Port ID Type	Type of the Port ID.
Port ID	Port ID of the neighbor.
TTL	Number of seconds that the information advertised by the neighbor remains valid.
Port Description	Port description of the neighbor's port.
System Name	Neighbor's system name.
System Description	Neighbor's system description.
System Capabilities (Supported)	Capabilities that the neighbor supports.
System Capabilities (Enabled)	Capabilities that are enabled on the neighbor.
Management Addresses	List of neighbor's management addresses.
Port VLAN ID (PVID)	VLAN identifier associated with untagged or priority tagged frames for the neighbor port.
Port & Protocol VLAN (Supported)	Whether Port & Protocol VLAN is supported on the LLDP neighbor.
Port & Protocol VLAN (Enabled)	Whether Port & Protocol VLAN is enabled on the LLDP neighbor.
Port & Protocol VLAN (VIDs)	List of Port & Protocol VLAN identifiers.
VLAN Names	List of names of VLANs that the neighbor's port belongs to.
Protocol IDs	List of protocols that are accessible through the neighbor's port.
MAC/PHY Auto-negotiation	Auto-negotiation configuration and status
Power Via MDI (PoE)	PoE configuration and status of 802.3 Power-Via-MDI TLV
Link Aggregation	Link aggregation information



**Table 46:** Parameters in the output of the **show lldp neighbors detail** command (cont.)

Parameter	Description
Maximum Frame Size	The maximum frame size capability
LLDP-MED Device Type	LLDP-MED Device type
LLDP-MED Capabilities	LLDP-MED capabilities supported
Network Policy	List of network policies
Location Identification	Location information
Extended Power Via MDI (PoE)	PoE-capability and current status
Inventory Management	Inventory information

**Related commands** [show lldp neighbors](#)

# show lldp statistics

**Overview** This command displays the global LLDP statistics (packet and event counters).

**Syntax** show lldp statistics

**Mode** User Exec and Privileged Exec

**Example** To display global LLDP statistics information, use the command:

```
awplus# show lldp statistics
```

## Output

**Table 47:** Example output from the **show lldp statistics** command

```
awplus# show lldp statistics

Global LLDP Packet and Event counters:

Frames:   Out ..... 345
          In ..... 423
          In Errored ..... 0
          In Dropped ..... 0
TLVs:    Unrecognized ..... 0
          Discarded ..... 0
Neighbors: New Entries ..... 20
           Deleted Entries ..... 20
           Dropped Entries ..... 0
           Entry Age-outs ..... 20
```

**Table 48:** Parameters in the output of the **show lldp statistics** command

Parameter	Description
Frames Out	Number of LLDPDU frames transmitted.
Frames In	Number of LLDPDU frames received.
Frames In Errored	Number of invalid LLDPDU frames received.
Frames In Dropped	Number of LLDPDU frames received and discarded for any reason.
TLVs Unrecognized	Number of LLDP TLVs received that are not recognized but the TLV type is in the range of reserved TLV types.
TLVs Discarded	Number of LLDP TLVs discarded for any reason.
Neighbors New Entries	Number of times the information advertised by neighbors has been inserted into the neighbor table.

**Table 48:** Parameters in the output of the **show lldp statistics** command (cont.)

Parameter	Description
Neighbors Deleted Entries	Number of times the information advertised by neighbors has been removed from the neighbor table.
Neighbors Dropped Entries	Number of times the information advertised by neighbors could not be entered into the neighbor table because of insufficient resources.
Neighbors Entry Age-outs Entries	Number of times the information advertised by neighbors has been removed from the neighbor table because the information TTL interval has expired.

**Related commands**

- [clear lldp statistics](#)
- [show lldp statistics interface](#)

# show lldp statistics interface

**Overview** This command displays the LLDP statistics (packet and event counters) for specified ports. If no port list is supplied, LLDP statistics for all ports are displayed.

**Syntax** `show lldp statistics interface [<port-list>]`

Parameter	Description
<port-list>	The ports for which the statistics are to be shown.

**Mode** User Exec and Privileged Exec

**Examples** To display LLDP statistics information for all ports, use the command:

```
awplus# show lldp statistics interface
```

To display LLDP statistics information for ports 1.0.1 and 1.0.6, use the command:

```
awplus# show lldp statistics interface port1.0.1,port1.0.6
```

## Output

**Table 49:** Example output from the **show lldp statistics interface** command

```
awplus# show lldp statistics interface port1.0.1,port1.0.6

LLDP Packet and Event Counters:

port1.0.1
  Frames:   Out ..... 27
            In ..... 22
            In Errored ..... 0
            In Dropped ..... 0
  TLVs:    Unrecognized ..... 0
            Discarded ..... 0
  Neighbors: New Entries ..... 3
            Deleted Entries ..... 0
            Dropped Entries ..... 0
            Entry Age-outs ..... 0

port1.0.6
  Frames:   Out ..... 15
            In ..... 18
            In Errored ..... 0
            In Dropped ..... 0
  TLVs:    Unrecognized ..... 0
            Discarded ..... 0
  Neighbors: New Entries ..... 1
            Deleted Entries ..... 0
            Dropped Entries ..... 0
            Entry Age-outs ..... 0
```

**Table 50:** Parameters in the output of the **show lldp statistics interface** command

Parameter	Description
Frames Out	Number of LLDPDU frames transmitted.
Frames In	Number of LLDPDU frames received.
Frames In Errored	Number of invalid LLDPDU frames received.
Frames In Dropped	Number of LLDPDU frames received and discarded for any reason.
TLVs Unrecognized	Number of LLDP TLVs received that are not recognized but the TLV type is in the range of reserved TLV types.
TLVs Discarded	Number of LLDP TLVs discarded for any reason.
Neighbors New Entries	Number of times the information advertised by neighbors has been inserted into the neighbor table.
Neighbors Deleted Entries	Number of times the information advertised by neighbors has been removed from the neighbor table.
Neighbors Dropped Entries	Number of times the information advertised by neighbors could not be entered into the neighbor table because of insufficient resources.
Neighbors Entry Age-outs Entries	Number of times the information advertised by neighbors has been removed from the neighbor table because the information TTL interval has expired.

**Related commands** [clear lldp statistics](#)  
[show lldp statistics](#)

# show location

**Overview** Use this command to display selected location information configured on the switch.

**Syntax**

```
show location {civic-location|coord-location|elin-location}
show location {civic-location|coord-location|elin-location}
identifier {<civic-loc-id>|<coord-loc-id>|<elin-loc-id>}
show location {civic-location|coord-location|elin-location}
interface <port-list>
```

Parameter	Description
civic-location	Display civic location information.
coord-location	Display coordinate location information.
elin-location	Display ELIN (Emergency Location Identifier Number) information.
<civic-loc-id>	Civic address location identifier, in the range 1 to 4095.
<coord-loc-id>	Coordinate location identifier, in the range 1 to 4095.
<elin-loc-id>	ELIN location identifier, in the range 1 to 4095.
<port-list>	Ports to display information about.

**Mode** User Exec and Privileged Exec

**Examples** To display a civic address location configured on port 1.0.1, use the command:

```
awplus# show location civic-location interface port1.0.1
```

**Table 51:** Example output from the **show location** command

```
awplus# show location civic-location interface port1.0.1
Port      ID      Element Type      Element Value
-----
1.0.1    1      Country           NZ
          City           Christchurch
          Street-suffix   Avenue
          House-number    27
          Primary-road-name Nazareth
```

To display coordinate location information configured on the identifier 1, use the command:

```
awplus# show location coord-location identifier 1
```

**Table 52:** Example output from the **show location** command

```
awplus# show location coord-location identifier 1
  ID  Element Type                Element Value
-----
  1   Latitude Resolution         15 bits
      Latitude                   38.8986481130123138427734375 degrees
      Longitude Resolution       15 bits
      Longitude                   130.2323232293128967285156250 degrees
      Altitude Resolution        10 bits
      Altitude                   2.50000000 meters
      Map Datum                  WGS 84
```

The coordinate location information displayed may differ from the information entered because it is stored in binary format. For more information, see the [location coord-location configuration](#) command.

To display all ELIN location information configured on the switch, use the command:

```
awplus# show location elin-location
```

**Table 53:** Example output from the **show location elin-location** command

```
awplus# show location elin-location
  ID  ELIN
-----
  1   1234567890
  2   5432154321
```

**Related commands**

- [location elin-location-id](#)
- [location civic-location identifier](#)
- [location civic-location configuration](#)
- [location coord-location identifier](#)
- [location coord-location configuration](#)
- [location elin-location](#)

**Command changes**

Version 5.4.8-2.1: Command added to AR2050V, AR3050S, AR4050S

# 45

# Mail (SMTP) Commands

## Introduction

**Overview** This chapter provides an alphabetical reference for commands used to configure mail. The mail feature uses Simple Mail Transfer Protocol (SMTP) to transfer mail from an internal email client operating within the AlliedWare Plus device. This feature is typically used to email event notifications to an external email server from the AlliedWare Plus device.

For information on using the mail feature, see the [Mail \(SMTP\) Feature Overview and Configuration Guide](#).

- Command List**
- “[debug mail](#)” on page 1817
  - “[delete mail](#)” on page 1818
  - “[mail](#)” on page 1819
  - “[mail from](#)” on page 1821
  - “[mail smtpserver](#)” on page 1822
  - “[mail smtpserver authentication](#)” on page 1823
  - “[mail smtpserver port](#)” on page 1825
  - “[show counter mail](#)” on page 1827
  - “[show mail](#)” on page 1828
  - “[undebug mail](#)” on page 1829



# debug mail

**Overview** This command turns on debugging for sending emails.  
The **no** variant of this command turns off debugging for sending emails.

**Syntax** debug mail  
no debug mail

**Mode** Privileged Exec

**Examples** To turn on debugging for sending emails, use the command:

```
awplus# debug mail
```

To turn off debugging for sending emails, use the command:

```
awplus# no debug mail
```

**Related commands**

- delete mail
- mail
- mail from
- mail smtpserver
- show counter mail
- show mail
- undebug mail

# delete mail

**Overview** This command deletes mail from the queue.

You need the *mail-id* from the **show mail** command output to delete specific emails, or use the **all** parameter to clear all messages in the queue completely.

**Syntax** `delete mail [mail-id <mail-id>|all]`

Parameter	Description
mail-id	Deletes a single mail from the mail queue.
	<mail-id> A unique mail ID number. Use the <a href="#">show mail</a> command to display this for an item of mail.
all	Delete all the mail in the queue.

**Mode** Privileged Exec

**Examples** To delete the unique mail item "20060912142356.1234" from the queue, use the command:

```
awplus# delete mail 20060912142356.1234
```

To delete all mail from the queue, use the command:

```
awplus# delete mail all
```

**Related commands**

- [debug mail](#)
- [mail](#)
- [mail from](#)
- [mail smtpserver](#)
- [show mail](#)

# mail

**Overview** This command sends an email using the SMTP protocol. If you specify a file the text inside the file is sent in the message body.

If you do not specify the **to**, **file**, or **subject** parameters, the CLI prompts you for the missing information.

Before you can send mail using this command, you must specify the sending email address using the [mail from](#) command and a mail server using the [mail smtpserver](#) command.

**Syntax** mail [to <to>] [subject <subject>] [file <filename>]

Parameter	Description
to	The email recipient.  <to> Email address.
subject	Description of the subject of this email. Use quote marks when the subject text contains spaces.  <subject> String.
file	File to insert as text into the message body.  <filename> String.

**Mode** Privileged Exec

**Usage notes** When you use the **mail** command you can use parameter substitutions in the subject field. The following table lists the parameters that can be substituted and their descriptions:

Parameter	Description
<%N>	When this parameter is specified, the %N is replaced by the host name of your device.
<%S>	When this parameter is specified, the %S is replaced by the serial number of your device.
<%D> <%L> <%T>	When any of these parameters is specified, they are replaced by the current date and time (local time) on your device.
<%U>	When this parameter is specified, the %U is replaced by the current date and time (UTC time) on your device.

**NOTE:** If no local time is configured, it will use UTC.

**Examples** To send an email to "admin@example.com" with the subject "test email" and with the message body inserted from the file "test.conf", use the command:

```
awplus# mail to admin@example.com subject "test email" filename  
test.conf
```

To send an email using parameter substitutions for the host name, serial number and date, use the commands:

```
awplus# mail to admin@example.com subject "Sending email from  
Hostname:%N Serial Number:%S Date:%T"
```

**Related  
commands**

[debug mail](#)

[delete mail](#)

[mail from](#)

[mail smtpserver](#)

[mail smtpserver authentication](#)

[mail smtpserver port](#)

[show counter mail](#)

[show mail](#)

# mail from

**Overview** This command sets an email address as the sender. You must specify a sending email address with this command before you can send email.

Use the **no** variant of this command to remove the “mail from” address.

**Syntax** mail from <from>  
no mail from

Parameter	Description
<from>	The email address that the mail is sent from (also known as the hostname).

**Mode** Global Configuration

**Example** To set up your email address as the sender “kaji@nerv.com”, use the command:

```
awplus(config)# mail from kaji@nerv.com
```

**Related commands**

- debug mail
- delete mail
- mail
- mail smtpserver
- show counter mail
- show mail
- undebug mail

# mail smtpserver

**Overview** This command specifies the IP address or domain name of the SMTP server that your device sends email to. You must specify a mail server with this command before you can send email.

Use the **no** variant of this command to remove the configured mail server.

**Syntax** mail smtpserver {<ip-address>|<name>}  
no mail smtpserver

Parameter	Description
<ip-address>	Internet Protocol (IP) address for the mail server.
<name>	Domain name (FQDN) for the mail server (also known as the host name).

**Mode** Global Configuration

**Usage notes** If you specify the server by specifying its domain name, you must also ensure that the DNS client on your device is enabled. It is enabled by default but if it has been disabled, you can re-enable it by using the [ip domain-lookup](#) command.

**Examples** To specify a mail server at "192.168.0.1", use the command:

```
awplus(config)# mail smtpserver 192.168.0.1
```

To specify a mail server that has a host name of "smtp.example.com", use the command:

```
awplus(config)# mail smtpserver smtp.example.com
```

To remove the configured mail server, use the command:

```
awplus(config)# no mail smtpserver
```

**Related commands**

- [debug mail](#)
- [delete mail](#)
- [mail](#)
- [mail from](#)
- [show counter mail](#)
- [show mail](#)

# mail smtpserver authentication

**Overview** Use this command to configure SMTP mail server authentication.

Use the **no** variant of this command to remove the configured SMTP mail server authentication.

**Syntax** mail smtpserver authentication {crammd5|login|plain} username <username> password [8] <password>  
no mail smtpserver authentication

Parameter	Description
crammd5	This is a Challenge Request Authentication Mechanism based on the HMAC-MD5 mechanism and is the most secure option.
login	A BASE64 encryption method
plain	A BASE64 encryption method
<username>	Registered user name
8	The registered user password is presented in an already encrypted format. This is how the running configuration stores the plain text password and is not for general use.
<password>	Registered user password

**Default** No authentication option is set by default.

**Mode** Global Configuration

**Usage notes** You cannot change the IP address or Domain Name of the SMTP server if authentication is configured. If you attempt to change it when authentication is configured, the following error message is displayed:

```
% Error: authentication configuration still exists
```

**Examples** To configure the SMTP mail server authentication to crammd5, use the commands:

```
awplus# configure terminal  
awplus(config)# mail smtpserver authentication crammd5 username  
admin password unguessablePassword
```

To remove SMTP mail server authentication, use the commands:

```
awplus# configure terminal  
awplus(config)# no mail smtpserver authentication
```

**Output** Figure 45-1: Example output from **show mail**:

```
awplus#show mail
Mail Settings
-----
State                : Alive
SMTP Server          : 1.2.3.4
Host Name            : admin@example.com
Authentication       : crammd5
Username             : admin
Debug                : Disabled

awplus#show running-config
!
mail smtpserver authentication plain username admin password 8
aF0a9pkjbmXGfl6TlSk/GakeIK5tMYN6LqMYT8Ia2qw=
!
```

**Related  
commands**

[debug mail](#)  
[delete mail](#)  
[mail](#)  
[mail from](#)  
[mail smtpserver](#)  
[mail smtpserver port](#)  
[show counter mail](#)  
[show mail](#)

**Command  
changes**

Version 5.4.8-1.1: command added



# mail smtpserver port

**Overview** Use this command to configure the SMTP mail client/server communication port. Use the **no** variant of this command to remove the configured port and set it back to the default port 25.

**Syntax** mail smtpserver port <port>  
no mail smtpserver port

Parameter	Description
<port>	Port number from the range 1 to 65535

**Default** Port 25 is the default port.

**Mode** Global Configuration

**Examples** To configure the mail server communication over port 587, use the commands:

```
awplus# configure terminal
awplus(config)# mail smtpserver port 587
```

To remove the configured port and set it back to the default port 25, use the commands:

```
awplus# configure terminal
awplus(config)# no mail smtpserver port
```

**Output** Figure 45-2: Example output from **show mail**:

```
awplus#show mail
Mail Settings
-----
State                : Alive
SMTP Server          : 10.24.165.4
Host Name             : admin@example.com
Authentication       : plain
Username              : admin
Port                  : 587
Debug                 : Disabled

awplus#show running-config
!
mail smtpserver port 587
!
```

**Related commands** [debug mail](#)  
[delete mail](#)  
[mail](#)

mail from  
mail smtpserver  
mail smtpserver authentication  
show counter mail  
show mail

**Command changes** Version 5.4.8-1.1: command added

# show counter mail

**Overview** This command displays the mail counters.

**Syntax** show counter mail

**Mode** User Exec and Privileged Exec

**Example** To show the emails in the queue use the command:

```
awplus# show counter mail
```

**Output** Figure 45-3: Example output from the **show counter mail** command

```
Mail Client (SMTP) counters
Mails Sent           ..... 2
Mails Sent Fails     ..... 1
```

**Table 1:** Parameters in the output of the **show counter mail** command

Parameter	Description
Mails Sent	The number of emails sent successfully since the last device restart.
Mails Sent Fails	The number of emails the device failed to send since the last device restart.

- Related commands**
- [debug mail](#)
  - [delete mail](#)
  - [mail](#)
  - [mail from](#)
  - [show mail](#)

# show mail

**Overview** This command displays the emails in the queue.

**Syntax** show mail

**Mode** Privileged Exec

**Example** To display the emails in the queue use the command:

```
awplus# show mail
```

**Output** Figure 45-4: Example output from the **show mail** command:

```
awplus#show mail
Mail Settings
-----
State                : Alive
SMTP Server          : example.net
Host Name             : test@example.com
Debug                 : Enabled

Messages
-----
To                   : rei@nerv.com
Subject              : The WAN is down
Message-ID           : 20180615121150.8663

To                   : rei@nerv.com
Subject              : WAN is not connecting in the lab
Message-ID           : 20180614142502.19308

To                   : rei@nerv.com
Subject              : The LAN is not functioning
Message-ID           : 20180614141911.29709
```

- Related commands**
- [delete mail](#)
  - [mail](#)
  - [mail from](#)
  - [mail smtpserver](#)
  - [show counter mail](#)
  - [undebug mail](#)

# undebug mail

**Overview** This command applies the functionality of the no [debug mail](#) command.

# 46

# RMON Commands

## Introduction

**Overview** This chapter provides an alphabetical reference for commands used to configure Remote Monitoring (RMON).

For an introduction to RMON and an RMON configuration example, see the [RMON Feature Overview and Configuration Guide](#).

RMON is disabled by default in AlliedWare Plus™. No RMON alarms or events are configured.

For information on filtering and saving command output, see the [“Getting Started with AlliedWare Plus” Feature Overview and Configuration Guide](#).

- Command List**
- [“rmon alarm”](#) on page 1831
  - [“rmon collection history”](#) on page 1833
  - [“rmon collection stats”](#) on page 1834
  - [“rmon event”](#) on page 1835
  - [“show rmon alarm”](#) on page 1836
  - [“show rmon event”](#) on page 1837
  - [“show rmon history”](#) on page 1839
  - [“show rmon statistics”](#) on page 1841

# rmon alarm

**Overview** Use this command to configure an RMON alarm to monitor the value of an SNMP object, and to trigger specified events when the monitored object crosses specified thresholds.

To specify the action taken when the alarm is triggered, use the event index of an event defined by the [rmon event](#) command.

Use the **no** variant of this command to remove the alarm configuration.

**NOTE:** Only alarms for switch port interfaces, not for VLAN interfaces, can be configured.

**Syntax**

```
rmon alarm <alarm-index> <oid> interval <1-2147483647>
{delta|absolute} rising-threshold <1-2147483647> event
<rising-event-index> falling-threshold <1-2147483647> event
<falling-event-index> alarmstartup [1|2|3] [owner <owner>]

no rmon alarm <alarm-index>
```

Parameter	Description
<alarm-index>	<1-65535> Alarm entry index value.
<oid>	The variable SNMP MIB Object Identifier (OID) name to be monitored, in the format etherStatsEntry.<field>.<stats-index>. For example, etherStatsEntry.5.22 is the OID for the etherStatsPkts field in the etherStatsEntry table for the interface defined by the <stats-index> 22 in the <a href="#">rmon collection stats</a> command.
interval <1-2147483647>	Polling interval in seconds.
delta	The RMON MIB alarmSampleType: the change in the monitored MIB object value between the beginning and end of the polling interval.
absolute	The RMON MIB alarmSampleType: the value of the monitored MIB object.
rising-threshold <1-2147483647>	Rising threshold value of the alarm entry in seconds.
<rising-event-index>	<1-65535> The event to be triggered when the monitored object value reaches the rising threshold value. This is an event index of an event specified by the <a href="#">rmon event</a> command.
falling-threshold <1-2147483647>	Falling threshold value of the alarm entry in seconds.
<falling-event-index>	<1-65535> The event to be triggered when the monitored object value reaches the falling threshold value. This is an event index of an event specified by the <a href="#">rmon event</a> command.

Parameter	Description
alarmstartup {1 2 3}	Whether RMON can trigger a falling alarm (1), a rising alarm (2) or either (3) when you first start monitoring. See the Usage section for more information. The default is setting 3 (either).
owner <owner>	Arbitrary owner name to identify the alarm entry.

**Default** By default, there are no alarms.

**Mode** Global Configuration

**Usage notes** RMON alarms have a rising and falling threshold. Once the alarm monitoring is operating, you cannot have a falling alarm unless there has been a rising alarm and vice versa.

However, when you start RMON alarm monitoring, an alarm must be generated without the other type of alarm having first been triggered. The **alarmstartup** parameter allows this. It is used to say whether RMON can generate a rising alarm (1), a falling alarm (2) or either alarm (3) as the first alarm.

Note that the SNMP MIB Object Identifier (OID) indicated in the command syntax with <oid> must be specified as a dotted decimal value with the form etherStatsEntry.<field>.<stats-index>, for example, etherStatsEntry.22.5.

**Example** To configure an alarm to monitor the change per minute in the etherStatsPkt value for interface 22 (defined by stats-index 22 in the [rmon collection stats](#) command), to trigger event 2 (defined by the [rmon event](#) command) when it reaches the rising threshold 400, and to trigger event 3 when it reaches the falling threshold 200, and identify this alarm as belonging to Maria, use the commands:

```
awplus# configure terminal
awplus(config)# rmon alarm 229 etherStatsEntry.22.5 interval 60
delta rising-threshold 400 event 2 falling-threshold 200 event
3 alarmstartup 3 owner maria
```

**Related commands** [rmon collection stats](#)  
[rmon event](#)



# rmon collection history

**Overview** Use this command to create a history statistics control group to store a specified number of snapshots (buckets) of the standard RMON statistics for the switch port, and to collect these statistics at specified intervals. If there is sufficient memory available, then the device will allocate memory for storing the set of buckets that comprise this history control.

Use the **no** variant of this command to remove the specified history control configuration.

**NOTE:** Only a history for switch port interfaces, not for VLAN interfaces, can be collected.

**Syntax** `rmon collection history <history-index> [buckets <1-65535>]  
[interval <1-3600>] [owner <owner>]  
no rmon collection history <history-index>`

Parameter	Description
<history-index>	<1-65535> A unique RMON history control entry index value.
buckets <1-65535>	Number of requested buckets to store snapshots. Default 50 buckets.
interval <1-3600>	Polling interval in seconds. Default 1800 second polling interval.
owner <owner>	Owner name to identify the entry.

**Default** The default interval is 1800 seconds and the default buckets is 50 buckets.

**Mode** Interface Configuration

**Example** To create a history statistics control group with ID 200 to store 500 snapshots with an interval of 600 seconds, use the commands:

```
awplus# configure terminal
awplus(config)# interface port1.0.2
awplus(config-if)# rmon collection history 200 buckets 500
interval 600 owner herbert
```

To disable the history statistics control group, use the commands:

```
awplus# configure terminal
awplus(config)# interface port1.0.2
awplus(config-if)# no rmon collection history 200
```

# rmon collection stats

**Overview** Use this command to enable the collection of RMON statistics on a switch port, and assign an index number by which to access these collected statistics.

Use the **no** variant of this command to stop collecting RMON statistics on this switch port.

**NOTE:** Only statistics for switch port interfaces, not for VLAN interfaces, can be collected.

**Syntax** `rmon collection stats <collection-index> [owner <owner>]`  
`no rmon collection stats <collection-index>`

Parameter	Description
<code>&lt;collection-index&gt;</code>	<code>&lt;1-65535&gt;</code> Give this collection of statistics an index number to uniquely identify it. This is the index to use to access the statistics collected for this switch port.
<code>owner &lt;owner&gt;</code>	An arbitrary owner name to identify this statistics collection entry.

**Default** RMON statistics are not enabled by default.

**Mode** Interface Configuration

**Example** To enable the collection of RMON statistics with a statistics index of 200, use the commands:

```
awplus# configure terminal
awplus(config)# interface port1.0.2
awplus(config-if)# rmon collection stats 200 owner myrtle
```

To stop collecting RMON statistics, use the commands:

```
awplus# configure terminal
awplus(config)# interface port1.0.2
awplus(config-if)# no rmon collection stats 200
```

# rmon event

**Overview** Use this command to create an event definition for a log or a trap or both. The event index for this event can then be referred to by the [rmon alarm](#) command.

Use the **no** variant of this command to remove the event definition.

**NOTE:** Only the events for switch port interfaces, not for VLAN interfaces, can be collected.

**Syntax**

```
rmon event <event-index> [description <description>|owner <owner>| trap <trap>]
```

```
rmon event <event-index> [log [description <description>|owner <owner>|trap <trap>] ]
```

```
rmon event <event-index> [log trap [description <description>|owner <owner>] ]
```

```
no rmon event <event-index>
```

Parameter	Description
<event-index>	<1-65535> Unique event entry index value.
log	Log event type.
trap	Trap event type.
log trap	Log and trap event type.
description<description>	Event entry description.
owner <owner>	Owner name to identify the entry.

**Default** No event is configured by default.

**Mode** Global Configuration

**Example** To create an event definition for a log with an index of 299, use this command:

```
awplus# configure terminal  
awplus(config)# rmon event 299 log description cond3 owner alfred
```

To to remove the event definition, use the command:

```
awplus# configure terminal  
awplus(config)# no rmon event 299
```

**Related commands** [rmon alarm](#)

# show rmon alarm

**Overview** Use this command to display the alarms and threshold configured for the RMON probe.

**NOTE:** *Only the alarms for switch port interfaces, not for VLAN interfaces, can be shown.*

**Syntax** `show rmon alarm`

**Mode** User Exec and Privileged Exec

**Example** To display the alarms and threshold, use this command:

```
awplus# show rmon alarm
```

**Related commands** [rmon alarm](#)

# show rmon event

**Overview** Use this command to display the events configured for the RMON probe.

**NOTE:** Only the events for switch port interfaces, not for VLAN interfaces, can be shown.

**Syntax** show rmon event

**Mode** User Exec and Privileged Exec

**Output** Figure 46-1: Example output from the **show rmon event** command

```
awplus#sh rmon event
event Index = 787
  Description TRAP
  Event type log & trap
  Event community name gopher
  Last Time Sent = 0
  Owner RMON_SNMP

event Index = 990
  Description TRAP
  Event type trap
  Event community name teabo
  Last Time Sent = 0
  Owner RMON_SNMP
```

**NOTE:** The following etherStats counters are not currently available for Layer 3 interfaces:

- etherStatsBroadcastPkts
- etherStatsCRCAlignErrors
- etherStatsUndersizePkts
- etherStatsOversizePkts
- etherStatsFragments
- etherStatsJabbers
- etherStatsCollisions
- etherStatsPkts64Octets
- etherStatsPkts65to127Octets
- etherStatsPkts128to255Octets
- etherStatsPkts256to511Octets
- etherStatsPkts512to1023Octets
- etherStatsPkts1024to1518Octets

**Example** To display the events configured for the RMON probe, use this command:

```
awplus# show rmon event
```

**Related  
commands** [rmon event](#)

# show rmon history

**Overview** Use this command to display the parameters specified on all the currently defined RMON history collections on the device.

**NOTE:** Only the history for switch port interfaces, not for VLAN interfaces, can be shown.

**Syntax** show rmon history

**Mode** User Exec and Privileged Exec

**Output** Figure 46-2: Example output from the **show rmon history** command

```
awplus#sh rmon history
  history index = 56
    data source ifindex = 4501
    buckets requested = 34
    buckets granted = 34
    Interval = 2000
    Owner Andrew

  history index = 458
    data source ifindex = 5004
    buckets requested = 400
    buckets granted = 400
    Interval = 1500
    Owner trev
=====
```

**NOTE:** The following etherStats counters are not currently available for Layer 3 interfaces:

- etherStatsBroadcastPkts
- etherStatsCRCAlignErrors
- etherStatsUndersizePkts
- etherStatsOversizePkts
- etherStatsFragments
- etherStatsJabbers
- etherStatsCollisions
- etherStatsPkts64Octets
- etherStatsPkts65to127Octets
- etherStatsPkts128to255Octets
- etherStatsPkts256to511Octets
- etherStatsPkts512to1023Octets

- etherStatsPkts1024to1518Octets

**Example** To display the parameters specified on all the currently defined RMON history collections, use the commands:

```
awplus# show rmon history
```

**Related commands** [rmon collection history](#)



# show rmon statistics

**Overview** Use this command to display the current values of the statistics for all the RMON statistics collections currently defined on the device.

**NOTE:** Only statistics for switch port interfaces, not for VLAN interfaces, can be shown.

**Syntax** show rmon statistics

**Mode** User Exec and Privileged Exec

**Example** To display the current values of the statistics for all the RMON statistics collections, use the commands:

```
awplus# show rmon statistics
```

**Output** Figure 46-3: Example output from the **show rmon statistics** command

```
awplus#show rmon statistics
rmon collection index 45
stats->ifindex = 4501
input packets 1279340, bytes 85858960, dropped 00, multicast packets 1272100
output packets 7306090, bytes 268724, multicast packets 7305660 broadcast
packets 290
rmon collection index 679
stats->ifindex = 5013
input packets 00, bytes 00, dropped 00, multicast packets 00
output packets 8554550, bytes 26777324, multicast packets 8546690 broadcast
packets 7720
```

**NOTE:** The following etherStats counters are not currently available for Layer 3 interfaces:

- etherStatsBroadcastPkts
- etherStatsCRCAlignErrors
- etherStatsUndersizePkts
- etherStatsOversizePkts
- etherStatsFragments
- etherStatsJabbers
- etherStatsCollisions
- etherStatsPkts64Octets
- etherStatsPkts65to127Octets
- etherStatsPkts128to255Octets
- etherStatsPkts256to511Octets
- etherStatsPkts512to1023Octets

- etherStatsPkts1024to1518Octets

**Related  
commands** [rmon collection stats](#)

# 47

# Secure Shell (SSH) Commands

## Introduction

**Overview** This chapter provides an alphabetical reference for commands used to configure Secure Shell (SSH). For more information, see the [SSH Feature Overview and Configuration Guide](#).

- Command List**
- “[banner login \(SSH\)](#)” on page 1845
  - “[clear ssh](#)” on page 1846
  - “[crypto key destroy hostkey](#)” on page 1847
  - “[crypto key destroy userkey](#)” on page 1848
  - “[crypto key generate hostkey](#)” on page 1849
  - “[crypto key generate userkey](#)” on page 1851
  - “[crypto key pubkey-chain knownhosts](#)” on page 1852
  - “[crypto key pubkey-chain userkey](#)” on page 1854
  - “[debug ssh client](#)” on page 1856
  - “[debug ssh server](#)” on page 1857
  - “[service ssh](#)” on page 1858
  - “[show banner login](#)” on page 1860
  - “[show crypto key hostkey](#)” on page 1861
  - “[show crypto key pubkey-chain knownhosts](#)” on page 1863
  - “[show crypto key pubkey-chain userkey](#)” on page 1864
  - “[show crypto key userkey](#)” on page 1865
  - “[show running-config ssh](#)” on page 1866
  - “[show ssh](#)” on page 1868
  - “[show ssh client](#)” on page 1870

- [“show ssh server”](#) on page 1871
- [“show ssh server allow-users”](#) on page 1873
- [“show ssh server deny-users”](#) on page 1874
- [“ssh”](#) on page 1875
- [“ssh client”](#) on page 1877
- [“ssh server”](#) on page 1879
- [“ssh server allow-users”](#) on page 1881
- [“ssh server authentication”](#) on page 1883
- [“ssh server deny-users”](#) on page 1885
- [“ssh server max-auth-tries”](#) on page 1887
- [“ssh server resolve-host”](#) on page 1888
- [“ssh server scp”](#) on page 1889
- [“ssh server sftp”](#) on page 1890
- [“undebg ssh client”](#) on page 1891
- [“undebg ssh server”](#) on page 1892

# banner login (SSH)

**Overview** This command configures a login banner on the SSH server. This displays a message on the remote terminal of the SSH client before the login prompt. SSH client version 1 does not support this banner.

To add a banner, first enter the command **banner login**, and hit [Enter]. Write your message. You can use any character and spaces. Use Ctrl+D at the end of your message to save the text and re-enter the normal command line mode.

The banner message is preserved if the device restarts.

The **no** variant of this command deletes the login banner from the device.

**Syntax** banner login  
no banner login

**Default** No banner is defined by default.

**Mode** Global Configuration

**Examples** To set a login banner message, use the commands:

```
awplus# configure terminal  
awplus(config)# banner login
```

The screen will prompt you to enter the message:

Type CNTL/D to finish.

... banner message comes here ...

Enter the message. Use Ctrl+D to finish, like this:

```
^D  
awplus(config)#
```

To remove the login banner message, use the commands:

```
awplus# configure terminal  
awplus(config)# no banner login
```

**Related commands** [show banner login](#)

# clear ssh

**Overview** This command deletes Secure Shell sessions currently active on the device. This includes both incoming and outgoing sessions. The deleted sessions are closed. You can only delete an SSH session if you are a system manager or the user who initiated the session. If **all** is specified then all active SSH sessions are deleted.

**Syntax** `clear ssh {<1-65535>|all}`

Parameters	Description
<1-65535>	Specify a session ID in the range 1 to 65535 to delete a specific session.
all	Delete all SSH sessions.

**Mode** Privileged Exec

**Examples** To stop the current SSH session 123, use the command:

```
awplus# clear ssh 123
```

To stop all SSH sessions active on the device, use the command:

```
awplus# clear ssh all
```

**Related commands** [service ssh](#)  
[ssh](#)

# crypto key destroy hostkey

**Overview** This command deletes the existing public and private keys of the SSH server.

When you enable the SSH server, the server automatically generates an SSHv2 host key pair (public and private keys), using RSA with 1024-bit key generation. If you need a key with different parameters than this, you can use the [crypto key generate hostkey](#) command to generate that key before you enable the SSH server.

**Syntax** `crypto key destroy hostkey {dsa|ecdsa|rsa|rsa1}`

Parameters	Description
<code>dsa</code>	Deletes the existing DSA public and private keys.
<code>ecdsa</code>	Deletes the existing ECDSA public and private keys.
<code>rsa</code>	Deletes the existing RSA public and private keys configured for SSH version 2 connections.
<code>rsa1</code>	Deletes the existing RSA public and private keys configured for SSH version 1 connections.

**Mode** Global Configuration

**Example** To destroy the RSA host key used for SSH version 2 connections, use the commands:

```
awplus# configure terminal
awplus(config)# crypto key destroy hostkey rsa
```

**Related commands** [crypto key generate hostkey](#)  
[service ssh](#)

# crypto key destroy userkey

**Overview** This command destroys the existing public and private keys of an SSH user configured on the device.

**Syntax** `crypto key destroy userkey <username> {dsa|rsa|rsa1}`

Parameters	Description
<code>&lt;username&gt;</code>	Name of the user whose userkey you are destroying. The username must begin with a letter. Valid characters are all numbers, letters, and the underscore, hyphen and full stop symbols.
<code>dsa</code>	Deletes the existing DSA userkey.
<code>rsa</code>	Deletes the existing RSA userkey configured for SSH version 2 connections.
<code>rsa1</code>	Deletes the existing RSA userkey for SSH version 1 connections.

**Mode** Global Configuration

**Example** To destroy the RSA user key for the SSH user `remoteuser`, use the commands:

```
awplus# configure terminal
awplus(config)# crypto key destroy userkey remoteuser rsa
```

**Related commands**

- [crypto key generate hostkey](#)
- [show ssh](#)
- [show crypto key hostkey](#)



# crypto key generate hostkey

**Overview** This command generates public and private keys for the SSH server.

When you enable the SSH server, the server automatically generates an SSHv2 host key pair (public and private keys), using RSA with 1024-bit key generation.

If you need a key with different parameters than this, you can use this command to generate that key before you enable the SSH server. If a host key exists with the same cryptography algorithm, this command replaces the old host key with the new key.

This command is not saved in the device configuration. However, the device saves the keys generated by this command in the non-volatile memory.

**Syntax** `crypto key generate hostkey {dsa} [<768-1024>]`  
`crypto key generate hostkey {rsa|rsa1} [<768-32768>]`  
`crypto key generate hostkey {ecdsa} [<256/384>]`

Parameters	Description
dsa	Creates a DSA hostkey. Both SSH version 1 and 2 connections can use the DSA hostkey.
rsa	Creates an RSA hostkey for SSH version 2 connections.
rsa1	Creates an RSA hostkey for SSH version 1 connections.
ecdsa	Creates an ECDSA hostkey. Both SSH version 1 and 2 connections can use the ECDSA hostkey.
<768-32768>	The length in bits of the generated key. The default is 1024 bits.
<256/384>	The ECDSA key size in bits. The default is 256, but it can be set to 384.

**Default** The default key length for RSA and DSA is 1024 bits.

The default key size for ECDSA is 256 bits.

**Mode** Global Configuration

**Examples** To generate an RSA host key for SSH version 2 connections that is 2048 bits in length, use the commands:

```
awplus# configure terminal
awplus(config)# crypto key generate hostkey rsa 2048
```

To generate a DSA host key, use the commands:

```
awplus# configure terminal
awplus(config)# crypto key generate dsa
```

To generate an ECDSA host key with an elliptic curve size of 384 bits, use the commands:

```
awplus# configure terminal  
awplus(config)# crypto key generate ecdsa 384
```

**Related commands**

- [crypto key destroy hostkey](#)
- [service ssh](#)
- [show crypto key hostkey](#)

# crypto key generate userkey

**Overview** This command generates public and private keys for an SSH user using either an RSA or DSA cryptography algorithm. To use public key authentication, copy the public key of the user onto the remote SSH server.

This command is not saved in the device configuration. However, the device saves the keys generated by this command in the non-volatile memory.

**Syntax** `crypto key generate userkey <username> {dsa} [<768-1024>]`  
`crypto key generate userkey <username> {rsa|rsa1} [<768-32768>]`  
`crypto key generate userkey <username> {ecdsa} [<256/384>]`

Parameters	Description
<username>	Name of the user that the user key is generated for. The username must begin with a letter. Valid characters are all numbers, letters, and the underscore, hyphen and full stop symbols.
dsa	Creates a DSA userkey. Both SSH version 1 and 2 connections can use a key created with this command.
rsa	Creates an RSA userkey for SSH version 2 connections.
rsa1	Creates an RSA userkey for SSH version 1 connections.
ecdsa	Creates an ECDSA hostkey. Both SSH version 1 and 2 connections can use the ECDSA hostkey.
<768-32768>	The length in bits of the generated key. The default is 1024 bits.
<256/384>	The ECDSA key size in bits. The default is 256, but it can be set to 384.

**Mode** Global Configuration

**Examples** To generate a 2048-bits RSA user key for SSH version 2 connections for the user "bob", use the commands:

```
awplus# configure terminal  
awplus(config)# crypto key generate userkey bob rsa 2048
```

To generate a DSA user key for the user "lapo", use the commands:

```
awplus# configure terminal  
awplus(config)# crypto key generate userkey lapo dsa
```

**Related commands** [crypto key pubkey-chain userkey](#)  
[show crypto key userkey](#)

# crypto key pubkey-chain knownhosts

**Overview** This command adds a public key of the specified SSH server to the known host database on your device. The SSH client on your device uses this public key to verify the remote SSH server.

The key is retrieved from the server. Before adding a key to this database, check that the key sent to you is correct.

If the server's key changes, or if your SSH client does not have the public key of the remote SSH server, then your SSH client will inform you that the public key of the server is unknown or altered.

The **no** variant of this command deletes the public key of the specified SSH server from the known host database on your device.

**Syntax** `crypto key pubkey-chain knownhosts [ip|ipv6] <hostname> [rsa|dsa|rsa1]`  
`no crypto key pubkey-chain knownhosts <1-65535>`

Parameter	Description
ip	Keyword used prior to specifying an IPv4 address
ipv6	Keyword used prior to specifying an IPv6 address
<hostname>	IPv4/IPv6 address or hostname of a remote server in the format a.b.c.d for an IPv4 address, or in the format x:x::x:x for an IPv6 address.
rsa	Specify the RSA public key of the server to be added to the known host database.
dsa	Specify the DSA public key of the server to be added to the known host database.
rsa1	Specify the SSHv1 public key of the server to be added to the know host database.
<1-65535>	Specify a key identifier when removing a key using the <b>no</b> parameter.

**Default** If no cryptography algorithm is specified, then **rsa** is used as the default cryptography algorithm.

**Mode** Privilege Exec

**Usage notes** This command adds a public key of the specified SSH server to the known host database on the device. The key is retrieved from the server. The remote SSH server is verified by using this public key. The user is requested to check the key is correct before adding it to the database.

If the remote server's host key is changed, or if the device does not have the public key of the remote server, then SSH clients will inform the user that the public key of the server is altered or unknown.

**Examples** To add the RSA host key of the remote SSH host IPv4 address 192.0.2.11 to the known host database, use the command:

```
awplus# crypto key pubkey-chain knownhosts 192.0.2.11
```

To delete the second entry in the known host database, use the command:

```
awplus# no crypto key pubkey-chain knownhosts 2
```

**Validation Commands** `show crypto key pubkey-chain knownhosts`

# crypto key pubkey-chain userkey

**Overview** This command adds a public key for an SSH user on the SSH server. This allows the SSH server to support public key authentication for the SSH user. When configured, the SSH user can access the SSH server without providing a password from the remote host.

The **no** variant of this command removes a public key for the specified SSH user that has been added to the public key chain. When a SSH user's public key is removed, the SSH user can no longer login using public key authentication.

**Syntax** `crypto key pubkey-chain userkey <username> [<filename>]`  
`no crypto key pubkey-chain userkey <username> <1-65535>`

Parameters	Description
<username>	Name of the user that the SSH server associates the key with. The username must begin with a letter. Valid characters are all numbers, letters, and the underscore, hyphen and full stop symbols. Default: no default
<filename>	Filename of a key saved in flash. Valid characters are any printable character. You can add a key as a hexadecimal string directly into the terminal if you do not specify a filename.
<1-65535>	The key ID number of the user's key. Specify the key ID to delete a key.

**Mode** Global Configuration

**Usage notes** You should import the public key file from the client node. The device can read the data from a file on the flash or user terminal.

Or you can add a key as text into the terminal. To add a key as text into the terminal, first enter the command **crypto key pubkey-chain userkey <username>**, and hit [Enter]. Enter the key as text. Note that the key you enter as text must be a valid SSH RSA key, not random ASCII text. Use [Ctrl]+D after entering it to save the text and re-enter the normal command line mode.

Note you can generate a valid SSH RSA key on the device first using the **crypto key generate host rsa** command. View the SSH RSA key generated on the device using the **show crypto hostkey rsa** command. Copy and paste the displayed SSH RSA key after entering the **crypto key pubkey-chain userkey <username>** command. Use [Ctrl]+D after entering it to save it.

**Examples** To generate a valid SSH RSA key on the device and add the key, use the following commands:

```
awplus# configure terminal
awplus(config)# crypto key generate host rsa
awplus(config)# exit

awplus# show crypto key hostkey
rsaAAAAB3NzaC1yc2EAAAABIwAAAIEAr1s7SokW5aW2fcOw1TStpb9J20bWluhnUC768EoWhyPW6FZ2t536005M29EpKBmGq1kQaz5V0mU9IQe66+5YyD4UxOKSDtTI+7jtjDcoGWHb2u4sFwRpXwJZcgYrXW16+6NvNbk+h+c/pqGDijj4SvfZZfeITzvvyZW4/I4pbN8=

awplus# configure terminal
awplus(config)# crypto key pubkey-chain userkey joeType CNTRL/D
to
finish:AAAAB3NzaC1yc2EAAAABIwAAAIEAr1s7SokW5aW2fcOw1TStpb9J20bWluhnUC768EoWhyPW6FZ2t536005M29EpKBmGq1kQaz5V0mU9IQe66+5YyD4UxOKSDtTI+7jtjDcoGWHb2u4sFwRpXwJZcgYrXW16+6NvNbk+h+c/pqGDijj4SvfZZfeITzvvyZW4/I4pbN8=control-D

awplus(config)#
```

To add a public key for the user `graydon` from the file `key.pub`, use the commands:

```
awplus# configure terminal
awplus(config)# crypto key pubkey-chain userkey graydon key.pub
```

To add a public key for the user `tamara` from the terminal, use the commands:

```
awplus# configure terminal
awplus(config)# crypto key pubkey-chain userkey tamara
```

and enter the key. Use `Ctrl+D` to finish.

To remove the first key entry from the public key chain of the user `john`, use the commands:

```
awplus# configure terminal
awplus(config)# no crypto key pubkey-chain userkey john 1
```

**Related commands** [show crypto key pubkey-chain userkey](#)

# debug ssh client

**Overview** This command enables the SSH client debugging facility. When enabled, any SSH, SCP and SFTP client sessions send diagnostic messages to the login terminal.

The **no** variant of this command disables the SSH client debugging facility. This stops the SSH client from generating diagnostic debugging message.

**Syntax** `debug ssh client [brief|full]`  
`no debug ssh client`

Parameter	Description
brief	Enables brief debug mode.
full	Enables full debug mode.

**Default** SSH client debugging is disabled by default.

**Mode** Privileged Exec and Global Configuration

**Examples** To start SSH client debugging, use the command:

```
awplus# debug ssh client
```

To start SSH client debugging with extended output, use the command:

```
awplus# debug ssh client full
```

To disable SSH client debugging, use the command:

```
awplus# no debug ssh client
```

**Related commands** [debug ssh server](#)  
[show ssh client](#)  
[undebug ssh client](#)



# debug ssh server

**Overview** This command enables the SSH server debugging facility. When enabled, the SSH server sends diagnostic messages to the system log. To display the debugging messages on the terminal, use the **terminal monitor** command.

The **no** variant of this command disables the SSH server debugging facility. This stops the SSH server from generating diagnostic debugging messages.

**Syntax** `debug ssh server [brief|full]`  
`no debug ssh server`

Parameter	Description
brief	Enables brief debug mode.
full	Enables full debug mode.

**Default** SSH server debugging is disabled by default.

**Mode** Privileged Exec and Global Configuration

**Examples** To start SSH server debugging, use the command:

```
awplus# debug ssh server
```

To start SSH server debugging with extended output, use the command:

```
awplus# debug ssh server full
```

To disable SSH server debugging, use the command:

```
awplus# no debug ssh server
```

**Related commands** [debug ssh client](#)  
[show ssh server](#)  
[undebug ssh server](#)

# service ssh

**Overview** Use this command to enable the Secure Shell server on the device. Once enabled, connections coming from SSH clients are accepted.

When you enable the SSH server, the server automatically generates an SSHv2 host key pair (public and private keys), using RSA with 1024-bit key generation. If you need a key with different parameters than this, you can use the [crypto key generate hostkey](#) command to generate that key before you enable the SSH server.

Use the **no** variant of this command disables the Secure Shell server. When the Secure Shell server is disabled, connections from SSH, SCP, and SFTP clients are not accepted. This command does not affect existing SSH sessions. To terminate existing sessions, use the [clear ssh](#) command.

**Syntax** `service ssh [ip|ipv6]`  
`no service ssh [ip|ipv6]`

**Default** The Secure Shell server is disabled by default. Both IPv4 and IPv6 Secure Shell server are enabled when you issue **service ssh** without specifying the optional **ip** or **ipv6** parameters.

**Mode** Global Configuration

**Examples** To enable both the IPv4 and the IPv6 Secure Shell server, use the commands:

```
awplus# configure terminal
awplus(config)# service ssh
```

To enable the IPv4 Secure Shell server only, use the commands:

```
awplus# configure terminal
awplus(config)# service ssh ip
```

To enable the IPv6 Secure Shell server only, use the commands:

```
awplus# configure terminal
awplus(config)# service ssh ipv6
```

To disable both the IPv4 and the IPv6 Secure Shell server, use the commands:

```
awplus# configure terminal
awplus(config)# no service ssh
```

To disable the IPv4 Secure Shell server only, use the commands:

```
awplus# configure terminal
awplus(config)# no service ssh ip
```

To disable the IPv6 Secure Shell server only, use the commands:

```
awplus# configure terminal
awplus(config)# no service ssh ipv6
```

**Related commands**

- crypto key generate hostkey
- show running-config ssh
- show ssh server
- ssh server allow-users
- ssh server deny-users

# show banner login

**Overview** This command displays the banner message configured on the device. The banner message is displayed to the remote user before user authentication starts.

**Syntax** `show banner login`

**Mode** User Exec, Privileged Exec, Global Configuration, Interface Configuration, Line Configuration

**Example** To display the current login banner message, use the command:

```
awplus# show banner login
```

**Related commands** [banner login \(SSH\)](#)

# show crypto key hostkey

**Overview** This command displays the public keys generated on the device for the SSH server.

When you enable the SSH server, the server automatically generates an SSHv2 host key pair (public and private keys), using RSA with 1024-bit key generation. If you need a key with different parameters than this, you can use the [crypto key generate hostkey](#) command to generate that key before you enable the SSH server.

The private key remains on the device secretly. The public key is copied to SSH clients to identify the server. This command displays the public key.

**Syntax** `show crypto key hostkey [dsa|ecdsa|rsa|rsa1]`

Parameter	Description
dsa	Displays the DSA algorithm public key. Both SSH version 1 and 2 connections can use the DSA hostkey
ecdsa	Displays the ECDSA algorithm public key. Both SSH version 1 and 2 connections can use the ECDSA hostkey.
rsa	Displays the RSA algorithm public key for SSH version 2 connections.
rsa1	Displays the RSA algorithm public key for SSH version 1 connections.

**Mode** User Exec, Privileged Exec and Global Configuration

**Examples** To show the public keys generated on the device for SSH server, use the command:

```
awplus# show crypto key hostkey
```

To display the RSA public key of the SSH server, use the command:

```
awplus# show crypto key hostkey rsa
```

**Output** Figure 47-1: Example output from the **show crypto key hostkey** command

Type	Bits	Fingerprint
rsa	2058	4e:7d:1d:00:75:79:c5:cb:c8:58:2e:f9:29:9c:1f:48
dsa	1024	fa:72:3d:78:35:14:cb:9a:1d:ca:1c:83:2c:7d:08:43
rsa1	1024	e2:1c:c8:8b:d8:6e:19:c8:f4:ec:00:a2:71:4e:85:8b

**Table 1:** Parameters in output of the **show crypto key hostkey** command

Parameter	Description
Type	Algorithm used to generate the key.
Bits	Length in bits of the key.
Fingerprint	Checksum value for the public key.

**Related commands** [crypto key destroy hostkey](#)  
[crypto key generate hostkey](#)

# show crypto key pubkey-chain knownhosts

**Overview** This command displays the list of public keys maintained in the known host database on the device.

**Syntax** `show crypto key pubkey-chain knownhosts [<1-65535>]`

Parameter	Description
<1-65535>	Key identifier for a specific key. Displays the public key of the entry if specified.

**Default** Display all keys.

**Mode** User Exec, Privileged Exec and Global Configuration

**Examples** To display public keys of known SSH servers, use the command:

```
awplus# show crypto key pubkey-chain knownhosts
```

To display the key data of the first entry in the known host data, use the command:

```
awplus# show crypto key pubkey-chain knownhosts 1
```

**Output** Figure 47-2: Example output from the **show crypto key public-chain knownhosts** command

No	Hostname	Type	Fingerprint
1	172.16.23.1	rsa	c8:33:b1:fe:6f:d3:8c:81:4e:f7:2a:aa:a5:be:df:18
2	172.16.23.10	rsa	c4:79:86:65:ee:a0:1d:a5:6a:e8:fd:1d:d3:4e:37:bd
3	5ffe:1053:ac21:ff00:0101:bcdf:ffff:0001	rsa1	af:4e:b4:a2:26:24:6d:65:20:32:d9:6f:32:06:ba:57

**Table 2:** Parameters in the output of the **show crypto key public-chain knownhosts** command

Parameter	Description
No	Number ID of the key.
Hostname	Host name of the known SSH server.
Type	The algorithm used to generate the key.
Fingerprint	Checksum value for the public key.

**Related commands** [crypto key pubkey-chain knownhosts](#)

# show crypto key pubkey-chain userkey

**Overview** This command displays the public keys registered with the SSH server for SSH users. These keys allow remote users to access the device using public key authentication. By using public key authentication, users can access the SSH server without providing password.

**Syntax** `show crypto key pubkey-chain userkey <username> [<1-65535>]`

Parameter	Description
<username>	User name of the remote SSH user whose keys you wish to display. The username must begin with a letter. Valid characters are all numbers, letters, and the underscore, hyphen and full stop symbols.
<1-65535>	Key identifier for a specific key.

**Default** Display all keys.

**Mode** User Exec, Privileged Exec and Global Configuration

**Example** To display the public keys for the user `manager` that are registered with the SSH server, use the command:

```
awplus# show crypto key pubkey-chain userkey manager
```

**Output** Figure 47-3: Example output from the **show crypto key public-chain userkey** command

No	Type	Bits	Fingerprint
1	dsa	1024	2b:cc:df:a8:f8:2e:8f:a4:a5:4f:32:ea:67:29:78:fd
2	rsa	2048	6a:ba:22:84:c1:26:42:57:2c:d7:85:c8:06:32:49:0e

**Table 3:** Parameters in the output of the **show crypto key userkey** command

Parameter	Description
No	Number ID of the key.
Type	The algorithm used to generate the key.
Bits	Length in bits of the key.
Fingerprint	Checksum value for the key.

**Related commands** [crypto key pubkey-chain userkey](#)



# show crypto key userkey

**Overview** This command displays the public keys created on this device for the specified SSH user.

**Syntax** `show crypto key userkey <username> [dsa|rsa|rsa1]`

Parameter	Description
<username>	User name of the local SSH user whose keys you wish to display. The username must begin with a letter. Valid characters are all numbers, letters, and the underscore, hyphen and full stop symbols.
dsa	Displays the DSA public key.
rsa	Displays the RSA public key used for SSH version 2 connections.
rsa1	Displays the RSA key used for SSH version 1 connections.

**Mode** User Exec, Privileged Exec and Global Configuration

**Examples** To show the public key generated for the user, use the command:

```
awplus# show crypto key userkey manager
```

To store the RSA public key generated for the user manager to the file "user.pub", use the command:

```
awplus# show crypto key userkey manager rsa > manager-rsa.pub
```

**Output** Figure 47-4: Example output from the **show crypto key userkey** command

Type	Bits	Fingerprint
rsa	2048	e8:d6:1b:c0:f4:b6:e6:7d:02:2e:a9:d4:a1:ca:3b:11
rsa1	1024	12:25:60:95:64:08:8e:a1:8c:3c:45:1b:44:b9:33:9b

**Table 4:** Parameters in the output of the **show crypto key userkey** command

Parameter	Description
Type	The algorithm used to generate the key.
Bits	Length in bits of the key.
Fingerprint	Checksum value for the key.

**Related commands** [crypto key generate userkey](#)

# show running-config ssh

**Overview** This command displays the current running configuration of Secure Shell (SSH).

**Syntax** show running-config ssh

**Mode** Privileged Exec and Global Configuration

**Example** To display the current configuration of SSH, use the command:

```
awplus# show running-config ssh
```

**Output** Figure 47-5: Example output from the **show running-config ssh** command

```
!  
ssh server session-timeout 600  
ssh server login-timeout 30  
ssh server allow-users manager 192.168.1.*  
ssh server allow-users john  
ssh server deny-user john*.a-company.com  
ssh server
```

**Table 5:** Parameters in the output of the **show running-config ssh** command

Parameter	Description
ssh server	SSH server is enabled.
ssh server v2	SSH server is enabled and only support SSHv2.
ssh server<port>	SSH server is enabled and listening on the specified TCP port.
no ssh server scp	SCP service is disabled.
no ssh server sftp	SFTP service is disabled.
ssh server session-timeout	Configure the server session timeout.
ssh server login-timeout	Configure the server login timeout.
ssh server max-startups	Configure the maximum number of concurrent sessions waiting authentication.
no ssh server authentication password	Password authentication is disabled.
no ssh server authentication publickey	Public key authentication is disabled.

**Table 5:** Parameters in the output of the **show running-config ssh** command

Parameter	Description
ssh server allow-users	Add the user (and hostname) to the allow list.
ssh server deny-users	Add the user (and hostname) to the deny list.

**Related commands**

- service ssh
- show ssh server

# show ssh

**Overview** This command displays the active SSH sessions on the device, both incoming and outgoing.

**Syntax** show ssh

**Mode** User Exec, Privileged Exec and Global Configuration

**Example** To display the current SSH sessions on the device, use the command:

```
awplus# show ssh
```

**Output** Figure 47-6: Example output from the **show ssh** command

```
Secure Shell Sessions:
ID  Type Mode   Peer Host      Username      State      Filename
-----
414 ssh  server 172.16.23.1   root         open
456 ssh  client 172.16.23.10 manager      user-auth
459 scp  client 172.16.23.12 root         download   example.awd
463 ssh  client 5ffe:33fe:5632:ffbb:bc35:ddee:0101:ac51
                                manager      user-auth
```

**Table 6:** Parameters in the output of the **show ssh** command

Parameter	Description
ID	Unique identifier for each SSH session.
Type	Session type; either SSH, SCP, or SFTP.
Mode	Whether the device is acting as an SSH client (client) or SSH server (server) for the specified session.
Peer Host	The hostname or IP address of the remote server or client.
Username	Login user name of the server.

**Table 6:** Parameters in the output of the **show ssh** command (cont.)

Parameter	Description	
State	The current state of the SSH session. One of:	
	connecting	The device is looking for a remote server.
	connected	The device is connected to the remote server.
	accepted	The device has accepted a new session.
	host-auth	host-to-host authentication is in progress.
	user-auth	User authentication is in progress.
	authenticated	User authentication is complete.
	open	The session is in progress.
	download	The user is downloading a file from the device.
	upload	The user is uploading a file from the device.
	closing	The user is terminating the session.
	closed	The session is closed.
Filename	Local filename of the file that the user is downloading or uploading.	

**Related commands** [clear ssh](#)

# show ssh client

**Overview** This command displays the current configuration of the Secure Shell client.

**Syntax** `show ssh client`

**Mode** User Exec, Privileged Exec and Global Configuration

**Example** To display the current configuration for SSH clients on the login shell, use the command:

```
awplus# show ssh client
```

**Output** Figure 47-7: Example output from the **show ssh client** command

```
Secure Shell Client Configuration
-----
Port                : 22
Version             : 2,1
Connect Timeout     : 30 seconds
Session Timeout     : 0 (off)
Debug               : NONE
```

**Table 7:** Parameters in the output of the **show ssh client** command

Parameter	Description
Port	SSH server TCP port where the SSH client connects to. The default is port 22.
Version	SSH server version; either "1", "2" or "2,1".
Connect Timeout	Time in seconds that the SSH client waits for an SSH session to establish. If the value is 0, the connection is terminated when it reaches the TCP timeout.
Debug	Whether debugging is active on the client.

**Related commands** [show ssh server](#)

# show ssh server

**Overview** This command displays the current configuration of the Secure Shell server.

Note that changes to the SSH configuration affects only new SSH sessions coming from remote hosts, and does not affect existing sessions.

**Syntax** show ssh server

**Mode** User Exec, Privileged Exec and Global Configuration

**Example** To display the current configuration of the Secure Shell server, use the command:

```
awplus# show ssh server
```

**Output** Figure 47-8: Example output from the **show ssh server** command

```
Secure Shell Server Configuration
-----
SSH Server           : Enabled
Port                 : 22
Version              : 2
Services              : scp, sftp
User Authentication  : publickey, password
Resolve Hosts        : Disabled
Session Timeout      : 0 (Off)
Login Timeout        : 60 seconds
Maximum Authentication Tries : 6
Maximum Startups     : 10
Debug                : NONE
```

**Table 8:** Parameters in the output of the **show ssh server** command

Parameter	Description
SSH Server	Whether the Secure Shell server is enabled or disabled.
Port	TCP port where the Secure Shell server listens for connections. The default is port 22.
Version	SSH server version; either "1", "2" or "2,1".
Services	List of the available Secure Shell service; one or more of SHELL, SCP or SFTP.
Authentication	List of available authentication methods.
Login Timeout	Time (in seconds) that the SSH server will wait the SSH session to establish. If the value is 0, the client login will be terminated when TCP timeout reaches.

**Table 8:** Parameters in the output of the **show ssh server** command (cont.)

Parameter	Description
Idle Timeout	Time (in seconds) that the SSH server will wait to receive data from the SSH client. The server disconnects if this timer limit is reached. If set at 0, the idle timer remains off.
Maximum Startups	The maximum number of concurrent connections that are waiting authentication. The default is 10.
Debug	Whether debugging is active on the server.

**Related commands** [show ssh](#)  
[show ssh client](#)



# show ssh server allow-users

**Overview** This command displays the user entries in the allow list of the SSH server.

**Syntax** `show ssh server allow-users`

**Mode** User Exec, Privileged Exec and Global Configuration

**Example** To display the user entries in the allow list of the SSH server, use the command:

```
awplus# show ssh server allow-users
```

**Output** Figure 47-9: Example output from the **show ssh server allow-users** command

Username	Remote Hostname (pattern)
awplus	192.168.*
john	
manager	*.alliedtelesis.com

**Table 9:** Parameters in the output of the **show ssh server allow-users** command

Parameter	Description
Username	User name that is allowed to access the SSH server.
Remote Hostname (pattern)	IP address or hostname pattern of the remote client. The user is allowed requests from a host that matches this pattern. If no hostname is specified, the user is allowed from all hosts.

**Related commands** [ssh server allow-users](#)  
[ssh server deny-users](#)

# show ssh server deny-users

**Overview** This command displays the user entries in the deny list of the SSH server. The user in the deny list is rejected to access the SSH server. If a user is not included in the access list of the SSH server, the user is also rejected.

**Syntax** `show ssh server deny-users`

**Mode** User Exec, Privileged Exec and Global Configuration

**Example** To display the user entries in the deny list of the SSH server, use the command:

```
awplus# show ssh server deny-users
```

**Output** Figure 47-10: Example output from the **show ssh server deny-users** command

Username	Remote Hostname (pattern)
john	*.b-company.com
manager	192.168.2.*

**Table 10:** Parameters in the output of the **show ssh server deny-user** command

Parameter	Description
Username	The user that this rule applies to.
Remote Hostname (pattern)	IP address or hostname pattern of the remote client. The user is denied requests from a host that matches this pattern. If no hostname is specified, the user is denied from all hosts.

**Related commands** [ssh server allow-users](#)  
[ssh server deny-users](#)

# ssh

**Overview** Use this command to initiate a Secure Shell connection to a remote SSH server.

If the server requests a password to login, you need to type in the correct password at the "Password:" prompt.

An SSH client identifies the remote SSH server by its public key registered on the client device. If the server identification is changed, server verification fails. If the public key of the server has been changed, the public key of the server must be explicitly added to the known host database.

**NOTE:** A hostname specified with SSH cannot begin with a hyphen (-) character.

**Syntax** `ssh [ip|ipv6] [user <username>|port <1-65535>|version {1|2}] <remote-device> [<command>]`

Parameter	Description
ip	Specify IPv4 SSH.
ipv6	Specify IPv6 SSH.
user	<p>Login user. If user is specified, the username is used for login to the remote SSH server when user authentication is required. Otherwise the current user name is used.</p> <p>&lt;username&gt;      User name to login on the remote server.</p>
port	<p>SSH server port. If port is specified, the SSH client connects to the remote SSH server with the specified TCP port. Otherwise, the client port configured by "ssh client" command or the default TCP port (22) is used.</p> <p>&lt;1-65535&gt;      TCP port.</p>
version	<p>SSH client version. If version is specified, the SSH client supports only the specified SSH version. By default, SSH client uses SSHv2 first. If the server does not support SSHv2, it will try SSHv1. The default version can be configured by "ssh client" command.</p> <p>1                      Use SSH version 1.</p> <p>2                      Use SSH version 2.</p>
<remote-device>	IPv4/IPv6 address or hostname of a remote server. The address is in the format A.B.C.D for an IPv4 address, or in the format X:X::X:X for an IPv6 address. Note that a hostname specified with SSH cannot begin with a hyphen (-) character.
<command>	A command to execute on the remote server. If a command is specified, the command is executed on the remote SSH server and the session is disconnected when the remote command finishes.

**Mode** User Exec and Privileged Exec

**Examples** To login to the remote SSH server at 192.0.2.5, use the command:

```
awplus# ssh ip 192.0.2.5
```

To login to the remote SSH server at 192.0.2.5 as user “manager”, use the command:

```
awplus# ssh ip user manager 192.0.2.5
```

To login to the remote SSH server at 192.0.2.5 that is listening on TCP port 2000, use the command:

```
awplus# ssh port 2000 192.0.2.5
```

To login to the remote SSH server with “example\_host” using an IPv6 session, use the command:

```
awplus# ssh ipv6 example_host
```

To run the **cmd** command on the remote SSH server at 192.0.2.5, use the command:

```
awplus# ssh ip 192.0.2.5 cmd
```

**Related commands**

- [crypto key generate userkey](#)
- [crypto key pubkey-chain knownhosts](#)
- [debug ssh client](#)
- [ssh client](#)

**Command changes**

- Version 5.4.6-2.1: VRF-lite support added for AR-Series devices.
- Version 5.4.8-1.2: secure mode syntax added for x220, x930, x550, XS900MX.
- Version 5.4.8-2.1: secure mode syntax added for x950, SBx908 GEN2.

# ssh client

**Overview** This command modifies the default configuration parameters of the Secure Shell (SSH) client. The configuration is used for any SSH client on the device to connect to remote SSH servers. Any parameters specified on SSH client explicitly override the default configuration parameters.

The change affects the current user shell only. When the user exits the login session, the configuration does not persist. This command does not affect existing SSH sessions.

The **no** variant of this command resets configuration parameters of the Secure Shell (SSH) client changed by the `ssh client` command, and restores the defaults.

This command does not affect the existing SSH sessions.

**Syntax**

```
ssh client {port <1-65535>|version {1|2}|session-timeout <0-3600>|connect-timeout <1-600>}
no ssh client {port|version|session-timeout|connect-timeout}
```

Parameter	Description
port	The default TCP port of the remote SSH server. If an SSH client specifies an explicit port of the server, it overrides the default TCP port. Default: 22
	<1-65535> TCP port number.
version	The SSH version used by the client for SSH sessions. The SSH client supports both version 2 and version 1 Default: version 2 Note: SSH version 2 is the default SSH version. SSH client supports SSH version 1 if SSH version 2 is not configured using a ssh version command.
	1 SSH clients on the device supports SSH version 1 only.
	2 SSH clients on the device supports SSH version 2 only
session-timeout	The global session timeout for SSH sessions. If the session timer lapses since the last time an SSH client received data from the remote server, the session is terminated. If the value is 0, then the client does not terminate the session. Instead, the connection is terminated when it reaches the TCP timeout. Default: 0 (session timer remains off)
	<0-3600> Timeout in seconds.

Parameter	Description
connect-timeout	The maximum time period that an SSH session can take to become established. The SSH client terminates the SSH session if this timeout expires and the session is still not established. Default: 30
	<1-600> Timeout in seconds.

**Mode** Privileged Exec

**Examples** To configure the default TCP port for SSH clients to 2200, and the session timer to 10 minutes, use the command:

```
awplus# ssh client port 2200 session-timeout 600
```

To configure the connect timeout of SSH client to 10 seconds, use the command:

```
awplus# ssh client connect-timeout 10
```

To restore the connect timeout to its default, use the command:

```
awplus# no ssh client connect-timeout
```

**Related commands** [show ssh client](#)  
[ssh](#)

# ssh server

**Overview** Use this command to modify the configuration of the SSH server. Changing these parameters affects new SSH sessions connecting to the device.

Use the **no** variant of this command to restore the configuration of a specified parameter to its default. The change affects the SSH server immediately if the server is running. Otherwise, the configuration is used when the server starts.

To enable the SSH server, use the [service ssh](#) command.

**Syntax**

```
ssh server {[v1v2|v2only]|<1-65535>}
ssh server {[session-timeout <0-3600>] [login-timeout <1-600>]
[max-startups <1-128>]}
no ssh server {[session-timeout] [login-timeout]
[max-startups]}
```

Parameter	Description
v1v2	Supports both SSHv2 and SSHv1 client connections. Default: v1v2
v2only	Supports SSHv2 client connections only.
<1-65535>	The TCP port number that the server listens to for incoming SSH sessions. Default: 22
session-timeout	The maximum time period that the server waits before deciding that a session is inactive and should be terminated. The server considers the session inactive when it has not received any data from the client, and when the client does not respond to keep alive messages. Default: 0 (session timer remains off).
	<0-3600> Timeout in seconds.
login-timeout	The maximum time period the server waits before disconnecting an unauthenticated client. Default: 60
	<1-600> Timeout in seconds.
max-startups	The maximum number of concurrent unauthenticated connections the server accepts. When the number of SSH connections awaiting authentication reaches the limit, the server drops any additional connections until authentication succeeds or the login timer expires for a connection. Default: 10
	<1-128> Number of sessions.

**Mode** Global Configuration

**Examples** To configure the session timer of SSH server to 10 minutes (600 seconds), use the commands:

```
awplus# configure terminal
awplus(config)# ssh server login-timeout 600
```

To configure the login timeout of SSH server to 30 seconds, use the commands:

```
awplus# configure terminal
awplus(config)# ssh server login-timeout 30
```

To limit the number of SSH client connections waiting for authentication from SSH server to 3, use the commands:

```
awplus# configure terminal
awplus(config)# ssh server max-startups 3
```

To set max-startups parameters of SSH server to the default configuration, use the commands:

```
awplus# configure terminal
awplus(config)# no ssh server max-startups
```

To support the Secure Shell server with TCP port 2200, use the commands:

```
awplus# configure terminal
awplus(config)# ssh server 2200
```

To force the Secure Shell server to support SSHv2 only, use the commands:

```
awplus# configure terminal
awplus(config)# ssh server v2only
```

To support both SSHv2 and SSHv1, use the commands:

```
awplus# configure terminal
awplus(config)# ssh server v1v2
```

**Related commands** [show ssh server](#)  
[ssh client](#)



# ssh server allow-users

**Overview** This command adds a username pattern to the allow list of the SSH server. If the user of an incoming SSH session matches the pattern, the session is accepted.

When there are no registered users in the server's database of allowed users, the SSH server does not accept SSH sessions even when enabled.

SSH server also maintains the deny list. The server checks the user in the deny list first. If a user is listed in the deny list, then the user access is denied even if the user is listed in the allow list.

The **no** variant of this command deletes a username pattern from the allow list of the SSH server. To delete an entry from the allow list, the username and hostname pattern should match exactly with the existing entry.

**Syntax** `ssh server allow-users <username-pattern> [<hostname-pattern>]`  
`no ssh server allow-users <username-pattern>`  
`[<hostname-pattern>]`

Parameter	Description
<code>&lt;username-pattern&gt;</code>	The username pattern that users can match to. An asterisk acts as a wildcard character that matches any string of characters.
<code>&lt;hostname-pattern&gt;</code>	The host name pattern that hosts can match to. If specified, the server allows the user to connect only from hosts matching the pattern. An asterisk acts as a wildcard character that matches any string of characters.

**Mode** Global Configuration

**Examples** To allow the user `john` to create an SSH session from any host, use the commands:

```
awplus# configure terminal
awplus(config)# ssh server allow-users john
```

To allow the user `john` to create an SSH session from a range of IP address (from 192.168.1.1 to 192.168.1.255), use the commands:

```
awplus# configure terminal
awplus(config)# ssh server allow-users john 192.168.1.*
```

To allow the user `john` to create a SSH session from a `a-company.com` domain, use the commands:

```
awplus# configure terminal
awplus(config)# ssh server allow-users john *.a-company.com
```

To delete the existing user entry `john 192.168.1.*` in the allow list, use the commands:

```
awplus# configure terminal
```

```
awplus(config)# no ssh server allow-users john 192.168.1.*
```

**Related commands**

- [show running-config ssh](#)
- [show ssh server allow-users](#)
- [ssh server deny-users](#)

# ssh server authentication

**Overview** This command enables RSA public-key or password user authentication for SSH Server. Apply the **password** keyword with the **ssh server authentication** command to enable password authentication for users. Apply the **publickey** keyword with the **ssh server authentication** command to enable RSA public-key authentication for users.

Use the **no** variant of this command to disable RSA public-key or password user authentication for SSH Server. Apply the **password** keyword with the **no ssh authentication** command to disable password authentication for users. Apply the required **publickey** keyword with the **no ssh authentication** command to disable RSA public-key authentication for users.

**Syntax** `ssh server authentication {password|publickey}`  
`no ssh server authentication {password|publickey}`

Parameter	Description
password	Specifies user password authentication for SSH server.
publickey	Specifies user publickey authentication for SSH server.

**Default** Both RSA public-key authentication and password authentication are enabled by default.

**Mode** Global Configuration

**Usage** For password authentication to authenticate a user, password authentication for a user must be registered in the local user database or on an external RADIUS server, before using the **ssh server authentication password** command.

For RSA public-key authentication to authenticate a user, a public key must be added for the user, before using the **ssh server authentication publickey** command.

**Examples** To enable `password` authentication for users connecting through SSH, use the commands:

```
awplus# configure terminal
awplus(config)# ssh server authentication password
```

To enable `publickey` authentication for users connecting through SSH, use the commands:

```
awplus# configure terminal
awplus(config)# ssh server authentication publickey
```

To disable password authentication for users connecting through SSH, use the commands:

```
awplus# configure terminal
```

```
awplus(config)# no ssh server authentication password
```

To disable publickey authentication for users connecting through SSH, use the commands:

```
awplus# configure terminal
```

```
awplus(config)# no ssh server authentication publickey
```

**Related  
commands**

[crypto key pubkey-chain userkey](#)

[service ssh](#)

[show ssh server](#)

# ssh server deny-users

**Overview** This command adds a username pattern to the deny list of the SSH server. If the user of an incoming SSH session matches the pattern, the session is rejected.

SSH server also maintains the allow list. The server checks the user in the deny list first. If a user is listed in the deny list, then the user access is denied even if the user is listed in the allow list.

If a hostname pattern is specified, the user is denied from the hosts matching the pattern.

The **no** variant of this command deletes a username pattern from the deny list of the SSH server. To delete an entry from the deny list, the username and hostname pattern should match exactly with the existing entry.

**Syntax** `ssh server deny-users <username-pattern> [<hostname-pattern>]`  
`no ssh server deny-users <username-pattern>`  
`[<hostname-pattern>]`

Parameter	Description
<code>&lt;username-pattern&gt;</code>	The username pattern that users can match to. The username must begin with a letter. Valid characters are all numbers, letters, and the underscore, hyphen, full stop and asterisk symbols. An asterisk acts as a wildcard character that matches any string of characters.
<code>&lt;hostname-pattern&gt;</code>	The host name pattern that hosts can match to. If specified, the server denies the user only when they connect from hosts matching the pattern. An asterisk acts as a wildcard character that matches any string of characters.

**Mode** Global Configuration

**Examples** To deny the user john to access SSH login from any host, use the commands:

```
awplus# configure terminal
awplus(config)# ssh server deny-users john
```

To deny the user john to access SSH login from a range of IP address (from 192.168.2.1 to 192.168.2.255), use the commands:

```
awplus# configure terminal
awplus(config)# ssh server deny-users john 192.168.2.*
```

To deny the user john to access SSH login from b-company.com domain, use the commands:

```
awplus# configure terminal
awplus(config)# ssh server deny-users john*.b-company.com
```

To delete the existing user entry `john 192.168.2.*` in the deny list, use the commands:

```
awplus# configure terminal
```

```
awplus(config)# no ssh server deny-users john 192.168.2.*
```

**Related commands**

- [show running-config ssh](#)
- [show ssh server deny-users](#)
- [ssh server allow-users](#)

# ssh server max-auth-tries

**Overview** Use this command to specify the maximum number of SSH authentication attempts that the device will allow.

Use the **no** variant of this command to return the maximum number of attempts to its default value of 6.

**Syntax** `ssh server max-auth-tries <1-32>`  
`no ssh server max-auth-tries`

Parameter	Description
<1-32>	Maximum number of SSH authentication attempts the device will allow.

**Default** 6 attempts

**Mode** Global Configuration

**Usage** By default, users must wait one second after a failed login attempt before trying again. You can increase this gap by using the command [aaa login fail-delay](#).

**Example** To set the maximum number of SSH authentication attempts to 3, use the commands:

```
awplus# configure terminal
awplus(config)# ssh server max-auth-tries 3
```

**Related commands** [show ssh server](#)

# ssh server resolve-host

**Overview** This command enables resolving an IP address from a host name using a DNS server for client host authentication.

The **no** variant of this command disables this feature.

**Syntax** `ssh server resolve-hosts`  
`no ssh server resolve-hosts`

**Default** This feature is disabled by default.

**Mode** Global Configuration

**Usage notes** Your device has a DNS Client that is enabled automatically when you add a DNS server to your device.

**Example** To resolve a host name using a DNS server, use the commands:

```
awplus# configure terminal
awplus(config)# ssh server resolve-hosts
```

**Related commands**

- `ip name-server`
- `show ssh server`
- `ssh server allow-users`
- `ssh server deny-users`



# ssh server scp

**Overview** This command enables the Secure Copy (SCP) service on the SSH server. Once enabled, the server accepts SCP requests from remote clients.

You must enable the SSH server as well as this service before the device accepts SCP connections. The SCP service is enabled by default as soon as the SSH server is enabled.

The **no** variant of this command disables the SCP service on the SSH server. Once disabled, SCP requests from remote clients are rejected.

**Syntax** `ssh server scp`  
`no ssh server scp`

**Mode** Global Configuration

**Examples** To enable the SCP service, use the commands:

```
awplus# configure terminal
awplus(config)# ssh server scp
```

To disable the SCP service, use the commands:

```
awplus# configure terminal
awplus(config)# no ssh server scp
```

**Related commands** [show running-config ssh](#)  
[show ssh server](#)

# ssh server sftp

**Overview** This command enables the Secure FTP (SFTP) service on the SSH server. Once enabled, the server accepts SFTP requests from remote clients.

You must enable the SSH server as well as this service before the device accepts SFTP connections. The SFTP service is enabled by default as soon as the SSH server is enabled. If the SSH server is disabled, SFTP service is unavailable.

The **no** variant of this command disables SFTP service on the SSH server. Once disabled, SFTP requests from remote clients are rejected.

**Syntax** `ssh server sftp`  
`no ssh server sftp`

**Mode** Global Configuration

**Examples** To enable the SFTP service, use the commands:

```
awplus# configure terminal
awplus(config)# ssh server sftp
```

To disable the SFTP service, use the commands:

```
awplus# configure terminal
awplus(config)# no ssh server sftp
```

**Related commands** [show running-config ssh](#)  
[show ssh server](#)

# undebug ssh client

**Overview** This command applies the functionality of the **no debug ssh client** command.

# undebug ssh server

**Overview** This command applies the functionality of the **no debug ssh server** command.

# 48

# Trigger Commands

## Introduction

**Overview** This chapter provides an alphabetical reference for commands used to configure Triggers. For more information, see the [Triggers Feature Overview and Configuration Guide](#).

For information on filtering and saving command output, see the [“Getting Started with AlliedWare Plus” Feature Overview and Configuration Guide](#).

- Command List**
- [“active \(trigger\)”](#) on page 1895
  - [“day”](#) on page 1896
  - [“debug trigger”](#) on page 1898
  - [“description \(trigger\)”](#) on page 1899
  - [“repeat”](#) on page 1900
  - [“script”](#) on page 1901
  - [“show debugging trigger”](#) on page 1903
  - [“show running-config trigger”](#) on page 1904
  - [“show trigger”](#) on page 1905
  - [“test”](#) on page 1910
  - [“time \(trigger\)”](#) on page 1911
  - [“trap”](#) on page 1913
  - [“trigger”](#) on page 1914
  - [“trigger activate”](#) on page 1915
  - [“type atmf node”](#) on page 1916
  - [“type card”](#) on page 1919
  - [“type cpu”](#) on page 1920
  - [“type interface”](#) on page 1921

- [“type linkmon-probe”](#) on page 1922
- [“type log”](#) on page 1924
- [“type memory”](#) on page 1925
- [“type periodic”](#) on page 1926
- [“type ping-poll”](#) on page 1927
- [“type reboot”](#) on page 1928
- [“type time”](#) on page 1929
- [“undebug trigger”](#) on page 1930

# active (trigger)

**Overview** This command enables a trigger. This allows the trigger to activate when its trigger conditions are met.

The **no** variant of this command disables a trigger. While in this state the trigger cannot activate when its trigger conditions are met.

**Syntax** active  
no active

**Default** Active, which means that triggers are enabled by default

**Mode** Trigger Configuration

**Usage notes** Configure a trigger first before you use this command to activate it.

For information about configuring a trigger, see the [Triggers\\_Feature Overview and Configuration Guide](#).

**Examples** To enable trigger 172, so that it can activate when its trigger conditions are met, use the commands:

```
awplus# configure terminal
awplus(config)# trigger 172
awplus(config-trigger)# active
```

To disable trigger 182, preventing it from activating when its trigger conditions are met, use the commands:

```
awplus# configure terminal
awplus(config)# trigger 182
awplus(config-trigger)# no active
```

**Related commands** [show trigger](#)  
[trigger](#)  
[trigger activate](#)

# day

**Overview** This command specifies the days or date that the trigger can activate on. You can specify one of:

- A specific date
- A specific day of the week
- A list of days of the week
- A day of any month of any year
- A day of a specific month in any year
- Every day

By default, the trigger can activate on any day.

**Syntax** `day every-day`  
`day <1-31>`  
`day <1-31> <month>`  
`day <1-31> <month> <year>`  
`day <weekday>`

Parameter	Description
<code>every-day</code>	Sets the trigger so that it can activate on any day.
<code>&lt;1-31&gt;</code>	Day of the month the trigger is permitted to activate on.
<code>&lt;month&gt;</code>	Sets the month that the trigger is permitted to activate on. Valid keywords are: <b>january, february, march, april, may, june, july, august, september, october, november, and december.</b>
<code>&lt;year&gt;</code>	Sets the year that the trigger is permitted to activate in, between 2000 and 2035.
<code>&lt;weekday&gt;</code>	Sets the days of the week that the trigger can activate on. You can specify one or more week days in a space separated list. Valid keywords are: <b>monday, tuesday, wednesday, thursday, friday, saturday, and sunday.</b>

**Default** **every-day**, so by default, the trigger can activate on any day.

**Mode** Trigger Configuration

**Usage notes** For example trigger configurations that use the **day** command, see “Restrict Internet Access” and “Turn off Power to Port LEDs” in the [Triggers Feature Overview and Configuration Guide](#).



**Examples** To permit trigger 55 to activate on the 1 June 2019, use the commands:

```
awplus# configure terminal
awplus(config)# trigger 55
awplus(config-trigger)# day 1 jun 2019
```

To permit trigger 12 to activate on Mondays, Wednesdays and Fridays, use the commands:

```
awplus# configure terminal
awplus(config)# trigger 12
awplus(config-trigger)# day monday wednesday friday
```

To permit trigger 17 to activate on the 5th day of any month, in any year, use the commands:

```
awplus# configure terminal
awplus(config)# trigger 17
awplus(config-trigger)# day 5
```

To permit trigger 6 to activate on the 20th day of September, in any year, use the commands:

```
awplus# configure terminal
awplus(config)# trigger 6
awplus(config-trigger)# day 20 september
```

To permit trigger 14 to activate on the 1st day of each month, in any year, at 11.00am, use the commands:

```
awplus# configure terminal
awplus(config)# trigger 14
awplus(config-trigger)# day 1
awplus(config-trigger)# type time 11:00
```

**Related commands** [show trigger](#)  
[type time](#)  
[trigger](#)

**Command changes** Version 5.4.8-2.1: day of the month functionality added

# debug trigger

**Overview** This command enables trigger debugging. This generates detailed messages about how your device is processing the trigger commands and activating the triggers.

The **no** variant of this command disables trigger debugging.

**Syntax** debug trigger  
no debug trigger

**Mode** Privilege Exec

**Examples** To start trigger debugging, use the command:

```
awplus# debug trigger
```

To stop trigger debugging, use the command:

```
awplus# no trigger
```

**Related commands** [show debugging trigger](#)  
[show trigger](#)  
[test](#)  
[trigger](#)  
[undebug trigger](#)

# description (trigger)

**Overview** This command adds an optional description to help you identify the trigger. This description is displayed in show command outputs and log messages.

The **no** variant of this command removes a trigger's description. The show command outputs and log messages stop displaying a description for this trigger.

**Syntax** `description <description>`  
`no description`

Parameter	Description
<code>&lt;description&gt;</code>	A word or phrase that uniquely identifies this trigger or its purpose. Valid characters are any printable character and spaces, up to a maximum of 40 characters.

**Mode** Trigger Configuration

**Examples** To give trigger 240 the description `daily status report`, use the commands:

```
awplus# configure terminal
awplus(config)# trigger 240
awplus(config-trigger)# description daily status report
```

To remove the description from trigger 36, use the commands:

```
awplus# configure terminal
awplus(config)# trigger 36
awplus(config-trigger)# no description
```

**Related commands** [show trigger](#)  
[test](#)  
[trigger](#)

# repeat

**Overview** This command specifies the number of times that a trigger is permitted to activate. This allows you to specify whether you want the trigger to activate:

- only the first time that the trigger conditions are met
- a limited number of times that the trigger conditions are met
- an unlimited number of times

Once the trigger has reached the limit set with this command, the trigger remains in your configuration but cannot be activated. Use the **repeat** command again to reset the trigger so that it is activated when its trigger conditions are met.

By default, triggers can activate an unlimited number of times. To reset a trigger to this default, specify either **yes** or **forever**.

**Syntax** `repeat { forever | no | once | yes | <1-4294967294> }`

Parameter	Description
yes   forever	The trigger repeats indefinitely, or until disabled.
no   once	The trigger activates only once.
<1-4292967294>	The trigger repeats the specified number of times.

**Mode** Trigger Configuration

**Examples** To allow trigger 21 to activate only once, use the commands:

```
awplus# configure terminal
awplus(config)# trigger 21
awplus(config-trigger)# repeat no
```

To allow trigger 22 to activate an unlimited number of times whenever its trigger conditions are met, use the commands:

```
awplus# configure terminal
awplus(config)# trigger 22
awplus(config-trigger)# repeat forever
```

To allow trigger 23 to activate only the first 10 times the conditions are met, use the commands:

```
awplus# configure terminal
awplus(config)# trigger 23
awplus(config-trigger)# repeat 10
```

**Related commands** [show trigger](#)  
[trigger](#)

# script

**Overview** This command specifies one or more scripts that are to be run when the trigger activates. You can add up to five scripts to a single trigger.

The sequence in which the trigger runs the scripts is specified by the number you set before the name of the script file. One script is executed completely before the next script begins.

Scripts may be either ASH shell scripts, indicated by a **.sh** filename extension suffix, or AlliedWare Plus™ scripts, indicated by a **.scp** filename extension suffix. AlliedWare Plus™ scripts only need to be readable.

The **no** variant of this command removes one or more scripts from the trigger's script list. The scripts are identified by either their name, or by specifying their position in the script list. The **all** parameter removes all scripts from the trigger.

**Syntax** `script <1-5> {<filename>}`  
`no script {<1-5>|<filename>|all}`

Parameter	Description
<1-5>	The position of the script in execution sequence. The trigger runs the lowest numbered script first.
<filename>	The path to the script file.

**Mode** Trigger Configuration

**Examples** To configure trigger 71 to run the script `flash:/cpu_trig.sh` in position 3 when the trigger activates, use the commands:

```
awplus# configure terminal
awplus(config)# trigger 71
awplus(config-trigger)# script 3 flash:/cpu_trig.sh
```

To configure trigger 99 to run the scripts **flash:reconfig.scp**, **flash:cpu\_trig.sh** and **flash:email.scp** in positions 2, 3 and 5 when the trigger activates, use the following commands:

```
awplus# configure terminal
awplus(config)# trigger 99
awplus(config-trigger)# script 2 flash:/reconfig.scp 3
flash:/cpu_trig.sh 5 flash:/email.scp
```

To remove the scripts 1, 3 and 4 from trigger 71's script list, use the commands:

```
awplus# configure terminal
awplus(config)# trigger 71
awplus(config-trigger)# no script 1 3 4
```

To remove the script flash:/cpu\_trig.sh from trigger 71's script list, use the commands:

```
awplus# configure terminal
awplus(config)# trigger 71
awplus(config-trigger)# no script flash:/cpu_trig.sh
```

To remove all the scripts from trigger 71's script list, use the commands:

```
awplus# configure terminal
awplus(config)# trigger 71
awplus(config-trigger)# no script all
```

**Related commands** [show trigger](#)  
[trigger](#)

# show debugging trigger

**Overview** This command displays the current status for trigger utility debugging. Use this command to show when trigger debugging has been turned on or off from the [debug trigger](#) command.

**Syntax** `show debugging trigger`

**Mode** User Exec and Privileged Exec

**Example** To display the current configuration of trigger debugging, use the command:  
`awplus# show debugging trigger`

**Output** Figure 48-1: Example output from the **show debugging trigger** command

```
awplus#debug trigger
awplus#show debugging trigger
Trigger debugging status:
  Trigger debugging is on

awplus#no debug trigger
awplus#show debugging trigger
Trigger debugging status:
  Trigger debugging is off
```

**Related commands** [debug trigger](#)

# show running-config trigger

**Overview** This command displays the current running configuration of the trigger utility.

**Syntax** `show running-config trigger`

**Mode** Privileged Exec

**Example** To display the current configuration of the trigger utility, use the command:

```
awplus# show running-config trigger
```

**Output** Figure 48-2: Example output from the **show running-config trigger** command

```
trigger 1
  type card in
trigger 2
  type card out
!
```

**Related commands** [show trigger](#)



# show trigger

**Overview** This command displays configuration and diagnostic information about the triggers configured on the device. Specify the **show trigger** command without any options to display a summary of the configuration of all triggers.

**Syntax** `show trigger [<1-250>|counter|full]`

Parameter	Description
<1-250>	Displays detailed information about a specific trigger, identified by its trigger ID.
counter	Displays statistical information about all triggers.
full	Displays detailed information about all triggers.

**Mode** Privileged Exec

**Example** To get summary information about all triggers, use the following command:

```
awplus# show trigger
```

Table 48-1: Example output from **show trigger**

```
awplus#show trigger
TR# Type & Details      Name                Ac Te Repeat      #Scr Days/Date
-----
001 CPU (80% any)      Busy CPU             Y  N  5              1 smtwtfS
005 Periodic (30 min)  Regular status check Y  N  Continuous     1 -mtwtf-
007 Memory (85% up)   High mem usage       Y  N  8              1 smtwtfS
011 Time (00:01)      Weekend access       Y  N  Continuous     1 -----s
013 Reboot             Y  N  Continuous     2 smtwtfS
017 Interface (vlan1 .. Change config for... Y  N  Once           1 2-apr-2008
019 Ping-poll (5 up)   Connection to svr1   Y  N  Continuous     1 smtwtfS
-----
```

Table 48-2: Parameters in the output of **show trigger**

Parameter	Description
TR#	Trigger identifier (ID).
Type & Details	The trigger type, followed by the trigger details in brackets.
Name	Descriptive name of the trigger configured with the <a href="#">description (trigger)</a> command.
Ac	Whether the trigger is active (Y), or inactive (N).

Table 48-2: Parameters in the output of **show trigger** (cont.)

Parameter	Description
Te	Whether the trigger is in test mode (Y) or not (N).
Repeat	Whether the trigger repeats continuously, and if not, the configured repeat count for the trigger. To see the number of times a trigger has activated, use the <b>show trigger</b> <1-250> command.
#Scr	Number of scripts associated with the trigger.
Days/Date	Days or date when the trigger may be activated. For the days options, the days are shown as a seven character string representing Sunday to Saturday. A hyphen indicates days when the trigger cannot be activated.

To display detailed information about trigger 3, use the command:

```
awplus# show trigger 3
```

Figure 48-3: Example output from **show trigger** for a specific trigger

```
awplus#show trigger 1
Trigger Configuration Details
-----
Trigger ..... 1
Name ..... display cpu usage when pass 80%
Type and details ..... CPU (80% up)
Days ..... smtwfss
Active ..... Yes
Test ..... No
Trap ..... Yes
Repeat ..... Continuous
Modified ..... Fri Feb 3 17:18:44 2017
Number of activations ..... 0
Last activation ..... not activated
Number of scripts ..... 1
1. shocpu.scp
2.
3.
4.
5.
-----
```

To display detailed information about all triggers, use the command:

```
awplus# show trigger full
```

Table 48-3: Example output from **show trigger full**

```
awplus#show trigger full
Trigger Configuration Details
-----
Trigger ..... 1
Name ..... Busy CPU
Type and details ..... CPU (80% up)
Days ..... smtwtfS
Active ..... Yes
Test ..... No
Trap ..... Yes
Repeat ..... Continuous
Modified ..... Fri Feb 3 17:05:16 2017
Number of activations ..... 0
Last activation ..... not activated
Number of scripts ..... 2
  1. flash:/cpu_alert.sh
  2. flash:/reconfig.scp
  3.
  4.
  5.
Trigger ..... 5
Name ..... Regular status check
Type and details ..... Periodic (30 min)
Days ..... smtwtfS
Active ..... Yes
Test ..... No
Trap ..... Yes
Repeat ..... 5 (2)
Modified ..... Fri Feb 3 17:18:44 2017
Number of activations ..... 0
Last activation ..... Fri Feb 10 18:00:00 2017
Number of scripts ..... 1
  1. flash:/stat_check.scp
  2.
  3.
  4.
  5.
-----
```

Table 49: Parameters in the output of **show trigger full** and **show trigger** for a specific trigger

Parameter	Description
Trigger	The ID of the trigger.
Name	Descriptive name of the trigger.
Type and details	The trigger type and its activation conditions.
Days	The days on which the trigger is permitted to activate.

**Table 49:** Parameters in the output of **show trigger full** and **show trigger** for a specific trigger (cont.)

Parameter	Description
Date	The date on which the trigger is permitted to activate. Only displayed if configured, in which case it replaces "Days".
Active	Whether or not the trigger is permitted to activate.
Test	Whether or not the trigger is operating in diagnostic mode.
Trap	Whether or not the trigger is enabled to send SNMP traps.
Repeat	Whether the trigger repeats an unlimited number of times (Continuous) or for a set number of times. When the trigger can repeat only a set number of times, then the number of times the trigger has been activated is displayed in brackets.
Modified	The date and time of the last time that the trigger was modified.
Number of activations	Number of times the trigger has been activated since the last restart of the device.
Last activation	The date and time of the last time that the trigger was activated.
Number of scripts	How many scripts are associated with the trigger, followed by the names of the script files in the order in which they run.

To display counter information about all triggers use the command:

```
awplus# show trigger counter
```

**Figure 48-4:** Example output from **show trigger counter**

```
awplus# show trigger counter
Trigger Module Counters
-----
Trigger activations                4
Last trigger activated             55
Time triggers activated today      0
Periodic triggers activated today  0
Interface triggers activated today  1
CPU triggers activated today       2
Memory triggers activated today    1
Reboot triggers activated today    0
Ping-poll triggers activated today  0
USB event triggers activated today  0
Stack master fail triggers activated today  0
Stack member triggers activated today  0
Stack link triggers activated today  0
ATMF node triggers activated today  0
Log triggers activated today       0
-----
```

**Related  
commands** [active \(trigger\)](#)  
[debug trigger](#)  
[script](#)  
[trigger](#)  
[trigger activate](#)

# test

**Overview** This command puts the trigger into a diagnostic mode. In this mode the trigger may activate but when it does it will not run any of the trigger's scripts. A log message will be generated to indicate when the trigger has been activated.

The **no** variant of this command takes the trigger out of diagnostic mode, restoring normal operation. When the trigger activates the scripts associated with the trigger will be run, as normal.

**Syntax** test  
no test

**Mode** Trigger Configuration

**Usage notes** Configure a trigger first before you use this command to diagnose it. For information about configuring a trigger, see the [Triggers\\_Feature Overview and Configuration Guide](#).

**Examples** To put trigger 5 into diagnostic mode, where no scripts will be run when the trigger activates, use the commands:

```
awplus# configure terminal
awplus(config)# trigger 5
awplus(config-trigger)# test
```

To take trigger 205 out of diagnostic mode, restoring normal operation, use the commands:

```
awplus# configure terminal
awplus(config)# trigger 205
awplus(config-trigger)# no test
```

**Related commands** [show trigger](#)  
[trigger](#)

# time (trigger)

**Overview** This command specifies the time of day when the trigger is permitted to activate. The **after** parameter specifies the start of a time period that extends to midnight during which trigger may activate. By default the value of this parameter is 00:00:00 (am); that is, the trigger may activate at any time. The **before** parameter specifies the end of a time period beginning at midnight during which the trigger may activate. By default the value of this parameter is 23:59:59; that is, the trigger may activate at any time. If the value specified for **before** is later than the value specified for **after**, a time period from “after” to “before” is defined, during which the trigger may activate. This command is not applicable to time triggers (**type time**).

The following figure illustrates how the **before** and **after** parameters operate.

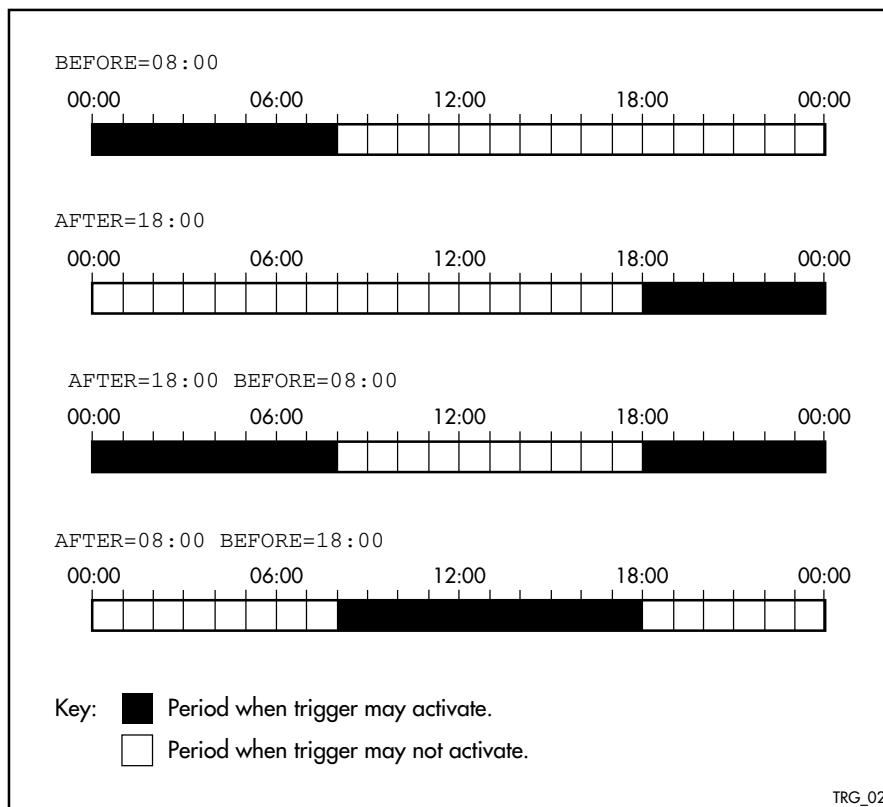

**Syntax** `time { [after <hh:mm:ss> ] [before <hh:mm:ss> ] }`

Parameter	Description
<code>after&lt;hh:mm:ss&gt;</code>	The earliest time of day when the trigger may be activated.
<code>before&lt;hh:mm:ss&gt;</code>	The latest time of day when the trigger may be activated.

**Mode** Trigger Configuration

**Usage notes** For example trigger configurations that use the **time (trigger)** command, see “Restrict Internet Access” and “Turn off Power to Port LEDs” in the [Triggers Feature Overview and Configuration Guide](#).

**Examples** To allow trigger 63 to activate between midnight and 10:30am, use the commands:

```
awplus# configure terminal
awplus(config)# trigger 63
awplus(config-trigger)# time before 10:30:00
```

To allow trigger 64 to activate between 3:45pm and midnight, use the commands:

```
awplus# configure terminal
awplus(config)# trigger 64
awplus(config-trigger)# time after 15:45:00
```

To allow trigger 65 to activate between 10:30am and 8:15pm, use the commands:

```
awplus# configure terminal
awplus(config)# trigger 65
awplus(config-trigger)# time after 10:30:00 before 20:15:00
```

**Related commands** [show trigger](#)  
[trigger](#)



# trap

**Overview** This command enables the specified trigger to send SNMP traps.

Use the **no** variant of this command to disable the sending of SNMP traps from the specified trigger.

**Syntax** trap  
no trap

**Default** SNMP traps are enabled by default for all defined triggers.

**Mode** Trigger Configuration

**Usage notes** You must configure SNMP before using traps with triggers. For more information, see:

- [Support for Allied Telesis Enterprise\\_MIBs\\_in\\_AlliedWare Plus](#), for information about which MIB objects are supported.
- the [SNMP Feature Overview and Configuration\\_Guide](#).
- the [SNMP Commands](#) chapter.

Since SNMP traps are enabled by default for all defined triggers, a common usage will be for the **no** variant of this command to disable SNMP traps from a specified trap if the trap is only periodic. Refer in particular to AT-TRIGGER-MIB in the [Support for Allied Telesis Enterprise\\_MIBs\\_in AlliedWare Plus](#) for further information about the relevant SNMP MIB.

**Examples** To enable SNMP traps to be sent from trigger 5, use the commands:

```
awplus# configure terminal
awplus(config)# trigger 5
awplus(config-trigger)# trap
```

To disable SNMP traps being sent from trigger 205, use the commands:

```
awplus# configure terminal
awplus(config)# trigger 205
awplus(config-trigger)# no trap
```

**Related commands** [trigger](#)  
[show trigger](#)

# trigger

**Overview** This command is used to access the Trigger Configuration mode for the specified trigger. Once Trigger Configuration mode has been entered the trigger type information can be configured and the trigger scripts and other operational parameters can be specified. At a minimum the trigger type information must be specified before the trigger can become active.

The **no** variant of this command removes a specified trigger and all configuration associated with it.

**Syntax** `trigger <1-250>`  
`no trigger <1-250>`

Parameter	Description
<1-250>	A trigger ID.

**Mode** Global Configuration

**Examples** To enter trigger configuration mode for trigger 12, use the commands:

```
awplus# configure terminal  
awplus(config)# trigger 12
```

To completely remove all configuration associated with trigger 12, use the commands:

```
awplus# configure terminal  
awplus(config)# no trigger 12
```

**Related commands** [show trigger](#)  
[trigger activate](#)

# trigger activate

**Overview** This command is used to manually activate a specified trigger from the Privileged Exec mode, which has been configured with the **trigger** command from the Global Configuration mode.

**Syntax** `trigger activate <1-250>`

Parameter	Description
<1-250>	A trigger ID.

**Mode** Privileged Exec

**Usage notes** This command manually activates a trigger without the normal trigger conditions being met.

The trigger is activated even if it has been configured as inactive by using the command **no active**. The scripts associated with the trigger will be executed even if the trigger is in the diagnostic test mode.

Triggers activated manually do not have their repeat counts decremented or their 'last triggered' time updated, and do not result in updates to the '[type] triggers today' counters.

**Example** To manually activate trigger 12 use the command:

```
awplus# trigger activate 12
```

**Related commands**

- [active \(trigger\)](#)
- [show trigger](#)
- [trigger](#)

# type atmf node

**Overview** This command configures a trigger to be activated at an AMF node join event or leave event.

**Syntax** `type atmf node {join|leave}`

Parameter	Description
join	AMF node join event.
leave	AMF node leave event.

**Mode** Trigger Configuration

**CAUTION:** *Only configure this trigger on one device because it is a network wide event.*

**Example 1** To configure trigger 5 to activate at an AMF node leave event, use the following commands. In this example the command is entered on node-1:

```
node1(config)# trigger 5
node1(config-trigger) type atmf node leave
```

**Example 2** The following commands will configure trigger 5 to activate if an AMF node join event occurs on any node within the working set:

```
node1# atmf working-set group all
```

This command returns the following display:

```
=====
node1, node2, node3:
=====

Working set join
```

Note that the running the above command changes the prompt from the name of the local node, to the name of the AMF-Network followed, in square brackets, by the number of member nodes in the working set.

```
AMF-Net[3]# conf t
AMF-Net[3](config)# trigger 5
AMF-Net[3](config-trigger)# type atmf node leave
AMF-Net[3](config-trigger)# description "E-mail on AMF Exit"
AMF-Net[3](config-trigger)# active
```

Enter the name of the script to run at the trigger event.

```
AMF-Net[3](config-trigger)# script 1 email_me.scp  
AMF-Net[3](config-trigger)# end
```

Display the trigger configurations

```
AMF-Net[3]# show trigger
```

This command returns the following display:

```
=====  
node1:  
=====
```

TR#	Type & Details	Description	Ac	Te	Tr	Repeat	#Scr	Days/Date
001	Periodic (2 min)	Periodic Status Chk	Y	N	Y	Continuous	1	smtwtfs
005	ATMF node (leave)	E-mail on ATMF Exit	Y	N	Y	Continuous	1	smtwtfs

```
-----  
  
=====  
Node2, Node3,  
=====
```

TR#	Type & Details	Description	Ac	Te	Tr	Repeat	#Scr	Days/Date
005	ATMF node (leave)	E-mail on ATMF Exit	Y	N	Y	Continuous	1	smtwtfs

```
-----
```

Display the triggers configured on each of the nodes in the AMF Network.

```
AMF-Net[3]# show running-config trigger
```

This command returns the following display:

```
=====  
Node1:  
=====  
  
trigger 1  
  type periodic 2  
  script 1 atmf.scp  
trigger 5  
  type atmf node leave  
description "E-mail on ATMF Exit"  
  script 1 email_me.scp  
!  
  
=====  
Node2, Node3:  
=====  
  
trigger 5  
  type atmf node leave  
description "E-mail on ATMF Exit"  
  script 1 email_me.scp  
!
```

**Related commands** [show trigger](#)

# type card

**Overview** Use this command to configure a trigger that activates on either the removal or the insertion of a Secure Digital (SD) or Secure Digital High Capacity (SDHC) card.

**Syntax** `type card {in|out}`

Parameter	Description
in	Trigger activates on insertion of a card.
out	Trigger activates on removal of a card.

**Mode** Trigger Configuration

**Usage notes** Card triggers cannot execute script files from a card.

For example trigger configurations that use the **type card** command, see “Capture Show Output and Save to an SD Card” in the [Triggers Feature Overview and Configuration\\_Guide](#).

**Examples** To configure `trigger 1` to activate on the insertion of a card, use the commands:

```
awplus# configure terminal
awplus(config)# trigger 1
awplus(config-trigger)# type card in
```

**Related commands** [trigger](#)  
[show running-config trigger](#)  
[show trigger](#)

# type cpu

**Overview** This command configures a trigger to activate based on CPU usage level. Selecting the **up** option causes the trigger to activate when the CPU usage exceeds the specified usage level. Selecting the **down** option causes the trigger to activate when CPU usage drops below the specified usage level. Selecting **any** causes the trigger to activate in both situations. The default is **any**.

**Syntax** `type cpu <1-100> [up|down|any]`

Parameter	Description
<1-100>	The percentage of CPU usage at which to trigger.
up	Activate when CPU usage exceeds the specified level.
down	Activate when CPU usage drops below the specified level
any	Activate when CPU usage passes the specified level in either direction

**Mode** Trigger Configuration

**Usage notes** For an example trigger configuration that uses the **type cpu** command, see “Capture Unusual CPU and RAM Activity” in the [Triggers Feature Overview and Configuration Guide](#).

**Examples** To configure trigger 28 to be a CPU trigger that activates when CPU usage exceeds 80% use the following commands:

```
awplus# configure terminal
awplus(config)# trigger 28
awplus(config-trigger)# type cpu 80 up
```

To configure trigger 5 to be a CPU trigger that activates when CPU usage either rises above or drops below 65%, use the following commands:

```
awplus# configure terminal
awplus(config)# trigger 5
awplus(config-trigger)# type cpu 65

or

awplus# configure terminal
awplus(config)# trigger 5
awplus(config-trigger)# type cpu 65 any
```

**Related commands** [show trigger](#)  
[trigger](#)



# type interface

**Overview** This command configures a trigger to activate based on the link status of an interface. The trigger can be activated when the interface becomes operational by using the **up** option, or when the interface closes by using the **down** option. The trigger can also be configured to activate when either one of these events occurs by using the **any** option.

**Syntax** `type interface <interface> [up|down|any]`

Parameter	Description
<interface>	Interface name. This can be the name of a device port, an eth-management port, or a VLAN.
up	Activate when interface becomes operational.
down	Activate when the interface closes.
any	Activate when any interface link status event occurs.

**Mode** Trigger Configuration

**Example** To configure trigger 19 to be an interface trigger that activates when port1.0.2 becomes operational, use the following commands:

```
awplus# configure terminal
awplus(config)# trigger 19
awplus(config-trigger)# type interface port1.0.2 up
```

**Related commands** [show trigger](#)  
[trigger](#)

# type linkmon-probe

**Overview** Use this command to create a trigger that will run a script when a Link Health Monitoring probe reports that a link becomes “good”, “bad”, or “unreachable”.

**Syntax** `type linkmon-probe <probename> <profilename>  
{good|bad|unreachable|any}`

Parameter	Description
<code>&lt;probename&gt;</code>	The name of the Link Health Monitoring probe that will be used for executing the trigger.
<code>&lt;profilename&gt;</code>	The name of the Link Health Monitoring performance profile that will be used for determine if the Link Health Monitoring probe is good, bad, or unreachable.
<code>good</code>	If the Link Health Monitoring probe becomes 'good' according to the Link Health Monitoring performance profile then the trigger will be executed.
<code>bad</code>	If the Link Health Monitoring probe goes 'bad' according to the Link Health Monitoring performance profile then the trigger will be executed.
<code>unreachable</code>	If the Link Health Monitoring probe becomes 'unreachable' according to the Link Health Monitoring performance profile then the trigger will be executed.
<code>any</code>	If the Link Health Monitoring probe changes state according to the Link Health Monitoring performance profile then the trigger will be executed.

**Mode** Trigger Configuration

**Example** When the Link Health Monitoring probes sent to the “test-probe” destination no longer meet the performance profile “test-profile” the link will be deemed “bad”. To create a trigger that will run a script when a Link Health Monitoring probe is deemed “bad”, use the following commands:

```
awplus# trigger 1  
awplus(config)# script 1 link-bad.scp  
awplus(config)# type linkmon-probe test-probe test-profile bad
```

To create a trigger that will run a script when the link is deemed “good” again, use the following commands:

```
awplus# trigger 2  
awplus(config)# script 1 link-good.scp  
awplus(config)# type linkmon-probe test-probe test-profile good
```

**Related commands** [trigger](#)

**Command changes** Version 5.4.8-1.1: command added

# type log

**Overview** Use this command to configure a trigger to activate based on the content of log messages matching a string or regular expression.

**Syntax** `type log <log-message-string>`

Parameter	Description
<code>&lt;log-message-string&gt;</code>	A string or a regular expression (PCRE) to match a log message or part of a log message.

**Default** There is no type or log message string set by default.

**Mode** Trigger Configuration

**Usage notes** Log type triggers fully support regular expressions using PCRE (Perl-Compatible Regular Expression) syntax.

Only log messages of severity level notice or higher can activate a trigger.

Note that any command executed by the script will generate a log message with level notice, and will include '[SCRIPT]' before the command string. Therefore, if something in the script matches the configured log message trigger string, it will retrigger indefinitely.

**Example** To configure trigger 6 to activate when a log message of level notice or higher indicates that any port has 'failed', use the commands:

```
awplus# configure terminal
awplus(config)# trigger 6
awplus(config-trigger)# type log port.+ failed
```

**Related commands** [show trigger](#)  
[trigger](#)

**Command changes** Version 5.4.7-2.1: command added

# type memory

**Overview** This command configures a trigger to activate based on RAM usage level. Selecting the **up** option causes the trigger to activate when memory usage exceeds the specified level. Selecting the **down** option causes the trigger to activate when memory usage drops below the specified level. Selecting **any** causes the trigger to activate in both situations. The default is **any**.

**Syntax** `type memory <1-100> [up|down|any]`

Parameter	Description
<1-100>	The percentage of memory usage at which to trigger.
up	Activate when memory usage exceeds the specified level.
down	Activate when memory usage drops below the specified level.
any	Activate when memory usage passes the specified level in either direction.

**Mode** Trigger Configuration

**Examples** To configure trigger 12 to be a memory trigger that activates when memory usage exceeds 50% use the following commands:

```
awplus# configure terminal
awplus(config)# trigger 12
awplus(config-trigger)# type memory 50 up
```

To configure trigger 40 to be a memory trigger that activates when memory usage either rises above or drops below 65%, use the following commands:

```
awplus# configure terminal
awplus(config)# trigger 40
awplus(config-trigger)# type memory 65
```

or

```
awplus# configure terminal
awplus(config)# trigger 40
awplus(config-trigger)# type memory 65 any
```

**Related commands** [show trigger](#)  
[trigger](#)

# type periodic

**Overview** This command configures a trigger to be activated at regular intervals. The time period between activations is specified in minutes.

**Syntax** `type periodic <1-1440>`

Parameter	Description
<code>&lt;1-1440&gt;</code>	The number of minutes between activations.

**Mode** Trigger Configuration

**Usage notes** A combined limit of 10 triggers of the type periodic and time can be configured. If you attempt to add more than 10 triggers the following error message is displayed:

```
% Cannot configure more than 10 triggers with the type time or periodic
```

For an example trigger configuration that uses the **type periodic** command, see "See Daily Statistics" in the [Triggers\\_Feature Overview and Configuration Guide](#).

**Example** To configure trigger 44 to activate periodically at 10 minute intervals use the following commands:

```
awplus# configure terminal
awplus(config)# trigger 44
awplus(config-trigger)# type periodic 10
```

**Related commands** [show trigger](#)  
[trigger](#)

# type ping-poll

**Overview** This command configures a trigger that activates when Ping Polling identifies that a target device's status has changed. This allows you to run a configuration script when a device becomes reachable or unreachable.

**Syntax** `type ping-poll <1-100> {up|down}`

Parameter	Description
<1-100>	The ping poll ID.
up	The trigger activates when ping polling detects that the target is reachable.
down	The trigger activates when ping polling detects that the target is unreachable.

**Mode** Trigger Configuration

**Example** To configure trigger 106 to activate when ping poll 12 detects that its target device is now unreachable, use the following commands:

```
awplus# configure terminal
awplus(config)# trigger 106
awplus(config-trigger)# type ping-poll 12 down
```

**Related commands** [show trigger](#)  
[trigger](#)

# type reboot

**Overview** This command configures a trigger that activates when your device is rebooted.

**Syntax** type reboot

**Mode** Trigger Configuration

**Example** To configure trigger 32 to activate when your device reboots, use the following commands:

```
awplus# configure terminal
awplus(config)# trigger 32
awplus(config-trigger)# type reboot
```

**Related commands** [show trigger](#)  
[trigger](#)



# type time

**Overview** This command configures a trigger that activates at a specified time of day.

**Syntax** `type time <hh:mm>`

Parameter	Description
<code>&lt;hh:mm&gt;</code>	The time to activate the trigger.

**Mode** Trigger Configuration

**Usage** A combined limit of 10 triggers of the type time and type periodic can be configured. If you attempt to add more than 10 triggers the following error message is displayed:

```
% Cannot configure more than 10 triggers with the type time or
periodic
```

**Example** To configure trigger 86 to activate at 15:53, use the following commands:

```
awplus# configure terminal
awplus(config)# trigger 86
awplus(config-trigger)# type time 15:53
```

**Related commands** [show trigger](#)  
[trigger](#)

# undebug trigger

**Overview** This command applies the functionality of the **no debug trigger** command.

# 49

# Ping-Polling Commands

## Introduction

**Overview** This chapter provides an alphabetical reference for commands used to configure Ping Polling. For more information, see the [Ping Polling Feature Overview and Configuration Guide](#).

For information on filtering and saving command output, see the [“Getting Started with AlliedWare Plus” Feature Overview and Configuration Guide](#).

Table 49-1: The following table lists the default values when configuring a ping poll

Default	Value
Critical-interval	1 second
Description	No description
Fail-count	5
Length	32 bytes
Normal-interval	30 seconds
Sample-size	5
Source-ip	The IP address of the interface from which the ping packets are transmitted
Time-out	1 second
Up-count	30

- Command List**
- [“active \(ping-polling\)”](#) on page 1933
  - [“clear ping-poll”](#) on page 1934
  - [“critical-interval”](#) on page 1935
  - [“debug ping-poll”](#) on page 1936

- [“description \(ping-polling\)”](#) on page 1937
- [“fail-count”](#) on page 1938
- [“ip \(ping-polling\)”](#) on page 1939
- [“length \(ping-poll data\)”](#) on page 1940
- [“normal-interval”](#) on page 1941
- [“ping-poll”](#) on page 1942
- [“sample-size”](#) on page 1943
- [“show counter ping-poll”](#) on page 1945
- [“show ping-poll”](#) on page 1947
- [“source-ip”](#) on page 1951
- [“timeout \(ping polling\)”](#) on page 1953
- [“up-count”](#) on page 1954
- [“undebug ping-poll”](#) on page 1955

# active (ping-polling)

**Overview** This command enables a ping-poll instance. The polling instance sends ICMP echo requests to the device with the IP address specified by the [ip \(ping-polling\)](#) command.

By default, polling instances are disabled. When a polling instance is enabled, it assumes that the device it is polling is unreachable.

The **no** variant of this command disables a ping-poll instance. The polling instance no longer sends ICMP echo requests to the polled device. This also resets all counters for this polling instance.

**Syntax** active  
no active

**Mode** Ping-Polling Configuration

**Examples** To activate the ping-poll instance 43, use the commands:

```
awplus# configure terminal
awplus(config)# ping-poll 43
awplus(config-ping-poll)# active
```

To disable the ping-poll instance 43 and reset its counters, use the commands:

```
awplus# configure terminal
awplus(config)# ping-poll 43
awplus(config-ping-poll)# no active
```

**Related commands** [debug ping-poll](#)  
[ip \(ping-polling\)](#)  
[ping-poll](#)  
[show ping-poll](#)

# clear ping-poll

**Overview** This command resets the specified ping poll, or all ping poll instances. This clears the ping counters, and changes the status of polled devices to unreachable. The polling instance changes to the polling frequency specified with the [critical-interval](#) command. The device status changes to reachable once the device responses have reached the [up-count](#).

**Syntax** `clear ping-poll {<1-100>|all}`

Parameter	Description
<1-100>	A ping poll ID number. The specified ping poll instance has its counters cleared, and the status of the device it polls is changed to unreachable.
all	Clears the counters and changes the device status of all polling instances.

**Mode** Privileged Exec

**Examples** To reset the ping poll instance 12, use the command:

```
awplus# clear ping-poll 12
```

To reset all ping poll instances, use the command:

```
awplus# clear ping-poll all
```

**Related commands**

- [active \(ping-polling\)](#)
- [ping-poll](#)
- [show ping-poll](#)

# critical-interval

**Overview** This command specifies the time period in seconds between pings when the polling instance has not received a reply to at least one ping, and when the device is unreachable.

This command enables the device to quickly observe changes in state, and should be set to a much lower value than the [normal-interval](#) command.

The **no** variant of this command sets the critical interval to the default of one second.

**Syntax** `critical-interval <1-65536>`  
`no critical-interval`

Parameter	Description
<1-65536>	Time in seconds between pings, when the device has failed to a ping, or the device is unreachable.

**Default** The default is 1 second.

**Mode** Ping-Polling Configuration

**Examples** To set the critical interval to 2 seconds for the ping-polling instance 99, use the commands:

```
awplus# configure terminal
awplus(config)# ping-poll 99
awplus(config-ping-poll)# critical-interval 2
```

To reset the critical interval to the default of one second for the ping-polling instance 99, use the commands:

```
awplus# configure terminal
awplus(config)# ping-poll 99
awplus(config-ping-poll)# no critical-interval
```

**Related commands**

- [fail-count](#)
- [normal-interval](#)
- [sample-size](#)
- [show ping-poll](#)
- [timeout \(ping polling\)](#)
- [up-count](#)

# debug ping-poll

**Overview** This command enables ping poll debugging for the specified ping-poll instance. This generates detailed messages about ping execution.

The **no** variant of this command disables ping-poll debugging for the specified ping-poll.

**Syntax** `debug ping-poll <1-100>`  
`no debug ping-poll {<1-100>|all}`

Parameter	Description
<1-100>	A unique ping poll ID number.
all	Turn off all ping-poll debugging.

**Mode** Privileged Exec

**Examples** To enable debugging for ping-poll instance 88, use the command:

```
awplus# debug ping-poll 88
```

To disable all ping poll debugging, use the command:

```
awplus# no debug ping-poll all
```

To disable debugging for ping-poll instance 88, use the command:

```
awplus# no debug ping-poll 88
```

**Related commands**

- [active \(ping-polling\)](#)
- [clear ping-poll](#)
- [ping-poll](#)
- [show ping-poll](#)
- [undebug ping-poll](#)



# description (ping-polling)

**Overview** This command specifies a string to describe the ping-polling instance. This allows the ping-polling instance to be recognized easily in show commands. Setting this command is optional.

By default ping-poll instances do not have a description.

Use the **no** variant of this command to delete the description set.

**Syntax** `description <description>`  
`no description`

Parameter	Description
<code>&lt;description&gt;</code>	The description of the target. Valid characters are any printable character and spaces. There is no maximum character length.

**Mode** Ping-Polling Configuration

**Examples** To add the text "Primary Gateway" to describe the ping-poll instance 45, use the commands:

```
awplus# configure terminal
awplus(config)# ping-poll 45
awplus(config-ping-poll)# description Primary Gateway
```

To delete the description set for the ping-poll instance 45, use the commands:

```
awplus# configure terminal
awplus(config)# ping-poll 45
awplus(config-ping-poll)# no description
```

**Related commands** [ping-poll](#)  
[show ping-poll](#)

# fail-count

**Overview** This command specifies the number of pings that must be unanswered, within the total number of pings specified by the [sample-size](#) command, for the ping-polling instance to consider the device unreachable.

If the number set by the [sample-size](#) command and the **fail-count** commands are the same, then the unanswered pings must be consecutive. If the number set by the [sample-size](#) command is greater than the number set by the **fail-count** command, then a device that does not always reply to pings may be declared unreachable.

The **no** variant of this command resets the fail count to the default.

**Syntax** `fail-count <1-100>`  
`no fail-count`

Parameter	Description
<code>&lt;1-100&gt;</code>	The number of pings within the sample size that a reachable device must fail to respond to before it is classified as unreachable.

**Default** The default is 5.

**Mode** Ping-Polling Configuration

**Examples** To specify the number of pings that must fail within the sample size to determine that a device is unreachable for ping-polling instance 45, use the commands:

```
awplus# configure terminal
awplus(config)# ping-poll 45
awplus(config-ping-poll)# fail-count 5
```

To reset the fail-count to its default of 5 for ping-polling instance 45, use the commands:

```
awplus# configure terminal
awplus(config)# ping-poll 45
awplus(config-ping-poll)# no fail-count
```

**Related commands**

- [critical-interval](#)
- [normal-interval](#)
- [ping-poll](#)
- [sample-size](#)
- [show ping-poll](#)
- [timeout \(ping polling\)](#)
- [up-count](#)

# ip (ping-polling)

**Overview** This command specifies the IPv4 address of the device you are polling.

**Syntax** `ip {<ip-address>|<ipv6-address>}`

Parameter	Description
<code>&lt;ip-address&gt;</code>	An IPv4 address in dotted decimal notation A.B.C.D
<code>&lt;ipv6-address&gt;</code>	An IPv6 address in hexadecimal notation X:X::X:X

**Mode** Ping-Polling Configuration

**Examples** To set ping-poll instance 5 to poll the device with the IP address 192.168.0.1, use the commands:

```
awplus# configure terminal
awplus(config)# ping-poll 5
awplus(config-ping-poll)# ip 192.168.0.1
```

To set ping-poll instance 10 to poll the device with the IPv6 address 2001:db8::, use the commands:

```
awplus# configure terminal
awplus(config)# ping-poll 10
awplus(config-ping-poll)# ip 2001:db8::
```

**Related commands**

- [ping-poll](#)
- [source-ip](#)
- [show ping-poll](#)

# length (ping-poll data)

**Overview** This command specifies the number of data bytes to include in the data portion of the ping packet. This allows you to set the ping packets to a larger size if you find that larger packet types in your network are not reaching the polled device, while smaller packets are getting through. This encourages the polling instance to change the device's status to unreachable when the network is dropping packets of the size you are interested in.

The **no** variant of this command resets the data bytes to the default of 32 bytes.

**Syntax** length <4-1500>  
no length

Parameter	Description
<4-1500>	The number of data bytes to include in the data portion of the ping packet.

**Default** The default is 32.

**Mode** Ping-Polling Configuration

**Examples** To specify that ping-poll instance 12 sends ping packet with a data portion of 56 bytes, use the commands:

```
awplus# configure terminal
awplus(config)# ping-poll 12
awplus(config-ping-poll)# length 56
```

To reset the number of data bytes in the ping packet to the default of 32 bytes for ping-poll instance 3, use the commands:

```
awplus# configure terminal
awplus(config)# ping-poll 12
awplus(config-ping-poll)# length
```

**Related commands** ping-poll  
show ping-poll

# normal-interval

**Overview** This command specifies the time period between pings when the device is reachable.

The **no** variant of this command resets the time period to the default of 30 seconds.

**Syntax** `normal-interval <1-65536>`  
`no normal-interval`

Parameter	Description
<code>&lt;1-65536&gt;</code>	Time in seconds between pings when the target is reachable.

**Default** The default is 30 seconds.

**Mode** Ping-Polling Configuration

**Examples** To specify a time period of 60 seconds between pings when the device is reachable for ping-poll instance 45, use the commands:

```
awplus# configure terminal
awplus(config)# ping-poll 45
awplus(config-ping-poll)# normal-interval 60
```

To reset the interval to the default of 30 seconds for ping-poll instance 45, use the commands:

```
awplus# configure terminal
awplus(config)# ping-poll 45
awplus(config-ping-poll)# no normal-interval
```

**Related commands**

- [critical-interval](#)
- [fail-count](#)
- [ping-poll](#)
- [sample-size](#)
- [show ping-poll](#)
- [timeout \(ping polling\)](#)
- [up-count](#)

# ping-poll

**Overview** This command enters the ping-poll configuration mode. If a ping-poll exists with the specified number, then this command enters its configuration mode. If no ping-poll exists with the specified number, then this command creates a new ping-poll with this ID number.

To configure a ping-poll, create a ping-poll using this command, and use the `ip (ping-polling)` command to specify the device you want the polling instance to poll. It is not necessary to specify any further commands unless you want to change a command's default.

The **no** variant of this command deletes the specified ping-poll.

**Syntax** `ping-poll <1-100>`  
`no ping-poll <1-100>`

Parameter	Description
<1-100>	A unique ping-poll ID number.

**Mode** Global Configuration

**Examples** To create ping-poll instance 3 and enter ping-poll configuration mode, use the commands:

```
awplus# configure terminal
awplus(config)# ping-poll 3
awplus(config-ping-poll)#
```

To delete ping-poll instance 3, use the commands:

```
awplus# configure terminal
awplus(config)# no ping-poll 3
```

**Related commands**

- [active \(ping-polling\)](#)
- [clear ping-poll](#)
- [debug ping-poll](#)
- [description \(ping-polling\)](#)
- [ip \(ping-polling\)](#)
- [length \(ping-poll data\)](#)
- [show ping-poll](#)
- [source-ip](#)

# sample-size

**Overview** This command sets the total number of pings that the polling instance inspects when determining whether a device is unreachable. If the number of pings specified by the **fail-count** command go unanswered within the inspected sample, then the device is declared unreachable.

If the numbers set in this command and **fail-count** command are the same, the unanswered pings must be consecutive. If the number set by this command is greater than that set with the **fail-count** command, a device that does not always reply to pings may be declared unreachable.

You cannot set this command's value lower than the **fail-count** value.

The polling instance uses the number of pings specified by the **up-count** command to determine when a device is reachable.

The **no** variant of this command resets this command to the default.

**Syntax** `sample-size <1-100>`  
`no sample size`

Parameter	Description
<1-100>	Number of pings that determines critical and up counts.

**Default** The default is 5.

**Mode** Ping-Polling Configuration

**Examples** To set the sample-size to 50 for ping-poll instance 43, use the commands:

```
awplus# configure terminal
awplus(config)# ping-poll 43
awplus(config-ping-poll)# sample-size 50
```

To reset sample-size to the default of 5 for ping-poll instance 43, use the commands:

```
awplus# configure terminal
awplus(config)# ping-poll 43
awplus(config-ping-poll)# no sample-size
```

**Related  
commands**

- critical-interval
- fail-count
- normal-interval
- ping-poll
- show ping-poll
- timeout (ping polling)
- up-count



# show counter ping-poll

**Overview** This command displays the counters for ping polling.

**Syntax** show counter ping-poll [<1-100>]

Parameter	Description
<1-100>	A unique ping poll ID number. This displays the counters for the specified ping poll only. If you do not specify a ping poll, then this command displays counters for all ping polls.

**Mode** User Exec and Privileged Exec

**Output** Figure 49-1: Example output from the **show counter ping-poll** command

```
Ping-polling counters
Ping-poll: 1
PingsSent          ..... 15
PingsFailedUpState ..... 0
PingsFailedDownState ..... 0
ErrorSendingPing   ..... 2
CurrentUpCount     ..... 13
CurrentFailCount   ..... 0
UpStateEntered     ..... 0
DownStateEntered   ..... 0

Ping-poll: 2
PingsSent          ..... 15
PingsFailedUpState ..... 0
PingsFailedDownState ..... 0
ErrorSendingPing   ..... 2
CurrentUpCount     ..... 13
CurrentFailCount   ..... 0
UpStateEntered     ..... 0
DownStateEntered   ..... 0

Ping-poll: 5
PingsSent          ..... 13
PingsFailedUpState ..... 0
PingsFailedDownState ..... 2
ErrorSendingPing   ..... 2
CurrentUpCount     ..... 9
CurrentFailCount   ..... 0
UpStateEntered     ..... 0
DownStateEntered   ..... 0
```

**Table 50:** Parameters in output of the **show counter ping-poll** command

Parameter	Description
Ping-poll	The ID number of the polling instance.
PingsSent	The total number of pings generated by the polling instance.
PingsFailedUpState	The number of unanswered pings while the target device is in the Up state. This is a cumulative counter for multiple occurrences of the Up state.
PingsFailedDownState	Number of unanswered pings while the target device is in the Down state. This is a cumulative counter for multiple occurrences of the Down state.
ErrorSendingPing	The number of pings that were not successfully sent to the target device. This error can occur when your device does not have a route to the destination.
CurrentUpCount	The current number of sequential ping replies.
CurrentFailCount	The number of ping requests that have not received a ping reply in the current sample-size window.
UpStateEntered	Number of times the target device has entered the Up state.
DownStateEntered	Number of times the target device has entered the Down state.

**Example** To display counters for the polling instances, use the command:

```
awplus# show counter ping-poll
```

**Related commands**

- [debug ping-poll](#)
- [ping-poll](#)
- [show ping-poll](#)

# show ping-poll

**Overview** This command displays the settings and status of ping polls.

**Syntax** `show ping-poll [<1-100>|state {up|down}] [brief]`

Parameter	Description	
<1-100>	Displays settings and status for the specified polling instance.	
state	Displays polling instances based on whether the device they are polling is currently reachable or unreachable.	
	up	Displays polling instance where the device state is reachable.
	down	Displays polling instances where the device state is unreachable.
brief	Displays a summary of the state of ping polls, and the devices they are polling.	

**Mode** User Exec and Privileged Exec

**Output** Figure 49-2: Example output from the **show ping-poll brief** command

```
Ping Poll Configuration
-----
Id Enabled State Destination
-----
1 Yes Down 192.168.0.1
2 Yes Up 192.168.0.100
```

**Table 51:** Parameters in output of the **show ping-poll brief** command

Parameter	Meaning
Id	The ID number of the polling instance, set when creating the polling instance with the <code>ping-poll</code> command.
Enabled	Whether the polling instance is enabled or disabled.

**Table 51:** Parameters in output of the **show ping-poll brief** command (cont.)

Parameter	Meaning
State	The current status of the device being polled:
Up	The device is reachable.
Down	The device is unreachable.
Critical Up	The device is reachable but recently the polling instance has not received some ping replies, so the polled device may be going down.
Critical Down	The device is unreachable but the polling instance received a reply to the last ping packet, so the polled device may be coming back up.
Destination	The IP address of the polled device, set with the <code>ip (ping-polling)</code> command.

**Figure 49-3:** Example output from the **show ping-poll** command

```

Ping Poll Configuration
-----

Poll 1:
Description                : Primary Gateway
Destination IP address     : 192.168.0.1
Status                     : Down
Enabled                    : Yes
Source IP address         : 192.168.0.10
Critical interval         : 1
Normal interval           : 30
Fail count                 : 10
Up count                  : 5
Sample size               : 50
Length                    : 32
Timeout                   : 1
Debugging                 : Enabled
  
```

```

Poll 2:
Description                : Secondary Gateway
Destination IP address    : 192.168.0.100
Status                    : Up
Enabled                   : Yes
Source IP address        : Default
Critical interval         : 5
Normal interval           : 60
Fail count                : 20
Up count                  : 30
Sample size               : 100
Length                    : 56
Timeout                   : 2
Debugging                 : Enabled
    
```

**Table 52:** Parameters in output of the **show ping-poll** command

Parameter	Description	
Description	Optional description set for the polling instance with the <a href="#">description (ping-polling)</a> command.	
Destination IP address	The IP address of the polled device, set with the <a href="#">ip (ping-polling)</a> command.	
Status	The current status of the device being polled:	
	Up	The device is reachable.
	Down	The device is unreachable.
	Critical Up	The device is reachable but recently the polling instance has not received some ping replies, so the polled device may be going down.
	Critical Down	The device is unreachable but the polling instance received a reply to the last ping packet, so the polled device may be coming back up.
Enabled	Whether the polling instance is enabled or disabled. The <a href="#">active (ping-polling)</a> and <a href="#">active (ping-polling)</a> commands enable and disable a polling instance.	
Source IP address	The source IP address sent in the ping packets. This is set using the <a href="#">source-ip</a> command.	
Critical interval	The time period in seconds between pings when the polling instance has not received a reply to at least one ping, and when the device is unreachable. This is set with the <a href="#">critical-interval</a> command.	
Normal interval	The time period between pings when the device is reachable. This is set with the <a href="#">normal-interval</a> command.	

**Table 52:** Parameters in output of the **show ping-poll** command (cont.)

Parameter	Description
Fail count	The number of pings that must be unanswered, within the total number of pings specified by the <a href="#">sample-size</a> command, for the polling instance to consider the device unreachable. This is set using the <a href="#">fail-count</a> command.
Up count	The number of consecutive pings that the polling instance must receive a reply to before classifying the device reachable again. This is set using the <a href="#">up-count</a> command.
Sample size	The total number of pings that the polling instance inspects when determining whether a device is unreachable. This is set using the <a href="#">sample-size</a> command.
Length	The number of data bytes to include in the data portion of the ping packet. This is set using the <a href="#">length (ping-poll data)</a> command.
Timeout	The time in seconds that the polling instance waits for a response to a ping packet. This is set using the <a href="#">timeout (ping polling)</a> command.
Debugging	Indicates whether ping polling debugging is <b>Enabled</b> or <b>Disabled</b> . This is set using the <a href="#">debug ping-poll</a> command.

**Examples** To display the ping poll settings and the status of all the polls, use the command:

```
awplus# show ping-poll
```

To display a summary of the ping poll settings, use the command:

```
awplus# show ping-poll brief
```

To display the settings for ping poll 6, use the command:

```
awplus# show ping-poll 6
```

To display a summary of the state of ping poll 6, use the command:

```
awplus# show ping-poll 6 brief
```

To display the settings of ping polls that have reachable devices, use the command:

```
awplus# show ping-poll state up
```

To display a summary of ping polls that have unreachable devices, use the command:

```
awplus# show ping-poll state down brief
```

**Related commands** [debug ping-poll](#)  
[ping-poll](#)

# source-ip

**Overview** This command specifies the source IP address to use in ping packets.

By default, the polling instance uses the address of the interface through which it transmits the ping packets. It uses the device's local interface IP address when it is set. Otherwise, the IP address of the interface through which it transmits the ping packets is used.

The **no** variant of this command resets the source IP in the packets to the device's local interface IP address.

**Syntax** `source-ip {<ip-address>|<ipv6-address>}`  
`no source-ip`

Parameter	Description
<code>&lt;ip-address&gt;</code>	An IPv4 address in dotted decimal notation A.B.C.D
<code>&lt;ipv6-address&gt;</code>	An IPv6 address in hexadecimal notation X:X::X:X

**Mode** Ping-Polling Configuration

**Examples** To configure the ping-polling instance 43 to use the source IP address 192.168.0.1 in ping packets, use the commands:

```
awplus# configure terminal
awplus(config)# ping-poll 43
awplus(config-ping-poll)# source-ip 192.168.0.1
```

To configure the ping-polling instance 43 to use the source IPv6 address 2001:db8:: in ping packets, use the commands:

```
awplus# configure terminal
awplus(config)# ping-poll 43
awplus(config-ping-poll)# source-ip 2001:db8::
```

To reset the source IP address to the device's local interface IP address for ping-poll instance 43, use the commands:

```
awplus# configure terminal
awplus(config)# ping-poll 43
awplus(config-ping-poll)# no source-ip
```

**Related commands** [description \(ping-polling\)](#)  
[ip \(ping-polling\)](#)  
[length \(ping-poll data\)](#)  
[ping-poll](#)  
[show ping-poll](#)



# timeout (ping polling)

**Overview** This command specifies the time in seconds that the polling instance waits for a response to a ping packet. You may find a higher time-out useful in networks where ping packets have a low priority.

The **no** variant of this command resets the set time out to the default of one second.

**Syntax** `timeout <1-30>`  
`no timeout`

Parameter	Description
<1-30>	Length of time, in seconds, that the polling instance waits for a response from the polled device.

**Default** The default is 1 second.

**Mode** Ping-Polling Configuration

**Examples** To specify the timeout as 5 seconds for ping-poll instance 43, use the commands:

```
awplus# configure terminal
awplus(config)# ping-poll 43
awplus(config-ping-poll)# timeout 5
```

To reset the timeout to its default of 1 second for ping-poll instance 43, use the commands:

```
awplus# configure terminal
awplus(config)# ping-poll 43
awplus(config-ping-poll)# no timeout
```

**Related commands**

- [critical-interval](#)
- [fail-count](#)
- [normal-interval](#)
- [ping-poll](#)
- [sample-size](#)
- [show ping-poll](#)
- [up-count](#)

# up-count

**Overview** This command sets the number of consecutive pings that the polling instance must receive a reply to before classifying the device reachable again.

The **no** variant of this command resets the up count to the default of 30.

**Syntax** `up-count <1-100>`  
`no up-count`

Parameter	Description
<code>&lt;1-100&gt;</code>	Number of replied pings before an unreachable device is classified as reachable.

**Default** The default is 30.

**Mode** Ping-Polling Configuration

**Examples** To set the upcount to 5 consecutive pings for ping-polling instance 45, use the commands:

```
awplus# configure terminal
awplus(config)# ping-poll 45
awplus(config-ping-poll)# up-count 5
```

To reset the upcount to the default value of 30 consecutive pings for ping-polling instance 45, use the commands:

```
awplus# configure terminal
awplus(config)# ping-poll 45
awplus(config-ping-poll)# no up-count
```

**Related commands**

- [critical-interval](#)
- [fail-count](#)
- [normal-interval](#)
- [ping-poll](#)
- [sample-size](#)
- [show ping-poll](#)
- [timeout \(ping polling\)](#)

# undebbug ping-poll

**Overview** This command applies the functionality of the no `debug ping-poll` command.

# 50

# sFlow Commands

## Introduction

**Overview** This chapter provides an alphabetical reference for sFlow commands.

- Command List**
- “[debug sflow](#)” on page 1957
  - “[debug sflow agent](#)” on page 1958
  - “[sflow agent](#)” on page 1959
  - “[sflow collector](#)” on page 1961
  - “[sflow collector max-datagram-size](#)” on page 1963
  - “[sflow enable](#)” on page 1964
  - “[sflow max-header-size](#)” on page 1965
  - “[sflow polling-interval](#)” on page 1967
  - “[sflow sampling-rate](#)” on page 1968
  - “[show debugging sflow](#)” on page 1969
  - “[show running-config sflow](#)” on page 1971
  - “[show sflow](#)” on page 1972
  - “[show sflow interface](#)” on page 1974
  - “[undebug sflow](#)” on page 1975

# debug sflow

**Overview** This command enables sFlow® debug message logging, for sFlow sampling and polling activity on the specified ports. If no ports are specified, sampling and/or polling debug messages are enabled for all ports.

The **no** variant of this command disables sFlow sampling and or polling debug message logging on the ports selected. If no ports are specified, sampling and/or polling debug messages are disabled on all ports.

**Syntax** `debug sflow [interface <port-list>] [sampling][polling]`  
`no debug sflow [interface <port-list>] [sampling][polling]`

Parameter	Description
interface	Interface information.
<port-list>	The ports for which sFlow debug is to be enabled. The ports to display information about. The port list can be: <ul style="list-style-type: none"><li>• a switch port (e.g. port1.0.12)</li><li>• a continuous range of ports separated by a hyphen, e.g. port1.0.1-1.0.24</li><li>• a comma-separated list of ports and port ranges, e.g. port1.0.1,port1.0.1-1.0.24.</li></ul>
sampling	Debug sFlow sampling for the specified port(s).
polling	Debug sFlow polling for the specified port(s).

**Default** The sFlow sampling and or polling debug is disabled.

**Mode** Privileged Exec

**Examples** To enable sFlow debug message logging for polling and sampling on port1.0.1 and port1.0.7, use the commands:

```
awplus# debug sflow interface port1.0.1,port1.0.7 sampling  
polling
```

To enable logging and polling of sFlow debug messages for polling and sampling on all ports, use the command:

```
awplus# debug sflow sampling polling
```

**Related commands** [show debugging sflow](#)  
[no debug all](#)

# debug sflow agent

**Overview** This command enables sFlow® debug message logging that is not specific to particular ports. For example, sending an sFlow datagram to the collector.

The **no** variant of this command applies the command default.

**Syntax** debug sflow agent  
no debug sflow agent

**Default** The sFlow agent debug message logging (that is not port specific) is disabled.

**Mode** Privileged Exec

**Example** To enable logging of sFlow agent debug messages, use the following command:

```
awplus# debug sflow agent
```

**Related commands** show debugging sflow  
debug sflow

# sflow agent

**Overview** This command sets the sFlow® agent IP address on the switch. This address is inserted into every sFlow datagram sent from the sFlow agent switch to the sFlow collector device. The sFlow collector can then use this address to uniquely identify and to access the switch, such as for SNMP. We therefore recommend that you change this address as little as possible.

Although the agent address can be set to any valid IPv4 or IPv6 address; we recommended that you set the sFlow® agent IP address to be the **local address** that is configured on the switch. For information on local addresses and how to set them up, see the [interface \(to configure\)](#) command. This ensures that the sFlow collector can maintain connectivity to the switch irrespective of the addition or deletion of VLAN interfaces (each of which will have its own specific IP address). Note that sFlow is rendered inactive whenever the agent address is not set.

The **no** variant of this command applies its default setting to remove a configured address.

**Syntax** `sflow agent {ip <ip-address>|ipv6 <ipv6-address>}`  
`no sflow agent {ip|ipv6}`

Parameter	Description
<code>&lt;ip-address&gt;</code>	The IPv4 address of the switch that is acting as the sFlow agent.
<code>&lt;ipv6-address&gt;</code>	The IPv6 address of the switch that is acting as the sFlow agent. The IPv6 address uses the format X:X::X:X.

**Default** The sFlow agent address is unset.

**Mode** Global Configuration

**Examples** To set the sFlow agent (IPv4) address to 192.0.2.23, use the command:

```
awplus# configure terminal
awplus(config)# sflow agent ip 192.0.2.23
```

To remove the sFlow agent (IPv4) address, use the command:

```
awplus# configure terminal
awplus(config)# no sflow agent ip
```

To set the sFlow agent (IPv6) address to 2001:0db8::1, use the command:

```
awplus# configure terminal
awplus(config)# sflow agent ipv6 2001:0db8::1
```

To remove the sFlow agent (IPv6) address, use the command:

```
awplus# configure terminal
awplus(config)# no sflow agent ipv6
```

**Related commands** `show running-config sflow`  
`show sflow`



# sflow collector

**Overview** This command sets the sFlow® agent's collector IP address and/or UDP port. This is the destination IP address and UDP port, for sFlow datagrams sent from the sFlow agent. The IP address can be any valid IPv4 or IPv6 address. Note that sFlow is rendered inactive whenever the collector address is set to 0.0.0.0 (for IPv4) or :: (for IPv6).

The **no** variant of this command returns the IP address and UDP port values to their defaults, which will result in sFlow being deactivated.

**Syntax** `sflow collector {[ip <ip-address>|ipv6 <ipv6-address>]}[[port <1-65535>]]`  
`no sflow collector {[ip|ipv6]}[[port]]`

Parameter	Description
<ip-address>	IPv4 address of the remote sFlow collector.
<ipv6-address>	IPv6 address of remote sFlow collector. The IPv6 address uses the format X:X::X:X.
port	Destination UDP port for sFlow datagrams sent to the collector.
<1-65535>	UDP port number (default: 6343).

**Default** The collector address is 0 . 0 . 0 . 0 (which renders sFlow inactive), and the UDP port is 6343.

**Mode** Global Configuration

**Examples** To set the sFlow collector address to 1920 . 2 . 25 and UDP port to 9000, use the command:

```
awplus# configure terminal
awplus(config)# sflow collector ip 192.0.2.25 port 9000
```

To remove the sFlow collector IPv4 address and leave the UDP port unchanged, use the command:

```
awplus# configure terminal
awplus(config)# no sflow collector ip
```

To remove the sFlow collector IPv4 address and to remove the UDP port, use the command:

```
awplus# configure terminal
awplus(config)# no sflow collector ip port
```

To set the sFlow collector address to 2001:0db8::1 and leave the UDP port unchanged, use the command:

```
awplus# configure terminal
awplus(config)# sflow collector ipv6 2001:0db8::1
```

To remove the sFlow collector IPv6 address and leave the UDP port unchanged, use the command:

```
awplus# configure terminal
awplus(config)# no sflow collector ipv6
```

To remove the sFlow collector IPv6 address and to remove the UDP port, use the command:

```
awplus# configure terminal
awplus(config)# no sflow collector ipv6 port
```

**Related commands** [show running-config sflow](#)  
[show sflow](#)

# sflow collector max-datagram-size

**Overview** This command sets the maximum size of the sFlow® datagrams sent to the collector.

The **no** variant of this command resets the maximum-datagram-size to the default.

**Syntax** `sflow collector max-datagram-size <200-1500>`  
`no sflow collector max-datagram-size`

Parameter	Description
<code>&lt;200-1500&gt;</code>	The maximum number of bytes that can be sent in an sFlow datagram sent from the agent to the collector.

**Default** 1400 bytes

**Mode** Global Configuration

**Example** To set the maximum datagram size to 1200, use the command:

```
awplus# configure terminal
awplus(config)# sflow collector max-datagram-size 1200
```

**Related commands** [show running-config sflow](#)  
[show sflow](#)

# sflow enable

**Overview** This command enables sFlow® globally on the switch.

The **no** variant of this command disables sFlow globally on the switch.

Note that enabling sFlow does not automatically set its operational status to active. To activate sFlow the following conditions need to be met:

- sFlow is enabled.
- The sFlow agent address is set.
- The sFlow collector address is set to a valid (non zero) IPv4 or IPv6 address.
- Polling or sampling is enabled on the ports to be sampled or polled.

**Syntax** sflow enable  
no sflow enable

**Default** sFlow is disabled globally on the switch.

**Mode** Global Configuration

**Example** To enable sFlow operation, use the command:

```
awplus# configure terminal  
awplus(config)# sflow enable
```

**Related commands** [show running-config sflow](#)  
[show sflow](#)

# sflow max-header-size

**Overview** This command sets the maximum header size of the Ethernet frames sampled on a specified port. The maximum header size is measured in bytes, referenced from the first byte of the Ethernet destination address and excludes the Ethernet FCS fields.

If a sampled Ethernet frame is longer than the maximum header size set by this command, then the frame will be truncated to the first N bytes before being placed in the sFlow datagram, where N is the maximum header size set by this command.

The **no** variant of this command resets the max-header-size to its default.

**Syntax** `sflow max-header-size <14-200>`  
`no sflow max-header-size`

Parameter	Description
<14-200>	The maximum number of header bytes to be sampled.

**Default** The max-header-size is 128 bytes.

**Mode** Interface Configuration

**Usage notes** The header size is measured from the first byte of the Ethernet frame MAC Destination Address.

- For an environment using standard TCP IPv4 over Ethernet frames, consider the following basic protocol structure:

Ethernet header (including the 4 byte 802.1Q header component) = 18 bytes

IPv4 header = 24 bytes

TCP header = 24 bytes

Total = 66 bytes

**CAUTION:** For IPv4, any data existing between 66 bytes and the value set by this command will be included in the sFlow packet samples. For example, with the default of 128 applied, up to 128-66=62 bytes of user data could be included in the sFlow datagram samples sent between the Agent and the Collector.

For more information, see the [sFlow Feature Overview and Configuration Guide](#).

- A similar consideration can be made for an environment using TCP IPv6 over Ethernet:

Ethernet header (including the 4 byte 802.1Q header component) = 18 bytes

IPv6 header = 40 bytes

TCP header = 24 bytes

Total = 82 bytes

**CAUTION:** For IPv6, any data existing between 82 bytes and the value set by this command will be included in the sFlow packet samples. For example, with the default of 128 applied, up to  $128-82=46$  bytes of user data could be included in the sFlow datagram samples sent between the Agent and the Collector.

Note that the agent-to-collector datagrams contain their own UDP headers, which are outside this calculation.

**Example** To set the maximum header size to 160 bytes for ports 1.0.1 and 1.0.7, use the commands:

```
awplus# configure terminal
awplus(config)# interface port1.0.1,port1.0.7
awplus(config-if)# sflow max-header-size 160
```

**Related commands**

- [show running-config sflow](#)
- [show sflow interface](#)
- [sflow max-header-size](#)

# sflow polling-interval

**Overview** This command sets the sFlow® counter polling interval (in seconds) for the specified ports. A value of 0 disables polling. A counter sample is taken every N seconds where N is the value set by this command.

The **no** variant of this command applies the default.

**Syntax** `sflow polling-interval {0|<1-16777215>}`  
`no sflow polling-interval`

Parameter	Description
0	Disable polling (the default).
<1-16777215>	The polling interval in seconds.

**Default** The polling-interval is 0 (polling disabled).

**Mode** Interface Configuration

**Example** To set the polling interval to 60 seconds for ports 1.0.1 and 1.0.7, use the following commands:

```
awplus# configure terminal
awplus(config)# interface port1.0.1,port1.0.7
awplus(config-if)# sflow polling-interval 60
```

**Related commands** [show running-config sflow](#)  
[show sflow interface](#)

# sflow sampling-rate

**Overview** This command sets the mean sFlow® sampling rate for the specified ports. Sampling occurs every N frames (on average), where N is the rate value set via this command. The sampling rate applies to ingress and egress frames independently. For example, a value of 1000 will sample one frame in every 1000 frames received, i.e. one in every 1000 frames sent from the specified port. A value of 0 disables sampling on the specified port(s).

The **no** variant of this command applies the default.

**Syntax** `sflow sampling-rate <256-16777215>`  
`no sflow sampling-rate`

Parameter	Description
<256-16777215>	The sampling rate N, measured in Ethernet frames.

**Default** The sampling-rate is 0 (sampling disabled).

**Mode** Interface Configuration

**Example** To set the sampling rate to 500 for port1.0.1 and port1.0.3, use the commands:

```
awplus# configure terminal
awplus(config)# interface port1.0.1,port1.0.3
awplus(config-if)# sflow sampling-rate 500
```

**Related commands** [show running-config sflow](#)  
[show sflow interface](#)



# show debugging sflow

**Overview** This command displays sFlow® debug settings for agent operation, and for sampling and polling on specific interface ports. If no interface ports are specified, sampling and polling will be applied to all ports.

**Syntax** `show debugging sflow [interface <port-list>]`

Parameter	Description
<code>interface</code>	The interface information.
<code>&lt;port-list&gt;</code>	The ports for which the sFlow debug settings are to be shown. The ports to display information about. The port list can be: <ul style="list-style-type: none"><li>• a switch port (e.g. <code>port1.0.6</code>)</li><li>• a continuous range of ports separated by a hyphen, e.g. <code>port1.0.1-1.0.6</code></li><li>• a comma-separated list of ports and port ranges, e.g. <code>port1.0.1,port1.0.3-1.0.6</code>.</li></ul>

**Mode** User Exec and Privileged Exec

**Example** To display sFlow debug settings on the agent, and for sampling and polling on ports 1.0.1 to 1.0.9, use the command:

```
awplus# show debugging sflow interface port1.0.1-1.0.9
```

**Output** Figure 50-1: Sample obtained for an sFlow agent

```
awplus# show debugging sflow interface port1.0.1-1.0.9
```

Port	Sampling Debug	Polling Debug
1.0.1	Enabled	Enabled
1.0.2	Enabled	-
1.0.3	-	-
1.0.4	-	-
1.0.5	-	-
1.0.6	-	Enabled
1.0.7	-	-
1.0.8	-	Enabled
1.0.9	-	Enabled

To display sFlow debug settings for all ports, use the command:

```
awplus# show debugging sflow
```

**Related commands** [show running-config sflow](#)  
[show sflow interface](#)

# show running-config sflow

**Overview** This command displays the running system information specific to the sFlow feature.

**Syntax** show running-config sflow

**Mode** Privileged Exec and Global Configuration

**Example** To display the sFlow running configuration information, use the command:

```
awplus# show running-config sflow
```

**Output** Figure 50-2: Example output from the **show running-config sflow** command

```
awplus#sh run sflow
!
sflow agent ip 192.0.2.33
sflow collector ip 192.0.2.65
sflow collector max-datagram-size 1200
sflow enable
!
interface port1.0.11-port1.0.22
 sflow sampling-rate 512
```

**Related commands** [show running-config](#)

# show sflow

**Overview** This command displays non-port-specific sFlow agent configuration and operational status.

**Syntax** show sflow

**Mode** Privileged Exec

**Example** To display sFlow configuration and operational status, use the command:

```
awplus# show sflow
```

## Output

**Table 1:** Example output from the **show sflow** command

sFlow Agent Configuration:	Default Values
sFlow Admin Status . . . . . Disabled	[Disabled]
sFlow Agent Address . . . . . [not set]	[not set]
Collector Address . . . . . 0.0.0.0	[0.0.0.0]
Collector UDP Port . . . . . 6343	[6343]
Tx Max Datagram Size . . . . . 1200	[1400]
sFlow Agent Status:	
Polling/sampling/Tx . . . . . Inactive because:	
- sFlow is disabled	
- Agent Addr is not set	
- Collector Addr is 0.0.0.0	
- Polling & sampling disabled on all ports	

**Table 2:** Parameters in the output of the **show sflow** command

Output Parameter	Description
sFlow Admin Status	Whether sFlow agent operation is administratively enabled.
sFlow Agent Address	The sFlow agent IPv4 or IPv6 address for the device. sFlow is rendered inactive whenever the agent address is not set.
Collector Address	The IPv4 or IPv6 collector address to which sFlow datagrams are sent. sFlow is rendered inactive whenever the collector address is set to 0.0.0.0 or 0:0::0.0.
Collector UDP Port	The UDP port on the collector to which sFlow datagrams are sent.

**Table 2:** Parameters in the output of the **show sflow** command (cont.)

Output Parameter	Description
Tx Max Datagram Size	The maximum size of the sFlow datagrams sent to the collector.
Polling/sampling/Tx	Whether sFlow sampling and/or polling (and hence sFlow datagram transmission) are active. If inactive the reasons are listed.

**Related commands** [show running-config sflow](#)  
[show sflow interface](#)

# show sflow interface

**Overview** This command displays sFlow agent sampling and polling configuration for specified ports.

**Syntax** `show sflow interface <ifrange>`

Parameter	Description
<ifrange>	The interface range.

**Mode** Privileged Exec

# undebug sflow

**Overview** This command applies the functionality of the **no** variant of the [debug sflow](#) command.