



AT-8216FXL/MT

AT-8216FXL/VF

AT-8216FXL/SC

AT-8224XL

AT-8288XL/MT

AT-8288XL/SC

Fast Ethernet Switches

Quick Install Guide

Copyright © 2000 Allied Telesyn International, Corp.
960 Stewart Drive Suite B, Sunnyvale CA 94086, USA

All rights reserved. No part of this publication may be reproduced without prior written permission from Allied Telesyn International, Corp.

Ethernet is a registered trademark of Xerox Corporation. All other product names, company names, logos or other designations mentioned herein are trademarks or registered trademarks of their respective owners.

Allied Telesyn International, Corp. reserves the right to make changes in specifications and other information contained in this document without prior written notice. The information provided herein is subject to change without notice. In no event shall Allied Telesyn International, Corp. be liable for any incidental, special, indirect, or consequential damages whatsoever, including but not limited to lost profits, arising out of or related to this manual or the information contained herein, even if Allied Telesyn International, Corp. has been advised of, known, or should have known, the possibility of such damages.

Electrical Safety and Emission Compliance Statement

Standards: This product meets the following standards.

U.S. Federal Communications Commission

RADIATED ENERGY

Note: This equipment has been tested and found to comply with the limits for a Class A digital device pursuant to Part 15 of FCC Rules. These limits are designed to provide reasonable protection against harmful interference when the equipment is operated in a commercial environment. This equipment generates, uses, and can radiate radio frequency energy and, if not installed and used in accordance with this instruction manual, may cause harmful interference to radio communications. Operation of this equipment in a residential area is likely to cause harmful interference in which case the user will be required to correct the interference at his own expense.

Note: Modifications or changes not expressly approved of by the manufacturer or the FCC, can void your right to operate this equipment.

Industry Canada

This Class A digital apparatus meets all requirements of the Canadian Interference-Causing Equipment Regulations.

Cet appareil numérique de la classe A respecte toutes les exigences du Règlement sur le matériel brouilleur du Canada.

RFI Emission

EN55022 Class A  1



WARNING: In a domestic environment this product may cause radio interference in which case the user may be required to take adequate measures.  2

Immunity

EN50082-1 1997  3

Electrical Safety

TUV-EN60950, UL1950, CSA 950  4





Laser

EN60825  5

Important: Appendix A contains translated safety statements for installing this equipment. When you see the , go to Appendix A for the translated safety statement in your language.

Wichtig: Anhang A enthält übersetzte Sicherheitshinweise für die Installation dieses Geräts. Wenn Sie  sehen, schlagen Sie in Anhang A den übersetzten Sicherheitshinweis in Ihrer Sprache nach.

Viktigt: Tillæg A indeholder oversatte sikkerhedsadvarsler, der vedrører installation af dette udstyr. Når De ser symbolet , skal De slå op i tillæg A og finde de oversatte sikkerhedsadvarsler i Deres eget sprog.

Belangrijk: Appendix A bevat vertaalde veiligheidsopmerkingen voor het installeren van deze apparatuur. Wanneer u de  ziet, raadpleeg Appendix A voor vertaalde veiligheidsinstructies in uw taal.

Important: L'annexe A contient les instructions de sécurité relatives à l'installation de cet équipement. Lorsque vous voyez le symbole , reportez-vous à l'annexe A pour consulter la traduction de ces instructions dans votre langue.

Tärkeää: Liite A sisältää tämän laitteen asentamiseen liittyvät käännetty turvaohjeet. Kun näet -symbolin, katso käännettyä turvaohjetta liitteestä A.

Importante: L'Appendice A contiene avvisi di sicurezza tradotti per l'installazione di questa apparecchiatura. Il simbolo , indica di consultare l'Appendice A per l'avviso di sicurezza nella propria lingua.

Viktig: Tillegg A inneholder oversatt sikkerhetsinformasjon for installering av dette utstyret. Når du ser , åpner du til Tillegg A for å finne den oversatte sikkerhetsinformasjonen på ønsket språk.

Importante: O Anexo A contém advertências de segurança traduzidas para instalar este equipamento. Quando vir o símbolo , leia a advertência de segurança traduzida no seu idioma no Anexo A.

Importante: El Apéndice A contiene mensajes de seguridad traducidos para la instalación de este equipo. Cuando vea el símbolo , vaya al Apéndice A para ver el mensaje de seguridad traducido a su idioma.

Obs! Bilaga A innehåller översatta säkerhetsmeddelanden avseende installationen av denna utrustning. När du ser , skall du gå till Bilaga A för att läsa det översatta säkerhetsmeddelandet på ditt språk.

Table of Contents

Electrical Safety and Emission Compliance Statement	iii
Welcome to Allied Telesyn	vii
Where to Find Web-based Guides	vii
Document Conventions	viii
Contacting Allied Telesyn	viii
Online Support	viii
Telephone and Fax Support.....	viii
E-mail Support	ix
Returning Products	ix
FTP Server	x
For Sales or Corporate Information	x
Tell Us What You Think	x
AT-8216FXL, AT-8224XL, and AT-8288XL Series	
Fast Ethernet Switches	1
Installing the Switch	2
Verifying the Package Contents	2
Reviewing Safety Guidelines	3
Installing the Switch On a Table.....	4
Installing the Switch in a Rack	6
Setting Up for Local Management	8
Switch LEDs	9
AT-S24 Software Default Setting	10
Warranty Registration	11
Appendix A	
Translated Electrical Safety Emission Information	13
Appendix B	
Technical Support Fax Order	25
Incident Summary	25
Appendix C	
AT-8216FXL, AT-8224XL, and AT-8288XL Quick Install	
Guide Feedback	27

Welcome to Allied Telesyn

This guide contains instructions on how to install AT-8216FXL, AT-8224XL, and AT-8288XL Series Fast Ethernet Switches.

Where to Find Web-based Guides

The Allied Telesyn web site at **www.alliedtelesyn.com** provides you with an easy way to access the most recent documentation and technical information for all of our products. All web-based documents relating to this product and other Allied Telesyn products can be downloaded from the web site in pdf format.

There are several other manuals that you will need in addition to this guide in order to install and manage your new switch. The following manual, which is available from the Allied Telesyn web site, contains complete installation instructions:

- ❑ *AT-8216FXL/MT, AT-8216FXL/VF, AT-8216FXL/SC, AT-8224XL, AT-8288XL/MT, and AT-8288XL/SC Installation Guide*, PN 613-10811-00

You should also download the following manual from the web site for instructions on how to use the AT-S24 management software:

- ❑ *AT-S24 Management Software User's Guide*, PN 613-10809-00

Document Conventions

This guide uses several conventions that you should become familiar with first before you begin to install the product.

Note

A note provides additional information.



Caution

A caution indicates that performing or omitting a specific action may result in equipment damage or loss of data.



Warning

A warning indicates that performing or omitting a specific action may result in bodily injury.

Contacting Allied Telesyn

There are several ways to contact Allied Telesyn technical support: online, telephone, fax and e-mail.

Online Support

You can request technical support online by filling out the Online Technical Support Form at www.alliedtelesyn.com/forms/support.htm.

Telephone and Fax Support

Americas

United States, Canada, Mexico,
Central America, South America
Tel: 1 (800) 428-4835, option 4
Fax: 1 (503) 639-3176

Asia

Singapore, Taiwan, Thailand, Malaysia,
Indonesia, Korea, Philippines, China,
India, Hong Kong
Tel: (+65) 381-5612
Fax: (+65) 383-3830

Germany

Germany, Switzerland, Austria, Eastern
Europe
Tel: (+49) 0130/83-56-66
Fax: (+49) 30-435-900-115

Italy

Italy, Spain, Portugal, Greece, Turkey,
Israel
Tel: (+39) 02-416047
Fax: (+39) 02-419282

Australia

Tel: 1 (800) 000-880
Fax: (+61) 2-9438-4966

Japan

Tel: (+81) 3-3443-5640
Fax: (+81) 3-3443-2443

France

France, Belgium, Luxembourg,
The Netherlands, Middle East, Africa
Tel: (+33) 0-1-60-92-15-25
Fax: (+33) 0-1-69-28-37-49

United Kingdom

United Kingdom, Denmark, Norway,
Sweden, Finland
Tel: (+0044) 1235-442500
Fax: (+44) 1-235-442680

E-mail Support

United States and Canada

TS1@alliedtelesyn.com

Latin America, Mexico, Puerto Rico, Caribbean, and Virgin Islands

latin_america@alliedtelesyn.com

United Kingdom, Sweden, Norway, Denmark, and Finland

support_europe@alliedtelesyn.com

Returning Products

Products for return or repair must first be assigned a Return Materials Authorization (RMA) number. A product sent to Allied Telesyn without a RMA number will be returned to the sender at the sender's expense.

To obtain an RMA number, contact Allied Telesyn's Technical Support at one of the following locations:

North America

2205 Ringwood Ave
San Jose, CA 95131
Tel: 1-800-428-4835, option 4
Fax: 1-503-639-3716

European Customer Support Centre

10/11 Bridgemoor Close
Westmead Industrial Estate
Swindon, Wiltshire SN5 7YT
England
Tel: +44-1793-501401
Fax: +44-1793-431099

**Latin America, the Caribbean,
Virgin Islands**

Tel: international code + 425-481-3852
Fax: international code + 425-483-9458

Mexico and Puerto Rico

Tel: 1-800-424-5012, ext 3852 or
1-800-424-4284, ext 3852
Mexico only: 95-800-424-5012, ext 3852
Fax: international code + 425-489-9191

FTP Server

If you know the name of a specific device driver that you need for an Allied Telesyn device, you can download the driver by connecting directly to our FTP server at **<ftp://gateway.centre.com>**.

At login, enter 'anonymous'. Enter your e-mail address for the password as requested by the server at login.

For Sales or Corporate Information

Allied Telesyn International, Corp.
19800 North Creek Parkway, Suite 200
Bothell, WA 98011
Tel: 1 (425) 487-8880
Fax: 1 (425) 489-9191

Allied Telesyn International, Corp.
960 Stewart Drive, Suite B
Sunnyvale, CA 94086
Tel: 1 (800) 424-4284 (USA and Canada)
Fax: 1 (408) 736-0100

Tell Us What You Think

If you have any comments or suggestions on how we might improve this or other Allied Telesyn documents, please fill out the "AT-8216FXL, AT-8224XL, and AT-8288XL Quick Install Guide Feedback" on page 27 and return the form to us at the address or fax number provided. You can also provide feedback online by filling out the Send Us Feedback Form at **www.alliedtelesyn.com/forms/feedback.htm**.

AT-8216FXL, AT-8224XL, and AT-8288XL Series Fast Ethernet Switches

The AT-8216FXL, AT-8224XL, and AT-8288XL Series Fast Ethernet Switches provide the following features:

- ❑ Ethernet, Fast Ethernet, and Gigabit Ethernet connectivity
- ❑ A small 1.5U high, 19-inch rackmountable enclosure
- ❑ Built-in management functions for extremely flexible operation in a standalone configuration

The switch models are listed in Table 1.

Table 1 AT-8216FXL, AT-8224XL, and AT-8288XL Series Fast Ethernet Switches

Models¹	Number of Ports	Type of Port	Type of Connector	Maximum Distance²
AT-8216FXL/MT	16	100Base-FX	MT-RJ	2 km (1.25 mi)
AT-8216FXL/VF	16	100Base-FX	VF-45	2 km (1.25 mi)
AT-8216FXL/SC	16	100Base-FX	SC	2 km (1.25 mi)
AT-8224XL	24	10/100Base-TX	RJ-45	100 m (328 ft)
AT-8288XL/MT	8	10/100Base-TX	RJ-45	100 m (328 ft)
	8	100Base-FX	MT-RJ	2 km (1.25 mi)
AT-8288XL/SC	8	10/100Base-TX	RJ-45	100 m (328 ft)
	8	100Base-FX	SC	2 km (1.25 mi)

1. All models include two expansion slots.

2. Maximum distance may be less depending on the duplex mode of the end node and the type of fiber optic cabling used with the switch.

Installing the Switch

The following sections explain how to install the Fast Ethernet switch in your network.

Note

For information on site requirements, cabling specifications, and network topologies, refer to the *AT-8216FXL/MT*, *AT-8216FXL/VF*, *AT-8216FXL/SC*, *AT-8224XL*, *AT-8288XL/MT*, and *AT-8288XL/SC Installation Guide*. This guide is available on the Allied Telesyn web site at www.alliedtelesyn/support/prd_libs.htm.

Verifying the Package Contents

Make sure the following components are included in the switch package. If any of these items are missing or damaged, contact your sales representative.

- One AT-8216FXL, AT-8224XL, or AT-8288XL Series Fast Ethernet Switch
- Two mounting brackets
- Six flathead Phillips screws
- Power cord (Americas, EC, Australia, and UK only)
- This quick install guide
- Warranty card

Reviewing Safety Guidelines

Please review the following safety guidelines before you begin to install the Fast Ethernet switch.



Laser

Class 1 laser product. *6*



Laser

Do not stare into the laser beam. *7*



Warning

Electric Shock Hazard: To prevent electric shock, do not remove the cover. There are no user-serviceable parts inside. The unit contains hazardous voltages and should only be opened by a trained and qualified technician. *8*



Warning

Lightning Danger: Do not work on this equipment or cables during periods of lightening activity. *9*



Warning

Power cord is used as a disconnection device: To de-energize equipment, disconnect the power cord. *10*



Warning

Electrical-Type Class 1 Equipment: This equipment must be earthed. The power plug must be connected to a properly wired earth ground socket outlet. An improperly wired socket outlet could place hazardous voltages on accessible metal parts. *11*



Caution

Pluggable Equipment: The socket outlet should be installed near the equipment and should be easily accessible. *12*



Caution

Air vents: The air vents must not be blocked on the unit and must have free access to the room ambient air for cooling. *13*



Caution

Operating Temperature: This product is designed for a maximum ambient temperature of 40°C. *14*



Caution

All Countries: Install this product in accordance with local and National Electric Codes. *15*

Installing the Switch On a Table

The Fast Ethernet switch can be installed in a standard 19-inch rack or on a table or desktop. To install the switch in a rack, go to the section “Installing the Switch in a Rack” on page 6. To install the switch on a table, perform the following steps:

1. Remove all components from the shipping package and store the packaging material in a safe location.
2. Locate a level, secure surface for the switch.
3. If you purchased an expansion module for the switch, install the module by following the instructions included with the module or by referring to the *AT-8216FXL/MT*, *AT-8216FXL/VF*, *AT-8216FXL/SC*, *AT-8224XL*, *AT-8288XL/MT*, and *AT-8288XL/SC Installation Guide*.
4. Apply AC power to the switch by plugging the power cord into the AC power connector on the back panel of the unit (shown in Figure 1) and plugging the other end into a wall outlet.

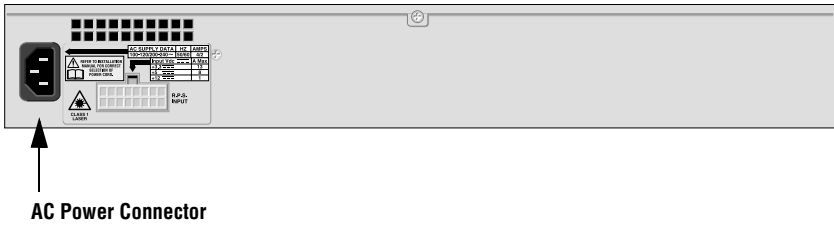

Figure 1 Switch Rear Panel



Warning

The power cord is used as a disconnection device. To de-energize equipment, disconnect the power cord. 10

As power is applied to the switch, the Fault LED (shown in Figure 2) flashes as the switch runs a series of internal self tests. After the switch has finished running its self tests, the Fault LED will stop flashing and will remain off. Refer to the section “Switch LEDs” on page 9 for information on all of the System and Port LEDs.

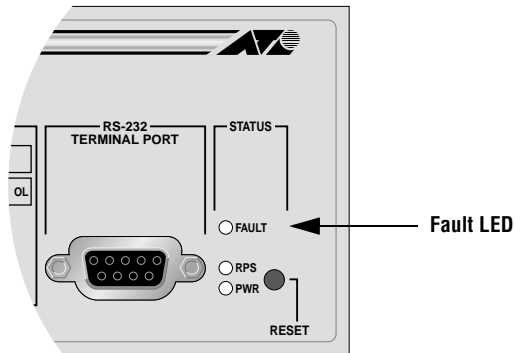

Figure 2 Fault LED

5. Connect the data cables, making sure each connection has a good valid link and that the switch is receiving packets. For 10/100Base-TX ports, use a straight-through cable to connect to workstations and servers, or use a crossover cable to connect to hubs, routers, or other switches.
6. Go to the procedure “Setting Up for Local Management” on page 8 to access the Omega management interface on the switch.

Installing the Switch in a Rack

To install the Ethernet switch in a standard 19-inch rack, perform the following procedure:

1. Remove all components from the shipping package and store the packaging material in a safe location.
2. To prepare the switch, place it on a level, secure surface.
3. If you purchased an expansion module for the switch, install the module by following the instructions included with the module or by referring to the *AT-8216FXL/MT*, *AT-8216FXL/VF*, *AT-8216FXL/SC*, *AT-8224XL*, *AT-8288XL/MT*, and *AT-8288XL/SC Installation Guide*.
4. Remove the snap-on plastic feet from the bottom of the switch, as shown in Figure 3.

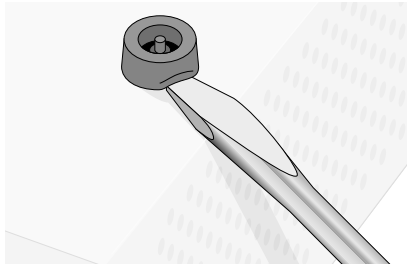

Figure 3 Removing the Feet

5. Attach the rackmounting brackets to each side of the switch, using the six flathead screws that came with the switch package as shown in Figure 4.

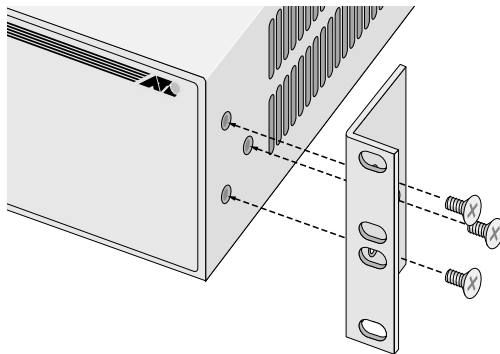

Figure 4 Attaching Rackmounting Brackets

6. Mount the switch in the rack using standard screws (not provided).

**Caution**

Air vents must not be blocked and must have free access to the room ambient air for cooling. *See* 13

7. Apply AC power to the switch by plugging the power cord into the AC power connector on the back panel of the unit (shown in Figure 1) and plugging the other end into a power outlet.

As power is applied to the switch, the Fault LED (shown in Figure 2) flashes as the switch runs a series of internal self tests. Refer to the sections “Switch LEDs” on page 9 for information on the system LEDs.

**Warning**

The power cord is used as a disconnection device. To de-energize equipment, disconnect the power cord. *See* 10

8. Connect the data cables, making sure each connection has a good valid link and that the switch is receiving packets. For 10/100Base-TX ports, use a straight-through cable to connect to workstations and servers, or use a crossover cable to connect to hubs, routers, or other switches.
9. Go to the procedure “Setting Up for Local Management” on page 8 to access the Omega management interface on the switch.

Setting Up for Local Management

If you are installing the switch in a TCP/IP environment or if you intend to manage the switch from a remote site, you must first assign an IP address to the switch using the Omega management software, which comes pre-installed on the switch. To connect a terminal to the switch and start an Omega management session, perform the following steps:

1. Connect a terminal to the RS232 connector on the front panel of the switch. Use an RS232, DB-9 straight-through cable.
2. Access your terminal emulation program, that is, VT100.
3. Set your terminal emulator to the following:
 - Baud rate: **9600**
 - Data bits: **8**
 - Parity: **None**
 - Stop bits: **1**
 - Flow control: **None**
4. Press **Return**.

The switch displays the Omega main menu.

You are now ready to use the Omega management interface to configure the switch. For instructions, refer to the *AT-S24 Management Software User's Guide*. This guide is available on the Allied Telesyn web site at www.alliedtelesyn/support/prd_libs.htm.

Switch LEDs

Table 2 and Table 3 describe the functions of the LEDs on the Ethernet switch.

Table 2 Power and Fault LEDs

LEDs	State	Description
Fault	Solid Red	The switch or management software is malfunctioning.
	Flashing Red	The switch is booting, running diagnostic tests, writing images to FLASH, or transferring files using XMODEM.
	Off	Normal operation.
Power	Solid Green	The switch is receiving power, voltage is within the acceptable range, and the power supply is working.

Table 3 Port LED Status

LEDs	State	Description
L/A (Link/Activity)	Solid Green	This indicates a 100 Mbps link.
	Flashing Green	This indicates 100 Mbps activity
	Solid Amber	This indicates a 10 Mbps link (10/100 ports only).
	Flashing Amber	This indicates 10 Mbps activity (10/100 Mbps ports only).
D/C (Duplex/ Collision)	Solid Green	The port is operating at full-duplex.
	Solid Amber	The port is operating at half-duplex.
	Flashing Amber	Collisions are occurring on the line.

For information on troubleshooting the switch, refer to the *AT-8216FXL/MT*, *AT-8216FXL/VF*, *AT-8216FXL/SC*, *AT-8224XL*, *AT-8288XL/MT*, and *AT-8288XL/SC Installation Guide*.

AT-S24 Software Default Setting

Table 4 lists the default settings for the AT-S24 software that comes pre-installed on the Fast Ethernet switch.

Table 4 Fast Ethernet Switch Default Settings

Settings	Default
IP Address	0.0.0.0
Subnet Mask	0.0.0.0
Gateway Address	0.0.0.0
Get Community String	public
Set Community String	private
Trap Community String	public
Spanning Tree Protocol	Disabled
Bridge Priority	32768
Bridge Max Age Time	20
Bridge Hello Time	2
Bridge Forwarding Delay	15
Telnet Access	Enabled
System Name	None
Omega Password	No password assigned
Omega Time-out Value	5 minutes
Download Password	ATS24
Duplex Mode 10/100Base-TX Ports	Auto-negotiating
Duplex Mode 100Base-FX Ports	Full-duplex
Active Aging Time (MAC Address Table)	300 seconds
High Port Speed	Auto-negotiating
Domain Name	None
VLAN Name	Default VLAN (all ports)
PVID/VID	1

Warranty Registration

When you have finished installing the switch, you should register your product by completing the enclosed warranty card and sending it in, or by visiting our web site at www.alliedtelesyn.com/forms/warranty.htm and completing the on-line registration form.

Appendix A

Translated Electrical Safety Emission Information

Important: This appendix contains multiple-language translations for the safety statements in this guide.

Wichtig: Dieser Anhang enthält Übersetzungen der in diesem Handbuch enthaltenen Sicherheitshinweise in mehreren Sprachen.

Vigtigt: Dette tillæg indeholder oversættelser i flere sprog af sikkerhedsadvarslerne i denne håndbog.

Belangrijk: Deze appendix bevat vertalingen in meerdere talen van de veiligheidsopmerkingen in deze gids.

Important: Cette annexe contient la traduction en plusieurs langues des instructions de sécurité figurant dans ce guide.

Tärkeää: Tämä liite sisältää tässä oppaassa esiintyvät turvaohjeet usealla kielellä.

Importante: questa appendice contiene traduzioni in più lingue degli avvisi di sicurezza di questa guida.

Viktig: Dette tillegget inneholder oversettelser til flere språk av sikkerhetsinformasjonen i denne veiledningen.

Importante: Este anexo contém traduções em vários idiomas das advertências de segurança neste guia.

Importante: Este apéndice contiene traducciones en múltiples idiomas de los mensajes de seguridad incluidos en esta guía.

Obs! Denna bilaga innehåller flerspråkiga översättningar av säkerhetsmeddelandena i denna handledning.

Standards: This product meets the following standards.

U.S. Federal Communications Commission

RADIATED ENERGY









Note: This equipment has been tested and found to comply with the limits for a Class A digital device pursuant to Part 15 of FCC Rules. These limits are designed to provide reasonable protection against harmful interference when the equipment is operated in a commercial environment. This equipment generates, uses, and can radiate radio frequency energy and, if not installed and used in accordance with this instruction manual, may cause harmful interference to radio communications. Operation of this equipment in a residential area is likely to cause harmful interference in which case the user will be required to correct the interference at his own expense.



Note: Modifications or changes not expressly approved of by the manufacturer or the FCC, can void your right to operate this equipment.

Industry Canada













This Class A digital apparatus meets all requirements of the Canadian Interference-Causing Equipment Regulations.

Cet appareil numérique de la classe A respecte toutes les exigences du Règlement sur le matériel brouilleur du Canada.



- ① RFI Emission EN55022 Class A
- ②  **WARNING:** In a domestic environment this product may cause radio interference in which case the user may be required to take adequate measures.
- ③ Immunity EN50082-1 1997
- ④ Electrical Safety EN60950, UL1950, CSA 950
- ⑤  Laser EN60825
- SAFETY**
- ⑥  **WARNING:** Class 1 Laser product.
- ⑦  **WARNING:** Do not stare into the laser beam.
- ⑧  **ELECTRICAL NOTICES**
WARNING: ELECTRIC SHOCK HAZARD
To prevent ELECTRIC shock, do not remove the cover. No user-serviceable parts inside. This unit contains HAZARDOUS VOLTAGES and should only be opened by a trained and qualified technician. To avoid the possibility of ELECTRIC SHOCK, disconnect electric power to the product before connecting or disconnecting the LAN cables.
- ⑨  **LIGHTNING DANGER**
DANGER: DO NOT WORK on equipment or CABLES during periods of LIGHTNING ACTIVITY.
- ⑩  **CAUTION: POWER CORD IS USED AS A DISCONNECTION DEVICE. TO DE-ENERGIZE EQUIPMENT,** disconnect the power cord.
- ⑪  **ELECTRICAL - TYPE CLASS 1 EQUIPMENT**
THIS EQUIPMENT MUST BE EARTHED. Power plug must be connected to a properly wired earth ground socket outlet. An improperly wired socket outlet could place hazardous voltages on accessible metal parts.
- ⑫  **PLUGGABLE EQUIPMENT,** the socket outlet shall be installed near the equipment and shall be easily accessible.

- 13  **CAUTION:** Air vents must not be blocked and must have free access to the room ambient air for cooling.
- 14  **OPERATING TEMPERATURE:** This product is designed for a maximum ambient temperature of 40° degrees C.
- 15  **ALL COUNTRIES:** Install product in accordance with local and National Electrical Codes.











Normen: Dieses Produkt erfüllt die Anforderungen der nachfolgenden Normen.

- 1 Hochfrequenzstörung EN55022 Klasse A
 - 2  **WARNUNG:** Bei Verwendung zu Hause kann dieses Produkt Funkstörungen hervorrufen. In diesem Fall müßte der Anwender angemessene Gegenmaßnahmen ergreifen.
 - 3 Störsicherheit EN50082-1 1997
 - 4 Elektrische Sicherheit EN60950, UL1950, CSA 950
 - 5  Laser EN60825
- SICHERHEIT**
- 6  **WARNUNG** Laserprodukt der Klasse 1.
 - 7  **WARNUNG** Nicht direkt in den Strahl blicken.
 - 8  **ACHTUNG: GEFÄHRLICHE SPANNUNG**
Das Gehäuse nicht öffnen. Das Gerät enthält keine vom Benutzer wartbaren Teile. Das Gerät steht unter Hochspannung und darf nur von qualifiziertem technischem Personal geöffnet werden. Vor Anschluß der LAN-Kabel, Gerät vom Netz trennen.
 - 9  **GEFAHR DURCH BLITZSCHLAG**
GEFAHR: Keine Arbeiten am Gerät oder an den Kabeln während eines Gewitters ausführen.
 - 10  **VORSICHT: DAS NETZKABEL DIENT ZUM TRENNEN DE STROMVERSORGUNG. ZUR TRENNUNG VOM NETZ, KABEL AUS DE STECKDOSE ZIEHEN.**
 - 11  **GERÄTE DER KLASSE 1**
DIESE GERÄTE MÜSSEN GEERDET SEIN. Der Netzstecker darf nur mit einer vorschriftsmäßig geerdeten Steckdose verbunden werden. Ein unvorschriftsmäßiger Anschluß kann die Metallteile des Gehäuses unter gefährliche elektrische Spannungen setzen.
 - 12  **STECKBARES GERÄT:** Die Anschlußbuchse sollte in der Nähe der Einrichtung angebracht werden und leicht zugänglich sein."
 - 13  **VORSICHT**
Die Entlüftungsöffnungen dürfen nicht versperrt sein und müssen zum Kühlen freien Zugang zur Raumluft haben.
 - 14  **BETRIEBSTEMPERATUR:** Dieses Produkt wurde für den Betrieb in einer Umgebungstemperatur von nicht mehr als 40° C entworfen.
 - 15  **ALLE LÄNDER:** Installation muß örtlichen und nationalen elektrischen Vorschriften entsprechen.













Standarder: Dette produkt tilfredsstiller de følgende standarder.

- 1 Radiofrekvens forstyrrelsesemission EN55022 Klasse A
- 2  **ADVARSEL:** I et hjemligt miljø kunne dette produkt forårsage radio forstyrrelse. Bliver det tilfældet, påkræves brugeren muligvis at tage tilstrækkelige foranstaltninger.
- 3 Immunitet EN50082-1 1997
- 4 Elektrisk sikkerhed EN60950, UL1950, CSA 950
- 5  Laser EN60825



SIKKERHED

- 6  **ADVARSEL** Laserprodukt af klasse 1.
- 7  **ADVARSEL** Stirr ikke på strålen.
- 8  **ELEKTRISKE FORHOLDSREGLER**
ADVARSEL: RISIKO FOR ELEKTRISK STØD
For at forebygge ELEKTRISK stød, undlad at åbne apparatet. Der er ingen indre dele, der kan repareres af brugeren. Denne enhed indeholder LIVSFARLIG STRØMSPÆNDINGER og bør kun åbnes af en uddannet og kvalificeret tekniker. For at undgå risiko for ELEKTRISK STØD, afbrydes den elektriske strøm til produktet, før LAN-kablerne monteres eller afmonteres.
- 9  **FARE UNDER UVEJR**
FARE: UNDLAD at arbejde på udstyr eller KABLER i perioder med LYNAKTIVITET.
- 10  **ADVARSEL: DEN STRØMFØRENDE LEDNING BRUGES TIL AT AFBRYDE STRØMMEN. SKAL STRØMMEN TIL APPARATET AFBRYDES,** tages ledningen ud af stikket.
- 11  **ELEKTRISK - KLASSE 1-UDSTYR**
DETTE UDSTYR KRÆVER JORDFORBINDELSE. Stikket skal være forbundet med en korrekt installeret jordforbunden stikkontakt. En ukorrekt installeret stikkontakt kan sætte livsfarlig spænding til tilgængelige metaldele.
- 12  **UDSTYR TIL STIKKONTAKT,** stikkontakten bør installeres nær ved udstyret og skal være lettilgængelig.
- 13  **ADVARSEL:** Ventilationsåbninger må ikke blokeres og skal have fri adgang til den omgivende luft i rummet for afkøling.
- 14  **BETJENINGSTEMPERATUR:** Dette apparat er konstrueret til en omgivende temperatur på maksimum 40 grader C.
- 15  **ALLE LANDE:** Installation af produktet skal ske i overensstemmelse med lokal og national lovgivning for elektriske installationer.











Eisen: Dit product voldoet aan de volgende eisen.

- | | | |
|----|---|--------------------------|
| 1 | RFI Emissie | EN55022 Klasse A |
| 2 |  WAARSCHUWING: Binnenshuis kan dit product radiostoring veroorzaken, in welk geval de gebruiker verplicht kan worden om gepaste maatregelen te nemen. | |
| 3 | Immunititeit | EN50082-1 1997 |
| 4 | Electrische Veiligheid | EN60950, UL1950, CSA 950 |
| 5 |  Laser | |
| | VEILIGHEID | |
| 6 |  WAARSHUWING Klasse-1 laser produkt. | |
| 7 |  WAARCHUWING Neit in de straal staren. | |
| 8 |  WAARSCHUWINGEN MET BETREKKING TOT ELEKTRICITEIT
WAARSCHUWING: GEVAAR VOOR ELEKTRISCHE SCHOKKEN
Verwijder het deksel niet, teneinde ELEKTRISCHE schokken te voorkomen. Binnenin bevinden zich geen onderdelen die door de gebruiker onderhouden kunnen worden. Dit toestel staat onder GEVAARLIJKE SPANNING en mag alleen worden geopend door een daartoe opgeleide en bevoegde technicus. Om het gevaar op ELEKTRISCHE SCHOKKEN te vermijden, moet u het toestel van de stroombron ontkoppelen alvorens de LAN-kabels te koppelen of ontkoppelen. | |
| 9 |  GEVAAR VOOR BLIKSEMINSLAG
GEVAAR: NIET aan toestellen of KABELS WERKEN bij BLIKSEM. | |
| 10 |  WAARSCHUWING: HET TOESTEL WORDT UITGESCHAKELD DOOR DE STROOMKABEL TE ONTKOPPELEN. OM HET TOESTEL STROOMLOOS TE MAKEN: de stroomkabel ontkoppelen. | |
| 11 |  ELEKTRISCHE TOESTELLEN VAN KLASSE 1
DIT TOESTEL MOET GEAARD WORDEN. De stekker moet aangesloten zijn op een juist geaarde contactdoos. Een onjuist geaarde contactdoos kan de metalen onderdelen waarmee de gebruiker eventueel in aanraking komt onder gevaarlijke spanning stellen. | |
| 12 |  AAN TE SLUITEN APPARATUUR, de contactdoos wordt in de nabijheid van de apparatuur geïnstalleerd en is gemakkelijk te bereiken." | |
| 13 |  OPGELET: De ventilatiegaten mogen niet worden gesperd en moeten de omgevingslucht ongehinderd toelaten voor afkoeling. | |
| 14 |  BEDRIJFSTEMPERATUUR: De omgevingstemperatuur voor dit produkt mag niet meer bedragen dan 40 graden Celsius. | |
| 15 |  ALLE LANDEN: het toestel installeren overeenkomstig de lokale en nationale elektrische voorschriften. | |













Normes: ce produit est conforme aux normes de suivantes:

- 1 Emission d'interférences radioélectriques EN55022 Classe A
- 2  **MISE EN GARDE:** dans un environnement domestique, ce produit peut provoquer des interférences radioélectriques. Auquel cas, l'utilisateur devra prendre les mesures adéquates.
- 3 Immunité EN50082 - 1
- 4 Sécurité électrique EN60950, UL1950, CSA 950
- 5  Laser EN60825



SÉCURITÉ

- 6  **ATTENTION** Produit laser di classe 1.
- 7  **ATTENTION** Ne pas fixer le faisceau des yeux.
- 8  **INFORMATION SUR LES RISQUES ÉLECTRIQUES**
AVERTISSEMENT: DANGER D'ÉLECTROCUTION
Pour éviter toute ÉLECTROCUTION, ne pas ôter le revêtement protecteur du matériel. Ce matériel ne contient aucun élément réparable par l'utilisateur. Il comprend des TENSIONS DANGEREUSES et ne doit être ouvert que par un technicien dûment qualifié. Pour éviter tout risque d'ÉLECTROCUTION, débrancher le matériel avant de connecter ou de déconnecter les câbles LAN.
- 9  **DANGER DE Foudre**
DANGER: NE PAS MANIER le matériel ou les CÂBLES lors d'activité orageuse.
- 10  **ATTENTION:** LE CORDON D'ALIMENTATION SERT DE MISE HORS CIRCUIT. POUR COUPER L'ALIMENTATION DU MATÉRIEL, débrancher le cordon.
- 11  **ÉQUIPEMENT DE CLASSE 1 ÉLECTRIQUE**
CE MATÉRIEL DOIT ÊTRE MIS A LA TERRE. La prise de courant doit être branchée dans une prise femelle correctement mise à la terre car des tensions dangereuses risqueraient d'atteindre les pièces métalliques accessibles à l'utilisateur.
- 12  **EQUIPEMENT POUR BRANCHEMENT ELECTRIQUE**, la prise de sortie doit être placée près de l'équipement et facilement accessible".
- 13  **ATTENTION:** Ne pas bloquer les fentes d'aération, ceci empêcherait l'air ambiant de circuler librement pour le refroidissement.
- 14  **TEMPÉRATURE DE FONCTIONNEMENT:** Ce matériel est capable de tolérer une température ambiante maximum de ou 40 degrés Celsius.
- 15  **POUR TOUS PAYS:** Installer le matériel conformément aux normes électriques nationales et locales.











Standardit: Tämä tuote on seuraavien standardien mukainen.

- 1 Radioaaltojen häirintä EN55022 Luokka A
- 2  **VAROITUS:** Kotiolosuhteissa tämä laite voi aiheuttaa radioaaltojen häirintä, missä tapauksessa laitteen käyttäjän on mahdollisesti ryhdyttävä tarpeellisiin toimenpiteisiin.
- 3 Kestävyys EN50082-1 1997
- 4 Sähköturvallisuus EN60950, UL1950, CSA 950
- 5  Laser EN60825
- TURVALLISUUS**
- 6  **VAROITUS** Luokan 1 Lasertuote.
- 7  **VARIOTUS** Älä katso säteeseen.
- 8  **SÄHKÖÖN LIITTYVIÄ HUOMAUTUKSIA**
VAROITUS: SÄHKÖISKUVAARA
 Estääksesi SÄHKÖISKUN älä poista kantta. Sisällä ei ole käyttäjän huollettavissa olevia osia. Tämä laite sisältää VAARALLISIA JÄNNITTEITÄ ja sen voi avata vain koulutettu ja pätevä teknikko. Vältääksesi SÄHKÖISKUN mahdollisuuden katkaise sähkövirta tuotteeseen ennen kuin liität tai irrotat paikallisverkon (LAN) kaapelit.
- 9  **SALAMANISKUVAARA**
HENGENVAARA: ÄLÄ TYÖSKENTELE laitteiden tai KAAPELEIDEN KANSSA SALAMOINNIN AIKANA.
- 10  **HUOMAUTUS: VIRTAJOHTOA KÄYTETÄÄN** VIRRANKATKAISULAITTEENA. VIRTAA KATKAISTAAN irrottamalla virtajohto.
- 11  **SÄHKÖ - TYYPPILUOKAN 1 LAITTEET**
TÄMÄ LAITE TÄYTYY MAADOITTAA. Pistoke täytyy liittää kunnollisesti maadoitettuun pistorasiaan. Virheellisesti johdotettu pistorasia voi altistaa metalliosat vaarallisille jännitteille.
- 12  **PISTORASIAAN KYTKETTÄVÄ LAITE;** pistorasia on asennettava laitteen lähelle ja siihen on oltava esteetön pääsy."
- 13  **HUOMAUTUS:** Ilmavaihtoreikiä ei pidä tukkia ja niillä täytyy olla vapaa yhteys ympäröivään huoneilmaan, jotta ilmanvaihto tapahtuisi.
- 14  **KÄYTTÖLÄMPÖTILA:** Tämä tuote on suunniteltu ympäröivän ilman maksimilämpötilalle 40°C.
- 15  **KAIKKI MAAT:** Asenna tuote paikallisten ja kansallisten sähköturvallisuusmääräysten mukaisesti.













Standard: Questo prodotto è conforme ai seguenti standard.

- 1 Emissione RFI (interferenza di radiofrequenza) EN55022 Classe A
- 2  **AVVERTENZA:** in ambiente domestico questo prodotto potrebbe causare radio interferenza. In questo caso potrebbe richiedersi all'utente di prendere gli adeguati provvedimenti.
- 3 Immunità EN50082-1 1997
- 4 Sicurezza elettrica EN60950, UL1950, CSA 950
- 5  Laser EN60825



NORME DI SICUREZZA

- 6  **AVVERTENZA** Prodotto laser di Classe 1.
- 7  **AVERTENZA** Non fissare il raggio con gli occhi.
- 8  **AVVERTENZE ELETTRICHE**
ATTENZIONE: PERICOLO DI SCOSSE ELETTRICHE
Per evitare SCOSSE ELETTRICHE non asportare il coperchio. Le componenti interne non sono riparabili dall'utente. Questa unità ha TENSIONI PERICOLOSE e va aperta solamente da un tecnico specializzato e qualificato. Per evitare ogni possibilità di SCOSSE ELETTRICHE, interrompere l'alimentazione del dispositivo prima di collegare o staccare i cavi LAN.
- 9  **PERICOLO DI FULMINI**
PERICOLO: NON LAVORARE sul dispositivo o sui CAVI durante PRECIPITAZIONI TEMPORALESCHES.
- 10  **ATTENZIONE: IL CAVO DI ALIMENTAZIONE È USATO COME DISPOSITIVO DI DISATTIVAZIONE. PER TOGLIERE LA CORRENTE AL DISPOSITIVO** staccare il cavo di alimentazione.
- 11  **ELETTRICITÀ - DISPOSITIVI DI CLASSE 1**
QUESTO DISPOSITIVO DEVE AVERE LA MESSA A TERRA. La spina deve essere inserita in una presa di corrente specificamente dotata di messa a terra. Una presa non cablata in maniera corretta rischia di scaricare una tensione pericolosa su parti metalliche accessibili.
- 12  **APPARECCHIATURA COLLEGABILE**, la presa va installata vicino all'apparecchio per risultare facilmente accessibile".
- 13  **ATTENZIONE:** le prese d'aria non vanno ostruite e devono consentire il libero ricircolo dell'aria ambiente per il raffreddamento.
- 14  **TEMPERATURA DI FUNZIONAMENTO:** Questo prodotto è concepito per una temperatura ambientale massima di 40 gradi centigradi.
- 15  **TUTTI I PAESI:** installare il prodotto in conformità delle vigenti normative elettriche nazionali.









Sikkerhetsnormer: Dette produktet tilfredsstiller følgende sikkerhetsnormer.

- 1 RFI stråling EN55022 Klasse A
- 2  **ADVARSEL:** Hvis dette produktet benyttes til privat bruk, kan produktet forårsake radioforstyrrelse. Hvis dette skjer, må brukeren ta de nødvendige forholdsregler.
- 3 Immunitet EN50082-1 1997
- 4 Elektrisk sikkerhet EN60950, UL1950, CSA 950
- 5  Laser EN60825
- SIKKERHET**
- 6  **ADVARSEL** Laserprodukt av klasse 1.
- 7  **ADVARSEL** Stirr ikke på strålen.
- 8  **ELEKTRISITET**
ADVARSEL: FARE FOR ELEKTRISK SJOKK
For å unngå ELEKTRISK sjokk, må dekslet ikke tas av. Det finnes ingen deler som brukeren kan reparere på innsiden. Denne enheten inneholder FARLIGE SPENNINGER, og må kun åpnes av en faglig kvalifisert tekniker. For å unngå ELEKTRISK SJOKK må den elektriske strømmen til produktet være avslått før LAN-kablene til- eller frakobles.
- 9  **FARE FOR LYNNEDSLAG**
FARE: ARBEID IKKE på utstyr eller **KABLER** i **TORDENVÆR**.
- 10  **FORSIKTIG: STRØMLEDNINGEN BRUKES TIL Å FRAKOBLE UTSTYRET. FOR** Å DEAKTIVISERE UTSTYRET, må strømforsyningen kobles fra.
- 11  **ELEKTRISK - TYPE 1- KLASSE UTSTYR**
DETTE UTSTYRET MÅ JORDES. Strømkontakten må være tilkopleet en korrekt jordet kontakt. En kontakt som ikke er korrekt jordet kan føre til farlig spenninger i lett t ilgjengelige metalldeleer.
- 12  **UTSTYR FOR STIKKONTAKT.** Stikkontakten skal monteres i nærheten av utstyret og skal være lett tilgjengelig."
- 13  **FORSIKTIG:** Lufterventilene må ikke blokkeres, og må ha fri tilgang til luft med romtemperatur for avkjøling.
- 14  **DRIFTSTEMPERATUR:** Dette produktet er konstruert for bruk i maksimum romtemperatur på 40 grader celsius.
- 15  **ALLE LAND:** Produktet må installeres i samsvar med de lokale og nasjonale elektriske koder.



Padrões: Este produto atende aos seguintes padrões.

- 1 Emissão de interferência de radiofrequência EN55022 Classe A
- 2  **AVISO:** Num ambiente doméstico este produto pode causar interferência na radiorrecepção e, neste caso, pode ser necessário que o utente tome as medidas adequadas.
- 3 Imunidade EN50082-1 1997
- 4 Segurança Eléctrica EN60950, UL1950, CSA 950
- 5  Laser EN60825











SEGURANÇA

- 6  **AVISO** Produto laser de classe 1
- 7  **AVISO** Não olhe fixamente para o raio.
- 8  **AVISOS SOBRE CARACTERÍSTICAS ELÉTRICAS**
ATENÇÃO: PERIGO DE CHOQUE ELÉTRICO
Para evitar CHOQUE ELÉTRICO, não retire a tampa. Não contém peças que possam ser consertadas pelo usuário. Este aparelho contém VOLTAGENS PERIGOSAS e só deve ser aberto por um técnico qualificado e treinado. Para evitar a possibilidade de CHOQUE ELÉTRICO, desconecte o aparelho da fonte de energia elétrica antes de conectar e desconectar os cabos da LAN.
- 9  **PERIGO DE CHOQUE CAUSADO POR RAIOS**
PERIGO: NÃO TRABALHE no equipamento ou nos CABOS durante períodos suscetíveis a QUEDAS DE RAIOS.
- 10  **CUIDADO: O CABO DE ALIMENTAÇÃO É UTILIZADO COMO UM DISPOSITIVO DE DESCONEXÃO. PARA DESELETRIFICAR O EQUIPAMENTO,** desconecte o cabo de ALIMENTAÇÃO.
- 11  **ELÉTRICO - EQUIPAMENTOS DO TIPO CLASSE 1 DEVE SER FEITA LIGAÇÃO DE FIO TERRA PARA ESTE EQUIPAMENTO.** O plugue de alimentação deve ser conectado a uma tomada com adequada ligação de fio terra. Tomadas sem adequada ligação de fio terra podem transmitir voltagens perigosas a peças metálicas expostas.
- 12  **EQUIPAMENTO DE LIGAÇÃO,** a tomada eléctrica deve estar instalada perto do equipamento e ser de fácil acesso."
- 13  **CUIDADO:** As aberturas de ventilação não devem ser bloqueadas e devem ter acesso livre ao ar ambiente para arrefecimento adequado do aparelho.
- 14  **TEMPERATURA DE FUNCIONAMENTO:** Este produto foi projetado para uma temperatura ambiente máxima de 40 graus centígrados.
- 15  **TODOS OS PAÍSES:** Instale o produto de acordo com as normas nacionais e locais para instalações elétricas.



Estándares: Este producto cumple con los siguientes estándares.

- 1 Emisión RFI EN55022 Clase A
- 2  **ADVERTENCIA:** en un entorno doméstico, este producto puede causar radiointerferencias, en cuyo caso, puede requerirse del usuario que tome las medidas que sean convenientes al respecto.
- 3 Inmunidad EN50082-1 1997
- 4 Seguridad eléctrica EN60950, UL1950, CSA 950
- 5  Laser EN60825











SEGURIDAD

- 6  **¡ADVERTENCIA!** Producto láser Clase 1.
- 7  **¡ADVERTENCIA!** No mirat fijamente el haz.
- 8  **AVISOS ELECTRICOS**
ADVERTENCIA: PELIGRO DE ELECTROCHOQUE
 Para evitar un ELECTROCHOQUE, no quite la tapa. No hay ningún componente en el interior al cual puede prestar servicio el usuario. Esta unidad contiene VOLTAJES PELIGROSOS y sólo deberá abrirla un técnico entrenado y calificado. Para evitar la posibilidad de ELECTROCHOQUE desconecte la corriente eléctrica que llega al producto antes de conectar o desconectar los cables LAN.
- 9  **PELIGRO DE RAYOS**
PELIGRO: NO REALICE NINGUN TIPO DE TRABAJO O CONEXION en los equipos o en LOS CABLES durante TORMENTAS ELECTRICAS.
- 10  **ATENCION:** EL CABLE DE ALIMENTACION SE USA COMO UN DISPOSITIVO DE DESCONEXION. PARA DESACTIVAR EL EQUIPO, desconecte el cable de alimentación.
- 11  **ELECTRICO - EQUIPO DEL TIPO CLASE 1**
ESTE EQUIPO TIENE QUE TENER CONEXION A TIERRA. El cable tiene que conectarse a un enchufe a tierra debidamente instalado. Un enchufe que no está correctamente instalado podría ocasionar tensiones peligrosas en las partes metálicas que están expuestas.
- 12  **EQUIPO CONECTABLE,** el tomacorriente se debe instalar cerca del equipo, en un lugar con acceso fácil".
- 13  **ATENCION:** Las aberturas para ventilación no deberán bloquearse y deberán tener acceso libre al aire ambiental de la sala para su enfriamiento.
- 14  **TEMPERATURA REQUERIDA PARA LA OPERACIÓN:** Este producto está diseñado para una temperatura ambiental máxima de 40 grados C.
- 15  **PARA TODOS LOS PAÍSES:** Monte el producto de acuerdo con los Códigos Eléctricos locales y nacionales.

Standarder: Denna produkt uppfyller följande standarder.

- 1 Radiostörning EN55022 Klass A
- 2  **WARNING:** Denna produkt kan ge upphov till radiostörningar i hemmet, vilket kan tvinga användaren till att vidtaga erforderliga åtgärder.
- 3 Immunitet EN50082-1 1997
- 4 Elsäkerhet EN60950, UL1950, CSA 950
- 5  Laser EN60825

SÄKERHET

- 6  **WARNING!** Laserprodukt av klass 1.
- 7  **WARNING!** Laserstrålning när enheten är öppen.
- 8  **TILLKÄNNAGIVANDEN BETRÄFFANDE ELEKTRICITETSRIK:**
RISK FÖR ELEKTRISK STÖTFör att undvika ELEKTRISK stöt, ta ej av locket. Det finns inga delar inuti som behöver underhållas. Denna apparat är under HÖGSPÄNNING och får endast öppnas av en utbildad kvalificerad tekniker. För att undvika ELEKTRISK STÖT, koppla ifrån produktens strömanslutning innan LAN-kablarna ansluts eller kopplas ur.
- 9  **FARA FÖR BLIXTNEDSLAG**
FARA: ARBETA EJ på utrustningen eller kablarna vid ÅSKVÄDER.
- 10  **WARNING: NÄTKABELN ANVÄNDS SOM STRÖMBRYTARE FÖR ATT KOPPLA FRÅN STRÖMMEN,** dra ur nätkabeln.
- 11  **ELEKTRISKT - TYP KLAS 1 UTRUSTNING**
DENNA UTRUSTNING MÅSTE VARA JORDAD. Nätkabeln måste vara ansluten till ett ordentligt jordat uttag. Ett felaktigt uttag kan göra att närliggande metalldelar utsätts för högspänning. Apparaten skall anslutas till jordat uttag, när den ansluts till ett nätverk.
- 12  **UTRUSTNING MED PLUGG.** Uttaget skall installeras i utrustningens närhet och vara lättåtkomligt".
- 13  **WARNING:** Luftventilerna får ej blockeras och måste ha fri tillgång till omgivande rumsluft för avsvälning.
- 14  **DRIFTSTEMPERATUR:** Denna produkt är konstruerad för rumstemperatur ej överstigande 40 grader Celsius.
- 15  **ALLA LÄNDER:** Installera produkten i enlighet med lokala och statliga bestämmelser för elektrisk utrustning.

Appendix B

Technical Support Fax Order

Name _____

Company _____

Address _____

City _____ State/Province _____

Zip/Postal Code _____ Country _____

Phone _____ Fax _____

Incident Summary

Allied Telesyn model number _____

Firmware release number of Allied Telesyn product (if applicable) _____

Other network software products I am using (e.g., network management)

Brief summary of problem _____

Conditions (List the steps that led up to the problem.) _____

Detailed description (Please use separate sheet)

Please also fax printouts of relevant files such as batch files and configuration files. When completed, fax this sheet to the appropriate Allied Telesyn office. Fax numbers can be found on page viii.

Appendix C

AT-8216FXL, AT-8224XL, and AT-8288XL Quick Install Guide Feedback

Please tell us what additional information you would like to see discussed in this guide. If there are topics you would like information on that were not covered in this guide, please photocopy this page, answer the questions and fax or mail this form back to Allied Telesyn. The mailing address and fax number are at the bottom of the page. Your comments are valuable when we plan future revisions of this guide.

I found the following the most valuable _____

I would like the following more developed _____

I would find this guide more useful if _____

Please fax or mail your feedback. Fax to 1-408-736-0100. Or mail to:
Allied Telesyn International, Corp.
c/o Technical Communications
960 Stewart Drive, Suite B
Sunnyvale, CA 94086 USA

