

Switches

AT-3726XL

AT-3716XL

AT-3714FXL



Installation Guide

PN 613-10766-00 Rev B

 **Allied Telesyn**

Simply Connecting the World

Copyright © 1998-1999 Allied Telesyn International, Corp.
960 Stewart Drive Suite B, Sunnyvale CA 94086 USA

All rights reserved. No part of this publication may be reproduced without prior written permission from Allied Telesyn International, Corp.

CentreCom is a registered trademark of Allied Telesyn International, Corp.

All other product names, company names, logos or other designations mentioned herein are trademarks or registered trademarks of their respective owners.

Allied Telesyn International, Corp. reserves the right to make changes in specifications and other information contained in this document without prior written notice. The information provided herein is subject to change without notice. In no event shall Allied Telesyn International, Corp. be liable for any incidental, special, indirect, or consequential damages whatsoever, including but not limited to lost profits, arising out of or related to this manual or the information contained herein, even if Allied Telesyn International, Corp. has been advised of, known, or should have known, the possibility of such damages.

Electrical Safety and Installation Requirements

For AT-3726XL and AT-3716XL

Standards: This product meets the following standards

U.S. Federal Communications Commission

Radiated Energy

Note: This equipment has been tested and found to comply with the limits for a Class A digital device pursuant to Part 15 of the FCC Rules. These limits are designed to provide reasonable protection against harmful interference when the equipment is operated in a commercial environment. This equipment generates, uses, and can radiate radio frequency energy and, if not installed and used in accordance with this instruction manual, may cause harmful interference to radio communications. Operation of this equipment in a residential area is likely to cause harmful interference in which case the user will be required to correct the interference at his own expense.

Note: Modifications or changes not expressly approved by the manufacturer or the FCC can void your right to operate this equipment.

Canadian Department of Communications

This Class A digital apparatus meets all requirements of the Canadian Interference-Causing Equipment Regulations.

Cet appareil numérique de la classe A respecte toutes les exigences du Règlement sur le matériel brouilleur du Canada.

RFI Emission

EN55022 Class A  1a

Immunity

EN50082-1  2

For AT-3714FXL

Standards: This product meets the following standards.

Declaration Of Conformity	
Manufacturers Name:	Allied Telesys International, Corp.
Manufacturers Address:	960 Stewart Drive, Suite B Sunnyvale, CA 94086 USA
Manufacturers Telephone:	408-730-095
Declares that the product:	Fiber Ethernet Switch
Model Number:	AT-3714FXL
This product complies with FCC Part 15B, Class B Limits:	
This device complies with part 15 of the FCC Rules. Operation is subject to the following two conditions: (1) This device must not cause harmful interference, and (2) this device must accept any interference received, including interference that may cause undesired operation.	
This equipment has been tested and found to comply with the limits for a Class B digital device, pursuant to Part 15 of the FCC rules. These limits are designed to provide reasonable protection against harmful interference in a residential installation. This equipment, generates, uses and can radiate radio frequency energy and, if not installed and used in accordance with instructions, may cause harmful interference to radio or television reception, which can be determined by turning the equipment off and on, the user is encourage to try to correct the interference by one or more of the following measures:	
<ul style="list-style-type: none">- Reorient or relocate the receiving antenna.- Increase the separation between the equipment and the receiver.- Connect the equipment into an outlet on a circuit different from that to which the receiver is connected.- Consult the dealer or an experienced radio/TV technician for help.	
Changes and modifications not expressly approved by the manufacturer or registrant of this equipment can void your authority to operate this equipment under Federal Communications Commission rules.	

Canadian Department of Communications	
This Class B digital apparatus meets all requirements of the Canadian Interference-Causing Equipment Regulations.	
Cet appareil numérique de la classe B respecte toutes les exigences du Règlement sur le matériel brouilleur du Canada.	

RFI Emission	EN55022 Class B  1b
Immunity	EN50082-1  2

Safety Warnings

WARNING: In a domestic environment this product may cause radio interference in which case the user may be required to take adequate measures.  3

IMPORTANT: Appendix A contains translated safety statements for installing this equipment. When you see the , go to Appendix A for the translated safety statement in your language.

WICHTIG: Anhang A enthält übersetzte Sicherheitshinweise für die Installation dieses Geräts. Wenn Sie  sehen, schlagen Sie in Anhang A den übersetzten Sicherheitshinweis in Ihrer Sprache nach.

VIGTIGT: Tillæg A indeholder oversatte sikkerhedsadvarsler, der vedrører installation af dette udstyr. Når De ser symbolet , skal De slå op i tillæg A og finde de oversatte sikkerhedsadvarsler i Deres eget sprog.

BELANGRIJK: Appendix A bevat vertaalde veiligheidsopmerkingen voor het installeren van deze apparatuur. Wanneer u de  ziet, raadpleeg Appendix A voor vertaalde veiligheidsinstructies in uw taal.

IMPORTANT : L'annexe A contient les instructions de sécurité relatives à l'installation de cet équipement. Lorsque vous voyez le symbole , reportez-vous à l'annexe A pour consulter la traduction de ces instructions dans votre langue.

TÄRKEÄÄ: Liite A sisältää tämän laitteen asentamiseen liittyvät käännetyt turvaohjeet. Kun näet -symbolin, katso käännettyä turvaohjetta liitteestä A.

IMPORTANTE: L'Appendice A contiene avvisi di sicurezza tradotti per l'installazione di questa apparecchiatura. Il simbolo , indica di consultare l'Appendice A per l'avviso di sicurezza nella propria lingua.

VIKTIG: Tillegg A inneholder oversatt sikkerhetsinformasjon for installering av dette utstyret. Når du ser , åpner du til Tillegg A for å finne den oversatte sikkerhetsinformasjonen på ønsket språk.

IMPORTANTE: O Anexo A contém advertências de segurança traduzidas para instalar este equipamento. Quando vir o símbolo , leia a advertência de segurança traduzida no seu idioma no Anexo A.

IMPORTANTE: El Apéndice A contiene mensajes de seguridad traducidos para la instalación de este equipo. Cuando vea el símbolo , vaya al Apéndice A para ver el mensaje de seguridad traducido a su idioma.

OBS! Bilaga A innehåller översatta säkerhetsmeddelanden avseende installationen av denna utrustning. När du ser , skall du gå till Bilaga A för att läsa det översatta säkerhetsmeddelandet på ditt språk.

Table of Contents

Electrical Safety and Installation Requirements	iii	
For AT-3726XL and AT-3716XL	iii	
For AT-3714FXL	iv	
Safety Warnings	v	
Preface		
Purpose of This Guide	Preface-i	
How This Guide is Organized	Preface-i	
Document Conventions	Preface-ii	
Related Guides	Preface-ii	
Chapter 1		
Product Description		1-1
Physical Description	1-3	
Hardware Features	1-4	
Network Management Features	1-5	
MAC Addressing	1-5	
Store-and- Forward Mode	1-5	
Transmit Pacing	1-5	
Mirror Port	1-6	
Media Dependent Adapters (MDAs)	1-6	
RS232 Connector	1-8	
Reset Button	1-8	
AC Power Connector	1-8	
Chapter 2		
Installing the Switch		2-1
Verifying Switch Package Contents	2-1	
Safety Information	2-2	
Preparing the Site	2-3	
Installing the Switch on the Desktop	2-4	
Rack Mounting the Unit	2-5	
Setting Up Terminal for Local Management Using Omega	2-7	
Switch Default Settings	2-8	
Media Dependent Adapters	2-9	
Verifying Package Contents.....	2-9	
Media Dependent Adapter Features.....	2-10	
Installing a Media Dependent Adapter	2-11	
Media Dependand Adapter LEDs	2-12	

Chapter 3

Troubleshooting3-1
At the First Sign of a Problem3-1
Network Cabling Problems3-2
Contacting Technical Support3-3
How the Switch Reports Problems3-4
Common Problems3-5
 Port Activity LED ON any Port is OFF3-5
 Power LED is OFF3-6
 Fault LED is ON3-7

Chapter 4

Switch Configurations4-1
Standalone Switch Configuration4-1
Workgroup Switch Configuration4-3

Appendix A

Translated Safety InformationA-1

Appendix B

Technical SpecificationsB-1
Media Dependent Adapter Cabling DistancesB-2

IndexIndex-1

Preface

Purpose of This Guide

This guide is written for installers and network administrators who are responsible for installing and maintaining the switch.

How This Guide is Organized

This guide consists of the following sections:

Chapter 1, **Product Description**, describes the features and functions of the switch.

Chapter 2, **Installing the Switch**, describes the procedures for installing the switch.

Chapter 3, **Troubleshooting**, describes how to troubleshoot the switch.

Chapter 4, **Switch Configurations**, presents topological illustrations for the switch.

Appendix A, **Translated Safety Information**, contains all of the translated safety warnings documented throughout this guide.

Appendix B, **Technical Specifications**, presents in tabular form the switch specifications.

An **Index** at the end of this guide lists entries according to subject matter.

Document Conventions

The conventions used in this guide are as follows:

Note

A note provides additional information.



Warning

A warning indicates that performing or omitting a specific action may result in bodily injury.



Caution

A caution indicates that performing or omitting a specific action may result in equipment damage or loss of data.

When you see the , go to Appendix A for the translated safety statement in your language.

Related Guides

Allied Telesyn wants our customers to be well informed by providing the most up-to-date and most easily accessible way to find our guides and other technical information.

Visit our website at: www.alliedtelesyn.com and download the following guide:

AT-3726XL, AT-3716XL, and AT-3714FXL Installation Guide, 613-10766-00

AT-S20 User's Guide, 613-10716-00

The following guides are shipped with their respective products:

AT-3726XL and AT-3716XL Quick Install Guide,
613-10769-00

AT-3726XL and AT-3716XL Translated Safety Information Booklet, 613-10768-00

AT-3714FXL Quick Install Guide, 613-10767-00

AT-3714FXL Translated Safety Information Booklet,
613-10770-00

AT-A10, AT-A11, AT-A20 and AT-A21 Quick Install Guide,
613-10742-00

Chapter 1

Product Description

The AT-3726XL and AT-3716XL are standalone, managed Ethernet switches that provides 24 or 14 10Base-T ports and one built-in 10/100Base-TX port. All ports capable of full- or half-duplex with auto-negotiation or manual configuration on all ports.

The AT-3714FXL provides 12 10Base-FL ports with one built-in 100Base-FX (SC). All ports manually configurable for half- or full-duplex.

All switches include a 100Base slot that can be configured with an optional Media Dependent Adapter (MDA) for 10/100Base-TX, 100Base-FX (SC), 100Base-FX (MT-RJ) or 100Base-FX (VF-45). Figure 1-1 shows the switches with the optional AT-A10, AT-A11, AT-A20 and AT-A21 MDAs.

The switches are intended for connections to the desktop as well as workgroup applications and implement direct high-speed server and backbone connections. Full-duplex capability on all ports eliminates collisions and provides up to 20 Mbps on the 10Base ports and up to 200 Mbps of bandwidth on the 100Base ports to servers, routers, and other switches. With built-in management, these switches provide seamless SNMP-based management capability.

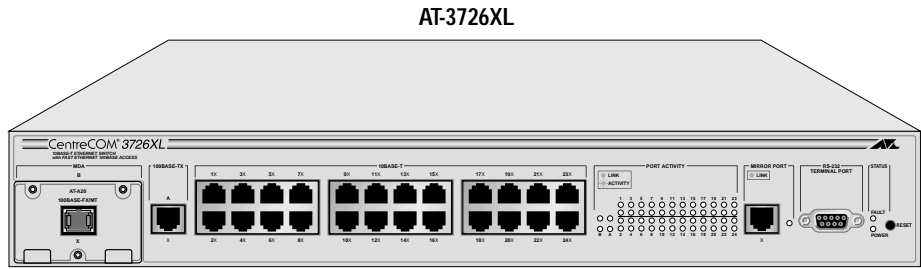

AT-A20 (optional MDA)

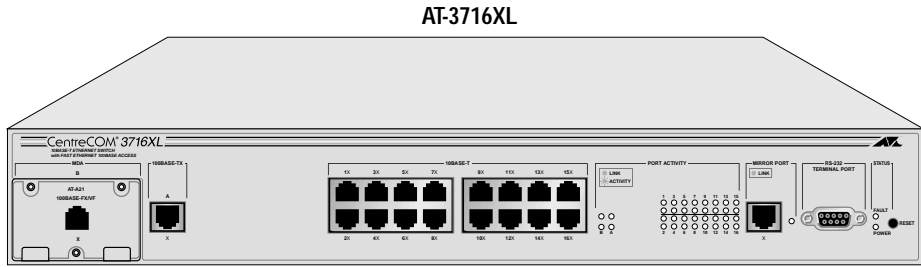

AT-A21 (optional MDA)

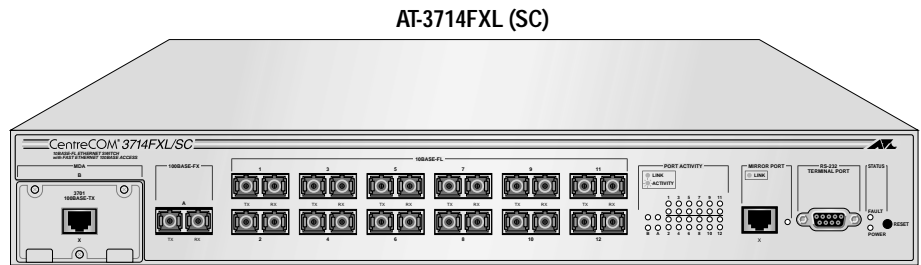

AT-A10 (optional MDA)

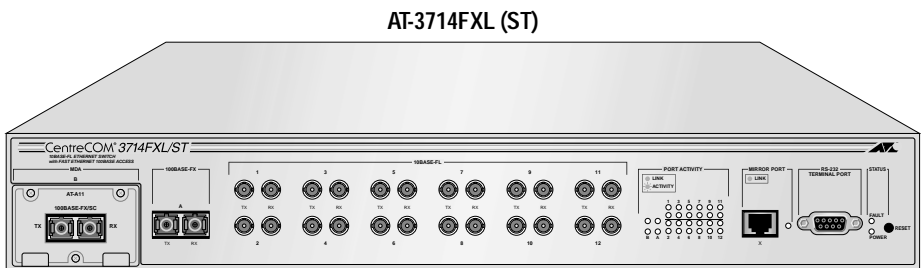

AT-A11 (optional MDA)

Figure 1-1 AT-3726XL, AT-3716XL, and AT-3714FXL (SC/ST) Switches

Physical Description

The switches have the following major front panel components:

- 24 or 14 Ethernet 10Base-T RJ45 ports (AT-3726XL, AT-3716XL); 12 Ethernet 10Base-FL (SC/ST) ports (AT-3714FXL)
- Optional MDA - 100Base-X port can be configured either with 10/100Base-TX (RJ45, AT-A10) connector, 100Base-FX (SC, AT-A11) connector, 100Base-FX (MT-RJ, AT-A20) connector or 100Base-FX (VF-45, AT-A21) connector
- Port Mirroring on 10Base-T RJ45 port
- One Fast Ethernet 100Base-TX RJ45 port (AT-3726XL, AT-3716XL); 100Base-FX (SC) for AT-3714FXL
- RS232 (DB9) connector (out-of-band configuration via Local Omega)
- Reset button
- System and port status LEDs

Hardware Features

The switches have the following major hardware features:

- 24 or 16 10Base-T ports for the AT-3726XL/AT-3716XL, plus one built-in 10/100Base-TX port capable of full- or half-duplex configurable through auto-negotiation (IEEE 802.3u standard) or manually settleable.
- 12 10Base-FL ports (SC/ST) for the AT-3714FXL, capable of full- or half-duplex, manually configurable.
- Additional 100Base modular port provides the option of a 100Base-TX or 100Base-FX port using one of the MDAs.
- Non-blocking, clear-channel architecture delivers wire-speed bridging and delivers up to 880 Mbps aggregate bandwidth for AT-3726XL, up to 720 Mbps for the AT-3716XL, and up to 640 Mbps for the AT-3714FXL to workstations, servers, routers and between switches.
- Shared-memory architecture of up to 4 MB of packet buffer using cost-effective EDO DRAM (dependent on model number) which virtually eliminates packet loss.
- Store-and-forward switching mode allows for full error checking.
- Hardware-base support for static entries and self-learning of active MAC addresses and their associated Virtual LANs (VLANs).
- Stores 2K MAC addresses in CAM.
- Port mirroring.
- VLANs configuration provides broadcast traffic control, firewall protection, and simplifies adds, moves, and changes. Supports thirty-two VLANs configurable by port or by tagging.
- Supports IEEE 802.1Q VLAN tagging.
- Half-duplex back pressure.
- Embedded 25 MHz 486 CPU supports management functions. Sufficient system memory which includes DRAMs and Flash memory for convenient firmware upgrades.
- In-band configuration of switch through Telnet, Remote Omega.
- In-band configuration through web, web-based Omega.
- Out-of-band configuration through RS232 connector, Local Omega.

Network Management Features

The switches have the following major network management features:

- ❑ SNMP Management Information Base (MIB) II, SNMP MIB extensions, Bridging MIB (RFC 1493), and Telnet support deliver comprehensive in-band management
- ❑ Web-based management
- ❑ Local Omega, a menu-based management console, provides detailed out-of-band configuration
- ❑ VLAN by port and 802.1Q VLAN tagging
- ❑ Embedded MIB statistics for enhanced traffic management, monitoring, and analysis
- ❑ IEEE 802.1d Spanning Tree Protocol support for redundant backbone connections and loop-free networks simplifies configuration and improves fault tolerance

MAC Addressing

The switch has hardware base support with Internal Address Lookup Engine (IALE) for static entries and self-learning of active MAC addresses. The switch supports 2K MAC addresses in CAM.

Store-and-Forward Mode

With store-and-forward switching mode, network administrators can optimize performance and enable full-error checking.

The store-and-forward mode works in the following way. First, as the packet is being received, it is placed in a buffer and held there until the entire packet is received. The packet is also being checked for errors and is not forwarded unless the entire packet is error-free. This mode is automatic when data is exchanged between 10Base and 100Base ports.

Transmit Pacing

Transmit pacing is enabled on a per port basis. When transmit pacing is enabled, the switch alters its transmission routine during heavy network activity. When the switch senses heavy traffic, it alters its transmission routing by intentionally inserting additional delay between transmission attempts. This added delay reduces collision rates, thus reducing the number of transmission attempts, which helps reduce CPU utilization, lightens overall network traffic, and allows the network time to normalize before attempting transmission.

If this additional delay is not applied, the switch attempts to transmit on an overloaded network, increasing the number of unsuccessful transmission attempts.

For detailed information concerning software and management features, refer to the **AT- S20 User's Guide**.

Mirror Port

The switch has a dedicated Mirror port. Administrators can use the Omega software to configure the Mirror port and modes. The Mirror port can monitor traffic on any port, one port at a time. A protocol analyzer or an RMON probe can be connected to the port mirroring connector using a standard Category 5 UTP cable.

In full-duplex mode the user needs to determine if they want to monitor TX or only RX data, but in only one direction at a time. In half-duplex mode, both RX/TX can be monitored simultaneously.

Media Dependent Adapters (MDAs)

The MDAs come in four versions, the AT-A10 which is the 10/100Base-TX adapter, the AT-A11 which is the 100Base-FX/SC version, the AT-A20 which is the 100Base-FX/MT version and the AT-A21 which is the 100Base-FX/VF version. The adapter LEDs, one for Activity and the other for Link status, are located on the switch's front panel under Port Activity.

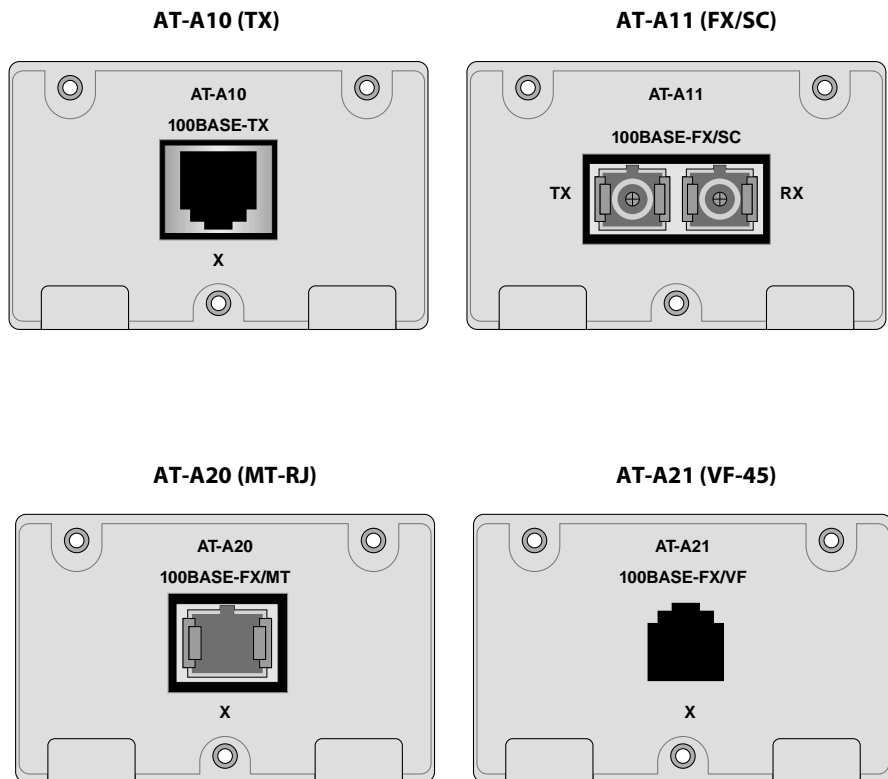

Figure 1-2 Media Dependent Adapter Faceplates

Table 1-1 lists the features of the MDAs. For details concerning how to install an adapter, see Chapter 2, **Installing a Media Dependent Adapter** on page 2-11.

Table 1-1 Media Dependent Adapter Features

Adapter	Supported Cable	Description
AT-A10	RJ45	10/100Base-TX RJ45 Ethernet port: auto-negotiated speed and duplex mode 10/100Base-T max. segment length: 330 ft (100 m), Category 5 UTP
AT-A11	Fiber SC	100Base-FX: multimode SC fiber connector 100Base Ethernet port 100Base-FX: max. segment length 1.25 mi (2 km) for full-duplex, 1351 ft (412 m) for half-duplex; 50/125 and 62.5/125 micron multimode fiber
AT-A20	Fiber MT-RJ	100Base-FX: multimode MT-RJ fiber connector 100Base Ethernet port 100Base-FX: max. segment length 1.25 mi (2 km) for full-duplex, 1351 ft (412 m) for half-duplex; 50/125 and 62.5/125 micron multimode fiber
AT-A21	Fiber VF-45	100Base-FX: multimode VF-45 fiber connector 100Base Ethernet port 100Base-FX: max. segment length 1.25 mi (2 km) for full-duplex, 1351 ft (412 m) for half-duplex; 50/125 and 62.5/125 micron multimode fiber

RS232 Connector

The RS232 connector provides out-of-band management through a VT100 terminal or a terminal emulation program such as HyperTerminal which is included with Microsoft® Windows' OS using a straight-through serial cable.

Reset Button

This recessed button can be activated using the tip of a ball point pen to reset the unit and run the power-on self tests.

AC Power Connector

The switch has a single power supply, which has autoswitch AC inputs. The input voltage range is from 120-240 VAC, 50/60 Hz.

Chapter 2

Installing the Switch

The AT-3726XL, AT-3716XL, and AT-3714FXL switch is 1.5 Rack Unit (RU) high and can be positioned on a desktop as a standalone unit or rack-mounted in a standard 19-inch rack.

Verifying Switch Package Contents

Make sure the following hardware components are included in your switch package. If any of the following items are missing or damaged, contact your sales representative.

- AT-3726XL, AT-3716XL, or AT-3714FXL Switch
- 2 mounting brackets
- 6 flathead Phillips screws
- Power cord (Americas, Central Europe, or UK only)
- Quick Install Guide
- Translated Safety Information Booklet
- Warranty card

Safety Information

Refer to Appendix A for translated safety statements in your language.



Warning
Electric Shock Hazard

To prevent ELECTRIC shock, do not remove cover. No user-serviceable parts inside. This unit contains HAZARDOUS VOLTAGES and should only be opened by a trained and qualified technician. To avoid the possibility of ELECTRIC SHOCK disconnect electric power to the product before connecting or disconnecting the LAN cables.

8



Laser

Warning Class 1 Laser product. 6



Laser

Warning Do not stare into the Laser beam. 7



Caution
Lightning Danger

DO NOT WORK on equipment or CABLES during periods of LIGHTNING ACTIVITY. 9



Caution
Electrical—Type Class 1 Equipment

This Equipment Must Be Earthed. Power plug must be connected to a properly wired earth ground socket outlet. An improperly wired socket outlet could place hazardous voltages on accessible metal parts. 11



Caution
Electrical—Cord Notice

Use power cord, maximum 4.5 meters long, rated 5 amp minimum, 250V, made of HAR cordage molded IEC 320 connector on one end and on the other end a plug approved by the country of end use.

12



Caution

Air vents must not be blocked and must have free access to the room ambient air for cooling. 13



Caution
Operating Temperature

This product is designed for a maximum ambient temperature of 40° C. 14



Caution

All Countries: Install product in accordance with local and National Electrical Codes. 15

Preparing the Site

Make sure that you follow common sense installation site requirements and observe the following:

- Make sure that the switch's power is accessible and cables can be easily connected.
- Cabling must be away from sources of electrical noise such as radios, transmitters, broadband amplifiers, power lines, and fluorescent fixtures.
- Ensure that the air vents on the side and rear of the switch are not restricted.
- If you are desk mounting the switch, make sure it is placed on a level, secure desktop.
- Do not place objects on top of the switch.
- Do not expose the switch to moisture or water.
- Make sure it is in a dust-free environment.
- Use a dedicated conditioned power circuit or UPS (Uninterruptable Power Supply) to provide reliable electrical power to the network devices.

Installing the Switch on the Desktop

1. Place the switch on a level, secure surface.
2. Apply power to the switch as follows:



Caution

The power cord is used as a disconnect device. To de-energize equipment, disconnect the power cord. ⚡ **10**

Attach the power cord to the unit and plug it in the wall outlet. Verify that the Power LED lights green. See Table 2-1 on 2-6.

As power is applied to the switch, the Fault LED flashes as the switch runs through its internal self-testing programs.

Rack Mounting the Unit



Caution

Do not use power tools to perform the following installation.



To rack mount the unit

1. Remove all cables and power cord from the switch (if previously attached).
2. Remove the snap-on plastic feet, as shown in Figure 2-1.

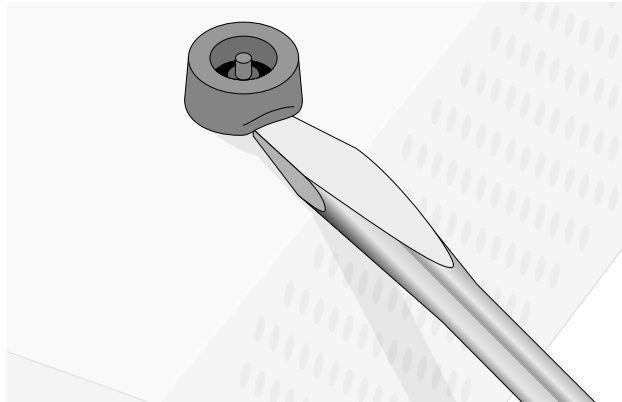

Figure 2-1 Removing the Feet

3. Attach the rack-mounting brackets to each side of the switch, using the 6 flathead screws provided.

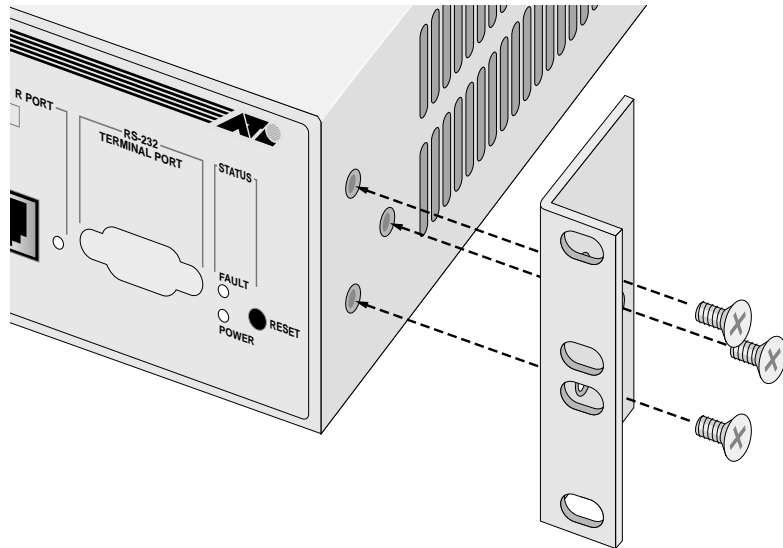

Figure 2-2 Attaching Rack-Mounting Brackets

4. Mount the unit in the rack.
5. Apply power to the unit as follows:

**Caution**

Power cord is used as a disconnection device. To de-energise equipment disconnect the power cord. *SR* 10

Attach the power cord to the unit and plug it in the wall outlet. Verify that the Power LED lights green. As power is applied to the switch, the switch runs its own internal testing. See Table 2-1, LEDs.

Table 2-1 LEDs

LED	Color	State	Description
Power (system)	Green	On	The switch is receiving power, voltage is within the acceptable range, and the power supply is working. Note: if only the management software is malfunctioning, the switch continues to forward packets.
		Off	No power.
Fault (system)	Red	On	The switch or management software is malfunctioning.
		Off	Normal operation.
		Flashing	Running diagnostics.
Link	Green	On	There is a physical link with a device.
		Off	No link.
Activity	Green	Flashing or On	The Ethernet port is receiving/transmitting packets.
		Off	No transmits or receives occurring on this port.

If the Power LED does not light green, see Chapter 3, **Troubleshooting** for further information.

Setting Up Terminal for Local Management Using Omega

1. For local management, connect your terminal to the RS232 connector on the switch's front panel. Use an RS232 DB9 straight-through serial cable.

Note

The RS232 is for Setup and Diagnostics only. The cable must be disconnected during normal operation to maintain Emissions Compliance.

2. Access your terminal emulator program. Press **Return** several times to ensure baud configuration (autobaud).
3. Set your terminal to the following
 - 8, data bits
 - 1, stop bits
 - None, parity

See also Table 2-2, Switch Default Settings.

You are now ready to access the switch's management software, Omega.

For remote management and further details concerning the Omega management software, refer to the **AT-S20 User's Guide**.

Switch Default Settings

Table 2-2 lists the switch default settings.

Table 2-2 Switch Default Settings

Settings	Default
IP Address	0.0.0.0
Subnet Mask	0.0.0.0
Gateway Address	0.0.0.0
Get community string	public
Set community string	private
Trap community string	public
Port mirroring state	Disabled
Spanning Tree Protocol	Disabled
Telnet Access	Enabled
System Name	None
Password (Omega)	No password assigned
Download Password	ATS20
Port Priority	128
Port Path Cost	100
Auto-negotiate/Half-Duplex/Full-Duplex	Auto-negotiate (AT-3726XL, AT-3716XL) Half-duplex (AT-3714FXL)
Spanning Tree Priority	32768
Active Aging Time	300 seconds
Hello Time	2 seconds
Transmit Pacing	Disabled
Bridge Identifier (STP)	32768 (bridge priority)
Port Priority (STP)	128
Port Cost (STP)	100 for 10 Mbps ports 10 for 100 Mbps ports
Store-and-forward or Cut-through (Fragment-free)	Store-and-forward
Domain Name	None
Timeout	5 minutes
Default VLAN Name	Default VLAN

Media Dependent Adapters

Four types of MDAs can be installed in the switches: either the AT-A10 (RJ45), the AT-A11 (Fiber/SC), the AT-A20 (Fiber/MT) or the AT-A21 (Fiber/VF).

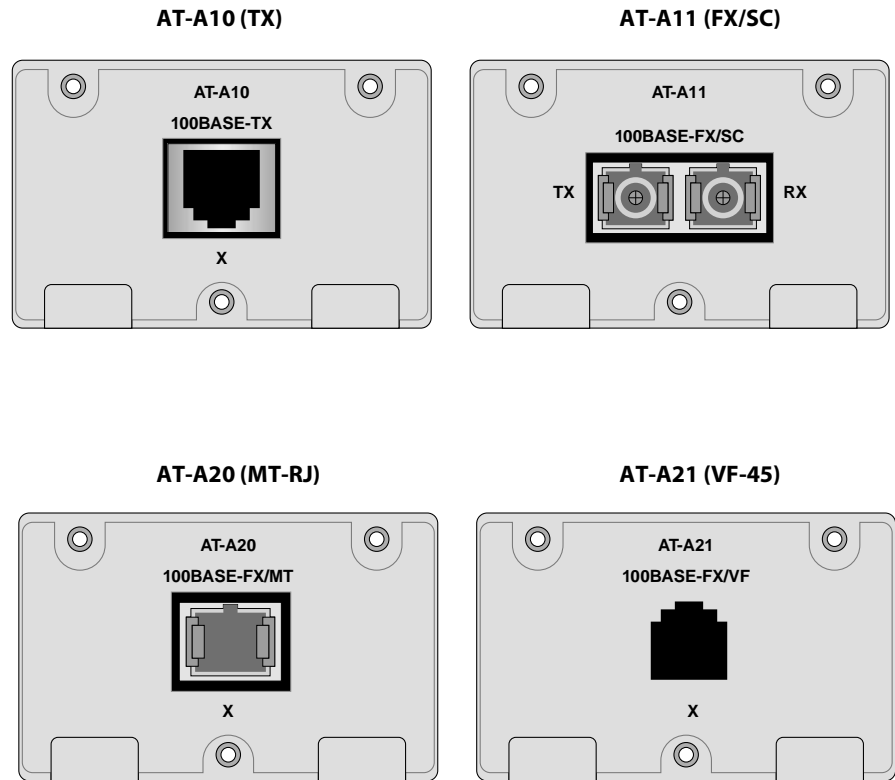

Figure 2-3 Media Dependent Adapter Faceplates

Verifying Package Contents

Make sure that you have received the following items:

- AT-A10, AT-A11, AT-A20 or AT-A21 adapter
- 3 flathead Phillips screws
- AT-A10, AT-A11, AT-A20 and AT-A21 Quick Install Guide
- Warranty Card

Media Dependent Adapter Features

Table 2-3 lists the MDA features.

Table 2-3 Media Dependent Adapter Features

Adapter	Supported Cable	Description
AT-A10	RJ45	10/100Base-TX RJ45 Ethernet port: auto-negotiated speed and duplex mode 10/100Base-T max. segment length: 330 ft (100 m), Category 5 UTP
AT-A11	Fiber SC	100Base-FX: multimode SC fiber connector 100Base Ethernet port 100Base-FX: max. segment length 1.25 mi (2 km) for full-duplex, 1351 ft (412 m) for half-duplex; 50/125 and 62.5/125 micron multimode fiber
AT-A20	Fiber MT-RJ	100Base-FX: multimode MT-RJ fiber connector 100Base Ethernet port 100Base-FX: max. segment length 1.25 mi (2 km) for full-duplex, 1351 ft (412 m) for half-duplex; 50/125 and 62.5/125 micron multimode fiber
AT-A21	Fiber VF-45	100Base-FX: multimode VF-45 fiber connector 100Base Ethernet port 100Base-FX: max. segment length 1.25 mi (2 km) for full-duplex, 1351 ft (412 m) for half-duplex; 50/125 and 62.5/125 micron multimode fiber

Installing a Media Dependent Adapter

▶ To install an MDA, do the following:

1. Disconnect the switch's power cord.
2. Unscrew the 3 flathead Phillips screws on the switch's blank faceplate and save the faceplate and screws for future use.



Caution

Make sure the MDA blank panel is attached to the unit if the MDA slot is vacant.

3. Unpack the MDA, making sure to observe ESD precautions.

The standoff on the MDA guides the adapter correctly into position so that the 50-pin plug aligns with the 50-pin receptacle on the main board. See Figure 2-4 and Figure 2-5 when performing the next step.

4. Slide the MDA into its empty slot making sure that the standoff is aligned properly.
5. Push the MDA into position so that the front panel contacts the front of the switch's chassis. See Figure 2-4.

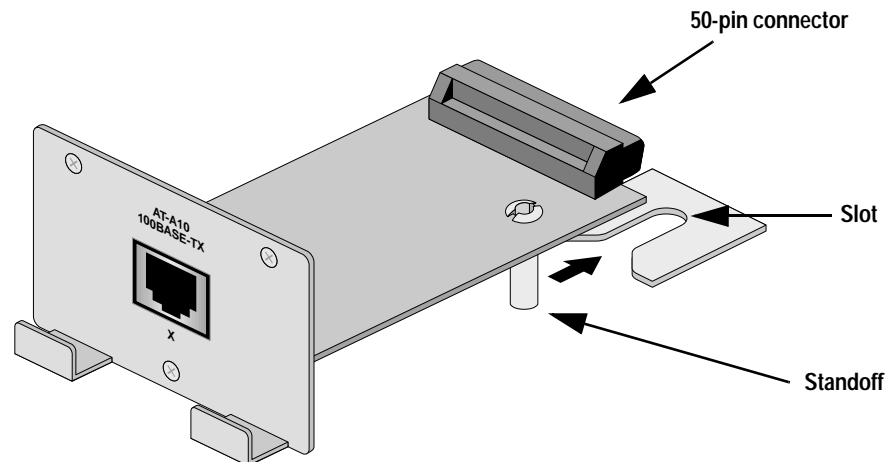

Figure 2-4 Guiding the MDA Standoff Into Its Slot

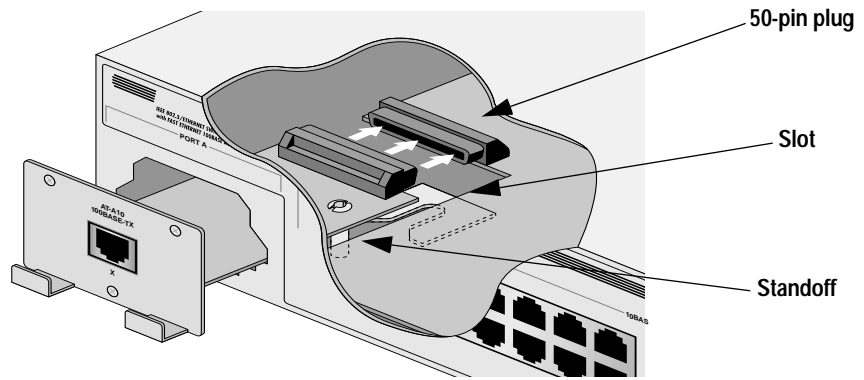

Figure 2-5 Connecting the 50-Pin Plug

6. Secure the MDA to the front of the switch with the 3 flathead Phillips screws that came with the MDA package.
7. Apply power to the unit as follows:



Caution

Power cord is used as a disconnection device. To de-energise equipment disconnect the power cord. *10*

Re-attach the power cord to the unit and plug it in the wall outlet. Verify that the Power LED lights green. See Table 2-1 on page 2-6.

8. Connect the data cable. Verify that the LEDs light.

Media Dependant Adapter LEDs

The MDA LEDs are located on the front panel of the switch under Port Activity.

Table 2-4 Media Dependent Adapter LEDs

LED	Color	State	Description
Link	Green	On	There is a good physical link with a device.
Activity	Green	Flashing or On	The Ethernet port is receiving/transmitting packets.

For troubleshooting techniques, see Chapter 3, **Troubleshooting**.

Chapter 3

Troubleshooting

At the First Sign of a Problem

Perform the following tasks when you first become aware of a problem with the switch:

- Make sure the power cord is securely connected and the power voltage is not fluctuating.
- Check the data cables for secure connections and make sure the device at the other end of a connection is operational.
- Press the **Reset** button so the switch can run self-diagnostics.

Use Omega to run diagnostics and read statistics. Refer to **AT-S20 User's Guide**, Chapter 5, **Diagnostics**, and Chapter 3, **Statistics: Received and Transmitted Ethernet Frames**, for further details concerning Omega.

- If the management software has failed, check the LEDs to see if the switch continues to forward packets. Then, at a convenient time, reboot the switch by pressing the **Reset** button or power OFF/ON the switch.
- If problems still persist, for example, the Fault LED remains on, contact Allied Telesyn's Technical Support or visit Allied Telesyn's website at **www.alliedtelesyn.com**.

Network Cabling Problems

If you have 100Base-TX (Fast Ethernet), some network problems may be related to exceeding cabling distances. Refer to the standard IEEE 802.3u, Clause 29.3.1.2 on **Worst Case Path Delay Value**. This document specifies that the collision domain diameter must be within the following limits:

- Under 330 ft (100 m) for TX cabling
- Under 1331.56 ft (412 m) for half-duplex FX cabling

Contacting Technical Support

Provide Technical Support with the following information:

- Switch model and serial number
- Software version number
- Description of the problem

See Allied Telesyn's website at **www.alliedtelesyn.com** for a list of worldwide Allied Telesyn locations.

How the Switch Reports Problems

The switch detects and processes errors as follows:

- ❑ The LEDs indicate problems with the port and power. Table 3-1 list and describes the switch LEDs.
- ❑ In a TCP/IP environment, if you have configured the software correctly, the management software triggers an SNMP trap message. As a result, the software then sends traps to alert the network manager when a trigger occurs. This type of software configuring allows the network administrator/manager to pro-actively monitor their network.

Table 3-1 LEDs

LED	Color	State	Description
Power (system)	Green	On	The switch is receiving power, voltage is within the acceptable range, and the power supply is working. Note: if only the management software is malfunctioning, the switch continues to forward packets.
		Off	No power.
Fault (system)	Red	On	The switch or management software is malfunctioning.
		Off	Normal operation.
		Flashing	Running diagnostics.
Link	Green	On	There is a physical link with a device.
		Off	No link.
Activity	Green	Flashing or On	The Ethernet port is receiving/transmitting packets.
		Off	No transmits or receives occurring on this port.

Common Problems

This section lists the common switch problems and the recommended actions to correct these problems.

Port Activity LED ON any Port is OFF

This may indicate:

- A loose data cable.
- The device at the other end of the connection is turned OFF.
- The port is disabled through the software.

Perform the following steps in sequence; you need not proceed to the next step if the problem is resolved:

1. Make sure the data cables are secure.
2. Make sure the device at the end of the connection is turned ON.
3. Someone has manually disabled the port through the software.
4. Log on to Omega if you can and check the port status (`Port status and configuration <port number>`).
5. Refer to the **AT-S20 User's Guide** to check that the port is Disabled. If the port is disabled, someone has manually disabled the port through the software for a specific reason. Verify that the reason no longer exists before you enable this port (`Port status and configuration` menu in the software).
6. Contact Allied Telesyn's technical support.

Power LED is OFF

If there is no power to the switch, it cannot function.

A Power LED that is OFF may indicate:

- A loose power cord.
- Power supply failure, malfunction or loss of power to the power supply.
- A power supply voltage is below acceptable levels.
- A high switch temperature due to fan failure or ambient temperature extreme.

Perform the following steps in sequence; you need not proceed to the next step if the problem is resolved:

1. Secure the power cord to the power source and check the Power LED to see if it is ON.
2. Ensure that the voltage is within the required levels in your region.
3. Log on to Omega and run Diagnostics if you can (`System administration>Diagnostics`) and record any failures.
4. Contact Allied Telesyn's technical support and report the results of the tests.

Fault LED is ON

This might indicate problems with the network management software, such as:

- Unsuccessful software downloads
- Loose RS232 interface connection

Perform the following steps in sequence; you need not proceed to the next step if the problem is resolved:

1. Reset the switch either by:
 - Pressing the **Reset** button on the front panel, or
 - Selecting `System Administration>Reset` and restart the system from Omega, if you can.
2. Make sure the RS232 connection from the local terminal or PC to the switch is secure; change the cable if necessary.

If you cannot access Omega Local because of a faulty RS232 connection, use Omega Remote via Telnet or manage the switch using SNMP until the problem is fixed.
3. Unplug the switch from the power source, then plug it back in again.
4. Try to log on to Omega and run diagnostics (`System administration>Diagnostics`).
5. Contact Allied Telesyn's technical support.

Chapter 4

Switch Configurations

Standalone Switch Configuration

Figure 4-4 and Figure 4-2 show the AT-3726XL and AT-3714FXL Switch respectively, used as a standalone switch for a group of heavy traffic users in a large corporate network. Switching is brought to the desktop with a single end-station per switch port. A local server is connected to the 100 Mbps Fast Ethernet port.

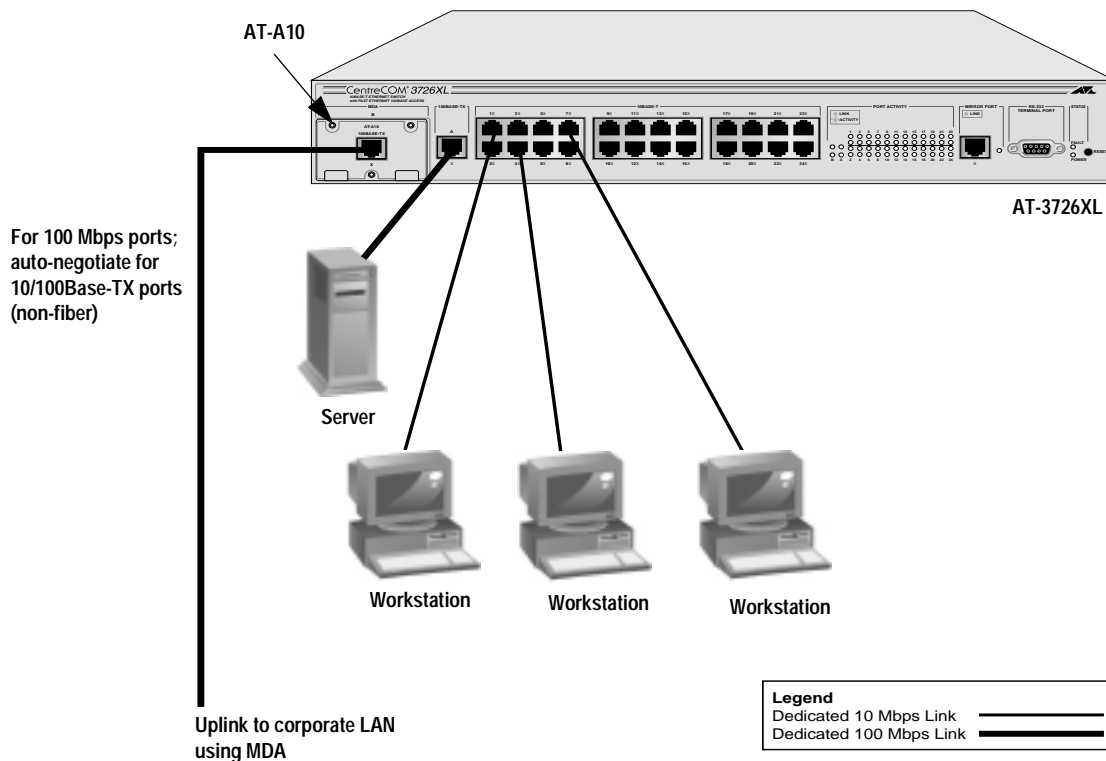

Figure 4-1 AT- 3726XL Switch in Desktop Configuration

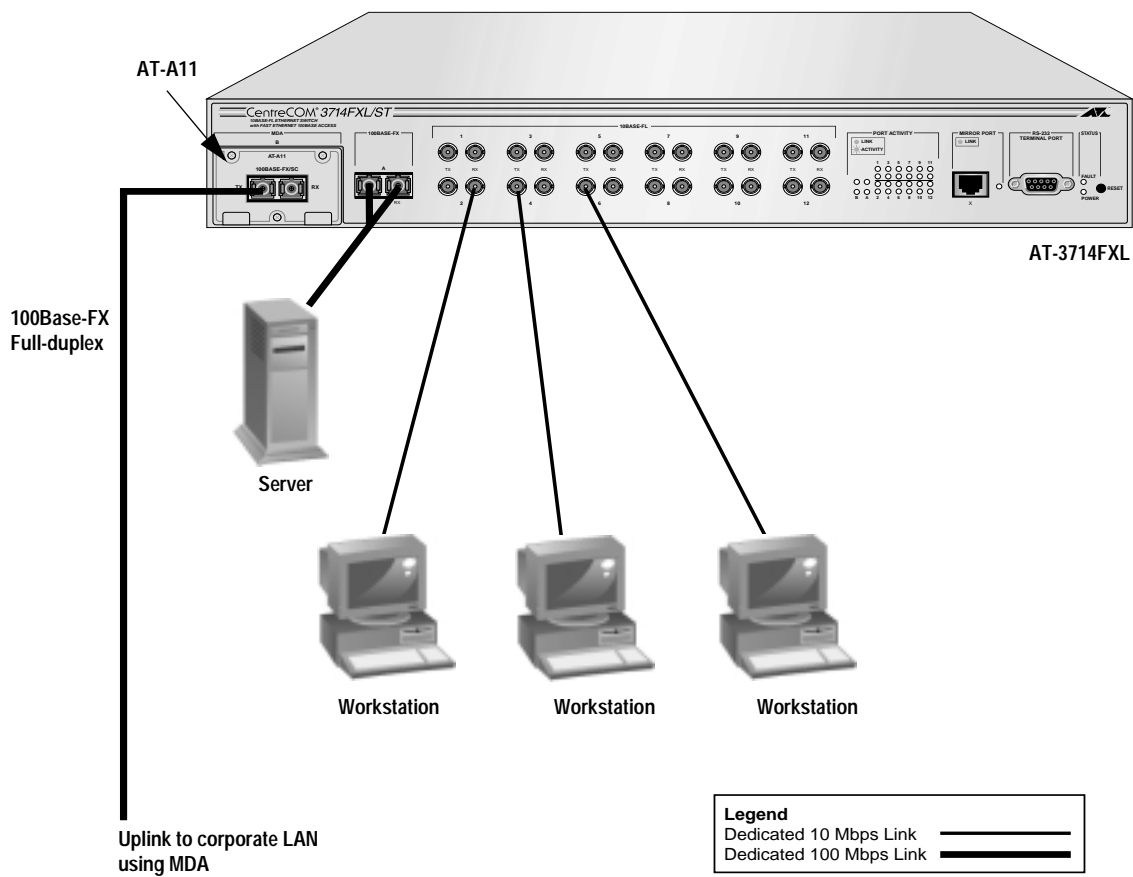

Figure 4-2 AT- 3714FXL Switch in Desktop Configuration

Workgroup Switch Configuration

Figure 4-3 and Figure 4-4 show how cascaded AT-3726XLs and AT-3714FXLs respectively, fit into a large corporate network with a Fast Ethernet infrastructure. A switch is located on each floor and servers are centralized in one room.

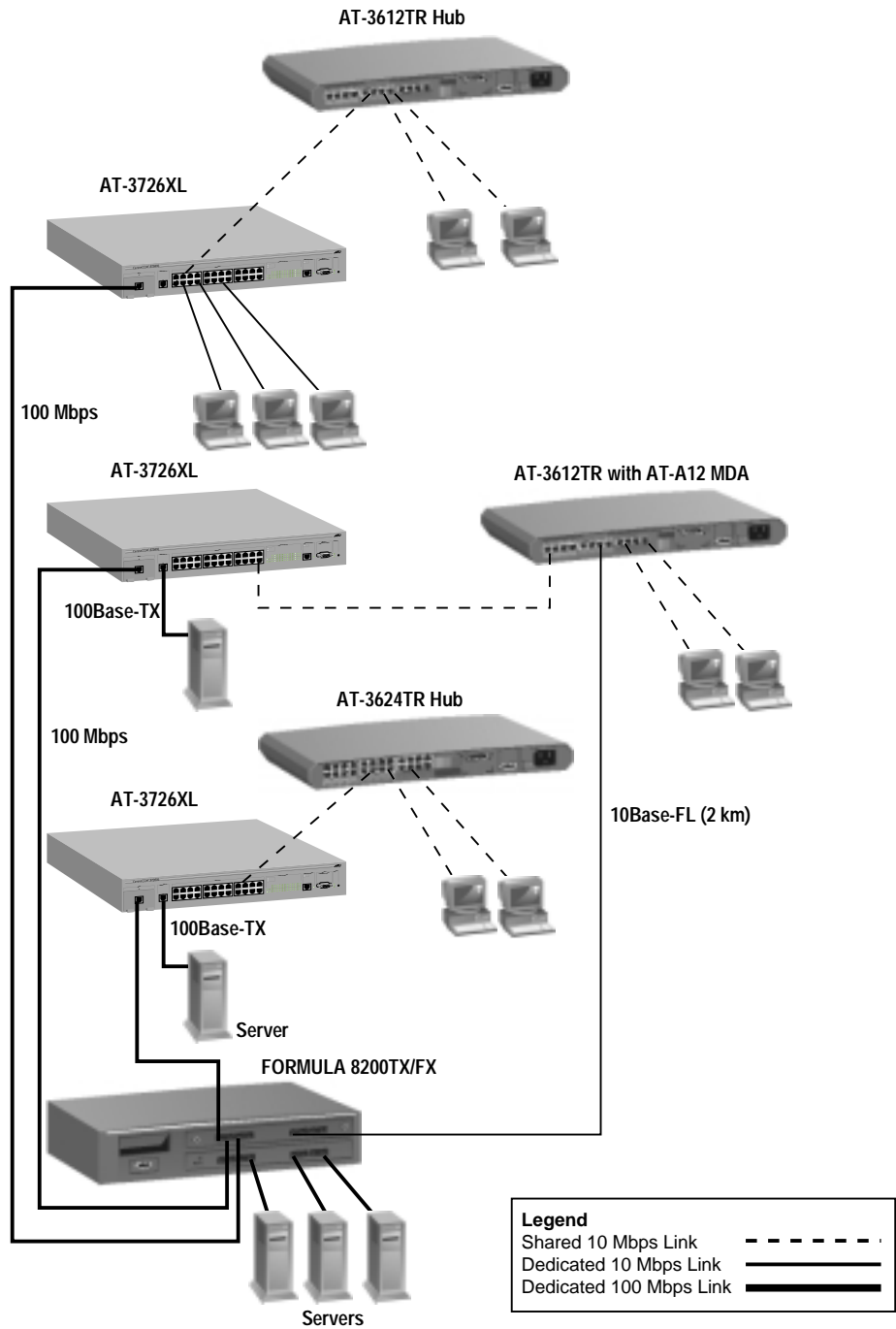

Figure 4-3 AT-3726XL Switch in Department Configuration

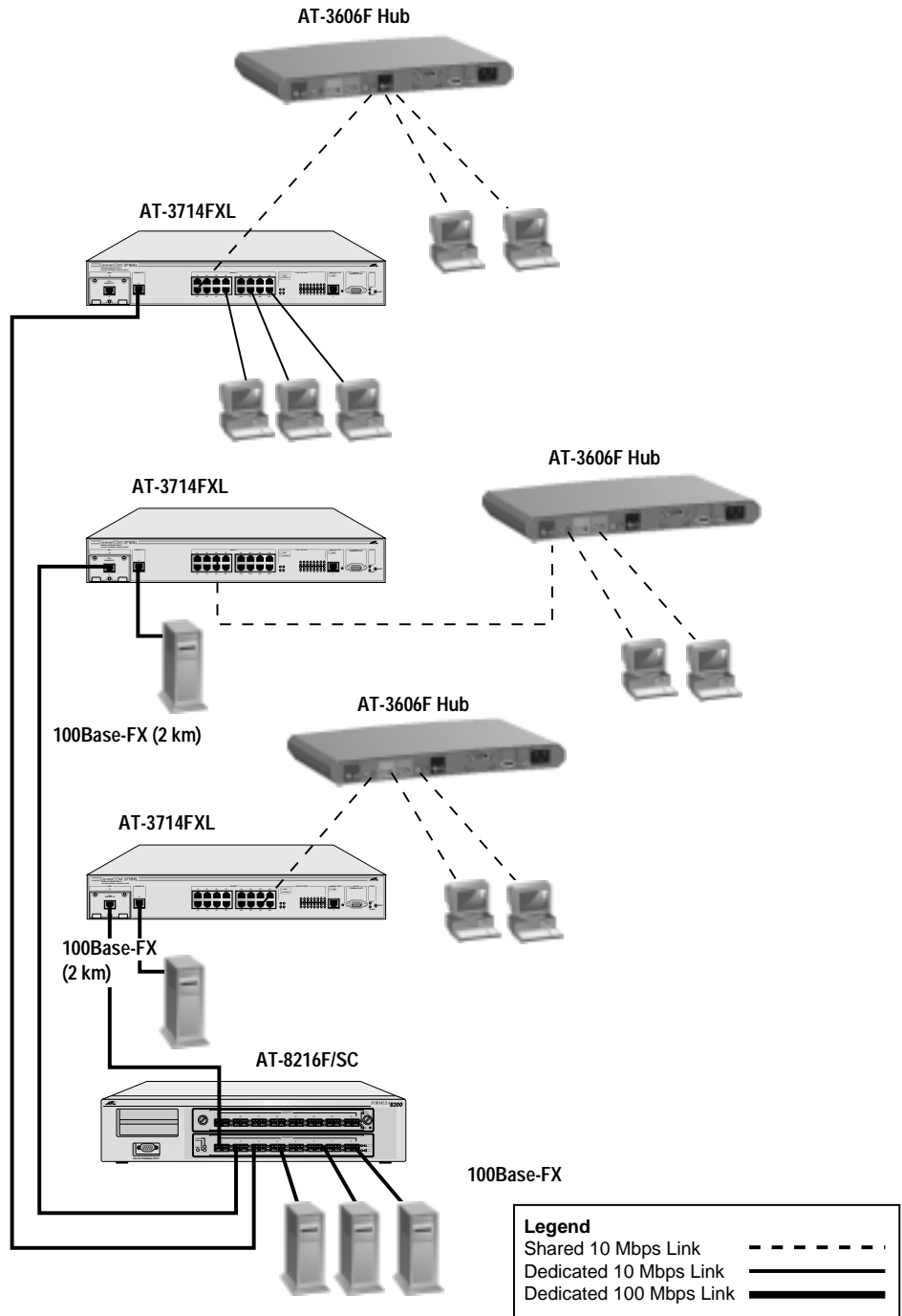

Figure 4-4 AT-3714FXL Switch in Department Configuration

Appendix A

Translated Safety Information

IMPORTANT: This appendix contains multiple-language translations for the safety statements in this guide

WICHTIG: Dieser Anhang enthält Übersetzungen der in diesem Handbuch enthaltenen Sicherheitshinweise in mehreren Sprachen.

VIGTIG: Dette tillæg indeholder oversættelser i flere sprog af sikkerhedsadvarselne i denne håndbog.

BELANGRIJK: Deze appendix bevat vertalingen in meerdere talen van de veiligheidsopmerkingen in deze gids.

IMPORTANT: Cette annexe contient la traduction en plusieurs langues des instructions de sécurité figurant dans ce guide.

TÄRKEÄÄ: Tämä liite sisältää tässä oppaassa esiintyvät turvaohjeet usealla kielellä.





























IMPORTANTE: questa appendice contiene traduzioni in più lingue degli avvisi di sicurezza di questa guida.























VIKTIG: Dette tillegget inneholder oversettelser til flere språk av sikkerhetsinformasjonen i denne veiledningen.

IMPORTANTE: Este anexo contém traduções em vários idiomas das advertências de segurança neste guia.

IMPORTANTE: Este apéndice contiene traducciones en múltiples idiomas de los mensajes de seguridad incluidos en esta guía.

OBS! Denna bilaga innehåller flerspråkiga översättningar av säkerhetsmeddelandena i denna handledning.

	1a	RFI Emission	EN55022 Class A (AT-3726XL, AT-3716XL)
	1b	RFI Emission	EN55022 Class B (AT-3714FXL)
	2	Immunity	EN50082-1 (includes all switches)
	3	WARNING: In a domestic environment this product may cause radio interference in which case the user may be required to take adequate measures.	
	4	Electrical Safety	TUV-EN60950, UL1950, CSA 950
	5	 Laser	EN60825
		At time of installation the Fiber Optic Lasers comply with FDA Radiation Performance Standard 21CFR Subchapter J, applicable at date of manufacture.	
	6	Warning Class 1 Laser product.	
	7	Warning Do not stare into the Laser beam.	
	8	 ELECTRICAL NOTICES WARNING: ELECTRIC SHOCK HAZARD To prevent ELECTRIC shock, do not remove cover. No user-serviceable parts inside. This unit contains HAZARDOUS VOLTAGES and should only be opened by a trained and qualified technician. To avoid the possibility of ELECTRIC SHOCK disconnect electric power to the product before connecting or disconnecting the LAN cables.	
	9	LIGHTNING DANGER DANGER: DO NOT WORK on equipment or CABLES during periods of LIGHTNING ACTIVITY.	
	10	CAUTION: POWER CORD IS USED AS A DISCONNECTION DEVICE. TO DE-ENERGISE EQUIPMENT disconnect the power cord.	
		ELECTRICAL—AUTO VOLTAGE ADJUSTMENT This product will automatically adjust to any voltage between the ranges shown on the label.	
	11	ELECTRICAL—TYPE CLASS 1 EQUIPMENT THIS EQUIPMENT MUST BE EARTHED. Power plug must be connected to a properly wired earth ground socket outlet. An improperly wired socket outlet could place hazardous voltages on accessible metal parts.	
	12	ELECTRICAL—CORD NOTICE Use power cord, maximum 4.5 meters long, rated 5 amp minimum, 250V, made of <HAR> cordage molded IEC 320 connector on one end and on the other end a plug approved by the country of end use. WARNING: Only use installed products in the HORIZONTAL position. DO NOT USE VERTICALLY.	
	13	CAUTION: Air vents must not be blocked and must have free access to the room ambient air for cooling.	
	14	OPERATING TEMPERATURE This product is designed for a maximum ambient temperature of 40 degrees C.	
	15	All Countries: Install product in accordance with local and National Electrical Codes.	
<hr/>			
	1a	Hochfrequenzstörung	EN55022 Klasse A (AT-3726XL, AT-3716XL)
	1b	Hochfrequenzstörung	EN55022 Klasse B (AT-3714FXL)
	2	Störsicherheit	EN50082-1 (includes all switches)
	3	WARNUNG: Bei Verwendung zu Hause kann dieses Produkt Funkstörungen hervorrufen. In diesem Fall müßte der Anwender angemessene Gegenmaßnahmen ergreifen.	
	4	Elektrische Sicherheit	TUV-EN60950, UL1950, CSA 950
	5	 Laser	EN60825
	6	WARNUNG Laserprodukt der Klasse 1.	
	7	WARNUNG Nicht direkt in den Strahl blicken.	
	8	 ACHTUNG: GEFÄHRLICHE SPANNUNG Das Gehäuse nicht öffnen. Das Gerät enthält keine vom Benutzer wartbaren Teile. Das Gerät steht unter Hochspannung und darf nur von qualifiziertem technischem Personal geöffnet werden. Vor Anschluß der LAN-Kabel, Gerät vom Netz trennen.	

-  **9** **GEFAHR DURCH BLITZSCHLAG**
GEFAHR: Keine Arbeiten am Gerät oder an den Kabeln während eines Gewitters ausführen.
-  **10** **VORSICHT: DAS NETZKABEL DIENST ZUM TRENNEN DER STROMVERSORGUNG. ZUR TRENNUNG VOM NETZ, KABEL AUS DER STECKDOSE ZIEHEN.**
- AUTOMATISCHE SPANNUNGSEINSTELLUNG**
Dieses Gerät stellt sich automatisch auf die auf dem Etikett aufgeführten Spannungswerte ein.
-  **11** **GERÄTE DER KLASSE 1**
DIESE GERÄTE MÜSSEN GEERDET SEIN. Der Netzstecker darf nur mit einer vorschriftsmäßig geerdeten Steckdose verbunden werden. Ein unvorschriftsmäßiger Anschluß kann die Metallteile des Gehäuses unter gefährliche elektrische Spannungen setzen.
-  **12** **NETZKABEL**
Das Netzkabel sollte eine maximale Länge von 4,5 Metern, einen Nennwert von mindestens 5 A und 250 V haben, aus HAR-Material hergestellt und mit einer gepreßten, IEC32 entsprechenden, Anschlußverbindung an einem Ende, und am anderen Ende mit einem im Land des Endverbrauchers geprüften Stecker ausgestattet sein.
- WARNUNG:** Die installierten Produkte dürfen nur in HORIZONTALER Position betrieben werden. NICHT IN VERTIKALER POSITION BETREIBEN.
-  **13** **VORSICHT**
Die Entlüftungsöffnungen dürfen nicht versperrt sein und müssen zum Kühlen freien Zugang zur Raumluft haben.
-  **14** **BETRIEBSTEMPERATUR**
Dieses Produkt wurde für den Betrieb in einer Umgebungstemperatur von nicht mehr als 40° C entworfen.
-  **15** **ALLE LÄNDER:** Installation muß örtlichen und nationalen elektrischen Vorschriften entsprechen.
-
-  **1a** Radiofrequenz forstyrrelsesemission EN55022 Klasse A (AT-3726XL, AT-3716XL)
-  **1b** Radiofrequenz forstyrrelsesemission EN55022 Klasse B (AT-3714FXL)
-  **2** Immunitet EN50082-1
-  **3** **ADVARSEL:** I et hjemligt miljø kunne dette produkt forårsage radio forstyrrelse. Bliver det tilfældet, påkræves brugeren muligvis at tage tilstrækkelige foranstaltninger.
-  **4** Elektrisk sikkerhed TUV-EN60950, UL1950, CSA 950
-  **5**  Laser EN60825
-  **6** **ADVARSEL** Laserprodukt av klasse 1.
-  **7** **ADVARSEL** Stirr ikke på strålen.
-  **8**  **ELEKTRISKE FORHOLDSREGLER**
ADVARSEL: RISIKO FOR ELEKTRISK STØD
For at forebygge ELEKTRISK stød, undlad at åbne apparatet. Der er ingen indre dele, der kan repareres af brugeren. Denne enhed indeholder LIVSFARLIGE STRØMSPÆNDINGER og bør kun åbnes af en uddannet og kvalificeret tekniker. For at undgå risiko for ELEKTRISK STØD, afbrydes den elektriske strøm til produktet, før LAN-kablerne monteres eller afmonteres.
-  **9** **FARE UNDER UVEJR**
FARE: UNDLAD at arbejde på udstyr eller KABLER i perioder med LYNAKTIVITET.
-  **10** **ADVARSEL: DEN STRØMFØRENDE LEDNING BRUGES TIL AT AFBRYDE STRØMMEN. SKAL STRØMMEN TIL APPARATET AFBRYDES, tages ledningen ud af stikket.**
- ELEKTRISK—AUTOMATISK SPÆNDINGSREGULERING**
Dette apparat vil automatisk tilpasse sig enhver spænding indenfor de værdier, der er angivet på etiketten.
-  **11** **ELEKTRISK—KLASSE 1-UDSTYR**
DETTE UDSTYR KRÆVER JORDFORBINDELSE. Stikket skal være forbundet med en korrekt installeret jordforbunden stikkontakt. En ukorrekt installeret stikkontakt kan sætte livsfarlig spænding til tilgængelige metaldele.
-  **12** **ELEKTRISK—LEDNING**
Anvend ledning af maksimum 4,5 meters længde, med en kapacitet på minimum 5 amp., 250 v, bestående af en IEC 320 connector med indstøbt <HAR> ledning i den ene ende og et stik i den anden ende, der er godkendt af myndighederne i brugerlandet.

ADVARSEL: Betjen kun de installerede produkter i den HORIZONTAL position (vandret).
BETJEN DEM IKKE I DEN VERTIKALE POSITION (lodret).

 **13** **ADVARSEL:** Ventilationsåbninger må ikke blokeres og skal have fri adgang til den omgivende luft i rummet for afkøling.

 **14** **BETJENINGSTEMPERATUR**
Dette apparat er konstrueret til en omgivende temperatur på maksimum 40 grader C.

 **15** **ALLE LANDE:** Installation af produktet skal ske i overensstemmelse med lokal og national lovgivning for elektriske installationer.

 **1a** RFI Emissie EN55022 Klasse A (AT-3726XL, AT-3716XL)

 **1b** RFI Emissie EN55022 Klasse B (AT-3714FXL)

 **2** Immunitet EN50082-1

 **3** **WAARSCHUWING:** Binnenshuis kan dit product radiostoring veroorzaken, in welk geval de gebruiker verplicht kan worden om gepaste maatregelen te nemen.

 **4** Elektrische Veiligheid TUV-EN60950, UL1950, CSA 950

 **5**  Laser EN60825

 **6** **WAARSCHUWING** Klasse-1 laser produkt.

 **7** **WAARSCHUWING** Niet in de straal staren.

 **8**  **WAARSCHUWINGEN MET BETREKKING TOT ELEKTRICITEIT**
WAARSCHUWING: GEVAAR VOOR ELEKTRISCHE SCHOKKEN
Verwijder het deksel niet, teneinde ELEKTRISCHE schokken te voorkomen. Binnenin bevinden zich geen onderdelen die door de gebruiker onderhouden kunnen worden. Dit toestel staat onder GEVAARLIJKE SPANNING en mag alleen worden geopend door een daartoe opgeleide en bevoegde technicus. Om het gevaar op ELEKTRISCHE SCHOKKEN te vermijden, moet u het toestel van de stroombron ontkoppelen alvorens de LAN-kabels te koppelen of ontkoppelen.

 **9** **GEVAAR VOOR BLIKSEMINSLAG**
GEVAAR: NIET aan toestellen of KABELS WERKEN bij BLIKSEM.

 **10** **WAARSCHUWING:** HET TOESTEL WORDT UITGESCHAKELD DOOR DE STROOMKABEL TE ONTKOPPELEN. OM HET TOESTEL STROOMLOOS TE MAKEN: de stroomkabel ontkoppelen.

ELEKTRISCH: AUTOMATISCHE AANPASSING VAN DESPANNING
Dit toestel past zich automatisch aan elke spanning aan, tussen de op het label vermelde waarden.

 **11** **ELEKTRISCHE TOESTELLEN VAN KLASSE 1**
DIT TOESTEL MOET GEAARD WORDEN. De stekker moet aangesloten zijn op een juist gearde contactdoos. Een onjuist gearde contactdoos kan de metalen onderdelen waarmee de gebruiker eventueel in aanraking komt onder gevaarlijke spanning stellen.

 **12** **ELEKTRISCHE SNOEREN**
Gebruik een elektrisch snoer, maximum 4,5 meter lang, berekend voor ten minste 5 ampère, 250V, uit HAR vervaardigd, met aan het ene uiteinde een gevormd IEC 320 aansluitstuk en aan het andere uiteinde een stekker die goedgekeurd is door het land waar het toestel gebruikt zal worden.

WAARSCHUWING: Gebruik de geïnstalleerde producten slechts in HORIZONTAL stand.
GEBRUIK ZE NIET VERTICAAL.

 **13** **OPGELET:** De ventilatiegaten mogen niet worden gesperd en moeten de omgevingslucht ongehinderd toelaten voor afkøling.

 **14** **BEDRIJFSTEMPERATUUR**
De omgevingstemperatuur voor dit produkt mag niet meer bedragen dan 40 graden Celsius.

 **15** **ALLE LANDE:** het toestel installeren overeenkomstig de lokale en nationale elektrische voorschriften.



























 **1a** Emission d'interférences radioélectriques EN55022 Classe A (AT-3726XL, AT-3716XL)

 **1b** Emission d'interférences radioélectriques EN55022 Classe B (AT-3714FXL)

 **2** Immunité EN50082 - 1

 **3** **MISE EN GARDE:** dans un environnement domestique, ce produit peut provoquer des interférences radioélectriques. Auquel cas, l'utilisateur devra prendre les mesures adéquates.

 **4** Sécurité électrique TUV-EN60950, UL1950, CSA 950

-  **5**  Laser EN60825
-  **6** **ATTENTION** Produit laser di classe 1.
-  **7** **ATTENTION** Ne pas fixer le faisceau des yeux.
-  **8**  **INFORMATION SUR LES RISQUES ÉLECTRIQUES**
AVERTISSEMENT : DANGER D'ÉLECTROCUTION
Pour éviter toute ÉLECTROCUTION, ne pas ôter le revêtement protecteur du matériel. Ce matériel ne contient aucun élément réparable par l'utilisateur. Il comprend des TENSIONS DANGEREUSES et ne doit être ouvert que par un technicien dûment qualifié. Pour éviter tout risque d'ÉLECTROCUTION, débrancher le matériel avant de connecter ou de déconnecter les câbles LAN.
-  **9** **DANGER DE Foudre**
DANGER: NE PAS MANIER le matériel ou les CÂBLES lors d'activité orageuse.
-  **10** **ATTENTION: LE CORDON D'ALIMENTATION SERT DE MISE HORS CIRCUIT. POUR COUPER L'ALIMENTATION DU MATÉRIEL, débrancher le cordon.**
- RÉGLAGE DE TENSION AUTOMATIQUE ÉLECTRIQUE**
Ce matériel peut s'ajuster automatiquement sur n'importe quelle tension comprise dans la plage indiquée sur l'étiquette.
-  **11** **ÉQUIPEMENT DE CLASSE 1 ÉLECTRIQUE**
CE MATÉRIEL DOIT ÊTRE MIS A LA TERRE. La prise de courant doit être branchée dans une prise femelle correctement mise à la terre car des tensions dangereuses risqueraient d'atteindre les pièces métalliques accessibles à l'utilisateur.
-  **12** **INFORMATION SUR LE CORDON ÉLECTRIQUE**
Utiliser un cordon secteur de 4.5 mètres de long maximum, calibré à 5 ampères minimum, 250V, fabriqué en câblage <HAR> avec connecteur IEC 32C moulé à une extrémité, et à l'autre extrémité, une prise de courant mâle répondant aux normes du pays d'utilisation.
- AVERTISSEMENT** : utiliser uniquement le matériel installé en position HORIZONTALE. NE PAS UTILISER EN POSITION VERTICALE.
-  **13** **ATTENTION:** Ne pas bloquer les fentes d'aération, ceci empêcherait l'air ambiant de circuler librement pour le refroidissement.
-  **14** **TEMPÉRATURE DE FONCTIONNEMENT**
Ce matériel est capable de tolérer une température ambiante maximum de 40 degrés Celsius.
-  **15** **POUR TOUS PAYS:** Installer le matériel conformément aux normes électriques nationales e locales.
-
-  **1a** Radioaaltojen häirintä EN55022 Luokka A (AT-3726XL, AT-3716XL)
-  **1b** Radioaaltojen häirintä EN55022 Luokka B (AT-3714FXL)
-  **2** Kestävyys EN50082-1
-  **3** **VAROITUS:** Kotiolosuhteissa tämä laite voi aiheuttaa radioaaltojen häirintä, missä tapauksessa laitteen käyttäjän on mahdollisesti ryhdyttävä tarpeellisiin toimenpiteisiin.
-  **4** Sähköturvallisuus TUV-EN60950, UL1950, CSA 950
-  **5**  Laser EN60825
-  **6**  **VAROITUS** Luokan 1 Lasertuote.
-  **7** **VAROITUS** Älä katso säteeseen.
-  **8**  **SÄHKÖÖN LIITTYVIÄ HUOMAUTUKSIA**
VAROITUS: SÄHKÖISKUVAARA
Estääksesi SÄHKÖISKUN älä poista kantta. Sisällä ei ole käyttäjän huollettavissa olevia osia. Tämä laite sisältää VAARALLISIA JÄNNITTEITÄ ja sen voi avata vain koulutettu ja pätevä teknikko. Välttääksesi SÄHKÖISKUN mahdollisuuden katkaise sähkövirta tuotteeseen ennen kuin liität tai irrotat paikallisverkon (LAN) kaapelit.
-  **9** **SALAMANISKUVAARA**
HENGENVAARA: ÄLÄ TYÖSKENTELE laitteiden tai KAAPELEIDEN KANSSA SALAMOINNIN AIKANA.
-  **10** **HUOMAUTUS:** VIRTAJOHTOA KÄYTETÄÄN VIRRANKATKAISULAITTEENA. VIRTA KATKAISTAAN irrottamalla virtajohto.

SÄHKÖ—AUTOMAATTINEN JÄNNITTEENSÄÄTÖ

Tämä tuote säättää automaattisesti mihin tahansa jännitteeseen ohjetarrassa annettujen arvojen välillä.

 11

SÄHKÖ—TYYPPILUOKAN 1 LAITTEET

TÄMÄ LAITE TÄYTY MAADOITTA. Pistoke täytyy liittää kunnollisesti maadoitettuun pistorasiaan. Virheellisesti johdotettu pistorasia voi altistaa metalliosat vaarallisille jännitteille.

 12

SÄHKÖ—JOHTOON LIITTYVÄ HUOMAUTUS

Käytä seuraavanlaista virtajohtoa: maksimipituus 4,5 metriä, minimito 5 ampeeria, 250 V, valmistettu <HAR> -johdostosta, muovattu IEC 320 -liitin toisessa päässä ja käyttömaassa hyväksytty pistoke toisessa päässä.

VAROITUS: Asennettuja tuotteita saa ainoastaan käyttää VAAKA-asennossa. PYSTYASENNUSTA EI SAA TEHDÄ.

 13

HUOMAUTUS: Ilmavaihtoreikiä ei pidä tukkia ja niillä täytyy olla vapaa yhteys ympäröivään huoneilmaan, jotta ilmanvaihto tapahtuisi.

 14

KÄYTTÖLÄMPÖTILA

Tämä tuote on suunniteltu ympäröivän ilman maksimilämpötilalle 40° C.

 15

KAIKKI MAAT: Asenna tuote paikallisten ja kansallisten sähköturvallisuusmääräysten mukaisesti.

 1a

Emissione RFI (interferenza di radiofrequenza)EN55022 ClasseA (AT-3726XL, AT-3716XL)

 1b

Emissione RFI (interferenza di radiofrequenza)EN55022 ClasseB (AT-3714FXL)

 2

Immunità EN50082-1

 3

AVVERTENZA: in ambiente domestico questo prodotto potrebbe causare radio interferenza. In questo caso potrebbe richiedersi all'utente di prendere gli adeguati provvedimenti.

 4

Sicurezza elettrica TUV-EN60950, UL1950, CSA 950

 5



Laser EN60825

 6

AVVERTENZA Prodotto laser di Classe 1.

 7

AVVERTENZA Non fissare il raggio con gli occhi.

 8

**AVVERTENZE ELETTRICHE**

ATTENZIONE: PERICOLO DI SCOSSE ELETTRICHE

Per evitare SCOSSE ELETTRICHE non asportare il coperchio. Le componenti interne non sono riparabili dall'utente. Questa unità ha TENSIONI PERICOLOSE e va aperta solamente da un tecnico specializzato e qualificato. Per evitare ogni possibilità di SCOSSE ELETTRICHE, interrompere l'alimentazione del dispositivo prima di collegare o staccare i cavi LAN.

 9

PERICOLO DI FULMINI

PERICOLO: NON LAVORARE sul dispositivo o sui CAVI durante PRECIPITAZIONI TEMPORALESCHIE.

 10

ATTENZIONE: IL CAVO DI ALIMENTAZIONE È USATO COME DISPOSITIVO DI DISATTIVAZIONE. PER TOGLIERE LA CORRENTE AL DISPOSITIVO staccare il cavo di alimentazione.

ELETTRICITÀ—REGOLAZIONE AUTOMATICA DELLA TENSIONE

Questo prodotto regolerà automaticamente la tensione ad un valore compreso nella gamma indicata sull'etichetta.

 11

ELETTRICITÀ—DISPOSITIVI DI CLASSE 1

QUESTO DISPOSITIVO DEVE AVERE LA MESSA A TERRA. La spina deve essere inserita in una presa di corrente specificamente dotata di messa a terra. Una presa non cablata in maniera corretta rischia di scaricare una tensione pericolosa su parti metalliche accessibili.

 12

ELETTRICITÀ—AVVERTENZA SUL CAVO

Usare un cavo della lunghezza massima di metri 4,5, con capacità minima di 5 A, 250 V, di filo <HAR>, dotato di connettore stampato IEC 320 ad un'estremità e di spina approvata dal paese di destinazione all'altra.

AVVERTENZA: usare i prodotti installati solo in posizione ORIZZONTALE. NON USARE VERTICALMENTE.































 13

ATTENZIONE: le prese d'aria non vanno ostruite e devono consentire il libero ricircolo dell'aria ambiente per il raffreddamento.







 14















TEMPERATURA DI FUNZIONAMENTO

Questo prodotto è concepito per una temperatura ambientale massima di 40 gradi centigradi.





	15	TUTTI I PAESI: installare il prodotto in conformità delle vigenti normative elettriche nazionali.	
<hr/>			
	1a	RFI stråling	EN55022 Klasse A (AT-3726XL, AT-3716XL)
	1b	RFI stråling	EN55022 Klasse B (AT-3714FXL)
	2	Immunitet	EN50082-1
	3	ADVARSEL: Hvis dette produktet benyttes til privat bruk, kan produktet forårsake radioforstyrrelse. Hvis dette skjer, må brukeren ta de nødvendige forholdsregler.	
	4	Elektrisk sikkerhet	TUV-EN60950, UL1950, CSA 950
	5	 Laser	EN60825
	6	ADVARSEL Laserprodukt av klasse 1.	
	7	ADVARSEL Stirr ikke på strålen.	
	8	 ELEKTRISITET ADVARSEL: FARE FOR ELEKTRISK SJOKK For å unngå ELEKTRISK sjokk, må dekslet ikke tas av. Det finnes ingen deler som brukeren kan reparere på innsiden. Denne enheten inneholder FARLIGE SPENNINGER, og må kun åpnes av en faglig kvalifisert tekniker. For å unngå ELEKTRISK SJOKK må den elektriske strømmen til produktet være avslått før LAN-kablene til- eller frakobles.	
	9	FARE FOR LYNNEDSLAG FARE: ARBEID IKKE på utstyr eller KABLER i TORDENVÆR.	
	10	FORSIKTIG: STRØMLEDNINGEN BRUKES TIL Å FRAKOBLE UTSTYRET. FOR Å DEAKTIVISERE UTSTYRET, må strømforsyningen kobles fra. ELEKTRISK—AUTO SPENNINGSTILPASNING Dette produktet vil automatisk bli tilpasset hvilken som helst strømspenning i de områdene som vises på etiketten.	
	11	ELEKTRISK—TYPE 1- KLASSE UTSTYR DETTE UTSTYRET MÅ JORDES. Strømkontakten må være tilkopleet en korrekt jordet kontakt. En kontakt som ikke er korrekt jordet kan føre til farlig spenninger i lett t ilgjengelige metalldeleer.	
	12	ELEKTRISK—MEDELELSE OM LEDNINGER Bruk en strømledning av maksimalt 4.5 m. i lengde, godkjent for minst av 5 amp, 250V, fremstilt av <HAR> ledning IEC 320 koplingsstykke i den ene enden, og i den andre enden en plugg som er blitt godkjent i brukerlandet. ADVARSEL: Installerte produkter må bare benyttes i HORIZONTAL posisjon. MÅ IKKE BENYTTES VERTIKALT.	
	13	FORSIKTIG: Lufteventilene må ikke blokkeres, og må ha fri tilgang til luft med romtemperatur for avkjøling.	
	14	DRIFTSTEMPERATUR Dette produktet er konstruert for bruk i maksimum romtemperatur på 40 grader celsius.	
	15	ALLE LAND: Produktet må installeres i samsvar med de lokale og nasjonale elektriske koder.	
<hr/>			
	1a	Emissão de interferência de radiofrequência	EN55022 Classe A(AT-3726XL, AT-3716XL)
	1b	Emissão de interferência de radiofrequência	EN55022 Classe B(AT-3714FXL)
	2	Imunidade	EN50082-1
	3	AVISO: Num ambiente doméstico este produto pode causar interferência na radorrecepção e, neste caso, pode ser necessário que o utente tome as medidas adequadas.	
	4	Segurança Eléctrica	TUV-EN60950, UL1950, CSA 950
	5	 Laser	EN60825
	6	AVISO Produto laser de classe 1	
	7	AVISO Não olhe fixamente para o raio.	
	8	 AVISOS SOBRE CARACTERÍSTICAS ELÉTRICAS ATENÇÃO: PERIGO DE CHOQUE ELÉTRICO Para evitar CHOQUE ELÉTRICO, não retire a tampa. Não contém peças que possam ser consertadas pelo usuário. Este aparelho contém VOLTAGENS PERIGOSAS e só deve ser aberto por um técnico qualificado e treinado. Para evitar a possibilidade de CHOQUE	



















ELÉTRICO, desconecte o aparelho da fonte de energia elétrica antes de conectar e desconectar os cabos da LAN.

-  **9 PERIGO DE CHOQUE CAUSADO POR RAI0**
PERIGO: NÃO TRABALHE no equipamento ou nos CABOS durante períodos suscetíveis a QUEDAS DE RAI0.
-  **10 CUIDADO:** O CABO DE ALIMENTAÇÃO É UTILIZADO COMO UM DISPOSITIVO DE DESCONEXÃO. PARA DESELETRIFICAR O EQUIPAMENTO, desconecte o cabo de ALIMENTAÇÃO.
- ELÉTRICO—AJUSTE AUTOMÁTICO DE VOLTAGEM**
Este produto ajustar-se-á automaticamente a qualquer voltagem que esteja dentro dos limites indicados no rótulo.
-  **11 ELÉTRICO—EQUIPAMENTOS DO TIPO CLASSE 1**
DEVE SER FEITA LIGAÇÃO DE FIO TERRA PARA ESTE EQUIPAMENTO. O plugue de alimentação deve ser conectado a uma tomada com adequada ligação de fio terra. Tomadas sem adequada ligação de fio terra podem transmitir voltagens perigosas a peças metálicas expostas.
-  **12 ELÉTRICO—AVISO SOBRE O CABO DE ALIMENTAÇÃO**
Use cabo de alimentação com comprimento máximo de 4,5 metros, com uma capacidade indicada mínima de 5 amp e 250 V, fabricado de material para cabo <HAR> com conector moldado IEC 320 em uma extremidade e, na outra extremidade, um plugue aprovado para uso no país em questão.
- CUIDADO!:** Use os produtos instalados na posição HORIZONTAL. NÃO OS USE VERTICALMENTE.
-  **13 CUIDADO:** As aberturas de ventilação não devem ser bloqueadas e devem ter acesso livre ao ar ambiente para arrefecimento adequado do aparelho.
-  **14 TEMPERATURA DE FUNCIONAMENTO**
Este produto foi projetado para uma temperatura ambiente máxima de 40 graus centígrados.
-  **15 TODOS OS PAÍSES:** Instale o produto de acordo com as normas nacionais e locais para instalações elétricas.

 1a	Emisión RFI	EN55022 Clase A (AT-3726XL, AT-3716XL)
 1b	Emisión RFI	EN55022 Clase B (AT-3714FXL)
 2	Inmunidad	EN50082-1
 3	ADVERTENCIA: en un entorno doméstico, este producto puede causar radiointerferencias, en cuyo caso, puede requerirse del usuario que tome las medidas que sean convenientes al respecto.	
 4	Seguridad eléctrica	TUV-EN60950, UL1950, CSA 950
 5	 Laser	EN60825
 6	¡ADVERTENCIA! Producto láser Clase 1.	
 7	¡ADVERTENCIA! No mirat fijamente el haz.	
 8	 AVISOS ELECTRICOS ADVERTENCIA: PELIGRO DE ELECTROCHOQUE	Para evitar un ELECTROCHOQUE, no quite la tapa. No hay ningún componente en el interior al cual puede prestar servicio el usuario. Esta unidad contiene VOLTAJES PELIGROSOS y sólo deberá abrirla un técnico entrenado y calificado. Para evitar la posibilidad de ELECTROCHOQUE desconecte la corriente eléctrica que llega al producto antes de conectar o desconectar los cables LAN.
 9	PELIGRO DE RAYOS	PELIGRO: NO REALICE NINGUN TIPO DE TRABAJO O CONEXION en los equipos o en LOS CABLES durante TORMENTAS ELECTRICAS.
 10	ATENCION: EL CABLE DE ALIMENTACION SE USA COMO UN DISPOSITIVO DE DESCONEXION. PARA DESACTIVAR EL EQUIPO, desconecte el cable de alimentación.	ELECTRICO—AUTO-AJUSTE DE TENSION Este producto se ajustará automáticamente a cualquier tensión entre los valores máximos y mínimos indicados en la etiqueta.
 11	ELECTRICO—EQUIPO DEL TIPO CLASE 1	ESTE EQUIPO TIENE QUE TENER CONEXION A TIERRA. El cable tiene que conectarse a un

enchufe a tierra debidamente instalado. Un enchufe que no está correctamente instalado podría ocasionar tensiones peligrosas en las partes metálicas que están expuestas.

-  **12** **ELECTRICO—ADVERTENCIA SOBRE EL CABLE**
Use un cable eléctrico con un máximo de 4,5 metros de largo, con una capacidad mínima de 5 amperios, 250 V, hecho de cable <HAR>, con el conector moldeado IEC 320 en un extremo y con un enchufe que está aprobado por el país de uso final en el otro.
- ADVERTENCIA:** Usar únicamente los productos instalados en posición HORIZONTAL. NO USARLOS EN POSICIÓN VERTICAL.
-  **13** **ATENCIÓN:** Las aberturas para ventilación no deberán bloquearse y deberán tener acceso libre al aire ambiental de la sala para su enfriamiento.
-  **14** **TEMPERATURA REQUERIDA PARA LA OPERACIÓN**
Este producto está diseñado para una temperatura ambiental máxima de 40 grados C.
-  **15** **PARA TODOS LOS PAÍSES:** Monte el producto de acuerdo con los Códigos Eléctricos locales y nacionales.

-
-  **1a** Radiostörning EN55022 Klass A (AT-3726XL, AT-3716XL)
-  **1b** Radiostörning EN55022 Klass B (AT-3714FXL)
-  **2** Immunitet EN50082-1
-  **3** **WARNING:** Denna produkt kan ge upphov till radiostörningar i hemmet, vilket kan tvinga användaren till att vidtaga erforderliga åtgärder.
-  **4** Elsäkerhet TUV-EN60950, UL1950, CSA 950
-  **5**  Laser EN60825
-  **6** **WARNING!** Laserprodukt av klass 1.
-  **7** **WARNING!** Laserstrålning när enheten är öppen.
-  **8**  **TILLKÄNNAGIVANDEN BETRÄFFANDE ELEKTRICITETSRIK:**
RISK FÖR ELEKTRISK STÖTFör att undvika ELEKTRISK stöt, ta ej av locket. Det finns inga delar inuti som behöver underhållas. Denna apparat är under HÖGSPÄNNING och får endast öppnas av en utbildad kvalificerad tekniker. För att undvika ELEKTRISKSTÖT, koppla ifrån produktens strömanslutning innan LAN-kablarna ansluts eller kopplas ur.
-  **9** **FARA FÖR BLIXTNEDSLAG**
FARA: ARBETA EJ på utrustningen eller kablarna vid ÅSKVÄDER.
-  **10** **WARNING:** NÄTKABELN ANVÄNDS SOM STRÖMBRYTARE FÖR ATT KOPPLA FRÅN STRÖMMEN, dra ur nätkabeln.
- ELEKTRISKT—AUTOMATISK SPÄNNINGSJUSTERING**
Denna produkt justeras automatiskt till alla spänningar inom omfånget som indikeras på produktens märkning.
-  **11** **ELEKTRISKT—TYP KLASS 1 UTRUSTNING**
DENNA UTRUSTNING MÅSTEVARA JORDAD. Nätkabeln måste vara ansluten till ett ordentligt jordat uttag. Ett felaktigt uttag kan göra att närliggande metalldelar utsätts för högspänning. Apparaten skall anslutas till jordat uttag, när den ansluts till ett nätverk.
-  **12** **ELEKTRISKT—ANMÄRKNING BETRÄFFANDE KABELN**
Använd en kabel med maximum längd 4,5 meter och minimum 5 amp nominal, 250V, av <HAR> kabelfabrikat med ett specialutformat IEC 320-kontaktidon i ena änden och i den andra en plugg som godkänts i landet där produkten används.
- WARNING:** Den installerade produkten bör endast användas i HORIZONTALÄGGE. FÅR INTE ANVÄNDAS VERTIKALT.
-  **13** **WARNING:** Luftventilerna får ej blockeras och måste ha fri tillgång till omgivande rumsluft för avsvälvning.
-  **14** **DRIFTTEMPERATUR**
Denna produkt är konstruerad för rumstemperatur ej överstigande 40 grader Celsius.
-  **15** **ALLA LÄNDER:** Installera produkten i enlighet med lokala och statliga bestämmelser för elektrisk utrustning.

Appendix B

Technical Specifications

Table B-1 lists the technical specifications for the AT-3726XL, AT-3716XL, and AT-3714FXL Switch.

Table B-3 AT-3726XL, AT-3716XL, and AT-3714FXL Technical Specifications

Physical Specifications			
	Dimensions (H x W x D)	Weight	
Base unit (fully loaded)	2.5 in x 17.33 in x 12.60 in (6.35 cm x 44.02 cm x 32.00 cm)	10 lbs, 13 oz (4.9 kg)	
Required ventilation on all sides	7.5 in (191 mm)		
Environmental Specifications			
Operating temperature	32° to 104° F (0° C to 40° C)		
Storage temperature	-4° to 167° F (-20° C to 75° C)		
Operating humidity	5% to 95% non-condensing		
Operating altitude range	up to 9,843 ft (3,000 m)		
Power Specifications			
Maximum power consumption	100 W		
AC input voltage	100-120/200-240VAC~ +6% -10% (autoranging)		
Frequency	50/60 Hz ± 3 cycles of nominal input frequency		
Safety and Electromagnetic Emissions Certifications			
Safety: UL 1950	CSA 22.2 No. 950	TUV EN 60950 EN60825	
EMI			
AT-3726XL	FCC Class A	EN55022 Class A	VCCI Class A
AT-3716XL	FCC Class A	EN55022 Class A	VCCI Class A
AT-3714FXL	FCC Class B	EN55022 Class B	VCCI Class B
Immunity: EN50082-1	Quality and Reliability: MTBF > 50,000 hrs	MTTR < 1/2 hr DOA < 1%	

Table B-2 RJ45 Pin Assignments

Pin Number	Function
1	RD+
2	RD-
3	TD+
4	Unused
5	Unused
6	TD-
7	Unused
8	Unused

Media Dependent Adapter Cabling Distances

Table B-3 lists the maximum cable distances for the AT-3726XL, AT-3716XL, and AT-3714FXL switch Media Dependent Adapter (MDA).

Table B-3 MDA Maximum Cable Distances

MDA	Ethernet Type	Maximum Distance
AT-A10	RJ45 (10/100Base)	330 ft (100 m), twisted pair Category 5 UTP
AT-A11	SC (100Base)	1.25 mi (2 km) for full-duplex, 1351 ft (412 m) for half-duplex 50/125 and 62.5/125 micron multimode fiber cable
AT-A20	Fiber MT-RJ (100Base)	1.25 mi (2 km) for full-duplex, 1351 ft (412 m) for half-duplex 50/125 and 62.5/125 micron multimode fiber cable
AT-A21	Fiber VF-45 (100Base)	1.25 mi (2 km) for full-duplex, 1351 ft (412 m) for half-duplex 50/125 and 62.5/125 micron multimode fiber cable

Index

Numerics

- 1.5 Rack Unit 2-1
- 19-inch rack 2-1

A

- auto-negotiation 1-4
- autoswitch AC inputs 1-8

B

- bandwidth capability 1-1

C

- conventions, document Preface-ii

D

- DB9 straight-through cable 2-7
- default settings 2-8
- desktop installation, switch, 2-4
- diagnostics 3-6
- disabled port 3-5

F

- full-duplex 1-1

I

- installation
 - site preparation, 2-3
 - switch, desktop, 2-4
- internal address lookup engine (IALE) 1-5

L

- LEDs
 - activity 2-6
 - fault 2-6
 - link 2-6
 - power 2-6
- local management setup 2-7

M

- MDA LEDs 2-12
 - activity 2-12
 - link 2-12
- media dependent adapter
 - AT-A10 1-7, 2-9, 2-10, B-2
 - AT-A11 1-7, 2-9, 2-10, B-2
 - AT-A20 1-7, 2-9, 2-10, B-2
 - AT-A21 1-7, 2-9, 2-10, B-2

- media dependent adapter (MDA) 1-1
- Microsoft Windows VTERM 1-8
- Mirror port 1-6

O

- Omega 1-5, 3-1, 3-5, 3-6
- out-of-band management 1-8

P

- preparation, site installation, 2-3

R

- redundant backbone connections 1-5
- reset button 1-8, 3-1, 3-7
- RS232 connector 1-8, 2-7, 3-7

S

- safety information, A-1
- site preparation, 2-3
- SNMP 3-7
- SNMP management information base 1-5
- SNMP trap message 3-4
- spanning tree protocol (STP) 1-5
- standalone switch 4-1
- store-and-forward 1-4, 1-5
- switch
 - desktop installation, 2-4
 - switch default settings 2-8
- Switch LEDs
 - activity 2-6, 3-4
 - fault 2-6, 3-4
 - link 2-6, 3-4
 - power 2-6, 3-4

T

- TCP/IP 3-4
- Telnet 3-7
- terminal settings 2-7
- transmit pacing 1-5

W

- worst case path delay value 3-2

