



Simply connecting the  world

AT-FS7016

AT-FS7024

Fast Ethernet Smart Switches

Installation Guide

Copyright © 2003 Allied Telesyn, Inc.
960 Stewart Drive Suite B, Sunnyvale, CA 94085, USA

All rights reserved. No part of this publication may be reproduced without prior written permission from Allied Telesyn, Inc.

Ethernet is a registered trademark of Xerox Corporation. All other product names, company names, logos or other designations mentioned herein are trademarks or registered trademarks of their respective owners.

Allied Telesyn, Inc. reserves the right to make changes in specifications and other information contained in this document without prior written notice. The information provided herein is subject to change without notice. In no event shall Allied Telesyn, Inc. be liable for any incidental, special, indirect, or consequential damages whatsoever, including but not limited to lost profits, arising out of or related to this manual or the information contained herein, even if Allied Telesyn, Inc. has been advised of, known, or should have known, the possibility of such damages.

Electrical Safety and Emissions Compliance Statement

Standards: This product meets the following standards.

U.S. Federal Communications Commission

Radiated Energy

Note: This equipment has been tested and found to comply with the limits for a Class A digital device pursuant to Part 15 of FCC Rules. These limits are designed to provide reasonable protection against harmful interference when the equipment is operated in a commercial environment. This equipment generates, uses, and can radiate radio frequency energy and, if not installed and used in accordance with this instruction manual, may cause harmful interference to radio communications. Operation of this equipment in a residential area is likely to cause harmful interference in which case the user will be required to correct the interference at his own expense.

Note: Modifications or changes not expressly approved of by the manufacturer or the FCC, can void your right to operate this equipment.

Canadian Department of Communications

This Class A digital apparatus meets all requirements of the Canadian Interference-Causing Equipment Regulations.

Cet appareil numérique de la classe A respecte toutes les exigences du Règlement sur le matériel brouilleur du Canada.

RFI Emission EN55022 Class A, EN6100-3-2,
EN6100-3-3  1

Warning: In a domestic environment this product may cause radio interference in which case the user may be required to take adequate measures.  2

Immunity EN55024  3

Electrical Safety TUV-EN60950, UL60950 (cUL_{us})  4

Important: Appendix B contains translated safety statements for installing this equipment. When you see the , go to Appendix B for the translated safety statement in your language.

Wichtig: Anhang B enthält übersetzte Sicherheitshinweise für die Installation dieses Geräts. Wenn Sie  sehen, schlagen Sie in Anhang B den übersetzten Sicherheitshinweis in Ihrer Sprache nach.

Vigtigt: Tillæg B indeholder oversatte sikkerhedsadvarsler, der vedrører installation af dette udstyr. Når De ser symbolet , skal De slå op i tillæg B og finde de oversatte sikkerhedsadvarsler i Deres eget sprog.

Belangrijk: Appendix B bevat vertaalde veiligheidsopmerkingen voor het installeren van deze apparatuur. Wanneer u de  ziet, raadpleeg Appendix B voor vertaalde veiligheidsinstructies in uw taal.

Important: L'annexe B contient les instructions de sécurité relatives à l'installation de cet équipement. Lorsque vous voyez le symbole , reportez-vous à l'annexe B pour consulter la traduction de ces instructions dans votre langue.

Tärkeää: Liite B sisältää tämän laitteen asentamiseen liittyvät käännetyt turvaohjeet. Kun näet ⚡-symbolin, katso käännettyä turvaohjetta liitteestä B.

Importante: l'Appendice B contiene avvisi di sicurezza tradotti per l'installazione di questa apparecchiatura. Il simbolo ⚡, indica di consultare l'Appendice B per l'avviso di sicurezza nella propria lingua.

Viktig: Tillegg B inneholder oversatt sikkerhetsinformasjon for installering av dette utstyret. Når du ser ⚡, åpner du til Tillegg B for å finne den oversatte sikkerhetsinformasjonen på ønsket språk.

Importante: O Anexo B contém advertências de segurança traduzidas para instalar este equipamento. Quando vir o símbolo ⚡, leia a advertência de segurança traduzida no seu idioma no Anexo B.

Importante: El Apéndice B contiene mensajes de seguridad traducidos para la instalación de este equipo. Cuando vea el símbolo ⚡, vaya al Apéndice B para ver el mensaje de seguridad traducido a su idioma.

Obs! Bilaga B innehåller översatta säkerhetsmeddelanden avseende installationen av denna utrustning. När du ser ⚡, skall du gå till Bilaga B för att läsa det översatta säkerhetsmeddelandet på ditt språk.

Table of Contents

Electrical Safety and Emissions Compliance Statement	iii
Welcome to Allied Telesyn	vii
Where to Find Web-based Guides	vii
Document Conventions	viii
Contacting Allied Telesyn	viii
Online Support	viii
E-mail and Telephone Support.....	viii
Returning Products	viii
For Sales or Corporate Information	ix
Obtaining Management Software Updates	ix
Tell Us What You Think	ix

Chapter 1

Overview	1
Key Features.....	3
Status LEDs.....	4
Port Speed.....	5
Duplex Mode	5
Auto MDI/MDI-X.....	6
RS-232 Terminal Port	6
Power Requirements	7
Network Topologies	8
Power Workgroup Topology	8
Collapsed Topology.....	9
Mixed Topology.....	10

Chapter 2

Installation	11
Verifying the Package Contents	11
Planning the Installation	12
Selecting a Site	13
Reviewing Safety Guidelines	14
Installing the Switch on a Table or Desktop.....	15
Rackmounting the Switch.....	17
Warranty Registration	19

- Chapter 3**
- Troubleshooting 21**

- Appendix A**
- Technical Specifications 23**
- Physical 23
- Environmental 23
- Electrical Rating 24
- Agency Compliance..... 24
- Pinout Assignments 25

- Appendix B**
- Translated Safety and Emission Information 27**

Welcome to Allied Telesyn

This guide contains instructions on how to install the AT-FS0716 and AT-FS0724 Fast Ethernet Smart Switches.

Where to Find Web-based Guides

The user guides for all Allied Telesyn products are available in Portable Document Format (PDF) from the Allied Telesyn web site at **www.alliedtelesyn.com**. You can view the documents online or download them onto a local workstation or server.

Once you have installed your AT-FS7016 and AT-FS7024 switch, refer to the following guide for instructions on how to manage and configure your unit:

- **AT-S67 and AT-S68 Software Management User's Guide**
PN 613-50494-00

Document Conventions

This guide uses the following conventions:

Note

Notes provide additional information.



Caution

Caution informs you that performing or omitting a specific action may result in equipment damage or loss of data.



Warning

Warnings informs you that performing or omitting a specific action may result in bodily injury.

Contacting Allied Telesyn

This section provides Allied Telesyn contact information for technical support as well as sales or corporate information.

Online Support

You can request technical support online by accessing the Allied Telesyn Knowledge Base from the following web site: **kb.alliedtelesyn.com**. You can use the Knowledge Base to submit questions to our technical support staff and review answers to previously asked questions.

E-mail and Telephone Support

For Technical Support via e-mail or telephone, refer to the “Support & Services” section of the Allied Telesyn web site: **www.alliedtelesyn.com**.

Returning Products

Products for return or repair must first be assigned a Return Materials Authorization (RMA) number. A product sent to Allied Telesyn without a RMA number will be returned to the sender at the sender’s expense.

To obtain a RMA number, contact Allied Telesyn’s Technical Support at our web site: **www.alliedtelesyn.com**

For Sales or Corporate Information

You can contact Allied Telesyn for sales or corporate information at our web site: **www.alliedtelesyn.com**. To find the contact information for your country, select “Contact Us” then “Worldwide Contacts”.

Obtaining Management Software Updates

New releases of management software for our managed products can be downloaded from either of the following Internet sites:

- Allied Telesyn web site: <http://www.alliedtelesyn.com>
- Allied Telesyn FTP server: <ftp://ftp.alliedtelesyn.com>

If you would prefer to download new software from the Allied Telesyn FTP server from your workstation’s command prompt, you will need FTP client software and you will be asked to log in to the server. Enter ‘anonymous’ as the user name and your e-mail address for the password.

Tell Us What You Think

If you have any comments or suggestions on how we might improve this or other Allied Telesyn documents, please fill out the General Enquiry Form online. This form can be accessed by selecting “Contact Us” from **www.alliedtelesyn.com**.

Chapter 1

Overview

The AT-FS7016 and AT-FS7024 are Layer 2, Fast Ethernet Smart Switches. These switches offer a range of features and capabilities, including limited management that simplifies the task of creating or expanding an Ethernet or Fast Ethernet network.

A Fast Ethernet Smart Switch can be used in a network environment which requires some configuration and minimum maintenance and monitoring.

The AT-FS7016 switch features 16 10/100Base-TX twisted pair ports. The AT-FS7024 switch features 24 10/100Base-TX twisted pair ports. Each twisted pair port has a RJ-45 connector and a maximum operating distance of 100 meters (328 feet). These ports are capable of Auto-negotiating to 10 or 100 Mbps and feature half- and full-duplex operation.

Each switch also features a RS-232 Terminal Port for out-of-band management.

The AT-FS7016 and AT-FS7024 switches feature an internal power supply and are designed for desktop or rackmount installation.

Figure 1 illustrates the front panel of the AT-FS7016 switch.

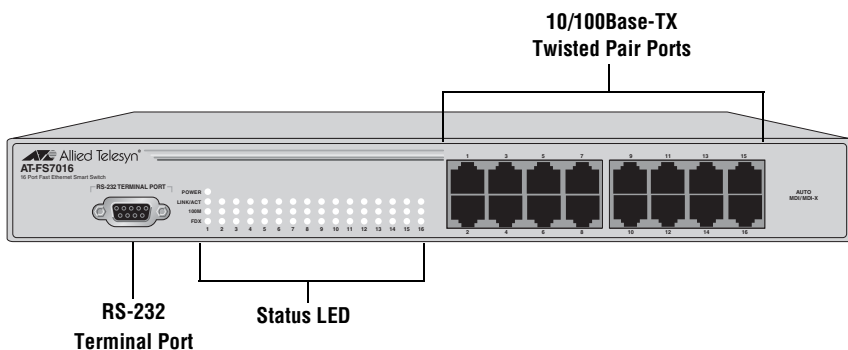

Figure 1 AT-FS7016 Front Panel

Figure 2 illustrates the front panel of the AT-FS7024 switch.

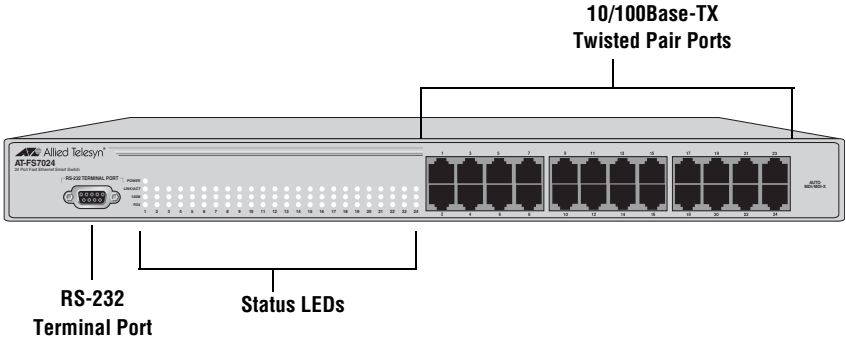

Figure 2 AT-FS7024 Front Panel

Figure 3 illustrates the back panel of the AT-FS7016 and AT-FS7024 switches.

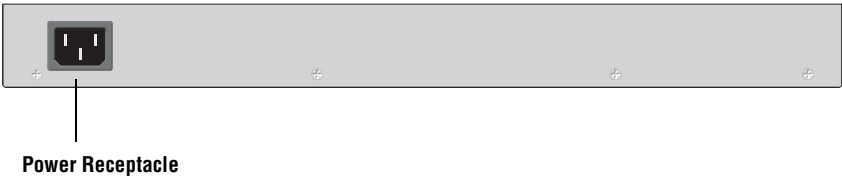

Figure 3 Back Panel

Table 1 lists the number of ports, connector type, and maximum operating distance for each smart switch.

Table 1 AT-FS7016 and AT-FS7024 Smart Switches

Model	Number of Ports	10/100Base-TX	
		Connector	Maximum Operating Distance
AT-FS7016	16	RJ-45	100 m (328 ft)
AT-FS7024	24	RJ-45	100 m (328 ft)

Key Features

The AT-FS7016 and AT-FS7024 Smart Switches have the following key features:

- LEDs for power and port status
- Fixed 16 or 24 10/100Base-TX twisted pair ports
- Auto MDI/MDI-X on all ports
- Full- or half-duplex operation on all ports
- RS-232 terminal port for out-of-band management
- Supports the following software functions:
 - Port mirroring
 - Port-based VLANs
 - Quality of Service (QoS)
 - Port trunking
 - Port configuration
- MAC address table with a capacity of 4000 addresses
- Store and forward switching mode
- For use on a desktop or a standard 19-inch rack

Status LEDs

Table 2 lists the status LEDs for the AT-FS7016 and AT-FS7024 switches.

Table 2 Status LEDs

LED	Color	Description
POWER	Green	Power is applied to the switch.
LINK/ACT	Green Blinking OFF	A valid link has been established on the port. The port is transmitting data. A link has not been detected on the port.
100M	Green OFF	The port is operating at 100 Mbps. The port is operating at 10 Mbps.
FDX	Green OFF	The port is operating in full-duplex mode. The port is operating in half-duplex mode.

Port Speed

The twisted pair ports are 10/100Base-TX compliant and are capable of both 10 Mbps and 100 Mbps speeds. You can set the port speed manually or, since the ports are IEEE 802.3 Auto-negotiation compliant, you can let the switch set each port's speed automatically. With Auto-negotiation, the switch automatically matches the highest possible common speed between the port on the switch and the port on the end-node. For example, if an end-node is capable of only 10 Mbps, the switch sets the port connected to the end-node to 10 Mbps.

Note

Auto-negotiation is activated as the default on each twisted pair port on the switch. To deactivate Auto-negotiation and set the speeds manually, refer to the *AT-S67 and AT-S68 Software Management User's Guide*.

Duplex Mode

The duplex mode refers to the manner in which an end-node sends and receives data on the network. Depending on its capabilities, an end-node can operate in either half- or full-duplex mode. An end-node operating in half-duplex can either send or receive data, but not both at the same time. However, an end-node operating in full-duplex can send and receive data simultaneously. The best network performance is achieved when an end-node can operate in full-duplex mode.

Each twisted pair port on the AT-FS7016 and AT-FS7024 switch can operate in either half- or full-duplex mode. The twisted pair ports are IEEE 802.3u-compliant and will Auto-negotiate the duplex mode setting.

If desired, Auto-negotiation on one or all of the ports can be disabled so that you can set the duplex mode manually through the management software.

Note

In order for a port on the switch to successfully Auto-negotiate its duplex mode with an end-node, the end-node should also be set to Auto-negotiation. Otherwise, a duplex mode mismatch can occur. A port on the switch using Auto-negotiation will default to half-duplex if it detects that the end-node is not using Auto-negotiation. This will result in a mismatch if the end-node is operating at a fixed duplex mode of full-duplex. Consequently, when connecting an end-node with a fixed duplex mode of full-duplex to a switch port, you should use the management software to disable Auto-negotiation on the port and set the port speed and duplex mode manually.

Auto MDI/MDI-X

An RJ-45 twisted pair port on a 10 Mbps or 100 Mbps Ethernet network device can have one of two possible wiring configurations: MDI or MDI-X. The RJ-45 port on a PC, router, or bridge is typically wired as MDI, while the twisted pair port on a switch or hub is usually MDI-X.

To connect two 10 Mbps or 100 Mbps network devices together that have dissimilar port wiring configurations, such as MDI to MDI-X, you would use a straight-through twisted pair cable. To connect two network devices that have the same wiring configuration, such as MDI to MDI, you would use a crossover cable.

When a port on the AT-FS7016 or AT-FS7024 switch is set to Auto-negotiation, the switch enables the auto MDI/MDI-X feature. The RJ-45 port automatically determines the configuration of the port on the device to which it is connected and then configures itself appropriately. This feature allows you to use either a straight-through or crossover cable when connecting a device to the twisted pair port.

The auto MDI/MDI-X feature is available only when a port is set to Auto-negotiation. If Auto-negotiation is disabled, the port defaults to MDI-X. In this case you would use a crossover cable to connect the port to an end-node with a MDI-X port (such as another switch).

RS-232 Terminal Port

The RS-232 Terminal Port is used to establish a local (out-of-band) management session with the switch. To establish a local management session, you connect either a VT100 terminal or a PC with a terminal emulation program to the port.

The RS-232 Terminal Port has a DB-9 female connector and uses a straight-through RS-232 cable (not provided). The default settings for the RS-232 Terminal Port are:

- Bits per second: 9600
- Data bits: 8
- Parity: None
- Stop bits: 1
- Flow control: None

Note

These default settings are for a DEC VT100 or ANSI terminal, or an equivalent terminal emulation program.

Power Requirements

The AT-FS7016 and AT-FS7024 switches use a universal internal switching power supply. Allied Telesyn ships power cords with these units to the U.S., Continental Europe, and the U.K. The AT-FS7016 switch requires input of 100 - 240 V AC, 0.8A, 50/60 Hz. The AT-FS7024 switch requires input of 100 - 240 V AC, 0.5A, 50/60 Hz. These switches have a maximum power consumption of 27W.

Network Topologies

The AT-FS7016 and AT-FS7024 Fast Ethernet Smart Switches can be used in a variety of network topologies. Three types of topologies are described below.

Power Workgroup Topology

A power workgroup topology, shown in Figure 4, allows each end-node to directly connect to a 10/100Base-TX twisted pair port on an AT-FS7016 switch. This gives each end-node a dedicated 10 Mbps or 100 Mbps link.

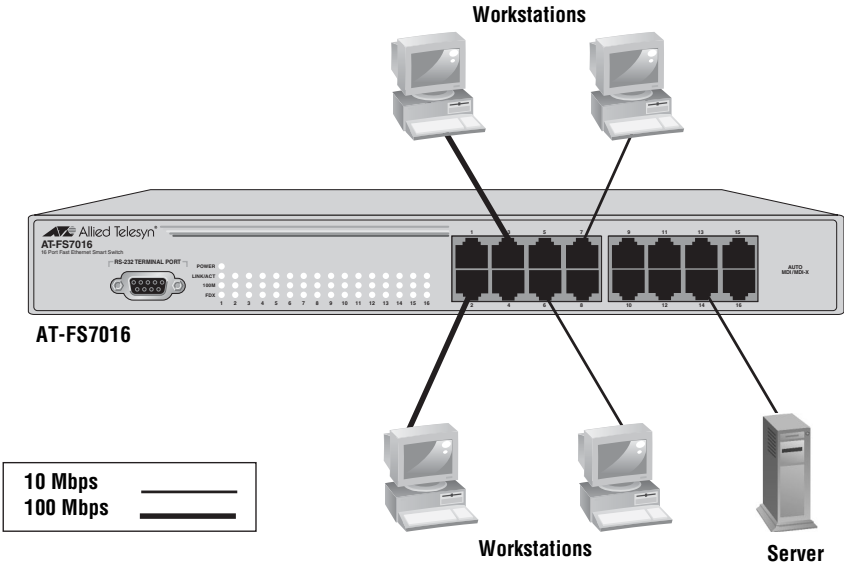

Figure 4 Power Workgroup Topology

Collapsed Topology

In the topology illustrated in Figure 5, an AT-FS7016 switch connects together 10/100 Mbps Ethernet hubs. This type of topology is often referred to as a collapsed backbone topology. The switch functions as the focal point of the network by acting as a bridge between the different workgroups. The switch transfers an Ethernet frame from hub-to-hub only when the destination end-node for the frame is on a different hub than the end-node that originated the frame. This reduces the amount of unnecessary data traffic in each workgroup, freeing up bandwidth and improving network performance.

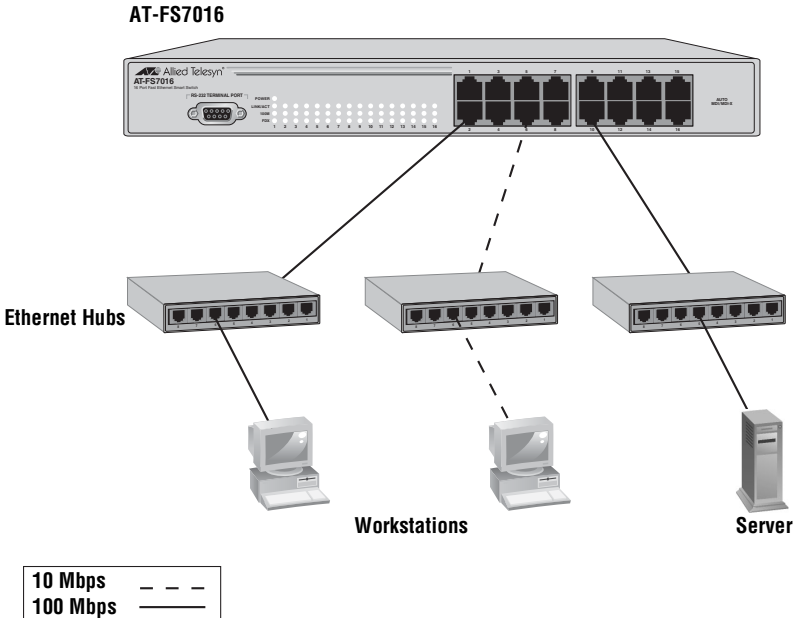

Figure 5 Collapsed Topology

Mixed Topology

Figure 6 illustrates a network of three AT-FS7024 switches. The workstations and servers are connected either directly to a switch or indirectly through an Ethernet hub. The switches are connected together through 10/100Base-TX twisted pair ports.

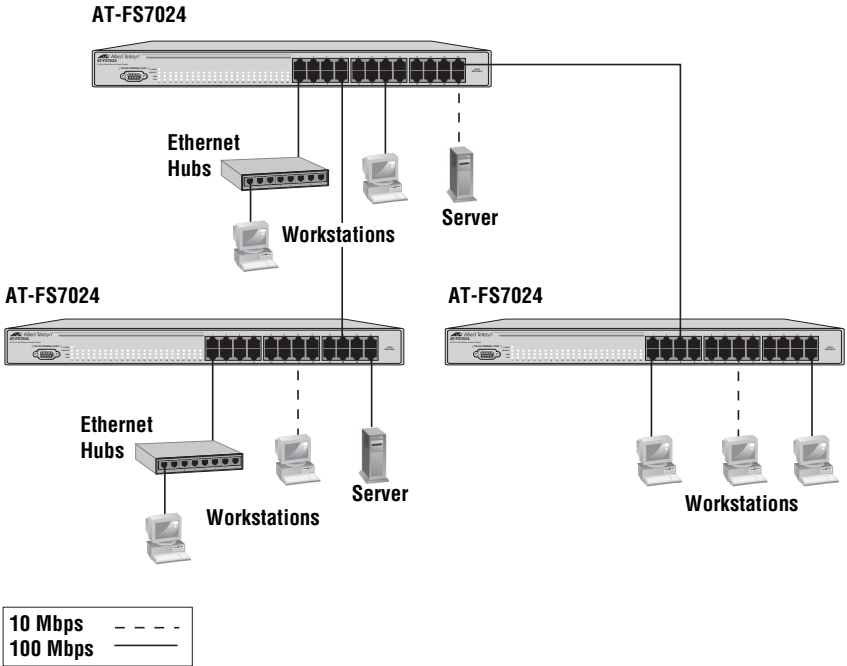

Figure 6 Mixed Topology

Chapter 2

Installation

Verifying the Package Contents

Make sure the following items are included in your package. If any item is missing or damaged, contact your Allied Telesyn sales representative for assistance.

- One AT-FS7016 or AT-FS7024 Fast Ethernet Smart Switch
- Four protective feet (AT-FS7016 only)
- AC power cord (for U.S., Continental Europe, or U.K.)
- Rackmounting kit
- This installation guide
- Warranty card

Planning the Installation

Be sure to observe the following guidelines when planning the installation of your switch.

- ❑ The end-nodes connected to the twisted pair ports can operate at either 10 Mbps or 100 Mbps and half- or full-duplex mode. Refer to “Port Speed” and “Duplex Mode” on page 5 for additional information.
- ❑ An end-node connected to a port on the switch can be a network adapter card, repeater, router, hub, or another switch.
- ❑ A twisted pair port using Auto-negotiation features auto MDI/MDI-X. It configures itself automatically as MDI or MDI-X when connected to an end-node. Consequently, you can use either a straight-through or crossover twisted pair cable when connecting any network device to a port. If Auto-negotiation is disabled and a port’s speed and duplex mode are set manually, the port defaults to MDI-X. Refer to “Auto MDI/MDI-X” on page 6 for additional information.
- ❑ Refer to Table 3 for the cabling specifications for the twisted pair ports.

Table 3 10/100Base-TX Twisted Pair Port Cabling Specifications

Operating Mode	Twisted Pair Cable	Maximum Operating Distance
10Base-T	Shielded or unshielded Category 3 or better	100 m (328 ft)
100Base-TX	Shielded or unshielded Category 5 or better	100 m (328 ft)

Selecting a Site

Be sure to observe the following guidelines when selecting a site for your switch.

- Select a site that is dust-free and moisture-free.
- Select a site that will allow you to easily access the switch's power and data cables.
- The twisted pair port cabling must be kept away from sources of electrical noise, such as radios, transmitters, power lines, broadband amplifiers electrical motors, and fluorescent fixtures.
- Make sure the air flow around the switch and through its vents on the side and back are not restricted.
- Use a dedicated power circuit or power conditioner to supply reliable power to the switch.
- If you plan to install the switch in an equipment rack, check to be sure that the rack is safely secured and that it will not tip over. Devices in a rack should be installed starting with the heavier devices at the bottom of the rack.
- If you are installing the switch on a table, be sure that the table is level and secure.
- The site should provide for easy access to the ports on the front of the switch. This will make it easy for you to connect and disconnect cables, as well as view the switch's LEDs.
- Do not place objects on top of the switch.

Reviewing Safety Guidelines

Please review the following safety guidelines before you begin to install the switch.



Warning

Electrical Shock Hazard: To prevent electrical shock, do not remove the cover. There are no user-serviceable parts inside. The unit contains hazardous voltages and should only be opened by a trained and qualified technician. *See 5*



Warning

Lightning Danger: Do not work on equipment or cables during periods of lightning activity. *See 6*



Warning

Power cord is used to disconnect device. To de-energize equipment, disconnect the power cord. *See 7*



Caution

Pluggable Equipment: The socket outlet should be installed near the equipment and should be easily accessible. *See 8*



Warning

Electrical-Type Class 1 Equipment: This equipment must be earthed. The power plug must be connected to a properly wired earth ground socket outlet. An improperly wired socket outlet could place hazardous voltages on accessible metal parts. *See 9*



Caution

Air vents: The air vents must not be blocked on the unit and must have free access to the room ambient air for cooling. *See 10*



Caution

Operating Temperature

This product is designed for a maximum ambient temperature of 40 degrees C. *See 11*



Caution

All Countries: Install product in accordance with local and National Electrical Codes. *See 12*

Installing the Switch on a Table or Desktop

If you are rackmounting an AT-FS7016 or AT-FS7024 switch, refer to “Rackmounting the Switch” on page 17.

To install the switch on a table or desktop, perform the following procedure:

1. Remove all equipment from the packaging and store the packing material in a safe place. In the event a problem occurs and you need to return the unit, please use as much of the original shipping material as possible.
2. For the AT-FS7016 switch, attach the four protective feet to the bottom of the unit. See Figure 7.

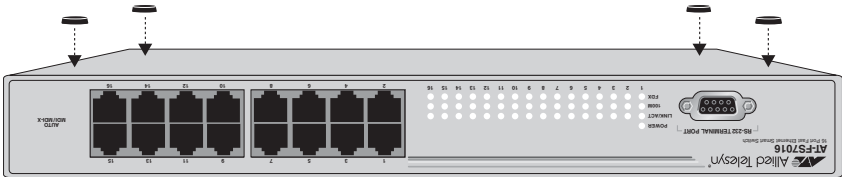

Figure 7 Attaching the Rubber Feet (AT-FS7016 only)

Note

The protective rubber feet for the AT-FS7024 switch are pre-installed.

3. Place the switch on a flat, secure surface leaving ample space around the switch for ventilation.
4. Apply power to the switch by plugging the AC power cord into an AC power outlet; then plug the other end of the power cord into the receptacle located on the back of the switch.
5. Verify that the POWER LED is green. If the LED is OFF, refer to “Troubleshooting” on page 21.

Note

The switch performs a self-diagnostic test upon power up. This takes about 20 seconds to complete.

6. Connect the twisted pair cables to a twisted pair ports on the switch and on the end-nodes. When connecting a twisted pair cable to a port on the switch, observe the following:
 - ❑ An RJ-45 connector should fit snugly into the port on the switch. The tab on the connector should lock in connector into place.

- ❑ Since the ports on the switch are auto MDI/MDI-X, you can use either a straight-through or crossover twisted pair cable to connect any type of network device to a port on the switch. Refer to “Auto MDI/MDI-X” on page 6 for additional information.
 - ❑ If you are creating a port trunk, do not connect the cable of the trunk to the switch until you have configured the trunk using the management software. Connecting the trunk cables to the switch before you have configured the software will result in a data loop, which can adversely affect network performance. For instructions on how to configure a port trunk, refer to the *AT-S67 and AT-S68 Software Management User’s Guide*.
7. Power ON the end-nodes connected to the switch.
 8. Check that the LINK/ACT LED for each port on the switch is green. If a LED is OFF, refer to “Troubleshooting” on page 21.

The switch is now ready for use. Refer to the *AT-S67 and AT-S68 Software Management User’s Guide* to manage and configure your unit. This guide is available at **www.alliedtelesyn.com**.

Rackmounting the Switch

The AT-FS7016 and AT-FS7024 switches can be used on a desktop or installed in a rack. For desktop installation, refer to “Installing the Switch on a Table or Desktop” on page 15.

To install the switch in a rack, perform the following procedure:

1. If attached, remove the four protective rubber feet from the bottom on the unit.
 - ❑ For the AT-FS7016 switch, remove the protective feet from the bottom of the unit, as shown in Figure 8.

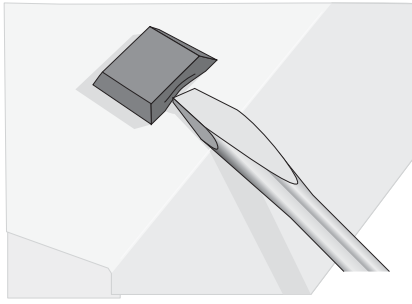

Figure 8 Removing the Protective Feet (AT-FS7016)

- ❑ For the AT-FS7024 switch, remove the protective feet from the bottom of the unit, as shown in Figure 9.

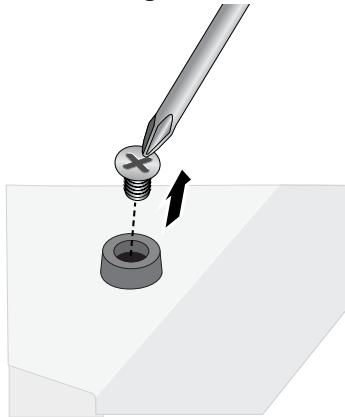

Figure 9 Removing the Protective Feet (AT-FS7024)

2. Attach the rackmounting brackets to each side of the switch using the screws provided. See Figure 10.

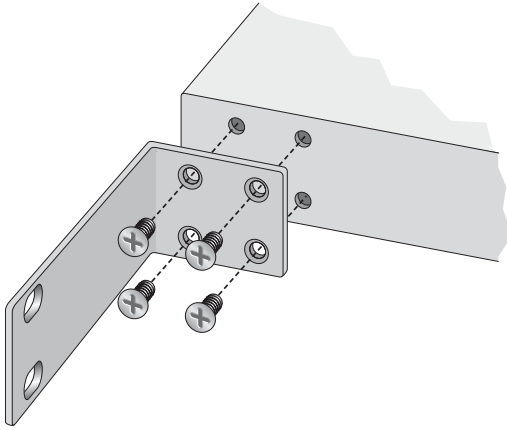

Figure 10 Attaching the Rackmounting Brackets to the Switch

3. Secure the switch to the rack using two screws (not provided) for each side, as shown in Figure 11.

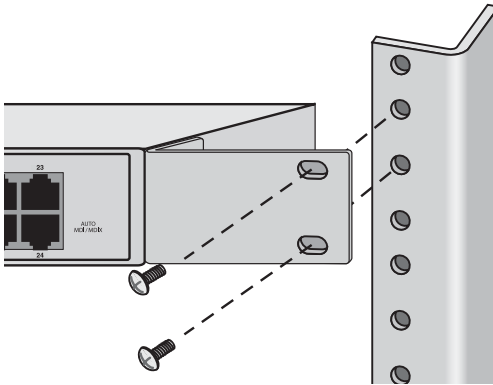

Figure 11 Installing the Switch to the Rack

4. Apply power to the switch by plugging the AC power cord into an AC power outlet; then plug the other end of the power cord into the receptacle located on the back of the switch.
5. Verify that the POWER LED is green. If the LED is OFF, refer to “Troubleshooting” on page 21.

Note

The switch performs a self-diagnostic test upon power up. This takes about 20 seconds to complete.

6. Connect the twisted pair cables to a twisted pair ports on the switch and on the end-nodes. When connecting a twisted pair cable to a port on the switch, observe the following:
 - ❑ An RJ-45 connector should fit snugly into the port on the switch. The tab on the connector should lock in connector into place.
 - ❑ Since the ports on the switch are auto MDI/MDI-X, you can use either a straight-through or crossover twisted pair cable to connect any type of network device to a port on the switch. Refer to “Auto MDI/MDI-X” on page 6 for additional information.
 - ❑ If you are creating a port trunk, do not connect the cable of the trunk to the switch until you have configured the trunk using the management software. Connecting the trunk cables to the switch before you have configured the software will result in a data loop, which can adversely affect network performance. For instructions on how to configure a port trunk, refer to the *AT-S67 and AT-S68 Software Management User’s Guide*.
7. Power ON the end-nodes connected to the switch.
8. Check that the LINK/ACT LED for each port on the switch is green. If a LED is OFF, refer to “Troubleshooting” on page 21.

The switch is now ready for use. Refer to the *AT-S67 and AT-S68 Software Management User’s Guide* to manage and configure your unit. This guide is available at www.alliedtelesyn.com.

Warranty Registration

When you finish installing the product, you should register you product by completing the enclosed warranty card and sending it in.

Chapter 3

Troubleshooting

Follow the guidelines below to test and troubleshoot the installation in the event a problem occurs.

If the POWER LED is OFF, do the following:

- Check to be sure that the power cord is securely connected to a power outlet and that the other end of the power cord is securely connected to the back of the switch.
- Check that the voltage from the power source is within the required levels for your region.
- Verify that the power outlet has power by connecting another device to it.
- Try connecting the unit to another power source.
- Try using another power cord.

If a LINK/ACT LED is OFF, do the following:

- Check that the end-node connected to the port is powered ON and is operating properly.
- Check that the twisted pair cable is securely connected to the twisted pair port on the switch and to the port on the end-node.
- Make sure that the twisted pair cable does not exceed 100 meters (328 feet) and that you are using Category 3 or better cable for 10Base-T operation or Category 5 or better cable for 100Base-TX operation.
- Verify that the end-node is operating at 10 Mbps or 100 Mbps.

If you are unable to establish a local management session with the switch through the RS-232 terminal port, do the following:

- ❑ Check to be sure that the RS-232 cable is securely connected to the RS-232 terminal port on the switch and to the RS-232 port on the terminal or PC.
- ❑ Check to be sure that you are using a straight-through RS-232 cable. Do not use a cross-over cable.
- ❑ Check to be sure that the operating parameters on the terminal or terminal emulation program, if you are using a PC, have been set correctly. Refer to “RS-232 Terminal Port” on page 6 for the default settings.

If you are still experiencing problems after testing and troubleshooting the installation, contact Allied Telesyn Technical Support for assistance. Refer to “Contacting Allied Telesyn” on page viii or visit our web site at **www.alliedtelesyn.com** for support information.

Appendix A

Technical Specifications

Physical

Dimensions:	W x D x H
AT-FS7016	330 mm x 155 mm x 44 mm (13.0 in x 6.1 in x 1.73 in)
AT-FS7024	440 mm x 174 mm x 41 mm (17.32 in x 6.85 in x 1.61 in)
Weight:	
AT-FS7016	1.5 kg (3.30 lb)
AT-FS7024	2.26 kg (4.98 lb)

Environmental

Maximum Operating:	0° to 40° C (32° to 104° F)
Maximum Storage:	-25° to 70° C (-13° F to 158° F)
Relative Humidity Operating:	5% to 80% (non-condensing)
Relative Humidity Storage:	5% to 90% (non-condensing)
Operating and Storage Altitude:	Up to 3,048 meters (10,000 feet)

Electrical Rating

Internal Universal Power Supply:

Input

AT-FS7016 100 - 240 V AC, 0.8A, 50/60 Hz

AT-FS7924 100 - 240 V AC, 0.5A, 50/60 Hz

Power Consumption: 27W maximum

Agency Compliance

EMI/RFI: FCC Class A, EN55022 Class A,
EN6100-3-2, EN6100-3-3
VCCI Class A, CISPR 22 Class A
(CE Mark, C-Tick)

Electrical Safety: TUV-EN60950, UL60950 (_cUL_{us})

Immunity: EN55024

Pinout Assignments

Figure 12 shows the pin assignments of the RJ-45 connector.

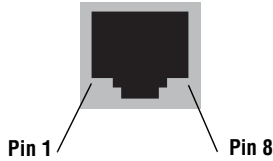

Figure 12 RJ-45 Connector

Table 4 lists the 10/100Base-TX connector pins and their signals when the port is operating in either MDI or MDI-X configuration.

Table 4 RJ-45 Pin Signals

MDI-X	Signal	MDI	Signal
1	RX+	1	TX+
2	RX-	2	TX-
3	TX+	3	RX+
4	-	4	-
5	-	5	-
6	TX-	6	RX-
7	-	7	-
8	-	8	-

Appendix B

Translated Safety and Emission Information

Important: This appendix contains multiple-language translations for the safety statements in this guide.

Wichtig: Dieser Anhang enthält Übersetzungen der in diesem Handbuch enthaltenen Sicherheitshinweise in mehreren Sprachen.

Vigtigt: Dette tillæg indeholder oversættelser i flere sprog af sikkerhedsadvarslerne i denne håndbog.

Belangrijk: Deze appendix bevat vertalingen in meerdere talen van de veiligheidsopmerkingen in deze gids.

Important: Cette annexe contient la traduction en plusieurs langues des instructions de sécurité figurant dans ce guide.

Tärkeää: Tämä liite sisältää tässä oppaassa esiintyvät turvaohjeet usealla kielellä.

Importante: questa appendice contiene traduzioni in più lingue degli avvisi di sicurezza di questa guida.

Viktig: Dette tillegget inneholder oversettelser til flere språk av sikkerhetsinformasjonen i denne veiledningen.

Importante: Este anexo contém traduções em vários idiomas das advertências de segurança neste guia.

Importante: Este apéndice contiene traducciones en múltiples idiomas de los mensajes de seguridad incluidos en esta guía.

Obs! Denna bilaga innehåller flerspråkiga översättningar av säkerhetsmeddelandena i denna handledning.

Standards: This product meets the following standards.

U.S. Federal Communications Commission

Radiated Energy

Note: This equipment has been tested and found to comply with the limits for a Class A digital device pursuant to Part 15 of FCC Rules. These limits are designed to provide reasonable protection against harmful interference when the equipment is operated in a commercial environment. This equipment generates, uses, and can radiate radio frequency energy and, if not installed and used in accordance with this instruction manual, may cause harmful interference to radio communications. Operation of this equipment in a residential area is likely to cause harmful interference in which case the user will be required to correct the interference at his own expense.

Note: Modifications or changes not expressly approved of by the manufacturer or the FCC, can void your right to operate this equipment.



Canadian Department of Communications

This Class A digital apparatus meets all requirements of the Canadian Interference-Causing Equipment Regulations.

Cet appareil numérique de la classe A respecte toutes les exigences du Règlement sur le matériel brouilleur du Canada.

- 1 RFI Emission EN55022 Class A, EN6100-3-2, EN6100-3-3
- 2 **Warning:** In a domestic environment this product may cause radio interference in which case the user may be required to take adequate measures.
- 3 Immunity EN55024
- 4 Electrical Safety TUV-EN60950, UL60950 (cULus)

Safety

- 5  **Electrical Notices**
Warning: Electric Shock Hazard
 To prevent ELECTRIC shock, do not remove cover. No user-serviceable parts inside. This unit contains HAZARDOUS VOLTAGES and should only be opened by a trained and qualified technician. To avoid the possibility of ELECTRIC SHOCK disconnect electric power to the product before connecting or disconnecting the LAN cables.
- 6  **Lightning Danger**
Danger: Do not work on equipment or cables during periods of lightning activity.
- 7 **Installation**
 **Caution:** Power cord is used as a disconnection device. to de-energize equipment, disconnect the power cord.
- 8 **Caution:** Pluggable Equipment: The socket outlet should be installed near the equipment and should be easily accessible.

Electrical—Auto Voltage Adjustment

This product will automatically adjust to any voltage between the ranges shown on the label.

9

Electrical—Type Class 1 Equipment

THIS EQUIPMENT MUST BE EARTHED. Power plug must be connected to a properly wired earth ground socket outlet. An improperly wired socket outlet could place hazardous voltages on accessible metal parts.

10



Caution: Air vents must not be blocked and must have free access to the room ambient air for cooling.

11

Operating Temperature: This product is designed for a maximum ambient temperature of 40 degrees C.

12

All Countries: Install product in accordance with local and National Electrical Codes.

Normen: Dieses Produkt erfüllt die Anforderungen der nachfolgenden Sicherheitsnormen.

1

Hochfrequenzstörung EN55022 Klasse A

2

Warnung: Bei Verwendung zu Hause kann dieses Produkt Funkstörungen hervorrufen. In diesem Fall müßte der Anwender angemessene Gegenmaßnahmen ergreifen.

3

Störsicherheit EN55024

4

Elektrische Sicherheit TUV-EN60950, UL60950 (cULus)

Sicherheit

5



Achtung: Gefährliche Spannung

Das Gehäuse nicht öffnen. Das Gerät enthält keine vom Benutzer wartbaren Teile. Das Gerät steht unter Hochspannung und darf nur von qualifiziertem technischem Personal geöffnet werden. Vor Anschluß der LAN-Kabel, Gerät vom Netz trennen.

6



Gefahr Durch Blitzschlag

Gefahr: Keine Arbeiten am Gerät oder an den Kabeln während eines Gewitters ausführen.

Installation

7



Vorsicht: Das netzkabel dient zum trennen der stromversorgung. Zur trennung vom netz, kabel aus der steckdose ziehen.

8

Steckbares Gerät: Die Anschlußbuchse sollte in der Nähe der Einrichtung angebracht werden und leicht zugänglich sein.”

Automatische Spannungseinstellung

Dieses Gerät stellt sich automatisch auf die auf dem Etikett aufgeführten Spannungswerte ein.

9

Geräte Der Klasse 1

DIESE GERÄTE MÜSSEN GEEDET SEIN. Der Netzstecker darf nur mit einer vorschriftsmäßig geerdeten Steckdose verbunden werden. Ein unvorschriftsmäßiger Anschluß kann die Metallteile des Gehäuses unter gefährliche elektrische Spannungen setzen.

10



Vorsicht

Die Entlüftungsöffnungen dürfen nicht versperrt sein und müssen zum Kühlen freien Zugang zur Raumluft haben.

- 🌀 11 **Betriebstemperatur:** Dieses Produkt wurde für den Betrieb in einer Umgebungstemperatur von nicht mehr als 40° C entworfen.
- 🌀 12 **Alle Länder:** Installation muß örtlichen und nationalen elektrischen Vorschriften entsprechen.

Standarder: Dette produkt opfylder følgende sikkerhedsstandarder.

- 🌀 1 Radiofrekvens forstyrrelsesemission EN55022 Klasse A
- 🌀 2 **Advarsel:** I et hjemligt miljø kunne dette produkt forårsage radio forstyrrelse. Bliver det tilfældet, påkræves brugeren muligvis at tage tilstrækkelige foranstaltninger.
- 🌀 3 Immunitet EN55024
- 🌀 4 Elektrisk sikkerhed TUV-EN60950, UL60950 (cULus)
Sikkerhed

🌀 5 **Elektriske Forholdsregler**



Advarsel: RISIKO FOR ELEKTRISK STØD

For at forebygge ELEKTRISK stød, undlad at åbne apparatet. Der er ingen indre dele, der kan repareres af brugeren. Denne enhed indeholder LIVSFARLIGE STRØMSPÆNDINGER og bør kun åbnes af en uddannet og kvalificeret tekniker. For at undgå risiko for ELEKTRISK STØD, afbrydes den elektriske strøm til produktet, før LAN-kablerne monteres eller afmonteres.

🌀 6 **Fare Under Uvejr**



Fare: UNDLAD at arbejde på udstyr eller KABLER i perioder med LYNAKTIVITET.

Installation

- 🌀 7 **Advarsel:** Den strømførende ledning bruges til at afbryde strømmen. Skal strømmen til apparatet afbrydes, tages ledningen ud af stikket.



- 🌀 8 **Udstyr Til Stikkontakt,** stikkontakten bør installeres nær ved udstyret og skal være lettilgængelig.

Elektrisk—Automatisk Spændingsregulering

Dette apparat vil automatisk tilpasse sig enhver spænding indenfor de værdier, der er angivet på etiketten.

🌀 9 **Elektrisk—Klasse 1-Udstyr**

DETTE UDSKYR KRÆVER JORDFORBINDELSE. Stikket skal være forbundet med en korrekt installeret jordforbunden stikkontakt. En ukorrekt installeret stikkontakt kan sætte livsfarlig spænding til tilgængelige metaldele.

- 🌀 10 **Advarsel:** Ventilationsåbninger må ikke blokeres og skal have fri adgang til den omgivende luft i rummet for afkøling.







- 🌀 11 **Betjeningstemperatur:** Dette apparat er konstrueret til en omgivende temperatur på maksimum 40 grader C.

- 🌀 12 **Alle Lande:** Installation af produktet skal ske i overensstemmelse med lokal og national lovgivning for elektriske installationer.

Normen: Dit product voldoet aan de volgende veiligheidsnormen.





- | | | |
|---|--|-------------------------------|
| 1 | RFI Emissie | EN55022 Klasse A |
| 2 | Waarschuwing: Binnenshuis kan dit product radiostoring veroorzaken, in welk geval de. | |
| 3 | Immunititeit | EN55024 |
| 4 | Electrische Veiligheid | TUV-EN60950, UL60950 (cUL-us) |
- Veiligheid

- 5  **Waarschuwingen Met Betrekking Tot Elektriciteit**
Waarschuwing: GEVAAR VOOR ELEKTRISCHE SCHOKKEN
 Verwijder het deksel niet, teneinde ELEKTRISCHE schokken te voorkomen. Binnenin bevinden zich geen onderdelen die door de gebruiker onderhouden kunnen worden. Dit toestel staat onder GEVAARLIJKE SPANNING en mag alleen worden geopend door een daartoe opgeleide en bevoegde technicus. Om het gevaar op ELEKTRISCHE SCHOKKEN te vermijden, moet u het toestel van de stroombron ontkoppelen alvorens de LAN-kabels te koppelen of ontkoppelen.
- 6  **Gevaar Voor Blikseminslag**
Gevaar: NIET aan toestellen of KABELS WERKEN bij BLIKSEM.
- Installatie**
- 7  **Waarschuwing:** Het toestel wordt uitgeschakeld door de stroomkabel te ontkoppelen. Om het toestel stroomloos te maken: de stroomkabel ontkoppelen.
- 8 **Aan Te Sluiten Apparatuur,** de contactdoos wordt in de nabijheid van de apparatuur geïnstalleerd en is gemakkelijk te bereiken.”
Elektrisch: Automatische Aanpassing Van De Spanning
 Dit toestel past zich automatisch aan elke spanning aan, tussen de op het label vermelde waarden.
- 9 **Elektrische Toestellen Van Klasse 1**
 DIT TOESTEL MOET GEAARD WORDEN. De stekker moet aangesloten zijn op een juist gearde contactdoos. Een onjuist gearde contactdoos kan de metalen onderdelen waarmee de gebruiker eventueel in aanraking komt onder gevaarlijke spanning stellen.
- 10  **Opgelet:** De ventilatiegaten mogen niet worden gesperd en moeten de omgevingslucht ongehinderd toelaten voor afkoeling.
- 11 **Bedrijfstemperatuur:** De omgevingstemperatuur voor dit produkt mag niet meer bedragen dan 40 graden Celsius.
- 12 **Alle Landen:** het toestel installeren overeenkomstig de lokale en nationale elektrische voorschriften.

Normes: ce produit est conforme aux normes de sécurité suivantes.

- 1 Emission d'interférences radioélectriques EN55022 Classe A
- 2 **Mise En Garde:** dans un environnement domestique, ce produit peut provoquer des interférences radioélectriques. Auquel cas, l'utilisateur devra prendre les mesures adéquates.
- 3 Immunité EN55024
- 4 Sécurité électrique TUV-EN60950, UL60950 (cULus)

Sécurité

- 5  **Information Sur Les Risques Électriques**
Avertissement: DANGER D'ÉLECTROCUTION
Pour éviter toute ÉLECTROCUTION, ne pas ôter le revêtement protecteur du matériel. Ce matériel ne contient aucun élément réparable par l'utilisateur. Il comprend des TENSIONS DANGEREUSES et ne doit être ouvert que par un technicien dûment qualifié. Pour éviter tout risque d'ÉLECTROCUTION, débrancher le matériel avant de connecter ou de déconnecter les câbles LAN.
- 6  **Danger De Foudre**
Danger: NE PAS MANIER le matériel ou les CÂBLES lors d'activité orageuse.
Installation
- 7  **Attention:** Le cordon d'alimentation sert de mise hors circuit. Pour couper l'alimentation du matériel, débrancher le cordon
- 8 **Équipement Pour Branchement Électrique**, la prise de sortie doit être placée près de l'équipement et facilement accessible".
Réglage De Tension Automatique Électrique
Ce matériel peut s'ajuster automatiquement sur n'importe quelle tension comprise dans la plage indiquée sur l'étiquette.
- 9 **Équipement De Classe 1 Électrique**
CE MATÉRIEL DOIT ÊTRE MIS A LA TERRE. La prise de courant doit être branchée dans une prise femelle correctement mise à la terre car des tensions dangereuses risqueraient d'atteindre les pièces métalliques accessibles à l'utilisateur.
- 10  **Attention:** Ne pas bloquer les fentes d'aération, ceci empêcherait l'air ambiant de circuler librement pour le refroidissement.
- 11 **Température De Fonctionnement:** Ce matériel est capable de tolérer une température ambiante maximum de 40 degrés Celsius.
- 12 **Pour Tous Pays:** Installer le matériel conformément aux normes électriques nationales et locales.

Normit: Tämä tuote on seuraavien turvallisuusnormien mukainen.

- 1 Radioaaltojen häirintä EN55022 Luokka A
- 2 **Varoit:** Kotiolosuhteissa tämä laite voi aiheuttaa radioaaltojen häirityä, missä tapauksessa laitteen käyttäjän on mahdollisesti ryhdyttävä tarpeellisiin toimenpiteisiin.
- 3 Kestävyyys EN55024
- 4 Sähköturvallisuus TUV-EN60950, UL60950 (cUL_{us})

Turvallisuus

- 5  **Sähköön Liittyviä Huomautuksia**
Varoit: SÄHKÖISKUVAARA
 Estääksesi SÄHKÖISKUN älä poista kantta. Sisällä ei ole käyttäjän huollettavissa olevia osia. Tämä laite sisältää VAARALLISIA JÄNNITTEITÄ ja sen voi avata vain koulutettu ja pätevä teknikko. Vältä äläkä SÄHKÖISKUN mahdollisuuden katkaista sähkövirta tuotteeseen ennen kuin liität tai irrotat paikallisverkon (LAN) kaapelit.
- 6  **Salamaniskuvaara**
Hengenvaara: ÄLÄ TYÖSKENTELE laitteiden tai KAAPELEIDEN KANSSA SALAMOINNIN AIKANA.
Asennus
- 7  **Huomaut:** Virtajohtoa käytetään virrankatkaisulaitteena. Virta katkaistaan irrottamalla virtajohto.
- 8 **Pistorasiaan Kytettävä Laite;** pistorasia on asennettava laitteen lähelle ja siihen on oltava esteetön pääsy.”
Sähkö—Automaattinen Jänniteensäätö
 Tämä tuote säätää automaattisesti mihin tahansa jännitteeseen ohjetarrassa annettujen arvojen välillä.
- 9 **Sähkö—Tyypiluokan 1 Laitteet**
 TÄMÄ LAITE TÄYTY MAADOITTA. Pistoke täytyy liittää kunnollisesti maadoitettuun pistorasiaan. Virheellisesti johdotettu pistorasia voi altistaa metalliosat vaarallisille jännitteille.
- 10  **Huomaut:** Ilmavaihtoreikiä ei pidä tukkia ja niillä täytyy olla vapaa yhteys ympäröivään huoneilmaan, jotta ilmanvaihto tapahtuisi.
- 11 **Käyttölämpötila:** Tämä tuote on suunniteltu ympäröivän ilman maksimilämpötilalle 40°C.
- 12 **Kaikki Maat:** Asenna tuote paikallisten ja kansallisten sähköturvallisuusmääräysten mukaisesti.

Standard: questo prodotto soddisfa i seguenti standard di sicurezza.

- 1 Emissione RFI (interferenza di radiofrequenza) EN55022 Classe A
- 2 **Avvertenza:** in ambiente domestico questo prodotto potrebbe causare radio interferenza. In questo caso potrebbe richiedersi all'utente di prendere gli adeguati provvedimenti.
- 3 Immunità EN55024
- 4 Sicurezza elettrica TUV-EN60950, UL60950 (cUL-us)

Norme Di Sicurezza

- 5  **Avvertenze Elettriche**
Attenzione: PERICOLO DI SCOSSE ELETTRICHE
Per evitare SCOSSE ELETTRICHE non asportare il coperchio. Le componenti interne non sono riparabili dall'utente. Questa unità ha TENSIONI PERICOLOSE e va aperta solamente da un tecnico specializzato e qualificato. Per evitare ogni possibilità di SCOSSE ELETTRICHE, interrompere l'alimentazione del dispositivo prima di collegare o staccare i cavi LAN.

- 6  **Pericolo Di Fulmini**
Pericolo: NON LAVORARE sul dispositivo o sui CAVI durante PRECIPITAZIONI TEMPORALESICHE.

Installazione

- 7  **Attenzione:** Il cavo di alimentazione è usato come dispositivo di disattivazione. Per togliere la corrente al dispositivo staccare il cavo di alimentazione.

- 8 **Apparecchiatura Collegabile**, la presa va installata vicino all'apparecchio per risultare facilmente accessibile”.

Elettricità—Regolazione Automatica Della Tensione

Questo prodotto regolerà automaticamente la tensione ad un valore compreso nella gamma indicata sull'etichetta.

- 9 **Elettricità—Dispositivi Di Classe 1**
QUESTO DISPOSITIVO DEVE AVERE LA MESSA A TERRA. La spina deve essere inserita in una presa di corrente specificamente dotata di messa a terra. Una presa non cablata in maniera corretta rischia di scaricare una tensione pericolosa su parti metalliche accessibili.

- 10  **Attenzione:** le prese d'aria non vanno ostruite e devono consentire il libero ricircolo dell'aria ambiente per il raffreddamento.





- 11 **Temperatura Di Funzionamento:** Questo prodotto è concepito per una temperatura ambientale massima di 40 gradi centigradi.

- 12 **Tutti I Paesi:** installare il prodotto in conformità delle vigenti normative elettriche nazionali.

Sikkerhetskrav: Dette produktet oppfyller følgende sikkerhetskrav.

- 1 RFI stråling EN55022 Klasse A
- 2 **Advarsel:** Hvis dette produktet benyttes til privat bruk, kan produktet forårsake radioforstyrrelse. Hvis dette skjer, må brukeren ta de nødvendige forholdsregler.
- 3 Immunitet EN55024
- 4 Elektrisk sikkerhet TUV-EN60950, UL60950 (cUL-us)



Sikkerhet

- 5  **Elektrisitet**
Advarsel: FARE FOR ELEKTRISK SJOKK
For å unngå ELEKTRISK sjokk, må dekslet ikke tas av. Det finnes ingen deler som brukeren kan reparere på innsiden. Denne enheten inneholder FARLIGE SPENNINGER, og må kun åpnes av en faglig kvalifisert tekniker. For å unngå ELEKTRISK SJOKK må den elektriske strømmen til produktet være avslått før LAN-kablene til- eller frakobles.
- 6  **Fare For Lynnedslag**
Fare: ARBEID IKKE på utstyr eller KABLER i TORDENVÆR.
- Installasjon**
- 7  **Forsiktig:** Strømledningen brukes til å frakoble utstyret. For å deaktivisere utstyret, må strømforsyningen kobles fra.
- 8 **Utstyr For Stikkontakt.** Stikkontakten skal monteres i nærheten av utstyret og skal være lett tilgjengelig.”
Elektrisk—Auto Spenningstilpasning
Dette produktet vil automatisk bli tilpasset hvilken som helst strømspenning i de områdene som vises på etiketten.
- 9 **Elektrisk—Type 1- Klasse Utstyr**
DETTE UTSTYRET MÅ JORDES. Strømkontakten må være tilkopleet en korrekt jordet kontakt. En kontakt som ikke er korrekt jordet kan føre til farlig spenninger i lett t ilgjengelige metalldeleer.
- 10  **Forsiktig:** Lufteventilene må ikke blokkeres, og må ha fri tilgang til luft med romtemperatur for avkjøling.
- 11 **Driftstemperatur:** Dette produktet er konstruert for bruk i maksimum romtemperatur på 40 grader celsius.
- 12 **Alle Land:** Produktet må installeres i samsvar med de lokale og nasjonale elektriske koder.

Padrões: Este produto satisfaz os seguintes padrões de segurança.

- 1 Emissão de interferência de radiofrequência EN55022 Classe A
- 2 **Aviso:** Num ambiente doméstico este produto pode causar interferência na radiorrecepção e, neste caso, pode ser necessário que o utente tome as medidas adequadas.
- 3 Imunidade EN55024
- 4 Segurança Eléctrica TUV-EN60950, UL60950 (cUL_{us})

Segurança

- 5  **Avisos Sobre Características Eléctricas**
Atenção: PERIGO DE CHOQUE ELÉTRICO
Para evitar CHOQUE ELÉTRICO, não retire a tampa. Não contém peças que possam ser consertadas pelo usuário. Este aparelho contém VOLTAGENS PERIGOSAS e só deve ser aberto por um técnico qualificado e treinado. Para evitar a possibilidade de CHOQUE ELÉTRICO, desconecte o aparelho da fonte de energia eléctrica antes de conectar e desconectar os cabos da LAN.
- 6  **Perigo De Choque Causado Por Raio**
Perigo: NÃO TRABALHE no equipamento ou nos CABOS durante períodos susceptíveis a QUEDAS DE RAIOS.

Instalação

- 7  **Cuidado:** O cabo de alimentação é utilizado como um dispositivo de desconexão. Para deseletrificar o equipamento, desconecte o cabo de alimentação.
- 8 **Equipamento De Ligação,** a tomada eléctrica deve estar instalada perto do equipamento e ser de fácil acesso.”

Eléctrico—Ajuste Automático De Voltagem

Este produto ajustar-se-á automaticamente a qualquer voltagem que esteja dentro dos limites indicados no rótulo.

- 9 **Eléctrico—Equipamentos Do Tipo Classe 1**
DEVE SER FEITA LIGAÇÃO DE FIO TERRA PARA ESTE EQUIPAMENTO. O plugue de alimentação deve ser conectado a uma tomada com adequada ligação de fio terra. Tomadas sem adequada ligação de fio terra podem transmitir voltagens perigosas a peças metálicas expostas.
- 10  **Cuidado:** As aberturas de ventilação não devem ser bloqueadas e devem ter acesso livre ao ar ambiente para arrefecimento adequado do aparelho.
- 11 **Temperatura De Funcionamento:** Este produto foi projetado para uma temperatura ambiente máxima de 40 graus centígrados.
- 12 **Todos Os Países:** Instale o produto de acordo com as normas nacionais e locais para instalações eléctricas.

Normas: este producto cumple con las siguientes normas de seguridad.

- | | | |
|-----|---|---|
| 🌀 1 | Emisión RFI | EN55022 Clase A |
| 🌀 2 | Advertencia: en un entorno doméstico, este producto puede causar radiointerferencias, en cuyo caso, puede requerirse del usuario que tome las medidas que sean convenientes al respecto. | |
| 🌀 3 | Inmunidad | EN55024 |
| 🌀 4 | Seguridad eléctrica | TUV-EN60950, UL60950 (cUL _{us}) |

Seguridad

🌀 5



Avisos Electricos

Advertencia: PELIGRO DE ELECTROCHOQUE

Para evitar un ELECTROCHOQUE, no quite la tapa. No hay ningún componente en el interior al cual puede prestar servicio el usuario. Esta unidad contiene VOLTAJES PELIGROSOS y sólo deberá abrirla un técnico entrenado y calificado Para evitar la posibilidad de ELECTROCHOQUE desconecte la corriente eléctrica que llega al producto antes de conectar o desconectar los cables LAN.

🌀 6



Peligro De Rayos

Peligro: NO REALICE NINGUN TIPO DE TRABAJO O CONEXION en los equipos o en LOS CABLES durante TORMENTAS ELECTRICAS.

Instalacion

🌀 7



Atencion: El cable de alimentacion se usa como un dispositivo de desconexion.

Para desactivar el equipo, desconecte el cable de alimentación.

🌀 8

Equipo Conectable, el tomacorriente se debe instalar cerca del equipo, en un lugar con acceso fácil".

Electrico—Auto-Ajuste De Tension

Este producto se ajustará automáticamente a cualquier tensión entre los valores máximos y mínimos indicados en la etiqueta.

🌀 9

Electrico—Equipo Del Tipo Clase 1

ESTE EQUIPO TIENE QUE TENER CONEXION A TIERRA. El cable tiene que conectarse a un enchufe a tierra debidamente instalado. Un enchufe que no está correctamente instalado podría ocasionar tensiones peligrosas en las partes metálicas que están expuestas.

🌀 10



Atencion: Las aberturas para ventilación no deberán bloquearse y deberán tener acceso libre al aire ambiental de la sala para su enfriamiento.

🌀 11

Temperatura Requerida Para La Operación: Este producto está diseñado para una temperatura ambiental máxima de 40 grados C.

🌀 12

Para Todos Los Países: Monte el producto de acuerdo con los Códigos Eléctricos locales y nacionales.

Normer: Denna produkt uppfyller följande säkerhetsnormer.

- 🌀 1 Radiostörning EN55022 Klass A
- 🌀 2 **Varning:** Denna produkt kan ge upphov till radiostörningar i hemmet, vilket kan tvinga användaren till att vidtaga erforderliga åtgärder.
- 🌀 3 Immunitet EN55024
- 🌀 4 Elsäkerhet TUV-EN60950, UL60950 (cUL_{us})

Säkerhet

- 🌀 5  **Tillkännagivanden Beträffande**
Elektricitetsrisk: RISK FÖR ELEKTRISK STÖTFör att undvika ELEKTRISK stöt, ta ej av locket. Det finns inga delar inuti som behöver underhållas. Denna apparat är under HÖGSPÄNNING och får endast öppnas av en utbildad kvalificerad tekniker. För att undvika ELEKTRISK STÖT, koppla ifrån produktens strömanslutning innan LAN-kablarna ansluts eller kopplas ur.

- 🌀 6  **Fara För Blixtnedslag**
Fara: ARBETA EJ på utrustningen eller kablarna vid ÅSKVÄDER.

Installation

- 🌀 7  **Varning:** Nätkabeln används som strömbrytare för att koppla från strömmen, dra ur nätkabeln.

- 🌀 8 **Utrustning Med Plugg.** Uttaget skall installeras i utrustningens närhet och vara lättåtkomligt”.

Elektriskt —automatisk Spänningsjustering

Denna produkt justeras automatiskt till alla spänningar inom omfånget som indikeras på produktens märkning.

- 🌀 9 **Elektriskt—Typ Klass 1 Utrustning**
DENNA UTRUSTNING MÅSTE VARA JORDAD. Nätkabeln måste vara ansluten till ett ordentligt jordat uttag. Ett felaktigt uttag kan göra att närliggande metalldelar utsätts för högspänning. Apparaten skall anslutas till jordat uttag, när den ansluts till ett nätverk.

- 🌀 10  **Varning:** Luftventilerna får ej blockeras och måste ha fri tillgång till omgivande rumsluft för avsvälning.

- 🌀 11 **Drifttemperatur:** Denna produkt är konstruerad för rumstemperatur ej överstigande 40 grader Celsius.

- 🌀 12 **Alla Länder:** Installera produkten i enlighet med lokala och statliga bestämmelser för elektrisk utrustning.