



AT-FS705E FC
AT-FS706E FC
10/100 Mbps Ethernet Switches

Installation Guide

Copyright © 2001 Allied Telesyn International, Corp.
960 Stewart Drive Suite B, Sunnyvale CA 94085, USA

All rights reserved. No part of this publication may be reproduced without prior written permission from Allied Telesyn International, Corp.

Ethernet is a registered trademark of Xerox Corporation. All other product names, company names, logos or other designations mentioned herein are trademarks or registered trademarks of their respective owners.

Allied Telesyn International, Corp. reserves the right to make changes in specifications and other information contained in this document without prior written notice. The information provided herein is subject to change without notice. In no event shall Allied Telesyn International, Corp. be liable for any incidental, special, indirect, or consequential damages whatsoever, including but not limited to lost profits, arising out of or related to this manual or the information contained herein, even if Allied Telesyn International, Corp. has been advised of, known, or should have known, the possibility of such damages.

Electrical Safety and Emission Compliance Statement

Standards: This product meets the following standards.

U.S. Federal Communications Commission

RADIATED ENERGY

Note: This equipment has been tested and found to comply with the limits for a Class A digital device pursuant to Part 15 of FCC Rules. These limits are designed to provide reasonable protection against harmful interference when the equipment is operated in a commercial environment. This equipment generates, uses, and can radiate radio frequency energy and, if not installed and used in accordance with this instruction manual, may cause harmful interference to radio communications. Operation of this equipment in a residential area is likely to cause harmful interference in which case the user will be required to correct the interference at his own expense.

Note: Modifications or changes not expressly approved of by the manufacturer or the FCC, can void your right to operate this equipment.

Industry Canada

This Class A digital apparatus meets all requirements of the Canadian Interference-Causing Equipment Regulations.

Cet appareil numérique de la classe A respecte toutes les exigences du Règlement sur le matériel brouilleur du Canada.

RFI Emission

FCC Part 15 (Class A), EN55022 (Class A)  1

WARNING: In a domestic environment this product may cause radio interference in which case the user may be required to take adequate measures.  2

Immunity

EN55024  3

Electrical Safety

UL 1950 (UL/cUL), EN60950 (TUV), EN60825  4

Important: Appendix A contains translated safety statements for installing this equipment. When you see the , go to Appendix A for the translated safety statement in your language.

Wichtig: Anhang A enthält übersetzte Sicherheitshinweise für die Installation dieses Geräts. Wenn Sie  sehen, schlagen Sie in Anhang A den übersetzten Sicherheitshinweis in Ihrer Sprache nach.

Vigtigt: Tillæg A indeholder oversatte sikkerhedsadvarsler, der vedrører installation af dette udstyr. Når De ser symbolet , skal De slå op i tillæg A og finde de oversatte sikkerhedsadvarsler i Deres eget sprog.

Belangrijk: Appendix A bevat vertaalde veiligheidsopmerkingen voor het installeren van deze apparatuur. Wanneer u de  ziet, raadpleeg Appendix A voor vertaalde veiligheidsinstructies in uw taal.

Important: L'annexe A contient les instructions de sécurité relatives à l'installation de cet équipement. Lorsque vous voyez le symbole , reportez-vous à l'annexe A pour consulter la traduction de ces instructions dans votre langue.

Tärkeää: Liite A sisältää tämän laitteen asentamiseen liittyvät käännettyä turvaohjeet. Kun näet -symbolin, katso käännettyä turvaohjetta liitteestä A.

Importante: L'Appendice A contiene avvisi di sicurezza tradotti per l'installazione di questa apparecchiatura. Il simbolo , indica di consultare l'Appendice A per l'avviso di sicurezza nella propria lingua.

Viktig: Tillegg A inneholder oversatt sikkerhetsinformasjon for installering av dette utstyret. Når du ser , åpner du til Tillegg A for å finne den oversatte sikkerhetsinformasjonen på ønsket språk.

Importante: O Anexo A contém advertências de segurança traduzidas para instalar este equipamento. Quando vir o símbolo , leia a advertência de segurança traduzida no seu idioma no Anexo A.



Importante: El Apéndice A contiene mensajes de seguridad traducidos para la instalación de este equipo. Cuando vea el símbolo , vaya al Apéndice A para ver el mensaje de seguridad traducido a su idioma.

Obs! Bilaga A innehåller översatta säkerhetsmeddelanden avseende installationen av denna utrustning. När du ser , skall du gå till Bilaga A för att läsa det översatta säkerhetsmeddelandet på ditt språk.

Table of Contents

Electrical Safety and Emission Compliance Statement	iii
Welcome to Allied Telesyn	vii
Where to Find Web-based Guides	vii
Document Conventions	vii
Contacting Allied Telesyn	viii
Online Support	viii
Telephone and Fax Support.....	viii
E-mail Support	ix
Returning Products	ix
FTP Server	x
For Sales or Corporate Information	x
Tell Us What You Think	x
Chapter 1	
Overview	1
10/100 Mbps Twisted Pair Ports	3
Type of Connector.....	3
Speed	3
Duplex Mode	3
Cabling.....	3
Maximum Distance	4
Auto MDI/MDI-X.....	4
100 Mbps Fiber Optic Port.....	5
Type of Connector.....	5
Speed	5
Duplex Mode Switch.....	5
Cabling.....	5
Maximum Distance	6
Introduction to Ethernet Switching	7
MAC Address Table.....	7
Store and Forward.....	8
Flow Control and Backpressure	8
Duplex Mode	9
System LEDs	10
Network Topologies	11

Chapter 2

Installing the Switch	17
Reviewing Safety Guidelines	17
Verifying the Package Contents	18
Selecting a Site for the Switch	19
Installing the Twisted Pair and Fiber Optic Cabling	19
Installing the Switch On a Table or Desktop.....	20
Installing the Switch on a Wall	21
Verifying and Troubleshooting the Installation.....	22
Warranty Registration	24
Technical Specifications	24

Appendix A

Translated Electrical Safety Emission Information	27
--	----

Appendix B

Technical Support Fax Order	37
Incident Summary	37

Appendix C

AT-FS705E FC and AT-FS706E FC Installation Guide Feedback	39
--	----

Welcome to Allied Telesyn

The guide contains instructions on how to install the AT-FS705E FC Series and AT-FS706E FC Series Ethernet Switches.

Where to Find Web-based Guides

The Allied Telesyn web site at **www.alliedtelesyn.com** contains the most recent documentation for all of our products. All product guides can be downloaded from the web site in PDF format.

Document Conventions

This guide uses several conventions that you should become familiar with before you begin to install the product.

Note

A note provides additional information.



Caution

A caution indicates that performing or omitting a specific action may result in equipment damage or loss of data.



Warning

A warning indicates that performing or omitting a specific action may result in bodily injury.

Contacting Allied Telesyn

You can contact Allied Telesyn technical support by telephone, fax, or e-mail. You can also contact technical support online through our web site.

Online Support

You can request technical support online by filling out the Online Technical Support Form at www.alliedtelesyn.com/support/supportf.asp or by accessing the Technical Support Knowledge Base from the Allied Telesyn North American web site. The Knowledge Base allows you to submit questions to our technical staff and review answers to previously asked questions.

Telephone and Fax Support

Listed below are the telephone and fax numbers for contacting Allied Telesyn Technical Support. On page 37 of this manual is the Technical Support Fax Order form. You should fill out this form and fax it to the appropriate number below when requesting technical assistance.

Americas

United States, Canada, Mexico,
Central America, South America
Tel: 1 (800) 428-4835, option 4
Fax: 1 (425) 481-3709

Asia

Singapore, Taiwan, Thailand, Malaysia,
Indonesia, Korea, Philippines, China,
India, Hong Kong
Tel: (+65) 3815-612
Fax: (+65) 3833-830

Australia

Australia, New Zealand
Tel: 1 (800) 000-880
Fax: (+61) 2-9438-4966

France

France, Belgium, Luxembourg,
The Netherlands, Middle East, Africa
Tel: (+33) 0-1-60-92-15-25
Fax: (+33) 0-1-69-28-37-49

Germany

Germany, Switzerland, Austria, Eastern
Europe
Tel: (+49) 30-435-900-126
Fax: (+49) 30-435-70-650

Italy

Italy, Spain, Portugal, Greece, Turkey,
Israel
Tel: (+39) 02-41-30-41
Fax: (+39) 02-41-30-42-00

Japan

Tel: (+81) 3-3443-5640
Fax: (+81) 3-3443-2443

United Kingdom

United Kingdom, Denmark, Norway,
Sweden, Finland, Iceland
Tel: (+44) 1-235-442560
Fax: (+44) 1-235-442680

E-mail Support

United States and Canada

TS1@alliedtelesyn.com

Latin America, Mexico, Puerto Rico, Caribbean, and Virgin Islands

latin_america@alliedtelesyn.com

Returning Products

Products for return or repair must first be assigned a Return Materials Authorization (RMA) number. A product sent to Allied Telesyn without a RMA number will be returned to the sender at the sender's expense.

To obtain an RMA number, contact Allied Telesyn's Technical Support at one of the following locations:

- United States and Canada**
Toll-free: 1-800-428-4835, option 4
Fax: 1-425-481-3790
- Europe, Africa, and Middle East**
Tel: +44-1793-501401
Fax: +44-1793-431099
- Latin America, Caribbean, and Virgin Islands**
Tel: International code + 425-481-3852
Fax: International code + 425-481-3895
- Puerto Rico**
Tel: 1-800-424-5012, ext. 3852 or
Tel: 1-800-424-4284, ext. 3852
- Mexico**
Tel: 800-424-5012, ext. 3852
Fax: International code + 425-481-3895
- Asia and Southeast Asia**
Tel: +65 381-5612
Fax: +65 383-3830
- Australia**
Tel: 1-800-000-880
Fax: 2-9438-4966
- New Zealand**
Tel: 0800-45-5782

FTP Server

If you need a new version of management software for an Allied Telesyn managed device and you know the file name of the program, you can download the software by connecting directly to our FTP server at **ftp://gateway.centre.com**. At login, enter 'anonymous' as the username and your e-mail address as the password.

For Sales or Corporate Information

Allied Telesyn International, Corp.

19800 North Creek Parkway, Suite 200

Bothell, WA 98011

Tel: 1 (425) 487-8880

Fax: 1 (425) 489-9191

Allied Telesyn International, Corp.

960 Stewart Drive, Suite B

Sunnyvale, CA 94085

Tel: 1 (800) 424-4284 (USA and Canada)

Fax: 1 (408) 736-0100

Tell Us What You Think

If you have any comments or suggestions on how we might improve this or other Allied Telesyn documents, fill out the "AT-FS705E FC and AT-FS706E FC Installation Guide Feedback" on page 39 and return the form to us at the address or fax number provided. You can also provide feedback online by filling out the Send Us Feedback form at **www.alliedtelesyn.com/contact/feedback.asp**.

Chapter 1

Overview

The AT-FS705E FC Series and the AT-FS706E FC Series Fast Ethernet switches are unmanaged Layer 2 switches. They can be used in a variety of network configurations and topologies. You can use the switches to create small workgroups with dedicated 10/100 Mbps links to your network devices, such as workstations, servers, printers, and routers. You can also use the switches to interconnect Ethernet hubs to provide a bridge between the different workgroups of your network. Finally, you can connect the switches to other Ethernet switches so that they can be part of a larger Ethernet network.

Common features of the switches include:

- ❑ Four 10/100 Mbps (10Base-T / 100Base-TX) twisted pair ports with RJ-45 connectors
- ❑ One (AT-FS705E FC) or two (AT-FS706E FC) 100 Mbps fiber optic ports with a maximum operating distance of 2 kilometers (1.25 miles)
- ❑ Full- or half-duplex operation on both the twisted pair ports and the fiber optic ports
- ❑ Automatic MDI/MDI-X configuration on the twisted pair ports
- ❑ Store and forward Ethernet packet handling
- ❑ MAC address table with a capacity of 4,000 addresses

The AT-FS705E FC Series and the AT-FS706E FC Series Fast Ethernet switches are easy to operate. They require no software management.

The switches are available with a variety of fiber optic connectors. For a complete list of the available models, contact your Allied Telesyn International sales representative.

Note

The AT-FS705E FC Series and the AT-FS706E FC Series switches are functionally identical. The only difference is the addition of the second fiber optic port on the AT-FS706E FC Series switch.

Figure 1 and Figure 2 illustrate the front and rear panels of the AT-FS705E FC Series and AT-FS706E FC Series Ethernet switches, respectively.

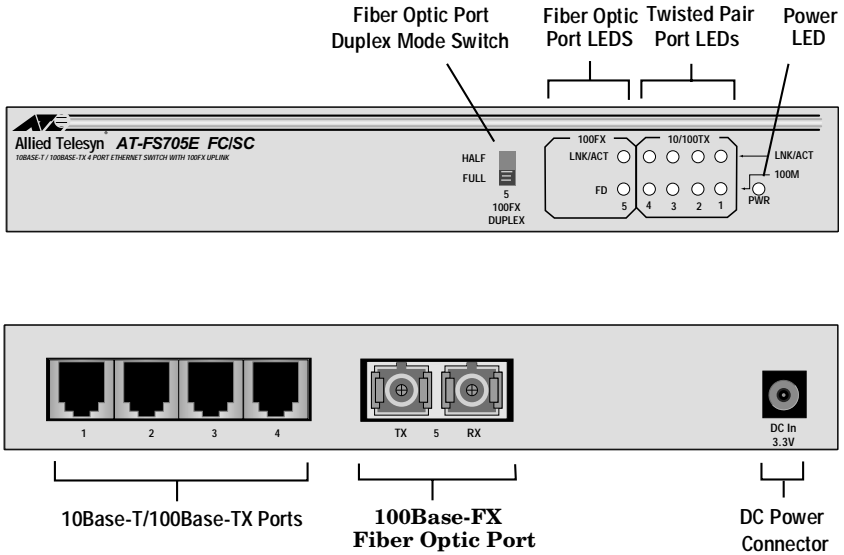

Figure 1 Front and Rear Panels of the AT-FS705EFC (Model AT-FS705EFC/SC)

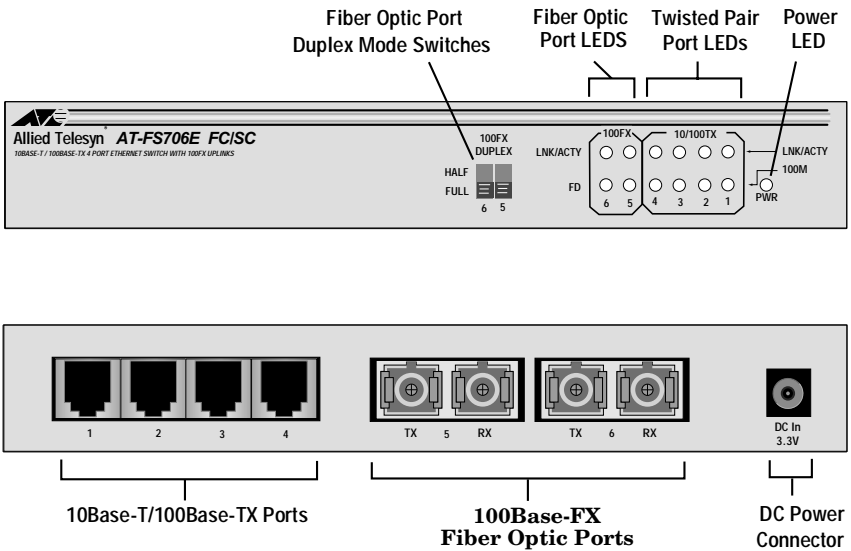

Figure 2 Front and Rear Panels of the AT-FS706EFC (Model AT-FS706E FC/SC)

10/100 Mbps Twisted Pair Ports

The AT-FS705E FC and AT-FS706E FC switches have four twisted pair ports.

Type of Connector

The twisted pair ports have RJ45 connectors.

Speed

These ports are compliant with the 10Base-T and 100Base-TX standards and are capable of either 10 Mbps or 100 Mbps operation. The ports are IEEE 802.3u Auto-negotiation-compliant, meaning the speed for each port is set automatically by the switch after determining the speed of the end node connected to the port. Auto-negotiation is designed to ensure that each port on the switch and the end node connected to each port are operating at the same speed and that they are communicating at the highest possible common speed of the devices.

Duplex Mode

The twisted pair ports can operate in either half- or full-duplex operation. Just as with speed, the ports use Auto-negotiation to set the duplex mode. If the end node is capable of full-duplex mode, the port is set to full-duplex. If the end node is capable of only half-duplex, the port is set to half-duplex. For an explanation of duplex mode, refer to the section “Duplex Mode” on page 9.

Cabling

The RJ45 ports on the switch can use shielded or unshielded twisted pair cable. There are several categories of twisted pair cabling used in Ethernet networks. They are Category 3, 4, and 5. The main difference between the categories relates to their attenuation, which is a measurement of signal loss over the length of the cable. All cables experience attenuation. The signal loses strength the longer the cable. The lower the loss of signal, the lower the attenuation.

Of the three categories, Category 3 has the highest attenuation, meaning that it has the highest signal loss. It is adequate for 10 Mbps operation, but should never be used for 100 Mbps network operations. The higher speed requires Category 5. If you are installing a new network with end nodes operating at 10 Mbps, it is recommended that you install Category 5 instead of Category 3. This will save you the trouble of having to install new twisted pair cabling should you later upgrade your end nodes to 100 Mbps.

Maximum Distance

The maximum distance of a twisted pair cable is 100 meters (328 feet). Cable lengths that exceed this limit can result in poor or erratic network performance.

Auto MDI/MDI-X

An RJ45 twisted pair port on a 10 Mbps or 100 Mbps Ethernet network device can be wired as either MDI and MDI-X. Twisted pair ports on personal computers, routers, and bridges are typically wired as MDI. The twisted pair ports on switches and hubs are usually MDI-X.

When connecting two network devices together, you use straight-through twisted pair cabling when connecting two dissimilar ports together, such as an MDI port to an MDI-X port. To connect two similar ports together, such as an MDI port to an MDI port, you use a crossover twisted pair cable.

The twisted pair ports on the AT-FS705E FC and AT-FS706E FC can operate as either MDI or MDI-X. This feature eliminates the need for using a crossover cable with the switch. This means that you can use straight-through twisted pair cabling regardless of the type of end nodes you connect to the ports. Each port automatically determines the configuration of the port on the device to which it is connected and then configures itself appropriately. For example, if a port on a switch is connected to a port on a bridge, which is typically wired as MDI, the port on the switch automatically configures itself as MDI-X.

100 Mbps Fiber Optic Port

The AT-FS705E FC and AT-FS706E FC Ethernet switches feature one and two fiber optic ports, respectively. You can use the fiber optic ports to connect the switch to other switches or other end nodes over large distances.

Type of Connector

The AT-FS705E FC Series and the AT-FS706E FC Series switches come with a variety of fiber optic connectors. Contact your Allied Telesyn International sales representative for a list of available connector types.

Speed

The fiber optic port is compliant with the 100Base-FX standard and has a fixed operating speed of 100 Mbps. This speed cannot be changed; the end node that you connect to the fiber optic port on the switch must also be able to operate at 100 Mbps.

Duplex Mode Switch

The fiber optic port(s) is able to operate in either half- or full-duplex mode. The duplex mode is set with the 100FX DUPLEX switch located on the front of the switch. The AT-FS705E FC Series has one duplex switch for its one fiber optic port. The AT-FS706E FC Series has two duplex switches, one for each of its two fiber optic ports. For an explanation of duplex mode, “Duplex Mode” on page 9.

Cabling

There are two basic types of fiber optic cabling used in Ethernet networks: multimode fiber and single-mode fiber. Multimode fiber is for short distances, typically not more than 2 kilometers (1.25 miles). Single-mode is for longer distances. The fiber optic port(s) on the Ethernet switch has a maximum operating distance of 2 kilometers, and is designed to be used with either 54/125 or 60/125 micron core/cladding multimode cable.

Note

Do not use single-mode fiber optic cable with the fiber optic port(s) on the AT-FS705E FC and AT-FS706E FC Ethernet switches.

Maximum Distance

The maximum operating distance of the fiber optic ports on the AT-FS705E FC and AT-FS706E FC Ethernet switches is 2 kilometers (1.25 miles). Cable lengths that exceed this limit can result in poor or erratic network performance.

Note

The fiber optic port on the network device that you intend to connect to the AT-FS705E FC or AT-FS706E FC Ethernet switch must have the same operating characteristics as the fiber optic port on the switch. For example, the maximum operating distance and operating wavelength of the end node's fiber optic port should be the same as the switch's fiber optic port. For the technical specifications of the fiber optic port on the switch, refer to "Technical Specifications" on page 24.

Introduction to Ethernet Switching

An Ethernet switch is designed to manage the flow of data between the various devices that are connected to its ports.

MAC Address Table

The heart of an Ethernet switch is the Media Access Control (MAC) address table. Every device that you attach to an Ethernet network has a MAC address. This address is assigned to the device by the device's manufacturer. For example, each network interface card (NIC) that you install into your network computers has a MAC address that was assigned to it by the card's manufacturer.

A switch's MAC address table is a list of the MAC addresses of the devices that are connected to its ports. The switch uses this table to direct data frames to their appropriate destination end nodes, and in some cases, to discard frames that it receives. The switch creates the MAC address table by examining the frames that it receives on its ports. Each frame is examined for its source address; that is, the MAC address of the end node that sent the frame. The switch checks to determine whether the address is already in its MAC address table. If it is not, the switch adds the address to the table along with the port number on which the frame was received. The result is a table that contains a list of all the MAC addresses of end nodes that have sent frames to the switch and the ports on the switch to which the end nodes are connected.

The switch also checks the destination MAC address of each frame it receives. The destination address is the MAC address of the end node to which the frame is intended. If the address is in the table, the switch directs the frame directly to the port where the end node is located. This helps to ensure that end nodes will only receive traffic that is intended for them and not have to deal with traffic intended for other end nodes.

If the destination address is not in the MAC address table, the switch broadcasts the frame to all switch ports. When the destination node responds, the switch will be able to match the address to a port so that the next time a frame is destined to that particular end node, the switch will be able to forward the frame to the correct port instead of having to broadcast the frame to all ports.

In some cases a switch will even discard a frame. If the switch receives a frame that is destined to a node on the same port on which the frame was received, the switch discards the frame.

The MAC address table in the AT-FS705E FC Series and AT-FS706E FC Series switches can store up to 4,000 MAC addresses. To prevent the table from becoming filled with addresses of end nodes that are no longer active, the switch has a MAC address aging timer. This timer will delete a MAC address from the table if it does not see a frame from the end node with the address on any port after five minutes (300 seconds). The aging timer also helps to ensure that the table is correct should an end node be moved from one port on the switch to another port.

Store and Forward

The Ethernet switch uses store and forward as the method for receiving and transmitting frames. When a Ethernet frame is received on a switch port, the switch does not retransmit the frame out the destination port until it has received the entire frame and stored the frame in its memory buffer. It then examines the frame to determine if it is a valid frame. Invalid frames, such as fragments, are discarded by the switch. In this manner, the switch ensures that only valid frames are transmitted out its ports and that damaged frames are not propagated on your network.

Flow Control and Backpressure

In order for an Ethernet switch to maintain the orderly movement of data between the end nodes that are connected to its ports, it will occasionally need to signal an end node to stop sending data. This can occur under several situations. For example, when two end nodes are operating at different speeds, the switch, while transferring data between the nodes, might need to instruct the faster end node to stop transmitting data to allow the slower end node to catch up. An example of this situation would be when a server operating at 100 Mbps is sending data to a workstation operating at only 10 Mbps.

Another situation when a switch might need to stop the transmission of data from an end node is if two end nodes are vying for the same switch port at the same time. An example of this would be if two workstations were attempting to send data to the same network printer simultaneously. The switch could allow only one workstation to send out the port to the printer, and it would need to instruct the other workstation to delay data transmission.

To some degree, these conflicts are avoided by the switch's port buffers. These buffers are used to store data when a port is either already busy transmitting other data or when a transmitting port on a switch is operating at a slower speed than the port on the switch receiving data.

How a switch signals an end node to stop transmitting data differs depending on the speed of the end node and switch port. Ports operating at 10 Mbps use flow control while ports operating at 100 Mbps use backpressure.

For a 10 Mbps port, the switch will stop an end node from transmitting data by forcing a collision. A collision on an Ethernet network occurs when two nodes attempt to transmit data using the same data link at the same time. A collision causes end nodes to stop sending data. When the switch needs to stop a 10 Mbps end node from transmitting data, it forces a collision on the data link, which stops the end node. Once the switch is ready to receive data again, the switch stops forcing collisions.

A port running at 100 Mbps uses PAUSE frames, as specified in the IEEE 802.3x standard. Whenever the switch wants an end node running at 100 Mbps to stop transmitting data, it issues a PAUSE frame. The frame simply instructs the end node to cease transmission. The switch continues to issue PAUSE frames until it is ready to again receive data from the end node.

Duplex Mode

Duplex mode refers to the manner in which an end node handles the receiving and transmitting of data. If an end node can receive or transmit data, but not both at the same time, the end node is operating in what is referred to as half-duplex mode. If an end node can both receive and transmit data simultaneously, the node is operating in full-duplex mode. Naturally, a node capable of operating in full-duplex can handle data much faster than a node that can only operate in half-duplex.

Each port on an AT-FS705E FC Series switch and AT-FS706E FC Series switch can operate in either half- or full-duplex mode. The twisted pair ports are IEEE 802.3u-compliant and will auto-negotiate the duplex mode setting. If the end node connected to a twisted pair port on the switch is capable of full-duplex operation, the switch sets the twisted pair port to full-duplex. If the end node is capable of only half-duplex, the port is set automatically to half-duplex.

The duplex mode for the fiber optic port(s) must be set manually using the 100FX DUPLEX switch on the front panel of the switch. For the fiber optic port to function correctly, this switch must be set to correspond to the duplex mode capability of the end node connected to port.

System LEDs

The switch has a series of LEDs that you can use to determine the operating status of the system and the ports. The LEDs are described in Table 1.

Table 1 System and Port LEDs

LED	Color	Function
PWR	Steady Green	The switch is receiving power.
FD	Steady Green	The fiber optic port is operating in full-duplex mode.
	OFF	The fiber optic port is operating in half-duplex mode.
100M	Steady Green	The twisted pair port is operating at 100 Mbps.
	OFF	The twisted pair port is operating at 10 Mbps.
LNK/ACTY	Steady Green	The port has established a valid link with the end node connected to the port.
	Blinking Green	Activity is detected on the port.
	OFF	The port has not established a link with the end node.

Network Topologies

There are a variety of network topologies that you can create with the AT-FS705E FC and AT-FS706E FC Series switches. The first topology shown in Figure 3 is of a power workgroup. Each end node is connected directly to a port on an AT-FS705E FC switch, giving each node a dedicated 10 Mbps or 100 Mbps link.

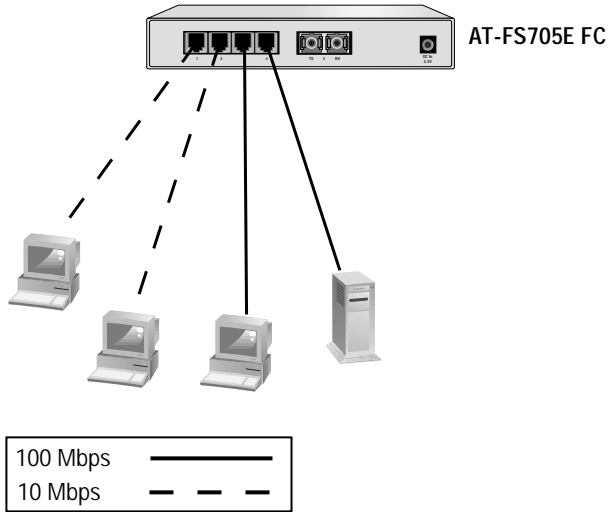

Figure 3 Power Workgroup Topology

In the topology illustrated in Figure 4, an AT-FS705E FC is used to connect together four 10/100 Mbps Ethernet hubs. Here the switch functions as a bridge between the different workgroups by controlling the flow of data between the workgroups. The switch transfers an Ethernet frame from hub to hub only when the destination node for the frame is on a different hub than the node that originated the frame. This reduces the amount of unnecessary data traffic in each workgroup. This frees up bandwidth and improves network performance.

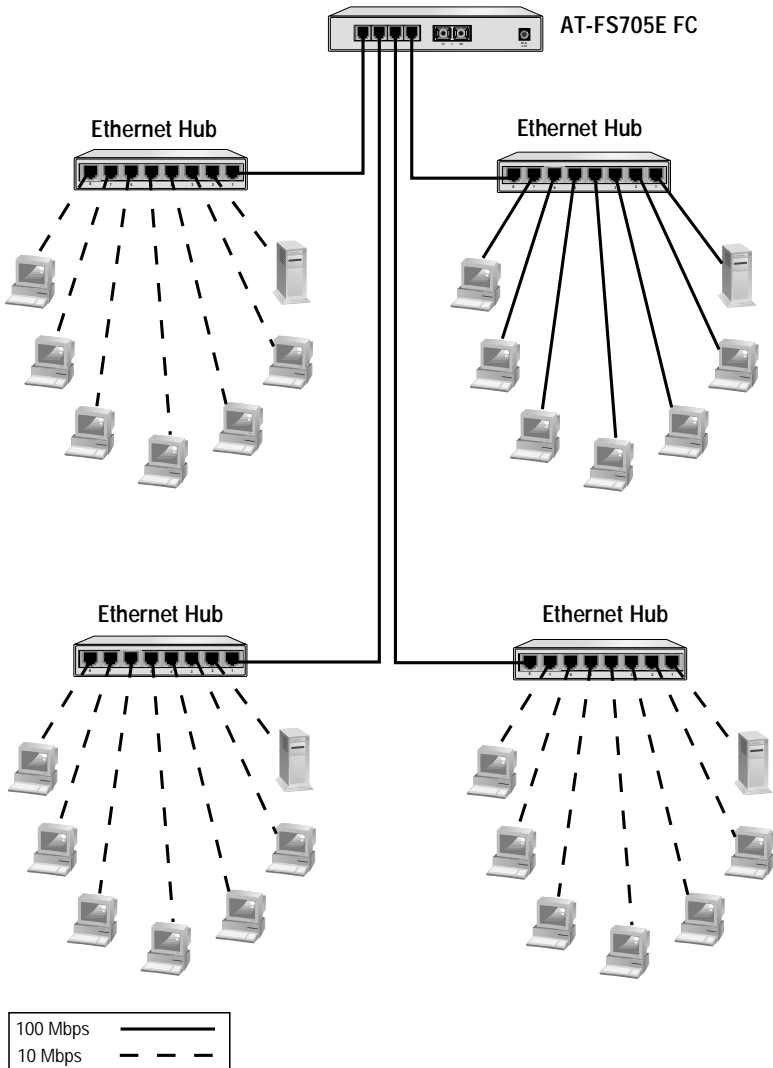

Figure 4 Ethernet Hub Topology

If your network consists of several AT-FS705E FC and AT-FS706E FC switches, then you will probably want to connect them together to form an integrated network. Here the fiber optic ports can be extremely useful. You can use the ports to create a fiber optic backbone. With a maximum operating distance of 2 kilometers (1.25 miles), the ports can be used to connect together switches that are physically far apart. In the topology shown in Figure 5, two AT-FS705E FC switches and one AT-FS706E FC switch have been interconnected using the fiber optic ports.

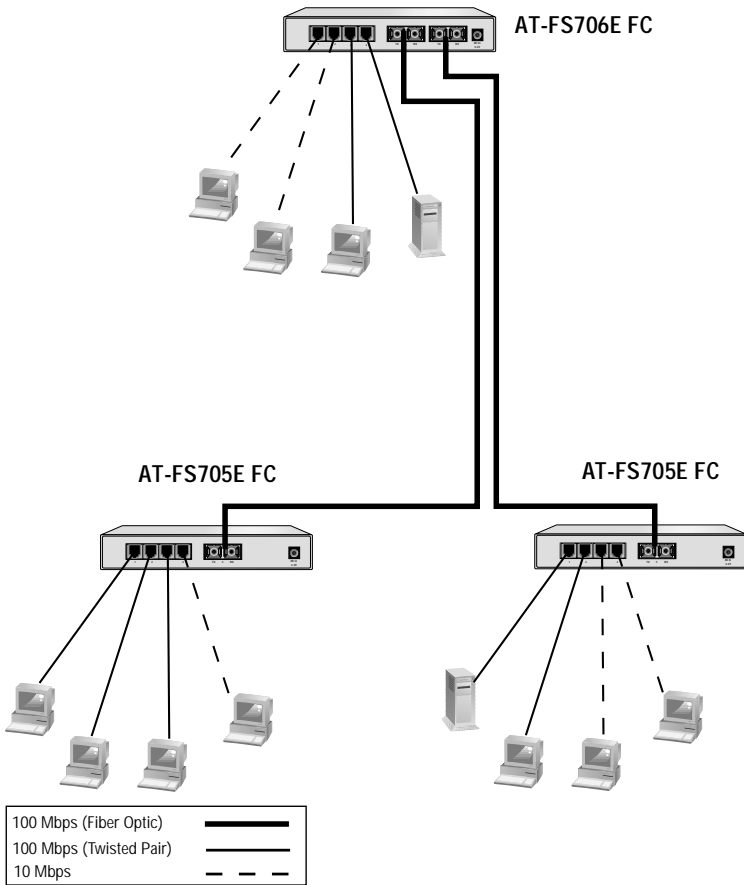

Figure 5 Backbone Topology

If you have more than three AT-FS705E FC or AT-FS706E FC switches that you want to connect together, then you might use an 100Base Ethernet switch that has multiple fiber optic ports to act as a backbone switch. This switch will function as the connection focal point for all the AT-FS705E FC and AT-FS706E FC switches in your network. This is often referred to as a collapsed backbone. An example of this topology is illustrated in Figure 6. Five AT-FS705 Ethernet Switches have been interconnected using an AT-8216FXL Fast Ethernet Switch.

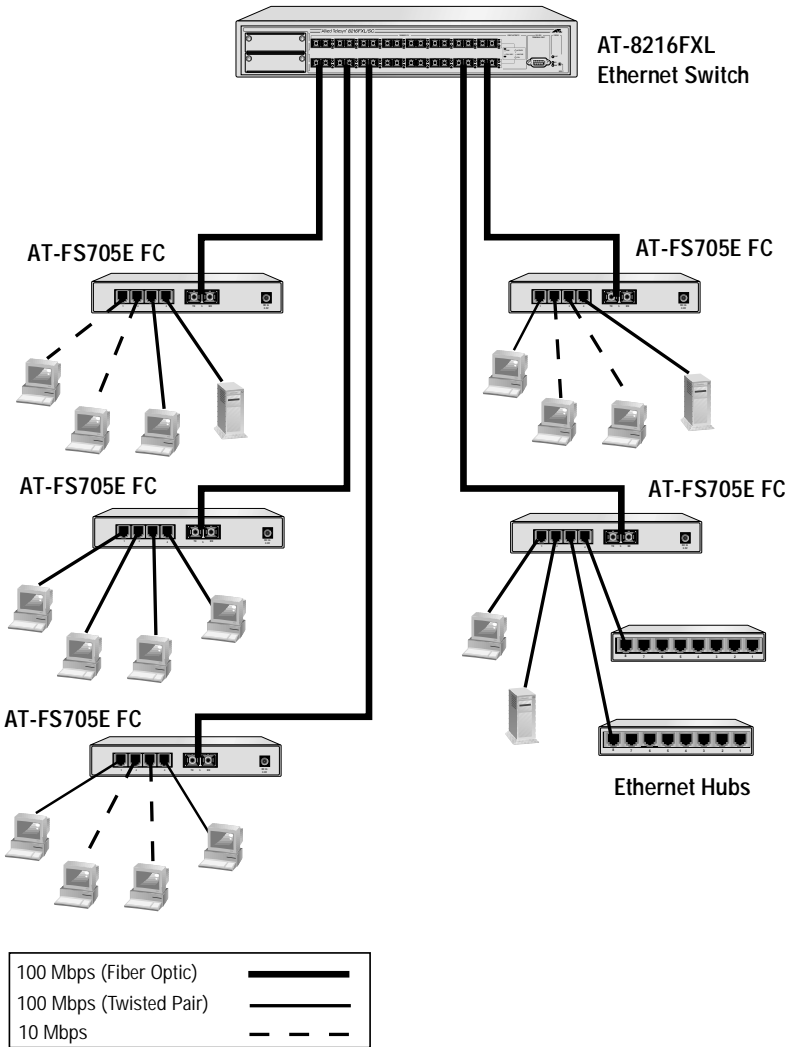

Figure 6 Collapsed Backbone Topology

In designing a network topology, be sure your topology does not contain any loops. A loop exists when there is more than one path between any two end nodes in your network. A loop can result in what is referred to as broadcast storms, where Ethernet frames become caught in repeating cycles that needlessly consume network bandwidth. This often results in poor network performance. An example of an invalid loop topology is shown in Figure 7.

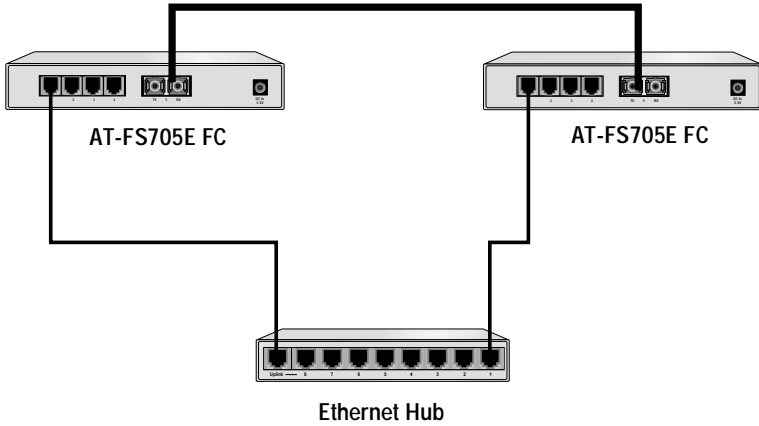

Figure 7 Invalid Loop Topology

Chapter 2

Installing the Switch

This chapter contains the installation instructions for the AT-FS705E FC and AT-706E FC Ethernet switches.

Reviewing Safety Guidelines

Please review the following safety guidelines before you begin to install the Ethernet switch.



Warning

Class 1 laser product. ⚡ 5



Warning

Do not stare into the laser beam. ⚡ 6



Warning

Electric Shock Hazard: To prevent electric shock, do not remove the cover. There are no user-serviceable parts inside. The unit contains hazardous voltages and should only be opened by a trained and qualified technician. ⚡ 7



Warning

Lightning Danger: Do not work on this equipment or cables during periods of lightening activity. ⚡ 8



Warning

Power cord is used as a disconnection device: To de-energize equipment, disconnect the power cord. ⚡ 9

**Caution**

Pluggable Equipment: The socket outlet should be installed near the equipment and should be easily accessible. *↪* 10

**Caution**

Air vents: The air vents must not be blocked on the unit and must have free access to the room ambient air for cooling. *↪* 11

**Caution**

Operating Temperature: This product is designed for a maximum ambient temperature of 40°C. *↪* 12

**Caution**

All Countries: Install this product in accordance with local and National Electric Codes. *↪* 13

Verifying the Package Contents

Make sure the following components are included in the switch package. If any item is missing or damaged, contact your Allied Telesyn International sales representative for assistance.

- One AT-FS705E FC or AT-FS706E FC Ethernet Switch
- One external power adapter
- This installation guide
- Warranty card

Selecting a Site for the Switch

Be sure to observe the following requirements when choosing a site for your switch:

- ❑ Make sure that the switch's power is accessible and cables can be easily connected.
- ❑ Air flow around the switch and through its vents on the side and rear must not be restricted.
- ❑ If you are installing the switch on a desk, make sure it is placed on a level, secure desktop.
- ❑ Do not place objects on top of the switch.
- ❑ Do not expose the switch to moisture or water.
- ❑ Make sure it is in a dust-free environment.
- ❑ Use dedicated power circuits or power conditioners to supply reliable electrical power to the network devices.

Installing the Twisted Pair and Fiber Optic Cabling

When installing the twisted pair cable for your network, be sure to observe the following guidelines:

- ❑ For 10Base-T operation (10 Mbps), use Category 3 100-ohm or better shielded or unshielded twisted pair cabling.
- ❑ For 100Base-TX operation (100 Mbps), use Category 5 100-ohm or better shielded or unshielded twisted pair cabling.
- ❑ The maximum length for a twisted pair cable is 100 meters (328 feet).
- ❑ Since the twisted pair ports automatically configure themselves as either MDI or MDI-X, you can use either straight-through or crossover twisted pair cabling, regardless of the type of end node that you are connecting to each port.
- ❑ Cabling should be kept away from sources of electrical noise such as radios, transmitters, broadband amplifiers, power lines, electric motors, and fluorescent fixtures.

When installing the fiber optic cabling for your network, be sure to observe the following guidelines:

- ❑ The fiber optic port on the switch requires either 54/125 or 60/125 micron core/cladding multimode fiber optic cable.
- ❑ The maximum operating distance of the fiber optic port on the switch is 2 kilometers (1.25 miles).

Installing the Switch On a Table or Desktop

To install the switch on a table or desktop, perform the following procedure:

1. Remove all components from the shipping package and store the packaging material in a safe location.
2. Locate a level, secure surface for the switch.

Note

If desired, you can affix the switch to a flat surface using the two threaded screw holes on the bottom of the chassis. The holes use M4 screws (not provided) and are 100 millimeters (3.94 inches) apart.

3. Power ON the switch using the external power adapter supplied with the unit. Connect the external power adapter to an appropriate power source and the DC cable on the adapter to the DC connector on the switch.

The PWR LED on the switch's front panel should be ON. If the LED remains OFF, refer to "Verifying and Troubleshooting the Installation" on page 22 for assistance.



Warning

The power cord is used as a disconnection device. To de-energize equipment, disconnect the power cord. *See* 9

Note

To prevent the DC power cable from being inadvertently pulled out of the switch, use the cable tie supplied with the unit to secure the DC power cable to the small cable hook located next to the DC connector.

4. Connect the twisted pair cables to the RJ45 connectors on the switch.
5. Remove the dust cover from the fiber optic port and connect the fiber optic cable to the port.
6. Set the 100FX DUPLEX switch to either HALF for half-duplex or FULL for full-duplex operation. The capabilities of the end node connected to the fiber optic port will determine the correct setting for this switch. If the end node is capable of only half-duplex, set the switch to HALF. If the end node is capable of full-duplex, set the switch to FULL.

The AT-FS705E FC switch has one 100FX DUPLEX switch for its one fiber optic port. The AT-FS706E FC switch has two switches for its two fiber optic ports.

7. Power ON the end nodes connected to the ports on the switch.
8. Check the LNK/ACTY LED for each port. The LED should be steady green or blinking. If a LNK/ACTY LED remains OFF, refer to “Verifying and Troubleshooting the Installation” on page 22 for assistance.

Installing the Switch on a Wall

The switch can be mounted either vertically or horizontally on a wall using the keyholes on the bottom of the chassis.

Note

For wall-mount installation, you must supply the two screws and plastic anchors or other material necessary to mount the device on the wall.

To install the switch on the wall, perform the following procedure:

1. Remove the rubber feet, all cables, and the DC power cord from the switch.
2. Select a wall location for the device.
3. Install two plastic anchors and two pan-head screws into the wall, separated by 100 millimeters (3.94 inches).
4. Position the device onto the wall screws. If you are mounting the switch horizontally, position the switch so that the ports are facing down and the LEDs are facing up. If you are mounting the switch vertically, position the switch so that the ports are facing to the left and the LEDs to the right.
5. Power ON the switch using the external power adapter supplied with the unit. Connect the external power adapter to an appropriate power source and the DC cable on the adapter to the DC connector on the switch.

The PWR LED on the switch’s front panel should be ON. If the LED remains OFF, refer to “Verifying and Troubleshooting the Installation” on page 22 for assistance.



Warning

The power cord is used as a disconnection device. To de-energize equipment, disconnect the power cord. ⚡

Note

To prevent the DC power cable from being inadvertently pulled out of the switch, use the cable tie supplied with the unit to secure the DC power cable to the small cable hook located next to the DC connector.

6. Connect the twisted pair cables to the RJ45 connectors on the switch.
7. Remove the dust cover from the fiber optic port and connect the fiber optic cable to the port.
8. Set the 100FX DUPLEX switch to either HALF for half-duplex or FULL for full-duplex operation. The capabilities of the end node connected to the fiber optic port will determine the correct setting for this switch. If the end node is capable of only half-duplex, set the switch to HALF. If the end node is capable of full-duplex, set the switch to FULL.

The AT-FS705E FC switch has one 100FX DUPLEX switch for its one fiber optic port. The AT-FS706E FC switch has two switches for its two fiber optic ports.

9. Power ON the end nodes connected to the ports on the switch.
10. Check the LNK/ACTY LED for each port. The LED should be steady green or blinking. If a LNK/ACTY LED remains OFF, refer to “Verifying and Troubleshooting the Installation.” for assistance.

Verifying and Troubleshooting the Installation

This section contains information on how to verify the installation of the switch and how to troubleshoot the unit in the event a problem occurs.

Check the PWR LED on the front of the switch. If the LED is OFF, indicating that the unit is not receiving power, do the following:

- Make sure that the power adapter is securely connected to a power source and that the DC power cord on the adapter is securely connected to the DC power connector on the switch.
- Verify that the power outlet has power by connecting another device to it.
- Try connecting the unit to another power source.
- Try using another power adapter.

Verify that the LNK/ACTY LED for each twisted pair port is either on or blinking. If an LED is off, do the following:

- ❑ Verify that the end node connected to the port is powered ON and is operating properly.
- ❑ Check that the twisted pair cable is securely connected to the port on the switch and to the port on the end node.
- ❑ Make sure that the twisted pair cable does not exceed 100 meters (328 feet).

Check that the LNK/ACTY LED for the fiber optic port is steady green or blinking. If the LED is off, do the following:

- ❑ Verify that the end node connected to the port is powered ON and is operating properly.
- ❑ Check that the fiber optic cable is securely connected to the port on the switch and to the port on the end node.
- ❑ Make sure that the cable connected to the fiber optic receiver port on the switch is connected to the transmitter port on the remote end node and that the fiber optic transmitter port on the switch is connected to the receiver port on the end node.
- ❑ Test the attenuation on the fiber cable to ensure that it does not exceed acceptable values.
- ❑ Verify that you are using the appropriate type of fiber optic cabling and that you have not exceeded the allowable maximum distance. For information, refer to the “Installing the Twisted Pair and Fiber Optic Cabling” on page 19
- ❑ Make sure that the 100FX DUPLEX switch is set correctly. The switch should be set to match the duplex mode of the end node connected to the fiber optic port.
- ❑ Check that the operating specifications (e.g., wavelength and maximum operating distance) of the fiber optic port on the end node are compatible with the operating specifications of the fiber optic port on the Ethernet switch.

Note

See “Technical Specifications” on page 24 for the operating specifications of the fiber optic port on the switch.

Warranty Registration

When you have finished installing the switch, you should register your product by completing the enclosed warranty card and sending it in, or by visiting our web site at www.alliedtelesyn.com/forms/warranty.htm and completing the on-line registration.

Technical Specifications

Table 6 lists the switch specifications.

Table 2 Technical Specifications

Physical Specifications	
Dimensions (H x W x D)	1.7 cm x 17.9 cm x 9.8 cm (0.7 in x 7 in x 3.9 in)
Weight	0.42 kg (0.9 lbs)
Required Ventilation (all sides)	19 cm (7.5 in)
Environmental Specifications	
Operating Temperature	0° to 40° C (32° to 104° F)
Storage Temperature	-25° to 70° C (-13° to 158° F)
Operating Humidity	5% to 95% non-condensing
Operating Altitude Range	up to 3,000 m (9,843 ft)
Power Specifications	
Power Adapter Input	100-120VAC, 1.0A maximum, 50/60Hz or 200-240VAC, 1.0A maximum, 50/60Hz
Power Adapter Output	3.3VDC - 3.5VDC, 1.5A
Fiber Optic Port(s)	
Maximum Distance	2 kilometers (1.25 miles)
Type of Cable	50/125 µm or 62.5/125 µm multimode fiber
Wavelength	1310 nanometers

Table 2 Technical Specifications (continued)

Launch Power (dBm)	Using 50/125 μm fiber: Max.: -14.0 Min.: -22.5 Avg.: -20.3 Using 62.5/125 μm fiber Max.: -14.0 Min.: -19.5 Avg.: -16.8
Receiver Power	Using 50/125 μm fiber or 62.5/125 μm fiber: Max.: -31.8 Min.: -14.0 Avg.: -34.5

Appendix A

Translated Electrical Safety Emission Information

Important: This appendix contains multiple-language translations for the safety statements in this guide.

Wichtig: Dieser Anhang enthält Übersetzungen der in diesem Handbuch enthaltenen Sicherheitshinweise in mehreren Sprachen.

Viktigt: Dette tillæg indeholder oversættelser i flere sprog af sikkerhedsadvarslerne i denne håndbog.

Belangrijk: Deze appendix bevat vertalingen in meerdere talen van de veiligheidsopmerkingen in deze gids.

Important: Cette annexe contient la traduction en plusieurs langues des instructions de sécurité figurant dans ce guide.

Tärkeää: Tämä liite sisältää tässä oppaassa esiintyvät turvaohjeet usealla kielellä.

Importante: questa appendice contiene traduzioni in più lingue degli avvisi di sicurezza di questa guida.

Viktig: Dette tillegget inneholder oversettelser til flere språk av sikkerhetsinformasjonen i denne veiledningen.

Importante: Este anexo contém traduções em vários idiomas das advertências de segurança neste guia.

Importante: Este apéndice contiene traducciones en múltiples idiomas de los mensajes de seguridad incluidos en esta guía.

Obs! Denna bilaga innehåller flerspråkiga översättningar av säkerhetsmeddelandena i denna handledning.

Standards: This product meets the following standards.

U.S. Federal Communications Commission

RADIATED ENERGY











Note: This equipment has been tested and found to comply with the limits for a Class A digital device pursuant to Part 15 of FCC Rules. These limits are designed to provide reasonable protection against harmful interference when the equipment is operated in a commercial environment. This equipment generates, uses, and can radiate radio frequency energy and, if not installed and used in accordance with this instruction manual, may cause harmful interference to radio communications. Operation of this equipment in a residential area is likely to cause harmful interference in which case the user will be required to correct the interference at his own expense.

Note: Modifications or changes not expressly approved of by the manufacturer or the FCC, can void your right to operate this equipment.











Industry Canada

This Class A digital apparatus meets all requirements of the Canadian Interference-Causing Equipment Regulations.





Cet appareil numérique de la classe A respecte toutes les exigences du Règlement sur le matériel brouilleur du Canada.







- 1 RFI Emission FCC Part 15 (Class A), EN55022 (Class A)
- 2  **WARNING:** In a domestic environment this product may cause radio interference in which case the user may be required to take adequate measures.
- 3 Immunity EN55024
- 4 Electrical Safety UL 1950 (UL/cUL), EN60950 (TUV), EN60825
- 5  **WARNING:** Class 1 Laser product.
- 6  **WARNING:** Do not stare into the laser beam.
- 7  **ELECTRICAL NOTICES**
WARNING: ELECTRIC SHOCK HAZARD
To prevent ELECTRIC shock, do not remove the cover. No user-serviceable parts inside. This unit contains HAZARDOUS VOLTAGES and should only be opened by a trained and qualified technician. To avoid the possibility of ELECTRIC SHOCK, disconnect electric power to the product before connecting or disconnecting the LAN cables.
- 8  **LIGHTNING DANGER**
DANGER: DO NOT WORK on equipment or CABLES during periods of LIGHTNING ACTIVITY.
- 9  **CAUTION: POWER CORD IS USED AS A DISCONNECTION DEVICE. TO DE-ENERGIZE EQUIPMENT,** disconnect the power cord.
- 10  **PLUGGABLE EQUIPMENT,** the socket outlet shall be installed near the equipment and shall be easily accessible.
- 11  **CAUTION:** Air vents must not be blocked and must have free access to the room ambient air for cooling.
- 12  **OPERATING TEMPERATURE:** This product is designed for a maximum ambient temperature of 40° degrees C.
- 13  **ALL COUNTRIES:** Install product in accordance with local and National Electrical Codes.

Normen: Dieses Produkt erfüllt die Anforderungen der nachfolgenden Normen.











- 1 Hochfrequenzstörung FCC Part 15 (Class A), EN55022 (Class A)
- 2  **WARNUNG:** Bei Verwendung zu Hause kann dieses Produkt Funkstörungen hervorrufen. In diesem Fall müßte der Anwender angemessene Gegenmaßnahmen ergreifen.
- 3 Störsicherheit EN55024
- 4 Elektrische Sicherheit UL 1950 (UL/cUL), EN60950 (TUV), EN60825
- 5  **WARNUNG:** Laserprodukt der Klasse 1.
- 6  **WARNUNG:** Nicht direkt in den Strahl blicken.
- 7  **ACHTUNG: GEFÄHRLICHE SPANNUNG**
Das Gehäuse nicht öffnen. Das Gerät enthält keine vom Benutzer wartbaren Teile. Das Gerät steht unter Hochspannung und darf nur von qualifiziertem technischem Personal geöffnet werden. Vor Anschluß der LAN-Kabel, Gerät vom Netz trennen.
- 8  **GEFAHR DURCH BLITZSCHLAG**
GEFAHR: Keine Arbeiten am Gerät oder an den Kabeln während eines Gewitters ausführen.
- 9  **VORSICHT: DAS NETZKABEL DIENT ZUM TRENNEN DER STROMVERSORGUNG. ZUR TRENNUNG VOM NETZ, KABEL AUS DER STECKDOSE ZIEHEN.**
- 10  **STECKBARES GERÄT:** Die Anschlußbuchse sollte in der Nähe der Einrichtung angebracht werden und leicht zugänglich sein."
- 11  **VORSICHT**
Die Entlüftungsöffnungen dürfen nicht versperrt sein und müssen zum Kühlen freien Zugang zur Raumluft haben.
- 12  **BETRIEBSTEMPERATUR:** Dieses Produkt wurde für den Betrieb in einer Umgebungstemperatur von nicht mehr als 40° C entworfen.
- 13  **ALLE LÄNDER:** Installation muß örtlichen und nationalen elektrischen Vorschriften entsprechen.

Standarder: Dette produkt tilfredsstiller de følgende standarder.











- 1 Radiofrekvens forstyrrelsesemission FCC Part 15 (Class A), EN55022 (Class A)
- 2  **ADVARSEL:** I et hjemligt miljø kunne dette produkt forårsage radio forstyrrelse. Bliver det tilfældet, påkræves brugeren muligvis at tage tilstrækkelige foranstaltninger.
- 3 Immunitet EN55024
- 4 Elektrisk sikkerhed UL 1950 (UL/cUL), EN60950 (TUV), EN60825
- 5  **ADVARSEL** Laserprodukt av klasse 1.
- 6  **ADVARSEL** Stirr ikke på strålen.
- 7  **ELEKTRISKE FORHOLDSREGLER**
ADVARSEL: RISIKO FOR ELEKTRISK STØD
For at forebygge ELEKTRISK stød, undlad at åbne apparatet. Der er ingen indre dele, der kan repareres af brugeren. Denne enhed indeholder LIVSFARLIGE STRØMSPÆNDINGER og bør kun åbnes af en uddannet og kvalificeret tekniker. For at undgå risiko for ELEKTRISK STØD, afbrydes den elektriske strøm til produktet, før LAN-kablerne monteres eller afmonteres.

- 8  **FARE UNDER UVEJR**
FARE: UNDLAD at arbejde på udstyr eller KABLER i perioder med LYNAKTIVITET.
- 9  **ADVARSEL:** DEN STRØMFØRENDE LEDNING BRUGES TIL AT AFBRYDE STRØMMEN. SKAL STRØMMEN TIL APPARATET AFBRYDES, tages ledningen ud af stikket.
- 10  **UDSTYR TIL STIKKONTAKT,** stikkontakten bør installeres nær ved udstyret og skal være lettilgængelig.
- 11  **ADVARSEL:** Ventilationsåbninger må ikke blokeres og skal have fri adgang til den omgivende luft i rummet for afkøling.
- 12  **BETJENINGSTEMPERATUR:** Dette apparat er konstrueret til en omgivende temperatur på maksimum 40 grader C.
- 13  **ALLE LANDE:** Installation af produktet skal ske i overensstemmelse med lokal og national lovgivning for elektriske installationer.



Eisen: Dit product voldoet aan de volgende eisen.







- 1 RFI Emissie FCC Part 15 (Class A), EN55022 (Class A)
- 2  **WAARSCHUWING:** Binnenshuis kan dit product radiostoring veroorzaken, in welk geval de gebruiker verplicht kan worden om gepaste maatregelen te nemen.
- 3 Immunitet EN55024
- 4 Electricische Veiligheid UL 1950 (UL/cUL), EN60950 (TUV), EN60825
- 5  **WAARSHUWING** Klasse-1 laser produkt.
- 6  **WAARCHUWING** Niet in de straal staren.
- 7  **WAARSCHUWINGEN MET BETREKKING TOT ELEKTRICITEIT**
WAARSCHUWING: GEVAAR VOOR ELEKTRISCHE SCHOKKEN
 Verwijder het deksel niet, teneinde ELEKTRISCHE schokken te voorkomen. Binnenin bevinden zich geen onderdelen die door de gebruiker onderhouden kunnen worden. Dit toestel staat onder GEVAARLIJKE SPANNING en mag alleen worden geopend door een daartoe opgeleide en bevoegde technicus. Om het gevaar op ELEKTRISCHE SCHOKKEN te vermijden, moet u het toestel van de stroombron ontkoppelen alvorens de LAN-kabels te koppelen of ontkoppelen.
- 8  **GEVAAR VOOR BLIKSEMINSLAG**
GEVAAR: NIET aan toestellen of KABELS WERKEN bij BLIKSEM.
- 9  **WAARSCHUWING:** HET TOESTEL WORDT UITGESCHAKELD DOOR DE STROOMKABEL TE ONTKOPPELEN. OM HET TOESTEL STROOMLOOS TE MAKEN: de stroomkabel ontkoppelen.
- 10  **AAN TE SLUITEN APPARATUUR,** de contactdoos wordt in de nabijheid van de apparatuur geïnstalleerd en is gemakkelijk te bereiken."
- 11  **OPGELET:** De ventilatiegaten mogen niet worden gesperd en moeten de omgevingslucht ongehinderd toelaten voor afkoeling.
- 12  **BEDRIJFSTEMPERATUUR:** De omgevingstemperatuur voor dit produkt mag niet meer bedragen dan 40 graden Celsius.
- 13  **ALLE LANDEN:** het toestel installeren overeenkomstig de lokale en nationale elektrische voorschriften.

Normes: ce produit est conforme aux normes de suivantes:









- 🌀 1 Emission d'interférences radioélectriques FCC Part 15 (Class A), EN55022 (Class A)
- 🌀 2  **MISE EN GARDE** : dans un environnement domestique, ce produit peut provoquer des interférences radioélectriques. Auquel cas, l'utilisateur devra prendre les mesures adéquates.
- 🌀 3 Immunité EN55024
- 🌀 4 Sécurité électrique UL 1950 (UL/cUL), EN60950 (TUV), EN60825
- 🌀 5  **ATTENTION** Produit laser di classe 1.
- 🌀 6  **ATTENTION** Ne pas fixer le faisceau des yeux.
- 🌀 7  **INFORMATION SUR LES RISQUES ÉLECTRIQUES**
AVERTISSEMENT: DANGER D'ÉLECTROCUTION
Pour éviter toute ÉLECTROCUTION, ne pas ôter le revêtement protecteur du matériel. Ce matériel ne contient aucun élément réparable par l'utilisateur. Il comprend des TENSIONS DANGEREUSES et ne doit être ouvert que par un technicien dûment qualifié. Pour éviter tout risque d'ÉLECTROCUTION, débrancher le matériel avant de connecter ou de déconnecter les câbles LAN.
- 🌀 8  **DANGER DE Foudre**
DANGER: NE PAS MANIER le matériel ou les CÂBLES lors d'activité orageuse.
- 🌀 9  **ATTENTION: LE CORDON D'ALIMENTATION SERT DE MISE HORS CIRCUIT. POUR COUPER L'ALIMENTATION DU MATÉRIEL, débrancher le cordon.**
- 🌀 10  **EQUIPEMENT POUR BRANCHEMENT ELECTRIQUE**, la prise de sortie doit être placée près de l'équipement et facilement accessible".
- 🌀 11  **ATTENTION:** Ne pas bloquer les fentes d'aération, ceci empêcherait l'air ambiant de circuler librement pour le refroidissement.
- 🌀 12  **TEMPÉRATURE DE FONCTIONNEMENT:** Ce matériel est capable de tolérer une température ambiante maximum de ou 40 degrés Celsius.
- 🌀 13  **POUR TOUS PAYS:** Installer le matériel conformément aux normes électriques nationales et locales.



Standardit: Tämä tuote on seuraavien standardien mukainen.

- 🌀 1 Radioaaltojen häirintä FCC Part 15 (Class A), EN55022 (Class A)
- 🌀 2  **VAROITUS:** Kotiolosuhteissa tämä laite voi aiheuttaa radioaaltojen häiröitä, missä tapauksessa laitteen käyttäjän on mahdollisesti ryhdyttävä tarpeellisiin toimenpiteisiin.
- 🌀 3 Kestävyys EN55024
- 🌀 4 Sähköturvallisuus UL 1950 (UL/cUL), EN60950 (TUV), EN60825
- 🌀 5  **VAROITUS** Luokan 1 Lasertuote.
- 🌀 6  **VARIOTUS** Älä katso säteeseen.











- 7  **SÄHKÖÖN LIITTYVIÄ HUOMAUTUKSIA**
VAROITUS: SÄHKÖISKUVAARA
 Estääksesi SÄHKÖISKUN älä poista kantta. Sisällä ei ole käyttäjän huollettavissa olevia osia. Tämä laite sisältää VAARALLISIA JÄNNITTEITÄ ja sen voi avata vain koulutettu ja pätevä teknikko. Vältääksesi SÄHKÖISKUN mahdollisuuden katkaista sähkövirta tuotteeseen ennen kuin liität tai irrotat paikallisverkon (LAN) kaapelit.
- 8  **SALAMANISKUVAARA**
HENGENVAARA: ÄLÄ TYÖSKENTELE laitteiden tai KAAPELEIDEN KANSSA SALAMOINNIN AIKANA.
- 9  **HUOMAUTUS: VIRTAJOHTOA KÄYTETÄÄN VIRRANKATKAISULAITTEENA.**
 VIRTA KATKAISTAAN irrottamalla virtajohto.
- 10  **PISTORASIAAN KYTKETTÄVÄ LAITE;** pistorasia on asennettava laitteen lähelle ja siihen on oltava esteetön pääsy."
- 11  **HUOMAUTUS:** Ilmavaihtoreikiä ei pidä tukkia ja niillä täytyy olla vapaa yhteys ympäröivään huoneilmaan, jotta ilmanvaihto tapahtuisi.
- 12  **KÄYTTÖLÄMPÖTILA:** Tämä tuote on suunniteltu ympäröivän ilman maksimilämpötilalle 40°C.
- 13  **KAIKKI MAAT:** Asenna tuote paikallisten ja kansallisten sähköturvallisuusmääräysten mukaisesti.

Standard: Questo prodotto è conforme ai seguenti standard.



- 1 Emissioni RFI (interferenza di radiofrequenza) FCC Part 15 (Class A), EN55022 (Class A)
- 2  **AVVERTENZA:** in ambiente domestico questo prodotto potrebbe causare radio interferenza. In questo caso potrebbe richiedersi all'utente di prendere gli adeguati provvedimenti.
- 3 Immunità EN55024
- 4 Sicurezza elettrica UL 1950 (UL/cUL), EN60950 (TUV), EN60825
- 5  **AVVERTENZA** Prodotto laser di Classe 1.
- 6  **AVVERTENZA** Non fissare il raggio con gli occhi.
- 7  **AVVERTENZE ELETTRICHE**
ATTENZIONE: PERICOLO DI SCOSSE ELETTRICHE
 Per evitare SCOSSE ELETTRICHE non asportare il coperchio. Le componenti interne non sono riparabili dall'utente. Questa unità ha TENSIONI PERICOLOSE e va aperta solamente da un tecnico specializzato e qualificato. Per evitare ogni possibilità di SCOSSE ELETTRICHE, interrompere l'alimentazione del dispositivo prima di collegare o staccare i cavi LAN.
- 8  **PERICOLO DI FULMINI**
PERICOLO: NON LAVORARE sul dispositivo o sui CAVI durante PRECIPITAZIONI TEMPORALESCHIE.
- 9  **ATTENZIONE: IL CAVO DI ALIMENTAZIONE È USATO COME DISPOSITIVO DI DISATTIVAZIONE. PER TOGLIERE LA CORRENTE AL DISPOSITIVO** staccare il cavo di alimentazione.
- 10  **APPARECCHIATURA COLLEGABILE,** la presa va installata vicino all'apparecchio per risultare facilmente accessibile".
- 11  **ATTENZIONE:** le prese d'aria non vanno ostruite e devono consentire il libero ricircolo dell'aria ambiente per il raffreddamento.







- 12  **TEMPERATURA DI FUNZIONAMENTO:** Questo prodotto è concepito per una temperatura ambientale massima di 40 gradi centigradi.
- 13  **TUTTI I PAESI:** installare il prodotto in conformità delle vigenti normative elettriche nazionali.

Sikkerhetsnormer: Dette produktet tilfredsstiller følgende sikkerhetsnormer.









- 1 RFI stråling FCC Part 15 (Class A), EN55022 (Class A)
- 2  **ADVARSEL:** Hvis dette produktet benyttes til privat bruk, kan produktet forårsake radioforstyrrelse. Hvis dette skjer, må brukeren ta de nødvendige forholdsregler.
- 3 Immunitet EN55024
- 4 Elektrisk sikkerhet UL 1950 (UL/cUL), EN60950 (TUV), EN60825
- 5  **ADVARSEL** Laserprodukt av klasse 1.
- 6  **ADVARSEL** Stirr ikke på strålen.
- 7  **ELEKTRISITET**
ADVARSEL: FARE FOR ELEKTRISK SJOKK
 For å unngå ELEKTRISK sjokk, må dekslet ikke tas av. Det finnes ingen deler som brukeren kan reparere på innsiden. Denne enheten inneholder FARLIGE SPENNINGER, og må kun åpnes av en faglig kvalifisert tekniker. For å unngå ELEKTRISK SJOKK må den elektriske strømmen til produktet være avslått før LAN-kablene til- eller frakobles.
- 8  **FARE FOR LYNNEDSLAG**
FARE: ARBEID IKKE på utstyr eller KABLER i TORDENVÆR.
- 9  **FORSIKTIG: STRØMLEDNINGEN BRUKES TIL Å FRAKOBLE UTSTYRET. FOR Å DEAKTIVISERE UTSTYRET, må strømforsyningen kobles fra.**
- 10  **UTSTYR FOR STIKKONTAKT.** Stikkontakten skal monteres i nærheten av utstyret og skal være lett tilgjengelig."
- 11  **FORSIKTIG:** Lufteventilene må ikke blokkeres, og må ha fri tilgang til luft med romtemperatur for avkjøling.
- 12  **DRIFTSTEMPERATUR:** Dette produktet er konstruert for bruk i maksimum romtemperatur på 40 grader celsius.
- 13  **ALLE LAND:** Produktet må installeres i samsvar med de lokale og nasjonale elektriske koder.



Padrões: Este produto atende aos seguintes padrões.

- 1 Emissão de interferência de radiofrequência FCC Part 15 (Class A), EN55022 (Class A)
- 2  **AVISO:** Num ambiente doméstico este produto pode causar interferência na radiorrecepção e, neste caso, pode ser necessário que o utente tome as medidas adequadas.
- 3 Imunidade EN55024
- 4 Segurança Eléctrica UL 1950 (UL/cUL), EN60950 (TUV), EN60825
- 5  **AVISO** Produto laser de classe 1.
- 6  **AVISO** Não olhe fixamente para o raio.











- 7  **AVISOS SOBRE CARACTERÍSTICAS ELÉTRICAS**
ATENÇÃO: PERIGO DE CHOQUE ELÉTRICO
 Para evitar CHOQUE ELÉTRICO, não retire a tampa. Não contém peças que possam ser consertadas pelo usuário. Este aparelho contém VOLTAGENS PERIGOSAS e só deve ser aberto por um técnico qualificado e treinado. Para evitar a possibilidade de CHOQUE ELÉTRICO, desconecte o aparelho da fonte de energia elétrica antes de conectar e desconectar os cabos da LAN.
- 8  **PERIGO DE CHOQUE CAUSADO POR RAIOS**
PERIGO: NÃO TRABALHE no equipamento ou nos CABOS durante períodos suscetíveis a QUEDAS DE RAIOS.
- 9  **CUIDADO: O CABO DE ALIMENTAÇÃO É UTILIZADO COMO UM DISPOSITIVO DE DESCONEXÃO. PARA DESELETRIFICAR O EQUIPAMENTO,** desconecte o cabo de ALIMENTAÇÃO.
- 10  EQUIPAMENTO DE LIGAÇÃO, a tomada elétrica deve estar instalada perto do equipamento e ser de fácil acesso."
- 11  **CUIDADO:** As aberturas de ventilação não devem ser bloqueadas e devem ter acesso livre ao ar ambiente para arrefecimento adequado do aparelho.
- 12  **TEMPERATURA DE FUNCIONAMENTO:** Este produto foi projetado para uma temperatura ambiente máxima de 40 graus centígrados.
- 13  **TODOS OS PAÍSES:** Instale o produto de acordo com as normas nacionais e locais para instalações elétricas.

Estándares: Este producto cumple con los siguientes estándares.

- 1 Emisión RFI FCC Part 15 (Class A), EN55022 (Class A)
- 2  **ADVERTENCIA:** en un entorno doméstico, este producto puede causar radiointerferencias, en cuyo caso, puede requerirse del usuario que tome las medidas que sean convenientes al respecto.
- 3 Inmunidad EN55024
- 4 Seguridad eléctrica UL 1950 (UL/cUL), EN60950 (TUV), EN60825
- 5  **¡ADVERTENCIA!** Producto láser Clase 1.
- 6  **¡ADVERTENCIA!** No mirat fijamente el haz.
- 7  **AVISOS ELECTRICOS**
ADVERTENCIA: PELIGRO DE ELECTROCHOQUE
 Para evitar un ELECTROCHOQUE, no quite la tapa. No hay ningún componente en el interior al cual puede prestar servicio el usuario. Esta unidad contiene VOLTAJES PELIGROSOS y sólo deberá abrirla un técnico entrenado y calificado. Para evitar la posibilidad de ELECTROCHOQUE desconecte la corriente eléctrica que llega al producto antes de conectar o desconectar los cables LAN.
- 8  **PELIGRO DE RAYOS**
PELIGRO: NO REALICE NINGUN TIPO DE TRABAJO O CONEXION en los equipos o en LOS CABLES durante TORMENTAS ELECTRICAS.
- 9  **ATENCION: EL CABLE DE ALIMENTACION SE USA COMO UN DISPOSITIVO DE DESCONEXION. PARA DESACTIVAR EL EQUIPO,** desconecte el cable de alimentación.
- 10  EQUIPO CONECTABLE, el tomacorriente se debe instalar cerca del equipo, en un lugar con acceso fácil".
- 11  **ATENCION:** Las aberturas para ventilación no deberán bloquearse y deberán tener acceso libre al aire ambiental de la sala para su enfriamiento.

- 12  **TEMPERATURA REQUERIDA PARA LA OPERACIÓN:** Este producto está diseñado para una temperatura ambiental máxima de 40 grados C.
- 13  **PARA TODOS LOS PAÍSES:** Monte el producto de acuerdo con los Códigos Eléctricos locales y nacionales.

Standarder: Denna produkt uppfyller följande standarder.

- 1 Radiostörning FCC Part 15 (Class A), EN55022 (Class A)
- 2  **WARNING:** Denna produkt kan ge upphov till radiostörningar i hemmet, vilket kan tvinga användaren till att vidtaga erforderliga åtgärder.
- 3 Immunitet EN55024
- 4 Elsäkerhet UL 1950 (UL/cUL), EN60950 (TUV), EN60825
- 5  **WARNING!** Laserprodukt av klass 1.
- 6  **WARNING!** Laserstrålning när enheten är öppen.
- 7  **TILLKÄNNAGIVANDEN BETRÄFFANDE ELEKTRICITETSRIK:**
RISK FÖR ELEKTRISK STÖTFör att undvika ELEKTRISK stöt, ta ej av locket. Det finns inga delar inuti som behöver underhållas. Denna apparat är under HÖGSPÄNNING och får endast öppnas av en utbildad kvalificerad tekniker. För att undvika ELEKTRISK STÖT, koppla ifrån produktens strömanslutning innan LAN-kablarna ansluts eller kopplas ur.
- 8  **FARA FÖR BLIXTNEDSLAG**
FARA: ARBETA EJ på utrustningen eller kablarna vid ÅSKVÄDER.
- 9  **WARNING:** NÄTKABELN ANVÄNDS SOM STRÖMBRYTARE FÖR ATT KOPPLA FRÅN STRÖMMEN, dra ur nätkabeln.
- 10  **UTRUSTNING MED PLUGG.** Uttaget skall installeras i utrustningens närhet och vara lättåtkomligt".
- 11  **WARNING:** Luftventilerna får ej blockeras och måste ha fri tillgång till omgivande rumsluft för avsvälvning.
- 12  **DRIFTSTEMPERATUR:** Denna produkt är konstruerad för rumstemperatur ej överstigande 40 grader Celsius.
- 13  **ALLA LÄNDER:** Installera produkten i enlighet med lokala och statliga bestämmelser för elektrisk utrustning.

Appendix B

Technical Support Fax Order

Name _____

Company _____

Address _____

City _____ State/Province _____

Zip/Postal Code _____ Country _____

Phone _____ Fax _____

Incident Summary

Model number of Allied Telesyn product I am using _____

Firmware release number of Allied Telesyn product _____

Other network software products I am using (e.g., network managers)

Brief summary of problem _____

Conditions (List the steps that led up to the problem.) _____

Detailed description (Please use separate sheet)

Please also fax printouts of relevant files such as batch files and configuration files. When completed, fax this sheet to the appropriate Allied Telesyn office. Fax numbers can be found on page viii.

Appendix C

AT-FS705E FC and AT-FS706E FC Installation Guide Feedback

Please tell us what additional information you would like to see discussed in this guide. If there are topics you would like information on that were not covered in this guide, please photocopy this page, answer the questions and fax or mail this form back to Allied Telesyn. The mailing address and fax number are at the bottom of the page. Your comments are valuable when we plan future revisions of this guide.

I found the following the most valuable _____

I would like the following more developed _____

I would find this guide more useful if _____

Please fax or mail your feedback. Fax to 1-408-736-0100. Or mail to:
Allied Telesyn International, Corp.
c/o Technical Communications
960 Stewart Drive, Suite B
Sunnyvale, CA 94086 USA

