



Simply connecting the (IP) world

AT-FS705PD

Fast Ethernet Switch

Installation Guide

Copyright © 2004 Allied Telesyn, Inc.
960 Stewart Drive Suite B, Sunnyvale CA 94085, USA

All rights reserved. No part of this publication may be reproduced without prior written permission from Allied Telesyn, Inc.

Ethernet is a registered trademark of Xerox Corporation. All other product names, company names, logos or other designations mentioned herein are trademarks or registered trademarks of their respective owners.

Allied Telesyn, Inc. reserves the right to make changes in specifications and other information contained in this document without prior written notice. The information provided herein is subject to change without notice. In no event shall Allied Telesyn, Inc. be liable for any incidental, special, indirect, or consequential damages whatsoever, including but not limited to lost profits, arising out of or related to this manual or the information contained herein, even if Allied Telesyn, Inc. has been advised of, known, or should have known, the possibility of such damages.

Electrical Safety and Emission Compliance Statements

Standards: This product meets the following standards:

U.S. Federal Communications Commission

Declaration Of Conformity

| | |
|----------------------------|---|
| Manufacturer Name: | Allied Telesyn, Inc. |
| Manufacturer Address: | 960 Stewart Drive, Suite B Sunnyvale, CA 94085 USA |
| Manufacturer Telephone: | 408-730-0950 |
| Declares that the product: | Fast Ethernet Switch |
| Model Numbers: | AT-FS705PD |

This product complies with FCC Part 15B, Class B Limits:

This device complies with part 15 of the FCC Rules. Operation is subject to the following two conditions: (1) This device must not cause harmful interference, and (2) this device must accept any interference received, including interference that may cause undesired operation.

Radiated Energy

Note: This equipment has been tested and found to comply with the limits for a Class B digital device pursuant to Part 15 of FCC Rules. These limits are designed to provide reasonable protection against harmful interference in a residential installation. This equipment generates, uses and can radiate radio frequency energy and, if not installed and used in accordance with instructions, may cause harmful interference to radio or television reception, which can be determined by turning the equipment off and on. The user is encouraged to try to correct the interference by one or more of the following measures:

- Reorient or relocate the receiving antenna.
- Increase the separation between the equipment and the receiver.
- Connect the equipment into an outlet on a circuit different from that to which the receiver is connected.
- Consult the dealer or an experienced radio/TV technician for help.

Changes and modifications not expressly approved by the manufacturer or registrant of this equipment can void your authority to operate this equipment under Federal Communications Commission rules.

Industry Canada

This Class B digital apparatus meets all requirements of the Canadian Interference-Causing Equipment Regulations.

Cet appareil numérique de la classe B respecte toutes les exigences du Règlement sur le matériel brouilleur du Canada.

RFI Emission

FCC Class B, EN55022 Class B,
VCCI Class B, C-TICK  1

Immunity

EN55024  2

Electrical Safety

EN60950 (TUV), UL60950 (cUL_{us}), CE  3

Important: Appendix B contains translated safety statements for installing this equipment. When you see the , go to Appendix B for the translated safety statement in your language.

Wichtig: Anhang B enthält übersetzte Sicherheitshinweise für die Installation dieses Geräts. Wenn Sie  sehen, schlagen Sie in Anhang B den übersetzten Sicherheitshinweis in Ihrer Sprache nach.

Vigtigt: Tillæg B indeholder oversatte sikkerhedsadvarsler, der vedrører installation af dette udstyr. Når De ser symbolet , skal De slå op i tillæg B og finde de oversatte sikkerhedsadvarsler i Deres eget sprog.

Belangrijk: Appendix B bevat vertaalde veiligheidsopmerkingen voor het installeren van deze apparatuur. Wanneer u de  ziet, raadpleeg Appendix B voor vertaalde veiligheidsinstructies in uw taal.

Important: L'annexe B contient les instructions de sécurité relatives à l'installation de cet équipement. Lorsque vous voyez le symbole , reportez-vous à l'annexe B pour consulter la traduction de ces instructions dans votre langue.

Tärkeää: Liite B sisältää tämän laitteen asentamiseen liittyvät käännetyt turvaohjeet. Kun näet -symbolin, katso käännettyä turvaohjetta liitteestä B.

Importante: l'Appendice B contiene avvisi di sicurezza tradotti per l'installazione di questa apparecchiatura. Il simbolo , indica di consultare l'Appendice B per l'avviso di sicurezza nella propria lingua.

Viktig: Tillegg B inneholder oversatt sikkerhetsinformasjon for installering av dette utstyret. Når du ser , åpner du til Tillegg B for å finne den oversatte sikkerhetsinformasjonen på ønsket språk.

Importante: O Anexo B contém advertências de segurança traduzidas para instalar este equipamento. Quando vir o símbolo , leia a advertência de segurança traduzida no seu idioma no Anexo B.

Importante: El Apéndice B contiene mensajes de seguridad traducidos para la instalación de este equipo. Cuando vea el símbolo , vaya al Apéndice B para ver el mensaje de seguridad traducido a su idioma.

Obs! Bilaga B innehåller översatta säkerhetsmeddelanden avseende installationen av denna utrustning. När du ser , skall du gå till Bilaga B för att läsa det översatta säkerhetsmeddelandet på ditt språk.

Table of Contents

| | |
|---|------|
| Electrical Safety and Emission Compliance Statements | iii |
| Table of Contents | v |
| Welcome to Allied Telesyn | vii |
| Where to Find Related Guides | vii |
| Documentation Conventions | vii |
| Contacting Allied Telesyn | viii |
| Online Support | viii |
| E-mail and Telephone Support | viii |
| Returning Products | viii |
| For Sales or Corporate Information | viii |
| | |
| Chapter 1 | |
| Overview | 1 |
| Key Features | 2 |
| Status LEDs | 3 |
| Powering Options | 4 |
| Twisted Pair Ports | 4 |
| Port Speed | 5 |
| Duplex Mode | 5 |
| Auto MDI/MDI-X | 6 |
| MAC Address Table | 6 |
| Store and Forward | 7 |
| Network Topologies | 8 |
| Standalone | 8 |
| Uplink | 9 |
| | |
| Chapter 2 | |
| Installation | 11 |
| Verifying the Package Contents | 11 |
| Planning the Installation | 12 |
| Selecting a Site | 13 |
| Reviewing Safety Guidelines | 14 |

Installing the Switch on a Desktop..... 15
Wall-Mounting the Switch 17
Warranty Registration 20

Chapter 3

Troubleshooting 21

Appendix A

Technical Specifications 23
Physical 23
Environmental 23
Electrical Rating 23
Agency Compliance..... 24
Pinout Assignments..... 24

Appendix B

Translated Safety and Emission Information 27

Welcome to Allied Telesyn

This guide contains instructions on how to install and configure the AT-FS705PD Fast Ethernet Switch.

Where to Find Related Guides

The Allied Telesyn web site at **www.alliedtelesyn.com** offers you an easy way to access the most recent documentation, software, and technical information for all of our products. For product guides, select “Support & Services” from our web site.

Documentation Conventions

This guide uses the following conventions:

Note

Notes provide additional information.



Caution

Cautions indicate that performing or omitting a specific action may result in equipment damage or loss of data.



Warning

Warnings indicate that performing or omitting a specific action may result in bodily injury.

Contacting Allied Telesyn

This section provides Allied Telesyn contact information for technical support as well as sales or corporate information.

Online Support

You can request technical support online by accessing the Allied Telesyn Knowledge Base from the following web site: **<http://kb.alliedtelesyn.com>**. You can use the Knowledge Base to submit questions to our technical support staff and review answers to previously asked questions.

E-mail and Telephone Support

For Technical Support via E-mail or telephone, refer to the Support & Services section of the Allied Telesyn web site: **<http://www.alliedtelesyn.com>**.

Returning Products

Products for return or repair must first be assigned a Return Materials Authorization (RMA) number. A product sent to Allied Telesyn without a RMA number will be returned to the sender at the sender's expense.

To obtain a RMA number, contact Allied Telesyn's Technical Support at our web site: **<http://www.alliedtelesyn.com>**.

For Sales or Corporate Information

You can contact Allied Telesyn for sales or corporate information at our web site: **<http://www.alliedtelesyn.com>**. To find the contact information for your country, select "Contact Us" then "Worldwide Contacts."

Chapter 1

Overview

The AT-FS705PD is a 5-port Unmanaged Fast Ethernet Switch that includes one Power-Over-Ethernet (POE) port. This switch is considered a Class 1 Powered Device (PD) and can be used in pair with any IEEE 802.3af/D4.3 or later compliant Power Sourcing Equipment (PSE).

This switch offers a range of features and capabilities that can be used in a variety of network configurations and topologies. It also serves the following functions:

- ❑ Creating small workgroups with dedicated 10 megabits per second (Mbps) and 100 Mbps links to your network devices, such as workstations, servers, printers, and routers.
- ❑ Interconnecting Ethernet hubs or switches to provide a bridge between the different workgroups of your network.
- ❑ Connecting to other Ethernet switches so that they can be part of a larger Ethernet network.
- ❑ Maximizing your existing network by providing full-duplex operation over a twisted pair port.
- ❑ Receiving both data and power through its POE port.

The POE port allows data and power be transmitted over the same single twisted pair cable without power sourcing consideration or electric rewires.

The AT-FS705PD switch features five 10/100 Mbps twisted pair ports with one port dedicated for POE operation. Each twisted pair port has an RJ-45 connector with a maximum operating distance of 100 meters (328 feet). The twisted pair port can operate at 10 Mbps or 100 Mbps and in half- or full-duplex mode.

The AT-FS705PD switch can be used on a desktop or mounted on a wall. The switch is easy to install and does not require software configuration or management.

Figure 1 illustrates the front and back panels of the AT-FS705PD switch.

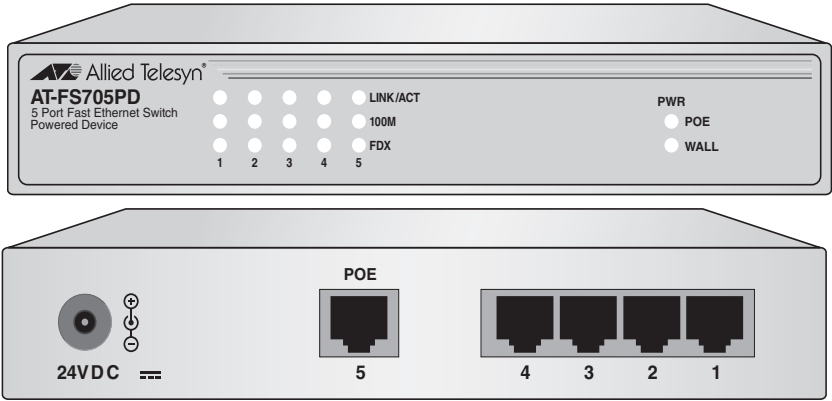

Figure 1 AT-FS705PD Switch Front and Back Panels

Key Features

The AT-FS705PD switch has the following key features:

- Five 10/100Base-TX ports using RJ-45 twisted pair connectors
- Power-Over-Ethernet PD Support
- System and port LEDs
- Auto MDI/MDI-X on all ports
- Auto-Negotiation on all ports (IEEE 802.3u-compliant)
- Non-blocking architecture
- Store and forward packet handling
- Backpressure and flow control (IEEE 802.3x-compliant)
- Storage for up to 2,048 MAC addresses with aging time at 300 seconds
- Maximum frame size of 1536 Byte
- For use on a desktop or wallmount

Status LEDs

Table 1 defines the LEDs for the switch.

Table 1 Status LEDs

| LED | Color | Description |
|----------|----------|--|
| LINK/ACT | Green | A valid link has been established on the port. |
| | OFF | No link has been established on the port. |
| | Blinking | Data is being received or transmitted on the port. |
| 100M | Green | The port is operating at 100 Mbps. |
| | OFF | The port is operating at 10 Mbps. |
| FDX | Green | The port is operating in full-duplex mode. |
| | OFF | The port is operating in half-duplex mode. |

Table 2 defines the LEDs for the power of the switch.

Table 2 Power Status LEDs

| PWR LED | Color | Description |
|---------|------------------|--|
| POE | Green | The switch is powered with the Power-Over-Ethernet feature via Port 5. |
| | OFF/ Blinking | The switch is not powered with the Power-Over-Ethernet feature via Port 5. |
| WALL | Green | The switch is powered with a wall adapter. |
| | OFF | The switch is not powered with a wall adapter. |

Powering Options

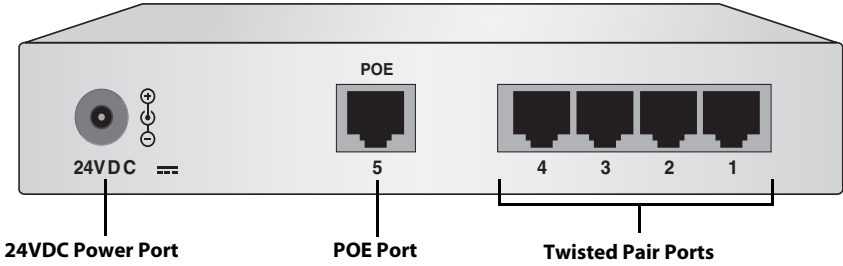

Figure 2 Power Port, POE Port, and Twisted Pair Ports on Back Panel

Two ways to power on an AT-FS705PD switch are as follows:

- ❑ **Option 1:** Powered by a 24VDC @ 0.3A+ output wall adapter. Option 1 has higher priority, if both options are connected to the AT-FS705PD, then it is powered by Option 1 and the PWR WALL LED is green. In the same time, the PWR POE LED is either blinking or OFF, which is fully controlled by the Power Sourcing Equipment (PSE).
- ❑ **Option 2:** Powered-over-Ethernet on Port 5. Option 2 will be enabled only if an IEEE 802.3af compliant PSE is connecting to Port 5, and no power plug is inserted in the 24VDC power port.



Caution

POE and power cord are used as disconnection devices: To de-energize equipment, disconnect the POE and the power cord.

Note

The AT-FS705PD Switch is classified as IEEE Std 802.3af-2003, **Environment A**, where a LAN or LAN segment, with all its associated interconnected equipment, is entirely contained within a single low-voltage power distribution system and within a single building.

Twisted Pair Ports

The AT-FS705PD switch has five 10Base-T/100Base-TX twisted pair ports. Each twisted pair port features a RJ-45 connector. The maximum operating distance for the twisted pair ports is 100 meters (328 feet) when operating at either 10 Mbps or 100 Mbps.

Port Speed

The twisted pair ports are compliant with the 10Base-T and 100Base-TX standards and are capable of either 10 Mbps or 100 Mbps operation. Since the ports are IEEE 802.3u Auto-Negotiation compliant, the switch will set the port speed automatically. With Auto-Negotiation, the speed of the ports are set automatically by the switch after it determines the speed of the end-node connected to the port. Auto-Negotiation is designed to ensure that the port on the switch and the end-node are operating at the same speed and that they are communicating at the highest possible common speed between the devices. For example, if an end-node is capable of only 10 Mbps, the switch then sets the port connected to the end-node to 10 Mbps.

Duplex Mode

Duplex mode refers to the way an end-node sends and receives data on the network. An end-node can operate in either half- or full-duplex mode depending on its capabilities. An end-node that is operating in half-duplex mode can either send data or receive data, but it cannot do both at the same time. An end-node that is operating in full-duplex mode can send and receive data simultaneously. The best network performance is achieved when an end-node can operate at full-duplex, since the end-node is able to send and receive data simultaneously.

Each twisted pair port on the AT-FS705PD switch can operate in either half-duplex or full-duplex mode. Since these twisted pair ports are IEEE 802.3u-compliant, the duplex mode can be set automatically through Auto-Negotiation. With Auto-Negotiation, if the end-node is capable of full-duplex, the port is set automatically to full-duplex mode. If the end-node is capable of half-duplex, the port is set automatically to half-duplex mode.

Note

In order for a twisted pair port on the AT-FS705PD switch to successfully Auto-Negotiate its duplex mode with an end-node, the end-node should also be using Auto-Negotiation. Otherwise, a duplex mode mismatch can occur. The twisted pair port, using Auto-Negotiation, will default to half-duplex if it detects that the end-node is not using Auto-Negotiation. This will result in a mismatch if the end-node is operating at a fixed duplex mode of full-duplex.

Auto MDI/MDI-X

A twisted pair port on a 10 Mbps or 100 Mbps Ethernet network device can have one of two possible wiring configurations: MDI or MDI-X. A twisted pair port on a PC, router, or bridge is typically wired as MDI, while a twisted pair port on a switch or hub is usually MDI-X.

To connect two 10 Mbps or 100 Mbps network devices together that have dissimilar port wiring configurations, such as an MDI to MDI-X, you would use a straight-through twisted pair cable. To connect two networks devices that have the same wiring configuration, such as MDI to MDI, you would use a crossover cable.

The AT-FS705PD switch features automatic MDI/MDI-X. The twisted pair port automatically determines the configurations of the port on the device to which it is connected and then configures itself appropriately. For example, if a port on a switch is connected to a port on a bridge, which is typically wired as MDI, the port on the switch automatically configures itself as MDI-X. This feature allows you to use either a crossover cable or a straight-through cable when connecting a device to a twisted pair port.

MAC Address Table

The heart of an Ethernet switch is the Media Access Control (MAC) address table. Every device that you attach to an Ethernet network has a MAC address. This address is assigned to the device by the device's manufacturer. For example, each Network Interface Card (NIC) that you install into your network computers has a MAC address that was assigned to it by the card's manufacturer.

A switch's MAC address table is a list of the MAC addresses of the devices that are connected to its ports. The switch uses this table to direct data frames to their appropriate destination end-nodes, and in some cases, to discard frames that it receives. The switch creates the MAC address table by examining the frames that it receives on its ports. Each frame is examined for its source address; that is, the MAC address of the end-node that sent the frame. The switch checks to determine whether the address is already in its MAC address table. If it is not, the switch adds the address to the table along with the port number on which the frame was received. The result is a table that contains a list of all the MAC addresses of end-nodes that have sent frames to the switch and the ports on the switch to which the end-nodes are connected.

The switch also checks the destination MAC address of each frame it receives. The destination address is the MAC address of the end-node to which the frame is intended. If the address is in the table, the switch directs the frame directly to the port where the end-node is located. This helps to ensure that end-nodes will only receive traffic that is intended for them and not have to deal with traffic intended for other end-nodes.

If the destination address is not in the MAC address table, the switch broadcasts the frame to all switch ports. When the destination end-node responds, the switch will be able to match the address to a port so that the next time a frame is destined to that particular end-node, the switch will be able to forward the frame to the correct port instead of having to broadcast the frame to all ports.

In some cases a switch will even discard a frame. If the switch receives a frame that is destined to an end-node on the same port on which the frame was received, the switch discards the frame.

The MAC address table in the AT-FS705PD switch can store up to 2,048 MAC addresses. To prevent the table from becoming filled with addresses of end-nodes that are no longer active, the switch has a MAC address aging timer. This timer will delete a MAC address from the table if it does not see a frame from the end-node with the address on any port after five minutes (300 seconds). The aging timer also helps to ensure that the table is correct should an end-node be moved from one port on the switch to another port.

Store and Forward

The AT-FS705PD switch supports store and forward switching at Fast Ethernet full-wire speed. Packets entering each port are stored in buffers. Once the full packet is received, the switch will forward or discard the packet, depending on its destination address and error status. This ensures that only error-free packets destined for another segment will be transferred across the switch, reducing network load. For example, if the packet entering from Port 1 is destined for an end-node on Port 2, the switch forwards the frame if the frame does not contain any errors. If the packet from Port 1 is destined for an end-node also connected to Port 1, the packet is discarded.

Network Topologies

The AT-FS705PD switch can be used in different topologies such as standalone and uplink. Each topology is describe below.

Standalone

A standalone topology uses one switch to connect the end-nodes. Figure 3 illustrates a standalone topology that uses an AT-FS705PD switch to connect several workstations and a server.

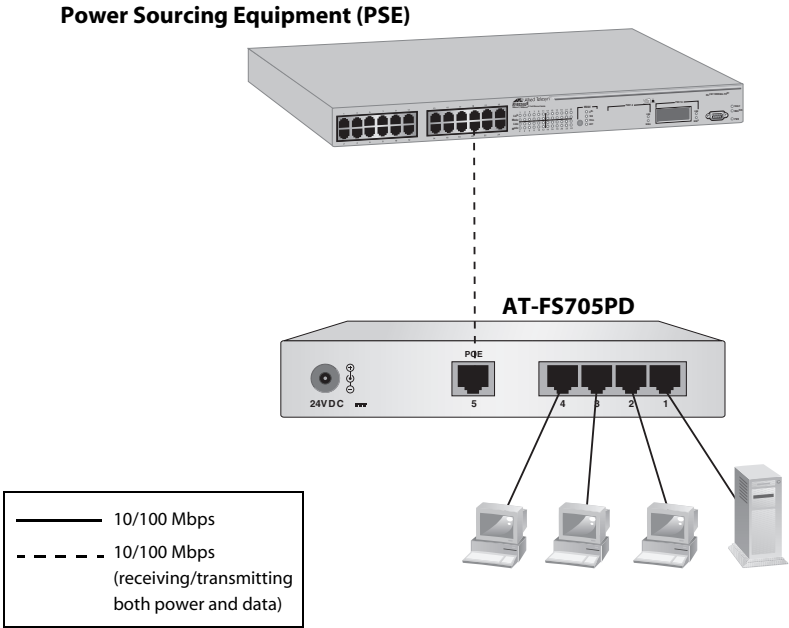

Figure 3 Standalone Topology

Uplink

Figure 4 illustrates multiple AT-FS705PD switches can be interconnected using uplinks from a centralized backbone Fast Ethernet switch.

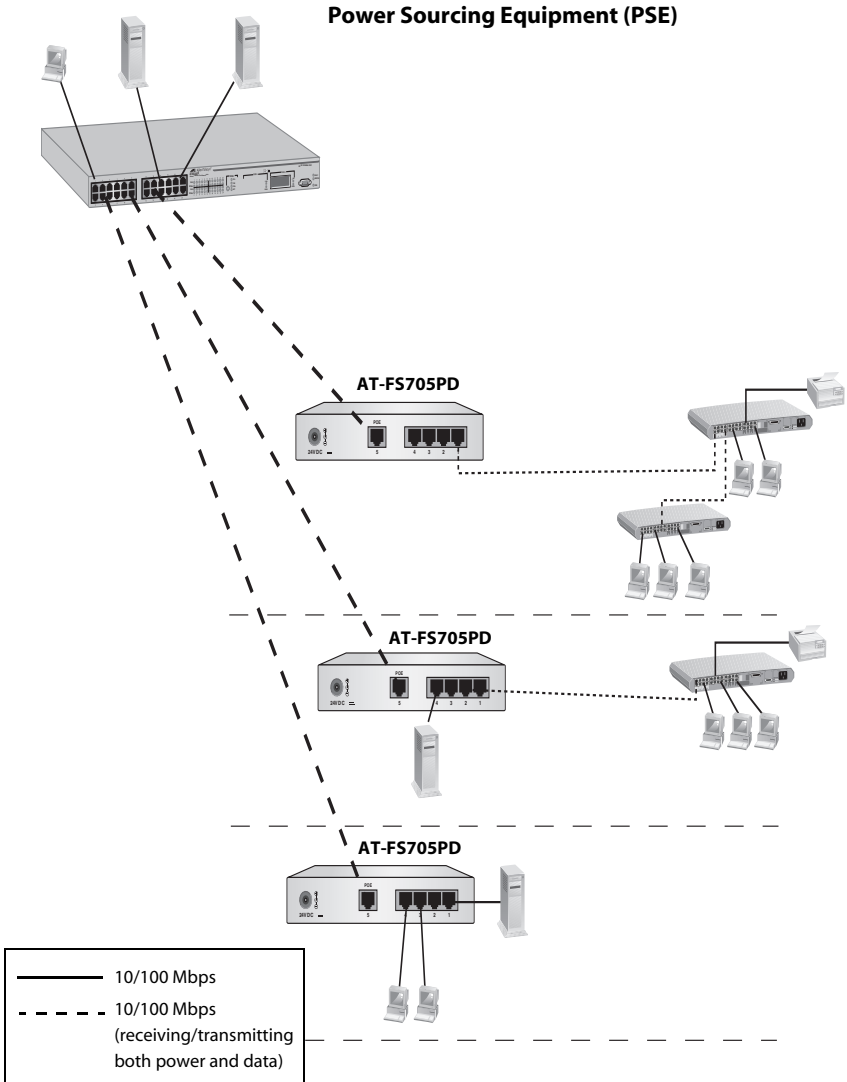

Figure 4 Uplink Topology

Chapter 2

Installation

This chapter contains the installation instructions for the AT-FS705PD switch. This switch can be used on a desktop or mounted on a wall.

Verifying the Package Contents

Make sure the following items are included in your package. If any item is missing or damaged, contact your Allied Telesyn sales representative for assistance.

- One AT-FS705PD Fast Ethernet Switch
- Two plastic wall anchor
- Two self-tapping screws
- Four protective rubber feet (for desktop use only)
- This installation guide
- Warranty card

Planning the Installation

Be sure to observe the following guidelines when planning the installation of your switch.

- ❑ The end-nodes connected to the twisted pair ports can operate at 10 Mbps or 100 Mbps and half or full-duplex. The switch uses Auto-Negotiation to determine the correct speed and duplex mode for each port.
- ❑ The end-nodes connected to the ports on the switch can be a network adapter card, hub, repeater, router, or another switch.
- ❑ The twisted pair port cabling must be kept away from sources of electrical noise, such as radios, transmitters, power lines, broadband amplifiers electrical motors, and fluorescent fixtures.
- ❑ A twisted pair port using the Auto-Negotiation feature to configure the Auto MDI/MDI-X. It configures itself automatically as MDI or MDI-X when connected to an end-node. Either a straight-through or crossover twisted pair cable can be used to connect a switch port to any network device.

Refer to Table 3 for the cabling specifications for the twisted pair ports.

Table 3 10Base-T/100Base-TX Twisted Pair Port Cabling Specifications

| Operating Mode | Twisted Pair Cable | Maximum Operating Distance |
|----------------|---|----------------------------|
| 10Base-T | Shielded or Unshielded Category 3 or better | 100 m (328 ft) |
| 100Base-TX | Shielded or Unshielded Category 5 or better | 100 m (328 ft) |

Selecting a Site

Be sure to observe the following requirements when choosing a site for your switch.

- Select a site that is dust-free and moisture-free.
- Be sure that the site will allow you to easily access the switch's power and data cables.
- Make sure that the switch is placed on a flat, secure surface (such as a desk or table) if you want to use it with desktop configuration.
- Make sure the air flow around the switch and through its vents on the side and back are not restricted.
- Be sure that the twisted pair port cabling is kept away from sources of electrical noise; such as radios, transmitters, power lines, broadband amplifiers, electrical motors, and fluorescent fixtures.
- Use a dedicated power circuit or a power conditioner to supply reliable power to the switch.

Reviewing Safety Guidelines

Please review the following safety guidelines before installing the AT-FS705PD switch.



Warning

Lightning Danger: Do not work on this equipment or cables during periods of lightning activity. ⚡ 4



Caution

Pluggable Equipment: The socket outlet should be installed near the equipment and should be easily accessible. ⚡ 5



Caution

Air Vents: The air vents must not be blocked on the unit and must have free access to the room ambient air for cooling. ⚡ 6



Caution

Operating Temperature: This product is designed for a maximum ambient temperature of 40°C. ⚡ 7



Caution

All Countries: Install this product in accordance with local and National Electric Codes. ⚡ 8

Installing the Switch on a Desktop

The AT-FS705PD switch can be used on a desktop or mounted on a wall. To wall-mount the switch, refer to “Wall-Mounting the Switch” on page 17.

To install an AT-FS705PD switch on a desktop, perform the following procedure:

1. Remove all equipment from the package and store the packaging material in a safe location.
2. If you are installing the switch on a desktop, attach the four protective feet to the bottom of the unit. See Figure 5.

Note

Do not attach the protective feet if you are wall-mounting the switch.

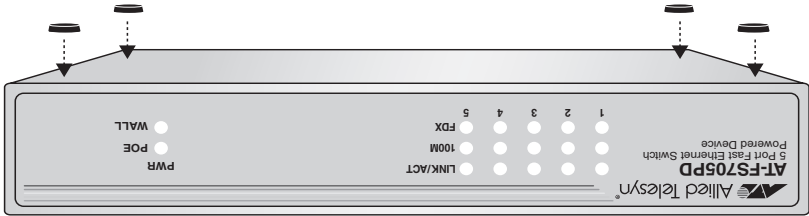

Figure 5 Attaching the Protective Feet

3. Place the switch on a flat, secure surface (such as a desk or table) leaving ample space around the unit for ventilation.
4. Connect the twisted pair cables to the twisted pair ports.

When connecting a twisted pair cable to a port, observe the following guidelines:

- An RJ-45 connector should fit snugly into the port on the converter. The tab on the connector should lock the connector into place.
- You should check to be sure that you are using the appropriate type of twisted pair cabling. Refer to Table 3 on page 12 for twisted pair cable specifications.
- Since the twisted pair port, when operating in Auto-Negotiation, is Auto MDI/MDI-X, you can use either a straight-through or crossover twisted pair cable to connect any type of network device to a port on the converter. If you disable Auto-Negotiation on the port, the port defaults to MDI-X.



Caution

POE and power cord are used as disconnection devices: To de-energize equipment, disconnect the POE and the power cord.

5. There are two ways to power ON the switch; perform one of the following steps:
 - ❑ Using a wall power adapter: Plug one end of the power cord to the 24VDC power connector on the back of the switch and the other end of the power cord to a power outlet.
 - ❑ Using the POE port: Plug one end of the twisted pair cable to the POE port on the back of the switch and the other end of the twisted pair cable to an Ethernet port on a PSE device.

Note

The AT-FS705PD Switch is classified as IEEE Std 802.3af-2003, **Environment A**, where a LAN or LAN segment, with all its associated interconnected equipment, is entirely contained within a single low-voltage power distribution system and within a single building.

6. Verify that either the PWR POE or WALL LED is green. If the LED is OFF, refer to “Troubleshooting” on page 21 for instructions.
7. Power ON the end-nodes connected to the switch.
8. Check the LINK/ACT LEDs for each port is green. If a LED is OFF, refer to “Troubleshooting” on page 21 for instructions.

The switch is now ready for use.

Wall-Mounting the Switch

The switch can be mounted horizontally on a wall using the keyholes on the bottom of the switch. The screws, plastic anchors, and other materials necessary to mount the switch on a wall are not provided.

To wall-mount the switch, perform the following procedure:

1. If attached, remove the rubber feet, data cables, and power cord from the switch.
2. Select a wall location for the device.
3. Install two plastic anchors and two screws onto the wall, as illustrated in Figure 6.

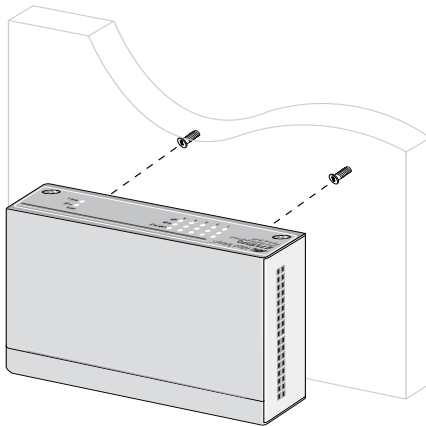

Figure 6 Installing The Plastic Anchors and Screws Onto The Wall

4. Position the switch horizontally onto the wall screws, as illustrated in Figure 7.

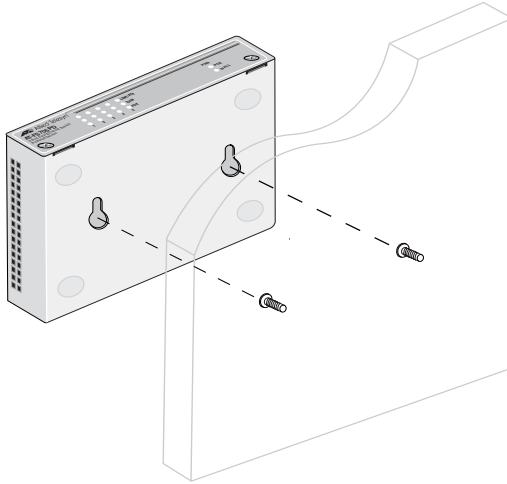

Figure 7 Positioning The Switch Onto The Wall Screws

5. Connect the twisted pair cables to the twisted pair ports.

When connecting a twisted pair cable to a port, observe the following guidelines:

- An RJ-45 connector should fit snugly into the port on the switch. The tab on the connector should lock the connector into place.
- You should check to be sure that you are using the appropriate type of twisted pair cabling. Refer to Table 3 on page 12 for twisted pair cable specifications.
- Since the twisted pair port, when operating in Auto-Negotiation, is Auto MDI/MDI-X, you can use either a straight-through or crossover twisted pair cable to connect any type of network device to a port on the converter.



Caution

POE and power cord are used as disconnection devices: To de-energize equipment, disconnect the POE and the power cord.

6. Power ON the switch.

There are two ways to power ON the switch; perform one of the following steps:

- Using a wall power adapter: Plug one end of the power cord to the 24VDC power connector on the back of the switch and the other end of the power cord to a power outlet.
 - Using the POE port: Make sure that no power plug is inserted in the 24VDC power port. Then plug one end of the twisted pair cable to the POE port on the back of the switch and the other end of the twisted pair cable to an Ethernet port on a PSE device.
7. Verify that either the PWR POE or WALL LED is green. If the LED is OFF, refer to “Troubleshooting” on page 21 for instructions.
8. Power ON the end-nodes connected to the switch.
9. Check the LINK/ACT LEDs for each port is green. If a LED is OFF, refer to “Troubleshooting” on page 21 for instructions.

The switch is now ready for use.

Warranty Registration

When you have finished installing the switch, you should register your switch by completing the enclosed warranty card and sending it in.

Chapter 3

Troubleshooting

Follow the guidelines below to test and troubleshoot the installation in the event a problem occurs.

If the PWR-POE LED is OFF and Port 5 is connected to a PSE device, do the following;

Note

This twisted pair cable connecting to the POE port must be a Category 5 Ethernet cable.

- Make sure that the PSE device is IEEE 802.3af/D4.3 or later compliant.
- Make sure that the PSE device is detecting the AT-FS705PD switch.
- Make sure that the CAT5 cable is functional.
- Make sure there is no power plug inserted in the 24VDC power port on the back panel of the switch.

If the PWR-WALL LED is OFF and the AT-FS705PD switch is connected to a wall adapter, do the following;

- Make sure that the wall adapter has an output capability of 24VDC @ 0.3A.
- Make sure that the wall adapter has the same output polarity as the one shown on the AT-FS705PD switch, refer to Figure 1 on page 2.

If a LINK/ACT LED is OFF, do the following:

- Check that the end-node connected to the port is powered ON and is operating properly.
- Check that the twisted pair cable is securely connected to the port on the switch and to the port on the end-node.

- ❑ Verify that the end-node connected to the port and the switch are operating at the same speed. Both must be operating at either 10 Mbps or 100 Mbps.
- ❑ Make sure that the twisted pair cable does not exceed 100 meters (328 feet) and that you are using a Category 3 or better cable for 10Base-T operation or a Category 5 or better cable for 100Base-TX operation.

If there is a communication problem between the end-nodes connected to the switch, do the following:

- ❑ Verify that the end-nodes are operating with the same duplex mode.

If you are still experiencing problems after testing and troubleshooting the installation, refer to “Contacting Allied Telesyn” on page viii or visit our web site at **www.alliedtelesyn.com** for support information.

Appendix A

Technical Specifications

Physical

| | |
|-------------|---|
| Dimensions: | W x H x D 125.73 mm x 26 mm x 100.05 mm (4.95 in x 1.02 in x 3.74 in) |
| Weight: | 372 grams (0.82 lbs) |

Environmental

| | |
|---------------------------------|------------------------------------|
| Operating Temperature: | 0° C to 40° C (32° F to 104° F) |
| Storage Temperature: | -25° C to 70° C (-13° F to 158° F) |
| Operating Humidity: | 5% to 90% non-condensing |
| Storage Humidity: | 5% to 95% non-condensing |
| Operating and Storage Altitude: | Up to 3,048 meters (10,000 feet) |

Electrical Rating

| | |
|-----------------------|----------------------|
| Input Supply Voltage: | 24VDC |
| Input Current: | 0.3A |
| POE Input Voltage: | 22 - 57VDC |
| POE Current: | 66mA - 140mA |
| Power Consumption: | 3W maximum (Class 1) |

Agency Compliance

| | |
|--------------------|--|
| EMI/RFI: | FCC Class B, EN55022 Class B, VCCI Class B, C-TICK |
| Electrical Safety: | EN60950 (TUV), UL60950 (cUL _{us}), CE |
| Immunity: | EN55024 |

Pinout Assignments

Figure 8 shows the pinout assignments for the RJ-45 connector.

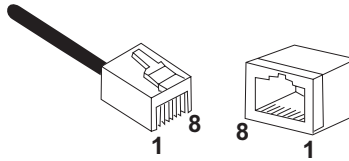

Figure 8 RJ-45 Pin Assignments

Table 4 lists the RJ-45 connector pins and their signals used in Port 1 - Port 4 when these port are operating in either MDI or MDI-X configuration.

Table 4 RJ-45 Pin Signals used in Ports 1 - 4

| MDI-X (Default) | Signal | MDI | Signal |
|-----------------|--------|-----|--------|
| 1 | RX+ | 1 | TX+ |
| 2 | RX- | 2 | TX- |
| 3 | TX+ | 3 | RX+ |
| 4 | - | 4 | - |
| 5 | - | 5 | - |
| 6 | TX- | 6 | RX- |
| 7 | - | 7 | - |
| 8 | - | 8 | - |

Table 5 lists the RJ-45 connector pins and their signals used in Port 5 when this port is connected to a PSE device using a straight cable.

Table 5 Port 5 RJ-45 Pin Signals (using straight cable)

| PSE PWR Configuration | Alternative A (MDI)_{PSE side} | Alternative A (MDI-X)_{PSE side} | Alternative A (MDI)_{PSE side} | Alternative A (MDI-X)_{PSE side} |
|------------------------------|---|---|---|---|
| Pin Number | Port 5 Signals (*) | | | |
| 1 | RX+ and <i>Vport-1</i> | TX+ and <i>Vport-1</i> | RX+ | TX+ |
| 2 | RX- and <i>Vport-1</i> | TX- and <i>Vport-1</i> | RX- | TX- |
| 3 | TX+ and <i>Vport-2</i> | RX+ and <i>Vport-2</i> | TX+ | RX+ |
| 4 | - | - | Vport+ | Vport+ |
| 5 | - | - | Vport+ | Vport+ |
| 6 | TX- and <i>Vport-2</i> | RX- and <i>Vport-2</i> | TX- | RX- |
| 7 | - | - | Vport- | Vport- |
| 8 | - | - | Vport- | Vport- |

(*) *Vport-1* can be either Vport + or Vport-, depending on the PSE device.

Vport-2 can be either Vport+ or Vport-, depending on the PSE device.

If *Vport-1* = Vport +, then *Vport-2* = Vport-, and if *Vport-1* = Vport -, then *Vport-2* = Vport+.

Table 6 lists the RJ-45 connector pins and their signals used in Port 5 when this port is connected to a PSE device using a cross-over cable.

Table 6 Port 5 RJ-45 Pin Signals (using cross-over cable)

| PSE PWR Configuration | Alternative A (MDI)_{PSE side} | Alternative A (MDI-X)_{PSE side} | Alternative A (MDI)_{PSE side} | Alternative A (MDI-X)_{PSE side} |
|------------------------------|---|---|---|---|
| Pin Number | Port 5 Signals (*) | | | |
| 1 | TX+ and <i>Vport-1</i> | RX+ and <i>Vport-1</i> | TX+ | RX+ |
| 2 | TX- and <i>Vport-1</i> | RX- and <i>Vport-1</i> | TX- | RX- |
| 3 | RX+ and <i>Vport-2</i> | TX+ and <i>Vport-2</i> | RX+ | TX+ |
| 4 | - | - | Vport+ | Vport+ |
| 5 | - | - | Vport+ | Vport+ |
| 6 | RX- and <i>Vport-2</i> | TX- and <i>Vport-2</i> | RX- | TX- |
| 7 | - | - | Vport- | Vport- |
| 8 | - | - | Vport- | Vport- |

(*) *Vport-1* can be either Vport + or Vport-, depending on the PSE device.
Vport-2 can be either Vport+ or Vport-, depending on the PSE device.
 If *Vport-1* = Vport +, then *Vport-2* = Vport-, and if *Vport-1* = Vport -, then *Vport-2* = Vport+.

Appendix B

Translated Safety and Emission Information

Important: This appendix contains multiple-language translations for the safety statements in this guide.

Wichtig: Dieser Anhang enthält Übersetzungen der in diesem Handbuch enthaltenen Sicherheitshinweise in mehreren Sprachen.

Vigtigt: Dette tillæg indeholder oversættelser i flere sprog af sikkerhedsadvarslerne i denne håndbog.

Belangrijk: Deze appendix bevat vertalingen in meerdere talen van de veiligheidsopmerkingen in deze gids.

Important: Cette annexe contient la traduction en plusieurs langues des instructions de sécurité figurant dans ce guide.

Tärkeää: Tämä liite sisältää tässä oppaassa esiintyvät turvaohjeet usealla kielellä.

Importante: questa appendice contiene traduzioni in più lingue degli avvisi di sicurezza di questa guida.

Viktig: Dette tillegget inneholder oversettelser til flere språk av sikkerhetsinformasjonen i denne veiledningen.

Importante: Este anexo contém traduções em vários idiomas das advertências de segurança neste guia.

Importante: Este apéndice contiene traducciones en múltiples idiomas de los mensajes de seguridad incluidos en esta guía.

Obs! Denna bilaga innehåller flerspråkiga översättningar av säkerhetsmeddelandena i denna handledning.

Standards: This product meets the following standards.

U.S. Federal Communications Commission

Declaration Of Conformity

Manufacturer Name: Allied Telesyn, Inc.
Manufacturer Address: 960 Stewart Drive, Suite B
Sunnyvale, CA 94085 USA
Manufacturer Telephone: 408-730-0950
Declares that the product: Fast Ethernet Switch
Model Numbers: AT-FS705PD

This product complies with FCC Part 15B, Class B Limits:

This device complies with part 15 of the FCC Rules. Operation is subject to the following two conditions: (1) This device must not cause harmful interference, and (2) this device must accept any interference received, including interference that may cause undesired operation.

Radiated Energy

Note: This equipment has been tested and found to comply with the limits for a Class B digital device pursuant to Part 15 of FCC Rules. These limits are designed to provide reasonable protection against harmful interference in a residential installation. This equipment generates, uses and can radiate radio frequency energy and, if not installed and used in accordance with instructions, may cause harmful interference to radio or television reception, which can be determined by turning the equipment off and on. The user is encouraged to try to correct the interference by one or more of the following measures:





- Reorient or relocate the receiving antenna.
- Increase the separation between the equipment and the receiver.
- Connect the equipment into an outlet on a circuit different from that to which the receiver is connected.
- Consult the dealer or an experienced radio/TV technician for help.

Changes and modifications not expressly approved by the manufacturer or registrant of this equipment can void your authority to operate this equipment under Federal Communications Commission rules.





Industry Canada

This Class B digital apparatus meets all requirements of the Canadian Interference-Causing Equipment Regulations.





Cet appareil numérique de la classe B respecte toutes les exigences du Règlement sur le matériel brouilleur du Canada.

- 1 **RFI Emission** FCC Class B, EN55022 Class B, VCCI Class B, C-TICK
- 2 **Immunity** EN55024
- 3 **Electrical Safety** EN60950 (TUV), UL60950 (cUL-us), CE
- 4  **Lightning Danger** **Danger: DO NOT WORK** on equipment or CABLES during periods of LIGHTNING ACTIVITY.
- 5  Pluggable equipment, the socket outlet shall be installed near the equipment and shall be easily accessible.
- 6  **Caution:** Air vents must not be blocked and must have free access to the room ambient air for cooling.
- 7  **Operating Temperature:** This product is designed for a maximum ambient temperature of 40 degrees C.
- 8  **All Countries:** Install product in accordance with local and National Electrical Codes.

Normen: Dieses Produkt erfüllt die Anforderungen der nachfolgenden Normen.

- 🔗 1 **Hochfrequenzstörung** FCC Klasse B, EN55022 Klasse B, VCCI Klasse B, C-TICK
- 🔗 2 **Störsicherheit** EN55024
- 🔗 3 **Elektrische Sicherheit** EN60950 (TUV), UL60950 (cUL_{us}), CE
- 🔗 4  **Gefahr Durch Blitzschlag**
Gefahr: Keine Arbeiten am Gerät oder an den Kabeln während eines Gewitters ausführen.
- 🔗 5  **Steckbares Gerät:** Die Anschlußbuchse sollte in der Nähe der Einrichtung angebracht werden und leicht zugänglich sein."
- 🔗 6  **Vorsicht**
Die Entlüftungsöffnungen dürfen nicht versperrt sein und müssen zum Kühlen freien Zugang zur Raumluft haben.
- 🔗 7  **Betriebstemperatur**
Dieses Produkt wurde für den Betrieb in einer Umgebungstemperatur von nicht mehr als 40° C entworfen.
- 🔗 8  **Alle Länder:** Installation muß örtlichen und nationalen elektrischen Vorschriften entsprechen.





Standarder: Dette produkt tilfredsstiller de følgende standarder.

- 1 **Radiofrekvens forstyrrelsesemission** FCC Klasse B, EN55022 Klasse B, VCCI Klasse B, C-TICK
- 2 **Immunitet** EN55024
- 3 **Elektrisk sikkerhed** EN60950 (TUV), UL60950 (cUL_{us}), CE
- 4  **Fare Under Uvejr**
Fare: UNDLAD at arbejde på udstyr eller KABLER i perioder med LYNAKTIVITET.
- 5  Aan te sluiten apparatuur, de contactdoos wordt in de nabijheid van de apparatuur geïnstalleerd en is gemakkelijk te bereiken."
- 6  **Opgelet:** De ventilatiegaten mogen niet worden gesperd en moeten de omgevingslucht ongehinderd toelaten voor afkoeling
- 7  **Betjeningstemperatur:** Dette apparat er konstrueret til en omgivende temperatur på maksimum 40 grader C.
- 8  **Alle Lande:** Installation af produktet skal ske i overensstemmelse med lokal og national lovgivning for elektriske installationer.





Eisen: Dit product voldoet aan de volgende eisen.

- 🔗 1 **RFI Emissie** FCC Klasse B, EN55022 Klasse B, VCCI Klasse B, C-TICK
- 🔗 2 **Immuniteit** EN55024
- 🔗 3 **Electrische Veiligheid** EN60950 (TUV), UL60950 (cUL_{us}), CE
- 🔗 4  **Gevaar Voor Blikseminslag**
Gevaar: NIET aan toestellen of KABELS WERKEN bij BLIKSEM.
- 🔗 5  Equipement pour branchement électrique, la prise de sortie doit être placée près de l'équipement et facilement accessible".
- 🔗 6  **Attention:** Ne pas bloquer les fentes d'aération, ceci empêcherait l'air ambiant de circuler librement pour le refroidissement
- 🔗 7  **Bedrijfstemperatuur:** De omgevingstemperatuur voor dit produkt mag niet meer bedragen dan 40 graden Celsius.
- 🔗 8  **Alle Landen:** het toestel installeren overeenkomstig de lokale en nationale elektrische voorschriften.





Normes: Ce produit est conforme aux normes de suivantes.

- 1 **Emission d'interférences radioélectriques** FCC Classe B, EN55022 Classe B, VCCI Classe B, C-TICK
- 2 **Immunité** EN55024
- 3 **Sécurité électrique** EN60950 (TUV), UL60950 (cUL_{us}), CE
- 4  **Danger De Foudre**
Danger: NE PAS MANIER le matériel ou les CÂBLES lors d'activité orageuse.
- 5  EQUIPEMENT POUR BRANCHEMENT ELECTRIQUE, la prise de sortie doit être placée près de l'équipement et facilement accessible".
- 6  **Attention:** Ne pas bloquer les fentes d'aération, ceci empêcherait l'air ambiant de circuler librement pour le refroidissement.
- 7  **Température De Fonctionnement**
Ce matériel est capable de tolérer une température ambiante maximum de 40 degrés Celsius.
- 8  **Pour Tous Pays:** Installer le matériel conformément aux normes électriques nationales et locales.





Standardit: Tämä tuote on seuraavien standardien mukainen.

- 🔗 1 **Radioaaltojen häirintä** FCC Luokka B, EN55022 Luokka B, VCCI Luokka B, C-TICK
- 🔗 2 **Kestävyys** EN55024
- 🔗 3 **Sähköturvallisuus** EN60950 (TUV), UL60950 (cUL_{us}), CE
- 🔗 4  **Salamaniskuvaara**
Engenvaara: ÄLÄ TYÖSKENTELE laitteiden tai KAAPELEIDEN KANSSA SALAMOINNIN AIKANA.
- 🔗 5  Pistorasiaan kytkettävä laite; pistorasia on asennettava laitteen lähelle ja siihen on oltava esteetön pääsy."
- 🔗 6  **Huomautus:** Ilmavaihtoreikiä ei pidä tukkia ja niillä täytyy olla vapaa yhteys ympäröivään huoneilmaan, jotta ilmanvaihto tapahtuisi.
- 🔗 7  **Käyttölämpötila**
Tämä tuote on suunniteltu ympäröivän ilman maksimilämpötilalle 40° C.
- 🔗 8  **Kaikki Maat:** Asenna tuote paikallisten ja kansallisten sähköturvallisuusmääräysten mukaisesti.





Standard: Questo prodotto è conforme ai seguenti standard.

- 1 **Emissione RFI (interferenza di radiofrequenza)** FCC Classe B, EN55022 Classe B, VCCI Classe B, C-TICK
- 2 **Immunità** EN55024
- 3 **Sicurezza elettrica** EN60950 (TUV), UL60950 (cUL_{us}), CE
- 4  **Pericolo Di Fulmini**
Pericolo: NON LAVORARE sul dispositivo o sui CAVI durante PRECIPITAZIONI TEMPORALESCHIE.
- 5  Apparecchiatura collegabile, la presa va installata vicino all'apparecchio per risultare facilmente accessibile".
- 6  **Attenzione:** le prese d'aria non vanno ostruite e devono consentire il libero ricircolo dell'aria ambiente per il raffreddamento.
- 7  **Temperatura Di Funzionamento**
Questo prodotto è concepito per una temperatura ambientale massima di 40 gradi centigradi.
- 8  **Tutti I Paesi** installare il prodotto in conformità delle vigenti normative elettriche nazionali.



Sikkerhetsnormer: Dette produktet tilfredsstiller følgende sikkerhetsnormer.

- 🔗 1 **RFI stråling** FCC Klasse B, EN55022 Klasse B, VCCI Klasse B, C-TICK
- 🔗 2 **Immunitet** EN55024
- 🔗 3 **Elektrisk sikkerhet** EN60950 (TUV), UL60950 (cUL_{us}), CE
- 🔗 4  **Fare For Lynnedslag**
Fare: ARBEID IKKE på utstyr eller KABLER i TORDENVÆR.
- 🔗 5  Utstyr for stikkontakt. Stikkontakten skal monteres i nærheten av utstyret og skal være lett tilgjengelig."
- 🔗 6  **Forsiktig:** Luftventilene må ikke blokkeres, og må ha fri tilgang til luft med romtemperatur for avkjøling.
- 🔗 7  **Driftstemperatur:** Dette produktet er konstruert for bruk i maksimum romtemperatur på 40 grader celsius.
- 🔗 8  **Alle Land:** Produktet må installeres i samsvar med de lokale og nasjonale elektriske koder.





Padrões: Este produto atende aos seguintes padrões.

- 1 **Emissão De Interferência De Radiofrequência** FCC Classe B, EN55022 Classe B, VCCI Classe B, C-TICK
- 2 **Imunidade** EN55024
- 3 **Segurança Eléctrica** EN60950 (TUV), UL60950 (cUL_{us}), CE
- 4  **Perigo De Choque Causado Por Raio**
Perigo: NÃO TRABALHE no equipamento ou nos CABOS durante períodos suscetíveis a QUEDAS DE RAIOS.
- 5  Equipamento de ligação, a tomada eléctrica deve estar instalada perto do equipamento e ser de fácil acesso."
- 6  **Cuidado:** As aberturas de ventilação não devem ser bloqueadas e devem ter acesso livre ao ar ambiente para arrefecimento adequado do aparelho.
- 7  **Temperatura De Funcionamento:** Este produto foi projetado para uma temperatura ambiente máxima de 40 graus centígrados.
- 8  **Todos Os Países:** Instale o produto de acordo com as normas nacionais e locais para instalações eléctricas.

Estándares: Este producto cumple con los siguientes estándares.

- 1 **Emisión RFI** FCC Clase B, EN55022 Clase B, VCCI Clase B, C-TICK
- 2 **Inmunidad** EN55024
- 3 **Seguridad eléctrica** EN60950 (TUV), UL60950 (cUL_{us}), CE
- 4  **Peligro De Rayos**
Eligro: NO REALICE NINGUN TIPO DE TRABAJO O CONEXION en los equipos o en LOS CABLES durante TORMENTAS ELECTRICAS.
- 5  Equipo conectable, el tomacorriente se debe instalar cerca del equipo, en un lugar con acceso fácil".
- 6  **Atencion:** Las aberturas para ventilación no deberán bloquearse y deberán tener acceso libre al aire ambiental de la sala para su enfriamiento.
- 7  **Temperatura Requerida Para La Operación:** Este producto está diseñado para una temperatura ambiental máxima de 40 grados C.
- 8  **Para Todos Los Países:** Monte el producto de acuerdo con los Códigos Eléctricos locales y nacionales.

Standarder: Denna produkt uppfyller följande standarder.

- 1 **Radiostörning** FCC Klass B, EN55022 Klass B, VCCI Klass B, C-TICK
- 2 **Immunitet** EN55024
- 3 **Elsäkerhet** EN60950 (TUV), UL60950 (cUL_{us}), CE
- 4  **Fara För Blixtnedslag**
Fara: ARBETA EJ på utrustningen eller kablarna vid ÅSKVÄDER.
- 5  Utrustning med plugg. Uttaget skall installeras i utrustningens närhet och vara lättåtkomligt".
- 6  **Varning:** Luftventilerna får ej blockeras och måste ha fri tillgång till omgivande rumsluft för avsvälvning.
- 7  **Driftstemperatur:** Denna produkt är konstruerad för rumstemperatur ej överstigande 40 grader Celsius.
- 8  **Alla Länder:** Installera produkten i enlighet med lokala och statliga bestämmelser för elektrisk utrustning.

