

AT-GS950/8
 AT-GS950/16
 AT-GS950/24
 AT-GS950/48
 Gigabit Ethernet Smart Switch



1966



1967

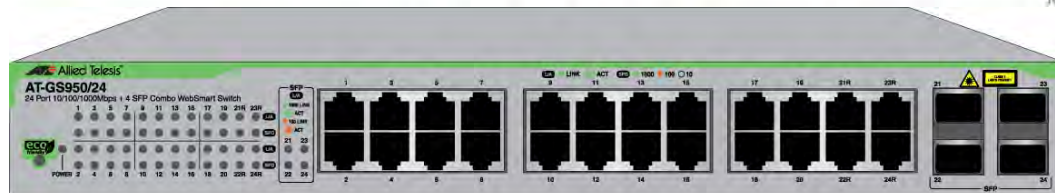

1968



1971

Installation Guide

Copyright © 2014 Allied Telesis, Inc.

All rights reserved. No part of this publication may be reproduced without prior written permission from Allied Telesis, Inc.

Allied Telesis and the Allied Telesis logo are trademarks of Allied Telesis, Incorporated. All other product names, company names, logos or other designations mentioned herein are trademarks or registered trademarks of their respective owners.

Allied Telesis, Inc. reserves the right to make changes in specifications and other information contained in this document without prior written notice. The information provided herein is subject to change without notice. In no event shall Allied Telesis, Inc. be liable for any incidental, special, indirect, or consequential damages whatsoever, including but not limited to lost profits, arising out of or related to this manual or the information contained herein, even if Allied Telesis, Inc. has been advised of, known, or should have known, the possibility of such damages.

Electrical Safety and Emissions Standards

This product meets the following standards.

U.S. Federal Communications Commission

Radiated Energy

Note: This equipment has been tested and found to comply with the limits for a Class A digital device pursuant to Part 15 of FCC Rules. These limits are designed to provide reasonable protection against harmful interference when the equipment is operated in a commercial environment. This equipment generates, uses, and can radiate radio frequency energy and, if not installed and used in accordance with this instruction manual, may cause harmful interference to radio communications. Operation of this equipment in a residential area is likely to cause harmful interference in which case the user will be required to correct the interference at his own expense.

Note: Modifications or changes not expressly approved of by the manufacturer or the FCC, can void your right to operate this equipment.

Industry Canada

This Class A digital apparatus meets all requirements of the Canadian Interference-Causing Equipment Regulations.

Cet appareil numérique de la classe A respecte toutes les exigences du Règlement sur le matériel brouilleur du Canada.

RFI Emissions FCC Class A, EN55022 Class A, EN61000-3-2, EN61000-3-3, C-TICK, CE

Warning: In a domestic environment this product may cause radio interference in which case the user may be required to take adequate measures.

Immunity EN55024

Electrical Safety EN60950 (TUV), UL 60950 (CUL-US)



Laser Safety EN60825

Translated Safety Statements

Important: The  indicates that translations of the safety statement are available in the PDF document "**Translated Safety Statements**" posted on the Allied Telesis website at www.alliedtelesis.com.

Contents

Preface	11
Symbol Conventions	11
Contacting Allied Telesis	12
Chapter 1: Overview	13
Features	13
Twisted Pair Ports	13
LEDs	14
SFP Slots	14
Installation Options	14
Power Conservation	14
MAC Address Table	14
Management Software	15
Management Interface	15
Dimensions	15
Operating Conditions	15
Front and Back Panels	16
Management Software	17
Twisted Pair Ports	17
Combo Ports	18
LEDs	20
eco-friendly Button	21
Power Supply	22
Network Topologies	23
Gigabit Ethernet to the Desktop	23
Gigabit Ethernet Backbone	23
Chapter 2: Installation	25
Reviewing Safety Precautions	26
Selecting a Site for the Switch	28
Cable Specifications	29
Unpacking the Switch	30
Installing the Switch on a Desktop	31
Installing the Switch in an Equipment Rack	32
Installing the Switch on a Wall	35
Installing Optional SFP Transceivers	37
Cabling the Switch	40
Powering On the Switch	41
Chapter 3: Troubleshooting	43
Appendix A: Technical Specifications	47
Physical Specifications	48
Dimensions (H x W x D)	48
Weights	48
Environmental Specifications	49
Power Specifications	49

Contents

Certifications.....	49
Connectors and Port Pinouts.....	50

List of Figures

Figure 1: AT-GS950/8, AT-GS950/16, AT-GS950/24 and AT-GS950/48 Front Panels	16
Figure 2: Back Panel	17
Figure 3: Gigabit Ethernet to the Desktop Topology.....	23
Figure 4: Gigabit Ethernet Backbone Topology.....	24
Figure 5: AT-GS950/xx Packing List.....	30
Figure 6: Attaching the Rubber Feet	31
Figure 7: Attaching the Rack-Mount Brackets to the Switch.....	33
Figure 8: Mounting the Switch in an Equipment Rack.....	34
Figure 9: Attaching the Brackets to Install the Switch on a Wall.....	35
Figure 10: Marking the Screw Hole Locations	35
Figure 11: Securing the Switch to the Wall.....	36
Figure 12: Removing the Dust Plug from an SFP Slot	37
Figure 13: Inserting the SFP.....	38
Figure 14: Plugging in the AC Power Cord.....	41
Figure 15: RJ-45 Connector and Port Pin Layout.....	50

List of Tables

Table 1. Combo Ports	18
Table 2. System LEDs	20
Table 3. 10/100/1000Base-T Port LEDs	20
Table 4. SFP Slot LEDs	21
Table 5. Twisted Pair Cabling and Distances	29
Table 6. Product Dimensions	48
Table 7. Product Weights	48
Table 8. Environmental Specifications	49
Table 9. Power Consumption	49
Table 10. Product Certifications	49
Table 11. MDI Pin Signals (10Base-T or 100Base-TX)	50
Table 12. MDI-X Pin Signals (10Base-T or 100Base-TX)	50
Table 13. RJ-45 1000Base-T Connector Pinouts	51

Preface

This guide contains the installation instructions for the AT-GS950/8, AT-GS950/16, AT-GS950/24 and AT-GS950/48 Gigabit Ethernet Smart Switches. The overview gives a physical description of the switch hardware and the instructions give the installation procedures.

This preface contains the following sections:

- ❑ “Symbol Conventions” on page 11
- ❑ “Contacting Allied Telesis” on page 12

Symbol Conventions

This document uses the following conventions:

Note

Notes provide additional information.



Caution

Cautions inform you that performing or omitting a specific action may result in equipment damage or loss of data.



Warning

Warnings inform you that performing or omitting a specific action may result in bodily injury.



Warning

Warnings inform you that an eye and skin hazard exists due to the presence of a Class 1 laser device.

Contacting Allied Telesis

If you need assistance with this product, you may contact Allied Telesis technical support by going to the Support & Services section of the Allied Telesis web site at www.alliedtelesis.com/support. You can find links for the following services on this page:

- ❑ 24/7 Online Support - Enter our interactive support center to search for answers to your questions in our knowledge database, check support tickets, learn about RMAs, and contact Allied Telesis technical experts.
- ❑ USA and EMEA phone support - Select the phone number that best fits your location and customer type.
- ❑ Hardware warranty information - Learn about Allied Telesis warranties and register your product online.
- ❑ Replacement Services - Submit a Return Merchandise Authorization (RMA) request via our interactive support center.
- ❑ Documentation - View the most recent installation guides, user guides, software release notes, white papers and data sheets for your product.
- ❑ Software Updates - Download the latest software releases for your product.
- ❑ For sales or corporate contact information, go to www.alliedtelesis.com/purchase and select your region.

Chapter 1

Overview

This chapter describes the AT-GS950/8, AT-GS950/16, AT-GS950/24 and AT-GS950/48 Layer 2 Gigabit Ethernet Switches. The sections in the chapter are.

- ❑ “Features” on page 13
- ❑ “Front and Back Panels” on page 16
- ❑ “Management Software” on page 17
- ❑ “Twisted Pair Ports” on page 17
- ❑ “Combo Ports” on page 18
- ❑ “LEDs” on page 20
- ❑ “eco-friendly Button” on page 21
- ❑ “Power Supply” on page 22
- ❑ “Network Topologies” on page 23

Features

Here are the hardware features of the AT-GS950/8, AT-GS950/16, AT-GS950/24 and AT-GS950/48 Gigabit Ethernet Switches.

Twisted Pair Ports

- ❑ 8, 16, 24 or 48 ports
- ❑ 10Base-TX, 100Base-T and 1000Base-T compliant
- ❑ IEEE 802.3u Auto-Negotiation compliant
- ❑ Auto-MDI/MDIX
- ❑ RJ-45 connectors
- ❑ 100 meters (328 feet) maximum operating distance
- ❑ IEEE 802.3x flow control in 10/100Base-TX full-duplex operation
- ❑ IEEE 802.3x back pressure in 10/100Base-TX half-duplex operation
- ❑ IEEE803.3z 1000Base-T flow control
- ❑ Support for jumbo frames up to 10KB

LEDs

- Speed and link/activity LEDs for the twisted pair ports
- Link/activity LEDs for the SFP slots
- Power LED

SFP Slots

- Two slots on the AT-GS950/8 and AT-GS950/16 Switches
- Four slots on the AT-GS950/24 and AT-GS950/48 Switches
- Support 100Base-FX and 1000Base-SX/LX transceivers

Note

The SFP slots on each switch are paired with twisted pair ports to form combo ports. For more information, refer to “Combo Ports” on page 18.

Note

SFP transceivers must be purchased separately. For a list of supported transceivers, contact your Allied Telesis distributor or reseller.

Installation Options

- 19-inch equipment rack
- Desk or tabletop
- Wall

Power Conservation

- eco-friendly button to turn off the port LEDs when the system is not being monitored
- High-efficiency power supply
- Power scaling based on traffic loads on ports operating at 1000 Mbps (Port power scaling not available at 10 or 100 Mbps)
- Power shutdown on unused ports

MAC Address Table

- 8 kilobytes
- Automatic learning and aging

Management Software

- ❑ AT-S107 Management Software for the AT-GS950/8 Switch
- ❑ AT-S108 Management Software for the AT-GS950/16 Switch
- ❑ AT-S109 Management Software for the AT-GS950/24 Switch
- ❑ AT-S116 Management Software for the AT-GS950/48 Switch

Note

The management software programs come pre-installed on the switches.

Management Interface

- ❑ Web-browser interface for in-band, over-the-network management

Dimensions

- ❑ AT-GS950/8 Switch(W x D x H):
280 mm (11.0 in) x 180 mm (7.1 in) x height - 44 mm (1.7 in)
- ❑ AT-GS950/16 and AT-GS950/24 Switches (W x D x H):
330 mm (13.0 in) x 200 mm (7.9 in) x 44 mm (1.7 in)
- ❑ AT-GS950/48 Switch (W x D x H):
440 mm (17.32 in) x 250 mm (9.4 in) x 44 mm (1.7 in)

Operating Conditions

- ❑ Operating temperature range of 0° C to 45° C (32° F to 113° F)
- ❑ Operating humidity range of 5% to 90% non-condensing

Note

There are two versions of the AT-GS950 Switches. This manual documents the newer version. To determine whether your switch is a old or new version, examine the front panel for the eco-friendly button. The button is found only on the new switches.

Front and Back Panels

Figure 1 on page 16 illustrates the front panels of the AT-GS950/8, AT-GS950/16, AT-GS950/24 and AT-GS950/48 Gigabit Ethernet Switches.

AT-GS950/8

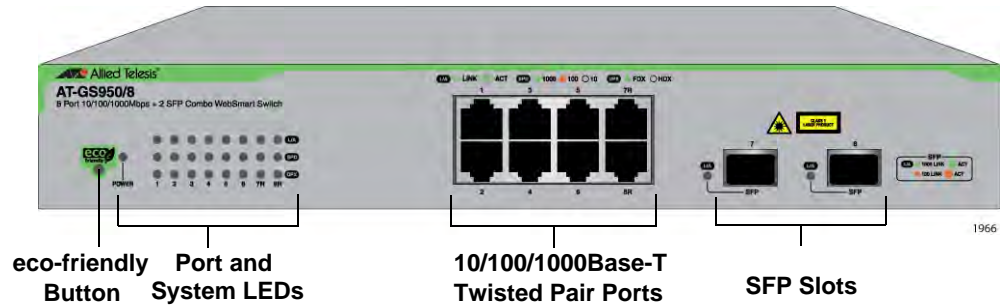

AT-GS950/16

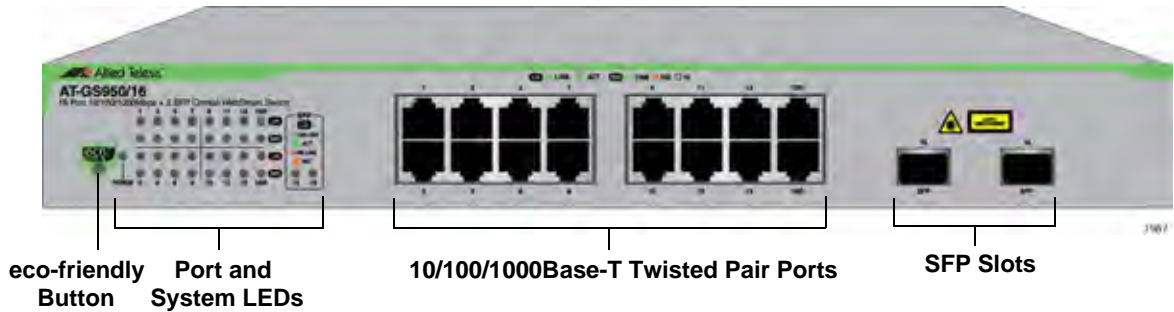

AT-GS950/24

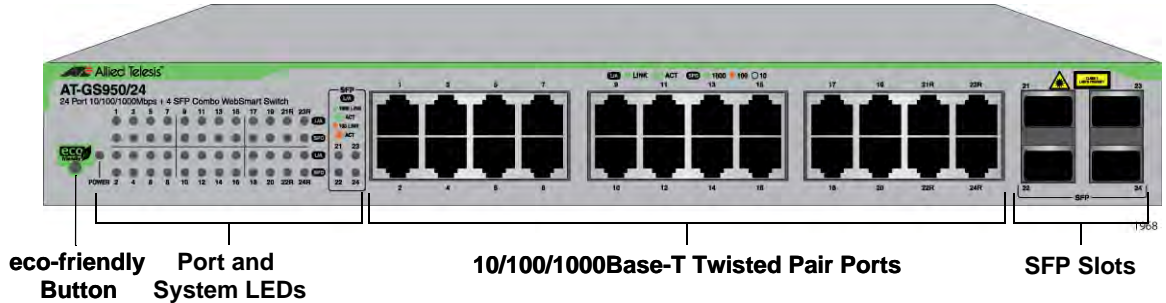

AT-GS950/48

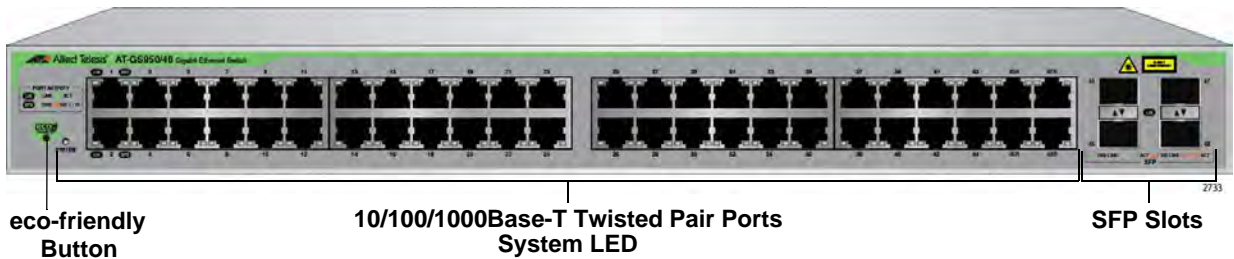

Figure 1. AT-GS950/8, AT-GS950/16, AT-GS950/24 and AT-GS950/48 Front Panels

The AC power plug is in the same location for each of the switches and is illustrated in Figure 2.

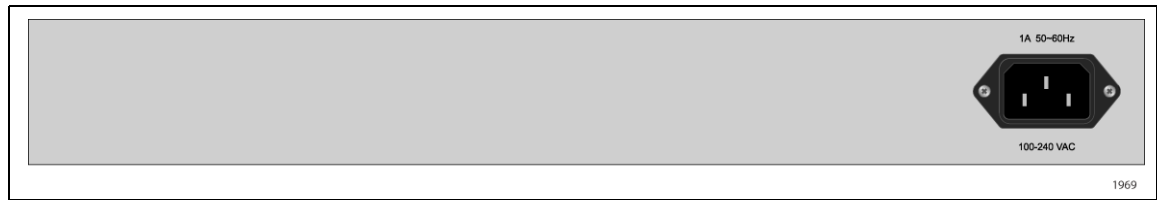

Figure 2. Back Panel

Management Software

The switches come with the management software pre-installed. Although the three models have the same features, each has a different management software program. The programs are:

- ❑ AT-S113 Management Software for the AT-GS950/8 Switch
- ❑ AT-S114 Management Software for the AT-GS950/16 Switch
- ❑ AT-S115 Management Software for the AT-GS950/24 Switch
- ❑ AT-S116 Management Software for the AT-GS950/48 Switch

In the unlikely event that the management software becomes corrupted or damaged, you can download the software from the Allied Telesis corporate web site and reinstall it on the switch. You may also want to periodically visit the Allied Telesis corporate web site to see if new versions of the software have been released. For instructions to install new management software, refer to the *AT-S107, AT-S108, AT-S109 or AT-S116 Management Software User's Guide*.

Twisted Pair Ports

The AT-GS950/8, AT-GS950/16, AT-GS950/24 and AT-GS950/48 switches feature 8, 16, 24 and 48 twisted pair ports, respectively. All four models are 10Base-T, 100Base-TX, and 1000Base-TX compliant. The port speeds and duplex modes may be set automatically with IEEE 802.3u Auto-Negotiation or manually with the management software.

The twisted pair ports feature 8-pin RJ-45 connectors. For the port pinouts, refer to “Connectors and Port Pinouts” on page 50.

The ports have a maximum operating distance of 100 m (328 feet). For 10 Mbps operation, the ports require Category 3 or better 100 ohm shielded or unshielded twisted pair cabling. For 100 or 1000 Mbps operation, the ports require Category 5 or Enhanced Category 5 (5E) 100 ohm shielded or unshielded twisted pair cabling.

The ports feature auto-MDI, which automatically configures the ports as MDI or MDI-X. This feature allows you to use straight-through twisted pair cables regardless of the wiring configurations of the ports on the end nodes.

Note

A switch port connected to an end node that is not using Auto-Negotiation should not use Auto-Negotiation to set the speed and duplex mode, because a duplex mode mismatch might occur. You should disable Auto-Negotiation and set the port's speed and duplex mode manually.

Combo Ports

The AT-GS950/8 and AT-GS950/16 Switches have two combo ports. The AT-GS950/24 and AT-GS950/48 Switches has four combo ports. Each combo port consists of one 10/100/1000Base-T twisted pair port and one slot for an optional 100Base-FX or 1000Base-SX/LX SFP transceiver. The twisted pair ports are identified with the letter "R" for "Redundant" on the front face plates of the units. The combo ports and slots are listed in Table 1.

Table 1. Combo Ports

Switch	Twisted Pair Port	SFP Slot
AT-GS950/8	7R	7
	8R	8
AT-GS950/16	15R	15
	16R	16
AT-GS950/24	21R	21
	22R	22
	23R	23
	24R	24

Table 1. Combo Ports

Switch	Twisted Pair Port	SFP Slot
AT-GS950/48	45R	45
	46R	46
	47R	47
	48R	48

The combo ports have the guidelines listed here:

- ❑ Only one port in a pair — either the twisted pair port or a corresponding SFP module — can be active at a time.
- ❑ The twisted pair port is the active port when its SFP slot is empty, or when an SFP module is installed but has not established a link to an end node.
- ❑ The twisted pair port automatically changes to the redundant status mode when an SFP module establishes a link with an end node.
- ❑ A twisted pair port automatically transitions back to the active status when the link is lost on the SFP module.
- ❑ In nearly all cases, a twisted pair port and an SFP module share the same configuration settings, including port settings, VLAN assignments, access control lists, and spanning tree.
- ❑ An exception to the shared settings is port speed. If you disable Auto-Negotiation on a twisted pair port and set the speed and duplex mode manually, the speed reverts to Auto-Negotiation when an SFP module establishes a link with an end node.

LEDs

Table 2 describes the system LEDs.

Table 2. System LEDs

LED	State	Description
POWER	Off	Either the switch is not receiving power or the AC input power is outside the normal operating range.
	Blinking Green	The switch is in the process of initializing the management software.
	Steady Green	The input AC power is within the normal operating range.

Table 3 describes the LEDs for the 10/100/1000Base-T ports.

Table 3. 10/100/1000Base-T Port LEDs

LED	State	Description
L/A (link/activity)	Off	The port has not established a link with a network device.
	Blinking Green	The port is transmitting or receiving network packets.
	Steady Green	The port has established a link to a network device.
SPD (speed)	Steady Green	The operating speed of the port is 1000 Mbps.
	Steady Amber	The operating speed of the port is 100 Mbps.
	Off	The operating speed of the port is 10 Mbps or the port has not established a link with a network device.
DPX (duplex mode for AT-GS950/8 Switch only)	Steady Green	The port is operating in full duplex mode.
	Off	The port is operating in half duplex mode.

Table 4 describes the LEDs for the SFP slots.

Table 4. SFP Slot LEDs

LED	State	Description
L/A (link/activity)	Off	The port on the SFP transceiver has not established a link with an end node or the transceiver slot is empty.
	Blinking Green	The SFP transceiver is transmitting or receiving network packets at 1000 Mbps.
	Steady Green	The SFP transceiver has established a link with a network device at 1000 Mbps, but is not transmitting or receiving network packets.
	Blinking Amber	The SFP transceiver is transmitting or receiving network packets at 100 Mbps.
	Steady Green	The SFP transceiver has established a link with a network device at 100 Mbps, but is not transmitting or receiving network packets.

Note

All of the port LEDs will be off when the switch is operating in the low power mode. To toggle on the LEDs, use the eco-friendly button.

eco-friendly Button

The eco-friendly button serves multiple functions. You can toggle the port LEDs on and off, reboot your switch or reset your switch configuration to factory default values.

The button operates as follows:

- eco-Friendly mode - When you press the eco-friendly button for 1 to 4 seconds, the front panel port LEDs are either enabled or disabled. You may use the button to turn off (disable) the LEDs when you are not monitoring the switch. Toggling the LEDs does not interfere with the network operations of the switch. The eco-friendly button does not control the Power LED.

- ❑ Reboot the switch - By pressing the button for 5 to 9 seconds, you can initiate a software reboot of the switch. All configuration settings including the Management static IP address or DHCP are retained.



Caution

During the reboot process, the switch does not forward network traffic. Rebooting the switch takes approximately 1 to 2 minutes before the switch comes back on line and is ready to switch Ethernet traffic again. Network traffic is lost during this period of time.

- ❑ Factory default reset - By pressing the button for greater than 10 seconds, you will initiate a software reboot of the switch and reset all of the configuration parameters of the switch to the factory default settings - including the management IP address.

Note

When the switch is reset to factory defaults, its IP address will revert to the static IP address of 192.168.1.1. If your browser is configured for another IP address, you will have to reconfigure your browser and workstation for the switch's default IP address before you can again connect to the switch.

- ❑ Both the reboot and factory default reset functions can be disabled in the management software. For more information, refer to the AT-GS950/8, AT-GS950/16, or AT-GS950/24 *Management Software User's Guide*.

Power Supply

Each switch has an internal power supply with a single AC power supply socket on the back panel. To power the switch on or off, connect or disconnect the power cord provided with the switch. A power cord is supplied with the switch from the factory.

Note

For the power requirements, refer to the "Power Specifications" on page 49.

Network Topologies

This section illustrates two network topologies: Gigabit Ethernet to the desktop and Gigabit Ethernet backbone.

Gigabit Ethernet to the Desktop

The topology shown in Figure 3 is commonly referred to as Gigabit Ethernet to the desktop. This topology provides the best in performance and reliability because each end node is connected directly to the AT-GS950/16 Switch with a dedicated network link

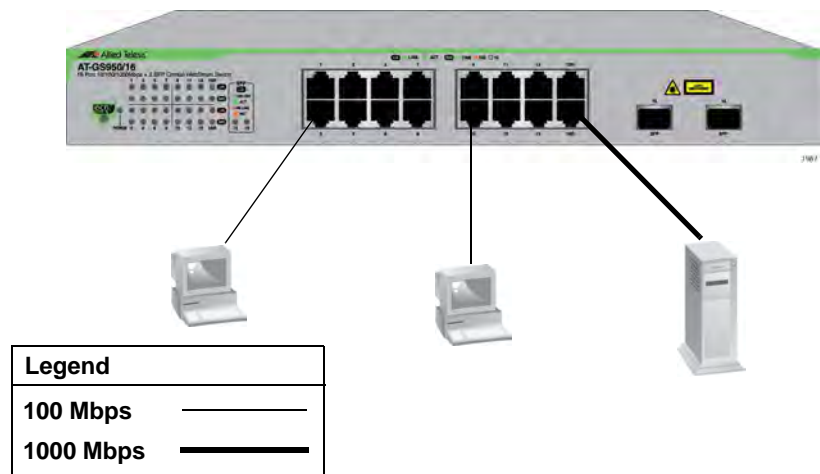

Figure 3. Gigabit Ethernet to the Desktop Topology

Gigabit Ethernet Backbone

In the topology illustrated in Figure 4 on page 24, the AT-GS950/16 is connected to other managed and unmanaged Ethernet switches to form a Gigabit Ethernet backbone topology. The AT-GS950/16 Switch functions as the focal point of the network by transferring Ethernet frames between the switches. This topology reduces the amount of unnecessary traffic in each workgroup, because the AT-GS950/16 Switch transfers frames only when the source and destination end nodes are located on different switches. This frees up bandwidth and improves network performance.

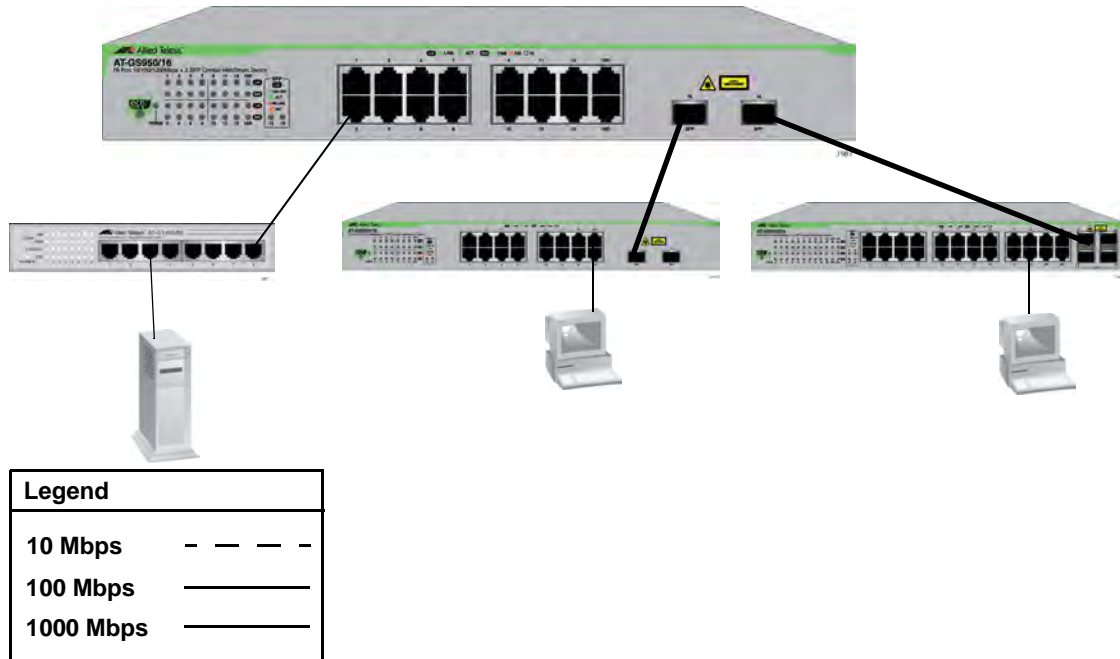

Figure 4. Gigabit Ethernet Backbone Topology

Chapter 2

Installation

This chapter contains the following sections:

- “Reviewing Safety Precautions” on page 26
- “Selecting a Site for the Switch” on page 28
- “Cable Specifications” on page 29
- “Unpacking the Switch” on page 30
- “Installing the Switch on a Desktop” on page 31
- “Installing the Switch in an Equipment Rack” on page 32
- “Installing the Switch on a Wall” on page 35
- “Installing Optional SFP Transceivers” on page 37
- “Cabling the Switch” on page 40
- “Powering On the Switch” on page 41

Reviewing Safety Precautions

Please review the following safety precautions before you begin to install the chassis or any of its components.

Note

The  indicates that a translation of the safety statement is available in a PDF document titled “Translated Safety Statements” posted on the Allied Telesis website at alliedtelesis.com/support.



Warning

To prevent electric shock, do not remove the cover. No user-serviceable parts inside. This unit contains hazardous voltages and should only be opened by a trained and qualified technician. To avoid the possibility of electric shock, disconnect electric power to the product before connecting or disconnecting the cables.  E1



Warning

Do not work on equipment or cables during periods of lightning activity.  E2



Warning

Power cord is used as a disconnection device. To de-energize equipment, disconnect the power cord.  E3



Warning

Class I Equipment. This equipment must be earthed. The power plug must be connected to a properly wired earth ground socket outlet. An improperly wired socket outlet could place hazardous voltages on accessible metal parts.  E4

Note

Pluggable Equipment. The socket outlet shall be installed near the equipment and shall be easily accessible.  E5



Caution

Air vents must not be blocked and must have free access to the room ambient air for cooling.  E6



Caution

Operating Temperature. This product is designed for a maximum ambient temperature of 40 degrees C. ⚡ E7

Note

All Countries: Install product in accordance with local and National Electrical Codes. ⚡ E8

Note

Circuit Overloading: Consideration should be given to the connection of the equipment to the supply circuit and the effect that overloading of circuits might have on overcurrent protection and supply wiring. Appropriate consideration of equipment nameplate ratings should be used when addressing this concern. ⚡ E21



Caution

Mounting of the equipment in the rack should be such that a hazardous condition is not created due to uneven mechanical loading. ⚡ E25

Note

If installed in a closed or multi-unit rack assembly, the operating ambient temperature of the rack environment may be greater than the room ambient temperature. Therefore, consideration should be given to installing the equipment in an environment compatible with the manufacturer's maximum rated ambient temperature (T_{mra}). ⚡ E35



Caution

Installation of the equipment in a rack should be such that the amount of air flow required for safe operation of the equipment is not compromised. ⚡ E36



Warning

Reliable earthing of rack-mounted equipment should be maintained. Particular attention should be given to supply connections other than direct connections to the branch circuits (e.g., use of power strips). ⚡ E37

Selecting a Site for the Switch

Observe the following requirements when choosing a site for your switch:

- ❑ If you plan to install the switch in an equipment rack, verify that the rack is safely secured and will not tip over. Devices in a rack should be installed starting at the bottom, with the heavier devices near the bottom of the rack.
- ❑ If you are installing the switch on a table, verify that the table is level and secure.
- ❑ The power outlet for the switch should be located near the unit and should be easily accessible.
- ❑ The site should provide for easy access to the ports on the front of the switch. This will make it easier for you to connect and disconnect cables, as well as view the switch's LEDs.
- ❑ Air flow around the unit and through its vents on the side and rear should not be restricted so that the switch can maintain adequate cooling.
- ❑ Do not place objects on top of the switch.
- ❑ Do not expose the switch to moisture or water.
- ❑ Ensure that the site is a dust-free environment.
- ❑ You should use dedicated power circuits or power conditioners to supply reliable electrical power to the network devices.

Cable Specifications

Table 5 contains the cable specifications for the twisted pair ports.

Table 5. Twisted Pair Cabling and Distances

Speed	Type of Cable	Maximum Operating Distance
10 Mbps	Standard TIA/EIA 568-B-compliant Category 3 or better shielded or unshielded cabling with 100 ohm impedance and a frequency of 16 MHz.	100 m (328 ft)
100 Mbps	Standard TIA/EIA 568-A-compliant Category 5 or TIA/EIA 568-B-compliant Enhanced Category 5 (Cat 5e) shielded or unshielded cabling with 100 ohm impedance and a frequency of 100 MHz.	100 m (328 ft)
1000 Mbps	Standard TIA/EIA 568-A-compliant Category 5 or TIA/EIA 568-B-compliant Enhanced Category 5 (Cat 5e) shielded or unshielded cabling with 100 ohm impedance and a frequency of 100 MHz.	100 m (328 ft)

Note

The twisted pair ports on the switch feature auto-MDI when operating at 10, 100, or 1000 Mbps. A port is configured as MDI or MDI-X when it is connected to an end node. Consequently, you can use a straight-through twisted pair cable when connecting any type of network device to a port on the switch.

Unpacking the Switch

To unpack the switch, perform the following procedure:

1. Remove all of the components from the shipping package.

Note

Store the packaging material in a safe location. You must use the original shipping material if you need to return the unit to Allied Telesis.

2. Place the switch on a level, secure surface.
3. Verify that the shipping container includes the items listed in Figure 5 on page 30 in addition to your AT-GS950/8, AT-GS950/16, AT-GS950/24 or AT-GS950/48 switch.

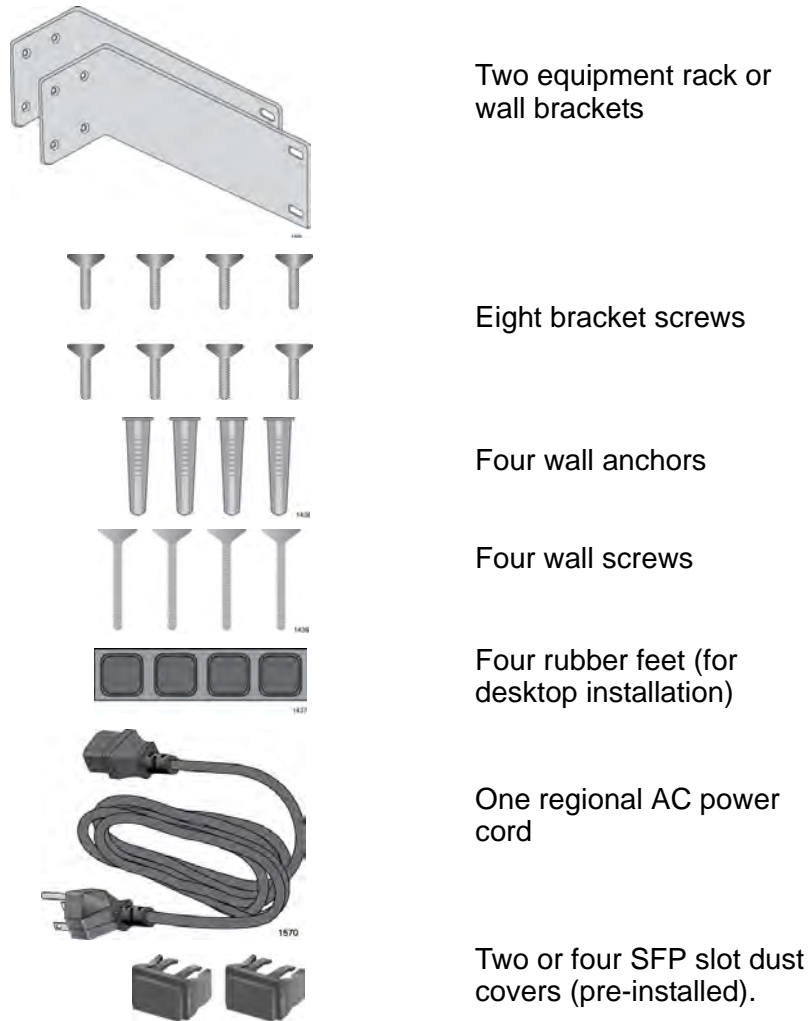

Figure 5. AT-GS950/xx Packing List

Installing the Switch on a Desktop

You may install the AT-GS950 Switch on a desktop or in a standard 19-inch equipment rack. To install the switch in a rack, refer to “Installing the Switch in an Equipment Rack” on page 32.

To place the switch on a desktop, perform the following procedure:

1. Remove all equipment from the package and store the packaging material in a safe place.
2. Turn the switch over and place it on a table.
3. Attach the four rubber feet to the bottom of the switch as shown in Figure 6.



Figure 6. Attaching the Rubber Feet

4. Turn the switch over again and place it on a flat, secure surface (such as a desk or table) leaving ample space around the unit for ventilation.
5. Go to “Installing Optional SFP Transceivers” on page 37 or “Cabling the Switch” on page 40.

Installing the Switch in an Equipment Rack

To install the switch in a standard 19-inch equipment rack, perform the following procedure:

1. If the rubber feet are attached to the bottom of the switch, remove them using a flat-head screwdriver.
2. Attach the two rack mount brackets to the sides of the switch using the eight bracket screws that come with the unit. There are four possible positions in which the brackets may be installed. See Figure 9 on page 35.

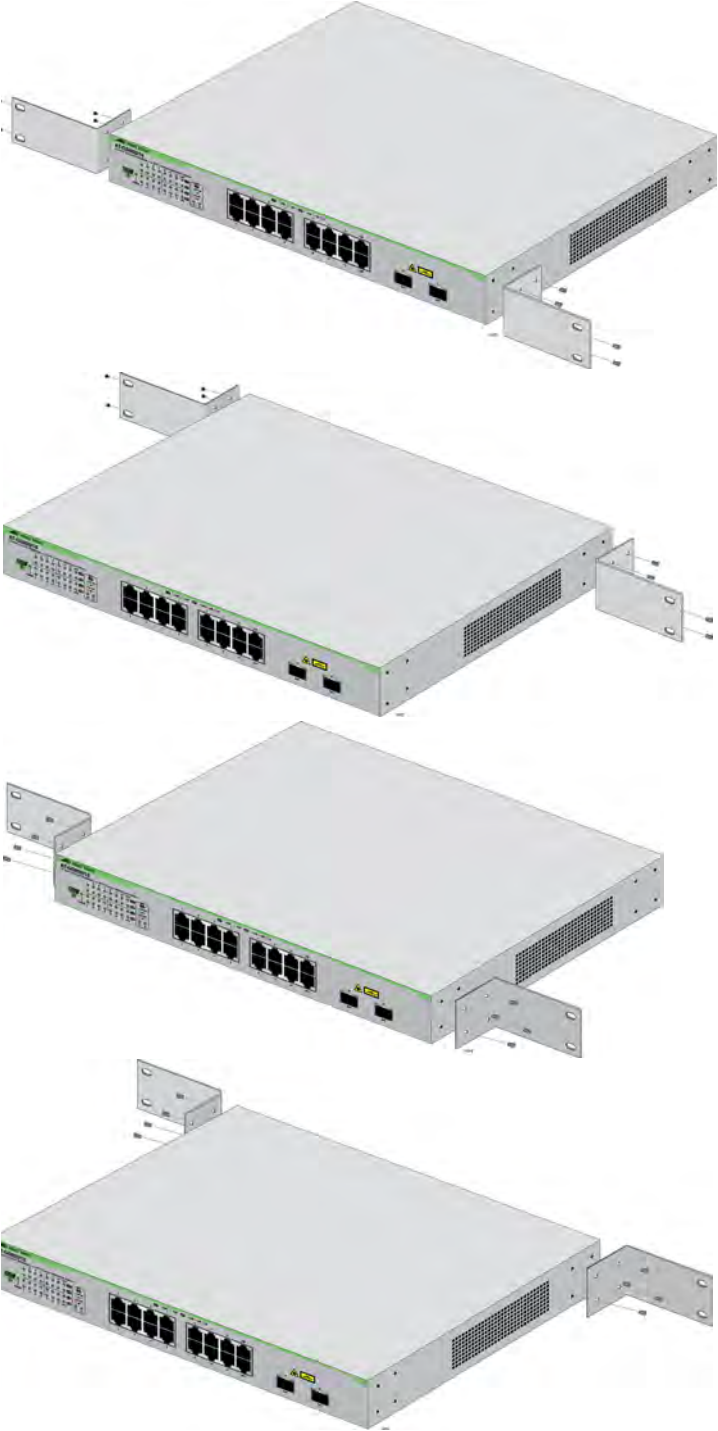

Figure 7. Attaching the Rack-Mount Brackets to the Switch

3. Mount the switch in a standard 19-inch equipment rack using four equipment rack screws (not provided with the switch).



Figure 8. Mounting the Switch in an Equipment Rack

4. Go to “Installing Optional SFP Transceivers” on page 37 or “Cabling the Switch” on page 40.

Installing the Switch on a Wall

To install the switch on a wall, perform the following procedure:

1. Turn the switch over and place it on a table.
2. If the rubber feet are attached to the bottom of the switch, remove them using a flat-head screwdriver.
3. Orient the brackets against the sides of the switch as shown in Figure 9, and secure them to the unit with the eight brackets screws included with the switch.



Figure 9. Attaching the Brackets to Install the Switch on a Wall

4. Have another person hold the switch at the wall location where the switch is to be installed, while you use a pencil or pen to mark the wall with the locations of the four holes in the brackets. The switch should be oriented such that its front faceplate is facing up and is level to the floor. See Figure 10 on page 35.



Figure 10. Marking the Screw Hole Locations

5. Install the four plastic anchors included with the switch into the wall, at the locations marked in the previous step. The anchors require 0.635 mm (0.25 in.) holes.
6. While another person holds the switch at the wall location, secure it to the wall using the four wall mounting screws. See Figure 11 on page 36.

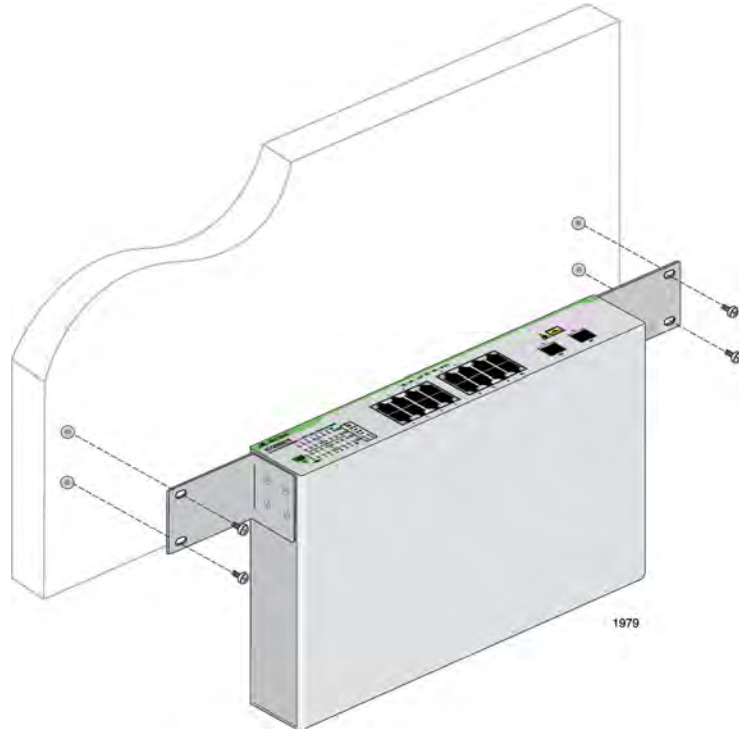

Figure 11. Securing the Switch to the Wall

7. Go to “Installing Optional SFP Transceivers” on page 37 or “Cabling the Switch” on page 40.

Installing Optional SFP Transceivers

To install an SFP transceiver, perform the following procedure:

Note

The transceiver can be hot-swapped; you do not need to power off the switch to install a transceiver. However, always remove the cables before removing the transceiver.

Note

You should always install the transceiver before connecting the fiber optic cables to it.

1. Remove the transceiver from its shipping container and store the packaging material in a safe location.

**Warning**

An SFP transceiver can be damaged by static electricity. Be sure to observe all standard electrostatic discharge (ESD) precautions, such as wearing an antistatic wrist strap, to avoid damaging the transceiver.

2. Remove the dust plug from an SFP slot. See Figure 12.

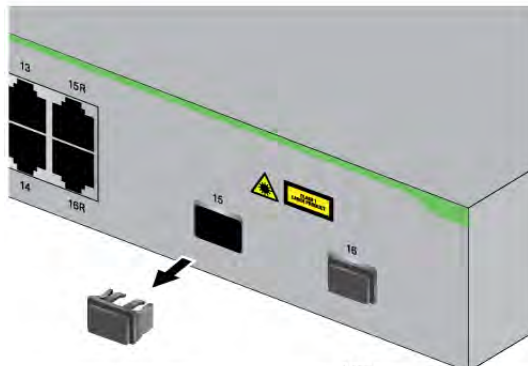

Figure 12. Removing the Dust Plug from an SFP Slot

3. Position the SFP transceiver with the label facing up.

- Slide the transceiver into the SFP slot until it clicks into place. See Figure 13

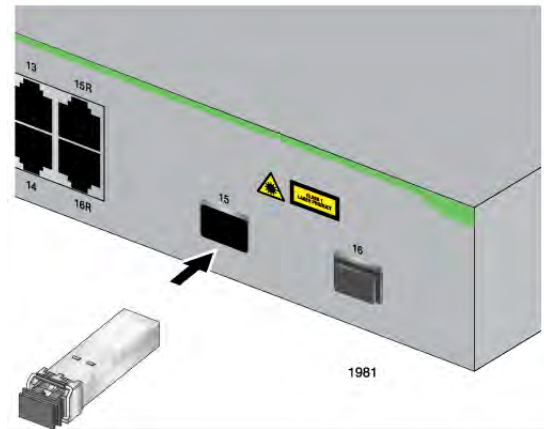

Figure 13. Inserting the SFP

- Verify that the handle on the transceiver is in the upright position, as shown in Figure 14. This secures the transceiver and prevents it from being dislodged from the slot.

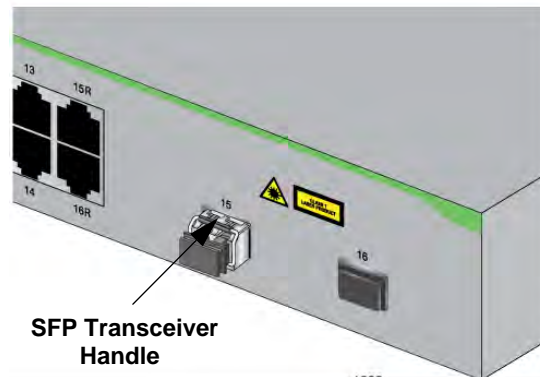

Figure 14. SFP Handle in Upright Position

- Repeat steps 2 through 5 to install additional SFP transceivers.

Note

SFP transceivers are dust sensitive. Always keep the plug in the optical bores when a fiber optic cable is not installed, or when storing the SFP. When you do remove the plug, keep it for future use.

Note

Unnecessary removal and insertion of an SFP can lead to premature failure.

For information on the cable specifications of the SFP, consult the documentation shipped with the SFP.

7. Go to “Cabling the Switch” on page 40.

Cabling the Switch

Observe the following guidelines when connecting twisted pair and fiber optic cables to the ports on the switch:

- ❑ The connector on the cable should fit snugly into the port on the switch. The tab on the connector should lock the connector into place.
- ❑ Because the twisted pair ports have auto-MDI/MDI-X, you may use straight-through twisted pair cable to connect any type of network device to the switch.
- ❑ If your network topology contains a loop where two or more network devices can communicate with each other over more than one network path, do not connect the network cables that form the loop until after you activate a spanning tree protocol on the switch. Data loops can adversely affect network performance.
- ❑ If you are creating a port trunk, do not connect the cables of the trunk to the switch until after you have created the trunk in the switch's management software. Otherwise, a network loop will result which can adversely affect network performance.

Powering On the Switch

To power on the switch, perform the following procedure:

1. Plug the power cord into the AC power connector on the back of the switch, as shown in Figure 15.



Figure 15. Plugging in the AC Power Cord

2. Plug the other end of the power cord into a wall outlet.



Warning

Power cord is used as a disconnection device. To de-energize equipment, disconnect the power cord. ⚡ E3

Note

Pluggable Equipment. The socket outlet shall be installed near the equipment and shall be easily accessible. ⚡ E5

3. Verify that the POWER LED is green. If the LED is OFF, refer to Chapter 3, “Troubleshooting” on page 43.

The switch is now powered on and ready for network operations. For information on how to manage the switch, refer to the *AT-S107, AT-S108, or AT-S109 Management Software User’s Guide*.

Chapter 3

Troubleshooting

This chapter contains information on how to troubleshoot the switch if a problem occurs.

Note

For further assistance, please contact Allied Telesis Technical Support at www.alliedtelesis.com/support.

Problem 1: The POWER LED on the front of the switch is off.

Solutions: The unit is not receiving power. Try the following:

- ❑ Verify that the power cord is securely connected to the power source and to the AC connector on the back panel of the switch.
- ❑ Verify that the power outlet has power by connecting another device to it.
- ❑ Try connecting the unit to another power source.
- ❑ Try a different power cord.
- ❑ Verify that the voltage from the power source is within the required levels for your region.

Problem 2: All of the port LEDs are off even though the ports are connected to active network devices.

Solution: The switch is probably operating in low power mode. To toggle on the LEDs, press the eco-friendly button on the front panel.

Problem 3: A twisted pair port on the switch is connected to a network device but the port's LINK/ACT LED is off.

Solutions: The port is unable to establish a link to a network device. Try the following:

- ❑ Verify that the network device connected to the twisted pair port is powered on and is operating properly.
- ❑ Verify that the twisted pair cable is securely connected to the port on the media converter channel and to the port on the remote network device.
- ❑ Verify that the port is connected to the correct twisted pair cable. This is to eliminate the possibility that the port is connected to the wrong network device, such as a powered off device.

- ❑ Try connecting another network device to the twisted pair port with a different cable. If the twisted pair port is able to establish a link, then the problem is with the cable or the other network device.
- ❑ Verify that the twisted pair cable does not exceed 100 meters (328 feet).
- ❑ Verify that you are using the appropriate category of twisted pair cable: Category 3 or better for 10 Mbps operation and Category 5 and Category 5E for 100 and 1000 Mbps operation.

Note

A 1000Base connection may require five to ten seconds to establish a link.

Problem 4: The LINK/ACT LED for an SFP transceiver is off.

Solutions: The fiber optic port on the transceiver is unable to establish a link to a network device. Try the following:

- ❑ Verify that the network device connected to the fiber optic port is operating properly.
- ❑ Verify that the fiber optic cable is securely connected to the port on the media converter channel and to the port on the remote network device.
- ❑ Check that the SFP module is fully inserted in the slot.
- ❑ Verify that the operating specifications of the fiber optic ports on the SFP transceiver and the remote network device are compatible.
- ❑ Verify that the correct type of fiber optic cabling is being used.
- ❑ Verify that the port is connected to the correct fiber optic cable. This is to eliminate the possibility that the port is connected to the wrong remote network device, such as a powered off device.
- ❑ Try connecting another network device to the fiber optic port using a different cable. If the port is able to establish a link, then the problem is with the cable or with the other network device.
- ❑ Use the switch's management software to verify that the port is enabled.
- ❑ If the remote network device is a management device, use its management firmware to determine whether its port is enabled.
- ❑ Test the attenuation on the fiber optic cable with a fiber optic tester to determine whether the optical signal is too weak (sensitivity) or too strong (maximum input power).

Problem 5: Network performance between a twisted pair port on the switch and a network device is slow.

Solution: There might be a duplex mode mismatch between the port and the network device. This occurs when a twisted pair port using Auto-Negotiation is connected to a device with a fixed duplex mode of full duplex. If this is the cause of the problem, adjust the duplex mode of the port on the network device or on the switch so that both ports are using the same duplex mode.

Problem 6: A port's LINK/ACT LED is blinking.

Solutions: The link between the port and the network device is intermittent. Try the following:

- ❑ Connect another network device with a different cable to the port. If the Link LED remains steady on, then the problem is with the original cable or the network device.
- ❑ If the problem is with an SFP transceiver, check that the transceiver is fully inserted in the slot.

Appendix A

Technical Specifications

This appendix contains the technical specifications for the AT-GS950/8, AT-GS950/16, AT-GS950/24 and AT-GS950/48 switches. The specification categories are as follows:

“Physical Specifications” on page 48

“Environmental Specifications” on page 49

“Power Specifications” on page 49

“Certifications” on page 49

“Connectors and Port Pinouts” on page 50

Physical Specifications

Dimensions (H x W x D)

Table 6. Product Dimensions

Model	Specification
AT-GS950/8	33 cm x 20 cm x 4.4 cm (13 in x 7.87 in x 1.73 in)
AT-GS950/16	33 cm x 20 cm x 4.4 cm (13 in x 7.87 in x 1.73 in)
AT-GS950/24	33 cm x 20 cm x 4.4 cm (13 in x 7.87 in x 1.73 in)
AT-GS950/48	44.4 cm x 25.7 cm x 4.32 cm (17.48 in x 10.12 in x 1.7 in)

Weights

Table 7. Product Weights

Model	Specifications
AT-GS950/8	1.5 kg (3.3 lbs)
AT-GS950/16	2.1 kg (4.60 lbs)
AT-GS950/24	2.3 kg (5.1 lbs)
AT-GS950/48	4.1 kg (9.0 lbs)

Environmental Specifications

Table 8. Environmental Specifications

Parameter	Specifications
Operating Temperature	0° C to 40° C (32° F to 104° F)
Storage Temperature	-25° C to 70° C (-13° F to 158° F)
Operating Humidity	5% to 90% noncondensing
Storage Humidity	5% to 95% noncondensing

Power Specifications

Input Supply Voltage - 100-240 VAC, 50 - 60 Hz

Table 9. Max AC Input Power Specifications

Parameter	Specifications
AT-GS950/8	8.7 W
AT-GS950/16	12.9 W
AT-GS950/24	17.3 W
AT-GS950/48	43.0 W

Certifications

Table 10. Product Certifications

Parameter	Specifications
EMI (Emissions)	FCC Class A, EN55022 Class A, CISPR 22 Class A
EMC (Immunity)	EN55024
Electrical and Laser Safety	EN60950-1 (TUV), UL 60950-1 (CUL-US), C-TICK, CE

Connectors and Port Pinouts

This section lists the connectors and connector pinouts.

Figure 16 illustrates the pin layout for an RJ-45 connector and port.

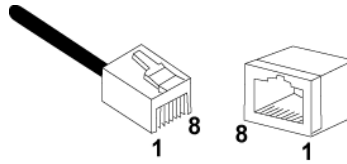

Figure 16. RJ-45 Connector and Port Pin Layout

Table 11 lists the RJ-45 pin signals when a twisted pair port is operating in the MDI configuration.

Table 11. MDI Pin Signals (10Base-T or 100Base-TX)

Pin	Signal
1	TX+
2	TX-
3	RX+
6	RX-

Table 12 lists the RJ-45 port pin signals when a twisted pair port is operating in the MDI-X configuration.

Table 12. MDI-X Pin Signals (10Base-T or 100Base-TX)

Pin	Signal
1	RX+
2	RX-
3	TX+
6	TX-

Table 13 lists the RJ-45 connector pins and their signals when a 1000Base-T port is operating at 1000 Mbps.

Table 13. RJ-45 1000Base-T Connector Pinouts

Pin	Pair	Signal
1	1	TX and RX+
2	1	TX and RX-
3	2	TX and RX+
4	3	TX and RX+
5	3	TX and RX-
6	2	TX and RX-
7	4	TX and RX+
8	4	TX and RX-

