

VDSL Ethernet Extender

AT-MC605

Installation Guide

Copyright 2009 Allied Telesis, Inc.

All rights reserved. No part of this publication may be reproduced without prior written permission from Allied Telesis, Inc.

Allied Telesis and the Allied Telesis logo are trademarks of Allied Telesis, Incorporated. All other product names, company names, logos or other designations mentioned herein are trademarks or registered trademarks of their respective owners.

Allied Telesis, Inc. reserves the right to make changes in specifications and other information contained in this document without prior written notice. The information provided herein is subject to change without notice. In no event shall Allied Telesis, Inc. be liable for any incidental, special, indirect, or consequential damages whatsoever, including but not limited to lost profits, arising out of or related to this manual or the information contained herein, even if Allied Telesis, Inc. has been advised of, known, or should have known, the possibility of such damages.

Electrical Safety and Emissions Standards

This product meets the following standards.

U.S. Federal Communications Commission	
Declaration of Conformity	
Manufacturer Name: Allied Telesis, Inc.	
Declares that the product: VDSL Ethernet Extender	
Model Number: AT-MC605	
This product complies with FCC Part 15B, Class B Limits:	
This device complies with part 15 of the FCC Rules. Operation is subject to the following two conditions: (1) This device must not cause harmful interference, and (2) this device must accept any interference received, including interference that may cause undesired operation.	
Radiated Energy	
Note: This equipment has been tested and found to comply with the limits for a Class B digital device pursuant to Part 15 of FCC Rules. These limits are designed to provide reasonable protection against harmful interference in a residential installation. This equipment generates, uses and can radiate radio frequency energy and, if not installed and used in accordance with instructions, may cause harmful interference to radio or television reception, which can be determined by turning the equipment off and on. The user is encouraged to try to correct the interference by one or more of the following measures:	
<ul style="list-style-type: none">- Reorient or relocate the receiving antenna.- Increase the separation between the equipment and the receiver.- Connect the equipment into an outlet on a circuit different from that to which the receiver is connected.- Consult the dealer or an experienced radio/TV technician for help.	
Changes and modifications not expressly approved by the manufacturer or registrant of this equipment can void your authority to operate this equipment under Federal Communications Commission rules.	

Industry Canada	
This Class B digital apparatus complies with Canadian ICES-003.	
Cet appareil numérique de la classe B est conforme à la norme NMB-003 du Canada.	

European Union Restriction of the Use of Certain Hazardous Substances (RoHS) in Electrical and Electronic Equipment	
This Allied Telesis RoHS-compliant product conforms to the European Union Restriction of the Use of Certain Hazardous Substances (RoHS) in Electrical and Electronic Equipment. Allied Telesis ensures RoHS conformance by requiring supplier Declarations of Conformity, monitoring incoming materials, and maintaining manufacturing process controls.	

RFI Emissions	FCC Class B, EN55022 Class B, EN61000-3-2, EN61000-3-3, VCCI Class B, C-TICK, CE
Immunity	EN55024
Electrical Safety	EN60950 (TUV), UL 60950 (cUL _{US})

Translated Safety Statements

Important: The  indicates that a translation of the safety statement is available in a PDF document titled “Translated Safety Statements” (613-000990) posted on the Allied Telesis website at www.alliedtelesis.com and on this product CD.

Contents

Preface	11
Safety Symbols Used in this Document	12
Where to Find Web-based Guides	13
Contacting Allied Telesis	14
Online Support	14
Email and Telephone Support	14
Returning Products	14
For Sales or Corporate Information	14
Warranty	14
Chapter 1: Overview	15
Summary of Features	16
AT-MC605 Port Descriptions	18
VDSL Line Port	18
Phone Port	18
10Base-T/100Base-Tx Ethernet Port	19
Status LEDs	22
VDSL Configuration DIP Switches	24
VDSL Switch Definitions	24
VDSL Configuration DIP Switch Descriptions	25
External AC/DC Power Adapter	27
Multiple Dwelling Unit (MDU) Topology	28
Chapter 2: Installation	30
Reviewing Safety Precautions	31
Selecting a Site for the AT-MC605 Ethernet Extender	32
Required Cabling	33
Unpacking the AT-MC605 Ethernet Extender	34
Installing the AT-MC605 VDSL Ethernet Extender Subscriber Unit	35
Using the Subscriber Unit on a Desktop	35
Wall-Mounting the Subscriber Unit	36
Cabling the Subscriber Unit	36
Powering On the Subscriber Unit	38
Installing the AT-MC605 Ethernet Extender Provider Unit	39
Using the Provider Unit on a Desktop	39
Wall-Mounting the Provider Unit	40
Rack-Mounting the Provider Unit	41
Cabling the Provider Unit	42
Powering On the Provider Unit	44
Chapter 3: Troubleshooting	45
LEDs	45
Appendix A: Technical Specifications	47
Physical Specifications	47
Environmental Specifications	47
Power Specifications	47
Safety and Electromagnetic Compatibility Certifications	48

List of Figures

Figure 1. AT- MC605 Front Panel.....	16
Figure 2. AT-MC605 Rear Panel	17
Figure 3. RJ-45 10Base-T/100Base-TX Connector Pin Assignments	21
Figure 4. VDSL Configuration DIP Switches	25
Figure 5. University Dormitory (MDU) Point-to-Point Topology	28
Figure 6. Attaching Protective Feet to the Subscriber Unit.....	35
Figure 7. Configuring AT-MC605 Ethernet Extender for Subscriber Mode	35
Figure 8. Connecting AT-MC605 Ethernet Port to Computer	36
Figure 9. Connecting AT-MC605 Phone Port to Telephone	37
Figure 10. VDSL Line to Wall/Interior Phone Line	37
Figure 11. Power On The Subscriber Unit.....	38
Figure 12. Attaching Protective Feet to the Provider Unit.....	39
Figure 13. Configuring AT-MC605 Ethernet Extender for Provider Mode	40
Figure 14. Configuring AT-MC605 Ethernet Extender for Provider Mode	41
Figure 15. Rack Mount - Set on Slider.....	41
Figure 16. Rack Mount - Set in Rack.....	42
Figure 17. Connecting AT-MC605 Ethernet Port to an Internet Service Provider	42
Figure 18. Connecting AT-MC605 Phone Port to PBX Connection.....	43
Figure 19. VDSL Line to Wall/Interior Phone Line.	43
Figure 20. Power On The Subscriber Unit.....	44

List of Tables

Table 1. Safety Symbols	12
Table 2. RJ-11 VDSL Line Port Pinouts	18
Table 3. RJ-11 Phone Port Pinouts	18
Table 4. RJ-45 Port Pinouts	21
Table 5. Front Panel Status LEDs	22
Table 6. VDSL Configuration DIP Switches	24
Table 7. AT-MC605 Cables	33

Preface



This guide contains instructions on how to install the AT-MC605 VDSL Ethernet Extender and contains the following sections:

- “Safety Symbols Used in this Document” on page 12
- “Where to Find Web-based Guides” on page 13
- “Contacting Allied Telesis” on page 14

Safety Symbols Used in this Document

This document uses the safety symbols defined in Table 1.

Table 1. Safety Symbols

Symbol	Meaning	Description
	Caution	Performing or omitting a specific action may result in equipment damage or loss of data.
	Warning	Performing or omitting a specific action may result in electrical shock.

Where to Find Web-based Guides

The installation and user guides for all Allied Telesis products are available in portable document format (PDF) on our web site at **www.alliedtelesis.com**. You can view the documents online or download them onto a local workstation or server.

Contacting Allied Telesis

This section provides Allied Telesis contact information for technical support as well as sales or corporate information.

Online Support

You can request technical support online by accessing the Allied Telesis Knowledge Base: www.alliedtelesis.com/support/kb.aspx. You can use the Knowledge Base to submit questions to our technical support staff and review answers to previously asked questions.

Email and Telephone Support

For Technical Support via email or telephone, refer to the Support section of the Allied Telesis web site: www.alliedtelesis.com/support.

Returning Products

Products for return or repair must first be assigned a return materials authorization (RMA) number. A product sent to Allied Telesis without an RMA number will be returned to the sender at the sender's expense. For instructions on how to obtain an RMA number, go to the Support section on our web site at www.alliedtelesis.com/support/rma.aspx.

For Sales or Corporate Information

You can contact Allied Telesis for sales or corporate information through our web site at <http://www.alliedtelesis.com/purchase>.

Warranty

For warranty information on the AT-MC605 VDSL Ethernet Extender, go to www.alliedtelesis.com/warranty for the specific terms and conditions of the warranty and for warranty registration.

Chapter 1

Overview

The AT-MC605 VDSL Ethernet Extended product is designed to transmit and receive data at very high speeds over unshielded pairs of copper wires using VDSL technology on your existing private telephone line.

This chapter contains the following sections:

- ❑ “Summary of Features” on page 16
- ❑ “AT-MC605 Port Descriptions” on page 18
- ❑ “Status LEDs” on page 22
- ❑ “VDSL Configuration DIP Switches” on page 24
- ❑ “External AC/DC Power Adapter” on page 27
- ❑ “Multiple Dwelling Unit (MDU) Topology” on page 28

Summary of Features

The AT-MC605 VDSL Ethernet Extender provides the following features:

- ❑ VDSL (Very high-bit-rate Digital Subscriber) protocol over existing private telephone lines.
- ❑ Phone port with an RJ-11 connector
- ❑ 10Base-T/100Base-TX ethernet port with an RJ-45 connector
- ❑ Auto MDI/MDI-X
- ❑ Auto-Negotiation for speed and duplex mode (IEEE 803.3u-compliant)
- ❑ Status LEDs for both 10Base-T/100Base-TX and VDSL Line ports
- ❑ 12V DC external power supply input port
- ❑ Installation on desktop, wall, DINRAIL, or rack mounting in an AT-MCR12 rackmount chassis
- ❑ Fully EU RoHS and China RoHS compliant

Figure 1. illustrates the front panel of the AT-MC605 VDSL Ethernet Extender.

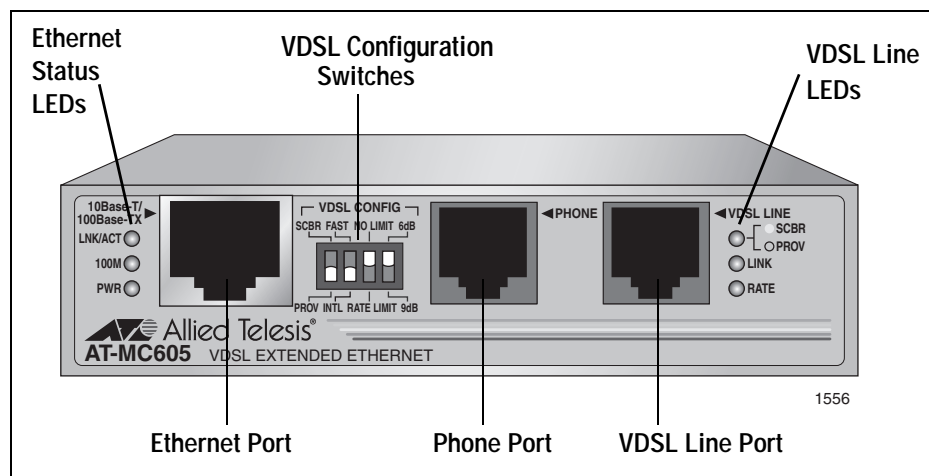

Figure 1. AT- MC605 Front Panel

Figure 2. illustrates the rear panels of the AT-MC605 VDSL Ethernet Extender.

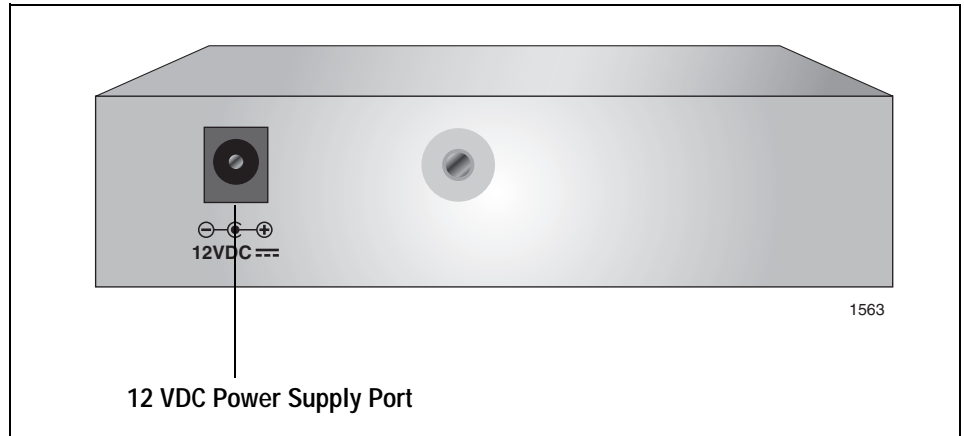

Figure 2. AT-MC605 Rear Panel

AT-MC605 Port Descriptions

VDSL Line Port The VDSL Line port features an RJ-11 connector. It allows you to connect two AT-MC605 VDSL Ethernet Extender units together using existing internal building telephone copper pairs. By using this equipment, both ethernet data and analog phone service are made accessible within a building without installing additional wiring for the ethernet connections. One AT-MC605 Ethernet Extender is configured as a Provider unit and the other as a Subscriber unit. The two units need to be within 3,000 meters (9842 feet) of each other in order for the port to operate properly.

Table 2 lists the RJ-11 VDSL Line Port pinouts and their assignments.

Table 2. RJ-11 VDSL Line Port Pinouts

Pin	Assignment
1	N/C
2	N/C
3	VDSL and phone ring
4	VDSL and phone tip
5	N/C
6	N/C1

Phone Port The Phone Port which allows you to connect one AT-MC605 Ethernet Extender configured as a Subscriber unit to a telephone and a second AT-MC605 Ethernet Extender configured as a Provider unit to your private telephone equipment in the building equipment room. This port features an RJ-11 connector.

Table 3 lists the RJ-11 Phone Port pinouts and their assignments.

Table 3. RJ-11 Phone Port Pinouts

Pin	Assignment
1	N/C
2	N/C
3	phone ring
4	phone tip

Table 3. RJ-11 Phone Port Pinouts

Pin	Assignment
5	N/C
6	N/C

10Base-T/ 100Base-Tx Ethernet Port

The AT-MC605 VDSL Ethernet Extender has one 10Base-T/100Base-Tx ethernet port which allows you to connect one AT-MC605 Ethernet Extender configured as a Subscriber unit to a computer and a second AT-MC605 Ethernet Extender configured as a Provider unit to an Internet Service Provider connection in the building equipment room. This twisted pair port features an RJ-45 connector with a maximum operating distance of 100 meters (328 feet). For the port pinout details, refer to “RJ-45 Port Pinouts” on page 21.

Type of Cabling

The 10Base-T/100Base-TX ethernet port is designed to operate with unshielded twisted pair cables. For 10 Mbps operation, Category 3 or better 100 ohm unshielded twisted pair cabling is required. For 100 Mbps operation, Category 5 and Enhanced Category 5 (5E) 100 ohm unshielded twisted pair cabling is recommended.

Auto MDI/MDI-X

A 10Base-T/100Base-TX ethernet port on a network device can have one of two possible wiring configurations: MDI or MDI-X. The ethernet port on a PC, router, or bridge is typically wired as MDI, while the twisted pair port on a switch or hub is usually MDI-X.

The AT-MC605 ethernet port features automatic MDI/MDI-X. The port automatically determines the configuration of its end-node and then configures itself appropriately. For example, if the AT-MC605 ethernet port is connected to a port on a bridge, which is typically wired as MDI, the AT-MC605 Ethernet Extender automatically configures the ethernet port to MDI-X. This feature allows you to use either straight-through or crossover cables when connecting the AT-MC605 Ethernet Extender to other ethernet devices.

Auto-Negotiation

The AT-MC605 VDSL Ethernet Extender Auto-Negotiates the speed and duplex mode of the ethernet link, so that the link comes up in the highest performance configuration supported by both ends. For example, if an end node is capable of only 10 Mbps, the AT-MC605 Ethernet Extender sets its ethernet port to 10 Mbps or if an end node is capable of 100 Mbps, the

ethernet port is set to 100 Mbps.

Half- and Full-duplex Mode

Duplex mode refers to the way an end-node sends and receives data on the network. An end-node can operate in either half- or full-duplex mode, depending on its capabilities. In half-duplex mode, data can be either sent or received, but not at the same time. In full-duplex mode, data can be sent and received simultaneously. The best network performance is achieved when an end-node can operate at full-duplex, since the end-node is able to send and receive data simultaneously.

The AT-MC605 VDSL Ethernet Extender can Auto-Negotiate to either half- or full-duplex mode, but cannot be manually configured to either mode. As a consequence, the end node must also be operating in the Auto-Negotiation mode for proper operation.

Note

For Auto-Negotiation to operate properly, the end-nodes connected to the AT-MC605 VDSL Ethernet Extender should also use Auto-Negotiation. If an end-node does not have this feature and has a fixed duplex mode of full-duplex, the result will be a duplex mode mismatch with the end-node. The AT-MC605 ethernet port ends up in the half-duplex mode if it is connected to an end-node with a fixed full-duplex mode. This configuration can produce network performance problems. Should you encounter this situation, you must configure the port on the end-node to use Auto-Negotiation or, if it lacks that feature, to half-duplex.

RJ-45 Port Pinouts

The pin assignments of an RJ-45 10Base-T/100Base-TX connector and port are illustrated in Figure 3.

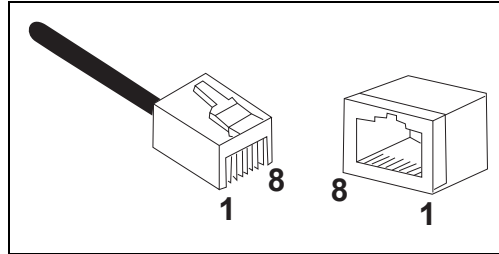

Figure 3. RJ-45 10Base-T/100Base-TX Connector Pin Assignments

Table 4 lists the RJ-45 10Base-T/100Base-TX connector pins and their signals when the port is operating in either MDI or MDI-X configuration.

Table 4. RJ-45 Port Pinouts

Pin	MDI Signal	MDI-X Signal
1	TX+	RX+
2	TX-	RX-
3	RX+	TX+
6	RX-	TX-

Status LEDs

The AT-MC605 VDSL Ethernet Extender features the status LEDs and are defined in Table 5.

Table 5. Front Panel Status LEDs

LED	Color	Description
PWR	GREEN	Power is applied to the unit.
	OFF	Power is not applied to the unit.
10/100Base-TX Port		
LINK/ ACT	Solid GREEN	A link has been established on the port.
	Blinking GREEN	Network traffic is being transmitted and/or received.
	OFF	A link has not been established.
100M	Solid GREEN	Port is linked at 100 Mbps.
	OFF	Port is linked at 10 Mbps when LINK/ACT LED is solid or blinking GREEN.
VDSL LINE Port		
SCBR/ PROV	Solid GREEN	Unit is configured as a Subscriber Unit (SCBR)
	OFF	Unit is configured as a Provider Unit (PROV)
LINK	Slow Blinking GREEN	VDSL is idle when blinking occurs approximately 1 time/sec.
	Fast Blinking GREEN	VDSL is in the training or handshake mode when the blinking occurs approximately 3 times/sec.
	Solid GREEN	VDSL has established a connection with its link partner.
	Rapid Blinking GREEN	VDSL activity is occurring when the blinking occurs approximately 6 times/sec.
	OFF	VDSL link is not established.

Table 5. Front Panel Status LEDs

LED	Color	Description
RATE	Blinking GREEN/	After a VDSL link is established, the Rate LED will continuously blink a set number of times in a set time interval. Each “blink” represents approximately 10 Mbps of VDSL line rate (e.g., six “blinks represents a VDSL line rate of 60 Mbps).

VDSL Configuration DIP Switches

VDSL Switch Definitions

The AT-MC605 VDSL Ethernet Extender features the four VDSL Configuration DIP switches on the front panel. The UP/DOWN positions of each switch are shown in “VDSL Configuration DIP Switches” on page 25 and defined in Table 6 below.

Table 6. VDSL Configuration DIP Switches

Switch	Position	Switch Function	Description
Left	UP	SCBR	Unit is configured for the Subscriber Mode.
	DOWN	PROV	Unit is configured for the Provider Mode.
Left Center	UP	FAST	FAST mode guarantees a minimum end to end latency less than 1 ms.
	DOWN	INTL	INTL (Interleaved) mode protects from impulse noises with a duration less than 250 ms This results in a maximum end to end latency of less than 6 ms.
Right Center	UP	NO LIMIT	NO LIMIT mode is an asymmetrical mode which provides line rates of up to 100 Mbps for the downlink and 60 Mbps for the uplink.
	DOWN	RATE LIMIT	RATE LIMIT mode limits the downlink and uplink line rates to a symmetrical mode where the line rates in both directions are approximately the same.
Right	UP	6 dB	The unit provides optimum Signal to Noise Ratio (SNR) for VDSL line length of less than 305 meters (1000 feet).
	DOWN	9 dB	The unit provides optimum Signal to Noise Ratio (SNR) for VDSL line length between 305 meters (1000 feet) and 3000 meters (9842 feet).

The front panel VDSL Configuration DIP switches are shown in Figure 4

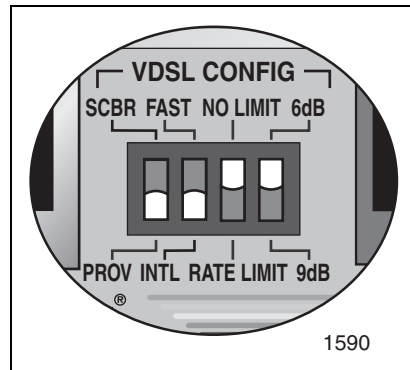

Figure 4. VDSL Configuration DIP Switches

VDSL Configuration DIP Switch Descriptions

SCBR/PROV VDSL Configuration Switch

The **SCBR/PROV** (Left) switch defines the function of the AT-MC605 Ethernet Extender as either a Subscriber or a Provider unit. The Subscriber (SCBR) position is selected when the AT-MC605 Ethernet Extender is used at the end point of the VDSL line where the ethernet and phone lines are distributed to the end-user. The Provider (PROV) position is selected when the AT-MC605 Ethernet Extender is used as the source for the VDSL line. Normally, two AT-MC605 Ethernet Extenders work together in tandem - one as a Subscriber unit and the other as a Provider unit.

FAST/INTL VDSL Configuration Switch

The **FAST/INTL** (Left Center) switch is used when noise compensation is required. If the VDSL line is operating in a relatively low noise environment, the data link and data transmission are usually reliable. The FAST position is recommended in this case. This operating mode has the advantage of short latency times - usually less than 1 ms.

You will want to select the INTL (Interleaved) position if you notice that the VDSL link is being repeatedly dropped or data is being lost, excessive noise bursts on the line may be the cause. With the Interleaved selection, the transmitted data is combined or interleaved with data correction code. This combination reduces the data errors, packet losses and loss of sync caused by a noisy environment. However, because the additional data correction code is added to the data stream, the overall transmission latency will increase and is usually less than 6 ms. The overall effect of this setting is more reliable data transmissions in a noisy environment.

NO LIMIT/RATE LIMIT VDSL Configuration Switch

The **NO LIMIT/RATE LIMIT** (Right Center) switch selects the maximum data rate for the VDSL line. The NO LIMIT position is the factory default for this switch, which allows a maximum downstream data rate of 100 Mbps and a maximum upstream data rate of 60 Mbps. The RATE LIMIT position limits the downlink and uplink line rates to a symmetrical mode where the line rates in both directions are approximately the same.

6 dB/9 dB VDSL Configuration Switch

The **6 dB/9 dB** (Right) switch selects the optimum signal to noise ratio (SNR) for your VDSL line which is dependent on the VDSL line length. The factory default setting for this switch is 6 dB SNR and assumes that your VDSL line is less than 305 meters (1000 feet) in length. Select the 9 dB SNR setting if your VDSL line is between 305 meters and 3000 meters (9842 feet) or if a more stable link and more noise protection is needed.

External AC/DC Power Adapter

An external, energy efficient, AC/DC power adapter is included with the AT-MC605 VDSL Ethernet Extender for desktop or wall-mount operation. The power adapter supplies 12V DC to the AT-MC605 Ethernet Extender. Allied Telesis supplies an approved safety compliant AC power adapter specifically designed for each region where the AT-MC605 VDSL Ethernet Extender is sold. Each type of power adapter has an unregulated output of 12V DC at 1A.

The AT-MC605 Ethernet Extender has a single DC power supply socket on the back panel. The unit does not have a power switch. To turn the unit ON or OFF, you must connect or disconnect the DC power cord.

Multiple Dwelling Unit (MDU) Topology

The AT-MC605 Ethernet Extender can be used in multi-dwelling units (MDU), multi-tenant buildings (MTU), and in the hospitality industry, such as airports, hotels, and convention centers.

When configured as a subscriber unit, the AT-MC605 Ethernet Extender can be used as a desktop or wallmount device. If the AT-MC605 Ethernet Extender is configured as a provider unit in a wiring closet or telecommunications room, it may be mounted on the wall, on a DINRAIL, or in an AT-MCR12 rackmount chassis in an equipment rack. Refer to “Installing the AT-MC605 Ethernet Extender Provider Unit” on page 39 for installation details. These units are manually configured as a subscriber/provider unit when installed.

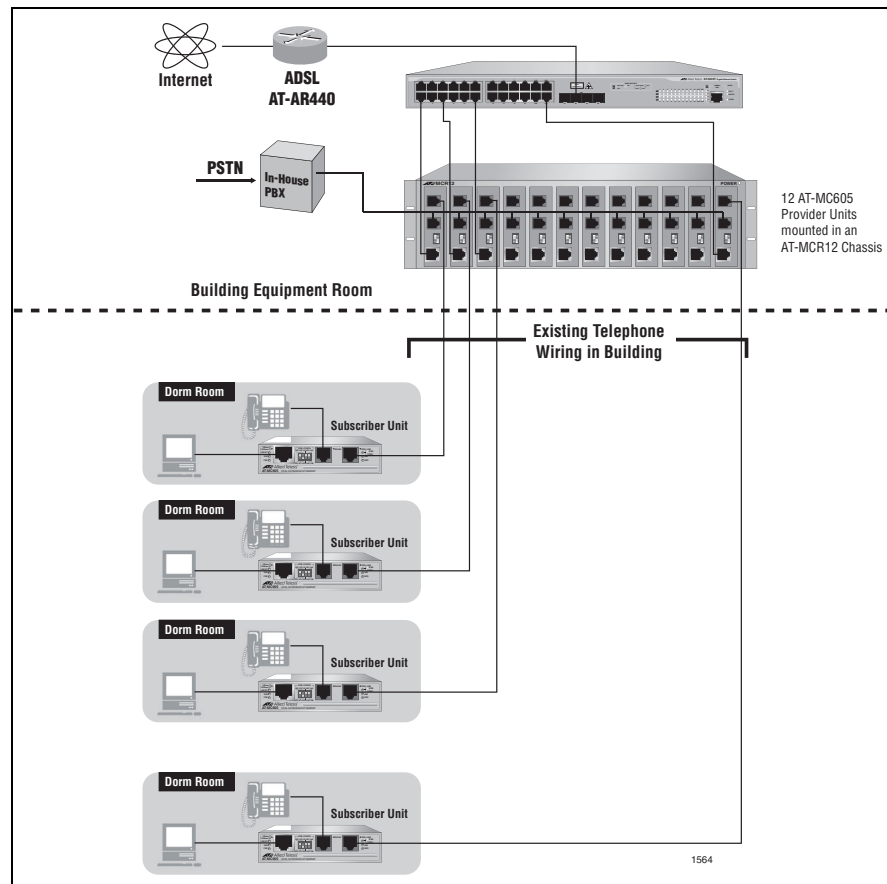

Figure 5. University Dormitory (MDU) Point-to-Point Topology

For example, Figure 5 illustrates a point-to-point topology for a university dormitory (MDU) where both the phone and internet services are delivered to each room using VDSL via the building’s existing telephone wiring. An AT-MC605 Subscriber unit is installed in each dorm room. The AT-MC605 Provider units are located in the building’s central equipment room and are

individually assigned to each dorm room. The Provider units are rack mounted together in AT-MCR12 chassis where they are connected to the building's telephone switch and internet service.

Chapter 2

Installation

This chapter contains the installation procedures for the AT-MC605 VDSL Ethernet Extender in the following sections:

- ❑ “Reviewing Safety Precautions” on page 31
- ❑ “Selecting a Site for the AT-MC605 Ethernet Extender” on page 32
- ❑ “Required Cabling” on page 33
- ❑ “Unpacking the AT-MC605 Ethernet Extender” on page 34
- ❑ “Installing the AT-MC605 VDSL Ethernet Extender Subscriber Unit” on page 35
- ❑ “Installing the AT-MC605 Ethernet Extender Provider Unit” on page 39

Reviewing Safety Precautions

Please review the following safety precautions before you begin to install the AT-MC605 VDSL Ethernet Extender.

Only use the power adapter supplied when the AT-MC605 VDSL Ethernet Extender is installed as a stand alone unit. No power adapter is required if the unit is inserted in the AT-MCR12 rackmount chassis.

**Warning**

Lightning Danger: Do not work on this equipment or cables during periods of lightning activity. ⚡ E2

**Caution**

Power cord is used as a disconnection device: To de-energize equipment, disconnect the power cord. ⚡ E3

**Caution**

Air vents: The air vents must not be blocked on the unit and must have free access to the room's ambient air for cooling. ⚡ E6

**Warning**

Operating Temperature: This product is designed for a maximum ambient temperature of 40°C. ⚡ E7

All Countries: Install this product in accordance with local and national electric codes. ⚡ E8

Selecting a Site for the AT-MC605 Ethernet Extender

Observe the following requirements when choosing a site for your AT-MC605 VDSL Ethernet Extender:

- ❑ If you plan to install a AT-MC605 Ethernet Extender into an AT-MCR12 rackmount chassis and equipment rack, check to be sure that the rack is safely secured and that it will not tip over. Devices in a rack should be installed starting at the bottom, with the heavier devices near the bottom of the rack.
- ❑ The AT-MC605 Ethernet Extender may be wall mounted either on a DINRAIL using a DINRAIL bracket or using an AT-WLMT bracket. Both brackets are provide separately. Select a place on the wall that provides the best cabling and power access.

Note

Both the DINRAIL bracket and the AT-WLMT wall mount bracket are sold separately. Contact your Allied Telesis Sales representative to purchase these items.

- ❑ If you are installing the AT-MC605 Ethernet Extender on a table, be sure that the table is level and secure.
- ❑ The power outlet for the AT-MC605 Ethernet Extender should be located near the unit and should be easily accessible.
- ❑ The site should provide for easy access to the ports on the front of the AT-MC605 Ethernet Extender. This makes it easy for you to connect and disconnect cables, as well as view the LEDs.
- ❑ To allow proper cooling of the AT-MC605 Ethernet Extender, air flow around the unit and through its vents on the side should not be restricted.
- ❑ Do not place objects on top of the AT-MC605 Ethernet Extender.
- ❑ Do not expose the AT-MC605 Ethernet Extender to moisture or water.
- ❑ Make sure that the site is a dust-free environment.
- ❑ You should use dedicated power circuits or power conditioners to supply reliable electrical power to the AT-MC605 Ethernet Extender.

Required Cabling

The AT-MC605 VDSL Ethernet Extender requires two or more of the three cables described in Table 7 below. These cables are not shipped with the AT-MC605 Ethernet Extender.

Table 7. AT-MC605 Cables

Port	Cable	Connector
Ethernet	Category 3 or better 100-ohm unshielded straight-through or crossover twisted pair cable	RJ-45
Phone	standard telephone cable	RJ-11
VDSL Line	standard telephone cable	RJ-11

Unpacking the AT-MC605 Ethernet Extender

To unpack the AT-MC605 product:

1. Remove all components from the shipping package and store the packaging material in a safe location.

Note

You must use the original shipping material if you need to return the unit to Allied Telesis.

2. Make sure the following hardware components are included in your AT-MC605 package. If any item is missing or damaged, contact your Allied Telesis sales representative for assistance.
 - One AT-MC605 Ethernet Extender
 - Four protective feet
 - One universal energy efficient power adapter

Installing the AT-MC605 VDSL Ethernet Extender Subscriber Unit

The AT-MC605 Subscriber unit is normally used as a stand-alone device, or can be used as a desktop device, or mounted to a wall.

Using the Subscriber Unit on a Desktop

To use the Subscriber unit on a desktop, perform the following procedure:

1. Remove all equipment from the package and store the packaging material in a safe place.
2. Attach the four protective feet (provided) to each corner of the bottom of the unit, as illustrated in Figure 6 , "Attaching Protective Feet to the Subscriber Unit".

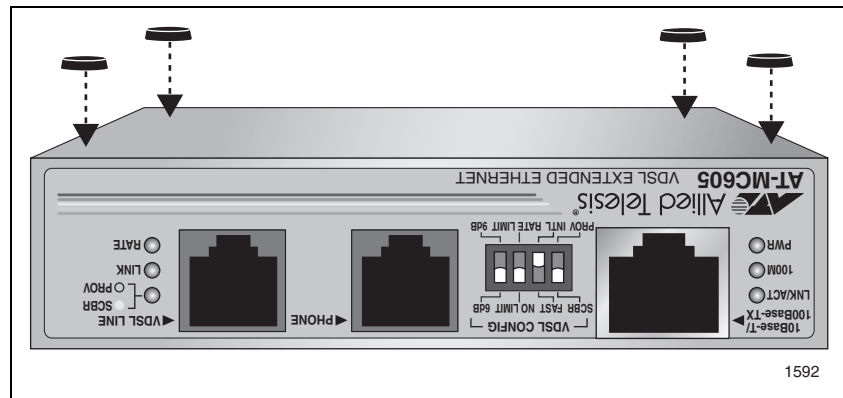

Figure 6. Attaching Protective Feet to the Subscriber Unit

3. Position the AT-MC605 Ethernet Extender on the desktop.
4. Configure the right VDSL CONFIG switch (SCBR/PROV) to the SCBR position as shown in Figure 7.

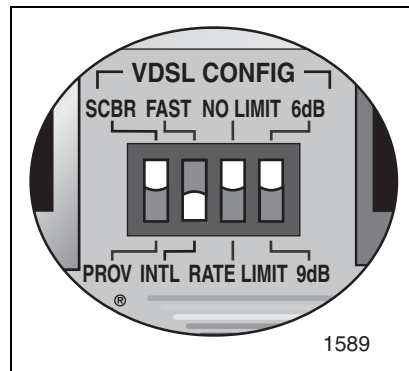

Figure 7. Configuring AT-MC605 Ethernet Extender for Subscriber Mode

5. Go to “Cabling the Subscriber Unit” on page 36 to connect the cables and to “Powering On the Subscriber Unit” on page 38 for powering the unit.

Wall-Mounting the Subscriber Unit

The AT-MC605 VDSL Ethernet Extender may be wall mounted directly to the wall with an AT-WLMT Wall Mount Bracket or by using an Allied Telesis DINRAIL Bracket (both supplied separately) in conjunction with a previously mounted DINRAIL.

1. Configure the right VDSL CONFIG switch (SCBR/PROV) to the SCBR position as shown in Figure 7, “Configuring AT-MC605 Ethernet Extender for Subscriber Mode” on page 35.
2. Follow the installation instructions supplied with the wall mounting bracket.
3. Go to “Cabling the Subscriber Unit” on page 36 to connect the cables and to “Powering On the Subscriber Unit” on page 38 for powering the unit.

Cabling the Subscriber Unit

To cable the Subscriber unit to a computer or telephone, perform the following steps:

1. To connect a computer to the AT-MC605 Ethernet Extender, connect the ethernet cable from the AT-MC605 ethernet port to the ethernet port on your computer, as shown in Figure 8 , “Connecting AT-MC605 Ethernet Port to Computer”.

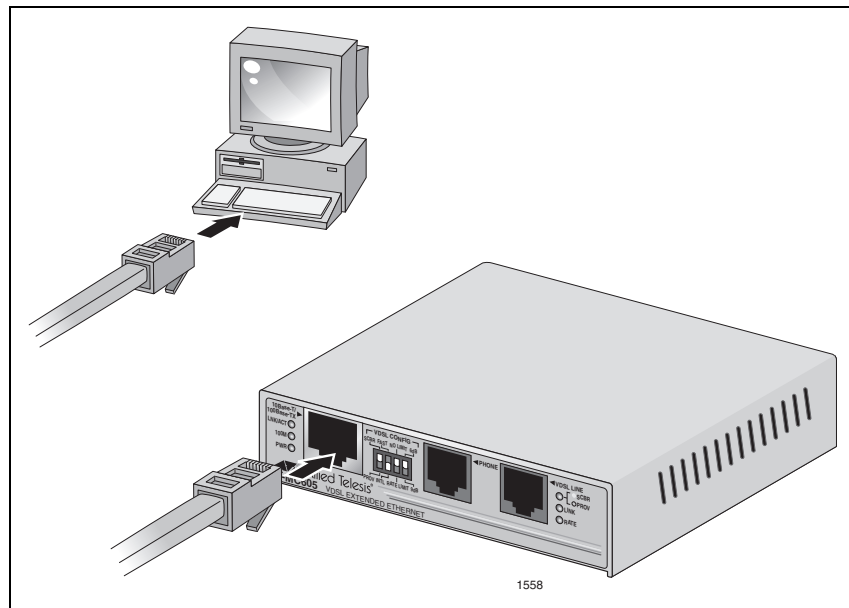

Figure 8. Connecting AT-MC605 Ethernet Port to Computer

2. To connect a telephone to the AT-MC605 Ethernet Extender, connect a telephone line cable from the Phone port to the telephone, as shown in Figure 9.

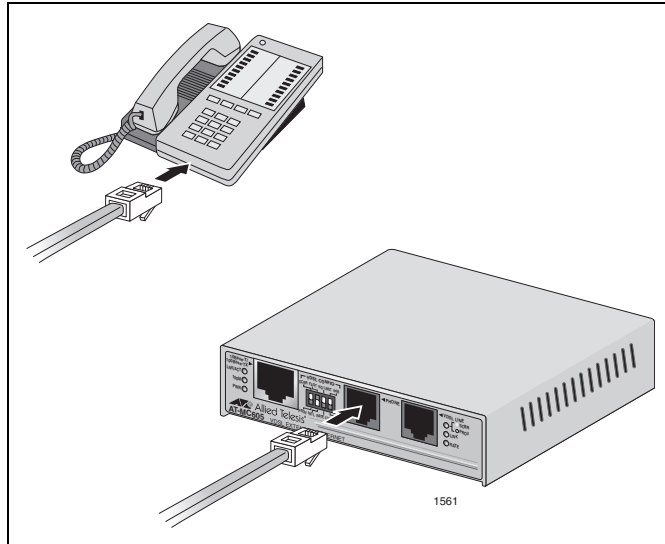

Figure 9. Connecting AT-MC605 Phone Port to Telephone

3. Next, connect a telephone line cable from the VDSL Line port to the wall/interior telephone line, as shown in Figure 10, so that the Subscriber unit can communicate with the Provider unit.

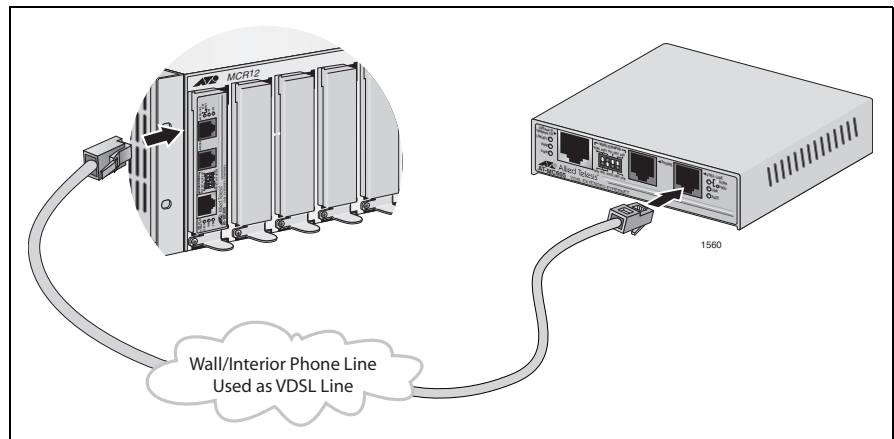

Figure 10. VDSL Line to Wall/Interior Phone Line

Powering On the Subscriber Unit

Power on the Subscriber unit using the power adapter provided, as shown in Figure 11.

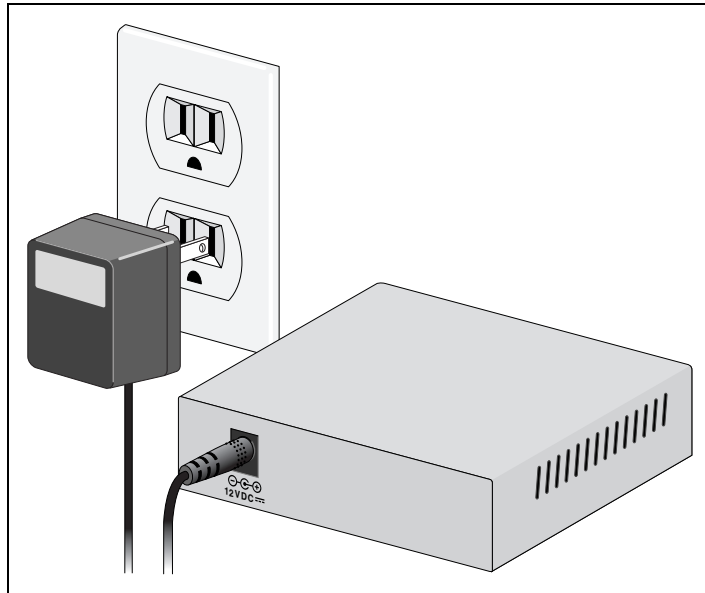

Figure 11. Power On The Subscriber Unit

Installing the AT-MC605 Ethernet Extender Provider Unit

The AT-MC605 Provider unit can either be installed in an AT-MCR12 rackmount chassis, or used as a desktop device, or mounted onto a wall.



Warning

To prevent exposure to electric shock, the AT-MC605 Provider Unit must be installed in a **RESTRICTED ACCESS LOCATION** and performed by **QUALIFIED SERVICE PERSONNEL**.

Note

For Finland, Norway, and Sweden – When the AT-MC605 Ethernet Extender and the AT-MCR12 rackmount chassis are used, a permanent ground conductor must be installed on the AT-MCR12 rackmount chassis. For installation instructions of this ground conductor, the *AT-MCR12 Media Converter Rackmount Chassis Installation Manual* is available in portable document format (PDF) on our web site at www.alliedtelesis.com.

Using the Provider Unit on a Desktop

To use the Provider unit on a desktop, perform the following procedure:

1. Remove all equipment from the package and store the packaging material in a safe place.
2. Attach the four protective feet (provided) to each corner of the bottom of the unit, as illustrated in Figure 12.

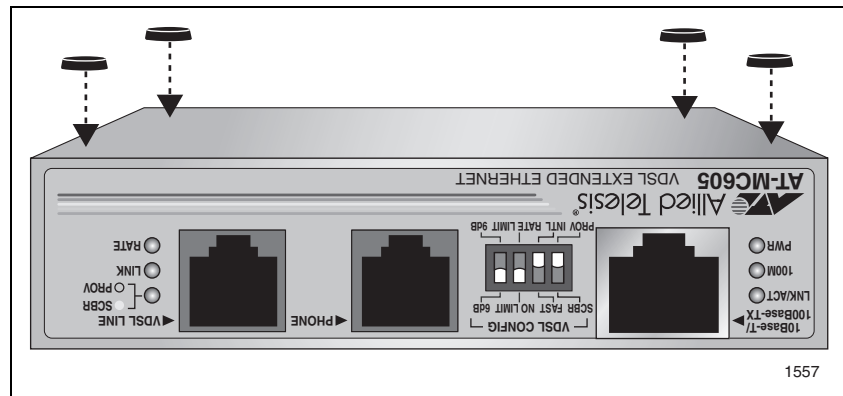

Figure 12. Attaching Protective Feet to the Provider Unit

3. Configure the right VDSL CONFIG switch (SCBR/PROV) to the SCBR position as shown in Figure 13.

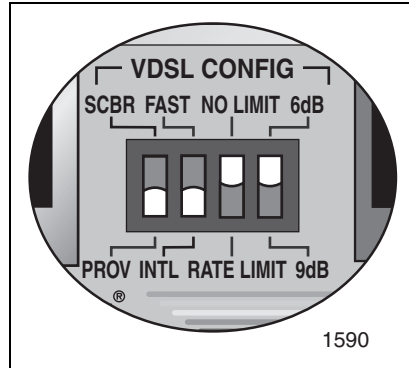

Figure 13. Configuring AT-MC605 Ethernet Extender for Provider Mode

4. Go to “Cabling the Provider Unit” on page 42 to connect the cables and to “Powering On the Provider Unit” on page 44 for powering the unit.

Wall-Mounting the Provider Unit

The AT-MC605 VDSL Ethernet Extender may be wall mounted directly to the wall with an AT-WLMT Wall Mount Bracket or by using an Allied Telesis DINRAIL Bracket in conjunction with a previously mounted DINRAIL. Both of these brackets may be ordered separately from the AT-MC605. Please contact your local Allied Telesis representative.

1. Configure the right VDSL CONFIG switch (SCBR/PROV) to the SCBR position as shown in Figure 13.
2. Follow the installation instructions supplied with the wall mounting bracket or DINRAIL bracket.
3. To connect the cables, see “Cabling the Provider Unit” on page 42.
4. To apply power to the unit, see “Powering On the Provider Unit” on page 44.

Rack-Mounting the Provider Unit

To install the Provider unit in an AT-MCR12 rackmount chassis, perform the following steps:

1. Configure the right VDSL CONFIG switch (SCBR/PROV) to the SCBR position as shown in Figure 14 , "Configuring AT-MC605 Ethernet Extender for Provider Mode".

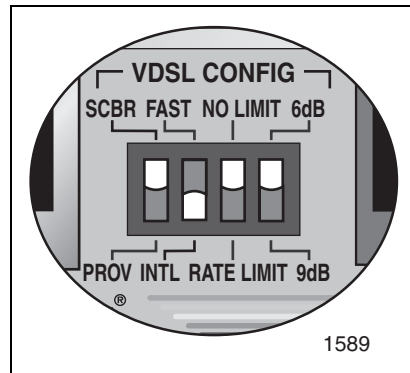

Figure 14. Configuring AT-MC605 Ethernet Extender for Provider Mode

2. Attach the unit to one of the sliders that holds the unit in the chassis, as shown in Figure 15.

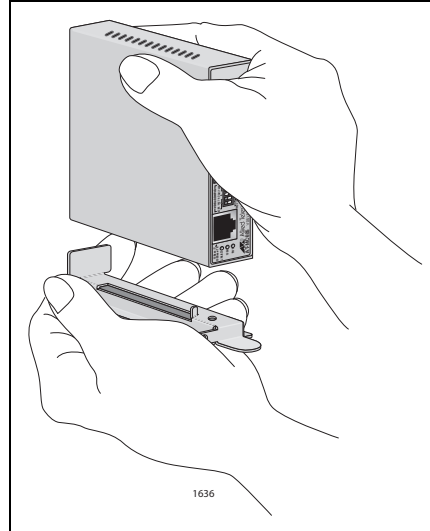

Figure 15. Rack Mount - Set on Slider

3. Position the slider, as shown in Figure 16 and push into the chassis.

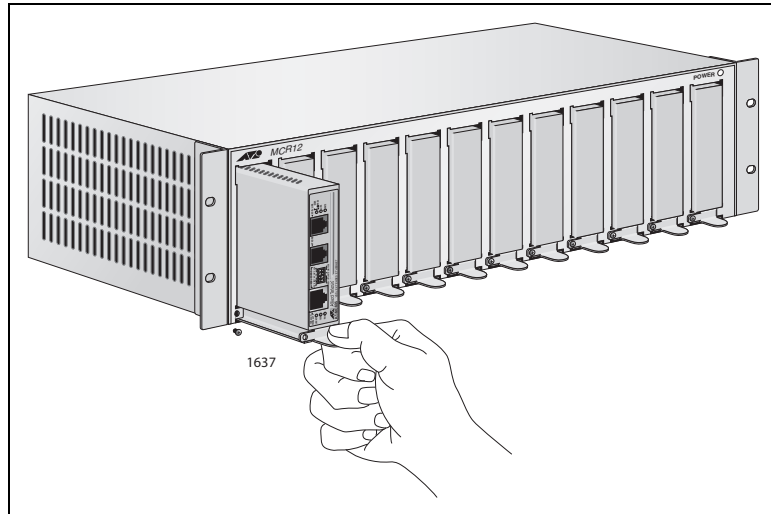

Figure 16. Rack Mount - Set in Rack

4. To connect the cables, see “Cabling the Provider Unit” on page 42.

Cabling the Provider Unit

To cable the Provider unit, perform the following steps:

1. Connect the ethernet cable from the ethernet port to the Service Provider box (ISP) in your wiring closet, as shown in Figure 17.

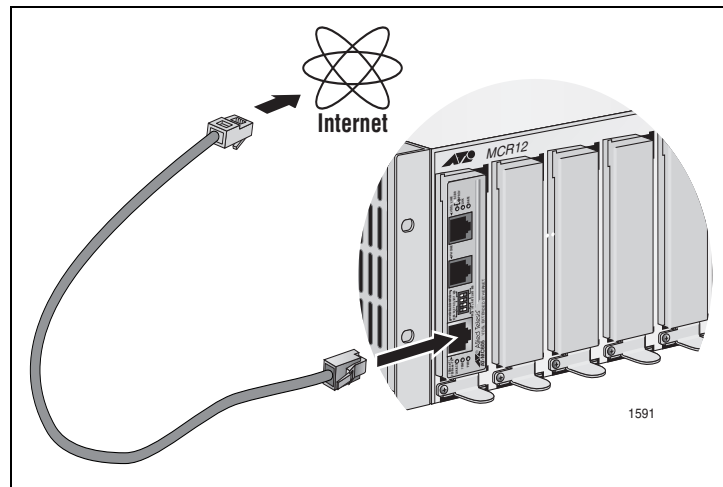

Figure 17. Connecting AT-MC605 Ethernet Port to an Internet Service Provider

2. Connect a telephone line cable from the Phone port to the building PBX connection as shown in Figure 18.

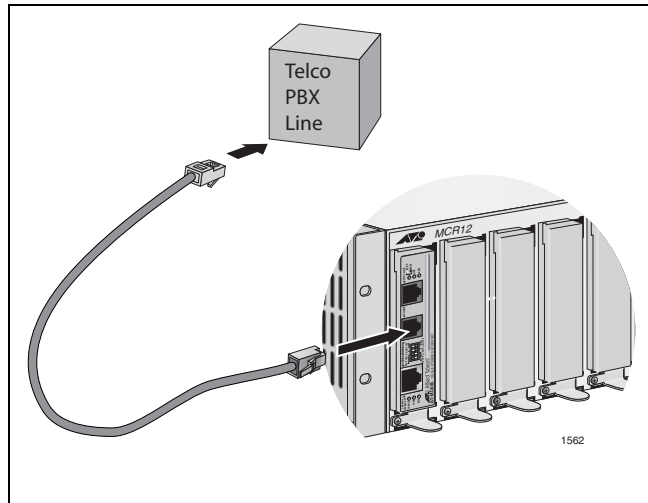

Figure 18. Connecting AT-MC605 Phone Port to PBX Connection

3. Connect a telephone line cable from the VDSL Line port to the wall/interior telephone line, as shown in Figure 19, so that the Provider unit can communicate with the Subscriber unit.

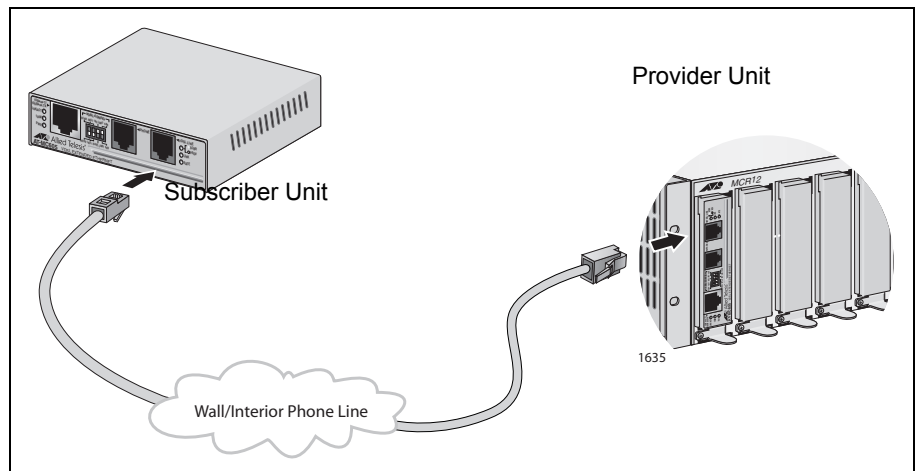

Figure 19. VDSL Line to Wall/Interior Phone Line.

Powering On the Provider Unit

If you have rack mounted the AT-MC605 Provider unit, the host equipment, AT-MCR12 rackmount chassis, is must be powered on as well.



Warning

The **QUALIFIED SERVICE PERSONNEL** must verify that the AT-MCR12 rackmount chassis power cord is connected to the socket provided with the ground conductor.

If the power cord is not connected, the **QUALIFIED SERVICE PERSONNEL** must install a permanent ground connection using the bond stud on the rear panel of the AT-MCR12 rackmount chassis.

For detailed information on how to power on the AT-MCR12 rackmount chassis, refer to the *AT-MCR12 Media Converter Rackmount Chassis Installation Manual*.

If you have installed a stand alone AT-MC605 Provider unit, power on the unit using the power adapter provided, as shown in Figure 20.

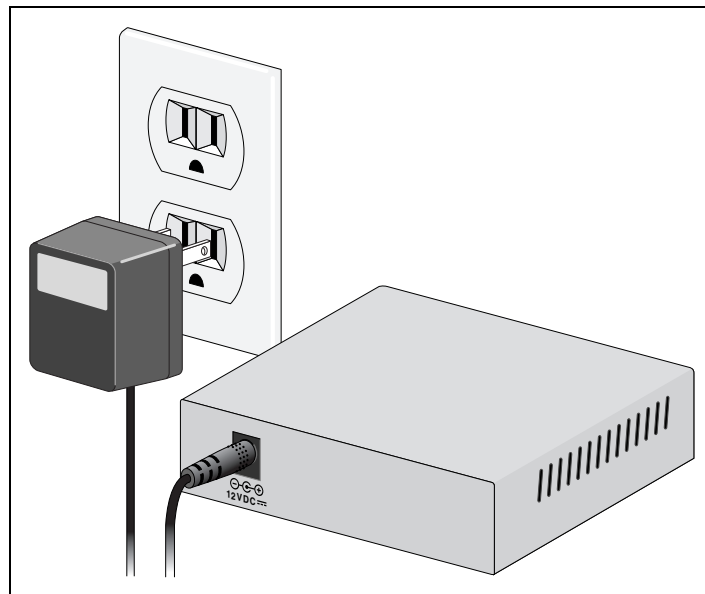

Figure 20. Power On The Subscriber Unit

Chapter 3

Troubleshooting

This chapter contains information on how to troubleshoot the AT-MC605 VDSL Ethernet Extender in the event a problem occurs.

Note

If after following the instructions in this chapter you are unable to resolve the problem, contact Allied Telesis Technical Support for assistance. Refer to “Contacting Allied Telesis” on page 14 for information on how to contact our Technical Support Department.

LEDs Check the PWR LED on the front of the AT-MC605 Ethernet Extender. If the LED is OFF, indicating that the AT-MC605 Ethernet Extender is not receiving power, do the following:

- ❑ If the AT-MC605 Ethernet Extender is inserted in the AT-MCR12 rackmount chassis, make sure that the power cord is securely connected to the power source and to the power connector on the back panel of the AT-MCR12 rackmount chassis.
- ❑ If the AT-MC605 Ethernet Extender is in a stand-alone configuration, make sure that the AC/DC power adapter is securely connected to both the power source and the DC power connector on the back panel of the AT-MC605 Ethernet Extender.
- ❑ Verify that the AC power outlet has power by connecting another device to it.
- ❑ Try connecting the AT-MC605 Ethernet Extender to another AC power source.
- ❑ Try using a different power cord or a different AC/DC power adapter.
- ❑ Check that the voltage from the power source is within the required levels for your region.

Verify that the ACT LED for each twisted pair port is ON. If a ACT LED is

OFF, do the following:

- ❑ Verify that the end node connected to the port is powered ON and is operating properly.
- ❑ Check that the twisted pair cable is securely connected to the port on the AT-MC605 Ethernet Extender and to the port on the end node.
- ❑ Make sure that the twisted pair cable does not exceed 100 meters (328 feet).
- ❑ Verify that you are using the appropriate category of twisted pair cable: Category 3 or better for 10 Mbps operation, Category 5 and Category 5E for 100 Mbps operation.
- ❑ Make sure that the operating parameters of the port on the AT-MC605 Ethernet Extender are compatible with the end node to which the port is connected.

Appendix A

Technical Specifications

Physical Specifications

Dimensions:	(W x D x H) 109 mm x 95 mm x 25 mm (4.29 in. x 3.74 in. x 0.98 in.)
Weight:	.3 kg (0.66 lbs)
Recommended Minimum Clearance on All Sides:	5.08 cm (2.0 in.)

Environmental Specifications

Operating Temperature:	0° C to 40° C
Storage Temperature:	-25° C to 70° C
Operating Humidity:	5% to 90% (noncondensing)
Storage Humidity:	5% to 95% (noncondensing)
Operating Altitude:	3,000 m
Non-operating Altitude:	4,000 m

Power Specifications

Power Consumption:	4 Watts
Input Supply Current:	350 mA
Input Supply Voltage:	12V DC

Safety and Electromagnetic Compatibility Certifications

Emission:	EN55022 Class B, FCC Part 15 Class B
Immunity:	EN55024
Safety:	EN60950, UL60950