

AR4050S

UNIFIED THREAT MANAGEMENT FIREWALL

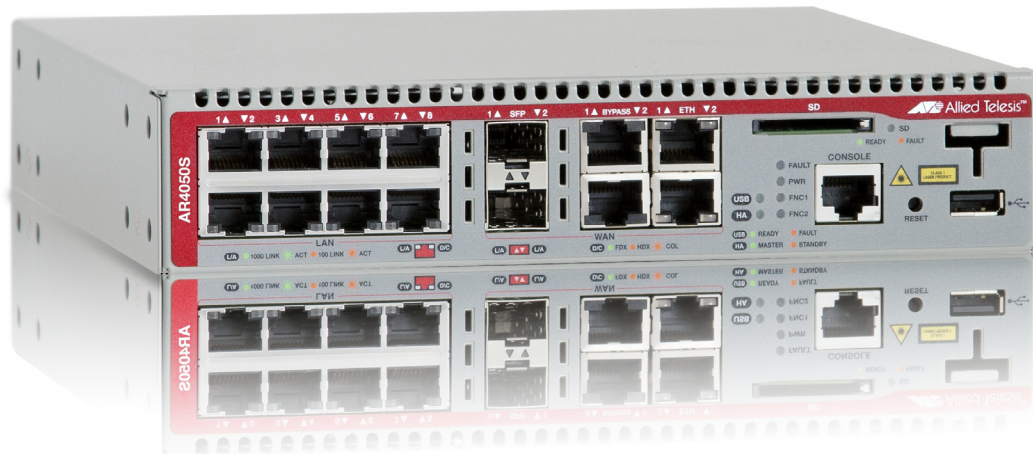

Command Reference for AlliedWare Plus™ Version 5.4.7-1.x

Acknowledgments

This product includes software developed by the University of California, Berkeley and its contributors.

Copyright ©1982, 1986, 1990, 1991, 1993 The Regents of the University of California.

All rights reserved.

This product includes software developed by the OpenSSL Project for use in the OpenSSL Toolkit. For information about this see www.openssl.org/

Copyright ©1998-2008 The OpenSSL Project. All rights reserved.

This product includes software licensed under v2 and v3 of the GNU General Public License, available from: www.gnu.org/licenses/gpl2.html and www.gnu.org/licenses/gpl.html respectively.

Source code for all GPL licensed software in this product can be obtained from the Allied Telesys GPL Code Download Center at: www.alliedtelesys.com/support/

Allied Telesys is committed to meeting the requirements of the open source licenses including the GNU General Public License (GPL) and will make all required source code available.

If you would like a copy of the GPL source code contained in Allied Telesys products, please send us a request by registered mail including a check for US\$15 to cover production and shipping costs and a CD with the GPL code will be mailed to you.

GPL Code Request
Allied Telesys Labs (Ltd)
PO Box 8011
Christchurch
New Zealand

Allied Telesys, AlliedWare Plus, Allied Telesys Management Framework, EPSRing, SwitchBlade, VCStack, and VCStack Plus are trademarks or registered trademarks in the United States and elsewhere of Allied Telesys, Inc.

Microsoft and Internet Explorer are registered trademarks of Microsoft Corporation. All other product names, company names, logos or other designations mentioned herein may be trademarks or registered trademarks of their respective owners.

© 2017 Allied Telesys, Inc.

All rights reserved. No part of this publication may be reproduced without prior written permission from Allied Telesys, Inc.

Allied Telesys, Inc. reserves the right to make changes in specifications and other information contained in this document without prior written notice. The information provided herein is subject to change without notice. In no event shall Allied Telesys, Inc. be liable for any incidental, special, indirect, or consequential damages whatsoever, including but not limited to lost profits, arising out of or related to this manual or the information contained herein, even if Allied Telesys, Inc. has been advised of, known, or should have known, the possibility of such damages.

Contents

PART 1:	Setup and Troubleshooting	98
Chapter 1:	CLI Navigation Commands	99
	Introduction	99
	configure terminal	100
	disable (Privileged Exec mode)	101
	do	102
	enable (Privileged Exec mode)	103
	end	105
	exit	106
	help	107
	logout	108
	show history	109
Chapter 2:	File and Configuration Management Commands	110
	Introduction	110
	autoboot enable	114
	boot config-file	115
	boot config-file backup	117
	boot system	118
	boot system backup	119
	cd	120
	copy (filename)	121
	copy current-software	123
	copy debug	124
	copy running-config	125
	copy startup-config	126
	copy zmodem	127
	create autoboot	128
	delete	129
	delete debug	130
	dir	131
	edit	133
	edit (filename)	134

erase factory-default	135
erase startup-config	136
ip tftp source-interface	137
ipv6 tftp source-interface	138
mkdir	139
move	140
move debug	141
pwd	142
rmdir	143
show autoboot	144
show boot	145
show file	147
show file systems	148
show running-config	150
show running-config interface	154
show startup-config	156
show version	157
unmount	162
write file	163
write memory	164
write terminal	165

Chapter 3: User Access Commands 166

Introduction	166
clear line console	168
clear line vty	169
enable password	170
enable secret	173
exec-timeout	176
flowcontrol hardware (asyn/console)	178
length (asyn)	180
line	181
privilege level	183
security-password history	184
security-password forced-change	185
security-password lifetime	186
security-password min-lifetime-enforce	187
security-password minimum-categories	188
security-password minimum-length	189
security-password reject-expired-pwd	190
security-password warning	191
service advanced-vty	192
service password-encryption	193
service telnet	194
service terminal-length (deleted)	195
show privilege	196
show security-password configuration	197
show security-password user	198
show telnet	199
show users	200
telnet	201
telnet server	202
terminal length	203

	terminal resize	204
	username	205
Chapter 4:	Subscription Licensing Commands	207
	Introduction	207
	license update (filename)	208
	license update online	209
	show license external	211
Chapter 5:	GUI Commands	212
	Introduction	212
	atmf topology-gui enable	213
	http secure-port	214
	log event-host	215
	service http	216
	show http	217
	update webgui now	218
Chapter 6:	Update Manager Commands	219
	Introduction	219
	show resource	220
	update now	222
	update webgui now	223
Chapter 7:	System Configuration and Monitoring Commands	224
	Introduction	224
	banner exec	226
	banner login (system)	228
	banner motd	230
	clock set	232
	clock summer-time date	233
	clock summer-time recurring	235
	clock timezone	237
	hostname	238
	max-fib-routes	240
	max-static-routes	242
	no debug all	243
	reboot	245
	reload	246
	show clock	247
	show cpu	249
	show cpu history	252
	show debugging	254
	show interface memory	255
	show memory	257
	show memory allocations	259
	show memory history	261
	show memory pools	262
	show memory shared	263
	show process	264
	show reboot history	266
	show router-id	267

show system	268
show system environment	269
show system interrupts	270
show system mac	271
show system pci device	272
show system pci tree	273
show system serialnumber	274
show tech-support	275
speed (asyn)	277
terminal monitor	279
undebg all	280

Chapter 8: Pluggables and Cabling Commands 281

Introduction	281
debug fiber-monitoring	282
fiber-monitoring action	284
fiber-monitoring baseline	285
fiber-monitoring enable	287
fiber-monitoring interval	288
fiber-monitoring sensitivity	289
show system fiber-monitoring	291
show system pluggable	294
show system pluggable detail	296
show system pluggable diagnostics	299

Chapter 9: Logging Commands 301

Introduction	301
clear exception log	304
clear log	305
clear log buffered	306
clear log external	307
clear log permanent	308
connection-log events	309
copy buffered-log	310
copy permanent-log	311
default log buffered	312
default log console	313
default log email	314
default log external	315
default log host	316
default log monitor	317
default log permanent	318
log buffered	319
log buffered (filter)	320
log buffered exclude	323
log buffered size	326
log console	327
log console (filter)	328
log console exclude	331
log date-format	334
log email	335
log email (filter)	336

log email exclude	339
log email time	342
log external	344
log external (filter)	346
log external exclude	349
log external rotate	352
log external size	354
log facility	355
log host	357
log host (filter)	359
log host exclude	362
log host source	365
log host time	366
log monitor (filter)	368
log monitor exclude	371
log permanent	374
log permanent (filter)	375
log permanent exclude	378
log permanent size	381
log-rate-limit nsm	382
log trustpoint	384
log url-requests	385
show connection-log events	386
show counter log	387
show exception log	388
show log	389
show log config	391
show log external	393
show log permanent	394
show running-config log	395
unmount	396

Chapter 10:	Scripting Commands	397
	Introduction	397
	activate	398
	echo	399
	wait	400

Chapter 11:	Interface Commands	401
	Introduction	401
	description (interface)	402
	interface (to configure)	403
	ip tcp adjust-mss	405
	ipv6 tcp adjust-mss	407
	mru jumbo	409
	mtu	410
	show interface	412
	show interface brief	416
	show interface memory	417
	show interface status	419
	shutdown	421

Chapter 12:	USB Cellular Modem Commands	422
	Introduction	422
	apn	423
	chat-script	425
	encapsulation ppp	426
	show cellular	428
	show system usb	431
	usb mode-switch	433
Chapter 13:	Port Mirroring Commands	435
	Introduction	435
	mirror interface	436
	show mirror	438
	show mirror interface	439
Chapter 14:	Interface Testing Commands	440
	Introduction	440
	clear test interface	441
	service test	442
	test interface	443
PART 2:	Interfaces and Layer 2	445
Chapter 15:	Switching Commands	446
	Introduction	446
	backpressure	448
	clear mac address-table dynamic	450
	clear mac address-table static	452
	clear port counter	453
	debug platform packet	454
	duplex	456
	flowcontrol (switch port)	457
	linkflap action	459
	mac address-table acquire	460
	mac address-table ageing-time	461
	mac address-table static	462
	polarity	463
	show debugging platform packet	464
	show flowcontrol interface	465
	show interface err-disabled	466
	show interface switchport	467
	show mac address-table	468
	show platform	470
	show platform port	471
	show storm-control	476
	speed	477
	storm-control level	479
	undebug platform packet	480
Chapter 16:	Bridging Commands	481
	Introduction	481

	ageing-time	482
	bridge	483
	bridge-group	484
	clear mac-filter	485
	l3-filtering enable	486
	mac-filter	487
	mac-filter-group	488
	mac-learning	489
	rule (MAC Filter)	490
	show bridge	492
	show bridge macaddr	494
	show mac-filter	495
Chapter 17:	VLAN Commands	496
	Introduction	496
	show vlan	497
	switchport access vlan	498
	switchport mode access	499
	switchport mode trunk	500
	switchport trunk allowed vlan	501
	switchport trunk native vlan	504
	vlan	505
	vlan database	506
Chapter 18:	Spanning Tree Commands	507
	Introduction	507
	clear spanning-tree statistics	509
	clear spanning-tree detected protocols (RSTP and MSTP)	510
	debug mstp (RSTP and STP)	511
	instance priority (MSTP)	515
	instance vlan (MSTP)	517
	region (MSTP)	519
	revision (MSTP)	520
	show debugging mstp	521
	show spanning-tree	522
	show spanning-tree brief	525
	show spanning-tree mst	526
	show spanning-tree mst config	527
	show spanning-tree mst detail	528
	show spanning-tree mst detail interface	530
	show spanning-tree mst instance	532
	show spanning-tree mst instance interface	533
	show spanning-tree mst interface	534
	show spanning-tree mst detail interface	535
	show spanning-tree statistics	537
	show spanning-tree statistics instance	539
	show spanning-tree statistics instance interface	540
	show spanning-tree statistics interface	542
	show spanning-tree vlan range-index	544
	spanning-tree autoedge (RSTP and MSTP)	545
	spanning-tree cisco-interoperability (MSTP)	546
	spanning-tree edgeport (RSTP and MSTP)	547

spanning-tree enable	548
spanning-tree errdisable-timeout enable	550
spanning-tree errdisable-timeout interval	551
spanning-tree force-version	552
spanning-tree forward-time	553
spanning-tree guard root	554
spanning-tree hello-time	555
spanning-tree link-type	556
spanning-tree max-age	557
spanning-tree max-hops (MSTP)	558
spanning-tree mode	559
spanning-tree mst configuration	560
spanning-tree mst instance	561
spanning-tree mst instance path-cost	562
spanning-tree mst instance priority	564
spanning-tree mst instance restricted-role	565
spanning-tree mst instance restricted-tcn	567
spanning-tree path-cost	568
spanning-tree portfast (STP)	569
spanning-tree portfast bpdu-filter	571
spanning-tree portfast bpdu-guard	573
spanning-tree priority (bridge priority)	575
spanning-tree priority (port priority)	576
spanning-tree restricted-role	577
spanning-tree restricted-tcn	578
spanning-tree transmit-holdcount	579
undebg mstp	580

Chapter 19: Link Aggregation Commands 581

Introduction	581
channel-group	583
clear lacp counters	585
debug lacp	586
lacp global-passive-mode enable	587
lacp port-priority	588
lacp system-priority	589
lacp timeout	590
show debugging lacp	592
show diagnostic channel-group	593
show etherchannel	594
show etherchannel detail	595
show etherchannel summary	596
show lacp sys-id	597
show lacp-counter	598
show port etherchannel	599
show static-channel-group	600
static-channel-group	601
undebg lacp	603

Chapter 20: 802.1Q Encapsulation Commands 604

Introduction	604
encapsulation dot1q	605

Chapter 21:	PPP Commands	607
	Introduction	607
	debug ppp	609
	encapsulation ppp	612
	interface (PPP)	614
	ip address negotiated	615
	ip tcp adjust-mss	617
	ip unnumbered	619
	ipv6 tcp adjust-mss	621
	keepalive (PPP)	623
	mtu (PPP)	625
	peer default ip address	626
	peer neighbor-route	628
	ppp authentication	630
	ppp authentication refuse	632
	ppp hostname	634
	ppp ipcp dns	636
	ppp ipcp dns suffix-list	638
	ppp ipcp ip-override	640
	ppp password	641
	ppp service-name (PPPoE)	642
	ppp timeout idle	643
	ppp username	644
	show debugging ppp	645
	show interface (PPP)	646
	undebug ppp	650
Chapter 22:	PPP over Ethernet (PPPoE) Commands	651
	Introduction	651
	clear pppoe-ac statistics	652
	debug pppoe-ac	653
	destination l2tp	654
	l2tp peer-address dns-lookup	655
	l2tp peer-address radius-lookup group	657
	l2tp peer-address static	658
	l2tp profile	660
	ppp-auth-protocol	662
	pppoe-ac	663
	pppoe-ac-service	664
	proxy-auth	665
	service-name	666
	show debugging pppoe ac	668
	show pppoe-ac config-check	669
	show pppoe-ac connections	671
	show pppoe-ac statistics	673
	show running-config pppoe-ac	676
PART 3:	Routing	677
Chapter 23:	IP Addressing and Protocol Commands	678
	Introduction	678
	arp-aging-timeout	680

arp (IP address MAC)	681
arp log	683
arp opportunistic-nd	686
arp-reply-bc-dmac	688
clear arp-cache	689
debug ip packet interface	691
ip address (IP Addressing and Protocol)	693
ip directed-broadcast	695
ip forward-protocol udp	697
ip gratuitous-arp-link	699
ip helper-address	701
ip limited-local-proxy-arp	703
ip local-proxy-arp	705
ip proxy-arp	706
ip redirects	707
ip tcp synack-retries	708
ip tcp timeout established	709
ip unreachable	710
local-proxy-arp	712
optimistic-nd	713
ping	714
show arp	716
show debugging ip packet	719
show ip forwarding	721
show ip interface	722
show ip interface vrf	723
show ip sockets	725
show ip traffic	728
tcpdump	730
traceroute	731
undebug ip packet interface	732

Chapter 24:	Domain Name Service (DNS) Commands	733
	Introduction	733
	clear ip dns forwarding cache	735
	ddns enable	736
	ddns-update-method	737
	ddns-update now	738
	debug ddns	739
	debug ip dns forwarding	740
	description (Domain List)	741
	domain (Domain List)	742
	host-name (DDNS)	743
	ip ddns-update-method	744
	ip dns forwarding	745
	ip dns forwarding cache	746
	ip dns forwarding dead-time	747
	ip dns forwarding domain-list	748
	ip dns forwarding retry	749
	ip dns forwarding source-interface	750
	ip dns forwarding timeout	751
	ip domain-list	752
	ip domain-lookup	753

ip domain-name	754
ip name-server	755
ipv6 ddns-update-method	757
password (DDNS)	758
ppp ipcp dns	759
ppp ipcp dns suffix-list	761
retry-interval (DDNS)	763
show ddns-update-method status	764
show debugging ip dns forwarding	765
show hosts	766
show ip dns forwarding	767
show ip dns forwarding cache	768
show ip dns forwarding server	770
show ip domain-list	772
show ip domain-name	773
show ip name-server	774
suppress-ipv4-updates (DDNS)	776
undebug (DDNS)	777
update-interval (DDNS)	778
update-url (DDNS)	779
use-ipv4-for-ipv6-updates (DDNS)	782
username (DDNS)	783

Chapter 25: IPv6 Commands 784

Introduction	784
clear ipv6 neighbors	786
ipv6 address	787
ipv6 address autoconfig	789
ipv6 enable	791
ipv6 eui64-linklocal	793
ipv6 forwarding	794
ipv6 multicast forward-slow-path-packet	795
ipv6 nd accept-ra-pinfo	796
ipv6 nd current-hoplimit	797
ipv6 nd managed-config-flag	799
ipv6 nd minimum-ra-interval	800
ipv6 nd other-config-flag	802
ipv6 nd prefix	803
ipv6 nd ra-interval	805
ipv6 nd ra-lifetime	806
ipv6 nd reachable-time	807
ipv6 nd retransmission-time	809
ipv6 nd suppress-ra	811
ipv6 neighbor	812
ipv6 opportunistic-nd	813
ipv6 route	814
ipv6 unreachable	815
ping ipv6	816
show ipv6 forwarding	817
show ipv6 interface brief	818
show ipv6 neighbors	819
show ipv6 route	820
show ipv6 route summary	822

	traceroute ipv6	823
Chapter 26:	Routing Commands	824
	Introduction	824
	ip route	825
	ipv6 route	828
	max-fib-routes	829
	max-static-routes	831
	maximum-paths	832
	show ip route	833
	show ip route database	836
	show ip route summary	839
	show ipv6 route	841
	show ipv6 route summary	843
Chapter 27:	RIP Commands	844
	Introduction	844
	accept-lifetime	846
	address-family ipv4 (RIP)	848
	alliedware-behavior	849
	cisco-metric-behavior (RIP)	851
	clear ip rip route	852
	debug rip	854
	default-information originate (RIP)	855
	default-metric (RIP)	856
	distance (RIP)	857
	distribute-list (RIP)	858
	fullupdate (RIP)	859
	ip rip authentication key-chain	860
	ip rip authentication mode	862
	ip rip authentication string	865
	ip rip receive-packet	867
	ip rip receive version	868
	ip rip send-packet	869
	ip rip send version	870
	ip rip send version 1-compatible	873
	ip rip split-horizon	875
	key	876
	key chain	877
	key-string	878
	maximum-prefix	879
	neighbor (RIP)	880
	network (RIP)	881
	passive-interface (RIP)	883
	rcv-buffer-size (RIP)	884
	redistribute (RIP)	885
	restart ip graceful	887
	rip restart grace-period	888
	route (RIP)	889
	router rip	890
	send-lifetime	891
	show debugging rip	893

show ip protocols rip	894
show ip rip	895
show ip rip database	896
show ip rip interface	897
show ip rip vrf database	898
show ip rip vrf interface	899
timers (RIP)	900
undebug rip	902
version (RIP)	903

Chapter 28: RIPng for IPv6 Commands 905

Introduction	905
aggregate-address (IPv6 RIPng)	907
clear ipv6 rip route	908
debug ipv6 rip	909
default-information originate (IPv6 RIPng)	910
default-metric (IPv6 RIPng)	911
distribute-list (IPv6 RIPng)	912
ipv6 rip metric-offset	913
ipv6 rip split-horizon	915
ipv6 router rip	917
neighbor (IPv6 RIPng)	918
passive-interface (IPv6 RIPng)	919
recv-buffer-size (IPv6 RIPng)	920
redistribute (IPv6 RIPng)	921
route (IPv6 RIPng)	922
router ipv6 rip	923
show debugging ipv6 rip	924
show ipv6 protocols rip	925
show ipv6 rip	926
show ipv6 rip database	927
show ipv6 rip interface	928
timers (IPv6 RIPng)	929
undebug ipv6 rip	930

Chapter 29: OSPF Commands 931

Introduction	931
area default-cost	934
area authentication	935
area filter-list	936
area nssa	937
area range	939
area stub	941
area virtual-link	942
auto-cost reference bandwidth	945
bandwidth	947
capability opaque	948
capability restart	949
clear ip ospf process	950
compatible rfc1583	951
debug ospf events	952
debug ospf ifsm	953

debug ospf lsa	954
debug ospf nfsm	955
debug ospf nsm	956
debug ospf packet	957
debug ospf route	958
default-information originate	959
default-metric (OSPF)	960
distance (OSPF)	961
enable db-summary-opt	963
host area	964
ip ospf authentication	965
ip ospf authentication-key	966
ip ospf cost	968
ip ospf database-filter	969
ip ospf dead-interval	970
ip ospf disable all	971
ip ospf hello-interval	972
ip ospf message-digest-key	973
ip ospf mtu	975
ip ospf mtu-ignore	976
ip ospf network	977
ip ospf priority	978
ip ospf resync-timeout	979
ip ospf retransmit-interval	980
ip ospf transmit-delay	981
max-concurrent-dd	982
maximum-area	983
neighbor (OSPF)	984
network area	985
ospf abr-type	987
ospf restart grace-period	988
ospf restart helper	989
ospf router-id	991
overflow database	992
overflow database external	993
passive-interface (OSPF)	994
redistribute (OSPF)	995
restart ospf graceful	997
router ospf	998
router-id	1000
show debugging ospf	1001
show ip ospf	1002
show ip ospf border-routers	1005
show ip ospf database	1006
show ip ospf database asbr-summary	1008
show ip ospf database external	1009
show ip ospf database network	1011
show ip ospf database nssa-external	1012
show ip ospf database opaque-area	1014
show ip ospf database opaque-as	1015
show ip ospf database opaque-link	1016
show ip ospf database router	1017
show ip ospf database summary	1019

show ip ospf interface	1022
show ip ospf neighbor	1023
show ip ospf route	1025
show ip ospf virtual-links	1026
show ip protocols ospf	1027
summary-address	1028
timers spf exp	1029
undebug ospf events	1030
undebug ospf ifsm	1031
undebug ospf lsa	1032
undebug ospf n fsm	1033
undebug ospf nsm	1034
undebug ospf packet	1035
undebug ospf route	1036

Chapter 30: OSPFv3 for IPv6 Commands 1037

Introduction	1037
abr-type	1040
area authentication ipsec spi	1041
area default-cost (IPv6 OSPF)	1043
area encryption ipsec spi esp	1044
area range (IPv6 OSPF)	1047
area stub (IPv6 OSPF)	1049
area virtual-link (IPv6 OSPF)	1050
area virtual-link authentication ipsec spi	1052
area virtual-link encryption ipsec spi	1054
auto-cost reference bandwidth (IPv6 OSPF)	1057
bandwidth	1059
clear ipv6 ospf process	1060
debug ipv6 ospf events	1061
debug ipv6 ospf ifsm	1062
debug ipv6 ospf lsa	1063
debug ipv6 ospf n fsm	1064
debug ipv6 ospf packet	1065
debug ipv6 ospf route	1066
default-information originate	1067
default-metric (IPv6 OSPF)	1068
distance (IPv6 OSPF)	1069
ipv6 ospf authentication spi	1071
ipv6 ospf cost	1073
ipv6 ospf dead-interval	1075
ipv6 ospf display route single-line	1076
ipv6 ospf encryption spi esp	1077
ipv6 ospf hello-interval	1080
ipv6 ospf neighbor	1081
ipv6 ospf network	1083
ipv6 ospf priority	1084
ipv6 ospf retransmit-interval	1085
ipv6 ospf transmit-delay	1086
ipv6 router ospf area	1087
max-concurrent-dd (IPv6 OSPF)	1089
passive-interface (IPv6 OSPF)	1090
redistribute (IPv6 OSPF)	1091

restart ipv6 ospf graceful	1093
router ipv6 ospf	1094
router-id (IPv6 OSPF)	1095
show debugging ipv6 ospf	1096
show ipv6 ospf	1097
show ipv6 ospf database	1099
show ipv6 ospf database external	1101
show ipv6 ospf database grace	1102
show ipv6 ospf database inter-prefix	1103
show ipv6 ospf database inter-router	1104
show ipv6 ospf database intra-prefix	1105
show ipv6 ospf database link	1106
show ipv6 ospf database network	1107
show ipv6 ospf database router	1109
show ipv6 ospf interface	1114
show ipv6 ospf neighbor	1116
show ipv6 ospf route	1118
show ipv6 ospf virtual-links	1120
summary-address (IPv6 OSPF)	1121
timers spf (IPv6 OSPF) (deprecated)	1123
timers spf exp (IPv6 OSPF)	1124
undebg ipv6 ospf events	1125
undebg ipv6 ospf ifsm	1126
undebg ipv6 ospf lsa	1127
undebg ipv6 ospf nfsm	1128
undebg ipv6 ospf packet	1129
undebg ipv6 ospf route	1130

Chapter 31:	BGP and BGP4+ Commands	1131
	Introduction	1131
	address-family	1137
	aggregate-address	1139
	auto-summary (BGP only)	1142
	bgp aggregate-nexthop-check	1143
	bgp always-compare-med	1144
	bgp bestpath as-path ignore	1145
	bgp bestpath compare-confed-aspath	1146
	bgp bestpath compare-routerid	1147
	bgp bestpath med	1148
	bgp bestpath med remove-recv-med	1150
	bgp bestpath med remove-send-med	1151
	bgp client-to-client reflection	1152
	bgp cluster-id	1153
	bgp confederation identifier	1155
	bgp confederation peers	1156
	bgp config-type	1158
	bgp dampening	1160
	bgp damp-peer-oscillation (BGP only)	1162
	bgp default ipv4-unicast	1163
	bgp default local-preference (BGP only)	1164
	bgp deterministic-med	1165
	bgp enforce-first-as	1167
	bgp fast-external-failover	1168

bgp graceful-restart	1169
bgp graceful-restart graceful-reset	1171
bgp log-neighbor-changes	1172
bgp memory maxallocation	1174
bgp nexthop-trigger-count	1175
bgp nexthop-trigger delay	1176
bgp nexthop-trigger enable	1177
bgp rfc1771-path-select (BGP only)	1178
bgp rfc1771-strict (BGP only)	1179
bgp router-id	1180
bgp scan-time (BGP only)	1181
bgp update-delay	1182
clear bgp *	1183
clear bgp (IPv4 or IPv6 address)	1184
clear bgp (ASN)	1186
clear bgp external	1187
clear bgp peer-group	1188
clear ip bgp * (BGP only)	1189
clear ip bgp (IPv4) (BGP only)	1191
clear ip bgp dampening (BGP only)	1192
clear ip bgp flap-statistics (BGP only)	1193
clear ip bgp (ASN) (BGP only)	1194
clear ip bgp external (BGP only)	1195
clear ip bgp peer-group (BGP only)	1196
clear bgp ipv6 (ipv6 address) (BGP4+ only)	1197
clear bgp ipv6 dampening (BGP4+ only)	1198
clear bgp ipv6 flap-statistics (BGP4+ only)	1199
clear bgp ipv6 (ASN) (BGP4+ only)	1200
clear bgp ipv6 external (BGP4+ only)	1201
clear bgp ipv6 peer-group (BGP4+ only)	1202
debug bgp (BGP only)	1203
distance (BGP and BGP4+)	1204
exit-address-family	1206
ip community-list	1207
ip community-list expanded	1209
ip community-list standard	1211
ip extcommunity-list expanded	1213
ip extcommunity-list standard	1215
ip prefix-list (IPv4 Prefix List)	1217
ipv6 prefix-list (IPv6 Prefix List)	1219
match as-path	1221
match community	1222
max-paths	1224
neighbor activate	1225
neighbor advertisement-interval	1228
neighbor allowas-in	1231
neighbor as-origination-interval	1234
neighbor attribute-unchanged	1236
neighbor capability graceful-restart	1239
neighbor capability orf prefix-list	1242
neighbor capability route-refresh	1245
neighbor collide-established	1248
neighbor default-originate	1250

neighbor description	1253
neighbor disallow-infinite-holdtime	1256
neighbor dont-capability-negotiate	1258
neighbor ebgp-multihop	1261
neighbor enforce-multihop	1264
neighbor filter-list	1267
neighbor interface	1270
neighbor local-as	1271
neighbor maximum-prefix	1273
neighbor next-hop-self	1276
neighbor override-capability	1279
neighbor passive	1281
neighbor password	1283
neighbor peer-group (add a neighbor)	1287
neighbor peer-group (create a peer-group)	1289
neighbor port	1290
neighbor prefix-list	1292
neighbor remote-as	1295
neighbor remove-private-AS (BGP only)	1298
neighbor restart-time	1300
neighbor route-map	1302
neighbor route-reflector-client (BGP only)	1306
neighbor route-server-client (BGP only)	1308
neighbor send-community	1309
neighbor shutdown	1312
neighbor soft-reconfiguration inbound	1314
neighbor timers	1317
neighbor transparent-as	1320
neighbor transparent-nexthop	1322
neighbor unsuppress-map	1324
neighbor update-source	1327
neighbor version (BGP only)	1330
neighbor weight	1332
network (BGP and BGP4+)	1335
network synchronization	1338
redistribute (into BGP or BGP4+)	1339
restart bgp graceful (BGP only)	1341
router bgp	1342
route-map	1343
set as-path	1346
set community	1347
show bgp ipv6 (BGP4+ only)	1349
show bgp ipv6 community (BGP4+ only)	1350
show bgp ipv6 community-list (BGP4+ only)	1352
show bgp ipv6 dampening (BGP4+ only)	1353
show bgp ipv6 filter-list (BGP4+ only)	1354
show bgp ipv6 inconsistent-as (BGP4+ only)	1355
show bgp ipv6 longer-prefixes (BGP4+ only)	1356
show bgp ipv6 neighbors (BGP4+ only)	1357
show bgp ipv6 paths (BGP4+ only)	1360
show bgp ipv6 prefix-list (BGP4+ only)	1361
show bgp ipv6 quote-regexp (BGP4+ only)	1362
show bgp ipv6 regexp (BGP4+ only)	1363

show bgp ipv6 route-map (BGP4+ only)	1364
show bgp ipv6 summary (BGP4+ only)	1365
show bgp memory maxallocation (BGP only)	1366
show bgp nexthop-tracking (BGP only)	1367
show bgp nexthop-tree-details (BGP only)	1368
show debugging bgp (BGP only)	1369
show ip bgp (BGP only)	1370
show ip bgp attribute-info (BGP only)	1371
show ip bgp cidr-only (BGP only)	1372
show ip bgp community (BGP only)	1373
show ip bgp community-info (BGP only)	1375
show ip bgp community-list (BGP only)	1376
show ip bgp dampening (BGP only)	1377
show ip bgp filter-list (BGP only)	1379
show ip bgp inconsistent-as (BGP only)	1380
show ip bgp longer-prefixes (BGP only)	1381
show ip bgp neighbors (BGP only)	1382
show ip bgp neighbors connection-retrytime (BGP only)	1385
show ip bgp neighbors hold-time (BGP only)	1386
show ip bgp neighbors keepalive (BGP only)	1387
show ip bgp neighbors keepalive-interval (BGP only)	1388
show ip bgp neighbors notification (BGP only)	1389
show ip bgp neighbors open (BGP only)	1390
show ip bgp neighbors rcvd-msgs (BGP only)	1391
show ip bgp neighbors sent-msgs (BGP only)	1392
show ip bgp neighbors update (BGP only)	1393
show ip bgp paths (BGP only)	1394
show ip bgp prefix-list (BGP only)	1395
show ip bgp quote-regexp (BGP only)	1396
show ip bgp regexp (BGP only)	1398
show ip bgp route-map (BGP only)	1400
show ip bgp scan (BGP only)	1401
show ip bgp summary (BGP only)	1402
show ip community-list	1404
show ip extcommunity-list	1405
show ip prefix-list (IPv4 Prefix List)	1406
show ip protocols bgp (BGP only)	1407
show ipv6 prefix-list (IPv6 Prefix List)	1408
show route-map	1409
synchronization	1410
timers (BGP)	1411
undebg bgp (BGP only)	1412

Chapter 32:	Route Map Commands	1413
	Introduction	1413
	match as-path	1415
	match community	1416
	match interface	1418
	match ip address	1419
	match ip next-hop	1421
	match ipv6 address	1422
	match ipv6 next-hop	1423
	match metric	1424

	match origin	1425
	match route-type	1427
	match tag	1428
	route-map	1429
	set aggregator	1432
	set as-path	1433
	set atomic-aggregate	1434
	set comm-list delete	1435
	set community	1436
	set dampening	1438
	set extcommunity	1440
	set ip next-hop (route map)	1442
	set ipv6 next-hop	1443
	set local-preference	1444
	set metric	1445
	set metric-type	1447
	set origin	1448
	set originator-id	1449
	set tag	1450
	set weight	1451
	show route-map	1452
Chapter 33:	Policy-based Routing Commands	1453
	Introduction	1453
	debug policy-based-routing	1454
	ip policy-route	1455
	ipv6 policy-route	1457
	policy-based-routing	1459
	policy-based-routing enable	1460
	show ip pbr route	1461
	show ipv6 pbr route	1463
	show pbr rules	1465
Chapter 34:	VRF-lite Commands	1467
	Introduction	1467
	address-family	1470
	address-family ipv4 (RIP)	1472
	arp (IP address MAC)	1473
	arp opportunistic-nd	1475
	clear arp-cache	1477
	clear ip bgp * (BGP only)	1479
	clear ip bgp (IPv4) (BGP only)	1481
	clear ip rip route	1482
	crypto key pubkey-chain knownhosts	1484
	default-metric (RIP)	1486
	description (VRF)	1487
	distance (RIP)	1488
	distribute-list (RIP)	1489
	export map	1490
	fullupdate (RIP)	1491
	import map	1492
	ip route static inter-vrf	1493

ip route	1494
ip vrf	1497
ip vrf forwarding	1498
max-fib-routes (VRF)	1499
max-static-routes (VRF)	1501
neighbor next-hop-self	1502
neighbor remote-as	1505
neighbor password	1508
network (RIP)	1512
passive-interface (RIP)	1514
ping	1515
rd (route distinguisher)	1517
redistribute (into BGP or BGP4+)	1518
redistribute (OSPF)	1520
redistribute (RIP)	1522
route (RIP)	1524
route-target	1525
router ospf	1527
router-id (VRF)	1529
show arp	1530
show crypto key pubkey-chain knownhosts	1533
show ip bgp cidr-only (BGP only)	1535
show ip bgp community (BGP only)	1536
show ip bgp community-list (BGP only)	1538
show ip bgp dampening (BGP only)	1539
show ip bgp filter-list (BGP only)	1541
show ip bgp inconsistent-as (BGP only)	1542
show ip bgp longer-prefixes (BGP only)	1543
show ip bgp prefix-list (BGP only)	1544
show ip bgp quote-regexp (BGP only)	1545
show ip bgp regexp (BGP only)	1547
show ip bgp route-map (BGP only)	1549
show ip bgp summary (BGP only)	1550
show ip interface vrf	1552
show ip rip vrf database	1554
show ip rip vrf interface	1555
show ip route	1556
show ip route database	1559
show ip route summary	1562
show ip vrf	1564
show ip vrf detail	1565
show ip vrf interface	1566
show running-config vrf	1567
ssh	1568
tcpdump	1570
telnet	1571
timers (RIP)	1572
traceroute	1574
version (RIP)	1575

PART 4: Multicast Applications 1577

Chapter 35: IGMP and IGMP Snooping Commands 1578

Introduction	1578
clear ip igmp	1580
clear ip igmp group	1581
clear ip igmp interface	1582
debug igmp	1583
ip igmp	1584
ip igmp flood specific-query	1585
ip igmp last-member-query-count	1586
ip igmp last-member-query-interval	1587
ip igmp maximum-groups	1588
ip igmp mroute-proxy	1590
ip igmp proxy-service	1591
ip igmp querier-timeout	1592
ip igmp query-holdtime	1593
ip igmp query-interval	1595
ip igmp query-max-response-time	1597
ip igmp ra-option	1599
ip igmp robustness-variable	1600
ip igmp snooping	1601
ip igmp snooping fast-leave	1602
ip igmp snooping mrouter	1603
ip igmp snooping querier	1604
ip igmp snooping report-suppression	1605
ip igmp snooping routermode	1606
ip igmp snooping source-timeout	1608
ip igmp snooping tcn query solicit	1609
ip igmp source-address-check	1611
ip igmp startup-query-count	1612
ip igmp startup-query-interval	1613
ip igmp trusted	1614
ip igmp version	1615
show debugging igmp	1616
show ip igmp groups	1617
show ip igmp interface	1619
show ip igmp proxy	1621
show ip igmp snooping mrouter	1622
show ip igmp snooping routermode	1623
show ip igmp snooping source-timeout	1624
show ip igmp snooping statistics	1625
undebug igmp	1627

Chapter 36: MLD and MLD Snooping Commands 1628

Introduction	1628
clear ipv6 mld	1630
clear ipv6 mld group	1631
clear ipv6 mld interface	1632
debug mld	1633
ipv6 mld	1634
ipv6 mld last-member-query-count	1635
ipv6 mld last-member-query-interval	1636
ipv6 mld querier-timeout	1637
ipv6 mld query-interval	1638
ipv6 mld query-max-response-time	1639

ipv6 mld robustness-variable	1640
ipv6 mld snooping	1641
ipv6 mld snooping fast-leave	1643
ipv6 mld snooping mrouter	1644
ipv6 mld snooping querier	1646
ipv6 mld snooping report-suppression	1647
ipv6 mld ssm-map enable	1649
ipv6 mld static-group	1650
ipv6 mld version	1652
show debugging mld	1653
show ipv6 mld groups	1654
show ipv6 mld interface	1655
show ipv6 mld snooping mrouter	1656
show ipv6 mld snooping statistics	1657

Chapter 37: Multicast Commands 1658

Introduction	1658
clear ip mroute	1660
clear ip mroute statistics	1661
clear ipv6 mroute	1662
clear ipv6 mroute statistics	1663
debug nsm mcast	1664
debug nsm mcast6	1665
ip mroute	1666
ip multicast route	1668
ip multicast route-limit	1670
ip multicast wrong-vif-suppression	1671
ip multicast-routing	1672
ipv6 mroute	1673
ipv6 multicast route	1675
ipv6 multicast route-limit	1677
ipv6 multicast-routing	1678
multicast	1679
show ip mroute	1680
show ip mvif	1682
show ip rpf	1683
show ipv6 mroute	1684
show ipv6 multicast forwarding	1686
show ipv6 mif	1687

Chapter 38: PIM-SM Commands 1688

Introduction	1688
clear ip pim sparse-mode bsr rp-set *	1690
clear ip pim sparse-mode packet statistics	1691
clear ip mroute pim sparse-mode	1692
debug pim sparse-mode	1693
debug pim sparse-mode timer	1694
ip pim anycast-rp	1696
ip pim bsr-border	1697
ip pim bsr-candidate	1698
ip pim cisco-register-checksum	1699
ip pim crp-cisco-prefix	1700

ip pim dr-priority	1701
ip pim exclude-genid	1702
ip pim ext-srcs-directly-connected	1703
ip pim hello-holdtime (PIM-SM)	1704
ip pim hello-interval (PIM-SM)	1705
ip pim ignore-rp-set-priority	1706
ip pim jp-timer	1707
ip pim register-rate-limit	1708
ip pim register-rp-reachability	1709
ip pim register-source	1710
ip pim register-suppression	1711
ip pim rp-address	1712
ip pim rp-candidate	1713
ip pim rp-register-kat	1714
ip pim sparse-mode	1715
ip pim sparse-mode passive	1716
ip pim spt-threshold	1717
ip pim ssm	1718
show debugging pim sparse-mode	1719
show ip pim sparse-mode bsr-router	1720
show ip pim sparse-mode interface	1721
show ip pim sparse-mode interface detail	1723
show ip pim sparse-mode local-members	1724
show ip pim sparse-mode mroute	1725
show ip pim sparse-mode mroute detail	1727
show ip pim sparse-mode neighbor	1729
show ip pim sparse-mode nexthop	1730
show ip pim sparse-mode packet statistics	1731
show ip pim sparse-mode rp-hash	1732
show ip pim sparse-mode rp mapping	1733
undebg all pim sparse-mode	1734

Chapter 39:	PIM-SMv6 Commands	1735
	Introduction	1735
	clear ipv6 mroute pim	1738
	clear ipv6 mroute pim sparse-mode	1739
	clear ipv6 pim sparse-mode bsr rp-set *	1740
	debug ipv6 pim sparse-mode	1741
	debug ipv6 pim sparse-mode packet	1743
	debug ipv6 pim sparse-mode timer	1744
	ipv6 pim anycast-rp	1746
	ipv6 pim bsr-border	1748
	ipv6 pim bsr-candidate	1750
	ipv6 pim cisco-register-checksum	1752
	ipv6 pim crp-cisco-prefix	1753
	ipv6 pim dr-priority	1754
	ipv6 pim exclude-genid	1756
	ipv6 pim ext-srcs-directly-connected	1757
	ipv6 pim hello-holdtime	1758
	ipv6 pim hello-interval	1759
	ipv6 pim ignore-rp-set-priority	1760
	ipv6 pim jp-timer	1761
	ipv6 pim neighbor-filter	1762

ipv6 pim register-rate-limit	1763
ipv6 pim register-rp-reachability	1764
ipv6 pim register-source	1765
ipv6 pim register-suppression	1766
ipv6 pim rp-address	1767
ipv6 pim rp-candidate	1769
ipv6 pim rp embedded	1770
ipv6 pim rp-register-kat	1771
ipv6 pim sparse-mode	1772
ipv6 pim sparse-mode passive	1773
ipv6 pim spt-threshold	1774
ipv6 pim ssm	1775
ipv6 pim unicast-bsm	1776
show debugging ipv6 pim sparse-mode	1777
show ipv6 pim sparse-mode bsr-router	1778
show ipv6 pim sparse-mode interface	1779
show ipv6 pim sparse-mode interface detail	1781
show ipv6 pim sparse-mode local-members	1782
show ipv6 pim sparse-mode mroute	1784
show ipv6 pim sparse-mode mroute detail	1786
show ipv6 pim sparse-mode neighbor	1788
show ipv6 pim sparse-mode nexthop	1789
show ipv6 pim sparse-mode rp-hash	1790
show ipv6 pim sparse-mode rp mapping	1791
show ipv6 pim sparse-mode rp nexthop	1792
undebug all ipv6 pim sparse-mode	1794
undebug ipv6 pim sparse-mode	1795

PART 5: Access and Security 1797

Chapter 40: Traffic Control Commands 1798

Introduction	1798
class (htb)	1800
class (priority)	1802
class (wrr)	1804
debug traffic-control	1806
interface (traffic-control)	1807
l3-filtering enable	1808
move rule (traffic-control)	1809
policy (traffic-control)	1810
red-curve	1812
rule (traffic-control)	1814
show debugging traffic-control	1816
show running-config traffic-control	1817
show traffic-control counters	1819
show traffic-control interface	1821
show traffic-control policy	1823
show traffic-control red-curve	1825
show traffic-control rule config-check	1827
show traffic-control rule	1828
show traffic-control	1829
sub-class (htb)	1830

	sub-class (priority)	1832
	sub-class (wrr)	1834
	sub-sub-class (htb)	1836
	sub-sub-class (priority)	1838
	sub-sub-class (wrr)	1840
	traffic-control enable	1842
	traffic-control	1843
Chapter 41:	Traffic Shaping Commands (deleted)	1845
	Introduction	1845
Chapter 42:	Authentication Commands	1846
	Introduction	1846
	auth critical	1849
	auth host-mode	1850
	auth log	1852
	auth max-supplicant	1854
	auth profile (Global Configuration)	1856
	auth profile (Interface Configuration)	1857
	auth reauthentication	1858
	auth supplicant-ip	1859
	auth supplicant-mac	1861
	auth timeout connect-timeout	1864
	auth timeout quiet-period	1865
	auth timeout reauth-period	1866
	auth timeout server-timeout	1868
	auth-web accounting	1869
	auth-web authentication	1870
	auth-web enable	1871
	auth-web forward	1873
	auth-web idle-timeout enable	1876
	auth-web idle-timeout timeout	1877
	auth-web max-auth-fail	1878
	auth-web method	1880
	auth-web-server dhcp ipaddress	1881
	auth-web-server dhcp lease	1882
	auth-web-server dhcp-wpad-option	1883
	auth-web-server host-name	1884
	auth-web-server intercept-port	1885
	auth-web-server ipaddress	1886
	auth-web-server page language	1887
	auth-web-server login-url	1888
	auth-web-server page logo	1889
	auth-web-server page sub-title	1890
	auth-web-server page success-message	1891
	auth-web-server page title	1892
	auth-web-server page welcome-message	1893
	auth-web-server ping-poll enable	1894
	auth-web-server ping-poll failcount	1895
	auth-web-server ping-poll interval	1896
	auth-web-server ping-poll reauth-timer-refresh	1897
	auth-web-server ping-poll timeout	1898

auth-web-server port	1899
auth-web-server redirect-delay-time	1900
auth-web-server redirect-url	1901
auth-web-server session-keep	1902
auth-web-server ssl	1903
auth-web-server ssl intercept-port	1904
copy proxy-autoconfig-file	1905
copy web-auth-https-file	1906
description (Authentication Profile)	1907
erase proxy-autoconfig-file	1908
erase web-auth-https-file	1909
show auth	1910
show auth diagnostics	1911
show auth interface	1912
show auth sessionstatistics	1915
show auth statistics interface	1916
show auth supplicant	1917
show auth supplicant interface	1920
show auth-web-server	1921
show auth-web-server page	1922
show proxy-autoconfig-file	1923

Chapter 43:

AAA Commands	1924
Introduction	1924
aaa accounting auth-web	1926
aaa accounting commands	1928
aaa accounting login	1930
aaa authentication auth-web	1933
aaa authentication enable default group tacacs+	1935
aaa authentication enable default local	1937
aaa authentication login	1938
aaa authentication openvpn	1940
aaa authorization commands	1941
aaa authorization config-commands	1943
aaa group server	1944
aaa local authentication attempts lockout-time	1945
aaa local authentication attempts max-fail	1946
aaa login fail-delay	1947
accounting login	1948
authorization commands	1949
clear aaa local user lockout	1951
debug aaa	1952
login authentication	1953
proxy-port	1954
radius-secure-proxy aaa	1955
server (radsecproxy-aaa)	1956
server mutual-authentication	1958
server name-check	1959
server trustpoint	1960
show aaa local user locked	1962
show aaa server group	1963
show debugging aaa	1964
show radius server group	1965

	undebug aaa	1967
Chapter 44:	RADIUS Commands	1968
	Introduction	1968
	deadtime (RADIUS server group)	1969
	debug radius	1970
	ip radius source-interface	1971
	radius-server deadtime	1972
	radius-server host	1973
	radius-server key	1976
	radius-server retransmit	1977
	radius-server timeout	1979
	server (Server Group)	1981
	show debugging radius	1983
	show radius	1984
	undebug radius	1987
Chapter 45:	Local RADIUS Server Commands	1988
	Introduction	1988
	attribute	1990
	authentication	1993
	client (radsecproxy-srv)	1994
	client mutual-authentication	1996
	client name-check	1997
	client trustpoint	1998
	clear radius local-server statistics	1999
	copy fdb-radius-users (to file)	2000
	copy local-radius-user-db (from file)	2002
	copy local-radius-user-db (to file)	2003
	crypto pki enroll local (deleted)	2004
	crypto pki enroll local local-radius-all-users (deleted)	2005
	crypto pki enroll local user (deleted)	2006
	crypto pki export local pem (deleted)	2007
	crypto pki export local pkcs12 (deleted)	2008
	crypto pki trustpoint local (deleted)	2009
	debug crypto pki (deleted)	2010
	domain-style	2011
	egress-vlan-id	2012
	egress-vlan-name	2013
	group	2014
	nas	2015
	radius-secure-proxy local-server	2016
	radius-server local	2017
	server auth-port	2018
	server enable	2019
	show crypto pki certificates (deleted)	2020
	show crypto pki certificates local-radius-all-users (deleted)	2021
	show crypto pki certificates user (deleted)	2022
	show crypto pki trustpoints (deleted)	2023
	show radius local-server group	2024
	show radius local-server nas	2025
	show radius local-server statistics	2026

	show radius local-server user	2027
	user (RADIUS server)	2029
	vlan (RADIUS server)	2031
Chapter 46:	Public Key Infrastructure Commands	2032
	Introduction	2032
	crypto key generate rsa	2033
	crypto key zeroize	2034
	crypto pki authenticate	2035
	crypto pki enroll	2036
	crypto pki enroll user	2037
	crypto pki export pem	2039
	crypto pki export pkcs12	2040
	crypto pki import pem	2042
	crypto pki import pkcs12	2044
	crypto pki trustpoint	2045
	enrollment (trustpoint configuration mode)	2046
	fingerprint (trustpoint configuration mode)	2047
	no crypto pki certificate	2049
	rsa keypair (trustpoint configuration mode)	2050
	show crypto key mypubkey rsa	2051
	show crypto pki certificates	2052
	show crypto pki enrollment user	2054
	show crypto pki trustpoint	2055
	subject-name (trustpoint configuration)	2056
Chapter 47:	TACACS+ Commands	2058
	Introduction	2058
	authorization commands	2059
	aaa authorization commands	2061
	aaa authorization config-commands	2063
	ip tacacs source-interface	2064
	show tacacs+	2065
	tacacs-server host	2067
	tacacs-server key	2069
	tacacs-server timeout	2070
PART 6:	High Availability	2071
Chapter 48:	High Availability Commands	2072
	Introduction	2072
	ha associate	2073
Chapter 49:	VRRP Commands	2075
	Introduction	2075
	advertisement-interval	2077
	alternate-checksum-mode	2079
	circuit-failover	2080
	debug vrrp	2082
	debug vrrp events	2083
	debug vrrp packet	2084

disable (VRRP)	2085
enable (VRRP)	2086
preempt-mode	2087
priority	2089
router ipv6 vrrp (interface)	2091
router vrrp (interface)	2093
show debugging vrrp	2095
show running-config router ipv6 vrrp	2096
show running-config router vrrp	2097
show vrrp	2098
show vrrp counters	2100
show vrrp ipv6	2103
show vrrp (session)	2104
transition-mode	2106
undebg vrrp	2108
undebg vrrp events	2109
undebg vrrp packet	2110
virtual-ip	2111
virtual-ipv6	2113
vrrp vmac	2115

PART 7: Network Management 2116

Chapter 50: Allied Telesis Management Framework™ (AMF) Commands 2117

Introduction	2117
area-link	2122
atmf area	2124
atmf area password	2126
atmf authorize	2128
atmf authorize provision	2130
atmf backup	2132
atmf backup area-masters delete	2133
atmf backup area-masters enable	2134
atmf backup area-masters now	2135
atmf backup area-masters synchronize	2136
atmf backup bandwidth	2137
atmf backup delete	2138
atmf backup enable	2139
atmf backup guests delete	2140
atmf backup guests enable	2141
atmf backup guests now	2142
atmf backup guests synchronize	2143
atmf backup now	2144
atmf backup redundancy enable	2146
atmf backup server	2147
atmf backup stop	2149
atmf backup synchronize	2150
atmf cleanup	2151
atmf container	2152
atmf container login	2153
atmf controller	2154
atmf distribute firmware	2155

atmf domain vlan	2157
atmf enable	2160
atmf group (membership)	2161
atmf guest-class	2163
atmf log-verbose	2165
atmf management subnet	2166
atmf management vlan	2169
atmf master	2171
atmf mtu	2172
atmf network-name	2173
atmf provision	2174
atmf provision node clone	2175
atmf provision node configure boot config	2177
atmf provision node configure boot system	2178
atmf provision node create	2179
atmf provision node delete	2181
atmf provision node license-cert	2183
atmf provision node locate	2185
atmf reboot-rolling	2186
atmf recover	2190
atmf recover guest	2192
atmf recover led-off	2193
atmf remote-login	2194
atmf restricted-login	2196
atmf secure-mode	2198
atmf secure-mode certificate expire	2200
atmf secure-mode certificate expiry	2201
atmf secure-mode certificate renew	2202
atmf secure-mode enable-all	2203
atmf select-area	2205
atmf topology-gui enable	2206
atmf virtual-crosslink	2207
atmf virtual-link	2209
atmf working-set	2211
bridge-group	2213
clear atmf links statistics	2214
clear atmf secure-mode certificates	2215
clear atmf secure-mode statistics	2216
debug atmf	2217
debug atmf packet	2219
discovery	2222
description (amf container)	2224
erase factory-default	2225
http-enable	2226
log event-host	2228
modeltype	2229
show atmf	2230
show atmf area	2234
show atmf area guests	2237
show atmf area guests-detail	2239
show atmf area nodes	2241
show atmf area nodes-detail	2243
show atmf area summary	2245

show atmf authorization	2246
show atmf backup	2249
show atmf backup area	2253
show atmf backup guest	2255
show atmf container	2257
show atmf detail	2260
show atmf group	2262
show atmf group members	2264
show atmf guests	2266
show atmf guests detail	2268
show atmf links	2271
show atmf links detail	2273
show atmf links guest	2282
show atmf links guest detail	2284
show atmf links statistics	2288
show atmf nodes	2291
show atmf provision nodes	2293
show atmf secure-mode	2294
show atmf secure-mode audit	2296
show atmf secure-mode audit link	2297
show atmf secure-mode certificates	2298
show atmf secure-mode sa	2301
show atmf secure-mode statistics	2304
show atmf tech	2306
show atmf virtual-links	2309
show atmf working-set	2311
show debugging atmf	2312
show debugging atmf packet	2313
show running-config atmf	2314
state	2315
switchport atmf-agentlink	2317
switchport atmf-arealink remote-area	2318
switchport atmf-crosslink	2320
switchport atmf-guestlink	2322
switchport atmf-link	2324
type atmf node	2325
undebg atmf	2328
username	2329

Chapter 51: Dynamic Host Configuration Protocol (DHCP) Commands 2331

Introduction	2331
bootfile	2333
clear ip dhcp binding	2334
default-router	2335
dns-server	2336
domain-name	2337
host (DHCP)	2338
ip address dhcp	2339
ip dhcp bootp ignore	2341
ip dhcp leasequery enable	2342
ip dhcp option	2343
ip dhcp pool	2345
ip dhcp-client default-route distance	2346

ip dhcp-relay agent-option	2348
ip dhcp-relay agent-option checking	2350
ip dhcp-relay agent-option remote-id	2352
ip dhcp-relay information policy	2354
ip dhcp-relay maxhops	2356
ip dhcp-relay max-message-length	2357
ip dhcp-relay server-address	2359
lease	2361
network (DHCP)	2363
next-server	2364
option	2365
probe enable	2367
probe packets	2368
probe timeout	2369
probe type	2370
range	2371
route	2372
service dhcp-relay	2373
service dhcp-server	2374
show counter dhcp-client	2375
show counter dhcp-relay	2376
show counter dhcp-server	2380
show dhcp lease	2382
show ip dhcp binding	2384
show ip dhcp pool	2386
show ip dhcp-relay	2390
show ip dhcp server statistics	2392
show ip dhcp server summary	2394
subnet-mask	2395

Chapter 52: DHCP for IPv6 (DHCPv6) Commands 2396

Introduction	2396
address prefix	2398
address range	2400
clear counter ipv6 dhcp-client	2402
clear counter ipv6 dhcp-server	2403
clear ipv6 dhcp binding	2404
clear ipv6 dhcp client	2406
dns-server (DHCPv6)	2407
domain-name (DHCPv6)	2409
ipv6 address (DHCPv6 PD)	2410
ipv6 address dhcp	2413
ipv6 dhcp client pd	2415
ipv6 dhcp option	2417
ipv6 dhcp pool	2419
ipv6 dhcp server	2421
ipv6 local pool	2422
ipv6 nd prefix (DHCPv6)	2424
link-address	2426
option (DHCPv6)	2428
prefix-delegation pool	2430
show counter ipv6 dhcp-client	2432
show counter ipv6 dhcp-server	2434

	show ipv6 dhcp	2436
	show ipv6 dhcp binding	2437
	show ipv6 dhcp interface	2440
	show ipv6 dhcp pool	2442
	snmp-address	2444
Chapter 53:	NTP Commands	2445
	Introduction	2445
	ntp authenticate	2446
	ntp authentication-key	2447
	ntp broadcastdelay	2448
	ntp discard	2449
	ntp master	2450
	ntp peer	2451
	ntp restrict	2453
	ntp server	2455
	ntp source	2457
	ntp trusted-key (deprecated)	2459
	show counter ntp (deprecated)	2460
	show ntp associations	2461
	show ntp counters	2463
	show ntp counters associations	2465
	show ntp status	2467
Chapter 54:	SNMP Commands	2468
	Introduction	2468
	debug snmp	2470
	show counter snmp-server	2471
	show debugging snmp	2475
	show running-config snmp	2476
	show snmp-server	2477
	show snmp-server community	2478
	show snmp-server group	2479
	show snmp-server user	2480
	show snmp-server view	2481
	snmp trap link-status	2482
	snmp trap link-status suppress	2484
	snmp-server	2486
	snmp-server community	2488
	snmp-server contact	2489
	snmp-server enable trap	2490
	snmp-server engineID local	2492
	snmp-server engineID local reset	2494
	snmp-server group	2495
	snmp-server host	2497
	snmp-server legacy-ifadminstatus	2499
	snmp-server location	2500
	snmp-server source-interface	2501
	snmp-server startup-trap-delay	2502
	snmp-server user	2503
	snmp-server view	2506
	undebg snmp	2507

Chapter 55:	SMTP Commands	2508
	Introduction	2508
	debug mail	2509
	delete mail	2510
	mail	2511
	show counter mail	2512
	show mail	2513
	undebg mail	2514
Chapter 56:	Secure Shell (SSH) Commands	2515
	Introduction	2515
	banner login (SSH)	2517
	clear ssh	2518
	crypto key destroy hostkey	2519
	crypto key destroy userkey	2520
	crypto key generate hostkey	2521
	crypto key generate userkey	2523
	crypto key pubkey-chain knownhosts	2524
	crypto key pubkey-chain userkey	2526
	debug ssh client	2528
	debug ssh server	2529
	service ssh	2530
	show banner login	2532
	show crypto key hostkey	2533
	show crypto key pubkey-chain knownhosts	2535
	show crypto key pubkey-chain userkey	2537
	show crypto key userkey	2538
	show running-config ssh	2539
	show ssh	2541
	show ssh client	2543
	show ssh server	2544
	show ssh server allow-users	2546
	show ssh server deny-users	2547
	ssh	2548
	ssh client	2550
	ssh server	2552
	ssh server allow-users	2554
	ssh server authentication	2556
	ssh server deny-users	2558
	ssh server max-auth-tries	2560
	ssh server resolve-host	2561
	ssh server scp	2562
	ssh server sftp	2563
	undebg ssh client	2564
	undebg ssh server	2565
Chapter 57:	Trigger Commands	2566
	Introduction	2566
	active (trigger)	2568
	day	2569
	debug trigger	2571
	description (trigger)	2572

repeat	2573
script	2574
show debugging trigger	2576
show running-config trigger	2577
show trigger	2578
test	2583
time (trigger)	2584
trap	2586
trigger	2587
trigger activate	2588
type atmf node	2589
type card	2592
type cpu	2593
type interface	2594
type memory	2595
type periodic	2596
type ping-poll	2597
type reboot	2598
type time	2599
type usb	2600
undebg trigger	2601

Chapter 58: Ping-Polling Commands 2602

Introduction	2602
active (ping-polling)	2604
clear ping-poll	2605
critical-interval	2606
debug ping-poll	2607
description (ping-polling)	2608
fail-count	2609
ip (ping-polling)	2610
length (ping-poll data)	2611
normal-interval	2612
ping-poll	2613
sample-size	2614
show counter ping-poll	2616
show ping-poll	2618
source-ip	2622
timeout (ping polling)	2624
up-count	2625
undebg ping-poll	2626

PART 8: Firewall and Network Address Translation (NAT) 2627

Chapter 59: Firewall Commands 2628

Introduction	2628
clear firewall connections	2630
connection-limit (Firewall)	2631
connection-log events	2632
firewall	2633
debug firewall	2634
ip tcp timeout established	2635

	move rule (Firewall)	2636
	protect (Firewall)	2637
	rule (Firewall)	2638
	show connection-log events	2640
	show firewall	2641
	show firewall connections	2642
	show firewall connections limits	2643
	show firewall connections limits config-check	2644
	show firewall rule	2645
	show firewall rule config-check	2647
	show debugging firewall	2648
	show running-config firewall	2649
Chapter 60:	Application and Entity Commands	2650
	Introduction	2650
	application	2652
	dport	2654
	dscp	2656
	host (Entity)	2658
	icmp-code	2660
	icmp-type	2662
	ip address (Entity)	2664
	ip subnet	2666
	ipv6 address (Entity)	2668
	ipv6 subnet	2670
	network (Entity)	2672
	protocol	2674
	show application	2676
	show application detail	2677
	show entity	2680
	sport	2682
	zone	2684
Chapter 61:	NAT Commands	2686
	Introduction	2686
	enable (NAT)	2688
	ip limited-local-proxy-arp	2689
	local-proxy-arp	2691
	move rule (NAT)	2692
	nat	2693
	rule (NAT)	2694
	show nat	2698
	show nat rule	2699
	show nat rule config-check	2701
	show running-config nat	2702
PART 9:	Advanced Network Protection	2703
Chapter 62:	IPS Commands	2704
	Introduction	2704
	category action (IPS)	2705
	ips	2706

	protect (IPS)	2707
	show ips	2708
	show ips categories	2709
	show running-config ips	2711
Chapter 63:	Malware Protection Commands	2712
	Introduction	2712
	malware-protection	2713
	protect (Malware Protection)	2714
	provider kaspersky (Malware Protection)	2715
	show malware-protection	2716
	show running-config malware-protection	2717
	update-interval (Malware Protection)	2718
Chapter 64:	Antivirus Commands	2720
	Introduction	2720
	action (Antivirus)	2722
	antivirus	2724
	debug antivirus	2725
	protect (Antivirus)	2726
	provider kaspersky (Antivirus)	2727
	show antivirus	2728
	show antivirus statistics	2729
	show debugging antivirus	2730
	show running-config antivirus	2731
	update-interval (Antivirus)	2732
Chapter 65:	URL Filtering Commands	2734
	Introduction	2734
	blacklist	2736
	log url-requests	2737
	protect (URL filtering)	2738
	provider kaspersky	2739
	show running-config url-filter	2740
	show url-filter	2741
	update-interval (URL Filtering)	2742
	url-filter reload custom-lists	2744
	url-filter	2745
	whitelist	2746
Chapter 66:	Web Control Commands	2747
	Introduction	2747
	action (Web Control)	2749
	category (Web Control)	2750
	debug web-control	2752
	match (Web-Control)	2753
	move rule (Web Control)	2755
	protect (Web Control)	2756
	provider digitalarts	2757
	rule (Web Control)	2758
	show debugging web-control	2761
	show running-config web-control	2762

	show web-control	2763
	show web-control categories	2765
	show web-control rules	2767
	web-control	2768
Chapter 67:	Application Control Commands	2770
	Introduction	2770
	dpi	2772
	enable (DPI)	2773
	provider provera	2774
	show dpi	2775
	show dpi statistics	2776
	show running-config dpi	2777
	update-interval (Application Control)	2778
Chapter 68:	IP Reputation Commands	2780
	Introduction	2780
	category action (IP Reputation)	2782
	ip-reputation	2784
	protect (IP Reputation)	2785
	provider proofpoint (IP Reputation)	2786
	show ip-reputation	2787
	show ip-reputation categories	2788
	show running-config ip-reputation	2790
	update-interval (IP Reputation)	2791
PART 10:	Virtual Private Networks (VPNs)	2793
Chapter 69:	IPsec Commands	2794
	Introduction	2794
	clear isakmp sa	2796
	crypto ipsec profile	2797
	crypto isakmp key	2799
	crypto isakmp peer	2801
	crypto isakmp profile	2803
	debug isakmp	2805
	dpd-interval	2807
	dpd-timeout	2808
	interface tunnel	2809
	lifetime (IPsec Profile)	2810
	lifetime (ISAKMP Profile)	2811
	no debug isakmp	2812
	pfs	2813
	show debugging isakmp	2815
	show interface tunnel (IPsec)	2816
	show ipsec counters	2817
	show ipsec peer	2818
	show ipsec policy	2819
	show ipsec profile	2820
	show ipsec sa	2822
	show isakmp counters	2823
	show isakmp key (IPsec)	2824

show isakmp peer	2825
show isakmp profile	2826
show isakmp sa	2828
transform (IPsec Profile)	2829
transform (ISAKMP Profile)	2830
tunnel destination (IPsec)	2832
tunnel local name (IPsec)	2834
tunnel local selector	2835
tunnel mode (IPsec)	2837
tunnel protection ipsec (IPsec)	2838
tunnel remote name (IPsec)	2839
tunnel remote selector	2840
tunnel source (IPsec)	2842
undebug isakmp	2844
version (ISAKMP)	2845

Chapter 70: GRE Tunneling Commands 2846

Introduction	2846
crypto isakmp key	2847
interface tunnel	2849
ip address (GRE)	2850
ip tcp adjust-mss	2852
ipv6 address (GRE)	2854
ipv6 tcp adjust-mss	2856
show interface tunnel (GRE)	2858
show isakmp key (GRE)	2859
tunnel checksum	2860
tunnel dscp	2861
tunnel destination (GRE)	2862
tunnel local name (GRE)	2864
tunnel mode (GRE)	2865
tunnel protection ipsec (GRE)	2866
tunnel remote name (GRE)	2867
tunnel source (GRE)	2868
tunnel ttl	2870

Chapter 71: OpenVPN Commands 2871

Introduction	2871
ip tcp adjust-mss	2873
ipv6 tcp adjust-mss	2875
show interface tunnel (OpenVPN)	2877
show openvpn connections	2878
show openvpn connections detail	2879
tunnel openvpn authentication	2880
tunnel openvpn cipher	2881
tunnel mode openvpn tap	2883
tunnel mode openvpn tun	2884
tunnel openvpn expiry-bytes	2885
tunnel openvpn expiry-seconds	2886
tunnel openvpn port	2887
tunnel openvpn tagging	2888

Chapter 72:	L2TP Commands	2889
	Introduction	2889
	crypto isakmp key	2891
	debug l2tp	2893
	destination	2894
	encapsulation ppp	2895
	ip-version	2897
	l2tp tunnel	2898
	l2tp unmanaged port	2900
	l2tp-profile	2901
	local-subaddress	2902
	protection ipsec	2903
	protection local-name	2904
	protection profile	2906
	protection remote-name	2907
	remote-subaddress	2909
	shared-secret	2910
	show debugging l2tp	2911
	show interface tunnel (L2TPv3)	2912
	show isakmp key (L2TPv3)	2913
	show l2tp session	2914
	show l2tp tunnel	2916
	show l2tp tunnel config-check	2920
	show running-config l2tp-profile	2922
	show running-config l2tp-tunnel	2923
	source	2924
	tunnel local id	2925
	tunnel mode (L2TPv3)	2926
	tunnel protection ipsec	2927
	tunnel remote id	2928
	version	2929

List of Commands

aaa accounting auth-web	1926
aaa accounting commands.....	1928
aaa accounting login.....	1930
aaa authentication auth-web.....	1933
aaa authentication enable default group tacacs+	1935
aaa authentication enable default local.....	1937
aaa authentication login	1938
aaa authentication openvpn	1940
aaa authorization commands	1941
aaa authorization commands	2061
aaa authorization config-commands	1943
aaa authorization config-commands	2063
aaa group server.....	1944
aaa local authentication attempts lockout-time.....	1945
aaa local authentication attempts max-fail.....	1946
aaa login fail-delay.....	1947
abr-type.....	1040
accept-lifetime	846
accounting login.....	1948
action (Antivirus)	2722
action (Web Control).....	2749
activate.....	398
active (ping-polling)	2604
active (trigger).....	2568
address prefix	2398

address range	2400
address-family ipv4 (RIP)	1472
address-family ipv4 (RIP)	848
address-family	1137
address-family	1470
advertisement-interval	2077
ageing-time	482
aggregate-address (IPv6 RIPng)	907
aggregate-address	1139
alliedware-behavior	849
alternate-checksum-mode	2079
antivirus	2724
apn	423
application	2652
area authentication ipsec spi	1041
area authentication	935
area default-cost (IPv6 OSPF)	1043
area default-cost	934
area encryption ipsec spi esp	1044
area filter-list	936
area nssa	937
area range (IPv6 OSPF)	1047
area range	939
area stub (IPv6 OSPF)	1049
area stub	941
area virtual-link (IPv6 OSPF)	1050
area virtual-link authentication ipsec spi	1052
area virtual-link encryption ipsec spi	1054
area virtual-link	942
area-link	2122
arp (IP address MAC)	1473
arp (IP address MAC)	681
arp log	683
arp opportunistic-nd	1475
arp opportunistic-nd	686

arp-aging-timeout.....	680
arp-reply-bc-dmac.....	688
atmf area password.....	2126
atmf area.....	2124
atmf authorize provision.....	2130
atmf authorize.....	2128
atmf backup area-masters delete.....	2133
atmf backup area-masters enable.....	2134
atmf backup area-masters now.....	2135
atmf backup area-masters synchronize.....	2136
atmf backup bandwidth.....	2137
atmf backup delete.....	2138
atmf backup enable.....	2139
atmf backup guests delete.....	2140
atmf backup guests enable.....	2141
atmf backup guests now.....	2142
atmf backup guests synchronize.....	2143
atmf backup now.....	2144
atmf backup redundancy enable.....	2146
atmf backup server.....	2147
atmf backup stop.....	2149
atmf backup synchronize.....	2150
atmf backup.....	2132
atmf cleanup.....	2151
atmf container login.....	2153
atmf container.....	2152
atmf controller.....	2154
atmf distribute firmware.....	2155
atmf domain vlan.....	2157
atmf enable.....	2160
atmf group (membership).....	2161
atmf guest-class.....	2163
atmf log-verbose.....	2165
atmf management subnet.....	2166
atmf management vlan.....	2169

atmf master	2171
atmf mtu	2172
atmf network-name	2173
atmf provision node clone	2175
atmf provision node configure boot config	2177
atmf provision node configure boot system	2178
atmf provision node create	2179
atmf provision node delete	2181
atmf provision node license-cert	2183
atmf provision node locate.....	2185
atmf provision.....	2174
atmf reboot-rolling	2186
atmf recover guest.....	2192
atmf recover led-off.....	2193
atmf recover.....	2190
atmf remote-login	2194
atmf restricted-login.....	2196
atmf secure-mode certificate expire	2200
atmf secure-mode certificate expiry	2201
atmf secure-mode certificate renew	2202
atmf secure-mode enable-all.....	2203
atmf secure-mode	2198
atmf select-area	2205
atmf topology-gui enable.....	213
atmf topology-gui enable.....	2206
atmf virtual-crosslink	2207
atmf virtual-link	2209
atmf working-set	2211
attribute	1990
auth critical.....	1849
auth host-mode	1850
auth log.....	1852
auth max-supplicant.....	1854
auth profile (Global Configuration)	1856
auth profile (Interface Configuration).....	1857

auth reauthentication.....	1858
auth supplicant-ip.....	1859
auth supplicant-mac.....	1861
auth timeout connect-timeout.....	1864
auth timeout quiet-period.....	1865
auth timeout reauth-period.....	1866
auth timeout server-timeout.....	1868
authentication.....	1993
authorization commands.....	1949
authorization commands.....	2059
auth-web accounting.....	1869
auth-web authentication.....	1870
auth-web enable.....	1871
auth-web forward.....	1873
auth-web idle-timeout enable.....	1876
auth-web idle-timeout timeout.....	1877
auth-web max-auth-fail.....	1878
auth-web method.....	1880
auth-web-server dhcp ipaddress.....	1881
auth-web-server dhcp lease.....	1882
auth-web-server dhcp-wpad-option.....	1883
auth-web-server host-name.....	1884
auth-web-server intercept-port.....	1885
auth-web-server ipaddress.....	1886
auth-web-server login-url.....	1888
auth-web-server page language.....	1887
auth-web-server page logo.....	1889
auth-web-server page sub-title.....	1890
auth-web-server page success-message.....	1891
auth-web-server page title.....	1892
auth-web-server page welcome-message.....	1893
auth-web-server ping-poll enable.....	1894
auth-web-server ping-poll failcount.....	1895
auth-web-server ping-poll interval.....	1896
auth-web-server ping-poll reauth-timer-refresh.....	1897

auth-web-server ping-poll timeout.....	1898
auth-web-server port	1899
auth-web-server redirect-delay-time	1900
auth-web-server redirect-url	1901
auth-web-server session-keep	1902
auth-web-server ssl intercept-port	1904
auth-web-server ssl.....	1903
autoboot enable.....	114
auto-cost reference bandwidth (IPv6 OSPF).....	1057
auto-cost reference bandwidth	945
auto-summary (BGP only).....	1142
backpressure	448
bandwidth	1059
bandwidth	947
banner exec	226
banner login (SSH).....	2517
banner login (system).....	228
banner motd	230
bgp aggregate-next-hop-check.....	1143
bgp always-compare-med	1144
bgp bestpath as-path ignore.....	1145
bgp bestpath compare-confed-aspath	1146
bgp bestpath compare-routerid.....	1147
bgp bestpath med remove-recv-med	1150
bgp bestpath med remove-send-med.....	1151
bgp bestpath med.....	1148
bgp client-to-client reflection	1152
bgp cluster-id	1153
bgp confederation identifier	1155
bgp confederation peers.....	1156
bgp config-type	1158
bgp dampening	1160
bgp damp-peer-oscillation (BGP only).....	1162
bgp default ipv4-unicast	1163
bgp default local-preference (BGP only)	1164

bgp deterministic-med	1165
bgp enforce-first-as	1167
bgp fast-external-failover	1168
bgp graceful-restart graceful-reset	1171
bgp graceful-restart	1169
bgp log-neighbor-changes	1172
bgp memory maxallocation	1174
bgp nexthop-trigger delay	1176
bgp nexthop-trigger enable	1177
bgp nexthop-trigger-count	1175
bgp rfc1771-path-select (BGP only)	1178
bgp rfc1771-strict (BGP only)	1179
bgp router-id	1180
bgp scan-time (BGP only)	1181
bgp update-delay	1182
blacklist	2736
boot config-file backup	117
boot config-file	115
boot system backup	119
boot system	118
bootfile	2333
bridge	483
bridge-group	2213
bridge-group	484
capability opaque	948
capability restart	949
category (Web Control)	2750
category action (IP Reputation)	2782
category action (IPS)	2705
cd	120
channel-group	583
chat-script	425
circuit-failover	2080
cisco-metric-behavior (RIP)	851
class (htb)	1800

class (priority)	1802
class (wrr)	1804
clear aaa local user lockout.....	1951
clear arp-cache	1477
clear arp-cache	689
clear atmf links statistics	2214
clear atmf secure-mode certificates	2215
clear atmf secure-mode statistics.....	2216
clear bgp (ASN).....	1186
clear bgp (IPv4 or IPv6 address)	1184
clear bgp *	1183
clear bgp external	1187
clear bgp ipv6 (ASN) (BGP4+ only).....	1200
clear bgp ipv6 (ipv6 address) (BGP4+ only)	1197
clear bgp ipv6 dampening (BGP4+ only).....	1198
clear bgp ipv6 external (BGP4+ only)	1201
clear bgp ipv6 flap-statistics (BGP4+ only)	1199
clear bgp ipv6 peer-group (BGP4+ only).....	1202
clear bgp peer-group	1188
clear counter ipv6 dhcp-client.....	2402
clear counter ipv6 dhcp-server	2403
clear exception log	304
clear firewall connections	2630
clear ip bgp (ASN) (BGP only).....	1194
clear ip bgp (IPv4) (BGP only).....	1191
clear ip bgp (IPv4) (BGP only).....	1481
clear ip bgp * (BGP only)	1189
clear ip bgp * (BGP only)	1479
clear ip bgp dampening (BGP only).....	1192
clear ip bgp external (BGP only)	1195
clear ip bgp flap-statistics (BGP only)	1193
clear ip bgp peer-group (BGP only).....	1196
clear ip dhcp binding	2334
clear ip dns forwarding cache	735
clear ip igmp group.....	1581

clear ip igmp interface	1582
clear ip igmp	1580
clear ip mroute pim sparse-mode	1692
clear ip mroute statistics	1661
clear ip mroute	1660
clear ip ospf process	950
clear ip pim sparse-mode bsr rp-set *	1690
clear ip pim sparse-mode packet statistics	1691
clear ip rip route	1482
clear ip rip route	852
clear ipv6 dhcp binding	2404
clear ipv6 dhcp client	2406
clear ipv6 mld group	1631
clear ipv6 mld interface	1632
clear ipv6 mld	1630
clear ipv6 mroute pim sparse-mode	1739
clear ipv6 mroute pim	1738
clear ipv6 mroute statistics	1663
clear ipv6 mroute	1662
clear ipv6 neighbors	786
clear ipv6 ospf process	1060
clear ipv6 pim sparse-mode bsr rp-set *	1740
clear ipv6 rip route	908
clear isakmp sa	2796
clear lacp counters	585
clear line console	168
clear line vty	169
clear log buffered	306
clear log external	307
clear log permanent	308
clear log	305
clear mac address-table dynamic	450
clear mac address-table static	452
clear mac-filter	485
clear ping-poll	2605

clear port counter	453
clear pppoe-ac statistics	652
clear radius local-server statistics	1999
clear spanning-tree detected protocols (RSTP and MSTP)	510
clear spanning-tree statistics	509
clear ssh	2518
clear test interface	441
client (radsecproxy-srv)	1994
client mutual-authentication	1996
client name-check	1997
client trustpoint	1998
clock set	232
clock summer-time date	233
clock summer-time recurring	235
clock timezone	237
compatible rfc1583	951
configure terminal	100
connection-limit (Firewall)	2631
connection-log events	2632
connection-log events	309
copy (filename)	121
copy buffered-log	310
copy current-software	123
copy debug	124
copy fdb-radius-users (to file)	2000
copy local-radius-user-db (from file)	2002
copy local-radius-user-db (to file)	2003
copy permanent-log	311
copy proxy-autoconfig-file	1905
copy running-config	125
copy startup-config	126
copy web-auth-https-file	1906
copy zmodem	127
create autoboot	128
critical-interval	2606

crypto ipsec profile	2797
crypto isakmp key	2799
crypto isakmp key	2847
crypto isakmp key	2891
crypto isakmp peer	2801
crypto isakmp profile	2803
crypto key destroy hostkey.....	2519
crypto key destroy userkey.....	2520
crypto key generate hostkey	2521
crypto key generate rsa	2033
crypto key generate userkey	2523
crypto key pubkey-chain knownhosts	1484
crypto key pubkey-chain knownhosts	2524
crypto key pubkey-chain userkey.....	2526
crypto key zeroize	2034
crypto pki authenticate	2035
crypto pki enroll local (deleted)	2004
crypto pki enroll local local-radius-all-users (deleted)	2005
crypto pki enroll local user (deleted).....	2006
crypto pki enroll user	2037
crypto pki enroll	2036
crypto pki export local pem (deleted)	2007
crypto pki export local pkcs12 (deleted)	2008
crypto pki export pem	2039
crypto pki export pkcs12.....	2040
crypto pki import pem	2042
crypto pki import pkcs12.....	2044
crypto pki trustpoint local (deleted)	2009
crypto pki trustpoint.....	2045
day.....	2569
ddns enable	736
ddns-update now	738
ddns-update-method.....	737
deadtime (RADIUS server group)	1969
debug aaa.....	1952

debug antivirus.....	2725
debug atmf packet	2219
debug atmf.....	2217
debug bgp (BGP only)	1203
debug crypto pki (deleted).....	2010
debug ddns	739
debug fiber-monitoring.....	282
debug firewall.....	2634
debug igmp.....	1583
debug ip dns forwarding.....	740
debug ip packet interface.....	691
debug ipv6 ospf events.....	1061
debug ipv6 ospf ifsm	1062
debug ipv6 ospf lsa.....	1063
debug ipv6 ospf nfsm.....	1064
debug ipv6 ospf packet.....	1065
debug ipv6 ospf route	1066
debug ipv6 pim sparse-mode packet.....	1743
debug ipv6 pim sparse-mode timer	1744
debug ipv6 pim sparse-mode	1741
debug ipv6 rip.....	909
debug isakmp.....	2805
debug l2tp	2893
debug lacp	586
debug mail.....	2509
debug mld	1633
debug mstp (RSTP and STP).....	511
debug nsm mcast	1664
debug nsm mcast6	1665
debug ospf events.....	952
debug ospf ifsm	953
debug ospf lsa.....	954
debug ospf nfsm	955
debug ospf nsm	956
debug ospf packet.....	957

debug ospf route	958
debug pim sparse-mode timer	1694
debug pim sparse-mode	1693
debug ping-poll	2607
debug platform packet	454
debug policy-based-routing	1454
debug ppp	609
debug pppoe-ac	653
debug radius	1970
debug rip	854
debug snmp	2470
debug ssh client	2528
debug ssh server	2529
debug traffic-control	1806
debug trigger	2571
debug vrrp events	2083
debug vrrp packet	2084
debug vrrp	2082
debug web-control	2752
default log buffered	312
default log console	313
default log email	314
default log external	315
default log host	316
default log monitor	317
default log permanent	318
default-information originate (IPv6 RIPng)	910
default-information originate (RIP)	855
default-information originate	1067
default-information originate	959
default-metric (IPv6 OSPF)	1068
default-metric (IPv6 RIPng)	911
default-metric (OSPF)	960
default-metric (RIP)	1486
default-metric (RIP)	856

default-router	2335
delete debug	130
delete mail	2510
delete	129
description (amf container)	2224
description (Authentication Profile)	1907
description (Domain List)	741
description (interface)	402
description (ping-polling)	2608
description (trigger)	2572
description (VRF)	1487
destination l2tp	654
destination	2894
dir	131
disable (Privileged Exec mode)	101
disable (VRRP)	2085
discovery	2222
distance (BGP and BGP4+)	1204
distance (IPv6 OSPF)	1069
distance (OSPF)	961
distance (RIP)	1488
distance (RIP)	857
distribute-list (IPv6 RIPng)	912
distribute-list (RIP)	1489
distribute-list (RIP)	858
dns-server (DHCPv6)	2407
dns-server	2336
do	102
domain (Domain List)	742
domain-name (DHCPv6)	2409
domain-name	2337
domain-style	2011
dpd-interval	2807
dpd-timeout	2808
dpi	2772

dport.....	2654
dscp	2656
duplex	456
echo	399
edit (filename).....	134
edit	133
egress-vlan-id	2012
egress-vlan-name.....	2013
enable (DPI)	2773
enable (NAT)	2688
enable (Privileged Exec mode)	103
enable (VRRP)	2086
enable db-summary-opt	963
enable password	170
enable secret	173
encapsulation dot1q.....	605
encapsulation ppp.....	2895
encapsulation ppp.....	426
encapsulation ppp.....	612
end	105
enrollment (trustpoint configuration mode)	2046
erase factory-default.....	135
erase factory-default.....	2225
erase proxy-autoconfig-file	1908
erase startup-config	136
erase web-auth-https-file	1909
exec-timeout.....	176
exit.....	106
exit-address-family	1206
export map.....	1490
fail-count.....	2609
fiber-monitoring action.....	284
fiber-monitoring baseline.....	285
fiber-monitoring enable	287
fiber-monitoring interval.....	288

fiber-monitoring sensitivity	289
fingerprint (trustpoint configuration mode)	2047
firewall	2633
flowcontrol (switch port)	457
flowcontrol hardware (asyn/console)	178
fullupdate (RIP)	1491
fullupdate (RIP)	859
group	2014
ha associate	2073
help	107
host (DHCP)	2338
host (Entity)	2658
host area	964
host-name (DDNS)	743
hostname	238
http secure-port	214
http-enable	2226
icmp-code	2660
icmp-type	2662
import map	1492
instance priority (MSTP)	515
instance vlan (MSTP)	517
interface (PPP)	614
interface (to configure)	403
interface (traffic-control)	1807
interface tunnel	2809
interface tunnel	2849
ip (ping-polling)	2610
ip address (Entity)	2664
ip address (GRE)	2850
ip address (IP Addressing and Protocol)	693
ip address dhcp	2339
ip address negotiated	615
ip community-list expanded	1209
ip community-list standard	1211

ip community-list.....	1207
ip ddns-update-method	744
ip dhcp bootp ignore	2341
ip dhcp leasequery enable	2342
ip dhcp option.....	2343
ip dhcp pool.....	2345
ip dhcp-client default-route distance	2346
ip dhcp-relay agent-option checking	2350
ip dhcp-relay agent-option remote-id	2352
ip dhcp-relay agent-option	2348
ip dhcp-relay information policy	2354
ip dhcp-relay maxhops	2356
ip dhcp-relay max-message-length.....	2357
ip dhcp-relay server-address	2359
ip directed-broadcast.....	695
ip dns forwarding cache	746
ip dns forwarding dead-time.....	747
ip dns forwarding domain-list.....	748
ip dns forwarding retry	749
ip dns forwarding source-interface	750
ip dns forwarding timeout	751
ip dns forwarding.....	745
ip domain-list.....	752
ip domain-lookup	753
ip domain-name.....	754
ip extcommunity-list expanded	1213
ip extcommunity-list standard	1215
ip forward-protocol udp	697
ip gratuitous-arp-link	699
ip helper-address	701
ip igmp flood specific-query	1585
ip igmp last-member-query-count	1586
ip igmp last-member-query-interval.....	1587
ip igmp maximum-groups	1588
ip igmp mroute-proxy	1590

ip igmp proxy-service	1591
ip igmp querier-timeout	1592
ip igmp query-holdtime	1593
ip igmp query-interval	1595
ip igmp query-max-response-time	1597
ip igmp ra-option	1599
ip igmp robustness-variable	1600
ip igmp snooping fast-leave	1602
ip igmp snooping mrouter	1603
ip igmp snooping querier	1604
ip igmp snooping report-suppression	1605
ip igmp snooping routermode	1606
ip igmp snooping source-timeout	1608
ip igmp snooping tcn query solicit	1609
ip igmp snooping	1601
ip igmp source-address-check	1611
ip igmp startup-query-count	1612
ip igmp startup-query-interval	1613
ip igmp trusted	1614
ip igmp version	1615
ip igmp	1584
ip limited-local-proxy-arp	2689
ip limited-local-proxy-arp	703
ip local-proxy-arp	705
ip mroute	1666
ip multicast route	1668
ip multicast route-limit	1670
ip multicast wrong-vif-suppression	1671
ip multicast-routing	1672
ip name-server	755
ip ospf authentication	965
ip ospf authentication-key	966
ip ospf cost	968
ip ospf database-filter	969
ip ospf dead-interval	970

ip ospf disable all	971
ip ospf hello-interval	972
ip ospf message-digest-key	973
ip ospf mtu	975
ip ospf mtu-ignore	976
ip ospf network	977
ip ospf priority	978
ip ospf resync-timeout	979
ip ospf retransmit-interval	980
ip ospf transmit-delay	981
ip pim anycast-rp	1696
ip pim bsr-border	1697
ip pim bsr-candidate	1698
ip pim cisco-register-checksum	1699
ip pim crp-cisco-prefix	1700
ip pim dr-priority	1701
ip pim exclude-genid	1702
ip pim ext-srcs-directly-connected	1703
ip pim hello-holdtime (PIM-SM)	1704
ip pim hello-interval (PIM-SM)	1705
ip pim ignore-rp-set-priority	1706
ip pim jp-timer	1707
ip pim register-rate-limit	1708
ip pim register-rp-reachability	1709
ip pim register-source	1710
ip pim register-suppression	1711
ip pim rp-address	1712
ip pim rp-candidate	1713
ip pim rp-register-kat	1714
ip pim sparse-mode passive	1716
ip pim sparse-mode	1715
ip pim spt-threshold	1717
ip pim ssm	1718
ip policy-route	1455
ip prefix-list (IPv4 Prefix List)	1217

ip proxy-arp	706
ip radius source-interface	1971
ip redirects	707
ip rip authentication key-chain	860
ip rip authentication mode	862
ip rip authentication string	865
ip rip receive version	868
ip rip receive-packet	867
ip rip send version 1-compatible	873
ip rip send version	870
ip rip send-packet	869
ip rip split-horizon	875
ip route static inter-vrf	1493
ip route	1494
ip route	825
ip subnet	2666
ip tacacs source-interface	2064
ip tcp adjust-mss	2852
ip tcp adjust-mss	2873
ip tcp adjust-mss	405
ip tcp adjust-mss	617
ip tcp synack-retries	708
ip tcp timeout established	2635
ip tcp timeout established	709
ip tftp source-interface	137
ip unnumbered	619
ip unreachable	710
ip vrf forwarding	1498
ip vrf	1497
ip-reputation	2784
ips	2706
ipv6 address (DHCPv6 PD)	2410
ipv6 address (Entity)	2668
ipv6 address (GRE)	2854
ipv6 address autoconfig	789

ipv6 address dhcp	2413
ipv6 address.....	787
ipv6 ddns-update-method.....	757
ipv6 dhcp client pd	2415
ipv6 dhcp option	2417
ipv6 dhcp pool	2419
ipv6 dhcp server.....	2421
ipv6 enable.....	791
ipv6 eui64-linklocal	793
ipv6 forwarding	794
ipv6 local pool.....	2422
ipv6 mld last-member-query-count	1635
ipv6 mld last-member-query-interval.....	1636
ipv6 mld querier-timeout	1637
ipv6 mld query-interval	1638
ipv6 mld query-max-response-time	1639
ipv6 mld robustness-variable	1640
ipv6 mld snooping fast-leave	1643
ipv6 mld snooping mrouter.....	1644
ipv6 mld snooping querier.....	1646
ipv6 mld snooping report-suppression	1647
ipv6 mld snooping.....	1641
ipv6 mld ssm-map enable.....	1649
ipv6 mld static-group.....	1650
ipv6 mld version.....	1652
ipv6 mld.....	1634
ipv6 mroute	1673
ipv6 multicast forward-slow-path-packet.....	795
ipv6 multicast route	1675
ipv6 multicast route-limit	1677
ipv6 multicast-routing	1678
ipv6 nd accept-ra-pinfo	796
ipv6 nd current-hoplimit.....	797
ipv6 nd managed-config-flag	799
ipv6 nd minimum-ra-interval.....	800

ipv6 nd other-config-flag	802
ipv6 nd prefix (DHCPv6).....	2424
ipv6 nd prefix.....	803
ipv6 nd ra-interval	805
ipv6 nd ra-lifetime	806
ipv6 nd reachable-time	807
ipv6 nd retransmission-time	809
ipv6 nd suppress-ra.....	811
ipv6 neighbor	812
ipv6 opportunistic-nd.....	813
ipv6 ospf authentication spi.....	1071
ipv6 ospf cost	1073
ipv6 ospf dead-interval	1075
ipv6 ospf display route single-line	1076
ipv6 ospf encryption spi esp	1077
ipv6 ospf hello-interval	1080
ipv6 ospf neighbor	1081
ipv6 ospf network	1083
ipv6 ospf priority	1084
ipv6 ospf retransmit-interval	1085
ipv6 ospf transmit-delay	1086
ipv6 pim anycast-rp.....	1746
ipv6 pim bsr-border	1748
ipv6 pim bsr-candidate	1750
ipv6 pim cisco-register-checksum	1752
ipv6 pim crp-cisco-prefix.....	1753
ipv6 pim dr-priority.....	1754
ipv6 pim exclude-genid.....	1756
ipv6 pim ext-srcs-directly-connected.....	1757
ipv6 pim hello-holdtime	1758
ipv6 pim hello-interval.....	1759
ipv6 pim ignore-rp-set-priority	1760
ipv6 pim jp-timer	1761
ipv6 pim neighbor-filter.....	1762
ipv6 pim register-rate-limit.....	1763

ipv6 pim register-rp-reachability	1764
ipv6 pim register-source	1765
ipv6 pim register-suppression.....	1766
ipv6 pim rp embedded	1770
ipv6 pim rp-address	1767
ipv6 pim rp-candidate	1769
ipv6 pim rp-register-kat.....	1771
ipv6 pim sparse-mode passive	1773
ipv6 pim sparse-mode	1772
ipv6 pim spt-threshold.....	1774
ipv6 pim ssm	1775
ipv6 pim unicast-bsm.....	1776
ipv6 policy-route	1457
ipv6 prefix-list (IPv6 Prefix List)	1219
ipv6 rip metric-offset	913
ipv6 rip split-horizon.....	915
ipv6 route	814
ipv6 route	828
ipv6 router ospf area.....	1087
ipv6 router rip.....	917
ipv6 subnet	2670
ipv6 tcp adjust-mss.....	2856
ipv6 tcp adjust-mss.....	2875
ipv6 tcp adjust-mss.....	407
ipv6 tcp adjust-mss.....	621
ipv6 tftp source-interface	138
ipv6 unreachable.....	815
ip-version	2897
keepalive (PPP)	623
key chain.....	877
key.....	876
key-string	878
l2tp peer-address dns-lookup	655
l2tp peer-address radius-lookup group.....	657
l2tp peer-address static.....	658

l2tp profile	660
l2tp tunnel	2898
l2tp unmanaged port	2900
l2tp-profile	2901
l3-filtering enable.....	1808
l3-filtering enable.....	486
lACP global-passive-mode enable	587
lACP port-priority	588
lACP system-priority.....	589
lACP timeout.....	590
lease	2361
length (asyn)	180
length (ping-poll data).....	2611
license update (filename)	208
license update online	209
lifetime (IPsec Profile)	2810
lifetime (ISAKMP Profile)	2811
line.....	181
link-address	2426
linkflap action	459
local-proxy-arp	2691
local-proxy-arp	712
local-subaddress	2902
log buffered (filter)	320
log buffered exclude.....	323
log buffered size.....	326
log buffered	319
log console (filter)	328
log console exclude	331
log console	327
log date-format.....	334
log email (filter).....	336
log email exclude.....	339
log email time	342
log email	335

log event-host.....	215
log event-host.....	2228
log external (filter).....	346
log external exclude.....	349
log external rotate.....	352
log external size.....	354
log external.....	344
log facility.....	355
log host (filter).....	359
log host exclude.....	362
log host source.....	365
log host time.....	366
log host.....	357
log monitor (filter).....	368
log monitor exclude.....	371
log permanent (filter).....	375
log permanent exclude.....	378
log permanent size.....	381
log permanent.....	374
log trustpoint.....	384
log url-requests.....	2737
log url-requests.....	385
login authentication.....	1953
logout.....	108
log-rate-limit nsm.....	382
mac address-table acquire.....	460
mac address-table ageing-time.....	461
mac address-table static.....	462
mac-filter.....	487
mac-filter-group.....	488
mac-learning.....	489
mail.....	2511
malware-protection.....	2713
match (Web-Control).....	2753
match as-path.....	1221

match as-path	1415
match community	1222
match community	1416
match interface	1418
match ip address	1419
match ip next-hop	1421
match ipv6 address	1422
match ipv6 next-hop	1423
match metric	1424
match origin	1425
match route-type	1427
match tag	1428
max-concurrent-dd (IPv6 OSPF)	1089
max-concurrent-dd	982
max-fib-routes (VRF)	1499
max-fib-routes	240
max-fib-routes	829
maximum-area	983
maximum-paths	832
maximum-prefix	879
max-paths	1224
max-static-routes (VRF)	1501
max-static-routes	242
max-static-routes	831
mirror interface	436
mkdir	139
modeltype	2229
move debug	141
move rule (Firewall)	2636
move rule (NAT)	2692
move rule (traffic-control)	1809
move rule (Web Control)	2755
move	140
mru jumbo	409
mtu (PPP)	625

mtu	410
multicast	1679
nas	2015
nat	2693
neighbor (IPv6 RIPng)	918
neighbor (OSPF)	984
neighbor (RIP)	880
neighbor activate	1225
neighbor advertisement-interval	1228
neighbor allowas-in	1231
neighbor as-origination-interval	1234
neighbor attribute-unchanged	1236
neighbor capability graceful-restart	1239
neighbor capability orf prefix-list	1242
neighbor capability route-refresh	1245
neighbor collide-established	1248
neighbor default-originate	1250
neighbor description	1253
neighbor disallow-infinite-holdtime	1256
neighbor dont-capability-negotiate	1258
neighbor ebgp-multihop	1261
neighbor enforce-multihop	1264
neighbor filter-list	1267
neighbor interface	1270
neighbor local-as	1271
neighbor maximum-prefix	1273
neighbor next-hop-self	1276
neighbor next-hop-self	1502
neighbor override-capability	1279
neighbor passive	1281
neighbor password	1283
neighbor password	1508
neighbor peer-group (add a neighbor)	1287
neighbor peer-group (create a peer-group)	1289
neighbor port	1290

neighbor prefix-list	1292
neighbor remote-as	1295
neighbor remote-as	1505
neighbor remove-private-AS (BGP only)	1298
neighbor restart-time	1300
neighbor route-map	1302
neighbor route-reflector-client (BGP only)	1306
neighbor route-server-client (BGP only)	1308
neighbor send-community	1309
neighbor shutdown	1312
neighbor soft-reconfiguration inbound	1314
neighbor timers	1317
neighbor transparent-as	1320
neighbor transparent-next-hop	1322
neighbor unsuppress-map	1324
neighbor update-source	1327
neighbor version (BGP only)	1330
neighbor weight	1332
network (BGP and BGP4+)	1335
network (DHCP)	2363
network (Entity)	2672
network (RIP)	1512
network (RIP)	881
network area	985
network synchronization	1338
next-server	2364
no crypto pki certificate	2049
no debug all	243
no debug isakmp	2812
normal-interval	2612
ntp authenticate	2446
ntp authentication-key	2447
ntp broadcastdelay	2448
ntp discard	2449
ntp master	2450

ntp peer.....	2451
ntp restrict	2453
ntp server	2455
ntp source.....	2457
ntp trusted-key (deprecated).....	2459
optimistic-nd.....	713
option (DHCPv6).....	2428
option.....	2365
ospf abr-type.....	987
ospf restart grace-period.....	988
ospf restart helper	989
ospf router-id.....	991
overflow database external	993
overflow database.....	992
passive-interface (IPv6 OSPF).....	1090
passive-interface (IPv6 RIPng)	919
passive-interface (OSPF)	994
passive-interface (RIP)	1514
passive-interface (RIP)	883
password (DDNS).....	758
peer default ip address	626
peer neighbor-route	628
pfs	2813
ping ipv6.....	816
ping.....	1515
ping.....	714
ping-poll	2613
polarity.....	463
policy (traffic-control).....	1810
policy-based-routing enable	1460
policy-based-routing	1459
ppp authentication refuse	632
ppp authentication	630
ppp hostname.....	634
ppp ipcp dns suffix-list.....	638

ppp ipcp dns suffix-list.....	761
ppp ipcp dns	636
ppp ipcp dns	759
ppp ipcp ip-override	640
ppp password	641
ppp service-name (PPPoE)	642
ppp timeout idle.....	643
ppp username.....	644
ppp-auth-protocol.....	662
pppoe-ac.....	663
pppoe-ac-service	664
preempt-mode	2087
prefix-delegation pool	2430
priority	2089
privilege level	183
probe enable	2367
probe packets	2368
probe timeout.....	2369
probe type	2370
protect (Antivirus)	2726
protect (Firewall)	2637
protect (IP Reputation).....	2785
protect (IPS)	2707
protect (Malware Protection).....	2714
protect (URL filtering).....	2738
protect (Web Control).....	2756
protection ipsec	2903
protection local-name	2904
protection profile.....	2906
protection remote-name.....	2907
protocol.....	2674
provider digitalarts	2757
provider kaspersky (Antivirus).....	2727
provider kaspersky (Malware Protection)	2715
provider kaspersky	2739

provider procera.....	2774
provider proofpoint (IP Reputation).....	2786
proxy-auth.....	665
proxy-port.....	1954
pwd.....	142
radius-secure-proxy aaa.....	1955
radius-secure-proxy local-server.....	2016
radius-server deadtime.....	1972
radius-server host.....	1973
radius-server key.....	1976
radius-server local.....	2017
radius-server retransmit.....	1977
radius-server timeout.....	1979
range.....	2371
rd (route distinguisher).....	1517
reboot.....	245
recv-buffer-size (IPv6 RIPng).....	920
recv-buffer-size (RIP).....	884
red-curve.....	1812
redistribute (into BGP or BGP4+).....	1339
redistribute (into BGP or BGP4+).....	1518
redistribute (IPv6 OSPF).....	1091
redistribute (IPv6 RIPng).....	921
redistribute (OSPF).....	1520
redistribute (OSPF).....	995
redistribute (RIP).....	1522
redistribute (RIP).....	885
region (MSTP).....	519
reload.....	246
remote-subaddress.....	2909
repeat.....	2573
restart bgp graceful (BGP only).....	1341
restart ipv6 ospf graceful.....	1093
restart ospf graceful.....	997
restart rip graceful.....	887

retry-interval (DDNS).....	763
revision (MSTP)	520
rip restart grace-period	888
rmdir.....	143
route (IPv6 RIPng)	922
route (RIP).....	1524
route (RIP).....	889
route.....	2372
route-map.....	1343
route-map.....	1429
router bgp	1342
router ipv6 ospf	1094
router ipv6 rip.....	923
router ipv6 vrrp (interface)	2091
router ospf	1527
router ospf	998
router rip.....	890
router vrrp (interface).....	2093
router-id (IPv6 OSPF).....	1095
router-id (VRF).....	1529
router-id	1000
route-target	1525
rsakeypair (trustpoint configuration mode).....	2050
rule (Firewall).....	2638
rule (MAC Filter)	490
rule (NAT)	2694
rule (traffic-control).....	1814
rule (Web Control).....	2758
sample-size.....	2614
script.....	2574
security-password forced-change	185
security-password history.....	184
security-password lifetime	186
security-password minimum-categories.....	188
security-password minimum-length.....	189

security-password min-lifetime-enforce	187
security-password reject-expired-pwd	190
security-password warning	191
send-lifetime	891
server (radsecproxy-aaa)	1956
server (Server Group)	1981
server auth-port	2018
server enable	2019
server mutual-authentication	1958
server name-check	1959
server trustpoint	1960
service advanced-vty	192
service dhcp-relay	2373
service dhcp-server	2374
service http	216
service password-encryption	193
service ssh	2530
service telnet	194
service terminal-length (deleted)	195
service test	442
service-name	666
set aggregator	1432
set as-path	1346
set as-path	1433
set atomic-aggregate	1434
set comm-list delete	1435
set community	1347
set community	1436
set dampening	1438
set extcommunity	1440
set ip next-hop (route map)	1442
set ipv6 next-hop	1443
set local-preference	1444
set metric	1445
set metric-type	1447

set origin	1448
set originator-id	1449
set tag	1450
set weight	1451
shared-secret	2910
show aaa local user locked	1962
show aaa server group	1963
show antivirus statistics	2729
show antivirus	2728
show application detail	2677
show application	2676
show arp	1530
show arp	716
show atmf area guests	2237
show atmf area guests-detail	2239
show atmf area nodes	2241
show atmf area nodes-detail	2243
show atmf area summary	2245
show atmf area	2234
show atmf authorization	2246
show atmf backup area	2253
show atmf backup guest	2255
show atmf backup	2249
show atmf container	2257
show atmf detail	2260
show atmf group members	2264
show atmf group	2262
show atmf guests detail	2268
show atmf guests	2266
show atmf links detail	2273
show atmf links guest detail	2284
show atmf links guest	2282
show atmf links statistics	2288
show atmf links	2271
show atmf nodes	2291

show atmf provision nodes	2293
show atmf secure-mode audit link	2297
show atmf secure-mode audit	2296
show atmf secure-mode certificates	2298
show atmf secure-mode sa	2301
show atmf secure-mode statistics	2304
show atmf secure-mode	2294
show atmf tech	2306
show atmf virtual-links	2309
show atmf working-set	2311
show atmf	2230
show auth diagnostics	1911
show auth interface	1912
show auth sessionstatistics	1915
show auth statistics interface	1916
show auth supplicant interface	1920
show auth supplicant	1917
show auth	1910
show auth-web-server page	1922
show auth-web-server	1921
show autoboot	144
show banner login	2532
show bgp ipv6 (BGP4+ only)	1349
show bgp ipv6 community (BGP4+ only)	1350
show bgp ipv6 community-list (BGP4+ only)	1352
show bgp ipv6 dampening (BGP4+ only)	1353
show bgp ipv6 filter-list (BGP4+ only)	1354
show bgp ipv6 inconsistent-as (BGP4+ only)	1355
show bgp ipv6 longer-prefixes (BGP4+ only)	1356
show bgp ipv6 neighbors (BGP4+ only)	1357
show bgp ipv6 paths (BGP4+ only)	1360
show bgp ipv6 prefix-list (BGP4+ only)	1361
show bgp ipv6 quote-regexp (BGP4+ only)	1362
show bgp ipv6 regexp (BGP4+ only)	1363
show bgp ipv6 route-map (BGP4+ only)	1364

show bgp ipv6 summary (BGP4+ only)	1365
show bgp memory maxallocation (BGP only)	1366
show bgp nexthop-tracking (BGP only)	1367
show bgp nexthop-tree-details (BGP only)	1368
show boot	145
show bridge macaddr	494
show bridge	492
show cellular	428
show clock	247
show connection-log events	2640
show connection-log events	386
show counter dhcp-client	2375
show counter dhcp-relay	2376
show counter dhcp-server	2380
show counter ipv6 dhcp-client	2432
show counter ipv6 dhcp-server	2434
show counter log	387
show counter mail	2512
show counter ntp (deprecated)	2460
show counter ping-poll	2616
show counter snmp-server	2471
show cpu history	252
show cpu	249
show crypto key hostkey	2533
show crypto key mypubkey rsa	2051
show crypto key pubkey-chain knownhosts	1533
show crypto key pubkey-chain knownhosts	2535
show crypto key pubkey-chain userkey	2537
show crypto key userkey	2538
show crypto pki certificates (deleted)	2020
show crypto pki certificates local-radius-all-users (deleted)	2021
show crypto pki certificates user (deleted)	2022
show crypto pki certificates	2052
show crypto pki enrollment user	2054
show crypto pki trustpoint	2055

show crypto pki trustpoints (deleted)	2023
show ddns-update-method status	764
show debugging aaa	1964
show debugging antivirus	2730
show debugging atmf packet	2313
show debugging atmf	2312
show debugging bgp (BGP only)	1369
show debugging firewall	2648
show debugging igmp	1616
show debugging ip dns forwarding	765
show debugging ip packet	719
show debugging ipv6 ospf	1096
show debugging ipv6 pim sparse-mode	1777
show debugging ipv6 rip	924
show debugging isakmp	2815
show debugging l2tp	2911
show debugging lacp	592
show debugging mld	1653
show debugging mstp	521
show debugging ospf	1001
show debugging pim sparse-mode	1719
show debugging platform packet	464
show debugging ppp	645
show debugging pppoe ac	668
show debugging radius	1983
show debugging rip	893
show debugging snmp	2475
show debugging traffic-control	1816
show debugging trigger	2576
show debugging vrrp	2095
show debugging web-control	2761
show debugging	254
show dhcp lease	2382
show diagnostic channel-group	593
show dpi statistics	2776

show dpi	2775
show entity	2680
show etherchannel detail	595
show etherchannel summary	596
show etherchannel	594
show exception log	388
show file systems	148
show file	147
show firewall connections limits config-check	2644
show firewall connections limits	2643
show firewall connections	2642
show firewall rule config-check	2647
show firewall rule	2645
show firewall	2641
show flowcontrol interface	465
show history	109
show hosts	766
show http	217
show interface (PPP)	646
show interface brief	416
show interface err-disabled	466
show interface memory	255
show interface memory	417
show interface status	419
show interface switchport	467
show interface tunnel (GRE)	2858
show interface tunnel (IPsec)	2816
show interface tunnel (L2TPv3)	2912
show interface tunnel (OpenVPN)	2877
show interface	412
show ip bgp (BGP only)	1370
show ip bgp attribute-info (BGP only)	1371
show ip bgp cidr-only (BGP only)	1372
show ip bgp cidr-only (BGP only)	1535
show ip bgp community (BGP only)	1373

show ip bgp community (BGP only)	1536
show ip bgp community-info (BGP only).....	1375
show ip bgp community-list (BGP only).....	1376
show ip bgp community-list (BGP only).....	1538
show ip bgp dampening (BGP only)	1377
show ip bgp dampening (BGP only)	1539
show ip bgp filter-list (BGP only)	1379
show ip bgp filter-list (BGP only)	1541
show ip bgp inconsistent-as (BGP only).....	1380
show ip bgp inconsistent-as (BGP only).....	1542
show ip bgp longer-prefixes (BGP only).....	1381
show ip bgp longer-prefixes (BGP only).....	1543
show ip bgp neighbors (BGP only)	1382
show ip bgp neighbors connection-retrytime (BGP only).....	1385
show ip bgp neighbors hold-time (BGP only)	1386
show ip bgp neighbors keepalive (BGP only)	1387
show ip bgp neighbors keepalive-interval (BGP only)	1388
show ip bgp neighbors notification (BGP only).....	1389
show ip bgp neighbors open (BGP only).....	1390
show ip bgp neighbors rcvd-msgs (BGP only).....	1391
show ip bgp neighbors sent-msgs (BGP only).....	1392
show ip bgp neighbors update (BGP only).....	1393
show ip bgp paths (BGP only)	1394
show ip bgp prefix-list (BGP only)	1395
show ip bgp prefix-list (BGP only)	1544
show ip bgp quote-regexp (BGP only)	1396
show ip bgp quote-regexp (BGP only).....	1545
show ip bgp regexp (BGP only).....	1398
show ip bgp regexp (BGP only).....	1547
show ip bgp route-map (BGP only)	1400
show ip bgp route-map (BGP only)	1549
show ip bgp scan (BGP only)	1401
show ip bgp summary (BGP only)	1402
show ip bgp summary (BGP only)	1550
show ip community-list.....	1404

show ip dhcp binding.....	2384
show ip dhcp pool.....	2386
show ip dhcp server statistics	2392
show ip dhcp server summary	2394
show ip dhcp-relay	2390
show ip dns forwarding cache	768
show ip dns forwarding server	770
show ip dns forwarding.....	767
show ip domain-list.....	772
show ip domain-name.....	773
show ip extcommunity-list.....	1405
show ip forwarding.....	721
show ip igmp groups	1617
show ip igmp interface	1619
show ip igmp proxy.....	1621
show ip igmp snooping mrouter	1622
show ip igmp snooping routermode	1623
show ip igmp snooping source-timeout	1624
show ip igmp snooping statistics.....	1625
show ip interface vrf	1552
show ip interface vrf	723
show ip interface	722
show ip mroute.....	1680
show ip mvif.....	1682
show ip name-server.....	774
show ip ospf border-routers.....	1005
show ip ospf database asbr-summary	1008
show ip ospf database external	1009
show ip ospf database network	1011
show ip ospf database nssa-external	1012
show ip ospf database opaque-area.....	1014
show ip ospf database opaque-as	1015
show ip ospf database opaque-link.....	1016
show ip ospf database router	1017
show ip ospf database summary	1019

show ip ospf database	1006
show ip ospf interface	1022
show ip ospf neighbor	1023
show ip ospf route.....	1025
show ip ospf virtual-links.....	1026
show ip ospf.....	1002
show ip pbr route.....	1461
show ip pim sparse-mode bsr-router	1720
show ip pim sparse-mode interface detail	1723
show ip pim sparse-mode interface	1721
show ip pim sparse-mode local-members	1724
show ip pim sparse-mode mroute detail.....	1727
show ip pim sparse-mode mroute.....	1725
show ip pim sparse-mode neighbor	1729
show ip pim sparse-mode nexthop.....	1730
show ip pim sparse-mode packet statistics	1731
show ip pim sparse-mode rp mapping	1733
show ip pim sparse-mode rp-hash	1732
show ip prefix-list (IPv4 Prefix List).....	1406
show ip protocols bgp (BGP only)	1407
show ip protocols ospf.....	1027
show ip protocols rip	894
show ip rip database.....	896
show ip rip interface	897
show ip rip vrf database.....	1554
show ip rip vrf database.....	898
show ip rip vrf interface.....	1555
show ip rip vrf interface.....	899
show ip rip	895
show ip route database.....	1559
show ip route database.....	836
show ip route summary.....	1562
show ip route summary.....	839
show ip route.....	1556
show ip route.....	833

show ip rpf	1683
show ip sockets.....	725
show ip traffic	728
show ip vrf detail	1565
show ip vrf interface	1566
show ip vrf	1564
show ip-reputation categories	2788
show ip-reputation	2787
show ips categories.....	2709
show ips.....	2708
show ipsec counters	2817
show ipsec peer	2818
show ipsec policy.....	2819
show ipsec profile	2820
show ipsec sa.....	2822
show ipv6 dhcp binding	2437
show ipv6 dhcp interface	2440
show ipv6 dhcp pool	2442
show ipv6 dhcp	2436
show ipv6 forwarding.....	817
show ipv6 interface brief.....	818
show ipv6 mif	1687
show ipv6 mld groups	1654
show ipv6 mld interface	1655
show ipv6 mld snooping mrouter	1656
show ipv6 mld snooping statistics.....	1657
show ipv6 mroute	1684
show ipv6 multicast forwarding.....	1686
show ipv6 neighbors	819
show ipv6 ospf database external	1101
show ipv6 ospf database grace.....	1102
show ipv6 ospf database inter-prefix	1103
show ipv6 ospf database inter-router.....	1104
show ipv6 ospf database intra-prefix	1105
show ipv6 ospf database link.....	1106

show ipv6 ospf database network	1107
show ipv6 ospf database router	1109
show ipv6 ospf database	1099
show ipv6 ospf interface	1114
show ipv6 ospf neighbor	1116
show ipv6 ospf route	1118
show ipv6 ospf virtual-links	1120
show ipv6 ospf	1097
show ipv6 pbr route	1463
show ipv6 pim sparse-mode bsr-router	1778
show ipv6 pim sparse-mode interface detail	1781
show ipv6 pim sparse-mode interface	1779
show ipv6 pim sparse-mode local-members	1782
show ipv6 pim sparse-mode mroute detail	1786
show ipv6 pim sparse-mode mroute	1784
show ipv6 pim sparse-mode neighbor	1788
show ipv6 pim sparse-mode nexthop	1789
show ipv6 pim sparse-mode rp mapping	1791
show ipv6 pim sparse-mode rp nexthop	1792
show ipv6 pim sparse-mode rp-hash	1790
show ipv6 prefix-list (IPv6 Prefix List)	1408
show ipv6 protocols rip	925
show ipv6 rip database	927
show ipv6 rip interface	928
show ipv6 rip	926
show ipv6 route summary	822
show ipv6 route summary	843
show ipv6 route	820
show ipv6 route	841
show isakmp counters	2823
show isakmp key (GRE)	2859
show isakmp key (IPsec)	2824
show isakmp key (L2TPv3)	2913
show isakmp peer	2825
show isakmp profile	2826

show isakmp sa	2828
show l2tp session	2914
show l2tp tunnel config-check	2920
show l2tp tunnel	2916
show lacp sys-id	597
show lacp-counter	598
show license external	211
show log config	391
show log external	393
show log permanent	394
show log	389
show mac address-table	468
show mac-filter	495
show mail	2513
show malware-protection	2716
show memory allocations	259
show memory history	261
show memory pools	262
show memory shared	263
show memory	257
show mirror interface	439
show mirror	438
show nat rule config-check	2701
show nat rule	2699
show nat	2698
show ntp associations	2461
show ntp counters associations	2465
show ntp counters	2463
show ntp status	2467
show openvpn connections detail	2879
show openvpn connections	2878
show pbr rules	1465
show ping-poll	2618
show platform port	471
show platform	470

show port etherchannel	599
show pppoe-ac config-check.....	669
show pppoe-ac connections	671
show pppoe-ac statistics.....	673
show privilege.....	196
show process.....	264
show proxy-autoconfig-file	1923
show radius local-server group.....	2024
show radius local-server nas	2025
show radius local-server statistics	2026
show radius local-server user.....	2027
show radius server group	1965
show radius	1984
show reboot history	266
show resource.....	220
show route-map.....	1409
show route-map.....	1452
show router-id.....	267
show running-config antivirus	2731
show running-config atmf	2314
show running-config dpi.....	2777
show running-config firewall.....	2649
show running-config interface	154
show running-config ip-reputation.....	2790
show running-config ips	2711
show running-config l2tp-profile.....	2922
show running-config l2tp-tunnel.....	2923
show running-config log.....	395
show running-config malware-protection	2717
show running-config nat.....	2702
show running-config pppoe-ac	676
show running-config router ipv6 vrrp	2096
show running-config router vrrp	2097
show running-config snmp	2476
show running-config ssh.....	2539

show running-config traffic-control	1817
show running-config trigger	2577
show running-config url-filter	2740
show running-config vrf	1567
show running-config web-control	2762
show running-config	150
show security-password configuration	197
show security-password user	198
show snmp-server community	2478
show snmp-server group	2479
show snmp-server user	2480
show snmp-server view	2481
show snmp-server	2477
show spanning-tree brief	525
show spanning-tree mst config	527
show spanning-tree mst detail interface	530
show spanning-tree mst detail interface	535
show spanning-tree mst detail	528
show spanning-tree mst instance interface	533
show spanning-tree mst instance	532
show spanning-tree mst interface	534
show spanning-tree mst	526
show spanning-tree statistics instance interface	540
show spanning-tree statistics instance	539
show spanning-tree statistics interface	542
show spanning-tree statistics	537
show spanning-tree vlan range-index	544
show spanning-tree	522
show ssh client	2543
show ssh server allow-users	2546
show ssh server deny-users	2547
show ssh server	2544
show ssh	2541
show startup-config	156
show static-channel-group	600

show storm-control.....	476
show system environment.....	269
show system fiber-monitoring.....	291
show system interrupts.....	270
show system mac.....	271
show system pci device.....	272
show system pci tree.....	273
show system pluggable detail.....	296
show system pluggable diagnostics.....	299
show system pluggable.....	294
show system serialnumber.....	274
show system usb.....	431
show system.....	268
show tacacs+.....	2065
show tech-support.....	275
show telnet.....	199
show traffic-control counters.....	1819
show traffic-control interface.....	1821
show traffic-control policy.....	1823
show traffic-control red-curve.....	1825
show traffic-control rule config-check.....	1827
show traffic-control rule.....	1828
show traffic-control.....	1829
show trigger.....	2578
show url-filter.....	2741
show users.....	200
show version.....	157
show vlan.....	497
show vrrp (session).....	2104
show vrrp counters.....	2100
show vrrp ipv6.....	2103
show vrrp.....	2098
show web-control categories.....	2765
show web-control rules.....	2767
show web-control.....	2763

shutdown	421
snmp trap link-status suppress	2484
snmp trap link-status	2482
snmp-server community	2488
snmp-server contact	2489
snmp-server enable trap	2490
snmp-server engineID local reset	2494
snmp-server engineID local	2492
snmp-server group	2495
snmp-server host	2497
snmp-server legacy-ifadminstatus	2499
snmp-server location	2500
snmp-server source-interface	2501
snmp-server startup-trap-delay	2502
snmp-server user	2503
snmp-server view	2506
snmp-server	2486
sntp-address	2444
source	2924
source-ip	2622
spanning-tree autoedge (RSTP and MSTP)	545
spanning-tree cisco-interoperability (MSTP)	546
spanning-tree edgeport (RSTP and MSTP)	547
spanning-tree enable	548
spanning-tree errdisable-timeout enable	550
spanning-tree errdisable-timeout interval	551
spanning-tree force-version	552
spanning-tree forward-time	553
spanning-tree guard root	554
spanning-tree hello-time	555
spanning-tree link-type	556
spanning-tree max-age	557
spanning-tree max-hops (MSTP)	558
spanning-tree mode	559
spanning-tree mst configuration	560

spanning-tree mst instance path-cost	562
spanning-tree mst instance priority	564
spanning-tree mst instance restricted-role.....	565
spanning-tree mst instance restricted-tcn	567
spanning-tree mst instance	561
spanning-tree path-cost	568
spanning-tree portfast (STP)	569
spanning-tree portfast bpdu-filter.....	571
spanning-tree portfast bpdu-guard	573
spanning-tree priority (bridge priority)	575
spanning-tree priority (port priority).....	576
spanning-tree restricted-role.....	577
spanning-tree restricted-tcn	578
spanning-tree transmit-holdcount	579
speed (asyn).....	277
speed	477
sport.....	2682
ssh client.....	2550
ssh server allow-users.....	2554
ssh server authentication	2556
ssh server deny-users	2558
ssh server max-auth-tries	2560
ssh server resolve-host.....	2561
ssh server scp.....	2562
ssh server sftp	2563
ssh server	2552
ssh	1568
ssh	2548
state	2315
static-channel-group	601
storm-control level	479
sub-class (htb).....	1830
sub-class (priority)	1832
sub-class (wrr).....	1834
subject-name (trustpoint configuration).....	2056

subnet-mask	2395
sub-sub-class (htb).....	1836
sub-sub-class (priority).....	1838
sub-sub-class (wrr).....	1840
summary-address (IPv6 OSPF).....	1121
summary-address	1028
suppress-ipv4-updates (DDNS).....	776
switchport access vlan	498
switchport atmf-agentlink	2317
switchport atmf-arealink remote-area	2318
switchport atmf-crosslink	2320
switchport atmf-guestlink.....	2322
switchport atmf-link	2324
switchport mode access	499
switchport mode trunk	500
switchport trunk allowed vlan.....	501
switchport trunk native vlan	504
synchronization	1410
tacacs-server host	2067
tacacs-server key	2069
tacacs-server timeout.....	2070
tcpdump.....	1570
tcpdump.....	730
telnet server.....	202
telnet	1571
telnet	201
terminal length.....	203
terminal monitor	279
terminal resize.....	204
test interface	443
test	2583
time (trigger)	2584
timeout (ping polling)	2624
timers (BGP)	1411
timers (IPv6 RIPng).....	929

timers (RIP)	1572
timers (RIP)	900
timers spf (IPv6 OSPF) (deprecated)	1123
timers spf exp (IPv6 OSPF)	1124
timers spf exp	1029
traceroute ipv6	823
traceroute	1574
traceroute	731
traffic-control enable	1842
traffic-control	1843
transform (IPsec Profile)	2829
transform (ISAKMP Profile)	2830
transition-mode	2106
trap	2586
trigger activate	2588
trigger	2587
tunnel checksum	2860
tunnel destination (GRE)	2862
tunnel destination (IPsec)	2832
tunnel dscp	2861
tunnel local id	2925
tunnel local name (GRE)	2864
tunnel local name (IPsec)	2834
tunnel local selector	2835
tunnel mode (GRE)	2865
tunnel mode (IPsec)	2837
tunnel mode (L2TPv3)	2926
tunnel mode openvpn tap	2883
tunnel mode openvpn tun	2884
tunnel openvpn authentication	2880
tunnel openvpn cipher	2881
tunnel openvpn expiry-bytes	2885
tunnel openvpn expiry-seconds	2886
tunnel openvpn port	2887
tunnel openvpn tagging	2888

tunnel protection ipsec (GRE)	2866
tunnel protection ipsec (IPsec)	2838
tunnel protection ipsec	2927
tunnel remote id.....	2928
tunnel remote name (GRE)	2867
tunnel remote name (IPsec).....	2839
tunnel remote selector.....	2840
tunnel source (GRE).....	2868
tunnel source (IPsec).....	2842
tunnel ttl	2870
type atmf node	2325
type atmf node	2589
type card.....	2592
type cpu	2593
type interface	2594
type memory.....	2595
type periodic	2596
type ping-poll	2597
type reboot	2598
type time.....	2599
type usb.....	2600
undebug (DDNS)	777
undebug aaa	1967
undebug all ipv6 pim sparse-mode.....	1794
undebug all pim sparse-mode	1734
undebug all	280
undebug atmf.....	2328
undebug bgp (BGP only).....	1412
undebug igmp	1627
undebug ip packet interface	732
undebug ipv6 ospf events	1125
undebug ipv6 ospf ifsm.....	1126
undebug ipv6 ospf lsa	1127
undebug ipv6 ospf nfsm	1128
undebug ipv6 ospf packet	1129

undebg ipv6 ospf route.....	1130
undebg ipv6 pim sparse-mode	1795
undebg ipv6 rip	930
undebg isakmp	2844
undebg lacp	603
undebg mail	2514
undebg mstp	580
undebg ospf events	1030
undebg ospf ifsm.....	1031
undebg ospf lsa	1032
undebg ospf nfsm.....	1033
undebg ospf nsm	1034
undebg ospf packet	1035
undebg ospf route	1036
undebg ping-poll	2626
undebg platform packet.....	480
undebg ppp	650
undebg radius	1987
undebg rip.....	902
undebg snmp.....	2507
undebg ssh client	2564
undebg ssh server.....	2565
undebg trigger.....	2601
undebg vrrp events	2109
undebg vrrp packet	2110
undebg vrrp	2108
unmount.....	162
unmount.....	396
up-count.....	2625
update now	222
update webgui now	218
update webgui now	223
update-interval (Antivirus)	2732
update-interval (Application Control)	2778
update-interval (DDNS).....	778

update-interval (IP Reputation).....	2791
update-interval (Malware Protection).....	2718
update-interval (URL Filtering)	2742
update-url (DDNS).....	779
url-filter reload custom-lists.....	2744
url-filter	2745
usb mode-switch	433
use-ipv4-for-ipv6-updates (DDNS).....	782
user (RADIUS server)	2029
username (DDNS).....	783
username	205
username	2329
version (ISAKMP)	2845
version (RIP)	1575
version (RIP)	903
version	2929
virtual-ip	2111
virtual-ipv6	2113
vlan (RADIUS server)	2031
vlan database	506
vlan	505
vrrp vmac	2115
wait	400
web-control	2768
whitelist.....	2746
write file.....	163
write memory	164
write terminal	165
zone	2684

Part 1: Setup and Troubleshooting

1

CLI Navigation Commands

Introduction

Overview This chapter provides an alphabetical reference for the commands used to navigate between different modes. This chapter also provides a reference for the help and show commands used to help navigate within the CLI.

- Command List**
- [“configure terminal”](#) on page 100
 - [“disable \(Privileged Exec mode\)”](#) on page 101
 - [“do”](#) on page 102
 - [“enable \(Privileged Exec mode\)”](#) on page 103
 - [“end”](#) on page 105
 - [“exit”](#) on page 106
 - [“help”](#) on page 107
 - [“logout”](#) on page 108
 - [“show history”](#) on page 109

configure terminal

Overview This command enters the Global Configuration command mode.

Syntax `configure terminal`

Mode Privileged Exec

Example To enter the Global Configuration command mode (note the change in the command prompt), enter the command:

```
awplus# configure terminal
awplus(config)#
```

disable (Privileged Exec mode)

Overview This command exits the Privileged Exec mode, returning the prompt to the User Exec mode. To end a session, use the [exit](#) command.

Syntax `disable`

Mode Privileged Exec

Example To exit the Privileged Exec mode, enter the command:

```
awplus# disable
awplus>
```

Related Commands

- [enable \(Privileged Exec mode\)](#)
- [end](#)
- [exit](#)

do

Overview This command lets you to run User Exec and Privileged Exec mode commands when you are in any configuration mode.

Syntax `do <command>`

Parameter	Description
<code><command></code>	Specify the command and its parameters.

Mode Any configuration mode

Example
`awplus# configure terminal`
`awplus(config)# do ping 192.0.2.23`

enable (Privileged Exec mode)

Overview This command enters the Privileged Exec mode and optionally changes the privilege level for a session. If a privilege level is not specified then the maximum privilege level (15) is applied to the session. If the optional privilege level is omitted then only users with the maximum privilege level can access Privileged Exec mode without providing the password as specified by the [enable password](#) or [enable secret](#) commands. If no password is specified then only users with the maximum privilege level set with the [username](#) command can assess Privileged Exec mode.

Syntax `enable [<privilege-level>]`

Parameter	Description
<code><privilege - level></code>	Specify the privilege level for a CLI session in the range <1-15>, where 15 is the maximum privilege level, 7 is the intermediate privilege level and 1 is the minimum privilege level. The privilege level for a user must match or exceed the privilege level set for the CLI session for the user to access Privileged Exec mode. Privilege level for a user is configured by username .

Mode User Exec

Usage Many commands are available from the Privileged Exec mode that configure operating parameters for the device, so you should apply password protection to the Privileged Exec mode to prevent unauthorized use. Passwords can be encrypted but then cannot be recovered. Note that non-encrypted passwords are shown in plain text in configurations.

The [username](#) command sets the privilege level for the user. After login, users are given access to privilege level 1. Users access higher privilege levels with the [enable \(Privileged Exec mode\)](#) command. If the privilege level specified is higher than the users configured privilege level specified by the [username](#) command, then the user is prompted for the password for that level.

Note that a separate password can be configured for each privilege level using the [enable password](#) and the [enable secret](#) commands from the Global Configuration mode. The [service password-encryption](#) command encrypts passwords configured by the [enable password](#) and the [enable secret](#) commands, so passwords are not shown in plain text in configurations.

Example The following example shows the use of the **enable** command to enter the Privileged Exec mode (note the change in the command prompt).

```
awplus> enable  
awplus#
```

The following example shows the **enable** command enabling access the Privileged Exec mode for users with a privilege level of 7 or greater. Users with a privilege level of 7 or greater do not need to enter a password to access Privileged Exec mode. Users with a privilege level 6 or less need to enter a password to access

Privilege Exec mode. Use the [enable password](#) command or the [enable secret](#) commands to set the password to enable access to Privileged Exec mode.

```
awplus> enable 7  
awplus#
```

**Related
Commands**

[disable \(Privileged Exec mode\)](#)
[enable password](#)
[enable secret](#)
[exit](#)
[service password-encryption](#)
[username](#)

end

Overview This command returns the prompt to the Privileged Exec command mode from any other advanced command mode.

Syntax end

Mode All advanced command modes, including Global Configuration and Interface Configuration modes.

Example The following example shows the use of the **end** command to return to the Privileged Exec mode directly from Interface mode.

```
awplus# configure terminal
awplus(config)# interface eth1
awplus(config-if)# end
awplus#
```

Related Commands

- disable (Privileged Exec mode)
- enable (Privileged Exec mode)
- exit

exit

Overview This command exits the current mode, and returns the prompt to the mode at the previous level. When used in User Exec mode, the **exit** command terminates the session.

Syntax `exit`

Mode All command modes, including Global Configuration and Interface Configuration modes.

Example The following example shows the use of the **exit** command to exit Interface mode, and return to Configure mode.

```
awplus# configure terminal
awplus(config)# interface eth1
awplus(config-if)# exit
awplus(config)#
```

Related Commands

- [disable \(Privileged Exec mode\)](#)
- [enable \(Privileged Exec mode\)](#)
- [end](#)

help

Overview This command displays a description of the AlliedWare Plus™ OS help system.

Syntax help

Mode All command modes

Example To display a description on how to use the system help, use the command:

```
awplus# help
```

Output Figure 1-1: Example output from the **help** command

```
When you need help at the command line, press '?'.

If nothing matches, the help list will be empty. Delete
characters until entering a '?' shows the available options.

Enter '?' after a complete parameter to show remaining valid
command parameters (e.g. 'show ?').

Enter '?' after part of a parameter to show parameters that
complete the typed letters (e.g. 'show ip?').
```

logout

Overview This command exits the User Exec or Privileged Exec modes and ends the session.

Syntax `logout`

Mode User Exec and Privileged Exec

Example To exit the User Exec mode, use the command:

```
awplus# logout
```

show history

Overview This command lists the commands entered in the current session. The history buffer is cleared automatically upon reboot.

The output lists all command line entries, including commands that returned an error.

For information on filtering and saving command output, see the [“Getting Started with AlliedWare Plus” Feature Overview and Configuration Guide](#).

Syntax `show history`

Mode User Exec and Privileged Exec

Example To display the commands entered during the current session, use the command:

```
awplus# show history
```

Output Figure 1-2: Example output from the **show history** command

```
1 en
2 show ru
3 conf t
4 route-map er deny 3
5 exit
6 ex
7 di
```

2

File and Configuration Management Commands

Introduction

Overview This chapter provides an alphabetical reference of AlliedWare Plus™ OS file and configuration management commands.

Filename Syntax and Keyword Usage Many of the commands in this chapter use the placeholder “filename” to represent the name and location of the file that you want to act on. The following table explains the syntax of the filename for each different type of file location.

When you copy a file...	Use this syntax:	Example:
Copying in local Flash memory	<code>flash: [/] [<directory> /] <filename></code>	To specify a file in the configs directory in Flash: <code>flash:configs/example.cfg</code>
Copying to or from an SD (or SDHC) card	<code>card: [/] [<directory> /] <filename></code>	To specify a file in the top-level directory of the SD card: <code>card:example.cfg</code>
Copying to or from a USB storage device	<code>usb: [/] [<directory> /] <filename></code>	To specify a file in the top-level directory of the USB stick: <code>usb:example.cfg</code>
Copying with HTTP	<code>http:// [[<username> : <password>] @] { <hostname> <host-ip> } [/ <filepath>] / <filename></code>	To specify a file in the configs directory on the server: <code>http://www.company.com/configs/example.cfg</code>
Copying with TFTP	<code>tftp:// [[<location>] / <directory>] / <filename></code>	To specify a file in the top-level directory of the server: <code>tftp://172.1.1.1/example.cfg</code>

When you copy a file...	Use this syntax:	Example:
Copying with SCP	<code>scp://<username>@<location>[/<directory>] [/<filename>]</code>	To specify a file in the configs directory on the server, logging on as user "bob": e.g. <code>scp://bob@10.10.0.12/configs/example.cfg</code>
Copying with SFTP	<code>sftp://[[<location>]/<directory>] /<filename></code>	To specify a file in the top-level directory of the server: <code>sftp://10.0.0.5/example.cfg</code>

Valid characters The filename and path can include characters from up to four categories. The categories are:

- 1) uppercase letters: A to Z
- 2) lowercase letters: a to z
- 3) digits: 0 to 9
- 4) special symbols: most printable ASCII characters not included in the previous three categories, including the following characters:

- -
- /
- .
- _
- @
- "
- '
- *
- :
- ~
- ?

Do not use spaces, parentheses or the + symbol within filenames. Use hyphens or underscores instead.

Syntax for directory listings

A leading slash (/) indicates the root of the current filesystem location.

In commands where you need to specify the local filesystem's Flash base directory, you may use **flash** or **flash:** or **flash:/**. For example, these commands are all the same:

- `dir flash`
- `dir flash:`
- `dir flash:/`

Similarly, you can specify the SD (or SDHC) card base directory with **card** or **card:** or **card:/**

Similarly, you can specify the USB storage device base directory with **usb** or **usb:** or **usb:/**

You cannot name a directory or subdirectory **flash**, **nvs**, **usb**, **card**, **tftp**, **scp**, **sftp** or **http**. These keywords are reserved for tab completion when using various file commands.

- Command List**
- [“autoboot enable”](#) on page 114
 - [“boot config-file”](#) on page 115
 - [“boot config-file backup”](#) on page 117
 - [“boot system”](#) on page 118
 - [“boot system backup”](#) on page 119
 - [“cd”](#) on page 120
 - [“copy \(filename\)”](#) on page 121
 - [“copy current-software”](#) on page 123
 - [“copy debug”](#) on page 124
 - [“copy running-config”](#) on page 125
 - [“copy startup-config”](#) on page 126
 - [“copy zmodem”](#) on page 127
 - [“create autoboot”](#) on page 128
 - [“delete”](#) on page 129
 - [“delete debug”](#) on page 130
 - [“dir”](#) on page 131
 - [“edit”](#) on page 133
 - [“edit \(filename\)”](#) on page 134
 - [“erase factory-default”](#) on page 135
 - [“erase startup-config”](#) on page 136
 - [“ip tftp source-interface”](#) on page 137
 - [“ipv6 tftp source-interface”](#) on page 138
 - [“mkdir”](#) on page 139
 - [“move”](#) on page 140
 - [“move debug”](#) on page 141
 - [“pwd”](#) on page 142
 - [“rmdir”](#) on page 143
 - [“show autoboot”](#) on page 144
 - [“show boot”](#) on page 145

- [“show file”](#) on page 147
- [“show file systems”](#) on page 148
- [“show running-config”](#) on page 150
- [“show running-config interface”](#) on page 154
- [“show startup-config”](#) on page 156
- [“show version”](#) on page 157
- [“unmount”](#) on page 162
- [“write file”](#) on page 163
- [“write memory”](#) on page 164
- [“write terminal”](#) on page 165

autoboot enable

Overview This command enables the device to restore a release file and/or a configuration file from external media, such as a USB storage device.

When the Autoboot feature is enabled, the device looks for a special file called `autoboot.txt` on the external media. If this file exists, the device will check the key and values in the file and recover the device with a new release file and/or configuration file from the external media. An example of a valid `autoboot.txt` file is shown in the following figure.

Figure 2-1: Example `autoboot.txt` file

```
[AlliedWare Plus]
Copy_from_external_media_enabled=yes
Boot_Release=AR4050S-5.4.7-1.1.rel
Boot_Config=network1.cfg
```

Use the **no** variant of this command to disable the Autoboot feature.

Syntax `autoboot enable`
`no autoboot enable`

Default The Autoboot feature operates the first time the device is powered up in the field, after which the feature is disabled by default.

Mode Global Configuration

Example To enable the Autoboot feature, use the command:

```
awplus# configure terminal
awplus# configure terminal
awplus(config)# no autoboot enable
```

Related Commands [create autoboot](#)
[show autoboot](#)
[show boot](#)

boot config-file

Overview Use this command to set the configuration file to use during the next boot cycle. Use the **no** variant of this command to remove the configuration file.

Syntax `boot config-file <filepath-filename>`
`no boot config-file`

Parameter	Description
<code><filepath-filename></code>	Filepath and name of a configuration file. The specified configuration file must exist in the specified filesystem. Valid configuration files must have a .cfg extension.

Mode Global Configuration

Usage You can only specify that the configuration file is on external memory (an SD card or USB storage device) if there is a backup configuration file already specified in Flash. If you attempt to set the configuration file on external memory and a backup configuration file is not specified in Flash, the following error message is displayed:

```
% Backup configuration files must be stored in the flash filesystem
```

In addition, you can only specify that the configuration file is on an SD card if the card is writable.

For an explanation of the configuration fallback order, see the [File Management Feature Overview and Configuration Guide](#).

Examples To run the configuration file "branch.cfg" stored on the device's Flash filesystem the next time the device boots up, use the commands:

```
awplus# configure terminal  
awplus(config)# boot config-file flash:/branch.cfg
```

To stop running the configuration file "branch.cfg" stored on the device's Flash filesystem when the device boots up, use the commands:

```
awplus# configure terminal  
awplus(config)# no boot config-file flash:/branch.cfg
```

To run the configuration file "branch.cfg" stored on the device's SD card filesystem the next time the device boots up, use the commands:

```
awplus# configure terminal  
awplus(config)# boot config-file card:/branch.cfg
```

To stop running the configuration file “branch.cfg” stored on the device’s SD card filesystem when the device boots up, use the commands:

```
awplus# configure terminal
awplus(config)# no boot config-file card:/branch.cfg
```

**Related
Commands**

- [boot config-file backup](#)
- [boot system](#)
- [boot system backup](#)
- [show boot](#)

boot config-file backup

Overview Use this command to set a backup configuration file to use if the main configuration file cannot be accessed.

Use the **no** variant of this command to remove the backup configuration file.

Syntax `boot config-file backup <filepath-filename>`
`no boot config-file backup`

Parameter	Description
<code><filepath-filename></code>	Filepath and name of a backup configuration file. Backup configuration files must be in the Flash filesystem. Valid backup configuration files must have a .cfg extension.
<code>backup</code>	The specified file is a backup configuration file.

Mode Global Configuration

Usage For an explanation of the configuration fallback order, see the [File Management Feature Overview and Configuration Guide](#).

Examples To set the configuration file `backup.cfg` as the backup to the main configuration file, use the commands:

```
awplus# configure terminal
awplus(config)# boot config-file backup flash:/backup.cfg
```

To remove the configuration file `backup.cfg` as the backup to the main configuration file, use the commands:

```
awplus# configure terminal
awplus(config)# no boot config-file backup flash:/backup.cfg
```

Related Commands

- [boot config-file](#)
- [boot system](#)
- [boot system backup](#)
- [show boot](#)

boot system

Overview Use this command to set the release file to load during the next boot cycle.

Use the **no** variant of this command to stop specifying a primary release file to boot from. If the device boots up with no release file set, it will use autoboot or the backup release file if either of those are configured, or you can use the boot menu to select a release file source. To access the boot menu, type Ctrl-B at bootup.

Syntax `boot system <filepath-filename>`
`no boot system`

Parameter	Description
<code><filepath-filename></code>	Filepath and name of a release file. The specified release file must exist and must be stored in the root directory of the specified filesystem. Valid release files must have a .rel extension.

Mode Global Configuration

Usage You can only specify that the release file is on external memory (an SD card or USB storage device) if there is a backup release file already specified in Flash. If you attempt to set the release file on external memory and a backup release file is not specified in Flash, an error message like the following one is displayed:

```
% A backup boot image must be set before setting a current boot image on card
```

Examples To boot up with the release AR4050S-5.4.7-1.1.rel file, which is stored on the device's Flash filesystem, the next time the device boots up, use the commands:

```
awplus# configure terminal  
awplus(config)# boot system flash:/AR4050S-5.4.7-1.1.rel
```

To run the release file AR4050S-5.4.7-1.1.rel, which is stored on the device's SD card filesystem, the next time the device boots up, use the commands:

```
awplus# configure terminal  
awplus(config)# boot system card:/AR4050S-5.4.7-1.1.rel
```

Related Commands

- [boot config-file](#)
- [boot config-file backup](#)
- [boot system backup](#)
- [show boot](#)

boot system backup

Overview Use this command to set a backup release file to load if the main release file cannot be loaded.

Use the **no** variant of this command to stop specifying a backup release file.

Syntax `boot system backup <filepath-filename>`
`no boot system backup`

Parameter	Description
<code><filepath-filename></code>	Filepath and name of a backup release file. Backup release files must be in the Flash filesystem. Valid release files must have a .rel extension.
<code>backup</code>	The specified file is a backup release file.

Mode Global Configuration

Examples To specify the file AR4050S-5.4.7-0.1.rel as the backup to the main release file, use the commands:

```
awplus# configure terminal  
awplus(config)# boot system backup flash:/AR4050S-5.4.7-0.1.rel
```

To stop specifying a backup to the main release file, use the commands:

```
awplus# configure terminal  
awplus(config)# no boot system backup
```

Related Commands [boot config-file](#)
[boot config-file backup](#)
[boot system](#)
[show boot](#)

cd

Overview This command changes the current working directory.

Syntax `cd <directory-name>`

Parameter	Description
<code><directory-name></code>	Name and path of the directory.

Mode Privileged Exec

Example To change to the directory called `images`, use the command:

```
awplus# cd images
```

Related Commands

- `dir`
- `pwd`
- `show file systems`

copy (filename)

Overview This command copies a file. This allows you to:

- copy files from your device to a remote device
- copy files from a remote device to your device
- copy files stored on Flash memory to or from a different memory type, such as a USB storage device
- create two copies of the same file on your device

Syntax `copy [force] <source-name> <destination-name>`

Parameter	Description
<code>force</code>	This parameter forces the copy command to overwrite the destination file, if it already exists, without prompting the user for confirmation. If you specify force , you can copy files to multiple AMF nodes through a working-set.
<code><source-name></code>	The filename and path of the source file. See Introduction on page 110 for valid syntax.
<code><destination-name></code>	The filename and path for the destination file. See Introduction on page 110 for valid syntax.

Mode Privileged Exec

Examples To use TFTP to copy the file "bob.key" into the current directory from the remote server at 10.0.0.1, use the command:

```
awplus# copy tftp://10.0.0.1/bob.key bob.key
```

To use SFTP to copy the file "new.cfg" into the current directory from a remote server at 10.0.1.2, use the command:

```
awplus# copy sftp://10.0.1.2/new.cfg bob.key
```

To use SCP with the username "beth" to copy the file old.cfg into the directory config_files on a remote server that is listening on TCP port 2000, use the command:

```
awplus# copy scp://beth@serv:2000/config_files/old.cfg old.cfg
```

To copy the file "newconfig.cfg" onto your device's Flash from an SD (or SDHC) Card, use the command:

```
awplus# copy card:/newconfig.cfg flash:/newconfig.cfg
```

To copy the file "newconfig.cfg" onto your device's Flash from a USB storage device, use the command:

```
awplus# copy usb:/newconfig.cfg flash:/newconfig.cfg
```

To copy the file "newconfig.cfg" to an SD (or SDHC) Card from your device's Flash, use the command:

```
awplus# copy flash:/newconfig.cfg card:/newconfig.cfg
```

To copy the file "newconfig.cfg" to a USB storage device from your device's Flash, use the command:

```
awplus# copy flash:/newconfig.cfg usb:/newconfig.cfg
```

To copy the file "config.cfg" into the current directory from a USB storage device, and rename it to "configtest.cfg", use the command:

```
awplus# copy usb:/config.cfg configtest.cfg
```

To copy the file "config.cfg" into the current directory from a remote file server, and rename it to "configtest.cfg", use the command:

```
awplus# copy fserver:/config.cfg configtest.cfg
```

On an AMF managed network to distribute the file "file.txt" to the top level of Flash memory on all nodes from the top level of Flash memory on the node named "master", use the commands:

```
awplus# atmf working-set group all
```

```
network-name[80]# copy force master.atmf/flash:/file.txt flash:
```

**Related
Commands**

[copy zmodem](#)

[copy buffered-log](#)

[copy permanent-log](#)

[edit \(filename\)](#)

[show file systems](#)

copy current-software

Overview This command copies the AlliedWare Plus™ OS software that the device has booted from, to a destination file.

Syntax `copy current-software <destination-name>`

Parameter	Description
<code><destination-name></code>	The filename and path where you would like the current running-release saved. This command creates a file if no file exists with the specified filename. If a file already exists, then the CLI prompts you before overwriting the file. See Introduction on page 110 for valid syntax.

Mode Privileged Exec

Example To copy the current software as installed in the working directory with the file name `my-release.rel`, use the command:

```
awplus# copy current-software my-release.rel
```

Related Commands [boot system backup](#)
[show boot](#)

copy debug

Overview This command copies a specified debug file to a destination file.

Syntax copy debug
{<destination-name>|card|debug|flash|nvs|scp|tftp|usb}
{<source-name>|debug|flash|nvs|scp|tftp|usb}

Parameter	Description
<destination-name>	The filename and path where you would like the debug output saved. See Introduction on page 110 for valid syntax.
<source-name>	The filename and path where the debug output originates. See Introduction on page 110 for valid syntax.

Mode Privileged Exec

Example To copy debug output to an SD (or SDHC) card with a filename “my-debug”, use the following command:

```
awplus# copy debug card:my-debug
```

To copy debug output to a USB storage device with a filename “my-debug”, use the following command:

```
awplus# copy debug usb:my-debug
```

Output Figure 2-2: CLI prompt after entering the **copy debug** command

```
Enter source file name []:
```

Related Commands delete debug
move debug

copy running-config

Overview This command copies the running-config to a destination file, or copies a source file into the running-config. Commands entered in the running-config do not survive a device reboot unless they are saved in a configuration file.

Syntax `copy <source-name> running-config`
`copy running-config [<destination-name>]`
`copy running-config startup-config`

Parameter	Description
<code><source-name></code>	The filename and path of a configuration file. This must be a valid configuration file with a .cfg filename extension. Specify this when you want the script in the file to become the new running-config. See Introduction on page 110 for valid syntax.
<code><destination-name></code>	The filename and path where you would like the current running-config saved. This command creates a file if no file exists with the specified filename. If a file already exists, then the CLI prompts you before overwriting the file. See Introduction on page 110 for valid syntax. If you do not specify a file name, the device saves the running-config to a file called default.cfg.
<code>startup-config</code>	Copies the running-config into the file set as the current startup-config file.

Mode Privileged Exec

Examples To copy the `running-config` into the `startup-config`, use the command:

```
awplus# copy running-config startup-config
```

To copy the file `layer3.cfg` into the `running-config`, use the command:

```
awplus# copy layer3.cfg running-config
```

To use SCP to copy the `running-config` as `current.cfg` to the remote server listening on TCP port 2000, use the command:

```
awplus# copy running-config  
scp://user@server:2000/config_files/current.cfg
```

Related Commands [copy startup-config](#)
[write file](#)
[write memory](#)

copy startup-config

Overview This command copies the startup-config script into a destination file, or alternatively copies a configuration script from a source file into the startup-config file.

Syntax `copy <source-name> startup-config`
`copy startup-config <destination-name>`

Parameter	Description
<code><source-name></code>	The filename and path of a configuration file. This must be a valid configuration file with a .cfg filename extension. Specify this to copy the script in the file into the startup-config file. Note that this does not make the copied file the new startup file, so any further changes made in the configuration file are not added to the startup-config file unless you reuse this command. See Introduction on page 110 for valid syntax.
<code><destination-name></code>	The destination and filename that you are saving the startup-config as. This command creates a file if no file exists with the specified filename. If a file already exists, then the CLI prompts you before overwriting the file. See Introduction on page 110 for valid syntax.

Mode Privileged Exec

Examples To copy the file `Layer3.cfg` to the `startup-config`, use the command:

```
awplus# copy Layer3.cfg startup-config
```

To copy the `startup-config` as the file `oldconfig.cfg` in the current directory, use the command:

```
awplus# copy startup-config oldconfig.cfg
```

Related Commands [copy running-config](#)

copy zmodem

Overview This command allows you to copy files using ZMODEM using Minicom. ZMODEM works over a serial connection and does not need any interfaces configured to do a file transfer.

Syntax `copy <source-name> zmodem`
`copy zmodem`

Parameter	Description
<code><source-name></code>	The filename and path of the source file. See Introduction on page 110 for valid syntax.

Mode Privileged Exec

Example To copy the local file `asuka.key` using ZMODEM, use the command:

```
awplus# copy asuka.key zmodem
```

Related Commands [copy \(filename\)](#)
[show file systems](#)

create autoboot

Overview Use this command to create an `autoboot.txt` file on external media. This command will automatically ensure that the keys and values that are expected in this file are correct. After the file is created the **create autoboot** command will copy the current release and configuration files across to the external media. The external media is then available to restore a release file and/or a configuration file to the device.

Syntax `create autoboot card`
`create autoboot usb`

Mode Privileged Exec

Example To create an `autoboot.txt` file on an SD card, use the command:

```
awplus# create autoboot card
```

To create an `autoboot.txt` file on a USB storage device, use the command:

```
awplus# create autoboot usb
```

Related Commands [autoboot enable](#)
[show autoboot](#)
[show boot](#)

delete

Overview This command deletes files or directories.

Syntax delete [force] [recursive] <filename>

Parameter	Description
force	Ignore nonexistent filenames and never prompt before deletion.
recursive	Remove the contents of directories recursively.
<filename>	The filename and path of the file to delete. See Introduction on page 110 for valid syntax.

Mode Privileged Exec

Examples To delete the file `temp.cfg` from the current directory, use the command:

```
awplus# delete temp.cfg
```

To delete the read-only file `one.cfg` from the current directory, use the command:

```
awplus# delete force one.cfg
```

To delete the directory `old_configs`, which is not empty, use the command:

```
awplus# delete recursive old_configs
```

To delete the directory `new_configs`, which is not empty, without prompting if any read-only files are being deleted, use the command:

```
awplus# delete force recursive new_configs
```

Related Commands [erase startup-config](#)
[rmdir](#)

delete debug

Overview Use this command to delete a specified debug output file.

Syntax `delete debug <source-name>`

Parameter	Description
<code><source-name></code>	The filename and path where the debug output originates. See Introduction on page 110 for valid URL syntax.

Mode Privileged Exec

Example To delete debug output, use the following command:

```
awplus# delete debug
```

Output Figure 2-3: CLI prompt after entering the **delete debug** command

```
Enter source file name []:
```

**Related
Commands** [copy debug](#)
[move debug](#)

dir

Overview This command lists the files on a filesystem. If no directory or file is specified then this command lists the files in the current working directory.

Syntax `dir [all] [recursive] [sort [reverse] [name|size|time]] [<filename>|card|debug|flash|nvs|usb]`

Parameter	Description
all	List all files.
recursive	List the contents of directories recursively.
sort	Sort directory listing.
reverse	Sort using reverse order.
name	Sort by name.
size	Sort by size.
time	Sort by modification time (default).
<filename>	The name of the directory or file. If no directory or file is specified, then this command lists the files in the current working directory.
card	SD (or SDHC) card root directory
debug	Debug root directory
flash	Flash memory root directory
nvs	NVS memory root directory
usb	USB storage device root directory

Mode Privileged Exec

Examples To list the files in the current working directory, use the command:

```
awplus# dir
```

To list the non-hidden files in the root of the Flash filesystem, use the command:

```
awplus# dir flash
```

To list all the files in the root of the Flash filesystem, use the command:

```
awplus# dir all flash:
```

To list recursively the files in the Flash filesystem, use the command:

```
awplus# dir recursive flash:
```

To list the files in alphabetical order, use the command:

```
awplus# dir sort name
```

To list the files by size, smallest to largest, use the command:

```
awplus# dir sort reverse size
```

To sort the files by modification time, oldest to newest, use the command:

```
awplus# dir sort reverse time
```

Output Figure 2-4: Example output from the **dir** command

```
awplus#dir
  630 -rw- May 19 2016 23:36:31  example.cfg
23652123 -rw- May 17 2016 03:41:18
  149 -rw- Feb  9 2016 00:40:35  exception.log
```

**Related
Commands** [cd](#)
[pwd](#)

edit

Overview This command opens a text file in the AlliedWare Plus™ text editor. Once opened you can use the editor to alter to the file.

If a filename is specified and it already exists, then the editor opens it in the text editor.

If no filename is specified, the editor prompts you for one when you exit it.

Before starting the editor make sure your terminal, terminal emulation program, or Telnet client is 100% compatible with a VT100 terminal. The editor uses VT100 control sequences to display text on the terminal.

For more information about using the editor, including control sequences, see the [File Management Feature Overview and Configuration Guide](#).

Syntax `edit [<filename>]`

Parameter	Description
<code><filename></code>	Name of a file in the local Flash filesystem.

Mode Privileged Exec

Examples To create and edit a new text file, use the command:

```
awplus# edit
```

To edit the existing configuration file `myconfig.cfg` stored on your device's Flash memory, use the command:

```
awplus# edit myconfig.cfg
```

Related Commands [edit \(filename\)](#)
[show file](#)

edit (filename)

Overview This command opens a remote text file as read-only in the AlliedWare Plus™ text editor.

Before starting the editor make sure your terminal, terminal emulation program, or Telnet client is 100% compatible with a VT100 terminal. The editor uses VT100 control sequences to display text on the terminal.

Syntax `edit <filename>`

Parameter	Description
<code><filename></code>	The filename and path of the remote file. See Introduction on page 110 for valid syntax.

Mode Privileged Exec

Example To view the file `bob.key` stored in the security directory of a TFTP server, use the command:

```
awplus# edit tftp://security/bob.key
```

Related Commands

- [copy \(filename\)](#)
- [edit](#)
- [show file](#)

erase factory-default

Overview This command erases all data from NVS and all data from Flash **excluding** the following:

- the current release file
- the backup release file
- license files

The device is then rebooted and returned to its factory default condition. The device can then be used for AMF automatic node recovery.

Syntax `erase factory-default`

Mode Privileged Exec.

Usage This command is an alias to the [atmf cleanup](#) command.

Example To erase data, use the command:

```
Node_1# erase factory-default
```

```
This command will erase all NVS, all flash contents except for  
the boot release, and any license files, and then reboot the  
switch. Continue? (y/n):y
```

**Related
Commands** [atmf cleanup](#)

erase startup-config

Overview This command deletes the file that is set as the startup-config file, which is the configuration file that the system runs when it boots up.

At the next restart, the device loads the default configuration file, default.cfg. If default.cfg no longer exists, then the device loads with the factory default configuration. This provides a mechanism for you to return the device to the factory default settings.

Syntax `erase startup-config`

Mode Privileged Exec

Example To delete the file currently set as the startup-config, use the command:

```
awplus# erase startup-config
```

Related Commands

- [boot config-file backup](#)
- [copy running-config](#)
- [copy startup-config](#)
- [show boot](#)

ip tftp source-interface

Overview Use this command to manually specify the IP address that all TFTP requests originate from. This is useful in network configurations where TFTP servers only accept requests from certain devices, or where the server cannot dynamically determine the source of the request.

Use the **no** variant of this command to stop specifying a source.

Syntax `ip tftp source-interface [<interface>|<ip-add>]`
`no ip tftp source-interface`

Parameter	Description
<code><interface></code>	The interface that TFTP requests originate from. The device will use the IP address of this interface as its source IP address. You can specify any interface that can have an IP address attached to it (e.g. a VLAN, PPP or Eth interface).
<code><ip-add></code>	The IP address that TFTP requests originate from, in dotted decimal format

Default There is no default source specified.

Mode Global Configuration

Usage This command is helpful in network configurations where TFTP traffic needs to traverse point-to-point links or subnets within your network, and you do not want to propagate those point-to-point links through your routing tables.

In those circumstances, the TFTP server cannot dynamically determine the source of the TFTP request, and therefore cannot send the requested data to the correct device. Specifying a source interface or address enables the TFTP server to send the data correctly.

Example To specify that TFTP requests originate from the IP address 192.0.2.1, use the following commands:

```
awplus# configure terminal
awplus(config)# ip tftp source-interface 192.0.2.1
```

Related Commands [copy \(filename\)](#)

ipv6 tftp source-interface

Overview Use this command to manually specify the IPv6 address that all TFTP requests originate from. This is useful in network configurations where TFTP servers only accept requests from certain devices, or where the server cannot dynamically determine the source of the request.

Use the **no** variant of this command to stop specifying a source.

Syntax `ipv6 tftp source-interface [<interface>|<ipv6-add>]`
`no ipv6 tftp source-interface`

Parameter	Description
<code><interface></code>	The interface that TFTP requests originate from. The device will use the IPv6 address of this interface as its source IPv6 address. You can specify any interface that can have an IPv6 address attached to it (e.g. a VLAN, PPP or Eth interface).
<code><ipv6-add></code>	The IPv6 address that TFTP requests originate from, in the format x:x:x:x, for example, 2001:db8::8a2e:7334.

Default There is no default source specified.

Mode Global Configuration

Usage This command is helpful in network configurations where TFTP traffic needs to traverse point-to-point links or subnets within your network, and you do not want to propagate those point-to-point links through your routing tables.

In those circumstances, the TFTP server cannot dynamically determine the source of the TFTP request, and therefore cannot send the requested data to the correct device. Specifying a source interface or address enables the TFTP server to send the data correctly.

Example To specify that TFTP requests originate from the IPv6 address 2001:db8::8a2e:7334, use the following commands:

```
awplus# configure terminal
awplus(config)# ipv6 tftp source-interface 2001:db8::8a2e:7334
```

Related Commands [copy \(filename\)](#)

mkdir

Overview This command makes a new directory.

Syntax `mkdir <name>`

Parameter	Description
<code><name></code>	The name and path of the directory that you are creating.

Mode Privileged Exec

Usage You cannot name a directory or subdirectory **flash**, **nvs**, **usb**, **card**, **tftp**, **scp**, **sftp** or **http**. These keywords are reserved for tab completion when using various file commands.

Example To make a new directory called `images` in the current directory, use the command:

```
awplus# mkdir images
```

**Related
Commands** `cd`
`dir`
`pwd`

move

Overview This command renames or moves a file.

Syntax `move <source-name> <destination-name>`

Parameter	Description
<code><source-name></code>	The filename and path of the source file. See Introduction on page 110 for valid syntax.
<code><destination-name></code>	The filename and path of the destination file. See Introduction on page 110 for valid syntax.

Mode Privileged Exec

Examples To rename the file `temp.cfg` to `startup.cfg`, use the command:

```
awplus# move temp.cfg startup.cfg
```

To move the file `temp.cfg` from the root of the Flash filesystem to the directory `myconfigs`, use the command:

```
awplus# move temp.cfg myconfigs/temp.cfg
```

**Related
Commands** [delete](#)
[edit](#)

[show file](#)

[show file systems](#)

move debug

Overview This command moves a specified debug file to a destination debug file.

Syntax `move debug {<destination-name>|card|debug|nvs|flash|usb}`

Parameter	Description
<code><destination-name></code>	The filename and path where you would like the debug output moved to. See Introduction on page 110 for valid syntax.

Mode Privileged Exec

Example To move debug output onto an SD (or SDHC) card with a filename “my-debug”, use the following command:

```
awplus# move debug card:my-debug
```

To move debug output onto a USB storage device with a filename “my-debug”, use the following command:

```
awplus# move debug usb:my-debug
```

Output Figure 2-5: CLI prompt after entering the **move debug** command

```
Enter source file name []:
```

Related Commands
[copy debug](#)
[delete debug](#)

pwd

Overview This command prints the current working directory.

Syntax `pwd`

Mode Privileged Exec

Example To print the current working directory, use the command:

```
awplus# pwd
```

**Related
Commands** `cd`

rmdir

Overview This command removes a directory. This command only works on empty directories, unless you specify the optional **force** keyword.

Syntax `rmdir [force] <name>`

Parameter	Description
<code>force</code>	Optional keyword that allows you to delete directories that are not empty and contain files or subdirectories.
<code><name></code>	The name and path of the directory.

Mode Privileged Exec

Usage You can use the CLI to access filesystems on a specific external memory device. See the [Introduction](#) on page 110 for syntax details.

Examples To remove the directory “images” from the top level of the Flash filesystem, use the command:

```
awplus# rmdir flash:/images
```

To create a directory called “level1” containing a subdirectory called “level2”, and then force the removal of both directories, use the commands:

```
awplus# mkdir level1
awplus# mkdir level1/level2
awplus# rmdir force level1
```

Related Commands

- [cd](#)
- [dir](#)
- [mkdir](#)
- [pwd](#)

show autoboot

Overview This command displays the Autoboot configuration and status.

Syntax show autoboot

Mode Privileged Exec

Example To show the Autoboot configuration and status, use the command:

```
awplus# show autoboot
```

Output Figure 2-6: Example output from the **show autoboot** command

```
awplus#show autoboot
Autoboot configuration
-----
Autoboot status           : enabled
USB file autoboot.txt exists : yes

Restore information on USB
Autoboot enable in autoboot.txt : yes
Restore release file       : AR4050S-5.4.7-1.1.rel (file exists)
Restore configuration file  : network_1.cfg (file exists)
```

Figure 2-7: Example output from the **show autoboot** command when an external media source is not present

```
awplus#show autoboot
Autoboot configuration
-----
Autoboot status           : disabled
External media source     : media not found.
```

Related Commands [autoboot enable](#)
[create autoboot](#)
[show boot](#)

show boot

Overview This command displays the current boot configuration. We recommend that the currently running release is set as the current boot image.

Syntax show boot

Mode Privileged Exec

Example To show the current boot configuration, use the command:

```
awplus# show boot
```

Output Figure 2-8: Example output from **show boot** when the current boot config is on an SD card

```
awplus#show boot
Boot configuration
-----
Current software   : AR4050S-5.4.7-1.1.rel
Current boot image : card:/AR4050S-5.4.7-1.1.rel
Backup boot image  : flash:/AR4050S-5.4.7-0.1.rel
Default boot config: flash:/default.cfg
Current boot config: card:/my.cfg (file exists)
Backup boot config: flash:/backup.cfg (file not found)
Autoboot status    : enabled
```

Figure 2-9: Example output from **show boot** when the current boot config is on a USB storage device

```
awplus#show boot
Boot configuration
-----
Current software   : AR4050S-5.4.7-1.1.rel
Current boot image : usb:/AR4050S-5.4.7-1.1.rel
Backup boot image  : flash:/AR4050S-5.4.7-0.1.rel
Default boot config: flash:/default.cfg
Current boot config: usb:/my.cfg (file exists)
Backup boot config: flash:/backup.cfg (file not found)
Autoboot status    : enabled
```

Table 2-1: Parameters in the output from **show boot**

Parameter	Description
Current software	The current software release that the device is using.
Current boot image	The boot image currently configured for use during the next boot cycle.

Table 2-1: Parameters in the output from **show boot** (cont.)

Parameter	Description
Backup boot image	The boot image to use during the next boot cycle if the device cannot load the main image.
Default boot config	The default startup configuration file. The device loads this configuration script if no file is set as the startup-config file.
Current boot config	The configuration file currently configured as the startup-config file. The device loads this configuration file during the next boot cycle if this file exists.
Backup boot config	The configuration file to use during the next boot cycle if the main configuration file cannot be loaded.
Autoboot status	The status of the Autoboot feature; either enabled or disabled.

**Related
Commands**

- [autoboot enable](#)
- [boot config-file backup](#)
- [boot system backup](#)
- [show autoboot](#)

show file

Overview This command displays the contents of a specified file.

Syntax `show file <filename>`

Parameter	Description
<code><filename></code>	Name of a file on the local Flash filesystem, or name and directory path of a file.

Mode Privileged Exec

Example To display the contents of the file `oldconfig.cfg`, which is in the current directory, use the command:

```
awplus# show file oldconfig.cfg
```

Related Commands

- [edit](#)
- [edit \(filename\)](#)
- [show file systems](#)

show file systems

Overview This command lists the filesystems and their utilization information where appropriate.

Syntax `show file systems`

Mode Privileged Exec

Examples To display the filesystems, use the command:

```
awplus# show file systems
```

Output Figure 2-10: Example output from the **show file systems** command

```
awplus#show file systems
Size (b)  Free (b)  Type  Flags  Prefixes  S/D/V  Lcl/Ntwk  Avail
-----
 63.0M    28.5M    flash  rw    flash:    static  local      Y
-         -        system rw    system:    virtual local      -
 10.0M     9.8M    debug  rw    debug:    static  local      Y
499.0K    431.0K   nvs    rw    nvs:      static  local      Y
-         -        tftp   rw    tftp:     -       network    -
-         -        scp    rw    scp:      -       network    -
-         -        sftp   ro    sftp:     -       network    -
-         -        http   ro    http:     -       network    -
-         -        rsync  rw    rsync:    -       network    -
```

Table 3: Parameters in the output of the **show file systems** command

Parameter	Description
Size (B) Available	The total memory available to this filesystem. The units are given after the value and are M for Megabytes or k for kilobytes.
Free (B)	The total memory free within this filesystem. The units are given after the value and are M for Megabytes or k for kilobytes.
Type	The memory type used for this filesystem; one of: flash system tftp scp sftp http.
Flags	The file setting options: rw (read write), ro (read only).

Table 3: Parameters in the output of the **show file systems** command (cont.)

Parameter	Description
Prefixes	The prefixes used when entering commands to access the filesystems; one of: flash system tftp scp sftp http.
S/V/D	The memory type: static, virtual, dynamic.
Lcl / Ntwk	Whether the memory is located locally or via a network connection.
Avail	Whether the memory is accessible: Y (yes), N (no), - (not applicable)

Related Commands

- [edit](#)
- [edit \(filename\)](#)
- [show file](#)

show running-config

Overview This command displays the current configuration of your device. Its output includes all non-default configuration. The default settings are not displayed.

NOTE: You can control the output by entering `|` or `>` at the end of the command:

- To display only lines that contain a particular word, enter:
`| include <word>`
- To start the display at the first line that contains a particular word, enter:
`| begin <word>`
- To save the output to a file, enter:
`> <filename>`

Syntax `show running-config [full|<feature>]`

Parameter	Description																												
full	Display the running-config for all features. This is the default setting, so it is the same as entering show running-config .																												
<feature>	Display only the configuration for a single feature. The features available depend on your device and will be some of the following list: <table border="1"><tbody><tr><td>access-list</td><td>ACL configuration</td></tr><tr><td>antivirus</td><td>Antivirus configuration</td></tr><tr><td>application</td><td>Application configuration</td></tr><tr><td>as-path</td><td>Autonomous system path filter configuration</td></tr><tr><td>as-path access-list</td><td>Configuration of ACLs for AS path filtering</td></tr><tr><td>atmf</td><td>Allied Telesis Management Framework configuration</td></tr><tr><td>bgp</td><td>Border Gateway Protocol (BGP) configuration</td></tr><tr><td>community-list</td><td>Community-list configuration</td></tr><tr><td>crypto</td><td>Security-specific configuration</td></tr><tr><td>dhcp</td><td>DHCP configuration</td></tr><tr><td>dpi</td><td>Deep Packet Inspection configuration</td></tr><tr><td>entity</td><td>Entity configuration</td></tr><tr><td>firewall</td><td>Firewall configuration</td></tr><tr><td>interface</td><td>Interface configuration. See show running-config interface for further options.</td></tr></tbody></table>	access-list	ACL configuration	antivirus	Antivirus configuration	application	Application configuration	as-path	Autonomous system path filter configuration	as-path access-list	Configuration of ACLs for AS path filtering	atmf	Allied Telesis Management Framework configuration	bgp	Border Gateway Protocol (BGP) configuration	community-list	Community-list configuration	crypto	Security-specific configuration	dhcp	DHCP configuration	dpi	Deep Packet Inspection configuration	entity	Entity configuration	firewall	Firewall configuration	interface	Interface configuration. See show running-config interface for further options.
access-list	ACL configuration																												
antivirus	Antivirus configuration																												
application	Application configuration																												
as-path	Autonomous system path filter configuration																												
as-path access-list	Configuration of ACLs for AS path filtering																												
atmf	Allied Telesis Management Framework configuration																												
bgp	Border Gateway Protocol (BGP) configuration																												
community-list	Community-list configuration																												
crypto	Security-specific configuration																												
dhcp	DHCP configuration																												
dpi	Deep Packet Inspection configuration																												
entity	Entity configuration																												
firewall	Firewall configuration																												
interface	Interface configuration. See show running-config interface for further options.																												

Parameter	Description
ip	Internet Protocol (IP) configuration
ip pim dense-mode	PIM-DM configuration
ip pim sparse-mode	PIM-SM configuration
ip route	IP static route configuration
ip-reputation	IP Reputation configuration
ips	IPS configuration
ipsec	Internet Protocol Security (IPSec) configuration
ipv6	Internet Protocol version 6 (IPv6) configuration
ipv6 access-list	IPv6 ACL configuration
ipv6 mroute	IPv6 multicast route configuration
ipv6 prefix-list	IPv6 prefix list configuration
ipv6 route	IPv6 static route configuration
isakmp	Internet Security Association Key Management Protocol (ISAKMP) configuration
key chain	Authentication key management configuration
l2tp-profile	L2TP tunnel profile configuration
lldp	LLDP configuration
log	Logging utility configuration
malware-protection	Malware protection configuration
nat	Network Address Translation configuration
power-inline	Power over Ethernet (PoE) configuration
policy-based-routing	Policy-based routing (PBR) configuration
pppoe-ac	PPPoE access concentrator configuration
prefix-list	Prefix-list configuration
route-map	Route-map configuration
router	Router configuration
router-id	Configuration of the router identifier for this system
security-password	Strong password security configuration
snmp	SNMP configuration
ssh	Secure Shell configuration

Parameter	Description
switch	Switch configuration
web-control	Web Control configuration

Mode Privileged Exec and Global Configuration

Example To display the current configuration of your device, use the command:

```
awplus# show running-config
```

Output Figure 2-11: Example output from **show running-config**

```
awplus#show running-config
!
service password-encryption
!
no banner motd
!
username manager privilege 15 password 8 $1$bJoVec4D$JwOJGPr7YqoExA0GVasdE0
!
log host source eth2
!
no service ssh
!

service telnet
!
no service http
!
no clock timezone
!
snmp-server
!
aaa authentication enable default local
aaa authentication login default local
!
ip domain-lookup
!
service dhcp-server
!
bridge 1
!
lACP global-passive-mode enable
!
l2tp tunnel test1
  version 2
  ip-version 4
!
interface eth1
  encapsulation ppp 0
  encapsulation dot1q 1
  bridge-group 1
  ip address dhcp
!
```



```
interface eth2
  ip address 192.168.0.20/16
!
interface ppp0
  ipv6 address 2001:db9::a3/64
  ipv6 enable
  snmp trap link-status
!
trigger 1
  type cpu 90
  day monday tuesday wednesday thursday friday
!
line con 0
line vty 0 4
!
end
```

Related Commands [copy running-config](#)
[show running-config interface](#)

show running-config interface

Overview This command displays the current configuration of one or more interfaces on the device.

Syntax `show running-config interface [<interface-list>] [ip igmp|ip multicast|ip pim dense-mode|ip pim sparse-mode|ipv6 rip|lacp|mstp|ospf|rip|rstp|stp]`

Parameter	Description
<interface-list>	The interfaces or ports to display information about. An interface-list can be: <ul style="list-style-type: none">• a PPP interface (e.g. ppp0), an Eth interface (e.g. eth1), a VLAN (e.g. vlan2), a LAN port (e.g. port1.0.4), a static channel group (e.g. sa2) or a dynamic (LACP) channel group (e.g. po2)• a continuous range of interfaces, ports, static channel groups or dynamic (LACP) channel groups, separated by a hyphen (e.g. vlan2-8, or port1.0.1-1.0.4, or sa1-2, or po1-2)• a comma-separated list of the above (e.g. vlan2,vlan20-30). Do not mix interface types in a list. The specified interfaces must exist.
lacp	Displays running configuration for LACP (Link Aggregation Control Protocol) for the specified interfaces.
ip igmp	Displays running configuration for IGMP (Internet Group Management Protocol) for the specified interfaces.
ip multicast	Displays running configuration for general multicast settings for the specified interfaces.
ip pim sparse-mode	Displays running configuration for PIM-SM (Protocol Independent Multicast - Sparse Mode) for the specified interfaces.
ip pim dense-mode	Displays running configuration for PIM-DM (Protocol Independent Multicasting - Dense Mode) for the specified interfaces.
mstp	Displays running configuration for MSTP (Multiple Spanning Tree Protocol) for the specified interfaces.
ospf	Displays running configuration for OSPF (Open Shortest Path First) for the specified interfaces.
rip	Displays running configuration for RIP (Routing Information Protocol) for the specified interfaces.
ipv6 rip	Displays running configuration for RIPng (RIP for IPv6) for the specified interfaces.

Parameter	Description
rstp	Displays running configuration for RSTP (Rapid Spanning Tree Protocol) for the specified interfaces.
stp	Displays running configuration for STP (Spanning Tree Protocol) for the specified interfaces.

Mode Privileged Exec and Global Configuration

Default Displays information for all protocols on all interfaces

Examples To display the current running configuration of your device for ports 1 to 4, use the command:

```
awplus# show running-config interface port1.0.1-port1.0.4
```

To display the current running configuration of a device for VLAN 1, use the command:

```
awplus# show running-config interface vlan1
```

To display the current running configuration of a device for VLANs 1 and 3-5, use the command:

```
awplus# show running-config interface vlan1,vlan3-vlan5
```

To display the current OSPF configuration of your device for ports 1 to 6, use the command:

```
awplus# show running-config interface port1.0.1-port1.0.6 ospf
```

Output Figure 2-12: Example output from a **show running-config interface ppp0** command

```
awplus#show running-config interface ppp0
!
interface ppp0
  ipv6 address 2001:db9::a3/64
  ipv6 enable
  snmp trap link-status
!
```

Related Commands [copy running-config](#)
[show running-config](#)

show startup-config

Overview This command displays the contents of the start-up configuration file, which is the file that the device runs on start-up.

For information on filtering and saving command output, see the [“Getting Started with AlliedWare Plus” Feature Overview and Configuration Guide](#).

Syntax `show startup-config`

Mode Privileged Exec

Example To display the contents of the current start-up configuration file, use the command:

```
awplus# show startup-config
```

Output Figure 2-13: Example output from the **show startup-config** command

```
awplus#show startup-config
!
service password-encryption
!
no banner motd
!
username manager privilege 15 password 8 $1$bJoVec4D$JwOJGPr7YqoExA0GVasdE0
!
no service ssh
!
service telnet
!
no clock timezone
.
.
.
line con 0
line vty 0 4
!
end
```

Related Commands

- [boot config-file backup](#)
- [copy running-config](#)
- [copy startup-config](#)
- [erase startup-config](#)
- [show boot](#)

show version

Overview This command displays the version number and copyright details of the current AlliedWare Plus™ OS your device is running.

Syntax show version

Mode User Exec and Privileged Exec

Example To display the version details of your currently installed software, use the command:

```
awplus# show version
```

Output Figure 2-14: Example output from **show version**

```
awplus#show version

AlliedWare Plus (TM) 5.4.5 03/19/15 21:15:14

Build name : AR3050S-5.4.5-0.1.rel
Build date : Thu Mar 19 21:15:30 UTC 2015
Build type : RELEASE

Application Interface Specification Framework
  Copyright (c) 2002-2004 MontaVista Software, Inc;
  Copyright (c) 2005-2010 Red Hat, Inc.
Command Line Option Parsing Library
  Copyright (c) 1998-2002 Red Hat Software Inc.
Corosync Cluster Engine
  Copyright (c) 2002-2004 MontaVista Software, Inc. All rights reserved;
  Copyright (c) 2005-2010 Red Hat, Inc.
DHCP Bind
  Copyright (c) 2005 - 2008, Holger Zuleger HZnet. All rights reserved.
  Copyright (c) 2004-2012 Internet Systems Consortium, Inc. ("ISC").
  Copyright (c) 1996-2003 Internet Software Consortium.
  Copyright (c) 1996-2001 Nominum, Inc.
  Copyright (c) 1995-2000 by Network Associates, Inc.
  Copyright (c) 2002 Stichting NLnet, Netherlands, stichting@nlnet.nl.
  Copyright (c) 1987, 1990, 1993, 1994
    The Regents of the University of California. All rights reserved.
  Copyright (c) The Internet Society 2005.
    This version of this module is part of RFC 4178; see the RFC itself
    full legal notices.
Copyright (c) 2004 Masarykova universita
(Masaryk University, Brno, Czech Republic). All rights reserved.
Copyright (c) 1997 - 2003 Kungliga Tekniska Högskolan
(Royal Institute of Technology, Stockholm, Sweden).
All rights reserved.
```

```
Copyright (c) 1998 Doug Rabson. All rights reserved.
Copyright (c) 2002, Rice University. All rights reserved.
Copyright (c) 1993 by Digital Equipment Corporation.
Copyright (c) 2000 Aaron D. Gifford. All rights reserved.
Copyright (c) 1998 Doug Rabson.
Copyright (c) 2001 Jake Burkholder. All rights reserved.
Copyright (c) 1995, 1996, 1997, and 1998 WIDE Project.
All rights reserved.
Copyright (c) 1999-2000 by Nortel Networks Corporation
Copyright (c) 2000-2002 Japan Network Information Center.
All rights reserved.
Copyright (c) 2004 Nominet, Ltd. Portions Copyright RSA Security Inc.
Copyright (c) 1996, David Mazieres <dm@uun.org>
Copyright (c) 2008, Damien Miller <djm@openbsd.org>
Copyright (c) 2000-2001 The OpenSSL Project. All rights reserved.
DHCP Library
Copyright (c) 2004-2012 by Internet Systems Consortium, Inc. ("ISC")
Copyright (c) 1995-2003 by Internet Software Consortium.
Embedded GNU C Library
Copyright (c) 1991 Regents of the University of California.
All rights reserved.
DNS Resolver from BIND 4.9.5
Copyright (c) 1993 by Digital Equipment Corporation.
Sun RPC Support
Copyright (c) 2010, Oracle America, Inc.
Mach Operating System
Copyright (c) 1991,1990,1989 Carnegie Mellon University.
All Rights Reserved.
EventLog
Copyright (c) 1992, 1993, 1994, 1995, 1996, 1997, 1998, 1999, 2000, 2001,
2002, 2003, 2004, 2005 Free Software Foundation, Inc.
Copyright (c) 2003 BalaBit IT Ltd. All rights reserved.
Author: Balazs Scheidler
Expat
Copyright (c) 1998, 1999, 2000 Thai Open Source Software Center Ltd
and Clark Cooper.
Copyright (c) 2001, 2002, 2003, 2004, 2005, 2006 Expat maintainers.
Fast Lexical Analyser Generator
Copyright (c) 2001, 2002, 2003, 2004, 2005, 2006, 2007 The Flex Project.
Copyright (c) 1990, 1997 The Regents of the University of California.
All rights reserved.
File Utility Library
Copyright (c) Ian F. Darwin 1986-1987, 1989-1992, 1994-1995.
Software written by Ian F. Darwin and others;
maintained 1994- Christos Zoulas.
FreeRADIUS
Copyright (c) 1999, 2000, 2001, 2002, 2003, 2004, 2005, 2006, 2007, 2008,
2009 The FreeRADIUS Server Project
Copyright (c) 1999, 2000, 2001, 2002, 2003, 2004, 2005, 2006, 2007, 2008,
2009 Alan DeKok <aland@deployingradius.com>.
Copyright (c) 1996, 1997, 1999, 2000, 2002, 2003, 2004, 2005
Free Software Foundation, Inc.
```

```
Copyright (c) 2003, 2004, 2005 Kostas Kalevras <kkalev@noc.ntua.gr>
Copyright (c) 2004 Cladju Consulting, Inc.
Copyright (c) 2001, 2002, 2003, 2004, 2005 Google, Inc.
Copyright (c) 2003, 2004 Michael Richardson <mcr@sandelman.ottawa.on.ca>
Copyright (c) 2002, 2003, 2004 Novell, Inc.
Copyright (c) 2002 Miguel A.L. Paraz <mparaz@mparaz.com>
Copyright (c) 2002 Simon Ekstrand <simon@routemeister.net>
Copyright (c) 2001 Chad Miller <cmiller@surfsouth.com>
Copyright (c) 2001 hereUare Communications, Inc.
Copyright (c) 2000 Jochen Friedrich <jochen@scram.de>
Copyright (c) 2000, 2002 Miquel van Smoorenburg
Copyright (c) 2000 Jeff Carneal <jeff@apex.net>
Copyright (c) 2000 Alan Curry <pacman@world.std.com>
Copyright (c) 2000 David Kerry <davidk@snti.com>
Copyright (c) 2000 Dmitri Ageev <d_ageev@ortcc.ru>
Copyright (c) 2000 Nathan Neulinger <nneul@umr.edu>
Copyright (c) 2000 Mike Machado <mike@innercite.com>
Copyright (c) 2000, 2001 Chad Miller <cmiller@surfsouth.com>
  Copyright (c) 1997, 1998, 1999 Cistron Internet Services B.V.
  Copyright (c) 1999 Kunihiro Ishiguro <kunihiro@zebra.org>
Hardware Platform Interface Library
  Copyright (c) 2004 by Intel Corp;
  Copyright (C) IBM Corp. 2004-2008.
IPSec Tools
Copyright (c) 1995, 1996, 1997, 1998, and 1999 WIDE Project.
All rights reserved.
Copyright (c) 2000 Wasabi Systems, Inc. All rights reserved.
Copyright (c) 2004-2006 Emmanuel Dreyfus. All rights reserved.
Copyright (c) 2004 SuSE Linux AG, Nuernberg, Germany.
Contributed by: Michal Ludvig <mludvig@suse.cz>, SUSE Labs.
All rights reserved.
Copyright (c) 2008 Timo Teras. All rights reserved.
Copyright (c) 1984, 1989, 1990, 2000, 2001, 2002, 2003, 2004, 2005, 2006
Free Software Foundation, Inc.
libcap2 - Support for getting/setting POSIX.1e capabilities
Copyright (c) 1997-9,2007-2011 Andrew G Morgan <morgan@kernel.org>
Copyright (C) 2010 Serge Hallyn <serue@us.ibm.com>
Copyright (C) 1997 Aleph One
LibHTP - A security-aware parser for the HTTP protocol
Copyright (c) 2009-2010 Open Information Security Foundation
Copyright (c) 2010-2013 Qualys, Inc.
All rights reserved.
Libnet - An API for construction and handling of network packets
Copyright (c) 1998 - 2002 Mike D. Schiffman <mike@infonexus.com>
http://www.packetfactory.net/libnet
LIBNET 1.1.3+ (c) 2009 - 2012 Sam Roberts <vieuxtech@gmail.com>
libpcap - An API for user-level packet capture
Copyright (c) 1990, 1991, 1992, 1993, 1994, 1995, 1996, 1997, 1998
The Regents of the University of California. All rights reserved.
Linux Utilities
Copyright (C) 1989, 1991 Free Software Foundation, Inc.
675 Mass Ave, Cambridge, MA 02139, USA
Copyright (c) 1989 The Regents of the University of California.
All rights reserved.
MD5 Message Digest Algorithm
Copyright (c) 1990-2, RSA Data Security, Inc. Created 1991.
All rights reserved.
```

```
NET-SNMP SNMP agent software
(c) 1996, 1998-2000 The Regents of the University of California.
All rights reserved;
(c) 2001-2003, Networks Associates Technology, Inc. All rights reserved;
(c) 2001-2003, Cambridge Broadband Ltd. All rights reserved;
(c) 2003, Sun Microsystems, Inc. All rights reserved;
(c) 2003-2006, Sparta, Inc. All rights reserved;
(c) 2004, Cisco, Inc and Information Network
Center of Beijing University of Posts and Telecommunications.
All rights reserved.
Network Time Protocol
  Copyright (c) 1970-2014 University of Delaware. All rights reserved.
  Copyright (c) 1984, 1989-1990, 2000-2012 Free Software Foundation, Inc.
OpenSSL Library
  Copyright (c) 1998-2011 The OpenSSL Project
  Copyright (c) 1995-1998 Eric A. Young, Tim J. Hudson
  All rights reserved.
PCI Bus Utilities
  Copyright (c) 1997--2003 Martin Mares <mj@ucw.cz>
PCRE - Perl Compatible Regular Expressions
  Copyright (c) 1997-2013 University of Cambridge. All rights reserved.
  Copyright(c) 2009-2013 Zoltan Herczeg. All rights reserved.
  Copyright (c) 2007-2012, Google Inc. All rights reserved
ProL2TP
  Copyright Katalix Systems Ltd, 2010, 2011. All rights reserved.
protobuf - Protocol Buffers
  Copyright 2008, Google Inc
  Protocol Buffers, Google's data interchange format - C implementation
  Copyright (c) 2008-2014, Dave Benson and the protobuf-c authors.
  All rights reserved.
pppd - Point-to-Point Protocol Daemon
  Copyright (c) 1984-2000 Carnegie Mellon University. All rights reserved.
  Copyright (c) 1993-2004 Paul Mackerras. All rights reserved.
  Copyright (c) 1995 Pedro Roque Marques. All rights reserved.
  Copyright (c) 1995 Eric Rosenquist. All rights reserved.
  Copyright (c) 1999 Tommi Komulainen. All rights reserved.
  Copyright (C) Andrew Tridgell 1999
  Copyright (c) 2000 by Sun Microsystems, Inc. All rights reserved.
  Copyright (c) 2001 by Sun Microsystems, Inc. All rights reserved.
  Copyright (c) 2002 Google, Inc. All rights reserved.
Racoon2 - A key management system for IPsec
  Copyright (C) 2004, 2005 WIDE Project. All rights reserved.
  Copyright (C) 2004 Emmanuel Dreyfus. All rights reserved.
  Copyright (C) 2004 SuSE Linux AG, Nuernberg, Germany.
  Contributed by: Michal Ludvig <mludvig@suse.cz>, SUSE Labs
  All rights reserved.
  Copyright (c) 1991, 1993
  The Regents of the University of California. All rights reserved.
  Copyright (c) 1998 Todd C. Miller <Todd.Miller@courtesan.com>
  All rights reserved.
```



```
RSA Data Security, Inc. MD5 Message-Digest Algorithm
(c) 1991-2, RSA Data Security, Inc. Created 1991. All rights reserved.
Secure Shell
OpenSSH
Copyright (c) 1995 Tatu Ylonen <ylo@cs.hut.fi>, Espoo, Finland.
All rights reserved.
Copyright (c) 1983, 1990, 1992, 1993, 1995
The Regents of the University of California. All rights reserved.
Cryptographic attack detector
Copyright (c) 1998 CORE SDI S.A., Buenos Aires, Argentina.
Ssh-keyscan
Copyright (c) 1995, 1996 by David Mazieres <dm@lcs.mit.edu>.
sFlow(R) Agent Software
Copyright (c) 2002-2006 InMon Corp.
Sudo
Copyright (c) 1994-1996, 1998-2014
Todd C. Miller <Todd.Miller@courtesan.com>
Copyright (c) 2001 Emin Martinian
Copyright (c) 1989, 1990, 1991, 1993
The Regents of the University of California. All rights reserved.
Copyright (c) 2011, VMware, Inc. All rights reserved.
Copyright (c) 2000 The NetBSD Foundation, Inc. All rights reserved.
Copyright (c) 1996 by Internet Software Consortium.
Copyright (C) 1995-2012 Jean-loup Gailly and Mark Adler
System Call Trace
Copyright (c) 1991, 1992 Paul Kranenburg <pk@cs.few.eur.nl>
Copyright (c) 1993 Branko Lankester <branko@hacktic.nl>
Copyright (c) 1993 Ulrich Pegelow <pegelow@moorea.uni-muenster.de>
Copyright (c) 1995, 1996
Michael Elizabeth Chastain <mec@duracef.shout.net>
Copyright (c) 1993, 1994, 1995, 1996 Rick Sladkey <jrs@world.std.com>
Copyright (c) 1998-2001 Wichert Akkerman <wakkerma@deephackmode.org>
All rights reserved.
TCP Dump Utility
Copyright (c) 1988-1997, 2000
The Regents of the University of California. All rights reserved.
Telnet
Copyright (c) 1983, 1995 Eric P. Allman
Copyright (c) 1988, 1990, 1991 and 1993
The Regents of the University of California. All rights reserved.
TIPC Utilities
Copyright (c) 2004-2005, Ericsson Research Canada
Copyright (c) 2004-2006, Ericsson AB
Copyright (c) 2005-2008,2010-2011, Wind River Systems
Copyright (c) 2012, Compass EOS Ltd http://compass-eos.com/
All rights reserved.

Portions of this product are covered by the GNU (L)GPL, source code may be
downloaded from: http://www.alliedtelesis.co.nz/support/gpl/awp.html
```

Related [boot system backup](#)
Commands [show boot](#)

unmount

Overview Use this command to unmount an external storage device. We recommend you unmount storage devices before removing them, to avoid file corruption. This is especially important if files may be automatically written to the storage device, such as external log files or AMF backup files.

Syntax `unmount card`
`unmount usb`

Parameter	Description
<code>card</code>	Unmount the SD card.
<code>usb</code>	Unmount the USB storage device.

Mode Privileged Exec

Example To unmount a USB storage device and safely remove it from the device, use the command:

```
awplus# unmount usb
```

Related Commands [clear log external](#)
[log external](#)
[show file systems](#)
[show log config](#)
[show log external](#)

Command changes Version 5.4.7-1.1: command added

write file

Overview This command copies the running-config into the file that is set as the current startup-config file. This command is a synonym of the **write memory** and **copy running-config startup-config** commands.

Syntax write [file]

Mode Privileged Exec

Example To write configuration data to the start-up configuration file, use the command:

```
awplus# write file
```

Related Commands

- [copy running-config](#)
- [write memory](#)
- [show running-config](#)

write memory

Overview This command copies the running-config into the file that is set as the current startup-config file. This command is a synonym of the **write file** and **copy running-config startup-config** commands.

Syntax write [memory]

Mode Privileged Exec

Example To write configuration data to the start-up configuration file, use the command:

```
awplus# write memory
```

Related Commands

- [copy running-config](#)
- [write file](#)
- [show running-config](#)

write terminal

Overview This command displays the current configuration of the device. This command is a synonym of the [show running-config](#) command.

Syntax `write terminal`

Mode Privileged Exec

Example To display the current configuration of your device, use the command:

```
awplus# write terminal
```

**Related
Commands** [show running-config](#)

3

User Access Commands

Introduction

Overview This chapter provides an alphabetical reference of commands used to configure user access.

- Command List**
- “clear line console” on page 168
 - “clear line vty” on page 169
 - “enable password” on page 170
 - “enable secret” on page 173
 - “exec-timeout” on page 176
 - “flowcontrol hardware (asyn/console)” on page 178
 - “length (asyn)” on page 180
 - “line” on page 181
 - “privilege level” on page 183
 - “security-password history” on page 184
 - “security-password forced-change” on page 185
 - “security-password lifetime” on page 186
 - “security-password min-lifetime-enforce” on page 187
 - “security-password minimum-categories” on page 188
 - “security-password minimum-length” on page 189
 - “security-password reject-expired-pwd” on page 190
 - “security-password warning” on page 191
 - “service advanced-vty” on page 192
 - “service password-encryption” on page 193
 - “service telnet” on page 194

- [“service terminal-length \(deleted\)”](#) on page 195
- [“show privilege”](#) on page 196
- [“show security-password configuration”](#) on page 197
- [“show security-password user”](#) on page 198
- [“show telnet”](#) on page 199
- [“show users”](#) on page 200
- [“telnet”](#) on page 201
- [“telnet server”](#) on page 202
- [“terminal length”](#) on page 203
- [“terminal resize”](#) on page 204
- [“username”](#) on page 205

clear line console

Overview This command resets a console line. If a terminal session exists on the line then the terminal session is terminated. If console line settings have changed then the new settings are applied.

Syntax `clear line console 0`

Mode Privileged Exec

Example To reset the console line (asyn), use the command:

```
awplus# clear line console 0
awplus# % The new settings for console line 0 have been applied
```

Related Commands

- [clear line vty](#)
- [flowcontrol hardware \(asyn/console\)](#)
- [line](#)
- [show users](#)

clear line vty

Overview This command resets a VTY line. If a session exists on the line then it is closed.

Syntax `clear line vty <0-32>`

Parameter	Description
<0-32>	Line number

Mode Privileged Exec

Example To reset the first VTY line, use the command:

```
awplus# clear line vty 1
```

**Related
Commands**

- [privilege level](#)
- [line](#)
- [show telnet](#)
- [show users](#)

enable password

Overview To set a local password to control access to various privilege levels, use the `enable password` Global Configuration command. Use the `enable password` command to modify or create a password to be used, and use the `no enable password` command to remove the password.

Note that the `enable secret` command is an alias for the `enable password` command, and the `no enable secret` command is an alias for the `no enable password` command. Issuing a `no enable password` command removes a password configured with the `enable secret` command. The `enable password` command is shown in the running and startup configurations. Note that if the `enable secret` command is entered then `enable password` is shown in the configuration.

Syntax `enable password [<plain>|8 <hidden>|level <1-15> 8 <hidden>]`
`no enable password [level <1-15>]`

Parameter	Description
<code><plain></code>	Specifies the unencrypted password.
8	Specifies a hidden password will follow.
<code><hidden></code>	Specifies the hidden encrypted password. Use an encrypted password for better security where a password crosses the network or is stored on a TFTP server.
level	Privilege level <1-15>. Level for which the password applies. You can specify up to 16 privilege levels, using numbers 1 through 15. Level 1 is normal EXEC-mode user privileges for User Exec mode. If this argument is not specified in the command or the no variant of the command, the privilege level defaults to 15 (enable mode privileges) for Privileged Exec mode. A privilege level of 7 can be set for intermediate CLI security.

Default The privilege level for enable password is level 15 by default. Previously the default was level 1.

Mode Global Configuration

Usage This command enables the Network Administrator to set a password for entering the Privileged Exec mode when using the `enable (Privileged Exec mode)` command. There are three methods to enable a password. In the examples below, for each method, note that the configuration is different and the configuration file output is different, but the password string to be used to enter the Privileged Exec mode with the **enable** command is the same (**mypasswd**).

A user can now have an intermediate CLI security level set with this command for privilege level 7 to access all the show commands in Privileged Exec mode and all the commands in User Exec mode, but not any configuration commands in Privileged Exec mode.

Note that the `enable password` command is an alias for the `enable secret` command and one password per privilege level is allowed using these commands. Do not assign one password to a privilege level with `enable password` and another password to a privilege level with `enable secret`. Use `enable password` or `enable secret` commands. Do not use both on the same level.

Using plain passwords

The plain password is a clear text string that appears in the configuration file as configured.

```
awplus# configure terminal
awplus(config)# enable password mypasswd
awplus(config)# end
```

This results in the following show output:

```
awplus#show run
Current configuration:
hostname awplus
enable password mypasswd
!
interface lo
```

Using encrypted passwords

You can configure an encrypted password using the `service password-encryption` command. First, use the `enable password` command to specify the string that you want to use as a password (**myspasswd**). Then, use the `service password-encryption` command to encrypt the specified string (**myspasswd**). The advantage of using an encrypted password is that the configuration file does not show **myspasswd**, it will only show the encrypted string **fU7zHzuutY2SA**.

```
awplus# configure terminal
awplus(config)# enable password mypasswd
awplus(config)# service password-encryption
awplus(config)# end
```

This results in the following show output:

```
awplus#show run
Current configuration:
hostname awplus
enable password 8 fU7zHzuutY2SA
service password-encryption
!
interface lo
```

Using hidden passwords

You can configure an encrypted password using the **HIDDEN** parameter (**8**) with the `enable password` command. Use this method if you already know the encrypted string corresponding to the plain text string that you want to use as a password. It is not required to use the `service password-encryption` command for

this method. The output in the configuration file will show only the encrypted string, and not the text string.

```
awplus# configure terminal
awplus(config)# enable password 8 fU7zHzuutY2SA
awplus(config)# end
```

This results in the following show output:

```
awplus#show run
Current configuration:
hostname awplus
enable password 8 fU7zHzuutY2SA
!
interface lo
```

Related Commands

- [enable \(Privileged Exec mode\)](#)
- [enable secret](#)
- [service password-encryption](#)
- [privilege level](#)
- [show privilege](#)
- [username](#)
- [show running-config](#)

enable secret

Overview To set a local password to control access to various privilege levels, use the `enable secret` Global Configuration command. Use the `enable secret` command to modify or create a password to be used, and use the `no enable secret` command to remove the password.

Note that the `enable secret` command is an alias for the `enable password` command, and the `no enable secret` command is an alias for the `no enable password` command. Issuing a `no enable password` command removes a password configured with the `enable secret` command. The `enable password` command is shown in the running and startup configurations. Note that if the `enable secret` command is entered then `enable password` is shown in the configuration

Syntax `enable secret [<plain>|8 <hidden>|level <0-15> 8 <hidden>]`
`no enable secret [level <1-15>]`

Parameter	Description
<code><plain></code>	Specifies the unencrypted password.
8	Specifies a hidden password will follow.
<code><hidden></code>	Specifies the hidden encrypted password. Use an encrypted password for better security where a password crosses the network or is stored on a TFTP server.
level	Privilege level <1-15>. Level for which the password applies. You can specify up to 16 privilege levels, using numbers 1 through 15. Level 1 is normal EXEC-mode user privileges for User Exec mode. If this argument is not specified in the command or the no variant of the command, the privilege level defaults to 15 (enable mode privileges) for Privileged Exec mode. A privilege level of 7 can be set for intermediate CLI security.

Default The privilege level for enable secret is level 15 by default.

Mode Global Configuration

Usage This command enables the Network Administrator to set a password for entering the Privileged Exec mode when using the `enable (Privileged Exec mode)` command. There are three methods to enable a password. In the examples below, for each method, note that the configuration is different and the configuration file output is different, but the password string to be used to enter the Privileged Exec mode with the **enable** command is the same (**mypasswd**).

A user can have an intermediate CLI security level set with this command for privilege level 7 to access all the show commands in Privileged Exec mode and all the commands in User Exec mode, but not any configuration commands in Privileged Exec mode.

Note that the `enable secret` command is an alias for the `enable password` command and one password per privilege level is allowed using these commands. Do not assign one password to a privilege level with `enable password` and another password to a privilege level with `enable secret`. Use `enable password` or `enable secret` commands. Do not use both on the same level.

Using plain passwords

The plain password is a clear text string that appears in the configuration file as configured.

```
awplus# configure terminal
awplus(config)# enable secret mypasswd
awplus(config)# end
```

This results in the following show output:

```
awplus#show run
Current configuration:
hostname awplus
enable password mypasswd
!
interface lo
```

Using encrypted passwords

Configure an encrypted password using the `service password-encryption` command. First, use the `enable password` command to specify the string that you want to use as a password (**mypasswd**). Then, use the `service password-encryption` command to encrypt the specified string (**mypasswd**). The advantage of using an encrypted password is that the configuration file does not show **mypasswd**, it will only show the encrypted string **fU7zHzuutY2SA**.

```
awplus# configure terminal
awplus(config)# enable secret mypasswd
awplus(config)# service password-encryption
awplus(config)# end
```

This results in the following show output:

```
awplus#show run
Current configuration:
hostname awplus
enable password 8 fU7zHzuutY2SA
service password-encryption
!
interface lo
```

Using hidden passwords

Configure an encrypted password using the **HIDDEN** parameter (**8**) with the `enable password` command. Use this method if you already know the encrypted string corresponding to the plain text string that you want to use as a password. It is not required to use the `service password-encryption` command for this method.

The output in the configuration file will show only the encrypted string, and not the text string:

```
awplus# configure terminal
awplus(config)# enable secret 8 fU7zHzuutY2SA
awplus(config)# end
```

This results in the following show output:

```
awplus#show run
Current configuration:
hostname awplus
enable password 8 fU7zHzuutY2SA
!
interface lo
```

Related Commands

- [enable \(Privileged Exec mode\)](#)
- [enable secret](#)
- [service password-encryption](#)
- [privilege level](#)
- [show privilege](#)
- [username](#)
- [show running-config](#)

exec-timeout

Overview This command sets the interval your device waits for user input from either a console or VTY connection. Once the timeout interval is reached, the connection is dropped. This command sets the time limit when the console or VTY connection automatically logs off after no activity.

The **no** variant of this command removes a specified timeout and resets to the default timeout (10 minutes).

Syntax `exec-timeout {<minutes>} [<seconds>]`
`no exec-timeout`

Parameter	Description
<code><minutes></code>	<code><0-35791></code> Required integer timeout value in minutes
<code><seconds></code>	<code><0-2147483></code> Optional integer timeout value in seconds

Default The default for the **exec-timeout** command is 10 minutes and 0 seconds (**exec-timeout 10 0**).

Mode Line Configuration

Usage This command is used set the time the telnet session waits for an idle VTY session, before it times out. An **exec-timeout 0 0** setting will cause the telnet session to wait indefinitely. The command **exec-timeout 0 0** is useful while configuring a device, but reduces device security.

If no input is detected during the interval then the current connection resumes. If no connections exist then the terminal returns to an idle state and disconnects incoming sessions.

Examples To set VTY connections to timeout after 2 minutes, 30 seconds if there is no response from the user, use the following commands:

```
awplus# configure terminal
awplus(config)# line vty 0 32
awplus(config-line)# exec-timeout 2 30
```

To reset the console connection to the default timeout of 10 minutes 0 seconds if there is no response from the user, use the following commands:

```
awplus# configure terminal
awplus(config)# line console 0
awplus(config-line)# no exec-timeout
```

Validation Commands `show running-config`

**Related
Commands** [line](#)
[service telnet](#)

flowcontrol hardware (asyn/console)

Overview Use this command to enable RTS/CTS (Ready To Send/Clear To Send) hardware flow control on a terminal console line (asyn port) between the DTE (Data Terminal Equipment) and the DCE (Data Communications Equipment).

Syntax `flowcontrol hardware`
`no flowcontrol hardware`

Mode Line Configuration

Default Hardware flow control is disabled by default.

Usage Hardware flow control makes use of the RTS and CTS control signals between the DTE and DCE where the rate of transmitted data is faster than the rate of received data. Flow control is a technique for ensuring that a transmitting entity does not overwhelm a receiving entity with data. When the buffers on the receiving device are full, a message is sent to the sending device to suspend the transmission until the data in the buffers has been processed.

Hardware flow control can be configured on terminal console lines (e.g. asyn0). For Reverse Telnet connections, hardware flow control must be configured to match on both the Access Server and the Remote Device. For terminal console sessions, hardware flow control must be configured to match on both the DTE and the DCE. Settings are saved in the running configuration. Changes are applied after reboot, clear line console, or after closing the session.

Use **show running-config** and **show startup-config** commands to view hardware flow control settings that take effect after reboot for a terminal console line. See the **show running-config** command output:

```
awplus#show running-config
!
line con 1
  speed 9600
  mode out 2001
  flowcontrol hardware
!
```

Note that line configuration commands do not take effect immediately. Line configuration commands take effect after one of the following commands or events:

- issuing a [clear line console](#) command
- issuing a [reboot](#) command
- logging out of the current session

Examples To enable hardware flow control on terminal console line asyn0, use the commands:

```
awplus# configure terminal
awplus(config)# line console 0
awplus(config-line)# flowcontrol hardware
```

To disable hardware flow control on terminal console line asyn0, use the commands:

```
awplus# configure terminal
awplus(config)# line console 0
awplus(config-line)# no flowcontrol hardware
```

Related Commands

- [clear line console](#)
- [show running-config](#)
- [speed \(asyn\)](#)

length (asyn)

Overview Use this command to specify the number of rows of output that the device will display before pausing, for the console or VTY line that you are configuring.

The **no** variant of this command restores the length of a line (terminal session) attached to a console port or to a VTY to its default length of 22 rows.

Syntax length <0-512>
no length

Parameter	Description
<0-512>	Number of lines on screen. Specify 0 for no pausing.

Mode Line Configuration

Default The length of a terminal session is 22 rows. The **no length** command restores the default.

Usage If the output from a command is longer than the length of the line the output will be paused and the ‘-More-’ prompt allows you to move to the next screen full of data.

A length of 0 will turn off pausing and data will be displayed to the console as long as there is data to display.

Examples To set the terminal session length on the console to 10 rows, use the command:

```
awplus# configure terminal
awplus(config)# line console 0
awplus(config-line)# length 10
```

To reset the terminal session length on the console to the default (22 rows), use the command:

```
awplus# configure terminal
awplus(config)# line console 0
awplus(config-line)# no length
```

To display output to the console continuously, use the command:

```
awplus# configure terminal
awplus(config)# line console 0
awplus(config-line)# length 0
```

Related Commands [terminal resize](#)
[terminal length](#)

line

Overview Use this command to enter line configuration mode for the specified VTYS or the console. The command prompt changes to show that the device is in Line Configuration mode.

Syntax `line vty <first-line> [<last-line>]`
`line console 0`

Parameter	Description
<code><first-line></code>	<code><0-32></code> Specify the first line number.
<code><last-line></code>	<code><0-32></code> Specify the last line number.
<code>console</code>	The console terminal line(s) for local access.
<code>vty</code>	Virtual terminal for remote console access.

Mode Global Configuration

Usage This command puts you into Line Configuration mode. Once in Line Configuration mode, you can configure console and virtual terminal settings, including setting [speed \(asyn\)](#), [length \(asyn\)](#), [privilege level](#), and authentication ([login authentication](#)) or accounting ([accounting login](#)) method lists.

To change the console (asyn) port speed, use this **line** command to enter Line Configuration mode before using the [speed \(asyn\)](#) command. Set the console speed (Baud rate) to match the transmission rate of the device connected to the console (asyn) port on your device.

Note that line configuration commands do not take effect immediately. Line configuration commands take effect after one of the following commands or events:

- issuing a [clear line console](#) command
- issuing a [reboot](#) command
- logging out of the current session

Examples To enter Line Configuration mode in order to configure all VTYS, use the commands:

```
awplus# configure terminal
awplus(config)# line vty 0 32
awplus(config-line)#
```

To enter Line Configuration mode to configure the console (asyn 0) port terminal line, use the commands:

```
awplus# configure terminal
awplus(config)# line console 0
awplus(config-line)#
```

**Related
Commands**

- accounting login
- clear line console
- clear line vty
- flowcontrol hardware (asyn/console)
- length (asyn)
- login authentication
- privilege level
- speed (asyn)

privilege level

Overview This command sets a privilege level for VTY or console connections. The configured privilege level from this command overrides a specific user's initial privilege level at the console login.

Syntax `privilege level <1-15>`

Mode Line Configuration

Usage You can set an intermediate CLI security level for a console user with this command by applying privilege level 7 to access all show commands in Privileged Exec and all User Exec commands. However, intermediate CLI security will not show configuration commands in Privileged Exec.

Examples To set the console connection to have the maximum privilege level, use the following commands:

```
awplus# configure terminal
awplus(config)# line console 0
awplus(config-line)# privilege level 15
```

To set all VTY connections to have the minimum privilege level, use the following commands:

```
awplus# configure terminal
awplus(config)# line vty 0 5
awplus(config-line)# privilege level 1
```

To set all VTY connections to have an intermediate CLI security level, to access all show commands, use the following commands:

```
awplus# configure terminal
awplus(config)# line vty 0 5
awplus(config-line)# privilege level 7
```

Related Commands

- [enable password](#)
- [line](#)
- [show privilege](#)
- [username](#)

security-password history

Overview This command specifies the number of previous passwords that are unable to be reused. A new password is invalid if it matches a password retained in the password history.

The **no** variant of the command disables this feature.

Syntax `security-password history <0-15>`
`no security-password history`

Parameter	Description
<0-15>	The allowable range of previous passwords to match against. A value of 0 will disable the history functionality and is equivalent to the no security-password history command. If the history functionality is disabled, all users' password history is reset and all password history is lost.

Default The default history value is 0, which will disable the history functionality.

Mode Global Configuration

Examples To restrict reuse of the three most recent passwords, use the command:

```
awplus# configure terminal
awplus(config)# security-password history 3
```

To allow the reuse of recent passwords, use the command:

```
awplus# configure terminal
awplus(config)# no security-password history
```

Related Commands

- [security-password forced-change](#)
- [security-password lifetime](#)
- [security-password min-lifetime-enforce](#)
- [security-password minimum-categories](#)
- [security-password minimum-length](#)
- [security-password reject-expired-pwd](#)
- [security-password warning](#)
- [show running-config security-password](#)
- [show security-password configuration](#)
- [show security-password user](#)

security-password forced-change

Overview This command specifies whether or not a user is forced to change an expired password at the next login. If this feature is enabled, users whose passwords have expired are forced to change to a password that must comply with the current password security rules at the next login.

Note that to use this command, the lifetime feature must be enabled with the [security-password lifetime](#) command and the reject-expired-pwd feature must be disabled with the [security-password reject-expired-pwd](#) command.

The **no** variant of the command disables this feature.

Syntax `security-password forced-change`
`no security-password forced-change`

Default The forced-change feature is disabled by default.

Mode Global Configuration

Example To force a user to change their expired password at the next login, use the command:

```
awplus# configure terminal
awplus(config)# security-password forced-change
```

Related Commands

- [security-password history](#)
- [security-password lifetime](#)
- [security-password min-lifetime-enforce](#)
- [security-password minimum-categories](#)
- [security-password minimum-length](#)
- [security-password reject-expired-pwd](#)
- [security-password warning](#)
- [show running-config security-password](#)
- [show security-password configuration](#)
- [show security-password user](#)

security-password lifetime

Overview This command enables password expiry by specifying a password lifetime in days.

Note that when the password lifetime feature is disabled, it also disables the [security-password forced-change](#) command and the [security-password warning](#) command.

The **no** variant of the command disables this feature.

Syntax `security-password lifetime <0-1000>`
`no security-password lifetime`

Parameter	Description
<code><0-1000></code>	Password lifetime specified in days. A value of 0 will disable lifetime functionality and the password will never expire. This is equivalent to the no security-password lifetime command.

Default The default password lifetime is 0, which will disable the lifetime functionality.

Mode Global Configuration

Example To configure the password lifetime to 10 days, use the command:

```
awplus# configure terminal
awplus(config)# security-password lifetime 10
```

Related Commands

- [security-password forced-change](#)
- [security-password history](#)
- [security-password min-lifetime-enforce](#)
- [security-password minimum-categories](#)
- [security-password minimum-length](#)
- [security-password reject-expired-pwd](#)
- [security-password warning](#)
- [show running-config security-password](#)
- [show security-password configuration](#)
- [show security-password user](#)

security-password min-lifetime-enforce

Overview Use this command to configure a minimum number of days before a password can be changed by a user. With this feature enabled, once a user sets the password, the user cannot change it again until the minimum lifetime has passed.

Use the **no** variant of this command to remove the minimum lifetime.

Syntax `security-password min-lifetime-enforce <0-1000>`
`no security-password min-lifetime-enforce`

Parameter	Description
<code><0-1000></code>	The minimum number of days before a password can be changed

Default By default, no minimum lifetime is enforced.

Mode Global Configuration

Usage The minimum lifetime is helpful in conjunction with a security policy that prevents people from re-using old passwords. For example, if you do not allow people to re-use any of their last 5 passwords, a person can bypass that restriction by changing their password 5 times in quick succession and then re-setting it to their previous password. The minimum lifetime prevents that by preventing people from changing their password in quick succession.

Example To force users to wait at least 2 days between changing passwords, use the command:

```
awplus(config)# security-password min-lifetime-enforce 2
```

Related Commands

- [security-password forced-change](#)
- [security-password history](#)
- [security-password lifetime](#)
- [security-password minimum-categories](#)
- [security-password minimum-length](#)
- [security-password reject-expired-pwd](#)
- [security-password warning](#)
- [show running-config security-password](#)
- [show security-password configuration](#)
- [show security-password user](#)

Command changes Version 5.4.7-0.2: command added

security-password minimum-categories

Overview This command specifies the minimum number of categories that the password must contain in order to be considered valid. The password categories are:

- uppercase letters: A to Z
- lowercase letters: a to z
- digits: 0 to 9
- special symbols: all printable ASCII characters not included in the previous three categories. The question mark (?) cannot be used as it is reserved for help functionality.

Note that to ensure password security, the minimum number of categories should align with the lifetime selected, i.e. the fewer categories specified the shorter the lifetime specified.

Syntax `security-password minimum-categories <1-4>`

Parameter	Description
<1-4>	Number of categories the password must satisfy, in the range 1 to 4.

Default The default number of categories that the password must satisfy is 1.

Mode Global Configuration

Example To configure the required minimum number of character categories to be 3, use the command:

```
awplus# configure terminal
awplus(config)# security-password minimum-categories 3
```

Related Commands

- [security-password forced-change](#)
- [security-password history](#)
- [security-password lifetime](#)
- [security-password min-lifetime-enforce](#)
- [security-password minimum-length](#)
- [security-password reject-expired-pwd](#)
- [security-password warning](#)
- [show running-config security-password](#)
- [show security-password configuration](#)
- [show security-password user](#)

security-password minimum-length

Overview This command specifies the minimum allowable password length. This value is checked against when there is a password change or a user account is created.

Syntax `security-password minimum-length <1-23>`

Parameter	Description
<1-23>	Minimum password length in the range from 1 to 23.

Default The default minimum password length is 1.

Mode Global Configuration

Example To configure the required minimum password length as 8, use the command:

```
awplus# configure terminal
awplus(config)# security-password minimum-length 8
```

Related Commands

- [security-password forced-change](#)
- [security-password history](#)
- [security-password lifetime](#)
- [security-password min-lifetime-enforce](#)
- [security-password minimum-categories](#)
- [security-password reject-expired-pwd](#)
- [security-password warning](#)
- [show running-config security-password](#)
- [show security-password configuration](#)
- [show security-password user](#)

security-password reject-expired-pwd

Overview This command specifies whether or not a user is allowed to login with an expired password. Users with expired passwords are rejected at login if this functionality is enabled. Users then have to contact the Network Administrator to change their password.

CAUTION: *Once all users' passwords are expired you are unable to login to the device again if the security-password reject-expired-pwd command has been executed. You will have to reboot the device with a default configuration file, or load an earlier software version that does not have the security password feature.*

We recommend you never have the command line "security-password reject-expired-pwd" in a default config file.

Note that when the reject-expired-pwd functionality is disabled and a user logs on with an expired password, if the forced-change feature is enabled with [security-password forced-change](#) command, a user may have to change the password during login depending on the password lifetime specified by the [security-password lifetime](#) command.

The **no** variant of the command disables this feature.

Syntax security-password reject-expired-pwd
no security-password reject-expired-pwd

Default The reject-expired-pwd feature is disabled by default.

Mode Global Configuration

Example To configure the system to reject users with an expired password, use the command:

```
awplus# configure terminal
awplus(config)# security-password reject-expired-pwd
```

Related Commands

- [security-password forced-change](#)
- [security-password history](#)
- [security-password lifetime](#)
- [security-password min-lifetime-enforce](#)
- [security-password minimum-categories](#)
- [security-password minimum-length](#)
- [security-password warning](#)
- [show running-config security-password](#)
- [show security-password configuration](#)
- [show security-password user](#)

security-password warning

Overview This command specifies the number of days before the password expires that the user will receive a warning message specifying the remaining lifetime of the password.

Note that the warning period cannot be set unless the lifetime feature is enabled with the [security-password lifetime](#) command.

The **no** variant of the command disables this feature.

Syntax `security-password warning <0-1000>`
`no security-password warning`

Parameter	Description
<code><0-1000></code>	Warning period in the range from 0 to 1000 days. A value 0 disables the warning functionality and no warning message is displayed for expiring passwords. This is equivalent to the no security-password warning command. The warning period must be less than, or equal to, the password lifetime set with the security-password lifetime command.

Default The default warning period is 0, which disables warning functionality.

Mode Global Configuration

Example To configure a warning period of three days, use the command:

```
awplus# configure terminal
awplus(config)# security-password warning 3
```

Related Commands

- [security-password forced-change](#)
- [security-password history](#)
- [security-password lifetime](#)
- [security-password min-lifetime-enforce](#)
- [security-password minimum-categories](#)
- [security-password minimum-length](#)
- [security-password reject-expired-pwd](#)
- [show running-config security-password](#)
- [show security-password configuration](#)
- [show security-password user](#)

service advanced-vty

Overview This command enables the advanced-vty help feature. This allows you to use TAB completion for commands. Where multiple options are possible, the help feature displays the possible options.

The **no service advanced-vty** command disables the advanced-vty help feature.

Syntax `service advanced-vty`
`no service advanced-vty`

Default The advanced-vty help feature is enabled by default.

Mode Global Configuration

Examples To disable the advanced-vty help feature, use the command:

```
awplus# configure terminal
awplus(config)# no service advanced-vty
```

To re-enable the advanced-vty help feature after it has been disabled, use the following commands:

```
awplus# configure terminal
awplus(config)# service advanced-vty
```

service password-encryption

Overview Use this command to enable password encryption. This is enabled by default. When password encryption is enabled, the device displays passwords in the running config in encrypted form instead of in plain text.

Use the **no service password-encryption** command to stop the device from displaying newly-entered passwords in encrypted form. This does not change the display of existing passwords.

Syntax `service password-encryption`
`no service password-encryption`

Mode Global Configuration

Example `awplus# configure terminal`
`awplus(config)# service password-encryption`

Validation Commands `show running-config`

Related Commands `enable password`

service telnet

Overview Use this command to enable the telnet server. The server is enabled by default. Enabling the telnet server starts the device listening for incoming telnet sessions on the configured port.

The server listens on port 23, unless you have changed the port by using the [privilege level](#) command.

Use the **no** variant of this command to disable the telnet server. Disabling the telnet server will stop the device listening for new incoming telnet sessions. However, existing telnet sessions will still be active.

Syntax

```
service telnet [ip|ipv6]
no service telnet [ip|ipv6]
```

Default The IPv4 and IPv6 telnet servers are enabled by default.
The configured telnet port is TCP port 23 by default.

Mode Global Configuration

Examples To enable both the IPv4 and IPv6 telnet servers, use the following commands:

```
awplus# configure terminal
awplus(config)# service telnet
```

To enable the IPv6 telnet server only, use the following commands:

```
awplus# configure terminal
awplus(config)# service telnet ipv6
```

To disable both the IPv4 and IPv6 telnet servers, use the following commands:

```
awplus# configure terminal
awplus(config)# no service telnet
```

To disable the IPv6 telnet server only, use the following commands:

```
awplus# configure terminal
awplus(config)# no service telnet ipv6
```

**Related
Commands**

- [clear line vty](#)
- [show telnet](#)
- [telnet server](#)

service terminal-length (deleted)

Overview This command has been deleted in Software Version 5.4.5-0.1 and later.

show privilege

Overview This command displays the current user privilege level, which can be any privilege level in the range <1-15>. Privilege levels <1-6> allow limited user access (all User Exec commands), privilege levels <7-14> allow restricted user access (all User Exec commands plus Privileged Exec show commands). Privilege level 15 gives full user access to all Privileged Exec commands.

Syntax `show privilege`

Mode User Exec and Privileged Exec

Usage A user can have an intermediate CLI security level set with this command for privilege levels <7-14> to access all show commands in Privileged Exec mode and all commands in User Exec mode, but no configuration commands in Privileged Exec mode.

Example To show the current privilege level of the user, use the command:

```
awplus# show privilege
```

Output Figure 3-1: Example output from the **show privilege** command

```
awplus#show privilege
Current privilege level is 15
awplus#disable
awplus>show privilege
Current privilege level is 1
```

Related Commands [privilege level](#)

show security-password configuration

Overview This command displays the configuration settings for the various security password rules.

Syntax `show security-password configuration`

Mode Privileged Exec

Example To display the current security-password rule configuration settings, use the command:

```
awplus# show security-password configuration
```

Output Figure 3-2: Example output from the **show security-password configuration** command

```
Security Password Configuration
Minimum password length ..... 8
Minimum password character categories to match ..... 3
Number of previously used passwords to restrict..... 4
Password lifetime ..... 30 day(s)
  Warning period before password expires ..... 3 day(s)
Reject expired password at login ..... Disabled
  Force changing expired password at login ..... Enabled
```

- Related Commands**
- [security-password forced-change](#)
 - [security-password history](#)
 - [security-password lifetime](#)
 - [security-password min-lifetime-enforce](#)
 - [security-password minimum-categories](#)
 - [security-password minimum-length](#)
 - [security-password reject-expired-pwd](#)
 - [security-password warning](#)
 - [show security-password user](#)

show security-password user

Overview This command displays user account and password information for all users.

Syntax `show security-password user`

Mode Privileged Exec

Example To display the system users' remaining lifetime or last password change, use the command:

```
awplus# show security-password user
```

Output Figure 3-3: Example output from the **show security-password** user command

User account and password information			
UserName	Privilege	Last-PWD-Change	Remaining-lifetime
manager	15	4625 day(s) ago	No Expiry
bob15	15	0 day(s) ago	30 days
ted7	7	0 day(s) ago	No Expiry
mike1	1	0 day(s) ago	No Expiry

- Related Commands**
- [security-password forced-change](#)
 - [security-password history](#)
 - [security-password lifetime](#)
 - [security-password min-lifetime-enforce](#)
 - [security-password minimum-categories](#)
 - [security-password minimum-length](#)
 - [security-password reject-expired-pwd](#)
 - [security-password warning](#)
 - [show security-password configuration](#)

show telnet

Overview This command shows the Telnet server settings.

Syntax `show telnet`

Mode User Exec and Privileged Exec

Example To show the Telnet server settings, use the command:

```
awplus# show telnet
```

Output Figure 3-4: Example output from the **show telnet** command

```
Telnet Server Configuration
-----
Telnet server           : Enabled
Protocol                : IPv4, IPv6
Port                    : 23
```

**Related
Commands**

- [clear line vty](#)
- [service telnet](#)
- [show users](#)
- [telnet server](#)

show users

Overview This command shows information about the users who are currently logged into the device.

Syntax show users

Mode User Exec and Privileged Exec

Example To show the users currently connected to the device, use the command:

```
awplus# show users
```

Output Figure 3-5: Example output from the **show users** command

Line	User	Host(s)	Idle	Location	Priv	Idletime	Timeout
con 0	manager	idle	00:00:00	ttyS0	15	10	N/A
vtty 0	bob	idle	00:00:03	172.16.11.3	1	0	5

Table 1: Parameters in the output of the **show users** command

Parameter	Description
Line	Console port user is connected to.
User	Login name of user.
Host(s)	Status of the host the user is connected to.
Idle	How long the host has been idle.
Location	URL location of user.
Priv	The privilege level in the range 1 to 15, with 15 being the highest.
Idletime	The time interval the device waits for user input from either a console or VTY connection.
Timeout	The time interval before a server is considered unreachable.

telnet

Overview Use this command to open a telnet session to a remote device.

Syntax telnet {<hostname>|[ip] <ipv4-addr>|[ipv6] <ipv6-addr>} [<port>]

Syntax (VRF-lite) telnet [vrf <vrf-name>] {<hostname>|[ip] <ipv4-addr>|[ipv6] <ipv6-addr>} [<port>]

Parameter	Description
vrf	Apply this command to a VRF instance.
<vrf-name>	The name of the VRF instance.
<hostname>	The host name of the remote system.
ip	Keyword used to specify the IPv4 address or host name of a remote system.
<ipv4-addr>	An IPv4 address of the remote system.
ipv6	Keyword used to specify the IPv6 address of a remote system
<ipv6-addr>	Placeholder for an IPv6 address in the format x:x::x:x, for example, 2001:db8::8a2e:7334
<port>	Specify a TCP port number (well known ports are in the range 1-1023, registered ports are 1024-49151, and private ports are 49152-65535).

Mode User Exec and Privileged Exec

Examples To connect to TCP port 2602 on the device at 10.2.2.2, use the command:

```
awplus# telnet 10.2.2.2 2602
```

To connect to the telnet server `host.example`, use the command:

```
awplus# telnet host.example
```

To connect to the telnet server `host.example` on TCP port 100, use the command:

```
awplus# telnet host.example 100
```

Example (VRF-lite) To open a telnet session to a remote host 192.168.0.1 associated with VRF instance `red`, use the command:

```
awplus# telnet vrf red ip 192.168.0.1
```

Command changes Version 5.4.6-2.1: VRF-lite support added.

telnet server

Overview This command enables the telnet server on the specified TCP port. If the server is already enabled then it will be restarted on the new port. Changing the port number does not affect the port used by existing sessions.

Syntax `telnet server {<1-65535>|default}`

Parameter	Description
<1-65535>	The TCP port to listen on.
default	Use the default TCP port number 23.

Mode Global Configuration

Example To enable the telnet server on TCP port 2323, use the following commands:

```
awplus# configure terminal
awplus(config)# telnet server 2323
```

Related Commands [show telnet](#)

terminal length

Overview Use the **terminal length** command to specify the number of rows of output that the device will display before pausing, for the currently-active terminal only.

Use the **terminal no length** command to remove the length specified by this command. The default length will apply unless you have changed the length for some or all lines by using the [length \(asyn\)](#) command.

Syntax `terminal length <length>`
`terminal no length [<length>]`

Parameter	Description
<code><length></code>	<code><0-512></code> Number of rows that the device will display on the currently-active terminal before pausing.

Mode User Exec and Privileged Exec

Examples The following example sets the number of lines to 15:

```
awplus# terminal length 15
```

The following example removes terminal length set previously:

```
awplus# terminal no length
```

Related Commands [terminal resize](#)
[length \(asyn\)](#)

terminal resize

Overview Use this command to automatically adjust the number of rows of output on the console, which the device will display before pausing, to the number of rows configured on the user's terminal.

Syntax `terminal resize`

Mode User Exec and Privileged Exec

Usage When the user's terminal size is changed, then a remote session via SSH or TELNET adjusts the terminal size automatically. However, this cannot normally be done automatically for a serial or console port. This command automatically adjusts the terminal size for a serial or console port.

Examples The following example automatically adjusts the number of rows shown on the console:

```
awplus# terminal resize
```

**Related
Commands** [length \(asyn\)](#)
[terminal length](#)

username

Overview This command creates or modifies a user to assign a privilege level and a password.

NOTE: *The default username privilege level of 1 is not shown in running-config output. Any username privilege level that has been modified from the default is shown.*

Syntax

```
username <name> privilege <1-15> [password [8] <password>]
username <name> password [8] <password>
no username <name>
```

Parameter	Description
<name>	The login name for the user. Do not use punctuation marks such as single quotes (' '), double quotes (" "), or colons (:) with the user login name.
privilege	The user's privilege level. Use the privilege levels to set the access rights for each user. <1-15> A privilege level: either 1-14 (limited access) or 15 (full access). A user with privilege level 1-14 can only access higher privilege levels if an enable password has been configured for the level the user tries to access and the user enters that password. A user at privilege level 1 can access the majority of show commands. A user at privilege level 7 can access the majority of show commands including platform show commands. Privilege Level 15 (to access the Privileged Exec command mode) is required to access configuration commands as well as show commands in Privileged Exec.
password	A password that the user must enter when logging in. 8 Specifies that you are entering a password as a string that has already been encrypted, instead of entering a plain-text password. The running-config displays the new password as an encrypted string even if password encryption is turned off. Note that the user enters the plain-text version of the password when logging in. <password> The user's password. The password can be up to 23 characters in length and include characters from up to four categories. The password categories are: <ul style="list-style-type: none"> uppercase letters: A to Z lowercase letters: a to z digits: 0 to 9 special symbols: all printable ASCII characters not included in the previous three categories. The question mark ? cannot be used as it is reserved for help functionality.

Mode Global Configuration

Default The privilege level is 1 by default. Note the default is not shown in running-config output.

Usage An intermediate CLI security level (privilege level 7 to privilege level 14) allows a CLI user access to the majority of show commands, including the platform show commands that are available at privilege level 1 to privilege level 6. Note that some show commands, such as **show running-configuration** and **show startup-configuration**, are only available at privilege level 15.

Examples To create the user "bob" with a privilege level of 15, for all show commands including show running-configuration and show startup-configuration and to access configuration commands in Privileged Exec command mode, and the password "bobs_secret", use the commands:

```
awplus# configure terminal
awplus(config)# username bob privilege 15 password bobs_secret
```

To create a user "junior_admin" with a privilege level of 7, which will have intermediate CLI security level access for most show commands, and the password "show_only", use the commands:

```
awplus# configure terminal
awplus(config)# username junior_admin privilege 7 password
show_only
```

Related Commands [enable password](#)
[security-password minimum-categories](#)
[security-password minimum-length](#)

4

Subscription Licensing Commands

Introduction

Overview This chapter provides an alphabetical reference for each of the Subscription Licensing commands.

Subscription Licensing enables you to use the advanced threat protection features on your next-generation firewall. To see the advanced threat protection subscriptions for your device, see the [NGFW Features Datasheet](#).

For Software Version 5.4.6-1.x and later, Subscription Licensing enables you to use Allied Telesis Management Framework (AMF). You need to purchase an AMF subscription for each AMF master or controller node in your AMF network. To see the AMF subscriptions for your device, see the [AlliedWare Plus Datasheet](#).

For step-by-step instructions about how to license AlliedWare Plus devices, see the [Licensing Feature Overview and Configuration Guide](#).

- Command List**
- “[license update \(filename\)](#)” on page 208
 - “[license update online](#)” on page 209
 - “[show license external](#)” on page 211

license update (filename)

Overview Use this command to load a license, after you have manually copied the license file onto the device.

Only use this command if you cannot directly access the [Allied Telesis Download Center](#) from this device. Otherwise, use the command [license update online](#) instead.

Syntax `license update <filename>`

Parameter	Description
<code><filename></code>	Name and path of the license file on the device.

Mode Privileged Exec

Usage You can download subscription licenses from the [Allied Telesis Download Center](#), in order to copy them onto the device.

Examples To load a license onto a device from a file called "license_file.bin" that is stored at the top level of Flash memory, use the following command:

```
awplus#license update license_file.bin
```

Related Commands [license update online](#)
[show license external](#)

Command changes Version 5.4.6-2.1: usage changed by introduction of [license update online](#)

license update online

Overview Use this command to add or update subscription licenses from the [Allied Telesis Download Center](#), to subscribe to features such as advanced threat management and AMF master.

When you enter this command, the device will:

- 1) Connect to the Download Center
- 2) Check if new or changed licenses are available for the device, keyed to the device's serial number
- 3) For each such license it finds, download and install the license.

Syntax `license update online`

Default AlliedWare Plus devices do not automatically connect to the Download Center and check whether licenses are available. They only check when you run the **license update online** command.

Mode User Exec/Privileged Exec

Usage **Firewall rule**

AR-series firewalls block all traffic by default, so you need to configure a firewall rule to allow the licensing connection attempt to pass through the firewall. The following figure shows a recommended example configuration, when the WAN interface to the Internet is configured as a ppp0 interface:

```
zone public
network wan
  ip subnet 0.0.0.0/0 interface ppp0
  host ppp0
  ip address dynamic interface ppp0

firewall
rule 10 permit dns from public.wan.ppp0 to public.wan
rule 20 permit https from public.wan.ppp0 to public.wan
protect
```

This rule permits DNS and HTTPS packets to any destination IP address, if:

- the source IP address of the packets is the IP address of the ppp0 interface, and
- the packets are egressing the firewall through interface ppp0.

DNS packets are permitted so that the device can look up the address of the Download Center. HTTPS packets are permitted so the secure communication session with the Download Center can proceed.

The rule uses a subnet of 0.0.0.0/0 to match on any destination IP address.

The “from” part of the rule uses “public.wan.ppp0” because the firewall itself is originating the connection to the Download Center, rather than allowing traffic to flow through it, as is the case for most firewall rules. Hence, the traffic that is involved in the connection to the Download Center originates from the IP address of the PPP interface.

Verifying the update

The update process normally takes approximately 5 seconds.

If the console does not respond for 10 or more seconds after typing the command, a network, routing or firewall configuration error is probably preventing the connection from establishing. If this happens, you can abort the command by pressing Ctrl-C, or wait for the command to time out after 30 seconds.

If the connection to the Download Centers fails and times out, an error message will be generated on the CLI to indicate the problem. If you abort the command, no error message is displayed.

If the update is successful, the device will produce log messages to say which features have had their licensing state updated (activated, deactivated, number of items changed, or expiry date changed). If the command completes successfully but there are no licenses available for the device, or no change in the licenses already on the device, no log messages will be produced.

You should also use the [show license external](#) command to confirm which licenses are active on the device after the update has been applied.

Example To add a subscription license, use the command:

```
awplus# license update online
```

Related Commands [show license external](#)

Command changes Version 5.4.6-2.1: command added

show license external

Overview Use this command to show information about subscription (external) licenses.

Syntax show license external

Mode Privileged Exec

Examples To show information about what subscription features the device is licensed for, use the following command:

```
awplus#show license external
```

Output Figure 4-1: Example output from **show license external**

```
awplus#show license external
Licensed features:

Application Control (Procera)
Start date           : 24-Feb-2015 12:00AM
Expiry date          : 24-Feb-2016 11:59PM

Web Control (Digital Arts)
Start date           : 24-Feb-2015 12:00AM
Expiry date          : 24-Feb-2016 11:59PM
```

Related Commands [license update online](#)

5

GUI Commands

Introduction

Overview This chapter provides an alphabetical reference of commands used to configure the GUI. For more information, see the [“Getting Started with AlliedWare Plus” Feature Overview and Configuration Guide](#)

- Command List**
- [“atmf topology-gui enable”](#) on page 213
 - [“http secure-port”](#) on page 214
 - [“log event-host”](#) on page 215
 - [“service http”](#) on page 216
 - [“show http”](#) on page 217
 - [“update webgui now”](#) on page 218

atmf topology-gui enable

Overview Use this command to enable the operation of Vista Manager EX on the Master device.

Vista Manager EX delivers state-of-the-art monitoring and management for your Autonomous Management Framework™ (AMF) network, by automatically creating a complete topology map of switches, firewalls and wireless access points (APs). An expanded view includes third-party devices such as security cameras.

Use the **no** variant of this command to disable operation of Vista Manager EX.

Syntax atmf topology-gui enable
no atmf topology-gui enable

Default Disabled by default on AMF Master and member nodes. Enabled by default on Controllers.

Mode Global Configuration mode

Usage To use Vista Manager EX, you must also enable the HTTP service on all AMF nodes, including all AMF masters and controllers. The HTTP service is enabled by default on AlliedWare Plus switches and disabled by default on AR-Series firewalls. To enable it, use the commands:

```
Node1# configure terminal
Node1(config)# service http
```

On one master in each AMF area in your network, you also need to configure the master to send event notifications to Vista Manager EX. To do this, use the commands:

```
Node1# configure terminal
Node1(config)# log event-host <ip-address> atmf-topology-event
```

Example To enable Vista Manager EX on Node1, use the following commands:

```
Node1# configure terminal
Node1(config)# atmf topology-gui enable
```

To disable Vista Manager EX on Node1, use the following commands:

```
Node1# configure terminal
Node1(config)# no atmf topology-gui enable
```

**Related
Commands** [atmf enable](#)
[log event-host](#)
[service http](#)

http secure-port

Overview Use this command to change the HTTPS port used to access the Firewall GUI. Use the **no** variant of this command to return to using the default port, which is 443.

Syntax `http secure-port <1-65535>`
`no http secure-port`

Parameter	Description
<code><1-65535></code>	The HTTPS port number

Default This command is disabled by default and port 443 is used for accessing the GUI.

Mode Global Configuration

Usage Note that any device on which a non-default secure port is set will have limited capabilities when accessed via Vista Manager. Additionally, all external API requests will need to be directed to the configured port, instead of the default port 443.

Example To set the port to 8443, use the commands:

```
awplus# configure terminal
awplus(config)# http secure-port 8443
```

To return to using the default port of 443, use the commands:

```
awplus# configure terminal
awplus(config)# no http secure-port
```

**Related
Commands** [service http](#)
[show http](#)

**Command
changes** Version 5.4.7-1.1: command added

log event-host

Overview Use this command to set up an external host to log AMF topology events through Vista Manager. This command is run on the Master device.

Use the **no** variant of this command to disable log events through Vista Manager.

Syntax `log event-host [<ipv4-addr>|<ipv6-addr>] atmf-topology-event`
`no log event-host [<ipv4-addr>|<ipv6-addr>] atmf-topology-event`

Parameter	Description
<code><ipv4-addr></code>	ipv4 address of the event host
<code><ipv6-addr></code>	ipv6 address of the event host

Default Log events are disabled by default.

Mode Global Configuration

Usage Event hosts are set so syslog sends the messages out as they come.

NOTE: *There is a difference between log event and log host messages:*

- Log event messages are sent out as they come by syslog
- Log host messages are set to wait for a number of messages (20) to send them out together for traffic optimization.

Example To enable Node 1 to log event messages from host IP address 192.0.2.31, use the following commands:

```
Node1# configure terminal
```

```
Node1(config)# log event-host 192.0.2.31 atmf-topology-event
```

To disable Node 1 to log event messages from host IP address 192.0.2.31, use the following commands:

```
Node1# configure terminal
```

```
Node1(config)# no log event-host 192.0.2.31 atmf-topology-event
```

Related Commands [atmf topology-gui enable](#)

service http

Overview Use this command to enable the HTTP (Hypertext Transfer Protocol) service. This service is required to support Vista Manager EX™ and the Firewall GUI. Use the **no** variant of this command to disable the HTTP feature.

Syntax `service http`
`no service http`

Default Disabled

Mode Global Configuration

Example To enable the HTTP service, use the following commands:

```
awplus# configure terminal  
awplus(config)# service http
```

To disable the HTTP service, use the following commands:

```
awplus# configure terminal  
awplus(config)# no service http
```

**Validation
Commands** `show running-config`

show http

Overview This command shows the HTTP server settings.

Syntax show http

Mode User Exec and Privileged Exec

Example To show the HTTP server settings, use the command:

```
awplus# show http
```

Output Figure 5-1: Example output from the **show http** command

```
awplus#show http
HTTP Server Configuration
-----
HTTP server           : Enabled
Port                  : 80
Web GUI Information
-----
GUI file in use       : webgui
GUI version:          : 3.1
```

**Related
Commands** [clear line vty](#)
[service http](#)

update webgui now

Overview Use this command to check whether you have the latest version of the device's GUI and update it if a newer version is available.

Syntax `update webgui now`

Mode Privileged Exec

Usage This command applies since software version 5.4.6-1.1. Prior to 5.4.6-1.1, users used the **copy** command to copy GUI files onto the AR-series firewall instead. If you did that, you need to delete all GUI files from Flash memory before you run the "update webgui now" command. To delete all GUI files, use the command:

```
awplus#del *gui_*.tar.gz
```

Examples To check for GUI updates, use the following command:

```
awplus#update webgui now
```

**Related
Commands** [show resource](#)

6

Update Manager Commands

Introduction

This chapter provides an alphabetical reference of commands used to update a resource. For more information, see the [Update Manager Feature Overview and Configuration_Guide](#).

- Command List**
- “[show resource](#)” on page 220
 - “[update now](#)” on page 222
 - “[update webgui now](#)” on page 223

show resource

Overview Use this command to show information about the resources of features that have been enabled.

Syntax `show resource [<resource_name>]`

Parameter	Description
<code><resource_name></code>	Specific resource to show

Mode Privileged Exec

Examples To show information about the resources of features that have been enabled, use the following command:

```
awplus#show resource
```

Output Figure 6-1: Example output for the **show resource** command

Table 6-1:

```
awplus#show resource
-----
Resource Name      Status      Version      Interval      Last Download      Next Download Check
-----
iprep_et_rules    Checking    1.1          4              Wed Dec 31 23:59:00 2013
                  hours      Thu Jan 1 01:00:00 2014
```

The parameters in the example output are explained in the following table.

Parameter	Description
Resource Name	Name of the updatable resource
Status	Resource status. There are five types of status: Sleeping, Checking, Starting, Downloading, Stopping.
Version	Current version of the resource
Interval	Configured update check interval for the resource
Last Download	Time stamp of last resource downloaded
Next Download Check	Time stamp of next download check for the resource

Related Commands [update-interval \(Antivirus\)](#)
[update-interval \(Application Control\)](#)

update-interval (IP Reputation)
update-interval (Malware Protection)
update now
update webgui now

update now

Overview Use this command to immediately perform a resource update check and update the specified resource if a newer version is available.

Syntax `update {<resource-name>|all} now`

Parameter	Description
<code><resource-name></code>	Specific resource to show. You will get an error message if the resource does not exist.
<code>all</code>	Update all resources

Mode Privileged Exec

Usage The default update interval for a resource is 1 hour. Users can initiate an immediate update check for a resource at any time without affecting any configured update check schedule. The Update Manager will perform an update check for a resource when triggered to do so. The Update Manager will request the current version number of the resource from the Update Server, then compare it with the current local version. If they are different, the Update Manager will initiate an update of the local resource.

Note that if the feature is disabled, regular and manual update checks for its resources are also disabled.

Also note that an update check for a resource will not proceed if an update of that resource is already in progress.

The Update Manager will retry upon failure to download a resource file because of DNS resolution error, bad checksum and so on.

Examples To immediately do an update check and update if needed for all available resources, use the following command:

```
awplus#update all now
```

To immediately do an update check and update if needed for the IP Reputation feature, use the following command:

```
awplus#update iprep_et_rules now
```

Related Commands

- [show resource](#)
- [update-interval \(Antivirus\)](#)
- [update-interval \(Application Control\)](#)
- [update-interval \(IP Reputation\)](#)
- [update-interval \(Malware Protection\)](#)
- [update webgui now](#)

update webgui now

Overview Use this command to check whether you have the latest version of the device's GUI and update it if a newer version is available.

Syntax `update webgui now`

Mode Privileged Exec

Usage This command applies since software version 5.4.6-1.1. Prior to 5.4.6-1.1, users used the **copy** command to copy GUI files onto the AR-series firewall instead. If you did that, you need to delete all GUI files from Flash memory before you run the "update webgui now" command. To delete all GUI files, use the command:

```
awplus#del *gui_*.tar.gz
```

Examples To check for GUI updates, use the following command:

```
awplus#update webgui now
```

Related Commands [show resource](#)

7

System Configuration and Monitoring Commands

Introduction

Overview This chapter provides an alphabetical reference of commands for configuring and monitoring the system.

- Command List**
- `"banner exec"` on page 226
 - `"banner login (system)"` on page 228
 - `"banner motd"` on page 230
 - `"clock set"` on page 232
 - `"clock summer-time date"` on page 233
 - `"clock summer-time recurring"` on page 235
 - `"clock timezone"` on page 237
 - `"hostname"` on page 238
 - `"max-fib-routes"` on page 240
 - `"max-static-routes"` on page 242
 - `"no debug all"` on page 243
 - `"reboot"` on page 245
 - `"reload"` on page 246
 - `"show clock"` on page 247
 - `"show cpu"` on page 249
 - `"show cpu history"` on page 252
 - `"show debugging"` on page 254
 - `"show interface memory"` on page 255
 - `"show memory"` on page 257
 - `"show memory allocations"` on page 259

- “show memory history” on page 261
- “show memory pools” on page 262
- “show memory shared” on page 263
- “show process” on page 264
- “show reboot history” on page 266
- “show router-id” on page 267
- “show system” on page 268
- “show system environment” on page 269
- “show system interrupts” on page 270
- “show system mac” on page 271
- “show system pci device” on page 272
- “show system pci tree” on page 273
- “show system serialnumber” on page 274
- “show tech-support” on page 275
- “speed (asyn)” on page 277
- “terminal monitor” on page 279
- “undebug all” on page 280

banner exec

Overview This command configures the User Exec mode banner that is displayed on the console after you login. The **banner exec default** command restores the User Exec banner to the default banner. Use the **no banner exec** command to disable the User Exec banner and remove the default User Exec banner.

Syntax banner exec <banner-text>
banner exec default
no banner exec

Default By default, the AlliedWare Plus™ version and build date is displayed at console login, such as:

```
AlliedWare Plus (TM) 5.4.7 01/03/17 12:00:00
```

Mode Global Configuration

Examples To configure a User Exec mode banner after login (in this example, to tell people to use the **enable** command to move to Privileged Exec mode), enter the following commands:

```
awplus#configure terminal
awplus(config)#banner exec Use enable to move to Priv Exec mode
awplus(config)#exit
awplus#exit

awplus login: manager
Password:

Use enable to move to Priv Exec mode

awplus>
```

To restore the default User Exec mode banner after login, enter the following commands:

```
awplus#configure terminal
awplus(config)#banner exec default
awplus(config)#exit
awplus#exit

awplus login: manager
Password:

AlliedWare Plus (TM) 5.4.7 01/03/17 12:00:00

awplus>
```

To remove the User Exec mode banner after login, enter the following commands:

```
awplus#configure terminal
awplus(config)#no banner exec
awplus(config)#exit
awplus#exit

awplus login: manager
Password:

awplus>
```

**Related
Commands** [banner login \(system\)](#)
[banner motd](#)

banner login (system)

Overview This command configures the login banner that is displayed on the console when you login. The login banner is displayed on all connected terminals. The login banner is displayed after the MOTD (Message-of-the-Day) banner and before the login username and password prompts.

Use the **no banner login** command to disable the login banner.

Syntax banner login
no banner login

Default By default, no login banner is displayed at console login.

Mode Global Configuration

Examples To configure a login banner of “Authorized users only” to be displayed when you login, enter the following commands:

```
awplus#configure terminal
awplus(config)#banner login
Type CNTL/D to finish.

Authorized users only

awplus(config)#exit
awplus#exit

Authorized users only

awplus login: manager
Password:

AlliedWare Plus (TM) 5.4.7 01/03/17 12:00:00

awplus>
```

To remove the login banner, enter the following commands:

```
awplus#configure terminal
awplus(config)#no banner login
awplus(config)#exit
awplus#exit

awplus login: manager
Password:

AlliedWare Plus (TM) 5.4.7 01/03/17 12:00:00

awplus>
```

**Related
Commands** [banner exec](#)
[banner motd](#)

banner motd

Overview Use this command to create or edit the text MotD (Message-of-the-Day) banner displayed before login. The MotD banner is displayed on all connected terminals. The MotD banner is useful for sending messages that affect all network users, for example, any imminent system shutdowns.

Use the **no** variant of this command to delete the MotD banner.

Syntax `banner motd <motd-text>`
`no banner motd`

Parameter	Description
<code><motd-text></code>	The text to appear in the Message of the Day banner.

Default By default, the device displays the AlliedWare Plus™ OS version and build date when you login.

Mode Global Configuration

Examples To configure a MotD banner of "System shutdown at 6pm today" to be displayed when you log in, enter the following commands:

```
awplus>enable
awplus#configure terminal
Enter configuration commands, one per line. End with CNTL/Z.
awplus(config)#banner motd System shutdown at 6pm today
awplus(config)#exit
awplus#exit

System shutdown at 6pm today
awplus login: manager
Password:

AlliedWare Plus (TM) 5.4.7 01/03/17 12:00:00

awplus>
```

To delete the login banner, enter the following commands:

```
awplus>enable
awplus#configure terminal
Enter configuration commands, one per line.  End with CNTL/Z.
awplus(config)#no banner motd
awplus(config)#exit
awplus#exit

awplus login: manager
Password:

AlliedWare Plus (TM) 5.4.7 01/03/17 12:00:00

awplus>
```

**Related
Commands** [banner exec](#)
[banner login \(system\)](#)

clock set

Overview This command sets the time and date for the system clock.

Syntax `clock set <hh:mm:ss> <day> <month> <year>`

Parameter	Description
<hh:mm:ss>	Local time in 24-hour format
<day>	Day of the current month, from 1 to 31
<month>	The first three letters of the current month
<year>	Current year, from 2000 to 2035

Mode Privileged Exec

Usage Configure the timezone before setting the local time. Otherwise, when you change the timezone, the device applies the new offset to the local time.

NOTE: *If Network Time Protocol (NTP) is enabled, then you cannot change the time or date using this command. NTP maintains the clock automatically using an external time source. If you wish to manually alter the time or date, you must first disable NTP.*

Example To set the time and date on your system to 2pm on the 2nd of October 2016, use the command:

```
awplus# clock set 14:00:00 2 oct 2016
```

Related Commands [clock timezone](#)

clock summer-time date

Overview This command defines the start and end of summertime for a specific year only, and specifies summertime's offset value to Standard Time for that year.

The **no** variant of this command removes the device's summertime setting. This clears both specific summertime dates and recurring dates (set with the [clock summer-time recurring](#) command).

By default, the device has no summertime definitions set.

Syntax

```
clock summer-time <timezone-name> date <start-day>
<start-month> <start-year> <start-time> <end-day> <end-month>
<end-year> <end-time> <1-180>

no clock summer-time
```

Parameter	Description
<timezone-name>	A description of the summertime zone, up to 6 characters long.
date	Specifies that this is a date-based summertime setting for just the specified year.
<start-day>	Day that the summertime starts, from 1 to 31.
<start-month>	First three letters of the name of the month that the summertime starts.
<start-year>	Year that summertime starts, from 2000 to 2035.
<start-time>	Time of the day that summertime starts, in the 24-hour time format HH:MM.
<end-day>	Day that summertime ends, from 1 to 31.
<end-month>	First three letters of the name of the month that the summertime ends.
<end-year>	Year that summertime ends, from 2000 to 2035.
<end-time>	Time of the day that summertime ends, in the 24-hour time format HH:MM.
<1-180>	The offset in minutes.

Mode Global Configuration

Examples To set a summertime definition for New Zealand using NZST (UTC+12:00) as the standard time, and NZDT (UTC+13:00) as summertime, with the summertime set to begin on the 25th of September 2016 and end on the 2nd of April 2017:

```
awplus(config)# clock summer-time NZDT date 25 sep 2:00 2016 2
apr 2:00 2017 60
```

To remove any summertime settings on the system, use the command:

```
awplus(config)# no clock summer-time
```

**Related
Commands** [clock summer-time recurring](#)
[clock timezone](#)

clock summer-time recurring

Overview This command defines the start and end of summertime for every year, and specifies summertime's offset value to Standard Time.

The **no** variant of this command removes the device's summertime setting. This clears both specific summertime dates (set with the [clock summer-time date](#) command) and recurring dates.

By default, the device has no summertime definitions set.

Syntax

```
clock summer-time <timezone-name> recurring <start-week>
<start-day> <start-month> <start-time> <end-week> <end-day>
<end-month> <end-time> <1-180>

no clock summer-time
```

Parameter	Description
<timezone-name>	A description of the summertime zone, up to 6 characters long.
recurring	Specifies that this summertime setting applies every year from now on.
<start-week>	Week of the month when summertime starts, in the range 1-5. The value 5 indicates the last week that has the specified day in it for the specified month. For example, to start summertime on the last Sunday of the month, enter 5 for <start-week> and sun for <start-day>.
<start-day>	Day of the week when summertime starts. Valid values are mon, tue, wed, thu, fri, sat or sun.
<start-month>	First three letters of the name of the month that summertime starts.
<start-time>	Time of the day that summertime starts, in the 24-hour time format HH:MM.
<end-week>	Week of the month when summertime ends, in the range 1-5. The value 5 indicates the last week that has the specified day in it for the specified month. For example, to end summertime on the last Sunday of the month, enter 5 for <end-week> and sun for <end-day>.
<end-day>	Day of the week when summertime ends. Valid values are mon, tue, wed, thu, fri, sat or sun.
<end-month>	First three letters of the name of the month that summertime ends.
<end-time>	Time of the day that summertime ends, in the 24-hour time format HH:MM.
<1-180>	The offset in minutes.

Mode Global Configuration

Examples To set a summertime definition for New Zealand using NZST (UTC+12:00) as the standard time, and NZDT (UTC+13:00) as summertime, with summertime set to start on the last Sunday in September, and end on the 1st Sunday in April, use the command:

```
awplus(config)# clock summer-time NZDT recurring 5 sun sep 2:00  
1 sun apr 2:00 60
```

To remove any summertime settings on the system, use the command:

```
awplus(config)# no clock summer-time
```

**Related
Commands** [clock summer-time date](#)
[clock timezone](#)

clock timezone

Overview This command defines the device's clock timezone. The timezone is set as a offset to the UTC.

The **no** variant of this command resets the system time to UTC.

By default, the system time is set to UTC.

Syntax `clock timezone <timezone-name> {minus|plus}
[<0-13>|<0-12>:<00-59>]`
`no clock timezone`

Parameter	Description
<timezone-name>	A description of the timezone, up to 6 characters long.
minusorplus	The direction of offset from UTC. The minus option indicates that the timezone is behind UTC. The plus option indicates that the timezone is ahead of UTC.
<0-13>	The offset in hours or from UTC.
<0-12>:<00-59>	The offset in hours or from UTC.

Mode Global Configuration

Usage Configure the timezone before setting the local time. Otherwise, when you change the timezone, the device applies the new offset to the local time.

Examples To set the timezone to New Zealand Standard Time with an offset from UTC of +12 hours, use the command:

```
awplus(config)# clock timezone NZST plus 12
```

To set the timezone to Indian Standard Time with an offset from UTC of +5:30 hours, use the command:

```
awplus(config)# clock timezone IST plus 5:30
```

To set the timezone back to UTC with no offsets, use the command:

```
awplus(config)# no clock timezone
```

Related Commands [clock set](#)
[clock summer-time date](#)
[clock summer-time recurring](#)

hostname

Overview This command sets the name applied to the device as shown at the prompt. The hostname is:

- displayed in the output of the [show system](#) command
- displayed in the CLI prompt so you know which device you are configuring
- stored in the MIB object sysName

Use the **no** variant of this command to revert the hostname setting to its default. For devices that are not part of an AMF network, the default is “awplus”.

Syntax `hostname <hostname>`
`no hostname [<hostname>]`

Parameter	Description
<code><hostname></code>	Specifies the name given to a specific device.

Default `awplus`

Mode Global Configuration

Usage Within an AMF network, any device without a user-defined hostname will automatically be assigned a name based on its MAC address.

To efficiently manage your network using AMF, we strongly advise that you devise a naming convention for your network devices and apply an appropriate hostname to each device.

The name must also follow the rules for ARPANET host names. The name must start with a letter, end with a letter or digit, and use only letters, digits, and hyphens. Refer to RFC 1035.

Example To set the system name to `HQ-Sales`, use the command:

```
awplus# configure terminal
awplus(config)# hostname HQ-Sales
```

This changes the prompt to:

```
HQ-Sales(config)#
```

To revert to the default hostname `awplus`, use the command:

```
HQ-Sales(config)# no hostname
```

This changes the prompt to:

```
awplus(config)#
```

NOTE: When AMF is configured, running the **no hostname** command will apply a hostname that is based on the MAC address of the device node, for example, **node_0000_5e00_5301**.

**Related
Commands** [show system](#)

max-fib-routes

Overview This command enables you to control the maximum number of FIB routes configured. It operates by providing parameters that enable you to configure preset maximums and warning message thresholds.

NOTE: When using VRF-lite, this command applies to the Global VRF instance; to set the max-fib-routes for a user-defined VRF instance use the *max-fib-routes (VRF)* command. For static routes use the *max-static-routes* command for the Global VRF instance and the *max-static-routes (VRF)* command for a user-defined VRF instance.

Use the **no** variant of this command to set the maximum number of FIB routes to the default of 4294967294 FIB routes.

Syntax max-fib-routes <1-4294967294> [<1-100>|warning-only]
no max-fib-routes

Parameter	Description
max-fib-routes	This is the maximum number of routes that can be stored in the device's Forwarding Information dataBase. In practice, other practical system limits would prevent this maximum being reached.
<1-4294967294>	The allowable configurable range for setting the maximum number of FIB-routes.
<1-100>	This parameter enables you to optionally apply a percentage value. This percentage will be based on the maximum number of FIB routes you have specified. This will cause a warning message to appear when your routes reach your specified percentage value. Routes can continue to be added until your configured maximum value is reached.
warning-only	This parameter enables you to optionally apply a warning message. If you set this option a warning message will appear if your maximum configured value is reached. Routes can continue to be added until your device reaches either the maximum capacity value of 4294967294, or a practical system limit.

Default The default number of FIB routes is the maximum number of FIB routes (4294967294).

Mode Global Configuration

Examples To set the maximum number of dynamic routes to 2000 and warning threshold of 75%, use the following commands:

```
awplus# config terminal  
awplus(config)# max-fib-routes 2000 75
```

**Related
Commands** [max-fib-routes \(VRF\)](#)

max-static-routes

Overview Use this command to set the maximum number of static routes, excluding FIB (Forwarding Information Base) routes.

NOTE: For FIB routes use the [max-fib-routes](#) command.

Use the **no** variant of this command to set the maximum number of static routes to the default of 1024 static routes.

Syntax `max-static-routes <1-1024>`
`no max-static-routes`

Default The default number of static routes is the maximum number of static routes (1024).

Mode Global Configuration

Example To reset the maximum number of static routes to the default maximum, use the command:

```
awplus# configure terminal
awplus(config)# no max-static-routes
```

NOTE: Static routes are applied before adding routes to the RIB (Routing Information Base). Therefore, rejected static routes will not appear in the running config.

Related Commands [max-fib-routes](#)

no debug all

Overview This command disables the debugging facility for all features on your device. This stops the device from generating any diagnostic debugging messages.

The debugging facility is disabled by default.

Syntax `no debug all [ipv6|nsm|ospf|pim sparse-mode|rip|vrrp]`

Parameter	Description
bgp	Turns off all debugging for BGP (Border Gateway Protocol).
ipv6	Turns off all debugging for IPv6 (Internet Protocol version 6).
nsm	Turns off all debugging for the NSM (Network Services Module).
ospf	Turns off all debugging for OSPF (Open Shortest Path First).
pim sparse-mode	Turns off all debugging for PIM (Protocol Independent Multicast) Sparse Mode.
rip	Turns off all debugging for RIP (Routing Information Protocol).
vrrp	Turns off all debugging for VRRP (Virtual Router Redundancy Protocol).

Mode Global Configuration and Privileged Exec

Example To disable debugging for all features, use the command:

```
awplus# no debug all
```

To disable all bgp debugging, use the command:

```
awplus# no debug all bgp
```

To disable all IPv6 debugging, use the command:

```
awplus# no debug all ipv6
```

To disable all NSM debugging, use the command:

```
awplus# no debug all nsm
```

To disable all OSPF debugging, use the command:

```
awplus# no debug all ospf
```

To disable all PIM Sparse Mode debugging, use the command:

```
awplus# no debug all pim sparse-mode
```

To disable all RIP debugging, use the command:

```
awplus# no debug all rip
```

To disable all VRRP debugging, use the command:

```
awplus# no debug all vrrp
```

**Related
Commands** [undebug all](#)

**Command
changes** Version 5.4.7-1.1: PIM Sparse Mode parameter added
Version 5.4.7-1.1: RIP parameter added

reboot

Overview This command halts the device and performs a cold restart (also known as reload). It displays a confirmation request before restarting.

Syntax `reboot`
`reload`

Mode Privileged Exec

Usage The **reboot** and **reload** commands perform the same action.

Examples To restart the device, use the command:

```
awplus# reboot
reboot system? (y/n): y
```

reload

Overview This command performs the same function as the [reboot](#) command.

show clock

Overview This command displays the system's current configured local time and date. It also displays other clock related information such as timezone and summertime configuration.

Syntax show clock

Mode User Exec and Privileged Exec

Example To display the system's current local time, use the command:

```
awplus# show clock
```

Output Figure 7-1: Example output from the **show clock** command for a device using New Zealand time

```
Local Time: Mon, 17 Oct 2016 13:56:06 +1200
UTC Time: Mon, 17 Oct 2016 01:56:06 +0000
Timezone: NZST
Timezone Offset: +12:00
Summer time zone: NZDT
Summer time starts: Last Sunday in September at 02:00:00
Summer time ends: First Sunday in April at 02:00:00
Summer time offset: 60 mins
Summer time recurring: Yes
```

Table 1: Parameters in the output of the **show clock** command

Parameter	Description
Local Time	Current local time.
UTC Time	Current UTC time.
Timezone	The current configured timezone name.
Timezone Offset	Number of hours offset to UTC.
Summer time zone	The current configured summertime zone name.
Summer time starts	Date and time set as the start of summer time.
Summer time ends	Date and time set as the end of summer time.
Summer time offset	Number of minutes that summer time is offset from the system's timezone.
Summer time recurring	Whether the device will apply the summer time settings every year or only once.

**Related
Commands** [clock set](#)
[clock summer-time date](#)
[clock summer-time recurring](#)
[clock timezone](#)

show cpu

Overview This command displays a list of running processes with their CPU utilization.

For information on filtering and saving command output, see the [“Getting Started with AlliedWare Plus” Feature Overview and Configuration Guide](#).

Syntax `show cpu [sort {thrds|pri|sleep|runtime}]`

Parameter	Description
sort	Changes the sorting order using the following fields. If you do not specify a field, then the list is sorted by percentage CPU utilization.
thrds	Sort by the number of threads.
pri	Sort by the process priority.
sleep	Sort by the average time sleeping.
runtime	Sort by the runtime of the process.

Mode User Exec and Privileged Exec

Examples To show the CPU utilization of current processes, sorting them by the number of threads the processes are using, use the command:

```
awplus# show cpu sort thrds
```

Output Figure 7-2: Example output from **show cpu**

```
awplus#show cpu
CPU averages:
 1 second: 0%, 20 seconds: 0%, 60 seconds: 0%
System load averages:
 1 minute: 0.16, 5 minutes: 0.13, 15 minutes: 0.13
Current CPU load:
 userspace: 2%, kernel: 6%, interrupts: 0% iowaits: 0%

user processes
=====
 pid name          thrds  cpu%   pri state sleep% runtime
763 hostd          1    2.9   20  run   0    128
803 diag_monitor  1    0.4   20  sleep 0   3292
768 hsl           14    0.4   20  sleep 0   3912
 1 init           1    0.0   20  sleep 0    686
478 rtccludge     1    0.0   20  sleep 0     9
504 portmap       1    0.0   20  sleep 0     2
17555 sh          1    0.0   20  sleep 0     1
17556 console_log_ale 1    0.0   20  sleep 0     1
 515 syslog-ng    1    0.0   20  sleep 0    153
 521 dbus-daemon  1    0.0   20  sleep 0     2
 532 automount    1    0.0   20  sleep 0    453
 571 appmond      1    0.0   20  sleep 0     41
 587 crond        1    0.0   20  sleep 0     17
 589 openhpid     9    0.0   20  sleep 0    284
 609 inetd        1    0.0   20  sleep 0     2
 761 nsm           1    0.0   20  sleep 0    260
 765 imi           1    0.0   20  sleep 0    616
 799 almond       1    0.0   20  sleep 0     52
 805 cntrd        1    0.0   20  sleep 0     45
 807 poehw        3    0.0   20  sleep 0    207
 820 authd        1    0.0   20  sleep 0     76
...

kernel threads
=====
 pid name          cpu%   pri state sleep% runtime
144 aio            0.0    0  sleep  0     0
 95 bdi-default    0.0   20  sleep  0     0
149 crypto         0.0    0  sleep  0     0
474 flush-31:4    0.0   20  sleep  0     1
143 fsnotify_mark 0.0   20  sleep  0     0
426 jffs2_gcd_mtd0 0.0   30  sleep  0   353
 96 kblockd       0.0    0  sleep  0     0
 12 khelper       0.0    0  sleep  0     0
105 khubd         0.0   20  sleep  0     0
 3 ksoftirqd/0    0.0   20  sleep  0     0
142 kswapd0       0.0   20  sleep  0     0
 2 kthreadd       0.0   20  sleep  0     0
 4 kworker/0:0    0.0   20  sleep  0    29
 6 linkwatch      0.0    0  sleep  0     0
466 loop0         0.0    0  sleep  0   801
 7 migration/0    0.0  -100  sleep  0     0
244 mtblock0      0.0   20  sleep  0     5
 93 sync_supers   0.0   20  sleep  0     1
```

Table 2: Parameters in the output of the **show cpu** command

Parameter	Description
CPU averages	Average CPU utilization for the periods stated.
System load averages	The average number of processes waiting for CPU time for the periods stated.
Current CPU load	Current CPU utilization specified by load types.
pid	Identifier number of the process.
name	A shortened name for the process
thrds	Number of threads in the process.
cpu%	Percentage of CPU utilization that this process is consuming.
pri	Process priority state.
state	Process state; one of "run", "sleep", "zombie", and "dead".
sleep%	Percentage of time that the process is in the sleep state.
runtime	The time that the process has been running for, measured in jiffies. A jiffy is the duration of one tick of the system timer interrupt.

- Related Commands**
- [show memory](#)
 - [show memory allocations](#)
 - [show memory history](#)
 - [show memory pools](#)
 - [show process](#)

show cpu history

Overview This command prints a graph showing the historical CPU utilization. For information on filtering and saving command output, see the [“Getting Started with AlliedWare Plus” Feature Overview and Configuration Guide](#).

Syntax `show cpu history`

Mode User Exec and Privileged Exec

Usage This command’s output displays three graphs of the percentage CPU utilization:

- per second for the last minute, then
- per minute for the last hour, then
- per 30 minutes for the last 30 hours.

Examples To display a graph showing the historical CPU utilization of the device, use the command:

```
awplus# show cpu history
```

Output Figure 7-3: Example output from the **show cpu history** command

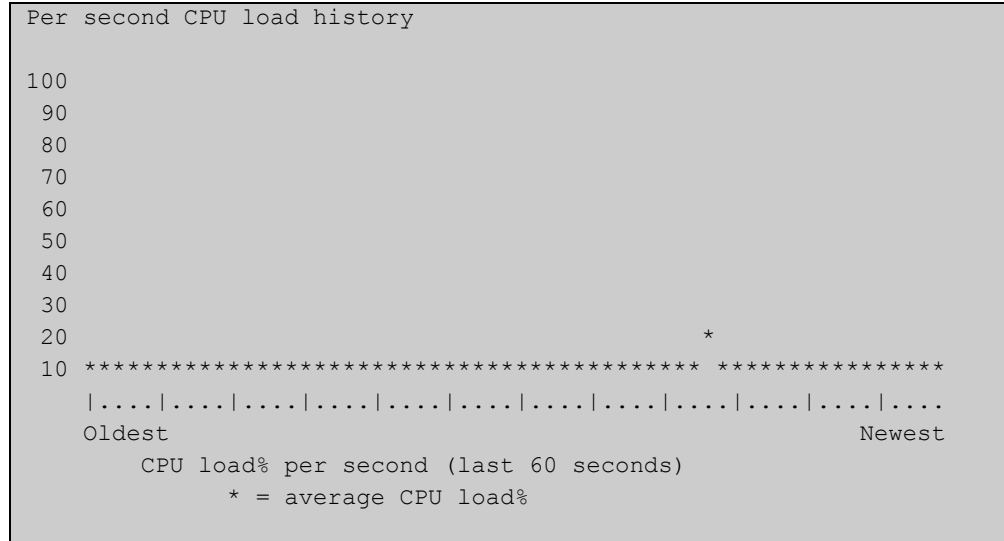

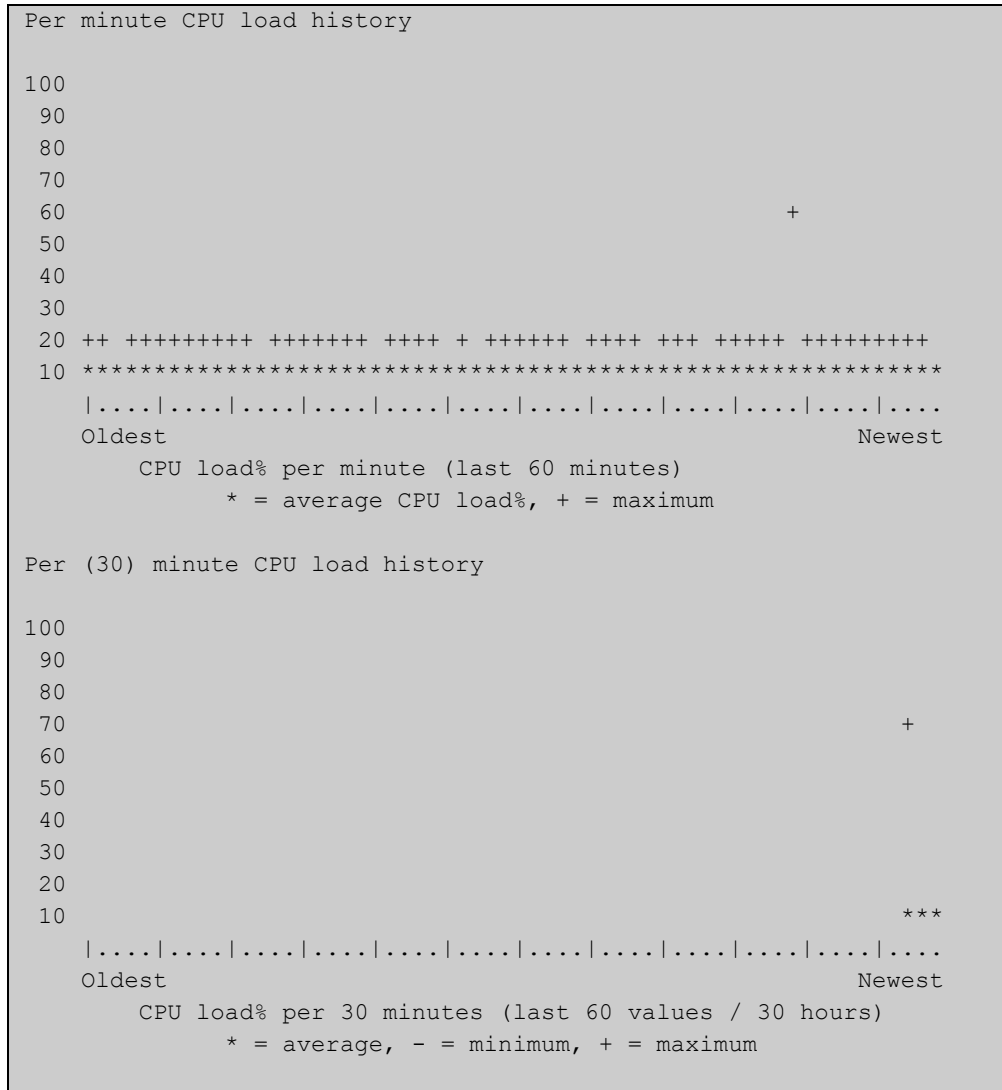

- Related Commands**
- [show memory](#)
 - [show memory allocations](#)
 - [show memory pools](#)
 - [show process](#)

show debugging

- Overview** This command displays information for all debugging options.
For information on filtering and saving command output, see the [“Getting Started with AlliedWare Plus” Feature Overview and Configuration Guide](#).
- Syntax** `show debugging`
- Default** This command runs all the **show debugging** commands in alphabetical order.
- Mode** User Exec and Privileged Exec
- Usage** This command displays all debugging information, similar to the way the [show tech-support](#) command displays all show output for use by Allied Telesis authorized service personnel only.
- Example** To display all debugging information, use the command:
`awplus# show debugging`
- Output** Figure 7-4: Example output from the **show debugging** command

```
awplus#show debugging
AAA debugging status:
  Authentication debugging is off
  Authorization debugging is off
  Accounting debugging is off
Antivirus Debugging Status: off
% Error: ATMF is not configured.
BGP debugging status:
  BGP debugging is off
  BGP nht debugging is off
  BGP nsm debugging is off
  BGP events debugging is off
  BGP keepalives debugging is off
  BGP updates debugging is off
  BGP fsm debugging is off
  BGP filter debugging is off
  BGP Route Flap Dampening debugging is off

Firewall Debugging Status: off
Traffic shaping debugging status: off
IGMP Debugging status:
  IGMP Decoder debugging is off
  IGMP Encoder debugging is off
  IGMP Events debugging is off
  IGMP FSM debugging is off
  IGMP Tree-Info-Base (TIB) debugging is off
DNS Relay debugging status:
  debugging is off
IP packet debugging status:
OSPFv3 debugging status:
...
```

show interface memory

Overview This command displays the shared memory used by either all interfaces, or the specified interface or interfaces. The output is useful for diagnostic purposes by Allied Telesis authorized service personnel.

For information on filtering and saving command output, see the [“Getting Started with AlliedWare Plus” Feature Overview and Configuration Guide](#).

Syntax `show interface memory`
`show interface <port-list> memory`

Parameter	Description
<port-list>	Display information about only the specified port or ports. The port list can be: <ul style="list-style-type: none">• an Eth (e.g. eth1) or switch port (e.g. port1.0.4), a static channel group (e.g. sa2) or a dynamic (LACP) channel group (e.g. po2)• a continuous range of ports separated by a hyphen (e.g. port1.0.1-1.0.4, or sa1-2, or po1-2)• a comma-separated list of ports and port ranges (e.g. port1.0.1,port1.0.4-1.0.6). Do not mix port types in the same list.

Mode User Exec and Privileged Exec

Example To display the shared memory used by all interfaces, use the command:

```
awplus# show interface memory
```

To display the shared memory used by port1.0.1 and port1.0.5 to port1.0.6, use the command:

```
awplus# show interface port1.0.1,port1.0.5-1.0.6 memory
```

Output Figure 7-5: Example output from the **show interface memory** command

```
awplus#show interface memory
Vlan blocking state shared memory usage
-----
Interface    shmid      Bytes Used  nattch    Status
port1.0.1    294921     512         1         1
port1.0.2    491535     512         1         1
port1.0.3    458766     512         1         1
port1.0.4    524304     512         1         1
port1.0.5    425997     512         1         1
port1.0.6    589842     512         1         1
port1.0.7    557073     512         1         1
port1.0.8    622611     512         1         1
eth2         327690     512         1         1
eth1         393228     512         1         1
lo           360459     512         1         1
```

Figure 7-6: Example output from **show interface <port-list> memory** for a list of interfaces

```
awplus#show interface port1.0.1,port1.0.5-1.0.6 memory
Vlan blocking state shared memory usage
-----
Interface      shmid      Bytes Used      natch      Status
port1.0.1      294921     512              1
port1.0.5      425997     512              1
port1.0.6      589842     512              1
```

**Related
Commands**

- [show interface brief](#)
- [show interface status](#)
- [show interface switchport](#)

show memory

Overview This command displays the memory used by each process that is currently running. For information on filtering and saving command output, see the [“Getting Started with AlliedWare Plus” Feature Overview and Configuration Guide](#).

Syntax `show memory [sort {size|peak|stk}]`

Parameter	Description
sort	Changes the sorting order for the list of processes. If you do not specify this, then the list is sorted by percentage memory utilization.
size	Sort by the amount of memory the process is currently using.
peak	Sort by the amount of memory the process is currently using.
stk	Sort by the stack size of the process.

Mode User Exec and Privileged Exec

Example To display the memory used by the current running processes, use the command:
`awplus# show memory`

Output Figure 7-7: Example output from **show memory**

```
awplus#show memory

RAM total: 824680 kB; free: 635032 kB; buffers: 20272 kB

user processes
=====
 pid name          mem%  size (kB)  peak (kB)  data (kB)  stk (kB)  virt (kB)
1443 squid          1.9    16408    299768    23568     264    299768
1441 squid          1.9    16416    299776    23568     272    299776
1440 squid          1.9    16416    299776    23568     272    299776
1439 squid          1.9    16416    299776    23568     272    299776
1438 squid          1.9    16152    298928    23568     264    298864
1226 imi            1.3    10968     23104     2760      160     22912
1228 hsl            1.2    10512    692944    608160    144    631856
2156 imish          1.0     8856    158456    75904     160     94696
1221 nsm            1.0     9008     21696     1968      152     21632
1296 ospfd          0.8     6936     19144     1016      144     19080
1293 bgpd           0.8     7264     19184     1168      152     19120
1291 pimd           0.8     6600     20992     2944      144     20928
1283 ripd           0.8     6640     18328     944       152     18256
...
```

Table 3: Parameters in the output of the **show memory** command

Parameter	Description
RAM total	Total amount of RAM memory free.
free	Available memory size.
buffers	Memory allocated kernel buffers.
pid	Identifier number for the process.
name	Short name used to describe the process.
mem%	Percentage of memory utilization the process is currently using.
size	Amount of memory currently used by the process.
peak	Greatest amount of memory ever used by the process.
data	Amount of memory used for data.
stk	The stack size.

- Related Commands**
- [show memory allocations](#)
 - [show memory history](#)
 - [show memory pools](#)
 - [show memory shared](#)

show memory allocations

Overview This command displays the memory allocations used by processes.

For information on filtering and saving command output, see the [“Getting Started with AlliedWare Plus” Feature Overview and Configuration Guide](#).

Syntax show memory allocations [<process>]

Parameter	Description
<process>	Displays the memory allocation used by the specified process.

Mode User Exec and Privileged Exec

Example To display the memory allocations used by all processes on your device, use the command:

```
awplus# show memory allocations
```

Output Figure 7-8: Example output from the **show memory allocations** command

```
awplus#show memory allocations
Memory allocations for imi
-----

Current 15093760 (peak 15093760)

Statically allocated memory:
- binary/exe           : 1675264
- libraries            : 8916992
- bss/global data     : 2985984
- stack                : 139264

Dynamically allocated memory (heap):
- total allocated      : 1351680
- in use               : 1282440
- non-mmapped         : 1351680
- maximum total allocated : 1351680
- total free space     : 69240
- releasable          : 68968
- space in freed fastbins : 16

Context
      filename:line   allocated   freed
+          lib.c:749     484
.
.
.
```

**Related
Commands**

- show memory
- show memory history
- show memory pools
- show memory shared
- show tech-support

show memory history

Overview This command prints a graph showing the historical memory usage.
For information on filtering and saving command output, see the [“Getting Started with AlliedWare Plus” Feature Overview and Configuration Guide](#).

Syntax `show memory history`

Mode User Exec and Privileged Exec

Usage This command’s output displays three graphs of the percentage memory utilization:

- per second for the last minute, then
- per minute for the last hour, then
- per 30 minutes for the last 30 hours.

Examples To show a graph displaying the historical memory usage, use the command:

```
awplus# show memory history
```

Output Figure 7-9: Example output from the **show memory history** command

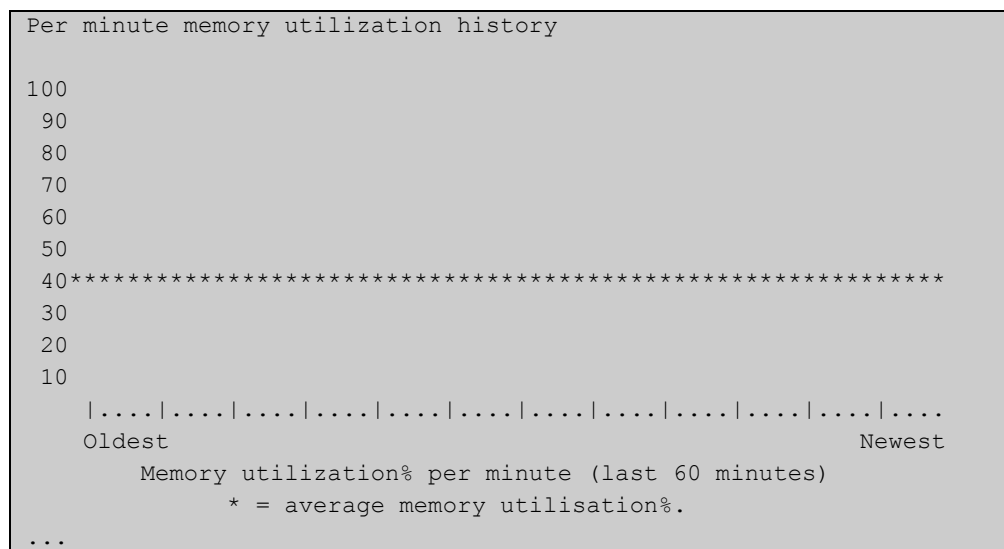

- Related Commands**
- [show memory allocations](#)
 - [show memory pools](#)
 - [show memory shared](#)
 - [show tech-support](#)

show memory pools

Overview This command shows the memory pools used by processes.

For information on filtering and saving command output, see the [“Getting Started with AlliedWare Plus” Feature Overview and Configuration Guide](#).

Syntax `show memory pools [<process>]`

Parameter	Description
<code><process></code>	Displays the memory pools used by the specified process.

Mode User Exec and Privileged Exec

Example To show the memory pools used by processes, use the command:

```
awplus# show memory pools
```

Output Figure 7-10: Example output from the **show memory pools** command

```
awplus#show memory pools
Memory pools for imi
-----

Current 15290368 (peak 15290368)

Statically allocated memory:
- binary/exe           : 1675264
- libraries            : 8916992
- bss/global data     : 2985984
- stack                : 139264

Dynamically allocated memory (heap):
- total allocated      : 1548288
- in use               : 1479816
- non-mmapped          : 1548288
- maximum total allocated : 1548288
- total free space     : 68472
- releasable           : 68200
- space in freed fastbins : 16
.
.
.
```

Related Commands

- [show memory allocations](#)
- [show memory history](#)
- [show tech-support](#)

show memory shared

Overview This command displays shared memory allocation information. The output is useful for diagnostic purposes by Allied Telesis authorized service personnel.

For information on filtering and saving command output, see the [“Getting Started with AlliedWare Plus” Feature Overview and Configuration Guide](#).

Syntax `show memory shared`

Mode User Exec and Privileged Exec

Example To display information about the shared memory allocation used on the device, use the command:

```
awplus# show memory shared
```

Output Figure 7-11: Example output from the **show memory shared** command

```
awplus#show memory shared
Shared Memory Status
-----
Segment allocated   = 39
Pages allocated     = 39
Pages resident      = 11

Shared Memory Limits
-----
Maximum number of segments           = 4096
Maximum segment size (kbytes)        = 32768
Maximum total shared memory (pages) = 2097152
Minimum segment size (bytes)         = 1
```

Related Commands

- [show memory allocations](#)
- [show memory history](#)
- [show memory](#)

show process

Overview This command lists a summary of the current running processes.

For information on filtering and saving command output, see the [“Getting Started with AlliedWare Plus” Feature Overview and Configuration Guide](#).

Syntax `show process [sort {cpu|mem}]`

Parameter	Description
sort	Changes the sorting order for the list of processes.
cpu	Sorts the list by the percentage of CPU utilization.
mem	Sorts the list by the percentage of memory utilization.

Mode User Exec and Privileged Exec

Usage This command displays a snapshot of currently-running processes. If you want to see CPU or memory utilization history instead, use the commands [show cpu history](#) or [show memory history](#).

Example To display a summary of the current running processes, use the command:

```
awplus# show process
```

Output Figure 7-12: Example output from the **show process** command

```
CPU averages:
 1 second: 8%, 20 seconds: 5%, 60 seconds: 5%
System load averages:
 1 minute: 0.04, 5 minutes: 0.08, 15 minutes: 0.12
Current CPU load:
 userspace: 9%, kernel: 9%, interrupts: 0% iowaits: 0%
RAM total: 514920 kB; free: 382600 kB; buffers: 16368 kB

user processes
=====
pid name      thrds  cpu%  mem%  pri  state  sleep%
962 pss        12    0     6    25  sleep    5
1  init         1     0     0    25  sleep    0
797 syslog-ng   1     0     0    16  sleep   88
...
kernel threads
=====
pid name      cpu%  pri  state  sleep%
71  aio/0      0    20  sleep  0
3   events/0   0    10  sleep  98
...
```

Table 4: Parameters in the output from the **show process** command

Parameter	Description
CPU averages	Average CPU utilization for the periods stated.
System load averages	The average number of processes waiting for CPU time for the periods stated.
Current CPU load	Current CPU utilization specified by load types
RAM total	Total memory size.
free	Available memory.
buffers	Memory allocated to kernel buffers.
pid	Identifier for the process.
name	Short name to describe the process.
thrds	Number of threads in the process.
cpu%	Percentage of CPU utilization that this process is consuming.
mem%	Percentage of memory utilization that this process is consuming.
pri	Process priority.
state	Process state; one of "run", "sleep", "stop", "zombie", or "dead".
sleep%	Percentage of time the process is in the sleep state.

Related Commands [show cpu](#)
[show cpu history](#)

show reboot history

Overview Use this command to display the device's reboot history.

Syntax `show reboot history`

Mode User Exec and Privileged Exec

Example To show the reboot history, use the command:

```
awplus# show reboot history
```

Output Figure 7-13: Example output from the **show reboot history** command

```
awplus#show reboot history

<date>      <time>      <type>      <description>
-----
2016-10-10  01:42:04  Expected    User Request
2016-10-10  01:35:31  Expected    User Request
2016-10-10  01:16:25  Unexpected  Rebooting due to critical process (network/nsm)
failure!
2016-10-10  01:11:04  Unexpected  Rebooting due to critical process (network/nsm)
failure!
2016-10-09  19:56:16  Expected    User Request
2016-10-09  19:51:20  Expected    User Request
```

Table 5: Parameters in the output from the **show reboot history** command

Parameter	Description
Unexpected	A non-intended reboot.
Expected	A planned or user-triggered reboot.
User request	User initiated reboot via the CLI.

Related Commands [show tech-support](#)

show router-id

Overview Use this command to show the Router ID of the current system.

Syntax `show router-id`

Mode User Exec and Privileged Exec

Example To display the Router ID of the current system, use the command:

```
awplus# show router-id
```

Output Figure 7-14: Example output from the **show router-id** command

```
awplus>show router-id  
Router ID: 10.55.0.2 (automatic)
```

show system

Overview This command displays general system information about the device, including the hardware, memory usage, and software version. It also displays location and contact details when these have been set.

For information on filtering and saving command output, see the [“Getting Started with AlliedWare Plus” Feature Overview and Configuration Guide](#).

Syntax `show system`

Mode User Exec and Privileged Exec

Example To display configuration information, use the command:

```
awplus# show system
```

Output Figure 7-15: Example output from **show system**

```
awplus#show system
System Status                               Mon Nov 16 08:42:16 2015

Board      ID  Bay      Board Name          Rev      Serial number
-----
Base       425          AR4050S             X1-0     A05049G27NE2004
-----

RAM:  Total: 824680 kB Free: 634632 kB
Flash: 3.6GB Used: 109.1MB Available: 3.3GB
-----

Environment Status : ***Fault***
Uptime              : 0 days 23:11:05
Bootloader version  : 5.0.6

Current software   : AR4050S-5.4.5-2.1.rel
Software version   : 5.4.5-2.1
Build date        : Thu Nov 12 12:11:29 NZDT 2015

Current boot config: flash:/default.cfg (file exists)

System Name
awplus
System Contact
System Location
```

Related Commands [show system environment](#)

show system environment

Overview This command displays the current environmental status of your device and any attached PSU, XEM, or other expansion option. The environmental status covers information about temperatures, fans, and voltage.

For information on filtering and saving command output, see the [“Getting Started with AlliedWare Plus” Feature Overview and Configuration Guide](#).

Syntax show system environment

Mode User Exec and Privileged Exec

Example To display the system’s environmental status, use the command:

```
awplus# show system environment
```

Output Figure 7-16: Example output from **show system environment**

```
awplus#show system environment
Environment Monitoring Status

Overall Status: ***Fault***

Resource ID: 1 Name: AR4050S
ID Sensor (Units) Reading Low Limit High Limit Status
1 Fan: Fan (Rpm) 3516 2411 - Ok
2 Voltage: 2.5V (Volts) 2.461 2.344 2.865 Ok
3 Voltage: Battery (Volts) 1.181 2.700 3.586 FAULT
4 Voltage: 3.3V (Volts) 3.266 2.973 3.627 Ok
5 Voltage: 5.0V (Volts) 4.974 4.505 5.495 Ok
6 Voltage: 12V (Volts) 11.563 10.813 13.188 Ok
7 Voltage: 0.92V (Volts) 0.844 0.872 0.970 FAULT
8 Temp: Internal (Degrees C) 32 58 (Hyst) 65 Ok
```

Related Commands [show system](#)

show system interrupts

Overview Use this command to display the number of interrupts for each IRQ (Interrupt Request) used to interrupt input lines on a PIC (Programmable Interrupt Controller) on your device.

For information on filtering and saving command output, see the [“Getting Started with AlliedWare Plus” Feature Overview and Configuration Guide](#).

Syntax `show system interrupts`

Mode User Exec and Privileged Exec

Example To display information about the number of interrupts for each IRQ in your device, use the command:

```
awplus# show system interrupts
```

Output Figure 7-17: Example output from the **show system interrupts** command

```
awplus#show system interrupts
      CPU0      CPU1
8:    151378    152020    Core Enabled  0  timer
16:      0      0      CIU Enabled  0  Ethernet
25:     256      0      CIU-W Enabled  0  octeon_wdt
26:      0     256      CIU-W Enabled  0  octeon_wdt
41:   946096   947120      CIU-M Enabled  0  SMP-IPI
51:      0      0      CIU Enabled  0  RGMII
53:      0      0      CIU Enabled  0  Ethernet
59:    1025      0      CIU Enabled  0  serial
60:    5825      0      CIU Enabled  0  i2c-octeon
61:      3      0      CIU Enabled  0  i2c-octeon
63:      0      0      CIB Enabled  0  xhci-hcd:usb1
65:      0      0  CIU-GPIO Enabled  0  0-0021
...

```

Related Commands [show system environment](#)

show system mac

Overview This command displays the physical MAC address of the device.

Syntax `show system mac`

Mode User Exec and Privileged Exec

Example To display the physical MAC address enter the following command:

```
awplus# show system mac
```

Output Figure 7-18: Example output from the **show system mac** command

```
awplus#show system mac
0200.0034.5682
0200.0034.5683
0200.0034.5684
```

show system pci device

Overview Use this command to display the PCI devices on your device.

Syntax `show system pci device`

Mode User Exec and Privileged Exec

Example To display information about the PCI devices on your device, use the command:

```
awplus# show system pci device
```

**Related
Commands** [show system environment](#)
[show system pci tree](#)

show system pci tree

Overview Use this command to display the PCI tree on your device.

Syntax `show system pci tree`

Mode User Exec and Privileged Exec

Example To display information about the PCI tree on your device, use the command:

```
awplus# show system pci tree
```

**Related
Commands** [show system environment](#)
[show system pci device](#)

show system serialnumber

Overview This command shows the serial number information for the device.
For information on filtering and saving command output, see the [“Getting Started with AlliedWare Plus” Feature Overview and Configuration Guide](#).

Syntax `show system serialnumber`

Mode User Exec and Privileged Exec

Example To display the serial number information for the device, use the command:

```
awplus# show system serialnumber
```

Output Figure 7-19: Example output from the **show system serial number** command

```
awplus#show system serialnumber  
45AX5300X
```

show tech-support

Overview This command generates system and debugging information for the device and saves it to a file.

This command is useful for collecting a large amount of information so that it can then be analyzed for troubleshooting purposes. The output of this command can be provided to technical support staff when reporting a problem.

You can optionally limit the command output to display only information for a given protocol or feature. The features available depend on your device and will be a subset of the features listed in the table below.

Syntax `show tech-support`
{ [all|atmf|auth|bgp|card|dhcpsn|epsr|firewall|igmp|ip|ipv6|mld|openflow|ospf|ospf6|pim|rip|ripng|stack|stp|system|tacacs+|update]} [outfile <filename>]

Parameter	Description
all	Display full information
atmf	Display ATMF-specific information
auth	Display authentication-related information
bgp	Display BGP-related information
card	Display Chassis Card specific information
dhcpsn	Display DHCP Snooping specific information
epsr	Display EPSR specific information
firewall	Display firewall specific information
igmp	Display IGMP specific information
ip	Display IP specific information
ipv6	Display IPv6 specific information
mld	Display MLD specific information
openflow	Display information related to OpenFlow
ospf	Display OSPF related information
ospf6	Display OSPF6 specific information
pim	Display PIM related information
rip	RIP related information
ripng	Display RIPNG specific information
stack	Display stacking device information
stp	Display STP specific information
system	Display general system information

Parameter	Description
tacacs+	Display TACACS+ information
update	Display resource update specific information
	Output modifier
>	Output redirection
>>	Output redirection (append)
outfile	Output file name
<filename>	Specifies a name for the output file. If no name is specified, this file will be saved as: tech-support.txt.gz.

Default Captures **all** information for the device.

By default the output is saved to the file 'tech-support.txt.gz' in the current directory. If this file already exists in the current directory then a new file is generated with the time stamp appended to the file name, for example 'tech-support20161009.txt.gz', so the previous file is retained.

Usage The command generates a large amount of output, which is saved to a file in compressed format. The output file name can be specified by outfile option. If the output file already exists, a new file name is generated with the current time stamp. If the output filename does not end with ".gz", then ".gz" is appended to the filename. Since output files may be too large for Flash on the device we recommend saving files to external memory or a TFTP server whenever possible to avoid device lockup. This method is not likely to be appropriate when running the working set option of AMF across a range of physically separated devices.

Mode Privileged Exec

Examples To produce the output needed by technical support staff, use the command:

```
awplus# show tech-support
```

speed (asyn)

Overview This command changes the console speed from the device. Note that a change in console speed is applied for subsequent console sessions. Exit the current session to enable the console speed change using the [clear line console](#) command.

Syntax `speed <console-speed-in-bps>`

Parameter	Description
<code><console-speed-in-bps></code>	Console speed Baud rate in bps (bits per second).
	1200 1200 Baud
	2400 2400 Baud
	9600 9600 Baud
	19200 19200 Baud
	38400 38400 Baud
	57600 57600 Baud
	115200 115200 Baud

Default The default console speed baud rate is 9600 bps.

Mode Line Configuration

Usage This command is used to change the console (asyn) port speed. Set the console speed to match the transmission rate of the device connected to the console (asyn) port on your device.

Example To set the terminal console (asyn0) port speed from the device to 57600 bps, then exit the session, use the commands:

```
awplus# configure terminal
awplus(config)# line console 0
awplus(config-line)# speed 57600
awplus(config-line)# exit
awplus(config)# exit
awplus# exit
```

Then log in again to enable the change:

```
awplus login:
Password:
awplus>
```

**Related
Commands** `clear line console`
`line`
`show running-config`
`show startup-config`
`speed`

terminal monitor

Overview Use this command to display debugging output on a terminal.

To display the cursor after a line of debugging output, press the Enter key.

Use the command **terminal no monitor** to stop displaying debugging output on the terminal, or use the timeout option to stop displaying debugging output on the terminal after a set time.

Syntax terminal monitor [*<1-60>*]

terminal no monitor

Parameter	Description
<i><1-60></i>	Set a timeout between 1 and 60 seconds for terminal output.

Default Disabled

Mode User Exec and Privileged Exec

Examples To display debugging output on a terminal, enter the command:

```
awplus# terminal monitor
```

To specify timeout of debugging output after 60 seconds, enter the command:

```
awplus# terminal monitor 60
```

To stop displaying debugging output on the terminal, use the command:

```
awplus# terminal no monitor
```

Related Commands All debug commands

undebug all

Overview This command applies the functionality of the [no debug all](#) command.

8

Pluggables and Cabling Commands

Introduction

Overview This chapter provides an alphabetical reference of commands used to configure and monitor Pluggables and Cabling, including:

- Optical Digital Diagnostic Monitoring (DDM) to help find fiber issues when links go down
- Active Fiber Monitoring for detecting changes in optical power received over fiber cables.

For more information, see the [Pluggables and Cabling Feature Overview and Configuration Guide](#).

- Command List**
- [“debug fiber-monitoring”](#) on page 282
 - [“fiber-monitoring action”](#) on page 284
 - [“fiber-monitoring baseline”](#) on page 285
 - [“fiber-monitoring enable”](#) on page 287
 - [“fiber-monitoring interval”](#) on page 288
 - [“fiber-monitoring sensitivity”](#) on page 289
 - [“show system fiber-monitoring”](#) on page 291
 - [“show system pluggable”](#) on page 294
 - [“show system pluggable detail”](#) on page 296
 - [“show system pluggable diagnostics”](#) on page 299

debug fiber-monitoring

Overview Use this command to enable debugging of active fiber monitoring on the specified ports.

Use the **no** variant of this command to disable debugging on all ports or the specified ports.

Syntax `debug fiber-monitoring interface <port-list>`
`no debug fiber-monitoring [interface <port-list>]`

Parameter	Description
<code><port-list></code>	The list of fiber ports to enable or disable debugging for, as a single port, a comma separated list or a hyphenated range.

Default Debugging of active fiber monitoring is disabled by default.

Mode User Exec/Privileged Exec

Usage While debugging is enabled by this command for a port, all the optical power readings for the port are sent to the console.

Example To enable debugging messages for active fiber monitoring of port 1.0.2 to be sent to the console, use the commands:

```
awplus# debug fiber-monitoring interface port 1.0.2  
awplus# terminal monitor
```

To disable debugging messages for active fiber monitoring on port 1.0.2, use the command:

```
awplus# no debug fiber-monitoring interface port 1.0.2
```

To disable all debugging messages for active fiber monitoring, use the command:

```
awplus# no debug fiber-monitoring
```

Output Figure 8-1: Example output from **debug fiber-monitoring**

```
awplus#debug fiber-monitoring interface port2.0.1
awplus#terminal monitor
% Warning: Console logging enabled
awplus#01:42:50 awplus Pluggable[522]: Fiber-monitor port2.0.1: Channel:1
Reading:1748 Baseline:1708 Threshold:1356
01:42:52 awplus Pluggable[522]: Fiber-monitor port2.0.1: Channel:1 Reading:1717
Baseline:1709 Threshold:1357
01:42:54 awplus Pluggable[522]: Fiber-monitor port2.0.1: Channel:1 Reading:1780
Baseline:1709 Threshold:1357
01:42:56 awplus Pluggable[522]: Fiber-monitor port2.0.1: Channel:1 Reading:1685
Baseline:1710 Threshold:1358
01:42:58 awplus Pluggable[522]: Fiber-monitor port2.0.1: Channel:1 Reading:1701
Baseline:1710 Threshold:1358
01:43:01 awplus Pluggable[522]: Fiber-monitor port2.0.1: Channel:1 Reading:1733
Baseline:1709 Threshold:1357
```

Related Commands [show system fiber-monitoring](#)

fiber-monitoring action

Overview Use this command to specify an action to be taken if the optical power received on the port changes from the baseline by the amount specified in the **fiber-monitoring sensitivity** command.

Use the **no** variant of this command to remove the specified action or all actions from the port.

Syntax `fiber-monitoring action {trap|shutdown}`
`no fiber-monitoring action [trap|shutdown]`

Parameter	Description
trap	Send an SNMP notification.
shutdown	Shutdown the port.

Default By default a log message is generated, but no additional action is performed.

Mode Interface Configuration mode for a fiber port.

Usage If fiber monitoring is enabled and this command is not used to set an action, a change in received power on a fiber port only generates a log message.

Example To set the device to send an SNMP notification when ports 1.0.1 or 1.0.2 receive reduced power, use the commands:

```
awplus(config)# interface port1.0.1-1.0.2  
awplus(config-if)# fiber-monitoring action trap
```

To set the device to send an SNMP notification and to shut down the port when ports 1.0.1 or 1.0.2 receive reduced power, use the commands:

```
awplus(config)# interface port1.0.1-1.0.2  
awplus(config-if)# fiber-monitoring action trap shutdown
```

To set the device not to send an SNMP notification when ports 1.0.1 or 1.0.2 receive reduced power, use the commands:

```
awplus(config)# interface port1.0.1-1.0.2  
awplus(config-if)# no fiber-monitoring action trap
```

To set the device not to perform any action when it receives reduced power on ports 1.0.1 or 1.0.2, use the commands:

```
awplus(config)# interface port1.0.1-1.0.2  
awplus(config-if)# no fiber-monitoring action
```

Related Commands [fiber-monitoring sensitivity](#)
[show system fiber-monitoring](#)

fiber-monitoring baseline

Overview Use this command to configure how the baseline value for comparison is calculated for active fiber monitoring on the port.

Note that alarm generation will not commence until the link has been up for a full averaging period.

Use the **no** variant of this command to set the fiber-monitoring baseline to its default value.

Syntax `fiber-monitoring baseline (average <12-150>|fixed <1-65535>)`
`no fiber-monitoring baseline`

Parameter	Description
average	Set the baseline optical power received to be based on the moving average of the specified number of most recent (non-zero) values. Default.
<12-150>	The number of most recent values to average for the baseline. Default: 12.
fixed	Set the baseline to a fixed level of received optical power. Not recommended—see Usage below.
<1-65535>	The fixed baseline value of received optical power in 0.0001mW.

Default The default is a moving average of the last 12 values. If the **fiber-monitoring interval** is set to its default (5s), the **fiber-monitoring baseline** default will be the average over the last minute.

Mode Interface Configuration for a fiber port

Usage **CAUTION:** *We do not recommend setting a fixed value because gradual change over time caused by temperature fluctuations, etc. could lead to unnecessary alarms.*

There are two ways to configure the baseline. The first is to choose a number of readings to average. This is the default and recommended method. The second is to set a fixed value in units of x0.0001mW.

If a fixed value is required, the easiest way is to enable fiber monitoring on the port and use the **show system fiber-monitoring** command to see what readings can be expected.

Example To set the baseline optical power to a moving average of the last 30 readings, use the command:

```
awplus(config-if)# fiber-monitoring baseline average 30
```

To set the baseline to its default, averaging the last 12 readings, use the command:

```
awplus(config-if)# no fiber-monitoring baseline
```

**Related
Commands** fiber-monitoring interval
fiber-monitoring sensitivity

fiber-monitoring enable

Overview Use this command to enable active fiber monitoring on a fiber port. If the port can support fiber monitoring but does not have the correct SFP or fiber type installed, the configuration will be saved, and monitoring will commence when a supported SFP is inserted. Disabling and re-enabling fiber monitoring on a port resets the baseline calculation.

Use the **no** variants of this command to disable active fiber monitoring on the interface, or to remove all the configuration and state for the ports, respectively.

Syntax

```
fiber-monitoring enable
no fiber-monitoring enable
no fiber-monitoring
```

Default Active fiber monitoring is disabled by default.

Mode Interface Configuration mode for a fiber port

Examples To enable active fiber monitoring on a ports 1.0.1 and 1.0.2, use the commands:

```
awplus(config)# interface port1.0.1-1.0.2
awplus(config-if)# fiber-monitoring enable
```

To disable fiber monitoring on the ports, use the commands:

```
awplus(config)# interface port1.0.1-1.0.2
awplus(config-if)# no fiber-monitoring enable
```

To remove all fiber-monitoring configuration and state for the ports, use the commands:

```
awplus(config)# interface port1.0.1-1.0.2
awplus(config-if)# no fiber-monitoring
```

Related Commands

- [fiber-monitoring action](#)
- [fiber-monitoring sensitivity](#)
- [show system fiber-monitoring](#)

fiber-monitoring interval

Overview Use this command to configure the fiber monitoring polling interval in seconds for the port. The optical power will be read every <interval> seconds and compared against the calculated threshold values to see if a log message or other action is required.

Use the **no** variant of this command to reset the polling interval to the default (5 seconds).

Syntax fiber-monitoring interval <2-60>
no fiber-monitoring interval

Parameter	Description
<2-60>	Optical power polling interval in seconds.

Default The interval is set to 5 seconds by default.

Mode Interface configuration mode for a fiber port.

Example To set the fiber monitoring polling interval for port 1.0.2 to 30 seconds, use the commands:

```
awplus(config)# interface port1.0.2  
awplus(config-if)# fiber-monitoring interval 30
```

To reset the fiber monitoring polling interval back to the default (5s), use the commands:

```
awplus(config)# interface port1.0.2  
awplus(config-if)# no fiber-monitoring interval
```

Related Commands [fiber-monitoring baseline](#)
[show system fiber-monitoring](#)

fiber-monitoring sensitivity

Overview Use this command to configure the sensitivity of the alarm thresholds on the port for active fiber monitoring.

Use the **no** variant of this command to reset the sensitivity to the default.

Syntax `fiber-monitoring sensitivity (low|medium|high|highest|fixed <25-65535>)|relative <0.01-10.0>`
`no fiber-monitoring sensitivity`

Parameter	Description
low	Low sensitivity (+/-2 dB)
medium	Medium sensitivity (1 dB) (default)
high	High sensitivity (the greater of 0.5 dB and 0.0025 mW)
highest	The highest sensitivity available: 0.0025mW
fixed<25-65535>	Fixed sensitivity at the specified level in 0.0001 mW.
relative <0.01-10.0>	Relative sensitivity at the specified level in dB.

Default The default is medium sensitivity.

Mode User Exec/Privileged Exec

Usage A log message is generated and configured actions are taken if the received optical power drops below the baseline value by the sensitivity configured with this command.

The sensitivity can be configured to one of four pre-defined levels in decibels or to a fixed absolute delta in units of 0.0001mW. The alarm thresholds can be seen in the **show system fiber-monitoring** output. The maximum absolute sensitivity configurable is 0.0025 mW. Note that 0.0025 mW equates to a reduction of approximately 1dB at the maximum attenuation of an AT-SPLX10/1.

Example To set the fiber monitoring sensitivity for port 1.0.2 to a relative sensitivity of 0.1 dB, use the commands:

```
awplus(config)# interface port1.0.2  
awplus(config-if)# fiber-monitoring sensitivity relative 0.1
```

To reset the fiber monitoring sensitivity to the default (medium), use the commands:

```
awplus(config)# interface port1.0.2  
awplus(config-if)# no fiber-monitoring sensitivity
```

**Related
Commands** fiber-monitoring action
fiber-monitoring baseline
show system fiber-monitoring

show system fiber-monitoring

Overview Use this command to display settings and current status for Active Fiber Monitoring.

Syntax show system fiber-monitoring

Mode User Exec/Privileged Exec

Example To display configuration and status for active fiber monitoring on ports, use the command:

```
awplus# show system fiber-monitoring
```

Output Figure 8-2: Example output from **show system fiber-monitoring**

```
awplus#show sys fiber-monitoring
Fiber Monitoring Status
  Reading units 0.0001mW

Stack member 1:

Interface port1.0.1
Status:          enabled
Supported:       Supported pluggable
Debugging:       disabled
Interval:        2 seconds
Sensitivity:     1.00dB
Baseline type:   average of last 35 values greater than 50
Status:
  Baseline value: 496
  Alarm threshold: 393
  Alarm:          no
  Last 12 Readings: 498 498 498 498 498 498 498 498 498 498 498 498
  Minimum reading: 486
  Maximum reading: 498

Interface port1.0.2
Status:          enabled
Supported:       Supported pluggable
Debugging:       disabled
Interval:        2 seconds
Sensitivity:     1.00dB
Baseline type:   average of last 30 values greater than 50
Status:
  Baseline value: 0
  Alarm threshold: 0
  Alarm:          no
  Last 12 Readings: 0 0 0 0 0 0 0 0 0 0 0 0
  Minimum reading: 0
  Maximum reading: 0
```

Table 8-1: Parameters in the output from **show system fiber-monitoring**

Parameter	Description
Reading units	The units for optical power readings in the rest of the display, e.g. 0.0001mW.
Status	Whether active fiber monitoring is enabled or disabled for this port.
Supported	Whether the pluggable inserted in this port supports active fiber monitoring.
Debugging	Whether debugging of active fiber monitoring is enabled or disabled for this port.
Interval	The configured interval between readings of optical power on this port.
Sensitivity	The configured sensitivity threshold for optical power changes on this port.
Baseline type	How the baseline optical power level is calculated: either the average of the specified number of previous readings or a specified fixed value in 0.0001mW.
Status	Current values for the following parameters.
Baseline value	The baseline value, calculated according to the configured baseline method, in 0.0001mW.
Alarm threshold	The current threshold for a change in optical power, calculated according to the configured sensitivity method, that will result in action.
Alarm	Whether the optical power at the most recent reading fallen below the threshold.
Last 12 readings	The last 12 optical power values measured, in 0.0001mW, with oldest value first.
Minimum reading	The lowest optical power reading since the fiber pluggable was last inserted, or since active fiber monitoring was last enabled on the port.
Maximum reading	The highest optical power reading since the fiber pluggable was last inserted, or since active fiber monitoring was last enabled on the port.

Related Commands

- [debug fiber-monitoring](#)
- [fiber-monitoring action](#)
- [fiber-monitoring baseline](#)
- [fiber-monitoring enable](#)

fiber-monitoring interval

fiber-monitoring sensitivity

show system pluggable

Overview This command displays **brief** pluggable transceiver information showing the pluggable type, the pluggable serial number, and the pluggable port on the device. Different types of pluggable transceivers are supported in different models of device. See your Allied Telesis dealer for more information about the models of pluggables that your device supports.

Syntax `show system pluggable [<port-list>]`

Parameter	Description
<port-list>	The Eth port or ports to display information about (e.g. eth1 or eth1,eth2)

Mode User Exec and Privileged Exec

Example To display brief information about all installed pluggable transceivers, use the command:

```
awplus# show system pluggable
```

Example To display information about the pluggable transceiver installed in eth1, use the command:

```
awplus# show system pluggable eth1
```

Output Figure 8-3: Example output from **show system pluggable eth1**

System Pluggable Information					
Port	Manufacturer	Device	Serial Number	Datecode	Type
eth1	AGILENT	HBCU-5710R	AK051300S3	050402	1000BASE-T

Table 9: Parameters in the output from the **show system pluggable** command

Parameter	Description
Port	Specifies the port number for the installed pluggable transceiver.
Vendor	Specifies the vendor's name for the installed pluggable transceiver.
Device	Specifies the device name for the installed pluggable transceiver.
Serial Number	Specifies the serial number for the installed pluggable transceiver.

Table 9: Parameters in the output from the **show system pluggable** command

Parameter	Description
Datecode	Specifies the manufacturing datecode for the installed pluggable transceiver. Checking the manufacturing datecode with the vendor may be useful when determining Laser Diode aging issues. For more information, see "How To Troubleshoot Fiber and Pluggable Issues" in the "Getting Started with AlliedWare Plus" Feature Overview and Configuration Guide .
Type	Specifies the device type for the installed pluggable transceiver.

- Related Commands**
- [show system environment](#)
 - [show system pluggable detail](#)
 - [show system pluggable diagnostics](#)

show system pluggable detail

Overview This command displays detailed pluggable transceiver information showing the pluggable type, the pluggable serial number, and the pluggable port on the device. Different types of pluggable transceivers are supported in different models of device. See your Allied Telesis dealer for more information about the models of pluggables that your device supports.

For information on filtering and saving command output, see the [“Getting Started with AlliedWare Plus” Feature Overview and Configuration Guide](#).

Syntax `show system pluggable [<port-list>] detail`

Parameter	Description
<code><port-list></code>	The Eth port or ports to display information about (e.g. eth1 or eth1,eth2)

Mode User Exec and Privileged Exec

Usage In addition to the information about pluggable transceivers displayed using the `show system pluggable` command (port, manufacturer, serial number, manufacturing datecode, and type information), the **show system pluggable detail** command displays the following information:

- **SFP Laser Wavelength:** Specifies the laser wavelength of the installed pluggable transceiver
- **Single mode Fiber:** Specifies the link length supported by the pluggable transceiver using single mode fiber
- **OM1 (62.5µ m) Fiber:** Specifies the link length, in meters (m) or kilometers (km) supported by the pluggable transceiver using 62.5 micron multi-mode fiber.
- **OM2 (50µ m) Fiber:** Specifies the link length (in meters or kilometers) supported by the pluggable transceiver using 50 micron multi-mode fiber.
- **Diagnostic Calibration:** Specifies whether the pluggable transceiver supports DDM or DOM Internal or External Calibration.
 - **Internal** is displayed if the pluggable transceiver supports DDM or DOM Internal Calibration.
 - **External** is displayed if the pluggable transceiver supports DDM or DOM External Calibration.
 - a dash (-) is displayed if neither Internal Calibration or External Calibration is supported.
- **Power Monitoring:** Displays the received power measurement type, which can be either **OMA**(Optical Module Amplitude) or **Avg**(Average Power) measured in µW.

NOTE: For parameters that are not supported or not specified, a hyphen is displayed instead.

Example To display detailed information about the pluggable transceivers installed in a particular port on the device, use a command like:

```
awplus# show system pluggable eth1 detail
```

To display detailed information about all the pluggable transceivers installed on the device, use the command:

```
awplus# show system pluggable detail
```

Output Figure 8-4: Example output from **show system pluggable detail** for a specific port on a device

```
System Pluggable Information Detail
eth1
=====
Vendor Name:          AGILENT
Device Name:          QBCU-5730R
Device Revision:      -
Device Type:          1000BASE-T
Serial Number:        AK0614GKET
Manufacturing Datecode: 060408
SFP Laser Wavelength: -
Link Length Supported
  Single Mode Fiber : -
  OM1 (62.5um) Fiber: -
  OM2 (50um) Fiber : -
  OM3 (50um) Fiber : -
Diagnostic Calibration: -
Power Monitoring:    -
```

Table 8-1: Parameters in the output from **show system pluggable detail**

Parameter	Description
Port	Specifies the port the pluggable transceiver is installed in.
Vendor Name	Specifies the vendor's name for the installed pluggable transceiver.
Device Name	Specifies the device name for the installed pluggable transceiver.
Device Revision	Specifies the hardware revision code for the pluggable transceiver. This may be useful for troubleshooting because different devices may support different pluggable transceiver revisions.
Device Type	Specifies the device type for the installed pluggable transceiver.

Table 8-1: Parameters in the output from **show system pluggable detail** (cont.)

Parameter	Description
Serial Number	Specifies the serial number for the installed pluggable transceiver.
Manufacturing Datecode	Specifies the manufacturing datecode for the installed pluggable transceiver. Checking the manufacturing datecode with the vendor may be useful when determining Laser Diode aging issues. For more information, see "How To Troubleshoot Fiber and Pluggable Issues" in the "Getting Started with AlliedWare Plus" Feature Overview and Configuration Guide .
SFP Laser Wavelength	Specifies the laser wavelength of the installed pluggable transceiver.
Single Mode Fiber	Specifies the link length supported by the pluggable transceiver using single mode fiber.
OM1 (62.5um) Fiber	Specifies the link length (in μm - micron) supported by the pluggable transceiver using 62.5 micron multi-mode fiber.
OM2 (50um) Fiber	Specifies the link length (in μm - micron) supported by the pluggable transceiver using 50 micron multi-mode fiber.
Diagnostic Calibration	Specifies whether the pluggable transceiver supports DDM or DOM Internal or External Calibration: Internal is displayed if the pluggable transceiver supports DDM or DOM Internal Calibration. External is displayed if the pluggable transceiver supports DDM or DOM External Calibration. - is displayed if neither Internal Calibration or External Calibration is supported.
Power Monitoring	Displays the received power measurement type, which can be either OMA (Optical Module Amplitude) or Avg (Average Power) measured in μW .

Related Commands

- [show system environment](#)
- [show system pluggable](#)
- [show system pluggable diagnostics](#)

show system pluggable diagnostics

Overview This command displays diagnostic information about SFP pluggable transceivers that support Digital Diagnostic Monitoring (DDM).

Different types of pluggable transceivers are supported in different models of device. See your device's Datasheet for more information about the models of pluggables that your device supports.

For information on filtering and saving command output, see the ["Getting Started with AlliedWare Plus" Feature Overview and Configuration Guide](#).

Syntax `show system pluggable [<port-list>] diagnostics`

Parameter	Description
<port-list>	The Eth port or ports to display information about (e.g. eth1 or eth1,eth2)

Mode User Exec and Privileged Exec

Usage Modern optical SFP transceivers support Digital Diagnostics Monitoring (DDM) functions.

Diagnostic monitoring features allow you to monitor real-time parameters of the pluggable transceiver, such as optical output power, optical input power, temperature, laser bias current, and transceiver supply voltage. Additionally, RX LOS (Loss of Signal) is shown when the received optical level is below a preset threshold. Monitor these parameters to check on the health of all transceivers, selected transceivers or a specific transceiver installed in a device.

Examples To display detailed information about all pluggable transceivers installed on a standalone device, use the command:

```
awplus# show system pluggable diagnostics
```

Output Figure 8-5: Example output from the **show system pluggable diagnostics** command on a device

```
awplus#show system pluggable diagnostics
System Pluggable Information Diagnostics
```

Eth1	Status	Alarms			Warnings		
	Reading	Alarm	Max	Min	Warning	Max	Min
Temp: (Degrees C)	31.105	-	78.00	-13.00	-	73.000	-8.000
Vcc: (Volts)	3.283	-	3.800	2.800	-	3.500	3.100
Tx Bias: (mA)	-	Low	15.440	0.440	Low	-12.440	2.440
Tx Power: (mW)	0.357	Low	1.175	0.200	Low	0.933	0.251
Rx Power: (mW)	-	Low	1.259	0.049	Low	1.000	0.062
Rx LOS:	Rx Down						

Table 9: Parameters in the output from the **show system pluggables diagnostics** command

Parameter	Description
Temp (Degrees C)	Shows the temperature inside the transceiver.
Vcc (Volts)	Shows voltage supplied to the transceiver.
Tx Bias (mA)	Shows current to the Laser Diode in the transceiver.
Tx Power (mW)	Shows the amount of light transmitted from the transceiver.
Rx Power (mW)	Shows the amount of light received in the transceiver.
Rx LOS	Rx Loss of Signal. This indicates whether: <ul style="list-style-type: none">• light is being received (Rx Up) and therefore the link is up, or• light is not being received (Rx Down) and therefore the link is down

**Related
Commands**

[show system environment](#)

[show system pluggable](#)

[show system pluggable detail](#)

9

Logging Commands

Introduction

Overview This chapter provides an alphabetical reference of commands used to configure logging. See the [Logging Feature Overview and Configuration Guide](#) for more information about the different types of log and how to filter log messages.

- Command List**
- [“clear exception log”](#) on page 304
 - [“clear log”](#) on page 305
 - [“clear log buffered”](#) on page 306
 - [“clear log external”](#) on page 307
 - [“clear log permanent”](#) on page 308
 - [“connection-log events”](#) on page 309
 - [“copy buffered-log”](#) on page 310
 - [“copy permanent-log”](#) on page 311
 - [“default log buffered”](#) on page 312
 - [“default log console”](#) on page 313
 - [“default log email”](#) on page 314
 - [“default log external”](#) on page 315
 - [“default log host”](#) on page 316
 - [“default log monitor”](#) on page 317
 - [“default log permanent”](#) on page 318
 - [“log buffered”](#) on page 319
 - [“log buffered \(filter\)”](#) on page 320
 - [“log buffered exclude”](#) on page 323
 - [“log buffered size”](#) on page 326

- [“log console”](#) on page 327
- [“log console \(filter\)”](#) on page 328
- [“log console exclude”](#) on page 331
- [“log date-format”](#) on page 334
- [“log email”](#) on page 335
- [“log email \(filter\)”](#) on page 336
- [“log email exclude”](#) on page 339
- [“log email time”](#) on page 342
- [“log external”](#) on page 344
- [“log external \(filter\)”](#) on page 346
- [“log external exclude”](#) on page 349
- [“log external rotate”](#) on page 352
- [“log external size”](#) on page 354
- [“log facility”](#) on page 355
- [“log host”](#) on page 357
- [“log host \(filter\)”](#) on page 359
- [“log host exclude”](#) on page 362
- [“log host source”](#) on page 365
- [“log host time”](#) on page 366
- [“log monitor \(filter\)”](#) on page 368
- [“log monitor exclude”](#) on page 371
- [“log permanent”](#) on page 374
- [“log permanent \(filter\)”](#) on page 375
- [“log permanent exclude”](#) on page 378
- [“log permanent size”](#) on page 381
- [“log-rate-limit nsm”](#) on page 382
- [“log trustpoint”](#) on page 384
- [“log url-requests”](#) on page 385
- [“show connection-log events”](#) on page 386
- [“show counter log”](#) on page 387
- [“show exception log”](#) on page 388
- [“show log”](#) on page 389
- [“show log config”](#) on page 391
- [“show log external”](#) on page 393
- [“show log permanent”](#) on page 394

- [“show running-config log”](#) on page 395
- [“unmount”](#) on page 396

clear exception log

Overview This command resets the contents of the exception log, but does not remove the associated core files.

Syntax `clear exception log`

Mode Privileged Exec

Example `awplus# clear exception log`

clear log

Overview This command removes the contents of the buffered and permanent logs.

Syntax `clear log`

Mode Privileged Exec

Example To delete the contents of the buffered and permanent log use the command:

```
awplus# clear log
```

**Related
Commands**

- [clear log buffered](#)
- [clear log permanent](#)
- [show log](#)

clear log buffered

Overview This command removes the contents of the buffered log.

Syntax `clear log buffered`

Mode Privileged Exec

Example To delete the contents of the buffered log use the following commands:

```
awplus# clear log buffered
```

**Related
Commands** [default log buffered](#)

[log buffered](#)

[log buffered \(filter\)](#)

[log buffered size](#)

[log buffered exclude](#)

[show log](#)

[show log config](#)

clear log external

Overview Use this command to delete the external log file from the SD card or USB storage device it is stored on.

If the external log is rotating between multiple files, this command deletes all those files, not just the most recent one.

Syntax `clear log external`

Mode Privileged Exec

Example To delete the external log file, use the command:

```
awplus# clear log external
```

Related Commands

- [default log external](#)
- [log external](#)
- [log external \(filter\)](#)
- [log external exclude](#)
- [log external rotate](#)
- [log external size](#)
- [show log config](#)
- [show log external](#)
- [unmount](#)

Command changes Version 5.4.7-1.1: command added

clear log permanent

Overview This command removes the contents of the permanent log.

Syntax `clear log permanent`

Mode Privileged Exec

Example To delete the contents of the permanent log use the following commands:

```
awplus# clear log permanent
```

Related Commands

- [default log permanent](#)
- [log permanent](#)
- [log permanent \(filter\)](#)
- [log permanent exclude](#)
- [log permanent size](#)
- [show log config](#)
- [show log permanent](#)

connection-log events

Overview Use this command to enable extra logging for indicating the start and the end of connections passing through the firewall.

Use the **no** variant of this command to turn off the extra logging of connections passing through the firewall.

Syntax `connection-log events [new|end|all]`
`no connection-log events [new|end|all]`

Parameter	Description
new	New connection
end	Connections closed
all	All new connections and connections closed. Default.

Default Connection logging is not enabled by default.

Mode Global Configuration.

Usage There are two types of messages you can log: new connections and connections that ended. You can control the amount of messages you log by choosing to log either type of message or all of the message types.

Messages contain the following information:

- time
- source and destination addresses (NATed and unNATed)
- protocol
- source and destination ports (NATed and unNATed)
- bytes and packets passed (found in the connection end message)

Example To log all of the new connections and all of the closed connections, use the commands:

```
awplus# configure terminal
awplus(config)# connection-log events all
```

Related Commands [show connection-log events](#)

Command changes Version 5.4.7-1.1: command added.

copy buffered-log

Overview Use this command to copy the buffered log to an internal or external destination.

Syntax `copy buffered-log <destination-name>`

Parameter	Description
<code><destination-name></code>	The filename and path for the destination file. See Introduction on page 110 for valid syntax.

Mode Privileged Exec

Example To copy the buffered log file onto a USB storage device and name the file "buffered-log.log", use the command:

```
awplus# copy buffered-log usb:/buffered-log.log
```

Related Commands

- [log buffered](#)
- [show file systems](#)
- [show log](#)

Command changes Version 5.4.7-1.1: command added

copy permanent-log

Overview Use this command to copy the permanent log to an internal or external destination.

Syntax `copy permanent-log <destination-name>`

Parameter	Description
<code><destination-name></code>	The filename and path for the destination file. See Introduction on page 110 for valid syntax.

Mode Privileged Exec

Example To copy the permanent log file onto a USB storage device and name the file "permanent-log.log", use the command:

```
awplus# copy permanent-log usb:/permanent-log.log
```

Related Commands

- [log permanent](#)
- [show file systems](#)
- [show log permanent](#)

Command changes Version 5.4.7-1.1: command added

default log buffered

Overview This command restores the default settings for the buffered log stored in RAM. By default the size of the buffered log is 50 kB and it accepts messages with the severity level of “warnings” and above.

Syntax `default log buffered`

Default The buffered log is enabled by default.

Mode Global Configuration

Example To restore the buffered log to its default settings use the following commands:

```
awplus# configure terminal
awplus(config)# default log buffered
```

Related Commands

- [clear log buffered](#)
- [log buffered](#)
- [log buffered \(filter\)](#)
- [log buffered size](#)
- [log buffered exclude](#)
- [show log](#)
- [show log config](#)

default log console

Overview This command restores the default settings for log messages sent to the terminal when a `log console` command is issued. By default all messages are sent to the console when a **log console** command is issued.

Syntax `default log console`

Mode Global Configuration

Example To restore the log console to its default settings use the following commands:

```
awplus# configure terminal
awplus(config)# default log console
```

Related Commands

- `log console`
- `log console (filter)`
- `log console exclude`
- `show log config`

default log email

Overview This command restores the default settings for log messages sent to an email address. By default no filters are defined for email addresses. Filters must be defined before messages will be sent. This command also restores the remote syslog server time offset value to local (no offset).

Syntax `default log email <email-address>`

Parameter	Description
<code><email-address></code>	The email address to send log messages to

Mode Global Configuration

Example To restore the default settings for log messages sent to the email address `admin@alliedtelesis.com` use the following commands:

```
awplus# configure terminal
awplus(config)# default log email admin@alliedtelesis.com
```

Related Commands

- [log email](#)
- [log email \(filter\)](#)
- [log email exclude](#)
- [log email time](#)
- [show log config](#)

default log external

Overview Use this command to restore the default settings for the external log. By default, the size of the external log is 50 kB, it rotates through 1 additional file, and it accepts messages with a severity level of notices and above.

Note that this command does not clear the configured filename for the external log.

Syntax `default log external`

Mode Global Configuration

Example To restore the default settings for the external log, use the commands:

```
awplus# configure terminal
awplus(config)# default log external
```

Related Commands

- [clear log external](#)
- [log external](#)
- [log external \(filter\)](#)
- [log external exclude](#)
- [log external rotate](#)
- [log external size](#)
- [show log config](#)
- [show log external](#)
- [unmount](#)

Command changes Version 5.4.7-1.1: command added

default log host

Overview This command restores the default settings for log sent to a remote syslog server. By default no filters are defined for remote syslog servers. Filters must be defined before messages will be sent. This command also restores the remote syslog server time offset value to local (no offset).

Syntax `default log host <ip-addr>`

Parameter	Description
<code><ip-addr></code>	The IP address of a remote syslog server

Mode Global Configuration

Example To restore the default settings for messages sent to the remote syslog server with IP address 10.32.16.21 use the following commands:

```
awplus# configure terminal
awplus(config)# default log host 10.32.16.21
```

Related Commands

- [log host](#)
- [log host \(filter\)](#)
- [log host exclude](#)
- [log host source](#)
- [log host time](#)
- [show log config](#)

default log monitor

Overview This command restores the default settings for log messages sent to the terminal when a [terminal monitor](#) command is used.

Syntax `default log monitor`

Default All messages are sent to the terminal when a [terminal monitor](#) command is used.

Mode Global Configuration

Example To restore the log monitor to its default settings use the following commands:

```
awplus# configure terminal
awplus(config)# default log monitor
```

**Related
Commands**

- [log monitor \(filter\)](#)
- [log monitor exclude](#)
- [show log config](#)
- [terminal monitor](#)

default log permanent

Overview This command restores the default settings for the permanent log stored in NVS. By default, the size of the permanent log is 50 kB and it accepts messages with the severity level of `warnings` and above.

Syntax `default log permanent`

Default The permanent log is enabled by default.

Mode Global Configuration

Example To restore the permanent log to its default settings use the following commands:

```
awplus# configure terminal
awplus(config)# default log permanent
```

Related Commands

- [clear log permanent](#)
- [log permanent](#)
- [log permanent \(filter\)](#)
- [log permanent exclude](#)
- [log permanent size](#)
- [show log config](#)
- [show log permanent](#)

log buffered

Overview This command configures the device to store log messages in RAM. Messages stored in RAM are not retained on the device over a restart. Once the buffered log reaches its configured maximum allowable size old messages will be deleted to make way for new ones.

Syntax `log buffered`
`no log buffered`

Default The buffered log is configured by default.

Mode Global Configuration

Examples To configured the device to store log messages in RAM use the following commands:

```
awplus# configure terminal
awplus(config)# log buffered
```

To configure the device to not store log messages in a RAM buffer use the following commands:

```
awplus# configure terminal
awplus(config)# no log buffered
```

Related Commands

- [clear log buffered](#)
- [copy buffered-log](#)
- [default log buffered](#)
- [log buffered \(filter\)](#)
- [log buffered size](#)
- [log buffered exclude](#)
- [show log](#)
- [show log config](#)

log buffered (filter)

Overview Use this command to create a filter to select messages to be sent to the buffered log. Selection can be based on the priority/ severity of the message, the program that generated the message, the logging facility used, a sub-string within the message or a combination of some or all of these.

The **no** variant of this command removes the corresponding filter, so that the specified messages are no longer sent to the buffered log.

Syntax `log buffered [level <level>] [program <program-name>] [facility <facility>] [msgtext <text-string>]`
`no log buffered [level <level>] [program <program-name>] [facility <facility>] [msgtext <text-string>]`

Parameter	Description
level	Filter messages to the buffered log by severity level.
<level>	The minimum severity of message to send to the buffered log. The level can be specified as one of the following numbers or level names, where 0 is the highest severity and 7 is the lowest severity:
0 emergencies	System is unusable
1 alerts	Action must be taken immediately
2 critical	Critical conditions
3 errors	Error conditions
4 warnings	Warning conditions
5 notices	Normal, but significant, conditions
6 informational	Informational messages
7 debugging	Debug-level messages
program	Filter messages to the buffered log by program. Include messages from a specified program in the buffered log.
<program-name>	The name of a program to log messages from, either one of the following predefined program names (not case-sensitive), or another program name (case-sensitive) that you find in the log output:
rip	Routing Information Protocol (RIP)
ripng	Routing Information Protocol - next generation (RIPng)
ospf	Open Shortest Path First (OSPF)
ospfv3	Open Shortest Path First (OSPF) version 3 (OSPFv3)
bgp	Border Gateway Protocol (BGP)
rsvp	Resource Reservation Protocol (RSVP)
pim-sm	Protocol Independent Multicast - Sparse Mode (PIM-SM)

Parameter	Description
<code>pim-smv6</code>	PIM-SM version 6 (PIM-SMv6)
<code>lacp</code>	Link Aggregation Control Protocol (LACP)
<code>stp</code>	Spanning Tree Protocol (STP)
<code>rstp</code>	Rapid Spanning Tree Protocol (RSTP)
<code>mstp</code>	Multiple Spanning Tree Protocol (MSTP)
<code>imi</code>	Integrated Management Interface (IMI)
<code>imish</code>	Integrated Management Interface Shell (IMISH)
<code>facility</code>	Filter messages to the buffered log by syslog facility.
<code><facility></code>	Specify one of the following syslog facilities to include messages from in the buffered log:
<code>kern</code>	Kernel messages
<code>user</code>	Random user-level messages
<code>mail</code>	Mail system
<code>daemon</code>	System daemons
<code>auth</code>	Security/authorization messages
<code>syslog</code>	Messages generated internally by syslogd
<code>lpr</code>	Line printer subsystem
<code>news</code>	Network news subsystem
<code>uucp</code>	UUCP subsystem
<code>cron</code>	Clock daemon
<code>authpriv</code>	Security/authorization messages (private)
<code>ftp</code>	FTP daemon
<code>msgtext</code>	Select messages containing a certain text string.
<code><text-string></code>	A text string to match (maximum 128 characters). This is case sensitive, and must be the last text on the command line.

Default By default the buffered log has a filter to select messages whose severity level is “notices (5)” or higher. This filter may be removed using the **no** variant of this command.

Mode Global Configuration

Examples To add a filter to send all messages containing the text “Bridging initialization” to the buffered log, use the following commands:

```
awplus# configure terminal
awplus(config)# log buffered msgtext Bridging initialization
```

To remove a filter that sends all messages containing the text “Bridging initialization” to the buffered log, use the following commands:

```
awplus# configure terminal
awplus(config)# no log buffered msgtext Bridging initialization
```

**Related
Commands**

clear log buffered
default log buffered
log buffered
log buffered size
log buffered exclude
show log
show log config

log buffered exclude

Overview Use this command to exclude specified log messages from the buffered log. You can exclude messages on the basis of:

- the priority/severity of the message
- the program that generated the message
- the logging facility used
- a sub-string within the message, or
- a combination of some or all of these.

Use the **no** variant of this command to stop excluding the specified messages.

Syntax `log buffered exclude [level <level>] [program <program-name>] [facility <facility>] [msgtext <text-string>]`
`no log buffered exclude [level <level>] [program <program-name>] [facility <facility>] [msgtext <text-string>]`

Parameter	Description
level	Exclude messages of the specified severity level.
<level>	The severity level to exclude. The level can be specified as one of the following numbers or level names, where 0 is the highest severity and 7 is the lowest severity:
0 emergencies	System is unusable
1 alerts	Action must be taken immediately
2 critical	Critical conditions
3 errors	Error conditions
4 warnings	Warning conditions
5 notices	Normal, but significant, conditions
6 informational	Informational messages
7 debugging	Debug-level messages
program	Exclude messages from a specified program.
<program-name>	The name of a program. Either one of the following predefined program names (not case-sensitive), or another program name (case-sensitive) that you find in the log output.
rip	Routing Information Protocol (RIP)
ripng	Routing Information Protocol - next generation (RIPng)
ospf	Open Shortest Path First (OSPF)
ospfv3	Open Shortest Path First (OSPF) version 3 (OSPFv3)
bgp	Border Gateway Protocol (BGP)
rsvp	Resource Reservation Protocol (RSVP)

Parameter	Description
pim-sm	Protocol Independent Multicast - Sparse Mode (PIM-SM)
pim-smv6	PIM-SM version 6 (PIM-SMv6)
lacp	Link Aggregation Control Protocol (LACP)
stp	Spanning Tree Protocol (STP)
rstp	Rapid Spanning Tree Protocol (RSTP)
mstp	Multiple Spanning Tree Protocol (MSTP)
imi	Integrated Management Interface (IMI)
imish	Integrated Management Interface Shell (IMISH)
facility	Exclude messages from a syslog facility.
<facility>	Specify one of the following syslog facilities to exclude messages from:
kern	Kernel messages
user	Random user-level messages
mail	Mail system
daemon	System daemons
auth	Security/authorization messages
syslog	Messages generated internally by syslogd
lpr	Line printer subsystem
news	Network news subsystem
uucp	UUCP subsystem
cron	Clock daemon
authpriv	Security/authorization messages (private)
ftp	FTP daemon
msgtext	Exclude messages containing a certain text string.
<text-string>	A text string to match (maximum 128 characters). This is case sensitive, and must be the last text on the command line.

Default No log messages are excluded

Mode Global configuration

Example To remove messages that contain the string "example of irrelevant message", use the following commands:

```
awplus# configure terminal
awplus(config)# log buffered exclude msgtext example of
irrelevant message
```

**Related
Commands**

- clear log buffered
- default log buffered
- log buffered
- log buffered (filter)
- log buffered size
- show log
- show log config

log buffered size

Overview This command configures the amount of memory that the buffered log is permitted to use. Once this memory allocation has been filled old messages will be deleted to make room for new messages.

Syntax `log buffered size <50-250>`

Parameter	Description
<50-250>	Size of the RAM log in kilobytes

Mode Global Configuration

Example To allow the buffered log to use up to 100 kB of RAM use the following commands:

```
awplus# configure terminal
awplus(config)# log buffered size 100
```

Related Commands

- [clear log buffered](#)
- [copy buffered-log](#)
- [default log buffered](#)
- [log buffered](#)
- [log buffered \(filter\)](#)
- [log buffered exclude](#)
- [show log](#)
- [show log config](#)

log console

Overview This command configures the device to send log messages to consoles. The console log is configured by default to send messages to the device's main console port.

Use the **no** variant of this command to configure the device not to send log messages to consoles.

Syntax `log console`
`no log console`

Mode Global Configuration

Examples To configure the device to send log messages use the following commands:

```
awplus# configure terminal
awplus(config)# log console
```

To configure the device not to send log messages in all consoles use the following commands:

```
awplus# configure terminal
awplus(config)# no log console
```

**Related
Commands** [default log console](#)
[log console \(filter\)](#)
[log console exclude](#)
[show log config](#)

log console (filter)

Overview This command creates a filter to select messages to be sent to all consoles when the **log console** command is given. Selection can be based on the priority/severity of the message, the program that generated the message, the logging facility used, a sub-string within the message or a combination of some or all of these.

Syntax `log console [level <level>] [program <program-name>] [facility <facility>] [msgtext <text-string>]`
`no log console [level <level>] [program <program-name>] [facility <facility>] [msgtext <text-string>]`

Parameter	Description
level	Filter messages by severity level.
<level>	The minimum severity of message to send. The level can be specified as one of the following numbers or level names, where 0 is the highest severity and 7 is the lowest severity:
0 emergencies	System is unusable
1 alerts	Action must be taken immediately
2 critical	Critical conditions
3 errors	Error conditions
4 warnings	Warning conditions
5 notices	Normal, but significant, conditions
6 informational	Informational messages
7 debugging	Debug-level messages
program	Filter messages by program. Include messages from a specified program.
<program-name>	The name of a program to log messages from, either one of the following predefined program names (not case-sensitive), or another program name (case-sensitive) that you find in the log output:
rip	Routing Information Protocol (RIP)
ripng	Routing Information Protocol - next generation (RIPng)
ospf	Open Shortest Path First (OSPF)
ospfv3	Open Shortest Path First (OSPF) version 3 (OSPFv3)
bgp	Border Gateway Protocol (BGP)
rsvp	Resource Reservation Protocol (RSVP)
pim-sm	Protocol Independent Multicast - Sparse Mode (PIM-SM)
pim-smv6	PIM-SM version 6 (PIM-SMv6)
lacp	Link Aggregation Control Protocol (LACP)
stp	Spanning Tree Protocol (STP)

Parameter	Description
	rstp Rapid Spanning Tree Protocol (RSTP)
	mstp Multiple Spanning Tree Protocol (MSTP)
	imi Integrated Management Interface (IMI)
	imish Integrated Management Interface Shell (IMISH)
facility	Filter messages by syslog facility.
<facility>	Specify one of the following syslog facilities to include messages from:
	kern Kernel messages
	user Random user-level messages
	mail Mail system
	daemon System daemons
	auth Security/authorization messages
	syslog Messages generated internally by syslogd
	lpr Line printer subsystem
	news Network news subsystem
	uucp UUCP subsystem
	cron Clock daemon
	authpriv Security/authorization messages (private)
	ftp FTP daemon
msgtext	Select messages containing a certain text string.
<text-string>	A text string to match (maximum 128 characters). This is case sensitive, and must be the last text on the command line.

Default By default the console log has a filter to select messages whose severity level is **critical** or higher. This filter may be removed using the **no** variant of this command. This filter may be removed and replaced by filters that are more selective.

Mode Global Configuration

Examples To create a filter to send all messages containing the text "Bridging initialization" to console instances where the **log console** command has been entered, use the following commands:

```
awplus# configure terminal
awplus(config)# log console msgtext "Bridging initialization"
```

To remove a default filter that includes sending **critical**, **alert** and **emergency** level messages to the console, use the following commands:

```
awplus# configure terminal
awplus(config)# no log console level critical
```

**Related
Commands**

- default log console
- log console
- log console exclude
- show log config

log console exclude

Overview Use this command to prevent specified log messages from being sent to the console, when console logging is turned on. You can exclude messages on the basis of:

- the priority/severity of the message
- the program that generated the message
- the logging facility used
- a sub-string within the message, or
- a combination of some or all of these.

Use the **no** variant of this command to stop excluding the specified messages.

Syntax `log console exclude [level <level>] [program <program-name>]
[facility <facility>] [msgtext <text-string>]`
`no log console exclude [level <level>] [program <program-name>]
[facility <facility>] [msgtext <text-string>]`

Parameter	Description
level	Exclude messages of the specified severity level.
<level>	The severity level to exclude. The level can be specified as one of the following numbers or level names, where 0 is the highest severity and 7 is the lowest severity:
0 emergencies	System is unusable
1 alerts	Action must be taken immediately
2 critical	Critical conditions
3 errors	Error conditions
4 warnings	Warning conditions
5 notices	Normal, but significant, conditions
6 informational	Informational messages
7 debugging	Debug-level messages
program	Exclude messages from a specified program.
<program-name>	The name of a program. Either one of the following predefined program names (not case-sensitive), or another program name (case-sensitive) that you find in the log output.
rip	Routing Information Protocol (RIP)
ripng	Routing Information Protocol - next generation (RIPng)
ospf	Open Shortest Path First (OSPF)
ospfv3	Open Shortest Path First (OSPF) version 3 (OSPFv3)
bgp	Border Gateway Protocol (BGP)

Parameter	Description
rsvp	Resource Reservation Protocol (RSVP)
pim-sm	Protocol Independent Multicast - Sparse Mode (PIM-SM)
pim-smv6	PIM-SM version 6 (PIM-SMv6)
lacp	Link Aggregation Control Protocol (LACP)
stp	Spanning Tree Protocol (STP)
rstp	Rapid Spanning Tree Protocol (RSTP)
mstp	Multiple Spanning Tree Protocol (MSTP)
imi	Integrated Management Interface (IMI)
imish	Integrated Management Interface Shell (IMISH)
facility	Exclude messages from a syslog facility.
<facility>	Specify one of the following syslog facilities to exclude messages from:
kern	Kernel messages
user	Random user-level messages
mail	Mail system
daemon	System daemons
auth	Security/authorization messages
syslog	Messages generated internally by syslogd
lpr	Line printer subsystem
news	Network news subsystem
uucp	UUCP subsystem
cron	Clock daemon
authpriv	Security/authorization messages (private)
ftp	FTP daemon
msgtext	Exclude messages containing a certain text string.
<text-string>	A text string to match (maximum 128 characters). This is case sensitive, and must be the last text on the command line.

Default No log messages are excluded

Mode Global configuration

Example To remove messages that contain the string “example of irrelevant message”, use the following commands:

```
awplus# configure terminal
awplus(config)# log console exclude msgtext example of
irrelevant message
```

**Related
Commands**

- default log console
- log console
- log console (filter)
- show log config

log date-format

Overview Use this command to change the date format for log messages to an ISO 8601 compliant format, or to return to the default date format.

Syntax `log date-format {iso|default}`

Parameter	Description
iso	Display the date and time in the ISO 8601 compliant format of: YYYY-MM-DDThh:mm:ssTZD
default	Display the date and time in the default date format of YYYY MMM DD HH:MM:SS

Default The default option of YYYY MMM DD HH:MM:SS (except when using terminal monitor, when it is HH:MM:SS)

Mode Global Configuration

Usage In the ISO 8601 compliant format, a T separates the date from the time, and the time is followed by the timezone offset from UTC time. For example, this is a log message with an ISO 8601 compliant date:

```
2016-09-29T08:55:43+13:00 user.notice Gateway IMISH[1983]:  
[manager@ttyS0]show run
```

This is a log message with the default date format:

```
2016 Sep 29 08:55:43 user.notice Gateway IMISH[1983]:  
[manager@ttyS0]show run
```

The date format setting affects all log messages, no matter where the messages are stored or displayed.

Examples To set the date format to the ISO 8601 compliant format, use the commands:

```
awplus# configure terminal  
awplus(config)# log date-format iso
```

To return to the default date format of YYYY MMM DD HH:MM:SS, use the commands:

```
awplus# configure terminal  
awplus(config)# log date-format default
```

Related Commands [show exception log](#)
[show log](#)
[show log permanent](#)

Command changes Version 5.4.6-2.1: command added

log email

Overview This command configures the device to send log messages to an email address. The email address is specified in this command.

Syntax `log email <email-address>`

Parameter	Description
<code><email-address></code>	The email address to send log messages to

Default By default no filters are defined for email log targets. Filters must be defined before messages will be sent.

Mode Global Configuration

Example To have log messages emailed to the email address `admin@alliedtelesis.com` use the following commands:

```
awplus# configure terminal
awplus(config)# log email admin@alliedtelesis.com
```

Related Commands

- [default log email](#)
- [log email \(filter\)](#)
- [log email exclude](#)
- [log email time](#)
- [show log config](#)

log email (filter)

Overview This command creates a filter to select messages to be sent to an email address. Selection can be based on the priority/ severity of the message, the program that generated the message, the logging facility used, a sub-string within the message or a combination of some or all of these.

The **no** variant of this command configures the device to no longer send log messages to a specified email address. All configuration relating to this log target will be removed.

Syntax `log email <email-address> [level <level>] [program <program-name>] [facility <facility>] [msgtext <text-string>]`
`no log email <email-address> [level <level>] [program <program-name>] [facility <facility>] [msgtext <text-string>]`

Parameter	Description
<code><email-address></code>	The email address to send logging messages to
<code>level</code>	Filter messages by severity level.
<code><level></code>	The minimum severity of message to send. The level can be specified as one of the following numbers or level names, where 0 is the highest severity and 7 is the lowest severity:
0 emergencies	System is unusable
1 alerts	Action must be taken immediately
2 critical	Critical conditions
3 errors	Error conditions
4 warnings	Warning conditions
5 notices	Normal, but significant, conditions
6 informational	Informational messages
7 debugging	Debug-level messages
<code>program</code>	Filter messages by program. Include messages from a specified program.
<code><program-name></code>	The name of a program to log messages from, either one of the following predefined program names (not case-sensitive), or another program name (case-sensitive) that you find in the log output:
rip	Routing Information Protocol (RIP)
ripng	Routing Information Protocol - next generation (RIPng)
ospf	Open Shortest Path First (OSPF)
ospfv3	Open Shortest Path First (OSPF) version 3 (OSPFv3)
bgp	Border Gateway Protocol (BGP)
rsvp	Resource Reservation Protocol (RSVP)

Parameter	Description
pim-sm	Protocol Independent Multicast - Sparse Mode (PIM-SM)
pim-smv6	PIM-SM version 6 (PIM-SMv6)
lacp	Link Aggregation Control Protocol (LACP)
stp	Spanning Tree Protocol (STP)
rstp	Rapid Spanning Tree Protocol (RSTP)
mstp	Multiple Spanning Tree Protocol (MSTP)
imi	Integrated Management Interface (IMI)
imish	Integrated Management Interface Shell (IMISH)
facility	Filter messages by syslog facility.
<facility>	Specify one of the following syslog facilities to include messages from:
kern	Kernel messages
user	Random user-level messages
mail	Mail system
daemon	System daemons
auth	Security/authorization messages
syslog	Messages generated internally by syslogd
lpr	Line printer subsystem
news	Network news subsystem
uucp	UUCP subsystem
cron	Clock daemon
authpriv	Security/authorization messages (private)
ftp	FTP daemon
msgtext	Select messages containing a certain text string.
<text-string>	A text string to match (maximum 128 characters). This is case sensitive, and must be the last text on the command line.

Mode Global Configuration

Examples To create a filter to send all messages containing the text "Bridging initialization", to the email address admin@homebase.com, use the following commands:

```
awplus# configure terminal
awplus(config)# log email admin@homebase.com msgtext "Bridging
initialization"
```

To create a filter to send messages with a severity level of **informational** and above to the email address `admin@alliedtelesis.com`, use the following commands:

```
awplus# configure terminal
awplus(config)# log email admin@alliedtelesis.com level
informational
```

To stop the device emailing log messages emailed to the email address `admin@alliedtelesis.com`, use the following commands:

```
awplus# configure terminal
awplus(config)# no log email admin@homebase.com
```

To remove a filter that sends messages with a severity level of **informational** and above to the email address `admin@alliedtelesis.com`, use the following commands:

```
awplus# configure terminal
awplus(config)# no log email admin@alliedtelesis.com level
informational
```

**Related
Commands**

- [default log email](#)
- [log email](#)
- [log email exclude](#)
- [log email time](#)
- [show log config](#)

log email exclude

Overview Use this command to prevent specified log messages from being emailed, when the device is configured to send log messages to an email address. You can exclude messages on the basis of:

- the priority/severity of the message
- the program that generated the message
- the logging facility used
- a sub-string within the message, or
- a combination of some or all of these.

Use the **no** variant of this command to stop excluding the specified messages.

Syntax `log email exclude [level <level>] [program <program-name>]
[facility <facility>] [msgtext <text-string>]`
`no log email exclude [level <level>] [program <program-name>]
[facility <facility>] [msgtext <text-string>]`

Parameter	Description
level	Exclude messages of the specified severity level.
<level>	The severity level to exclude. The level can be specified as one of the following numbers or level names, where 0 is the highest severity and 7 is the lowest severity:
0 emergencies	System is unusable
1 alerts	Action must be taken immediately
2 critical	Critical conditions
3 errors	Error conditions
4 warnings	Warning conditions
5 notices	Normal, but significant, conditions
6 informational	Informational messages
7 debugging	Debug-level messages
program	Exclude messages from a specified program.
<program-name>	The name of a program. Either one of the following predefined program names (not case-sensitive), or another program name (case-sensitive) that you find in the log output.
rip	Routing Information Protocol (RIP)
ripng	Routing Information Protocol - next generation (RIPng)
ospf	Open Shortest Path First (OSPF)
ospfv3	Open Shortest Path First (OSPF) version 3 (OSPFv3)
bgp	Border Gateway Protocol (BGP)

Parameter	Description
rsvp	Resource Reservation Protocol (RSVP)
pim-sm	Protocol Independent Multicast - Sparse Mode (PIM-SM)
pim-smv6	PIM-SM version 6 (PIM-SMv6)
lacp	Link Aggregation Control Protocol (LACP)
stp	Spanning Tree Protocol (STP)
rstp	Rapid Spanning Tree Protocol (RSTP)
mstp	Multiple Spanning Tree Protocol (MSTP)
imi	Integrated Management Interface (IMI)
imish	Integrated Management Interface Shell (IMISH)
facility	Exclude messages from a syslog facility.
<facility>	Specify one of the following syslog facilities to exclude messages from:
kern	Kernel messages
user	Random user-level messages
mail	Mail system
daemon	System daemons
auth	Security/authorization messages
syslog	Messages generated internally by syslogd
lpr	Line printer subsystem
news	Network news subsystem
uucp	UUCP subsystem
cron	Clock daemon
authpriv	Security/authorization messages (private)
ftp	FTP daemon
msgtext	Exclude messages containing a certain text string.
<text-string>	A text string to match (maximum 128 characters). This is case sensitive, and must be the last text on the command line.

Default No log messages are excluded

Mode Global configuration

Example To remove messages that contain the string “example of irrelevant message”, use the following commands:

```
awplus# configure terminal
awplus(config)# log email exclude msgtext example of irrelevant message
```

**Related
Commands**

- default log email
- log email
- log email (filter)
- log email time
- show log config

log email time

Overview This command configures the time used in messages sent to an email address. If the syslog server is in a different time zone to your device then the time offset can be configured using either the **utc-offset** parameter option keyword or the **local-offset** parameter option keyword, where **utc-offset** is the time difference from UTC (Universal Time, Coordinated) and **local-offset** is the difference from local time.

Syntax `log email <email-address> time {local|local-offset|utc-offset {plus|minus}<0-24>}`

Parameter	Description
<email-address>	The email address to send log messages to
time	Specify the time difference between the email recipient and the device you are configuring.
local	The device is in the same time zone as the email recipient
local-offset	The device is in a different time zone to the email recipient. Use the plus or minus keywords and specify the difference (offset) from local time of the device to the email recipient in hours.
utc-offset	The device is in a different time zone to the email recipient. Use the plus or minus keywords and specify the difference (offset) from UTC time of the device to the email recipient in hours.
plus	Negative offset (difference) from the device to the email recipient.
minus	Positive offset (difference) from the device to the email recipient.
<0-24>	World Time zone offset in hours

Default The default is **local** time.

Mode Global Configuration

Usage Use the **local** option if the email recipient is in the same time zone as this device. Messages will display the time as on the local device when the message was generated.

Use the **offset** option if the email recipient is in a different time zone to this device. Specify the time offset of the email recipient in hours. Messages will display the time they were generated on this device but converted to the time zone of the email recipient.

Examples To send messages to the email address `test@home.com` in the same time zone as the device's local time zone, use the following commands:

```
awplus# configure terminal
awplus(config)# log email admin@base.com time local 0
```

To send messages to the email address `admin@base.com` with the time information converted to the time zone of the email recipient, which is 3 hours ahead of the device's local time zone, use the following commands:

```
awplus# configure terminal
awplus(config)# log email admin@base.com time local-offset plus
3
```

To send messages to the email address `user@remote.com` with the time information converted to the time zone of the email recipient, which is 3 hours behind the device's UTC time zone, use the following commands:

```
awplus# configure terminal
awplus(config)# log email user@remote.com time utc-offset minus
3
```

**Related
Commands**

- [default log email](#)
- [log email](#)
- [log email \(filter\)](#)
- [log email exclude](#)
- [show log config](#)

log external

Overview Use this command to enable external logging. External logging sends syslog messages to a file on an SD card or USB storage device.

If the file does not already exist on the storage device, it (and any specified subdirectory) will be automatically created. If the file already exists, messages are appended to it.

Use the **no** variant of this command to disable external logging.

Syntax `log external <filename>`
`no log external`

Parameter	Description
<code><filename></code>	The file and optionally directory path to store the log messages in. See Introduction on page 110 for valid syntax.

Default External logging is disabled by default.

Mode Global Configuration

Usage We strongly recommend using ext3 or ext4 as the file system on the external storage device. These file systems have a lower risk of file corruption occurring if the switch or firewall loses power.

You should also unmount the storage device before removing it from the switch or firewall, to avoid corrupting the log file. To unmount the device, use the **unmount** command.

If you are using this on a VCStack, each stack member needs to have its own external storage device. Enabling or disabling external logging enables or disables it on all stack members.

Example To save messages to a file called "messages.log" in a directory called "log" on a USB storage device, use the command:

```
awplus# configure terminal
awplus(config)# log external usb:/log/messages.log
```

Related Commands

- [clear log external](#)
- [default log external](#)
- [log external \(filter\)](#)
- [log external exclude](#)
- [log external rotate](#)
- [log external size](#)
- [show log config](#)

show log external

unmount

Command changes Version 5.4.7-1.1: command added

log external (filter)

Overview Use this command to create a filter to select messages to be sent to the external log. You can include messages based on:

- the priority/severity of the message
- the program that generated the message
- the logging facility used
- a sub-string within the message, or
- a combination of some or all of these.

The **no** variant of this command removes the corresponding filter, so that the specified messages are no longer sent to the external log.

Syntax `log external [level <level>] [program <program-name>] [facility <facility>] [msgtext <text-string>]`
`no log external [level <level>] [program <program-name>] [facility <facility>] [msgtext <text-string>]`

Parameter	Description
level	Filter messages to the external log by severity level.
<level>	The minimum severity of message to send to the external log. The level can be specified as one of the following numbers or level names, where 0 is the highest severity and 7 is the lowest severity:
0 emergencies	System is unusable
1 alerts	Action must be taken immediately
2 critical	Critical conditions
3 errors	Error conditions
4 warnings	Warning conditions
5 notices	Normal, but significant, conditions
6 informational	Informational messages
7 debugging	Debug-level messages
program	Filter messages to the external log by program. Include messages from a specified program in the external log.
<program-name>	The name of a program to log messages from, either one of the following predefined program names (not case-sensitive), or another program name (case-sensitive) that you find in the log output:
rip	Routing Information Protocol (RIP)
ripng	Routing Information Protocol - next generation (RIPng)
ospf	Open Shortest Path First (OSPF)

Parameter	Description
ospfv3	Open Shortest Path First (OSPF) version 3 (OSPFv3)
bgp	Border Gateway Protocol (BGP)
rsvp	Resource Reservation Protocol (RSVP)
pim-sm	Protocol Independent Multicast - Sparse Mode (PIM-SM)
pim-smv6	PIM-SM version 6 (PIM-SMv6)
lacp	Link Aggregation Control Protocol (LACP)
stp	Spanning Tree Protocol (STP)
rstp	Rapid Spanning Tree Protocol (RSTP)
mstp	Multiple Spanning Tree Protocol (MSTP)
imi	Integrated Management Interface (IMI)
imish	Integrated Management Interface Shell (IMISH)
facility	Filter messages to the external log by syslog facility.
<facility>	Specify one of the following syslog facilities to include messages from in the log:
kern	Kernel messages
user	Random user-level messages
mail	Mail system
daemon	System daemons
auth	Security/authorization messages
syslog	Messages generated internally by syslogd
lpr	Line printer subsystem
news	Network news subsystem
uucp	UUCP subsystem
cron	Clock daemon
authpriv	Security/authorization messages (private)
ftp	FTP daemon
msgtext	Select messages containing a certain text string.
<text-string>	A text string to match (maximum 128 characters). This is case sensitive, and must be the last text on the command line.

Default By default the external log has a filter to select messages whose severity level is “notices (5)” or higher. This filter may be removed using the **no** variant of this command.

Mode Global Configuration

Examples To add a filter to send all messages containing the text “Bridging initialization” to the external log, use the following commands:

```
awplus# configure terminal
awplus(config)# log external msgtext Bridging initialization
```

To remove a filter that sends all messages containing the text “Bridging initialization” to the external log, use the following commands:

```
awplus# configure terminal
awplus(config)# no log external msgtext Bridging initialization
```

**Related
Commands**

clear log external
default log external
log external
log external exclude
log external rotate
log external size
show log config
show log external
unmount

**Command
changes** Version 5.4.7-1.1: command added

log external exclude

Overview Use this command to exclude specified log messages from the external log. You can exclude messages on the basis of:

- the priority/severity of the message
- the program that generated the message
- the logging facility used
- a sub-string within the message, or
- a combination of some or all of these.

Use the **no** variant of this command to stop excluding the specified messages.

Syntax `log external exclude [level <level>] [program <program-name>] [facility <facility>] [msgtext <text-string>]`
`no log external exclude [level <level>] [program <program-name>] [facility <facility>] [msgtext <text-string>]`

Parameter	Description
level	Exclude messages of the specified severity level.
<level>	The severity level to exclude. The level can be specified as one of the following numbers or level names, where 0 is the highest severity and 7 is the lowest severity:
0 emergencies	System is unusable
1 alerts	Action must be taken immediately
2 critical	Critical conditions
3 errors	Error conditions
4 warnings	Warning conditions
5 notices	Normal, but significant, conditions
6 informational	Informational messages
7 debugging	Debug-level messages
program	Exclude messages from a specified program.
<program-name>	The name of a program. Either one of the following predefined program names (not case-sensitive), or another program name (case-sensitive) that you find in the log output.
rip	Routing Information Protocol (RIP)
ripng	Routing Information Protocol - next generation (RIPng)
ospf	Open Shortest Path First (OSPF)
ospfv3	Open Shortest Path First (OSPF) version 3 (OSPFv3)
bgp	Border Gateway Protocol (BGP)
rsvp	Resource Reservation Protocol (RSVP)

Parameter	Description
pim-sm	Protocol Independent Multicast - Sparse Mode (PIM-SM)
pim-smv6	PIM-SM version 6 (PIM-SMv6)
lacp	Link Aggregation Control Protocol (LACP)
stp	Spanning Tree Protocol (STP)
rstp	Rapid Spanning Tree Protocol (RSTP)
mstp	Multiple Spanning Tree Protocol (MSTP)
imi	Integrated Management Interface (IMI)
imish	Integrated Management Interface Shell (IMISH)
facility	Exclude messages from a syslog facility.
<facility>	Specify one of the following syslog facilities to exclude messages from:
kern	Kernel messages
user	Random user-level messages
mail	Mail system
daemon	System daemons
auth	Security/authorization messages
syslog	Messages generated internally by syslogd
lpr	Line printer subsystem
news	Network news subsystem
uucp	UUCP subsystem
cron	Clock daemon
authpriv	Security/authorization messages (private)
ftp	FTP daemon
msgtext	Exclude messages containing a certain text string.
<text-string>	A text string to match (maximum 128 characters). This is case sensitive, and must be the last text on the command line.

Default No log messages are excluded

Mode Global Configuration

Example To remove messages that contain the string "example of irrelevant message", use the following commands:

```
awplus# configure terminal
awplus(config)# log external exclude msgtext example of
irrelevant message
```

Related Commands [clear log external](#)

default log external
log external
log external (filter)
log external rotate
log external size
show log config
show log external
unmount

Command changes Version 5.4.7-1.1: command added

log external rotate

Overview Use this command to configure the number of files that the external log can rotate through.

Use the **no** variant of this command to return to the default.

Syntax `log external rotate <0-255>`
`no log external rotate`

Parameter	Description
<0-255>	The number of additional files to rotate through. Note that the device rotates between the initial file and the number of additional files specified by this value - see the Usage section below.

Default The default is 1, which rotates between the initial file and 1 additional file (for example, rotates between messages.log and messages.log.1)

Mode Global Configuration

Usage The device rotates between the initial file and the number of additional files specified by this command. For example, the diagram below shows how setting rotate to 2 makes the device rotate through 3 files.

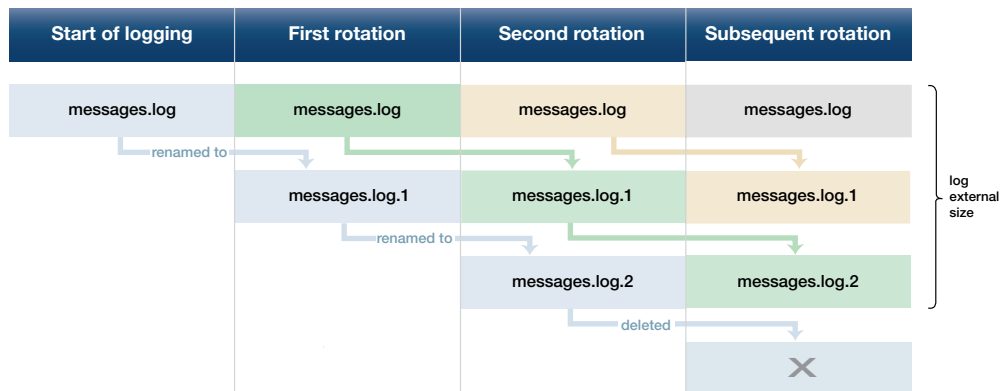

Note that if you set rotate to 0, and the external log file becomes full, then the device deletes the full log file and creates a new (empty) file of the same name to save messages into. For this reason, we recommend setting rotate to at least 1.

Example To set the rotation value to 2, and therefore rotate between 3 files, use the commands:

```
awplus# configure terminal
awplus(config)# log external rotate 2
```

**Related
Commands**

- clear log external
- default log external
- log external
- log external (filter)
- log external exclude
- log external size
- show log config
- show log external
- unmount

**Command
changes**

- Version 5.4.7-1.1: command added

log external size

Overview Use this command to configure the total amount of size that the external log is permitted to use, in kilobytes. The maximum possible depends on the storage device's file system.

Note that if you are rotating between multiple files, this is the maximum size of all files, not of each individual file. For example, if you are rotating between 2 files (**log external rotate 1**), each file will have a maximum size of 25 kBytes by default.

Use the **no** variant of this command to return to the default size.

Syntax `log external size [<50-4194304>]`
`no log external size`

Parameter	Description
<50-4194304>	The total amount of size that the external log is permitted to use, in kilobytes.

Default 50 kBytes

Mode Global Configuration

Example To configure a total log size of 100 kBytes, use the commands:

```
awplus# configure terminal
awplus(config)# log external size 100
```

Related Commands

- [clear log external](#)
- [default log external](#)
- [log external](#)
- [log external \(filter\)](#)
- [log external exclude](#)
- [log external rotate](#)
- [log external size](#)
- [show log config](#)
- [show log external](#)
- [unmount](#)

Command changes Version 5.4.7-1.1: command added

log facility

Overview Use this command to assign a facility to all log messages generated on this device. This facility overrides any facility that is automatically generated as part of the log message.

Use the **no** variant of this command to remove the configured facility.

Syntax `log facility {kern|user|mail|daemon|auth|syslog|lpr|news|uucp|cron|authpriv|ftp|local0|local1|local2|local3|local4|local5|local6|local7}`
`no log facility`

Default None. The outgoing syslog facility depends on the log message.

Mode Global Configuration

Usage Specifying different facilities for log messages generated on different devices can allow messages from multiple devices sent to a common server to be distinguished from each other.

Ordinarily, the facility values generated in log messages have meanings as shown in the following table. Using this command will override these meanings, and the new meanings will depend on the use you put them to.

Table 9-1: Ordinary meanings of the facility parameter in log messages

Facility	Description
kern	Kernel messages
user	User-level messages
mail	Mail system
daemon	System daemons
auth	Security/authorization messages
syslog	Messages generated internally by the syslog daemon
lpr	Line printer subsystem
news	Network news subsystem
uucp	UNIX-to-UNIX Copy Program subsystem
cron	Clock daemon
authpriv	Security/authorization (private) messages

Table 9-1: Ordinary meanings of the facility parameter in log messages (cont.)

Facility	Description
ftp	FTP daemon
local<0..7>	The facility labels above have specific meanings, while the local facility labels are intended to be put to local use. In AlliedWare Plus, some of these local facility labels are used in log messages. In particular, local5 is assigned to log messages generated by UTM Firewall security features.

Example To specify a facility of local6, use the following commands:

```
awplus# configure terminal
awplus(config)# log facility local6
```

**Related
Commands** [show log config](#)

log host

Overview This command configures the device to send log messages to a remote syslog server via UDP port 514. The IP address of the remote server must be specified. By default no filters are defined for remote syslog servers. Filters must be defined before messages will be sent.

Use the **no** variant of this command to stop sending log messages to the remote syslog server.

Syntax `log host <ipv4-addr> [secure]`
`log host <ipv6-addr>`
`no log host <ipv4-addr>|<ipv6-addr>`

Parameter	Description
<code><ipv4-addr></code>	Specify the source IPv4 address, in dotted decimal notation (A.B.C.D).
<code><ipv6-addr></code>	Specify the source IPv6 address, in X:X::X:X notation.
<code>secure</code>	Optional value to create a secure log destination. This option is only valid for IPv4 hosts.

Mode Global Configuration

Usage Use the optional **secure** parameter to configure a secure IPv4 syslog host. For secure hosts, syslog over TLS is used to encrypt the logs. The certificate received from the remote log server must have an issuer chain that terminates with the root CA certificate for any of the trustpoints that are associated with the application.

The remote server may also request that a certificate is transmitted from the local device. In this situation the first trustpoint added to the syslog application will be transmitted to the remote server.

For detailed information about securing syslog, see the [PKI Feature Overview_and Configuration Guide](#).

Examples To configure the device to send log messages to a remote secure syslog server with IP address 10.32.16.99, use the following commands:

```
awplus# configure terminal
awplus(config)# log host 10.32.16.99 secure
```

To stop the device from sending log messages to the remote syslog server with IP address 10.32.16.99, use the following commands:

```
awplus# configure terminal
awplus(config)# no log host 10.32.16.99
```

Related Commands [default log host](#)
[log host \(filter\)](#)

log host exclude

log host source

log host time

log trustpoint

show log config

log host (filter)

Overview This command creates a filter to select messages to be sent to a remote syslog server. Selection can be based on the priority/severity of the message, the program that generated the message, the logging facility used, a substring within the message or a combination of some or all of these.

The **no** variant of this command configures the device to no longer send log messages to a remote syslog server. The IP address of the syslog server must be specified. All configuration relating to this log target will be removed.

Syntax `log host <ip-addr> [level <level>] [program <program-name>] [facility <facility>] [msgtext <text-string>]`
`no log host <ip-addr> [level <level>] [program <program-name>] [facility <facility>] [msgtext <text-string>]`

Parameter	Description
<code><ip-addr></code>	The IP address of a remote syslog server.
<code>level</code>	Filter messages by severity level.
<code><level></code>	The minimum severity of message to send. The level can be specified as one of the following numbers or level names, where 0 is the highest severity and 7 is the lowest severity:
0 emergencies	System is unusable
1 alerts	Action must be taken immediately
2 critical	Critical conditions
3 errors	Error conditions
4 warnings	Warning conditions
5 notices	Normal, but significant, conditions
6 informational	Informational messages
7 debugging	Debug-level messages
<code>program</code>	Filter messages by program. Include messages from a specified program.
<code><program-name></code>	The name of a program to log messages from, either one of the following predefined program names (not case-sensitive), or another program name (case-sensitive) that you find in the log output:
rip	Routing Information Protocol (RIP)
ripng	Routing Information Protocol - next generation (RIPng)
ospf	Open Shortest Path First (OSPF)
ospfv3	Open Shortest Path First (OSPF) version 3 (OSPFv3)
bgp	Border Gateway Protocol (BGP)
rsvp	Resource Reservation Protocol (RSVP)
pim-sm	Protocol Independent Multicast - Sparse Mode (PIM-SM)

Parameter	Description
pim-smv6	PIM-SM version 6 (PIM-SMv6)
lacp	Link Aggregation Control Protocol (LACP)
stp	Spanning Tree Protocol (STP)
rstp	Rapid Spanning Tree Protocol (RSTP)
mstp	Multiple Spanning Tree Protocol (MSTP)
imi	Integrated Management Interface (IMI)
imish	Integrated Management Interface Shell (IMISH)
facility	Filter messages by syslog facility.
<facility>	Specify one of the following syslog facilities to include messages from:
kern	Kernel messages
user	Random user-level messages
mail	Mail system
daemon	System daemons
auth	Security/authorization messages
syslog	Messages generated internally by syslogd
lpr	Line printer subsystem
news	Network news subsystem
uucp	UUCP subsystem
cron	Clock daemon
authpriv	Security/authorization messages (private)
ftp	FTP daemon
msgtext	Select messages containing a certain text string.
<text-string>	A text string to match (maximum 128 characters). This is case sensitive, and must be the last text on the command line.

Mode Global Configuration

Examples To create a filter to send all messages containing the text "Bridging initialization", to a remote syslog server with IP address 10.32.16.21, use the following commands:

```
awplus# configure terminal
awplus(config)# log host 10.32.16.21 msgtext "Bridging
initialization"
```

To create a filter to send messages with a severity level of **informational** and above to the syslog server with IP address 10.32.16.21, use the following commands:

```
awplus# configure terminal
awplus(config)# log host 10.32.16.21 level informational
```

To remove a filter that sends all messages containing the text "Bridging initialization", to a remote syslog server with IP address 10.32.16.21, use the following commands:

```
awplus# configure terminal
awplus(config)# no log host 10.32.16.21 msgtext "Bridging
initialization"
```

To remove a filter that sends messages with a severity level of **informational** and above to the syslog server with IP address 10.32.16.21, use the following commands:

```
awplusawpluls# configure terminal
awplus(config)# no log host 10.32.16.21 level informational
```

**Related
Commands**

[default log host](#)

[log host](#)

[log host exclude](#)

[log host source](#)

[log host time](#)

[show log config](#)

log host exclude

Overview Use this command to prevent specified log messages from being sent to the remote syslog server, when `log host` is enabled. You can exclude messages on the basis of:

- the priority/severity of the message
- the program that generated the message
- the logging facility used
- a sub-string within the message, or
- a combination of some or all of these.

Use the **no** variant of this command to stop excluding the specified messages.

Syntax `log host exclude [level <level>] [program <program-name>]
[facility <facility>] [msgtext <text-string>]`
`no log host exclude [level <level>] [program <program-name>]
[facility <facility>] [msgtext <text-string>]`

Parameter	Description
level	Exclude messages of the specified severity level.
<level>	The severity level to exclude. The level can be specified as one of the following numbers or level names, where 0 is the highest severity and 7 is the lowest severity:
0 emergencies	System is unusable
1 alerts	Action must be taken immediately
2 critical	Critical conditions
3 errors	Error conditions
4 warnings	Warning conditions
5 notices	Normal, but significant, conditions
6 informational	Informational messages
7 debugging	Debug-level messages
program	Exclude messages from a specified program.
<program-name>	The name of a program. Either one of the following predefined program names (not case-sensitive), or another program name (case-sensitive) that you find in the log output.
rip	Routing Information Protocol (RIP)
ripng	Routing Information Protocol - next generation (RIPng)
ospf	Open Shortest Path First (OSPF)
ospfv3	Open Shortest Path First (OSPF) version 3 (OSPFv3)
bgp	Border Gateway Protocol (BGP)

Parameter	Description
rsvp	Resource Reservation Protocol (RSVP)
pim-sm	Protocol Independent Multicast - Sparse Mode (PIM-SM)
pim-smv6	PIM-SM version 6 (PIM-SMv6)
lacp	Link Aggregation Control Protocol (LACP)
stp	Spanning Tree Protocol (STP)
rstp	Rapid Spanning Tree Protocol (RSTP)
mstp	Multiple Spanning Tree Protocol (MSTP)
imi	Integrated Management Interface (IMI)
imish	Integrated Management Interface Shell (IMISH)
facility	Exclude messages from a syslog facility.
<facility>	Specify one of the following syslog facilities to exclude messages from:
kern	Kernel messages
user	Random user-level messages
mail	Mail system
daemon	System daemons
auth	Security/authorization messages
syslog	Messages generated internally by syslogd
lpr	Line printer subsystem
news	Network news subsystem
uucp	UUCP subsystem
cron	Clock daemon
authpriv	Security/authorization messages (private)
ftp	FTP daemon
msgtext	Exclude messages containing a certain text string.
<text-string>	A text string to match (maximum 128 characters). This is case sensitive, and must be the last text on the command line.

Default No log messages are excluded

Mode Global configuration

Example To remove messages that contain the string “example of irrelevant message”, use the following commands:

```
awplus# configure terminal
awplus(config)# log host exclude msgtext example of irrelevant message
```

**Related
Commands**

- default log host
- log host
- log host (filter)
- log host source
- log host time
- show log config

log host source

Overview Use this command to specify a source interface or IP address for the device to send syslog messages from. You can specify any one of an interface name, an IPv4 address or an IPv6 address.

This is useful if the device can reach the syslog server via multiple interfaces or addresses and you want to control which interface/address the device uses.

Use the **no** variant of this command to stop specifying a source interface or address.

Syntax `log host source {<interface-name>|<ipv4-addr>|<ipv6-addr>}`
`no log host source`

Parameter	Description
<code><interface-name></code>	Specify the source interface name. You can enter a VLAN, eth interface or loopback interface.
<code><ipv4-addr></code>	Specify the source IPv4 address, in dotted decimal notation (A.B.C.D).
<code><ipv6-addr></code>	Specify the source IPv6 address, in X:X::X:X notation.

Default None (no source is configured)

Mode Global Configuration

Example To send syslog messages from 192.168.1.1, use the commands:

```
awplus# configure terminal
awplus(config)# log host source 192.168.1.1
```

Related Commands

- [default log host](#)
- [log host](#)
- [log host \(filter\)](#)
- [log host exclude](#)
- [log host time](#)
- [show log config](#)

log host time

Overview This command configures the time used in messages sent to a remote syslog server. If the syslog server is in a different time zone to your device then the time offset can be configured using either the **utc-offset** parameter option keyword or the **local-offset** parameter option keyword, where **utc-offset** is the time difference from UTC (Universal Time, Coordinated) and **local-offset** is the difference from local time.

Syntax `log host <email-address> time {local|local-offset|utc-offset {plus|minus} <0-24>}`

Parameter	Description
<email-address>	The email address to send log messages to
time	Specify the time difference between the email recipient and the device you are configuring.
local	The device is in the same time zone as the email recipient
local-offset	The device is in a different time zone to the email recipient. Use the plus or minus keywords and specify the difference (offset) from local time of the device to the email recipient in hours.
utc-offset	The device is in a different time zone to the email recipient. Use the plus or minus keywords and specify the difference (offset) from UTC time of the device to the email recipient in hours.
plus	Negative offset (difference) from the device to the syslog server.
minus	Positive offset (difference) from the device to the syslog server.
<0-24>	World Time zone offset in hours

Default The default is **local** time.

Mode Global Configuration

Usage Use the **local** option if the remote syslog server is in the same time zone as the device. Messages will display the time as on the local device when the message was generated.

Use the **offset** option if the email recipient is in a different time zone to this device. Specify the time offset of the remote syslog server in hours. Messages will display the time they were generated on this device but converted to the time zone of the remote syslog server.

Examples To send messages to the remote syslog server with the IP address 10.32.16.21 in the same time zone as the device's local time zone, use the following commands:

```
awplus# configure terminal
awplus(config)# log host 10.32.16.21 time local 0
```

To send messages to the remote syslog server with the IP address 10.32.16.12 with the time information converted to the time zone of the remote syslog server, which is 3 hours ahead of the device's local time zone, use the following commands:

```
awplus# configure terminal
awplus(config)# log host 10.32.16.12 time local-offset plus 3
```

To send messages to the remote syslog server with the IP address 10.32.16.02 with the time information converted to the time zone of the email recipient, which is 3 hours behind the device's UTC time zone, use the following commands:

```
awplus# configure terminal
awplus(config)# log host 10.32.16.02 time utc-offset minus 3
```

**Related
Commands**

[default log host](#)

[log host](#)

[log host \(filter\)](#)

[log host exclude](#)

[log host source](#)

[show log config](#)

log monitor (filter)

Overview This command creates a filter to select messages to be sent to the terminal when the **terminal monitor** command is given. Selection can be based on the priority/severity of the message, the program that generated the message, the logging facility used, a sub-string within the message or a combination of some or all of these.

Syntax `log monitor [level <level>] [program <program-name>] [facility <facility>] [msgtext <text-string>]`
`no log monitor [level <level>] [program <program-name>]`
`[facility <facility>] [msgtext <text-string>]`

Parameter	Description
level	Filter messages by severity level.
<level>	The minimum severity of message to send. The level can be specified as one of the following numbers or level names, where 0 is the highest severity and 7 is the lowest severity:
0 emergencies	System is unusable
1 alerts	Action must be taken immediately
2 critical	Critical conditions
3 errors	Error conditions
4 warnings	Warning conditions
5 notices	Normal, but significant, conditions
6 informational	Informational messages
7 debugging	Debug-level messages
program	Filter messages by program. Include messages from a specified program.
<program-name>	The name of a program to log messages from, either one of the following predefined program names (not case-sensitive), or another program name (case-sensitive) that you find in the log output:
rip	Routing Information Protocol (RIP)
ripng	Routing Information Protocol - next generation (RIPng)
ospf	Open Shortest Path First (OSPF)
ospfv3	Open Shortest Path First (OSPF) version 3 (OSPFv3)
bgp	Border Gateway Protocol (BGP)
rsvp	Resource Reservation Protocol (RSVP)
pim-sm	Protocol Independent Multicast - Sparse Mode (PIM-SM)
pim-smv6	PIM-SM version 6 (PIM-SMv6)
lacp	Link Aggregation Control Protocol (LACP)

Parameter	Description
	stp Spanning Tree Protocol (STP)
	rstp Rapid Spanning Tree Protocol (RSTP)
	mstp Multiple Spanning Tree Protocol (MSTP)
	imi Integrated Management Interface (IMI)
	imish Integrated Management Interface Shell (IMISH)
facility	Filter messages by syslog facility.
<facility>	Specify one of the following syslog facilities to include messages from:
	kern Kernel messages
	user Random user-level messages
	mail Mail system
	daemon System daemons
	auth Security/authorization messages
	syslog Messages generated internally by syslogd
	lpr Line printer subsystem
	news Network news subsystem
	uucp UUCP subsystem
	cron Clock daemon
	authpriv Security/authorization messages (private)
	ftp FTP daemon
msgtext	Select messages containing a certain text string.
<text-string>	A text string to match (maximum 128 characters). This is case sensitive, and must be the last text on the command line.

Default By default there is a filter to select all messages. This filter may be removed and replaced by filters that are more selective.

Mode Global Configuration

Examples To create a filter to send all messages that are generated by authentication and have a severity of **info** or higher to terminal instances where the terminal monitor command has been given, use the following commands:

```
awplus# configure terminal
awplus(config)# log monitor level info program auth
```

To remove a default filter that includes sending everything to the terminal, use the following commands:

```
awplus# configure terminal
awplus(config)# no log monitor level debugging
```

**Related
Commands**

- default log monitor
- log monitor exclude
- show log config
- terminal monitor

log monitor exclude

Overview Use this command to prevent specified log messages from being displayed on a terminal, when **terminal monitor** is enabled. You can exclude messages on the basis of:

- the priority/severity of the message
- the program that generated the message
- the logging facility used
- a sub-string within the message, or
- a combination of some or all of these.

Use the **no** variant of this command to stop excluding the specified messages.

Syntax `log console exclude [level <level>] [program <program-name>]
[facility <facility>] [msgtext <text-string>]`
`no log console exclude [level <level>] [program <program-name>]
[facility <facility>] [msgtext <text-string>]`

Parameter	Description
level	Exclude messages of the specified severity level.
<level>	The severity level to exclude. The level can be specified as one of the following numbers or level names, where 0 is the highest severity and 7 is the lowest severity:
0 emergencies	System is unusable
1 alerts	Action must be taken immediately
2 critical	Critical conditions
3 errors	Error conditions
4 warnings	Warning conditions
5 notices	Normal, but significant, conditions
6 informational	Informational messages
7 debugging	Debug-level messages
program	Exclude messages from a specified program.
<program-name>	The name of a program. Either one of the following predefined program names (not case-sensitive), or another program name (case-sensitive) that you find in the log output.
rip	Routing Information Protocol (RIP)
ripng	Routing Information Protocol - next generation (RIPng)
ospf	Open Shortest Path First (OSPF)
ospfv3	Open Shortest Path First (OSPF) version 3 (OSPFv3)
bgp	Border Gateway Protocol (BGP)

Parameter	Description
rsvp	Resource Reservation Protocol (RSVP)
pim-dm	Protocol Independent Multicast - Dense Mode (PIM-DM)
pim-sm	Protocol Independent Multicast - Sparse Mode (PIM-SM)
pim-smv6	PIM-SM version 6 (PIM-SMv6)
stp	Spanning Tree Protocol (STP)
rstp	Rapid Spanning Tree Protocol (RSTP)
mstp	Multiple Spanning Tree Protocol (MSTP)
imi	Integrated Management Interface (IMI)
imish	Integrated Management Interface Shell (IMISH)
facility	Exclude messages from a syslog facility.
<facility>	Specify one of the following syslog facilities to exclude messages from:
kern	Kernel messages
user	Random user-level messages
mail	Mail system
daemon	System daemons
auth	Security/authorization messages
syslog	Messages generated internally by syslogd
lpr	Line printer subsystem
news	Network news subsystem
uucp	UUCP subsystem
cron	Clock daemon
authpriv	Security/authorization messages (private)
ftp	FTP daemon
msgtext	Exclude messages containing a certain text string.
<text-string>	A text string to match (maximum 128 characters). This is case sensitive, and must be the last text on the command line.

Default No log messages are excluded

Mode Global configuration

Example To remove messages that contain the string “example of irrelevant message”, use the following commands:

```
awplus# configure terminal
awplus(config)# log monitor exclude msgtext example of
irrelevant message
```

**Related
Commands**

- default log monitor
- log monitor (filter)
- show log config
- terminal monitor

log permanent

Overview This command configures the device to send permanent log messages to non-volatile storage (NVS) on the device. The content of the permanent log is retained over a reboot. Once the permanent log reaches its configured maximum allowable size old messages will be deleted to make way for new messages.

The **no** variant of this command configures the device not to send any messages to the permanent log. Log messages will not be retained over a restart.

Syntax `log permanent`
`no log permanent`

Mode Global Configuration

Examples To enable permanent logging use the following commands:

```
awplus# configure terminal
awplus(config)# log permanent
```

To disable permanent logging use the following commands:

```
awplus# configure terminal
awplus(config)# no log permanent
```

Related Commands

- `clear log permanent`
- `copy permanent-log`
- `default log permanent`
- `log permanent (filter)`
- `log permanent exclude`
- `log permanent size`
- `show log config`
- `show log permanent`

log permanent (filter)

Overview This command creates a filter to select messages to be sent to the permanent log. Selection can be based on the priority/ severity of the message, the program that generated the message, the logging facility used, a sub-string within the message or a combination of some or all of these.

The **no** variant of this command removes the corresponding filter, so that the specified messages are no longer sent to the permanent log.

Syntax `log permanent [level <level>] [program <program-name>]
[facility <facility>] [msgtext <text-string>]`
`no log permanent [level <level>] [program <program-name>]
[facility <facility>] [msgtext <text-string>]`

Parameter	Description
level	Filter messages sent to the permanent log by severity level.
<level>	The minimum severity of message to send. The level can be specified as one of the following numbers or level names, where 0 is the highest severity and 7 is the lowest severity:
0 emergencies	System is unusable
1 alerts	Action must be taken immediately
2 critical	Critical conditions
3 errors	Error conditions
4 warnings	Warning conditions
5 notices	Normal, but significant, conditions
6 informational	Informational messages
7 debugging	Debug-level messages
program	Filter messages by program. Include messages from a specified program.
<program-name>	The name of a program to log messages from, either one of the following predefined program names (not case-sensitive), or another program name (case-sensitive) that you find in the log output:
rip	Routing Information Protocol (RIP)
ripng	Routing Information Protocol - next generation (RIPng)
ospf	Open Shortest Path First (OSPF)
ospfv3	Open Shortest Path First (OSPF) version 3 (OSPFv3)
bgp	Border Gateway Protocol (BGP)
rsvp	Resource Reservation Protocol (RSVP)
pim-sm	Protocol Independent Multicast - Sparse Mode (PIM-SM)
pim-smv6	PIM-SM version 6 (PIM-SMv6)

Parameter	Description
	lacp Link Aggregation Control Protocol (LACP)
	stp Spanning Tree Protocol (STP)
	rstp Rapid Spanning Tree Protocol (RSTP)
	mstp Multiple Spanning Tree Protocol (MSTP)
	imi Integrated Management Interface (IMI)
	imish Integrated Management Interface Shell (IMISH)
facility	Filter messages by syslog facility.
<facility>	Specify one of the following syslog facilities to include messages from:
	kern Kernel messages
	user Random user-level messages
	mail Mail system
	daemon System daemons
	auth Security/authorization messages
	syslog Messages generated internally by syslogd
	lpr Line printer subsystem
	news Network news subsystem
	uucp UUCP subsystem
	cron Clock daemon
	authpriv Security/authorization messages (private)
	ftp FTP daemon
msgtext	Select messages containing a certain text string.
<text-string>	A text string to match (maximum 128 characters). This is case sensitive, and must be the last text on the command line.

Default By default the buffered log has a filter to select messages whose severity level is `notices` (5) or higher. This filter may be removed using the **no** variant of this command.

Mode Global Configuration

Examples To create a filter to send all messages containing the text "Bridging initialization", to the permanent log use the following commands:

```
awplus# configure terminal
awplus(config)# log permanent msgtext Bridging initialization
```

Related Commands

- [clear log permanent](#)
- [default log permanent](#)
- [log permanent](#)

log permanent exclude

log permanent size

show log config

show log permanent

log permanent exclude

Overview Use this command to prevent specified log messages from being sent to the permanent log. You can exclude messages on the basis of:

- the priority/severity of the message
- the program that generated the message
- the logging facility used
- a sub-string within the message, or
- a combination of some or all of these.

Use the **no** variant of this command to stop excluding the specified messages.

Syntax `log permanent exclude [level <level>] [program <program-name>] [facility <facility>] [msgtext <text-string>]`
`no log permanent exclude [level <level>] [program <program-name>] [facility <facility>] [msgtext <text-string>]`

Parameter	Description
level	Exclude messages of the specified severity level.
<level>	The severity level to exclude. The level can be specified as one of the following numbers or level names, where 0 is the highest severity and 7 is the lowest severity:
0 emergencies	System is unusable
1 alerts	Action must be taken immediately
2 critical	Critical conditions
3 errors	Error conditions
4 warnings	Warning conditions
5 notices	Normal, but significant, conditions
6 informational	Informational messages
7 debugging	Debug-level messages
program	Exclude messages from a specified program.
<program-name>	The name of a program. Either one of the following predefined program names (not case-sensitive), or another program name (case-sensitive) that you find in the log output.
rip	Routing Information Protocol (RIP)
ripng	Routing Information Protocol - next generation (RIPng)
ospf	Open Shortest Path First (OSPF)
ospfv3	Open Shortest Path First (OSPF) version 3 (OSPFv3)
bgp	Border Gateway Protocol (BGP)
rsvp	Resource Reservation Protocol (RSVP)

Parameter	Description
pim-sm	Protocol Independent Multicast - Sparse Mode (PIM-SM)
pim-smv6	PIM-SM version 6 (PIM-SMv6)
lacp	Link Aggregation Control Protocol (LACP)
stp	Spanning Tree Protocol (STP)
rstp	Rapid Spanning Tree Protocol (RSTP)
mstp	Multiple Spanning Tree Protocol (MSTP)
imi	Integrated Management Interface (IMI)
imish	Integrated Management Interface Shell (IMISH)
facility	Exclude messages from a syslog facility.
<facility>	Specify one of the following syslog facilities to exclude messages from:
kern	Kernel messages
user	Random user-level messages
mail	Mail system
daemon	System daemons
auth	Security/authorization messages
syslog	Messages generated internally by syslogd
lpr	Line printer subsystem
news	Network news subsystem
uucp	UUCP subsystem
cron	Clock daemon
authpriv	Security/authorization messages (private)
ftp	FTP daemon
msgtext	Exclude messages containing a certain text string.
<text-string>	A text string to match (maximum 128 characters). This is case sensitive, and must be the last text on the command line.

Default No log messages are excluded

Mode Global configuration

Example To remove messages that contain the string "example of irrelevant message", use the following commands:

```
awplus# configure terminal
awplus(config)# log permanent exclude msgtext example of
irrelevant message
```

Related Commands [clear log permanent](#)

default log permanent
log permanent
log permanent (filter)
log permanent size
show log config
show log permanent

log permanent size

Overview This command configures the amount of memory that the permanent log is permitted to use. Once this memory allocation has been filled old messages will be deleted to make room for new messages.

Syntax `log permanent size <50-250>`

Parameter	Description
<code><50-250></code>	Size of the permanent log in kilobytes

Mode Global Configuration

Example To allow the permanent log to use up to 100 kB of NVS use the following commands:

```
awplus# configure terminal
awplus(config)# log permanent size 100
```

Related Commands

- [clear log permanent](#)
- [copy permanent-log](#)
- [default log permanent](#)
- [log permanent](#)
- [log permanent \(filter\)](#)
- [log permanent exclude](#)
- [show log config](#)
- [show log permanent](#)

log-rate-limit nsm

Overview This command limits the number of log messages generated by the device for a given interval.

Use the **no** variant of this command to revert to the default number of log messages generated by the device of up to 200 log messages per second.

Syntax `log-rate-limit nsm messages <message-limit> interval <time-interval>`
`no log-rate-limit nsm`

Parameter	Description
<code><message-limit></code>	<code><1-65535></code> The number of log messages generated by the device.
<code><time-interval></code>	<code><0-65535></code> The time period for log message generation in 1/100 seconds. If an interval of 0 is specified then no log message rate limiting is applied.

Default By default, the device will allow 200 log messages to be generated per second.

Mode Global Configuration

Usage Previously, if the device received a continuous stream of IGMP packets with errors, such as when a packet storm occurs because of a network loop, then the device generates a lot of log messages using more and more memory, which may ultimately cause the device to shutdown. This log rate limiting feature constrains the rate that log messages are generated by the device.

Note that if within the given time interval, the number of log messages exceeds the limit, then any excess log messages are discarded. At the end of the time interval, a single log message is generated indicating that log messages were discarded due to the log rate limit being exceeded.

Thus if the expectation is that there will be a lot of discarded log messages due to log rate limiting, then it is advisable to set the time interval to no less than 100, which means that there would only be one log message, indicating log excessive log messages have been discarded.

Examples To limit the device to generate up to 300 log messages per second, use the following commands:

```
awplus# configure terminal
awplus(config)# log-rate-limit nsm messages 300 interval 100
```

To return the device the default setting, to generate up to 200 log messages per second, use the following commands:

```
awplus# configure terminal  
awplus(config)# no log-rate-limit nsm
```

log trustpoint

Overview This command adds one or more trustpoints to be used with the syslog application. Multiple trustpoints may be specified, or the command may be executed multiple times, to add multiple trustpoints to the application.

The **no** version of this command removes one or more trustpoints from the list of trustpoints associated with the application.

Syntax `log trustpoint [<trustpoint-list>]`
`no log trustpoint [<trustpoint-list>]`

Parameter	Description
<trustpoint-list>	Specify one or more trustpoints to be added or deleted.

Default No trustpoints are created by default.

Mode Global Configuration

Usage The device certificate associated with first trustpoint added to the application will be transmitted to remote servers. The certificate received from the remote server must have an issuer chain that terminates with the root CA certificate for any of the trustpoints that are associated with the application.

If no trustpoints are specified in the command, the trustpoint list will be unchanged.

If **no log trustpoint** is issued without specifying any trustpoints, then all trustpoints will be disassociated from the application.

Example You can add multiple trustpoints by executing the command multiple times:

```
awplus# configure terminal
awplus(config)# log trustpoint trustpoint_1
awplus(config)# log trustpoint trustpoint_2
```

Alternatively, add multiple trustpoints with a single command:

```
awplus(config)# log trustpoint trustpoint_2 trustpoint_3
```

Disassociate all trustpoints from the syslog application using the command:

```
awplus(config)# no log trustpoint trustpoint_2 trustpoint_3
```

Related Commands [log host](#)
[show log config](#)

log url-requests

Overview If URL Filtering is enabled, then by default, black list hits and issues with match criteria and list files are logged.

Use this command to enable logging of all HTTP and HTTPS URL requests (both permitted and denied) passing through the firewall.

Use the **no** variant of this command to disable extra logging of HTTP and HTTPS URL requests passing through the firewall.

Syntax `log url-requests`
`no log url-requests`

Default Disabled by default.

Mode URL Filter Configuration

Usage When enabled, additional log messages for HTTP and HTTPS URL requests passing through the firewall contain the:

- URL being accessed
- IP address of the user that requested the URL

Example To configure logging of all HTTP and HTTPS URL requests passing through the firewall (permitted as well as denied), use the following commands:

```
awplus# configure terminal
awplus(config)# url-filter
awplus(config-url-filter)# log url-requests
```

**Related
Commands** [url-filter](#)

**Command
changes** Version 5.4.7-1.1: command added

show connection-log events

Overview This command displays the configuration state (enabled or disabled) for the logging of connections passing through the firewall, as configured by the [connection-log events](#) command.

Syntax `show connection-log events`

Mode User Exec

Example To show the logging configuration state for the connections passing through the firewall, use the command:

```
awplus# show connection-log events
```

Output Figure 9-1: Example output from **show connection-log events**

```
awplus#show connection-log events
Log new connection events:      Disabled
Log connection end events:     Enabled
```

Related Commands [connection-log events](#)

Command changes Version 5.4.7-1.1: command added.

show counter log

Overview This command displays log counter information.

Syntax show counter log

Mode User Exec and Privileged Exec

Example To display the log counter information, use the command:

```
awplus# show counter log
```

Output Figure 9-2: Example output from the **show counter log** command

```
Log counters
Total Received          ..... 2328
Total Received P0      ..... 0
Total Received P1      ..... 0
Total Received P2      ..... 1
Total Received P3      ..... 9
Total Received P4      ..... 32
Total Received P5      ..... 312
Total Received P6      ..... 1602
Total Received P7      ..... 372
```

Table 10: Parameters in output of the **show counter log** command

Parameter	Description
Total Received	Total number of messages received by the log
Total Received P0	Total number of Priority 0 (Emergency) messages received
Total Received P1	Total number of Priority 1 (Alert) messages received
Total Received P2	Total number of Priority 2 (Critical) messages received
Total Received P3	Total number of Priority 3 (Error) messages received
Total Received P4	Total number of Priority 4 (Warning) messages received
Total Received P5	Total number of Priority 5 (Notice) messages received
Total Received P6	Total number of Priority 6 (Info) messages received
Total Received P7	Total number of Priority 7 (Debug) messages received

Related Commands [show log config](#)

show exception log

Overview This command displays the contents of the exception log.

Syntax show exception log

Mode User Exec and Privileged Exec

Example To display the exception log, use the command:

```
awplus# show exception log
```

Output Figure 9-3: Example output from the **show exception log** command on a device

```
awplus#show exception log
<date> <time> <facility>.<severity> <program[<pid>]>: <message>
-----
2017 Jul 19 05:14:16 local7.debug awplus corehandler : Process hsl (PID:745) sig
nal 11, core dumped to /flash/hsl-IE200-test_2017_07-20170718-1-2-1500441256-1
227.tgz
-----
```

show log

Overview This command displays the contents of the buffered log.
For information on filtering and saving command output, see the [“Getting Started with AlliedWare_Plus” Feature Overview and Configuration Guide](#).

Syntax `show log [tail [<10-250>]]`

Parameter	Description
tail	Display only the latest log entries.
<10-250>	Specify the number of log entries to display.

Default By default the entire contents of the buffered log is displayed.

Mode User Exec, Privileged Exec and Global Configuration

Usage If the optional **tail** parameter is specified, only the latest 10 messages in the buffered log are displayed. A numerical value can be specified after the **tail** parameter to select how many of the latest messages should be displayed.

The **show log** command is only available to users at privilege level 7 and above. To set a user’s privilege level, use the command:

```
awplus(config)# username <name> privilege <1-15>
```

Examples To display the contents of the buffered log use the command:

```
awplus# show log
```

To display the 10 latest entries in the buffered log use the command:

```
awplus# show log tail 10
```

Output Figure 9-4: Example output from **show log**

```
awplus#show log

<date> <time> <facility>.<severity> <program[<pid>]>: <message>

-----
2011 Aug 29 07:55:22 kern.notice awplus kernel: Linux version 2.6.32.12-at1 (mak
er@awpmaker03-dl) (gcc version 4.3.3 (Gentoo 4.3.3-r3 p1.2, pie-10.1.5) ) #1 Wed
Dec 8 11:53:40 NZDT 2010
2011 Aug 29 07:55:22 kern.warning awplus kernel: No pci config register base in
dev tree, using default
2011 Aug 29 07:55:23 kern.notice awplus kernel: Kernel command line: console=tty
S0,9600 releasefile=AR4050S-5.4.7-1.1.rel ramdisk=14688 bootversion=1.1.0-rc12
loglevel=1 extraflash=00000000
2011 Aug 29 07:55:25 kern.notice awplus kernel: RAMDISK: squashfs filesystem fou
nd at block 0
2011 Aug 29 07:55:28 kern.warning awplus kernel: ipifwd: module license 'Proprie
tary' taints kernel.
...
```

- Related Commands**
- [clear log buffered](#)
 - [copy buffered-log](#)
 - [default log buffered](#)
 - [log buffered](#)
 - [log buffered \(filter\)](#)
 - [log buffered size](#)
 - [log buffered exclude](#)
 - [show log config](#)

show log config

Overview This command displays information about the logging system. This includes the configuration of the various log destinations, such as buffered, permanent, syslog servers (hosts) and email addresses. This also displays the latest status information for each log destination.

Syntax `show log config`

Mode User Exec, Privileged Exec and Global Configuration

Example To display the logging configuration use the command:

```
awplus# show log config
```

Output Figure 9-5: Example output from **show log config**

```
Facility: default
PKI trustpoints: example_trustpoint

Buffered log:
Status ..... enabled
Maximum size ... 100kb
Filters:
*1 Level ..... notices
  Program ..... any
  Facility ..... any
  Message text . any
  2 Level ..... informational
  Program ..... auth
  Facility ..... daemon
  Message text . any
  Statistics .... 1327 messages received, 821 accepted by filter (2016 Oct 11
10:36:16)
Permanent log:
Status ..... enabled
Maximum size ... 60kb
Filters:
  1 Level ..... error
  Program ..... any
  Facility ..... any
  Message text . any
*2 Level ..... warnings
  Program ..... dhcp
  Facility ..... any
  Message text . "pool exhausted"
  Statistics .... 1327 messages received, 12 accepted by filter (2016 Oct 11
10:36:16)
```

```
Host 10.32.16.21:
  Time offset .... +2:00
  Offset type .... UTC
  Source ..... -
  Secured ..... enabled
  Filters:
  1 Level ..... critical
    Program ..... any
    Facility ..... any
    Message text . any
  Statistics ..... 1327 messages received, 1 accepted by filter (2016 Oct 11
10:36:16)
Email admin@alliedtelesis.com:
  Time offset .... +0:00
  Offset type .... Local
  Filters:
  1 Level ..... emergencies
    Program ..... any
    Facility ..... any
    Message text . any
  Statistics ..... 1327 messages received, 0 accepted by filter (2016 Oct 11
10:36:16)
...
```

In the above example the '*' next to filter 1 in the buffered log configuration indicates that this is the default filter. The permanent log has had its default filter removed, so none of the filters are marked with '*'.

NOTE: Terminal log and console log cannot be set at the same time. If console logging is enabled then the terminal logging is turned off.

**Related
Commands**

- [show counter log](#)
- [show log](#)
- [show log permanent](#)

show log external

Overview Use this command to display the contents of the external log, which is stored on an SD card or USB storage device.

Syntax `show log external [tail [<10-250>]]`

Parameter	Description
tail	Display only the latest log entries.
<10-250>	Specify the number of log entries to display.

Mode Global Configuration

Privileged Exec

User Exec

Usage If the optional **tail** parameter is specified, only the latest 10 messages in the permanent log are displayed. A numerical value can be specified after the **tail** parameter to change how many of the latest messages should be displayed.

Example To display the last 5 entries in the external log, use the command:

```
awplus# show log external tail 5
```

Related Commands

- [clear log external](#)
- [default log external](#)
- [log external](#)
- [log external \(filter\)](#)
- [log external exclude](#)
- [log external rotate](#)
- [log external size](#)
- [show log config](#)
- [unmount](#)

Command changes Version 5.4.7-1.1: command added

show log permanent

Overview This command displays the contents of the permanent log.

Syntax show log permanent [tail [<10-250>]]

Parameter	Description
tail	Display only the latest log entries.
<10-250>	Specify the number of log entries to display.

Usage If the optional **tail** parameter is specified only, the latest 10 messages in the permanent log are displayed. A numerical value can be specified after the **tail** parameter to change how many of the latest messages should be displayed.

Mode User Exec, Privileged Exec and Global Configuration

Example To display the permanent log, use the command:

```
awplus# show log permanent
```

Output Figure 9-6: Example output from **show log permanent**

```
awplus#show log permanent

<date> <time> <facility>.<severity> <program[<pid>]: <message>
-----
2014 Jun 10 09:30:09 syslog.notice syslog-ng[67]: syslog-ng starting up;
version='\`2.0rc3\`'
2014 Jun 10 09:30:09 auth.warning portmap[106]: user rpc not found, reverting to
user bin
2014 Jun 10 09:30:09 cron.notice crond[116]: crond 2.3.2 dillon, started, log
level 8
2014 Jun 10 09:30:14 daemon.err snmpd[181]: /flash/.configs/snmpd.conf: line 20:
Error: bad SUBTREE object
2014 Jun 10 09:30:14 user.info HSL[192]: HSL: INFO: Registering port port1.0.1
```

- Related Commands**
- [clear log permanent](#)
 - [copy permanent-log](#)
 - [default log permanent](#)
 - [log permanent](#)
 - [log permanent \(filter\)](#)
 - [log permanent exclude](#)
 - [log permanent size](#)
 - [show log config](#)

show running-config log

Overview This command displays the current running configuration of the Log utility.

Syntax `show running-config log`

Mode Privileged Exec and Global Configuration

Example To display the current configuration of the log utility, use the command:

```
awplus# show running-config log
```

**Related
Commands** [show log](#)
[show log config](#)

unmount

Overview Use this command to unmount an external storage device. We recommend you unmount storage devices before removing them, to avoid file corruption. This is especially important if files may be automatically written to the storage device, such as external log files or AMF backup files.

Syntax `unmount card`
`unmount usb`

Parameter	Description
card	Unmount the SD card.
usb	Unmount the USB storage device.

Mode Privileged Exec

Example To unmount a USB storage device and safely remove it from the device, use the command:

```
awplus# unmount usb
```

Related Commands [clear log external](#)
[log external](#)
[show file systems](#)
[show log config](#)
[show log external](#)

Command changes Version 5.4.7-1.1: command added

10

Scripting Commands

Introduction

Overview This chapter provides commands used for command scripts.

- Command List**
- [“activate”](#) on page 398
 - [“echo”](#) on page 399
 - [“wait”](#) on page 400

activate

Overview This command activates a script file.

Syntax activate [background] <script>

Parameter	Description
background	Activate a script to run in the background. A process that is running in the background will operate as a separate task, and will not interrupt foreground processing. Generally, we recommend running short, interactive scripts in the foreground and longer scripts in the background. The default is to run the script in the foreground.
<script>	The file name of the script to activate. The script is a command script consisting of commands documented in this software reference. Note that you must use either a .scp or a .sh filename extension for a valid script text file, as described below in the usage section for this command.

Mode Privileged Exec

Usage When a script is activated, the privilege level is set to 1 enabling User Exec commands to run in the script. If you need to run Privileged Exec commands in your script you need to add an [enable \(Privileged Exec mode\)](#) command to the start of your script. If you need to run Global Configuration commands in your script you need to add a [configure terminal](#) command after the **enable** command at the start of your script.

The **activate** command executes the script in a new shell. A [terminal length](#) shell command, such as **terminal length 0** may also be required to disable a delay that would pause the display.

A script must be a text file with a filename extension of either **.sh** or **.scp** only for the AlliedWare Plus™ CLI to activate the script file. The **.sh** filename extension indicates the file is an ASH script, and the **.scp** filename extension indicates the file is an AlliedWare Plus™ script.

Examples To activate a command script to run as a background process, use the command:

```
awplus# activate background test.scp
```

Related Commands

- [configure terminal](#)
- [echo](#)
- [enable \(Privileged Exec mode\)](#)
- [wait](#)

echo

Overview This command echoes a string to the terminal, followed by a blank line.

Syntax `echo <line>`

Parameter	Description
<code><line></code>	The string to echo

Mode User Exec and Privileged Exec

Usage This command may be useful in CLI scripts, to make the script print user-visible comments.

Example To echo the string `Hello World` to the console, use the command:

```
awplus# echo Hello World
```

Output

```
Hello World
```

**Related
Commands** [activate](#)
[wait](#)

wait

Overview This command pauses execution of the active script for the specified period of time.

Syntax `wait <delay>`

Parameter	Description
<code><delay></code>	<code><1-65335></code> Specify the time delay in seconds

Default No wait delay is specified by default to pause script execution.

Mode Privileged Exec (when executed from a script not directly from the command line)

Usage Use this command to pause script execution in an **.scp** (AlliedWare Plus™ script) or an **.sh** (ASH script) file executed by the [activate](#) command. The script must contain an **enable** command, because the **wait** command is only executed in the Privileged Exec mode.

Example See an **.scp** script file extract below that will show port counters for interface port1.0.1 over a 10 second interval:

```
enable

show interface port1.0.1

wait 10

show interface port1.0.1
```

Related Commands

- [activate](#)
- [echo](#)
- [enable \(Privileged Exec mode\)](#)

11

Interface Commands

Introduction

Overview This chapter provides an alphabetical reference of commands used to configure and display interfaces.

- Command List**
- “[description \(interface\)](#)” on page 402
 - “[interface \(to configure\)](#)” on page 403
 - “[ip tcp adjust-mss](#)” on page 405
 - “[ipv6 tcp adjust-mss](#)” on page 407
 - “[mru jumbo](#)” on page 409
 - “[mtu](#)” on page 410
 - “[show interface](#)” on page 412
 - “[show interface brief](#)” on page 416
 - “[show interface memory](#)” on page 417
 - “[show interface status](#)” on page 419
 - “[shutdown](#)” on page 421

description (interface)

Overview Use this command to add a description to a specific port or interface.

Syntax `description <description>`

Parameter	Description
<code><description></code>	Text describing the specific interface. Descriptions can contain any printable ASCII characters (ASCII 32-126).

Mode Interface Configuration

Example The following example uses this command to describe the device that a switch port is connected to.

```
awplus# configure terminal
awplus(config)# interface port1.0.2
awplus(config-if)# description Boardroom PC
```

Command changes Version 5.4.7-1.1: valid character set changed to printable ASCII characters

interface (to configure)

Overview Use this command to select one or more interfaces to configure.

Syntax `interface <interface-list>`
`interface lo`

Parameter	Description
<code><interface-list></code>	<p>The interfaces or ports to configure.</p> <p>An interface-list can be:</p> <ul style="list-style-type: none">• an interface such as a VLAN (e.g. <code>vlan1</code>), a switch port (e.g. <code>port1.0.1</code>), a static channel group (e.g. <code>sa3</code>), a dynamic (LACP) channel group (e.g. <code>po4</code>), a PPP interface (e.g. <code>ppp0</code>), an Ethernet interface, (e.g. <code>eth1</code>), a tunnel interface (e.g. <code>tunnel0</code>) or a bridge interface (e.g. <code>br2</code>).• a continuous range of interfaces, ports, static channel groups or dynamic (LACP) channel groups separated by a hyphen; e.g. <code>vlan2-8</code>, or <code>port1.0.1-1.0.6</code>, or <code>sa1-2</code>, or <code>po1-2</code>• a comma-separated list of the above; e.g. <code>port1.0.1, port1.0.4-1.0.6</code>. Do not mix interface types in a list <p>The specified interfaces must exist.</p>
<code>lo</code>	The local loopback interface.

Usage A local loopback interface is one that is always available for higher layer protocols to use and advertise to the network. Although a local loopback interface is assigned an IP address, it does not have the usual requirement of connecting to a lower layer physical entity. This lack of physical attachment creates the perception of a local loopback interface always being accessible via the network.

Local loopback interfaces can be utilized by a number of protocols for various purposes. They can be used to improve access to the device and also increase its reliability, security, scalability and protection. In addition, local loopback interfaces can add flexibility and simplify management, information gathering and filtering.

One example of this increased reliability is for OSPF to advertise a local loopback interface as an interface-route into the network irrespective of the physical links that may be “up” or “down” at the time. This provides a higher probability that the routing traffic will be received and subsequently forwarded.

Mode Global Configuration

Example The following example shows how to enter Interface mode to configure `vlan1`. Note how the prompt changes.

```
awplus# configure terminal
awplus(config)# interface vlan1
awplus(config-if)#
```

The following example shows how to enter Interface mode to configure PPP interface, `PPP0`.

```
awplus# configure terminal
awplus(config)# interface ppp0
awplus(config-if)#
```

The following example shows how to enter Interface mode to configure the local loopback interface.

```
awplus# configure terminal
awplus(config)# interface lo
awplus(config-if)#
```

The following example shows how to enter interface mode to configure bridge `br2`.

```
awplus# configure terminal
awplus(config)# interface br2
awplus(config-if)#
```

Related Commands

- [ip address \(IP Addressing and Protocol\)](#)
- [show interface](#)
- [show interface brief](#)

ip tcp adjust-mss

Overview Use this command to set the Maximum Segment Size (MSS) size for an interface, where MSS is the maximum TCP data packet size that the interface can transmit before fragmentation.

Use the **no** variant of this command to remove a previously specified MSS size for a PPP interface, and restore the default MSS size.

Syntax `ip tcp adjust-mss {<mss-size>|pmtu}`
`no ip tcp adjust-mss`

Parameter	Description
<mss-size>	<64-1460> Specifies the MSS size in bytes.
pmtu	Adjust TCP MSS automatically with respect to the MTU on the interface.

Default The default setting allows a TCP server or a TCP client to set the MSS value for itself.

Mode Interface Configuration

Usage When a host initiates a TCP session with a server it negotiates the IP segment size by using the MSS option field in the TCP packet. The value of the MSS option field is determined by the Maximum Transmission Unit (MTU) configuration on the host.

You can set a feasible MSS value on the following interfaces:

- PPPoE
- Ethernet
- VTI Tunnels (IPsec, GRE, IPv6, L2TP, OpenVPN)
- VLAN

Examples To configure an MSS size of 1452 bytes on PPP interface ppp0, use the commands:

```
awplus# configure terminal
awplus(config)# interface ppp0
awplus(config-if)# ip tcp adjust-mss 1452
```

To configure an MSS size of 1452 bytes on Ethernet interface eth1, use the commands:

```
awplus# configure terminal
awplus(config)# interface eth1
awplus(config-if)# ip tcp adjust-mss 1452
```

To restore the MSS size to the default size on PPP interface `ppp0`, use the commands:

```
awplus# configure terminal
awplus(config)# interface ppp0
awplus(config-if)# no ip tcp adjust-mss
```

**Related
Commands**

[mtu \(PPP\)](#)
[show interface](#)
[show interface \(PPP\)](#)
[show interface tunnel \(GRE\)](#)

ipv6 tcp adjust-mss

Overview Use this command to set the IPv6 Maximum Segment Size (MSS) size for an interface, where MSS is the maximum TCP data packet size that the interface can transmit before fragmentation.

Use the **no** variant of this command to remove a previously specified MSS size for a PPP interface, and restore the default MSS size.

Syntax `ip tcp adjust-mss {<mss-size>|pmtu}`
`no ip tcp adjust-mss`

Parameter	Description
<code><mss-size></code>	<code><64-1460></code> Specifies the MSS size in bytes.
<code>pmtu</code>	Adjust TCP MSS automatically with respect to the MTU on the interface.

Default The default setting allows a TCP server or a TCP client to set the MSS value for itself.

Mode Interface Configuration

Usage When a host initiates a TCP session with a server it negotiates the IP segment size by using the MSS option field in the TCP packet. The value of the MSS option field is determined by the Maximum Transmission Unit (MTU) configuration on the host.

You can set a feasible MSS value on the following interfaces:

- PPPoE
- Ethernet
- VTI Tunnels (IPSec, GRE, IPv6, L2TP, OpenVPN)
- VLAN

Examples To configure an IPv6 MSS size of 1452 bytes on PPP interface ppp0, use the commands:

```
awplus# configure terminal
awplus(config)# interface ppp0
awplus(config-if)# ipv6 tcp adjust-mss 1452
```

To configure an IPv6 MSS size of 1452 bytes on Ethernet interface eth1, use the commands:

```
awplus# configure terminal
awplus(config)# interface eth1
awplus(config-if)# ip tcp adjust-mss 1452
```

To restore the MSS size to the default size on PPP interface `ppp0`, use the commands:

```
awplus# configure terminal
awplus(config)# interface ppp0
awplus(config-if)# no ip tcp adjust-mss
```

**Related
Commands**

[mtu \(PPP\)](#)
[show interface](#)
[show interface \(PPP\)](#)
[show interface tunnel \(GRE\)](#)

mru jumbo

Overview Use this command to enable the device to forward jumbo frames. For more information, see the [Switching Feature Overview and Configuration Guide](#).

When jumbo frame support is enabled, the maximum size of packets that the device can forward is 9710 bytes of payload.

Use the no variant of this command to remove jumbo frame support, and restore the default MRU size (1500 bytes) for switch ports.

NOTE:

The figure of 1500 or 9710 bytes specifies the payload only. For an IEEE 802.1q frame, provision is made (internally) for the following additional components:

- Source and Destination addresses
- EtherType field
- Priority and VLAN tag fields
- FCS

These additional components increase the frame size internally (to 1522 bytes in the default case).

Syntax mru jumbo
no mru

Default By default, jumbo frame support is not enabled.

Mode Interface Configuration for switch ports.

Usage Note that [show interface](#) output will only show MRU size for switch ports.

We recommend limiting the number of ports with jumbo frames support enabled to two.

Examples To enable the device to forward jumbo frames on `port1.0.2`, use the commands:

```
awplus# configure terminal
awplus(config)# interface port1.0.2
awplus(config-if)# mru jumbo
```

To remove the jumbo frame support, and therefore restore the MRU size of 1500 bytes on `port1.0.2`, use the commands:

```
awplus# configure terminal
awplus(config)# interface port1.0.2
awplus(config-if)# no mru
```

Related Commands [show interface](#)

mtu

Overview Use this command to set the Maximum Transmission Unit (MTU) size for VLANs, where MTU is the maximum packet size that VLANs can transmit. The MTU size setting is applied to both IPv4 and IPv6 packet transmission.

Use the **no** variant of this command to remove a previously specified Maximum Transmission Unit (MTU) size for VLANs, and restore the default MTU size (1500 bytes) for VLANs.

Syntax `mtu <68-1582>`
`no mtu`

Default The default MTU size is 1500 bytes for VLAN interfaces.

Mode Interface Configuration for VLAN interfaces.

Usage If a device receives an IPv4 packet for Layer 3 switching to another VLAN with an MTU size smaller than the packet size, and if the packet has the **'don't fragment'** bit set, then the device will send an ICMP **'destination unreachable'** (3) packet type and a **'fragmentation needed and DF set'** (4) code back to the source. For IPv6 packets bigger than the MTU size of the transmitting VLAN interface, an ICMP **'packet too big'** (ICMP type 2 code 0) message is sent to the source.

Note that you cannot configure MTU on bridge interfaces. The MTU of the bridge interface is determined by the member interface of the bridge which has the lowest MTU. For example, if you attach eth1 with MTU 1200, ppp1 with MTU 1400, and vlan1 with MTU 1500 to a bridge interface, the MTU for that interface will be 1200.

Note that `show interface` output will only show MTU size for VLAN interfaces.

Examples To configure an MTU size of 1500 bytes on interface "vlan2", use the commands:

```
awplus# configure terminal
awplus(config)# interface vlan2
awplus(config-if)# mtu 1500
```

To configure an MTU size of 1500 bytes on interfaces "vlan2" to "vlan4", use the commands:

```
awplus# configure terminal
awplus(config)# interface vlan2-vlan4
awplus(config-if)# mtu 1500
```

To restore the MTU size to the default MTU size of 1500 bytes on "vlan2", use the commands

```
awplus# configure terminal
awplus(config)# interface vlan2
awplus(config-if)# no mtu
```

To restore the MTU size to the default MTU size of 1500 bytes on “vlan2” to “vlan4”, use the commands

```
awplus# configure terminal
awplus(config)# interface vlan2-vlan4
awplus(config-if)# no mtu
```

**Related
Commands** [show interface](#)

show interface

Overview Use this command to display interface configuration and status.

For information on filtering and saving command output, see the [“Getting Started with AlliedWare Plus” Feature Overview and Configuration Guide](#).

Syntax `show interface [<interface-list>]`
`show interface lo`

Parameter	Description
<code><interface-list></code>	<p>The interfaces or ports to configure. An interface-list can be:</p> <ul style="list-style-type: none">• an interface such as a VLAN (e.g. <code>vlan1</code>), a switch port (e.g. <code>port1.0.1</code>), a static channel group (e.g. <code>sa3</code>), a dynamic (LACP) channel group (e.g. <code>po4</code>), a PPP interface (e.g. <code>ppp0</code>), an Ethernet interface (e.g. <code>eth1</code>), a tunnel interface (e.g. <code>tunnel0</code>), or a bridge interface (e.g. <code>br2</code>).• a continuous range of interfaces, ports, static channel groups or dynamic (LACP) channel groups separated by a hyphen; e.g. <code>vlan2-8</code>, or <code>port1.0.1-1.0.6</code>, or <code>sa1-2</code>, or <code>po1-2</code>• a comma-separated list of the above; e.g. <code>port1.0.1, port1.0.4-1.0.6</code>. Do not mix interface types in a list <p>The specified interfaces must exist.</p>
<code>lo</code>	The local loopback interface.

Mode User Exec and Privileged Exec

Usage Note that the output displayed with this command will show MTU (Maximum Transmission Unit) size for VLAN interfaces, and MRU (Maximum Received Unit) size for switch ports.

Example To display configuration and status information for all interfaces, use the command:

```
awplus# show interface
```

Figure 11-1: Example output from the **show interface** command

```
awplus#show interface
Interface port1.0.1
  Scope: both
  Link is UP, administrative state is UP
  Thrash-limiting
    Status Not Detected, Action link-down, Timeout 60(s)
  Hardware is Ethernet, address is 0000.cd24.daeb
  index 5001 metric 1 mru 1500
  <UP,BROADCAST,RUNNING,MULTICAST>
  current duplex full, current speed 1000
  configured duplex auto, configured speed auto, configured polarity auto
  current ecofriendly lpi
  configured ecofriendly lpi
  SNMP link-status traps: Sending (Suppressed after 20 traps in 60 sec.)
    input packets 2396, bytes 324820, dropped 0, multicast packets 2370
    output packets 73235, bytes 406566, multicast packets 7321 broadcast packets 7
  Time since last state change: 0 days 16:35:52
...

```

To display configuration and status information for interface `lo`, use the command:

```
awplus# show interface lo
```

Figure 11-2: Example output from the **show interface lo** command

```
awplus#show interface lo
Interface lo
  Scope: both
  Link is UP, administrative state is UP
  Hardware is Loopback
  index 1 metric 1
  <UP,LOOPBACK,RUNNING>
  SNMP link-status traps: Disabled
    input packets 0, bytes 0, dropped 0, multicast packets 0
    output packets 0, bytes 0, multicast packets 0 broadcast packets 0
  Time since last state change: 69 days 01:28:47

```

To display configuration and status information for interfaces `vlan1` and `vlan2`, use the command:

```
awplus# show interface vlan1,vlan2
```

Figure 11-3: Example output from the **show interface vlan1,vlan2** command

```
awplus#show interface vlan1,vlan2
Interface vlan1
  Scope: both
  Link is UP, administrative state is UP
  Hardware is VLAN, address is 0015.77e9.5c50
  IPv4 address 192.168.1.1/24 broadcast 192.168.1.255
  index 201 metric 1 mtu 1500
  arp ageing timeout 300
  <UP,BROADCAST,RUNNING,MULTICAST>
  SNMP link-status traps: Disabled
  Bandwidth 1g
    input packets 295606, bytes 56993106, dropped 5, multicast packets 156
    output packets 299172, bytes 67379392, multicast packets 0 broadcast packets 0
  Time since last state change: 0 days 14:22:39

Interface vlan2
  Scope: both
  Link is DOWN, administrative state is UP
  Hardware is VLAN, address is 0015.77e9.5c50
  IPv4 address 192.168.2.1/24 broadcast 192.168.2.255
  Description: ip_phone_vlan
  index 202 metric 1 mtu 1500
  arp ageing timeout 300
  <UP,BROADCAST,MULTICAST>
  SNMP link-status traps: Disabled
  Bandwidth 1g
    input packets 0, bytes 0, dropped 0, multicast packets 0
    output packets 90, bytes 4244, multicast packets 0 broadcast packets 0
  Time since last state change: 0 days 14:22:39
```

To display configuration and status information for `br1`, use the command:

```
awplus# show interface br1
```

```
awplus#show interface br1
Interface br1
  Link is UP, administrative state is UP
  Hardware is Bridge
  IPv6 address fe80::200:cdff:fe38:f7/64
  index 33555969 metric 1
  MAC ageing time 300
  <UP,BROADCAST,RUNNING,MULTICAST>
  SNMP link-status traps: Disabled
    input packets 0, bytes 0, dropped 0, multicast packets 0
    output packets 3, bytes 218, multicast packets 0 broadcast packets 0
  Time since last state change: 0 days 00:00:09
```

To display configuration and status information for `eth1`, use the command:

```
awplus# show interface eth1
```

Figure 11-4: Example output from the **show interface eth1** command:

```
awplus#show interface eth1
Interface eth1
  Link is DOWN, administrative state is UP
  Hardware is Ethernet, address is 0200.0034.5682
  index 9 metric 1 mtu 1500
  configured duplex auto, configured speed auto, configured polarity auto
  <UP,BROADCAST,MULTICAST>
  SNMP link-status traps: Disabled
  Bandwidth 1g
    input packets 0, bytes 0, dropped 0, multicast packets 0
    output packets 0, bytes 0
  Time since last state change: 0 days 20:18:54
```

**Related
Commands**

- [mru jumbo](#)
- [mtu](#)
- [show interface brief](#)

show interface brief

Overview Use this command to display brief interface, configuration, and status information, including provisioning information.

For information on filtering and saving command output, see the [“Getting Started with AlliedWare Plus” Feature Overview and Configuration Guide](#).

Syntax `show interface brief`

Mode User Exec and Privileged Exec

Output Figure 11-5: Example output from **show interface brief**

```
awplus#show interface brief
Interface          Status           Protocol
port1.0.1          admin up         down
port1.0.2          admin up         down
port1.0.3          admin up         down
port1.0.4          admin up         down
port1.0.5          admin up         down
port1.0.6          admin up         down
port1.0.7          admin up         down
port1.0.8          admin up         down
eth2               admin up         down
eth1               admin up         down
lo                 admin up         running
vlan1              admin up         down
vlan2              admin up         down
ppp1               admin up         down
```

Table 11-1: Parameters in the output of **show interface brief**

Parameter	Description
Interface	The name or type of interface.
Status	The administrative state. This can be either admin up or admin down .
Protocol	The link state. This can be either down , running , or provisioned .

Related Commands [show interface](#)
[show interface memory](#)

show interface memory

Overview This command displays the shared memory used by either all interfaces, or the specified interface or interfaces. The output is useful for diagnostic purposes by Allied Telesis authorized service personnel.

For information on filtering and saving command output, see the [“Getting Started with AlliedWare Plus” Feature Overview and Configuration Guide](#).

Syntax `show interface memory`
`show interface <port-list> memory`

Parameter	Description
<port-list>	Display information about only the specified port or ports. The port list can be: <ul style="list-style-type: none">• an Eth (e.g. eth1) or switch port (e.g. port1.0.4), a static channel group (e.g. sa2) or a dynamic (LACP) channel group (e.g. po2)• a continuous range of ports separated by a hyphen (e.g. port1.0.1-1.0.4, or sa1-2, or po1-2)• a comma-separated list of ports and port ranges (e.g. port1.0.1,port1.0.4-1.0.6). Do not mix port types in the same list.

Mode User Exec and Privileged Exec

Example To display the shared memory used by all interfaces, use the command:

```
awplus# show interface memory
```

To display the shared memory used by port1.0.1 and port1.0.5 to port1.0.6, use the command:

```
awplus# show interface port1.0.1,port1.0.5-1.0.6 memory
```

Output Figure 11-6: Example output from the **show interface memory** command

```
awplus#show interface memory
Vlan blocking state shared memory usage
-----
Interface    shmid      Bytes Used  nattch    Status
port1.0.1    294921     512         1         1
port1.0.2    491535     512         1         1
port1.0.3    458766     512         1         1
port1.0.4    524304     512         1         1
port1.0.5    425997     512         1         1
port1.0.6    589842     512         1         1
port1.0.7    557073     512         1         1
port1.0.8    622611     512         1         1
eth2         327690     512         1         1
eth1         393228     512         1         1
lo           360459     512         1         1
```

Figure 11-7: Example output from **show interface <port-list> memory** for a list of interfaces

```
awplus#show interface port1.0.1,port1.0.5-1.0.6 memory
Vlan blocking state shared memory usage
-----
Interface      shmid      Bytes Used      natch      Status
port1.0.1      294921     512              1
port1.0.5      425997     512              1
port1.0.6      589842     512              1
```

- Related
Commands**
- [show interface brief](#)
 - [show interface status](#)
 - [show interface switchport](#)

show interface status

Overview Use this command to display the status of the specified interface or interfaces. Note that when no interface or interfaces are specified then the status of all interfaces on the device are shown.

Syntax `show interface [<port-list>] status`

Parameter	Description
<port-list>	<p>The ports to display information about. The port list can be:</p> <ul style="list-style-type: none"> a switch port (e.g. port1.0.6), a static channel group (e.g. sa2) or a dynamic (LACP) channel group (e.g. po2) a continuous range of ports separated by a hyphen, e.g. port1.0.1-1.0.6, or sa1-2, or po1-2 a comma-separated list of ports and port ranges, e.g. port1.0.1,port1.0.4-1.0.6. Do not mix switch ports, static channel groups, and dynamic (LACP) channel groups in the same list

Examples To display the status of ports 1.0.1 to 1.0.4, use the commands:

```
awplus# show interface port1.0.1-1.0.4 status
```

Table 12: Example output from the `show interface <port-list> status` command

```
awplus#show interface port1.0.1-1.0.4 status
```

Port	Name	Status	Vlan	Duplex	Speed	Type
port1.0.1		notconnect	1	auto	auto	1000BASE-T
port1.0.2		notconnect	1	auto	auto	1000BASE-T
port1.0.3		notconnect	1	auto	auto	1000BASE-T
port1.0.4		notconnect	1	auto	auto	1000BASE-T

To display the status of all ports, use the commands:

```
awplus# show interface status
```

Table 13: Example output from the `show interface status` command

```
awplus#sho int status
```

Port	Name	Status	Vlan	Duplex	Speed	Type
port1.0.1	Trunk_Net	connected	trunk	a-full	a-1000	1000BaseTX
port1.0.2	Access_Net1	connected	5	full	1000	1000BaseTX
port1.0.3	Access_Net1	disabled	5	auto	auto	1000BaseTX
port1.0.4	Access_Net2	connected	6	auto	auto	1000BaseTX
...						
eth2		notconnect	none	auto	auto	1000BASE-T
eth1		notconnect	none	auto	auto	1000BASE-T

Table 14: Parameters in the output from the **show interface status** command

Parameter	Description
Port	Name/Type of the interface.
Name	Description of the interface.
Status	The administrative and operational status of the interface; one of: <ul style="list-style-type: none"> disabled: the interface is administratively down. connect: the interface is operationally up. notconnect: the interface is operationally down.
Vlan	VLAN type or VLAN IDs associated with the port: <ul style="list-style-type: none"> When the VLAN mode is trunk, it displays trunk (it does not display the VLAN IDs). When the VLAN mode is access, it displays the VLAN ID. When the VLAN mode is private promiscuous, it displays the primary VLAN ID if it has one, and promiscuous if it does not have a VLAN ID. When the VLAN mode is private host, it displays the primary and secondary VLAN IDs. When the port is an Eth port, it displays none: there is no VLAN associated with it. When the VLAN is dynamically assigned, it displays the current dynamically assigned VLAN ID (not the access VLAN ID), or dynamic if it has multiple VLANs dynamically assigned.
Duplex	The actual duplex mode of the interface, preceded by a- if it has autonegotiated this duplex mode. If the port is disabled or not connected, it displays the configured duplex setting.
Speed	The actual link speed of the interface, preceded by a- if it has autonegotiated this speed. If the port is disabled or not connected, it displays the configured speed setting.
Type	The type of interface, e.g. 1000BaseTX. For SFP bays, it displays Unknown if it does not recognize the type of SFP installed, or Not present if an SFP is not installed or is faulty.

Related Commands [show interface](#)
[show interface memory](#)

shutdown

Overview This command shuts down the selected interface. This administratively disables the link and takes the link down at the physical (electrical) layer.

Use the **no** variant of this command to disable this function and therefore to bring the link back up again.

Syntax shutdown
no shutdown

Mode Interface Configuration

Usage If you shutdown an aggregator, the device shows the admin status of the aggregator and its component ports as “admin down”. While the aggregator is down, the device accepts **shutdown** and **no shutdown** commands on component ports, but these have no effect on port status. Ports will not come up again while the aggregator is down.

Example To shut down port1.0.2, use the commands:

```
awplus# configure terminal
awplus(config)# interface port1.0.2
awplus(config-if)# shutdown
```

To bring up port1.0.2, use the commands:

```
awplus# configure terminal
awplus(config)# interface port1.0.2
awplus(config-if)# no shutdown
```

To shut down vlan2, use the commands:

```
awplus# configure terminal
awplus(config)# interface vlan2
awplus(config-if)# shutdown
```

To bring up vlan2, use the commands:

```
awplus# configure terminal
awplus(config)# interface vlan2
awplus(config-if)# no shutdown
```

12

USB Cellular Modem Commands

Introduction

Overview This chapter provides an alphabetical reference of commands used to configure USB Cellular Modems.

For more information, see the [USB Cellular Modem Feature Overview and Configuration Guide](#).

- Command List**
- [“apn”](#) on page 423
 - [“chat-script”](#) on page 425
 - [“encapsulation ppp”](#) on page 426
 - [“show cellular”](#) on page 428
 - [“show system usb”](#) on page 431
 - [“usb mode-switch”](#) on page 433

apn

Overview Use this command to set the Access Point Name (APN) to use to connect to a 3G serial cellular network.

Use the **no** variant of this command to unset the APN.

Syntax `apn <access-point-name>`
`no apn <access-point-name>`

Parameter	Description
<code><access-point-name></code>	The APN to use to connect to a cellular network (for example, <code>www.example.com</code>).

Default No APN is set

Mode Interface Configuration (Cellular)

Usage The APN has to be set in order to initiate the cellular network connection. Some mobile network operators do not require a specific APN to be specified, in this case any APN can be used.

Examples To set the APN to `www.example.com` for a cellular interface, use the commands:

```
awplus# configure terminal
awplus(config)# int cellular0
awplus(config-if)# apn www.example.com
```

Output Figure 12-1: Example output from the **apn** command

```
awplus#configure terminal
awplus(config)#int cellular0
awplus(config-if)#apn www.example.com
```

To unset the APN, use the commands:

```
awplus# configure terminal
awplus(config)# int cellular0
awplus(config-if)# no apn
```

Output Figure 12-2: Example output from the **no apn** command

```
awplus#configure terminal
awplus(config)#int cellular0
awplus(config-if)#no apn
```

Related Commands [chat-script](#)

show cellular
show system usb
usb mode-switch

chat-script

Overview Use this command to set a chat-script, instead of the default chat-script, to connect to a 3G serial cellular network.

Use the **no** variant of this command to set the chat-script back to the default.

Syntax `chat-script <file-name>`
`no chat-script <file-name>`

Parameter	Description
<code><file-name></code>	The path to the chat-script file (this file has to have a ".chat" extension).

Default The default chat-script is a built in chat-script that in most cases is sufficient for connecting to a cellular network.

Mode Interface Configuration (Cellular)

Usage The chat-script file must have the file extension ".chat". The chat-script consists of a sequence of expect-send pairs of strings. The send strings are AT (Hayes) commands. Any occurrence of the string \$APN in the chat-script will be substituted with the Access Point Name (APN) configured on a cellular interface.

Examples To use a non-default chat-script, "connect.chat", use the commands:

```
awplus# configure terminal
awplus(config)# interface cellular0
awplus(config-if)# #chat-script connect.chat
```

To use the default chat-script, use the commands:

```
awplus# configure terminal
awplus(config)# interface cellular0
awplus(config-if)# #no chat-script
```

Related Commands

- [apn](#)
- [show cellular](#)
- [show system usb](#)
- [usb mode-switch](#)

encapsulation ppp

Overview Use this command to enable PPP encapsulation and create one or more PPP interfaces over Ethernet, a cellular interface, or a L2TPv2 managed VPN.

Use the **no** variant of this command to disable PPP encapsulation and remove the specified PPP interface.

Syntax encapsulation ppp <index>
no encapsulation ppp <index>

Parameter	Description
<index>	The PPP interface index number in the range from 0 to 255.

Default No PPP encapsulation or interfaces are configured by default.

Mode Interface Configuration mode for an Ethernet interface (e.g. **interface eth1**), or an Ethernet sub-interface (e.g. **interface eth1.1**), or a cellular interface (e.g. **interface cellular0**).

L2TP Tunnel Configuration mode for an L2TP tunnel (e.g. **l2tp tunnel tunnel0**).

Examples To configure a PPP interface with index 0 for Ethernet interface eth1, use the commands:

```
awplus# configure terminal
awplus(config)# interface eth1
awplus(config-if)# encapsulation ppp 0
```

To shut down the ppp0 interface and remove it from Ethernet interface eth1, use the commands:

```
awplus# configure terminal
awplus(config)# interface ppp0
awplus(config-if)# shutdown
awplus(config-if)# interface eth1
awplus(config-if)# no encapsulation ppp 0
```

To set the L2TP tunnel tunnel1 to encapsulate the PPP interface with index 1, use the commands:

```
awplus# configure terminal
awplus(config)# l2tp tunnel tunnel1
awplus(config-l2tp-tunnel)# encapsulation ppp 1
```

To remove the PPP interface with index 1 from L2TP tunnel tunnel1, use the commands:

```
awplus# configure terminal
awplus(config)# l2tp tunnel tunnel1
awplus(config-l2tp-tunnel)# no encapsulation ppp 1
```

**Related
Commands**

[l2tp tunnel](#)
[ppp service-name \(PPPoE\)](#)
[show interface \(PPP\)](#)

show cellular

Overview Use this command to display status information about 3G serial USB cellular modems currently plugged into your AR-Series Firewall.

Syntax `show cellular <cellular-interface-name>`

Parameter	Description
<code><cellular-interface-name></code>	Specify the name of a cellular interface. This option displays status information for the cellular modem associated with that interface.

Default None

Mode Privileged Exec

Usage If a cellular interface is specified, then the command only shows information for the cellular modem associated with that interface. Different vendors, and models of cellular modems often provide different sets of information:

- Vendor-specific information will not be displayed if the information is unable to be obtained from the cellular modem.
- For information that is common to most cellular modems, "(unknown)" will be displayed if the information was not obtained successfully.

Examples To show status information about all cellular modems, use the command:

```
awplus# show cellular
```

Output Figure 12-3: Example output from **show cellular**

```
awplus#show cellular
Interface cellular0
  Manufacturer: huawei
  Model ID: E1762
  Revision ID: 11.126.10.00.74
  Serial ID: 351553036840711
  IMSI: 530011104647258
  Signal Quality:
    RSSI: -71 dBm
    Bit Error Rate: (unknown)
  Service Center Address:
    Phone Number: +6421600600
    Number Type: International
  GPRS Mobile Station Class: Class A
  Serial Port Configuration:
    Baud rate: 115200
    Character Format: 8-N-1
    Parity: Space
```

```
Terminal Equipment Character Set: IRA
Cable interface DTE-DCE local flow control:
  To DTE: RTS
  To DCE: CTS
System Time: 1980/01/06,03:37:39
GPRS Network Registration Status: Registered, home network
PIN Request Status: READY
Functionality Level: Full functionality (power-saving disabled)
Facility Lock Status:
  SIM card lock: Not active
  SIM fixed dialling memory feature: Not active
  Network personalization: Not active
  Network subset personalization: Not active
  Service provider personalization: Not active
  Corporate personalization: Not active
  Lock phone to first SIM card: Not active
Call Mode: Single mode
Wireless Data Service: 3GPP systems (GERAN, UTRAN and E-UTRAN)
GPRS Service Status: Mobile station is attached to a GPRS service
Dialling Number Type: National
Bearer Service Type:
  Autobauding: Enabled
  Service: Data circuit asynchronous (UDI or 3.1 kHz modem)
  Connection Element: Non-transparent
Automatic time and time zone update via NITS: Not enabled
PPP support between TE and MT: Supported
Last Error Report: No cause information available
PLMN selection method: User controlled PLMN selected from Access Technology
PDP Contexts:
  Context ID: 1
  Type: IP
  APN: www.vodafone.net.nz
  Address: 0.0.0.0
  Header Compression: Off
  Status: Not active
  Primary DNS: 0.0.0.0
  Secondary DNS: 0.0.0.0
  Diagnostic mode baud rate: 115200
  TE-DCE baud rate: 115200
  Tolerance to long delays in PDP call setup: Enabled
  Hardware Version: CD25TCPV
System Info:
  System Service State: Valid service
  System Service Domain: CS and PS service
  Roaming Status: Not roaming
  System Mode: WCDMA mode
  SIM card state: Valid USIM card state
  System Sub-mode: WCDMA mode
System Config:
  Supported System Mode: Auto-select
  Network Acquisition Order: WCDMA, then GSM
  Service Domain Support: CS and PS
Card-Lock:
  Lock Status: Unlock code does not need to be provided
  Remaining Unlock Attempts: 10
  PLMN ID of the operator who has locked this device: None
```

```
Signal Strength:
  RSSI (dBm): -64
  ECIO (dBm): -5
  RSCP (dBm): -69
ICCID: 984610411061462785F5
Software Version: E1762 11.126.10.00.74,CD25TCPV,Ver.B
HSUPA status: Enabled
HSDPA status: Enabled
Card Mode: USIM
Device Mode:
  Mode ID: 20
  Port Modes:
    Port 0: MDM
    Port 1: NDIS
    Port 2: DIAG
    Port 3: PCUI
    Port 4: CDROM
Data Service Traffic:
  Last Connection Time (s): 5134
  Last Bytes Transmitted: 0
  Last Bytes Received: 168
  Total Connection Time (s): 64354
  Total Bytes Transmitted: 910
  Total Bytes Received: 3168
PIN Status:
  Status: READY
  Remaining input attempts:
    PUK: 10
    PIN: 3
    PUK2: 10
    PIN2: 3
```

To show status information about the cellular modem associated with interface 'cellular0' only, use the command:

```
awplus# show cellular cellular0
```

**Related
Commands**

[apn](#)
[chat-script](#)
[show system usb](#)
[usb mode-switch](#)

show system usb

Overview Use this command to display technical information about connected USB devices.

Syntax `show system usb [detail]`

Parameter	Description
detail	This option provides greater detail about the USB device, such as descriptors for the device, configuration and Interface.

Default None

Mode Privileged Exec

Examples To show information about USB devices connected to your AR-Series Firewall, use the command:

```
awplus# show system usb
```

Output Figure 12-4: Example output from **show system usb**

```
awplus#show system usb
Bus 001 Device 003: ID 12d1:140c Huawei Technologies Co., Ltd. E180v modem
```

To show greater detail of information about USB devices connected to your AR-Series Firewall, use the command:

```
awplus# show system usb detail
```

Output Figure 12-5: Example output from **show system usb detail**

```
awplus#show system usb detail

Bus 001 Device 002: ID 12d1:1001 Huawei Technologies Co., Ltd. E169/E620/E800 HS
DPA Modem
Device Descriptor:
  bLength                18
  bDescriptorType        1
  bcdUSB                  2.00
  bDeviceClass            0 (Defined at Interface level)
  bDeviceSubClass        0
  bDeviceProtocol         0
  bMaxPacketSize0        64
```

```
idVendor      0x12d1 Huawei Technologies Co., Ltd.
idProduct     0x1001 E169/E620/E800 HSDPA Modem
bcdDevice     0.00
iManufacturer 3 HUAWEI Technology
iProduct      2 HUAWEI Mobile
iSerial       0
bNumConfigurations 1
Configuration Descriptor:
  bLength      9
  bDescriptorType 2
  wTotalLength 85
  bNumInterfaces 3
  bConfigurationValue 1
  iConfiguration 1 Huawei Configuration
  bmAttributes 0xe0
    Self Powered
    Remote Wakeup
  MaxPower     500mA
Interface Descriptor:
  bLength      9
  bDescriptorType 4
  bInterfaceNumber 0
  bAlternateSetting 0
  bNumEndpoints 3
  bInterfaceClass 255 Vendor Specific Class
  bInterfaceSubClass 255 Vendor Specific Subclass
  bInterfaceProtocol 255 Vendor Specific Protocol
  iInterface    0
...

```

- Related Commands**
- [apn](#)
 - [chat-script](#)
 - [show cellular](#)
 - [usb mode-switch](#)

usb mode-switch

Overview Use this command to map a specific USB device to a mode-switch configuration file.

The **no** variant of this command removes the configuration corresponding to a specific ID.

Syntax `usb mode-switch id <1-16> vendor-id <vendor-id> product-id <product-id> [manufacturer <manufacturer>|product <product>|serial <serial>|vendor <vendor>|model <model>|revision <revision>] file <file-name>`
`no usb mode-switch id <1-16>`

Parameter	Description
id	mode switch configuration ID.
<1-16>	Configuration ID number (from 1 through 16).
vendor-id	Specify the USB device's vendor ID.
<vendor-id>	4 digit hexadecimal value representing the device's vendor ID.
product-id	Specify the USB device's product ID.
<product-id>	4 digit hexadecimal value representing the device's product ID.
manufacturer	Specify the USB product descriptor.
<manufacturer>	All or part of the USB manufacturer string descriptor (with spaces replaced by underscores).
product	Specify the USB product descriptor.
<product>	All or part of the USB product string descriptor (with spaces replaced by underscores).
serial	Specify the USB serial descriptor.
<serial>	All or part of the USB serial string descriptor (with spaces replaced by underscores).
vendor	Specify the SCSI vendor descriptor.
<vendor>	All or part of the SCSI model descriptor (with spaces replaced by underscores).
model	Specify the SCSI model descriptor.
<model>	All or part of the SCSI revision descriptor (with spaces replaced by underscores).
revision	Specify the SCSI revision descriptor.
<revision>	All or part of the SCSI revision descriptor (with spaces replaced by underscores).

Parameter	Description
file	Specify the mode switch config file to be used instead of the default when the target device is inserted.
<file>	Mode switch configuration file URL with extension .conf.

Default Some USB devices will use a default mode switch configuration file if one is not specified.

Mode Global Configuration

Usage Some USB devices must be explicitly told to switch to a compatible mode. The **usb mode-switch** command does this by matching on a target device by its USB vendor and product IDs, and executing a specified configuration file.

Additional parameters can be defined which specify other USB and SCSI descriptors. These are useful if there are multiple devices that have the same product and vendor IDs, but differ in the other parameters. The mode switch configuration files must have the extension “.conf”.

Examples To add a mode switch configuration for a USB device, use the commands:

```
awplus# configure terminal
awplus(config)# usb mode-switch id 1 vendor-id 12d1 product-id
140c manufacturer HUAWEI file switch.conf
```

To remove a mode switch configuration for a USB device, use the commands:

```
awplus# configure terminal
awplus(config)# no usb mode-switch id 1
```

**Related
Commands**

- apn
- chat-script
- show cellular
- show system usb
- usb mode-switch

13

Port Mirroring Commands

Introduction

Overview This chapter provides an alphabetical reference of commands used to configure Port Mirroring.

For more information, see the [Mirroring Feature Overview and Configuration Guide](#).

- Command List**
- [“mirror interface”](#) on page 436
 - [“show mirror”](#) on page 438
 - [“show mirror interface”](#) on page 439

mirror interface

Overview Use this command to define a mirror port and mirrored (monitored) ports and direction of traffic to be mirrored. The port for which you enter interface mode will be the mirror port.

The destination port is removed from all VLANs, and no longer participates in other switching.

Use the **no** variant of this command to disable port mirroring by the destination port on the specified source port.

Syntax

```
mirror interface <source-port-list> direction  
{both|receive|transmit}  
  
no mirror interface <source-port-list>
```

Parameter	Description
<source-port-list>	The source switch ports to mirror. A port-list can be: <ul style="list-style-type: none">• a port (e.g. port1.0.2)• a continuous range of ports separated by a hyphen, e.g. port1.0.1-1.0.2• a comma-separated list of ports and port ranges, e.g. port1.0.1,port1.0.4-1.0.6 The source port list cannot include dynamic or static channel groups (link aggregators).
direction	Specifies whether to mirror traffic that the source port receives, transmits, or both.
both	Mirroring traffic both received and transmitted by the source port.
receive	Mirroring traffic received by the source port.
transmit	Mirroring traffic transmitted by the source port.

Mode Interface Configuration

Usage Use this command to send traffic to another device connected to the mirror port for monitoring.

For more information, see the [Mirroring Feature Overview and Configuration Guide](#).

A mirror port cannot be associated with a VLAN. If a switch port is configured to be a mirror port, it is automatically removed from any VLAN it was associated with.

This command can only be applied to a single mirror (destination) port, not to a range of ports, nor to a static or dynamic channel group. Do not apply multiple interfaces with an interface command before issuing the mirror interface command. One interface may have multiple mirror interfaces.

Example To mirror traffic received and transmitted on port1.0.4 and port1.0.5 to destination port1.0.3, use the commands:

```
awplus# configure terminal
awplus(config)# interface port1.0.3
awplus(config-if)# mirror interface port1.0.4,port1.0.5
direction both
```

show mirror

Overview Use this command to display the status of all mirrored ports.

Syntax `show mirror`

Mode User Exec and Privileged Exec

Example To display the status of all mirrored ports, use the following command:

```
awplus# show mirror
```

Output Figure 13-1: Example output from the **show mirror** command

```
Mirror Test Port Name: port1.0.1
Mirror option: Enabled
Mirror direction: both
Monitored Port Name: port1.0.2
Mirror Test Port Name: port1.0.3
Mirror option: Enabled
Mirror direction: receive
Monitored Port Name: port1.0.4
Mirror Test Port Name: port1.0.3
Mirror option: Enabled
Mirror direction: receive
Monitored Port Name: port1.0.1
Mirror Test Port Name: port1.0.1
Mirror option: Enabled
Mirror direction: receive
Monitored Port Name: port1.0.3
Mirror Test Port Name: port1.0.1
Mirror option: Enabled
Mirror direction: transmit
Monitored Port Name: port1.0.4
```

show mirror interface

Overview Use this command to display port mirroring configuration for a mirrored (monitored) switch port.

Syntax `show mirror interface <port>`

Parameter	Description
<code><port></code>	The monitored switch port to display information about.

Mode User Exec, Privileged Exec and Interface Configuration

Example To display port mirroring configuration for the `port1.0.4`, use the following commands:

```
awplus# configure terminal
awplus(config)# interface port1.0.4
awplus(config-if)# show mirror interface port1.0.4
```

Output Figure 13-2: Example output from the **show mirror interface** command

```
Mirror Test Port Name: port1.0.3
Mirror option: Enabled
Mirror direction: both
Monitored Port Name: port1.0.4
```

14

Interface Testing Commands

Introduction

Overview This chapter provides an alphabetical reference of commands used for testing interfaces.

- Command List**
- “clear test interface” on page 441
 - “service test” on page 442
 - “test interface” on page 443

clear test interface

Overview This command clears test results and counters after issuing the [test interface](#) command. Test results and counters must be cleared before executing subsequent [test interface](#) commands.

Syntax `clear test interface {<port-list>|all}`

Parameter	Description
<code><port-list></code>	The ports to test. A port-list can be: <ul style="list-style-type: none">• a switch port (e.g. <code>port1.0.6</code>)• a continuous range of ports separated by a hyphen, e.g. <code>port1.0.1-port1.0.6</code>• a comma-separated list of the above, e.g. <code>port1.0.1,port1.0.5-1.0.6</code> The specified ports must exist.
<code>all</code>	All interfaces

Mode Privileged Exec

Examples To clear the counters for `port1.0.1` use the command:

```
awplus# clear test interface port1.0.1
```

To clear the counters for all interfaces use the command:

```
awplus# clear test interface all
```

Related Commands [test interface](#)

service test

Overview This command puts the device into the interface testing state, ready to begin testing. After entering this command, enter Interface Configuration mode for the desired interfaces and enter the command [test interface](#).

Do not test interfaces on a device that is part of a live network—disconnect the device first.

Use the **no** variant of this command to stop the test service.

Syntax `service test`
`no service test`

Mode Global Configuration

Example To put the device into a test state, use the command:

```
awplus(config)# service test
```

**Related
Commands** [test interface](#)

test interface

Overview This command starts a test on a port or all ports or a selected range or list of ports.

Use the **no** variant of this command to disable this function. The test duration can be configured by specifying the time in minutes after specifying a port or ports to test.

For an example of all the commands required to test switch ports, see the Examples section in this command. To test an Ethernet port, set its speed to 100 by using the command **speed 100**.

NOTE: Do not run test interface on live networks because this will degrade network performance.

Syntax test interface {<port-list>|all} [time{<1-60>|cont}]
no test interface {<port-list>|all}

Parameter	Description
<port-list>	The ports to test. A port-list can be: <ul style="list-style-type: none">• a switch port (e.g. port1.0.6)• a continuous range of ports separated by a hyphen, e.g. port1.0.1-port1.0.6• a comma-separated list of the above, e.g. port1.0.1,port1.0.5-1.0.6 The specified ports must exist.
all	All ports
time	Keyword entered prior to the value for the time duration of the interface test.
<1-60>	Specifies duration of time to test the interface or interfaces in minutes (from a minimum of 1 minute to a maximum of 60 minutes). The default is 4 minutes.
cont	Specifies continuous interface testing until canceled with command negation.

Mode Privileged Exec

Example To test the switch ports in VLAN 1, install loopbacks in the ports, and enter the following commands:

```
awplus(config)# service test
awplus(config)# no spanning-tree rstp enable bridge-forward
awplus(config)# interface vlan1
awplus(config-if)# shutdown
awplus(config-if)# end
awplus# test interface all
```

To see the output, use the commands:

```
awplus# show test
awplus# show test count
```

To start the test on all interfaces for 1 minute use the command:

```
awplus# test interface all time 1
```

**Related
Commands** [clear test interface](#)

Part 2: Interfaces and Layer 2

15

Switching Commands

Introduction

Overview This chapter provides an alphabetical reference of commands used to configure switching.

For more information, see the [Switching Feature Overview and Configuration Guide](#).

- Command List**
- “backpressure” on page 448
 - “clear mac address-table dynamic” on page 450
 - “clear mac address-table static” on page 452
 - “clear port counter” on page 453
 - “debug platform packet” on page 454
 - “duplex” on page 456
 - “flowcontrol (switch port)” on page 457
 - “linkflap action” on page 459
 - “mac address-table acquire” on page 460
 - “mac address-table ageing-time” on page 461
 - “mac address-table static” on page 462
 - “polarity” on page 463
 - “show debugging platform packet” on page 464
 - “show flowcontrol interface” on page 465
 - “show interface err-disabled” on page 466
 - “show interface switchport” on page 467
 - “show mac address-table” on page 468
 - “show platform” on page 470

- [“show platform port”](#) on page 471
- [“show storm-control”](#) on page 476
- [“speed”](#) on page 477
- [“storm-control level”](#) on page 479
- [“undebug platform packet”](#) on page 480

backpressure

Overview This command provides a method of applying flow control to ports running in half duplex mode. The setting will only apply when the link is in the half-duplex state.

You can disable backpressure on an interface using the **off** parameter or the **no** variant of this command.

Syntax `backpressure {on|off}`
`no backpressure`

Parameters	Description
on	Enables half-duplex flow control.
off	Disables half-duplex flow control.

Default Backpressure is turned off by default. You can determine whether an interface has backpressure enabled by viewing the running-config output; **backpressure on** is shown for interfaces if this feature is enabled.

Mode Interface Configuration

Usage The backpressure feature enables half duplex Ethernet ports to control traffic flow during congestion by preventing further packets arriving. Back pressure utilizes a pre-802.3x mechanism in order to apply Ethernet flow control to switch ports that are configured in the half duplex mode.

The flow control applied by the [flowcontrol \(switch port\)](#) command operates only on full-duplex links, whereas back pressure operates only on half-duplex links.

If a port has insufficient capacity to receive further frames, the device will simulate a collision by transmitting a CSMA/CD jamming signal from this port until the buffer empties. The jamming signal causes the sending device to stop transmitting and wait a random period of time, before retransmitting its data, thus providing time for the buffer to clear. Although this command is only valid for switch ports operating in half-duplex mode the remote device (the one sending the data) can be operating in the full duplex mode.

To see the currently-negotiated duplex mode for ports whose links are up, use the command [show interface](#). To see the configured duplex mode (when different from the default), use the command [show running-config](#).

Examples To enable back pressure flow control on interfaces `port1.0.1-port1.0.2` enter the following commands:

```
awplus# configure terminal
awplus(config)# interface port1.0.1-port1.0.2
awplus(config-if)# backpressure on
```

To disable back pressure flow control on interface `port1.0.2` enter the following commands:

```
awplus# configure terminal
awplus(config)# interface port1.0.2
awplus(config-if)# backpressure off
```

**Validation
Commands** `show running-config`
`show interface`

**Related
Commands** `duplex`

clear mac address-table dynamic

Overview Use this command to clear the filtering database of all entries learned for a selected MAC address, an MSTP instance, a switch port interface or a VLAN interface.

Syntax `clear mac address-table dynamic [address <mac-address>|interface <port> [instance <inst>]|vlan <vid>]`

Parameter	Description
address	Specify a MAC (Media Access Control) address to be cleared from the filtering database.
<mac-address>	Enter a MAC address to be cleared from the database in the format HHHH.HHHH.HHHH.
interface	Specify a switch port to be cleared from the filtering database.
instance	Specify an MSTP (Multiple Spanning Tree) instance to be cleared from the filtering database.
<inst>	Enter an MSTP instance in the range 1 to 63 to be cleared from the filtering database.
vlan	Specify a VLAN to be cleared from the filtering database.
<vid>	Enter a VID (VLAN ID) in the range 1 to 4094 to be cleared from the filtering database.

Mode Privileged Exec

Usage Use this command with options to clear the filtering database of all entries learned for a given MAC address, interface or VLAN. Use this command without options to clear any learned entries.

Use the optional `instance` parameter to clear the filtering database entries associated with a specified MSTP instance. Note that you must first specify a switch port interface before you can specify an MSTP instance.

Compare this usage and operation with the [clear mac address-table static](#) command. Note that an MSTP instance cannot be specified with the command **clear mac address-table static**.

Examples This example shows how to clear all dynamically learned filtering database entries for all interfaces, addresses, VLANs.

```
awplus# clear mac address-table dynamic
```

This example shows how to clear all dynamically learned filtering database entries when learned through device operation for the MAC address 0000.5E00.5302.

```
awplus# clear mac address-table dynamic address 0000.5E00.5302
```

This example shows how to clear all dynamically learned filtering database entries when learned through device operation for a given MSTP instance 1 on switch port interface port1.0.2.

```
awplus# clear mac address-table dynamic interface port1.0.2  
instance 1
```

**Related
Commands** [clear mac address-table static](#)
[show mac address-table](#)

clear mac address-table static

Overview Use this command to clear the filtering database of all statically configured entries for a selected MAC address, interface, or VLAN.

Syntax `clear mac address-table static [address <mac-address>|interface <port>|vlan <vid>]`

Parameter	Description
address	The MAC address whose entries are to be cleared from the filtering database.
<mac-address>	Specifies the MAC (Media Access Control) address to be cleared from. Enter this address in the format HHHH.HHHH.HHHH.
interface	Specify the interface from which statically configured entries are to be cleared.
<port>	Specify the switch port from which address entries will be cleared. This can be a single switch port, (e.g. port1.0.4), a static channel group (e.g. sa2), or a dynamic (LACP) channel group (e.g. po2).
vlan	A VLAN whose statically configured entries are to be cleared.
<vid>	Specifies the VLAN ID whose statically configured entries are to be cleared.

Mode Privileged Exec

Usage Use this command with options to clear the filtering database of all entries made from the CLI for a given MAC address, interface or VLAN. Use this command without options to clear any entries made from the CLI.

Compare this usage with [clear mac address-table dynamic](#) command.

Examples This example shows how to clear all filtering database entries configured through the CLI.

```
awplus# clear mac address-table static
```

This example shows how to clear all filtering database entries for a specific interface configured through the CLI.

```
awplus# clear mac address-table static interface port1.0.3
```

This example shows how to clear filtering database entries configured through the CLI for the mac address 0000.5E00.5302.

```
awplus# clear mac address-table static address 0000.5E00.5302
```

Related Commands

- [clear mac address-table dynamic](#)
- [mac address-table static](#)
- [show mac address-table](#)

clear port counter

Overview Use this command to clear the packet counters of the port.

Syntax `clear port counter [<port>]`

Parameter	Description
<code><port></code>	The port number or range

Mode Privileged Exec

Example To clear the packet counter for `port1.0.1`, use the command:

```
awplus# clear port counter port1.0.1
```

Related Commands [show platform port](#)

debug platform packet

Overview This command enables platform to CPU level packet debug functionality on the device.

Use the **no** variant of this command to disable platform to CPU level packet debug. If the result means both send and receive packet debug are disabled, then any active timeout will be canceled.

Syntax debug platform packet [recv] [send] [timeout <timeout>] [vlan <vlan-id>|all]
no debug platform packet [recv] [send]

Parameter	Description
recv	Debug packets received.
send	Debug packets sent.
timeout	Stop debug after a specified time.
<timeout>	<0-3600>The timeout period, specified in seconds.
vlan	Limit debug to a single VLAN ID specified.
<vlan-id>	<1-4094> The VLAN ID to limit the debug output on.
all	Debug all VLANs (default setting).

Default A 5 minute timeout is configured by default if no other timeout duration is specified.

Mode Privileged Exec and Global Configuration

Usage This command can be used to trace packets sent and received by the CPU. If a timeout is not specified, then a default 5 minute timeout will be applied.

If a timeout of 0 is specified, packet debug will be generated until the **no** variant of this command is used or another timeout value is specified. The timeout value applies to both send and receive debug and is updated whenever the **debug platform packet** command is used.

Examples To enable both receive and send packet debug for the default timeout of 5 minutes, enter:

```
awplus# debug platform packet
```

To enable receive packet debug for 10 seconds, enter:

```
awplus# debug platform packet recv timeout 10
```

To enable send packet debug with no timeout, enter:

```
awplus# debug platform packet send timeout 0
```

To enable VLAN packet debug for VLAN 2 with a timeout duration of 3 minutes, enter:

```
awplus# debug platform packet vlan 2 timeout 150
```

To disable receive packet debug, enter:

```
awplus# no debug platform packet recv
```

Related Commands [show debugging platform packet](#)
[undebug platform packet](#)

duplex

Overview This command changes the duplex mode for the specified port.

To see the currently-negotiated duplex mode for ports whose links are up, use the command [show interface](#). To see the configured duplex mode (when different from the default), use the command [show running-config](#).

Syntax duplex {auto|full|half}

Parameter	Description
auto	Auto-negotiate duplex mode.
full	Operate in full duplex mode only.
half	Operate in half duplex mode only.

Default By default, ports auto-negotiate duplex mode.

Mode Interface Configuration

Usage Switch ports in a static or dynamic (LACP) channel group must have the same port speed and be in full duplex mode. Once switch ports have been aggregated into a channel group, you can set the duplex mode of all the switch ports in the channel group by applying this command to the channel group.

Examples To specify full duplex for port1.0.4, enter the following commands:

```
awplus# configure terminal
awplus(config)# interface port1.0.4
awplus(config-if)# duplex full
```

To specify half duplex for port1.0.4, enter the following commands:

```
awplus# configure terminal
awplus(config)# interface port1.0.4
awplus(config-if)# duplex half
```

To auto-negotiate duplex mode for port1.0.4, enter the following commands:

```
awplus# configure terminal
awplus(config)# interface port1.0.4
awplus(config-if)# duplex auto
```

**Related
Commands**

- [backpressure](#)
- [polarity](#)
- [speed](#)
- [show interface](#)

flowcontrol (switch port)

Overview Use this command to enable flow control, and configure the flow control mode for the switch port.

Use the **no** variant of this command to disable flow control for the specified switch port.

Syntax `flowcontrol both`
`flowcontrol {send|receive} {off|on}`
`no flowcontrol`

Parameter	Description
<code>both</code>	Use this parameter to specify send and receive flow control for the port.
<code>receive</code>	When the port receives pause frames, it temporarily stops (pauses) sending traffic.
<code>on</code>	Enable the specified flow control.
<code>off</code>	Disable the specified flow control.
<code>send</code>	When the port is congested (receiving too much traffic), it sends pause frames to request the other end to temporarily stop (pause) sending traffic.

Default By default, flow control is disabled.

Mode Interface Configuration

Usage The flow control mechanism specified by 802.3x is only for full duplex links. It operates by sending PAUSE frames to the link partner to temporarily suspend transmission on the link.

Flow control enables connected Ethernet ports to control traffic rates during congestion by allowing congested nodes to pause link operation at the other end. If one port experiences congestion, and cannot receive any more traffic, it notifies the other port to stop sending until the condition clears. When the local device detects congestion at its end, it notifies the remote device by sending a pause frame. On receiving a pause frame, the remote device stops sending data packets, which prevents loss of data packets during the congestion period.

Flow control is not recommended when running QoS or ACLs, because the complex queuing, scheduling, and filtering configured by QoS or ACLs may be slowed by applying flow control.

For half-duplex links, an older form of flow control known as backpressure is supported. See the related [backpressure](#) command.

For flow control on async serial (console) ports, see the [flowcontrol hardware \(async/console\)](#) command.

Examples

```
awplus# configure terminal
awplus(config)# interface port1.0.2
awplus(config-if)# flowcontrol receive on
awplus# configure terminal
awplus(config)# interface port1.0.2
awplus(config-if)# flowcontrol send on
awplus# configure terminal
awplus(config)# interface port1.0.2
awplus(config-if)# flowcontrol receive off
awplus# configure terminal
awplus(config)# interface port1.0.2
awplus(config-if)# flowcontrol send off
```

**Related
Commands**

- [backpressure](#)
- [show running-config](#)

linkflap action

Overview Use this command to detect flapping on all ports. If more than 15 flaps occur in less than 15 seconds the flapping port will shut down.

Use the **no** variant of this command to disable flapping detection at this rate.

Syntax linkflap action [shutdown]
no linkflap action

Parameter	Description
linkflap	Global setting for link flapping.
action	Specify the action for port.
shutdown	Shutdown the port.

Default Linkflap action is disabled by default.

Mode Global Configuration

Example To enable the linkflap action command on the device, use the following commands:

```
awplus# configure terminal  
awplus(config)# linkflap action shutdown
```

mac address-table acquire

Overview Use this command to enable MAC address learning on the device.

Use the **no** variant of this command to disable learning.

Syntax mac address-table acquire
no mac address-table acquire

Default Learning is enabled by default for all instances.

Mode Global Configuration

Example awplus# configure terminal
awplus(config)# mac address-table acquire

mac address-table ageing-time

Overview Use this command to specify an ageing-out time for a learned MAC address. The learned MAC address will persist for at least the specified time.

The **no** variant of this command will reset the ageing-out time back to the default of 300 seconds (5 minutes).

Syntax `mac address-table ageing-time <ageing-timer> none`
`no mac address-table ageing-time`

Parameter	Description
<code><ageing-timer></code>	<code><10-1000000></code> The number of seconds of persistence.
<code>none</code>	Disable learned MAC address timeout.

Default The default ageing time is 300 seconds.

Mode Global Configuration

Examples The following commands specify various ageing timeouts on the device:

```
awplus# configure terminal
awplus(config)# mac address-table ageing-time 1000
awplus# configure terminal
awplus(config)# mac address-table ageing-time none
awplus# configure terminal
awplus(config)# no mac address-table ageing-time
```

mac address-table static

Overview Use this command to statically configure the MAC address-table to forward or discard frames with a matching destination MAC address.

Syntax `mac address-table static <mac-addr> {forward|discard} interface <port> [vlan <vid>]`
`no mac address-table static <mac-addr> {forward|discard} interface <port> [vlan <vid>]`

Parameter	Description
<mac-addr>	The destination MAC address in HHHH . HHHH . HHHH format.
<port>	The port to display information about. The port may be a switch port (e.g. port1.0.4), a static channel group (e.g. sa2), or a dynamic (LACP) channel group (e.g. po2).
<vid>	The VLAN ID. If you do not specify a VLAN, its value defaults to vlan 1.

Mode Global Configuration

Usage The **mac address-table static** command is only applicable to Layer 2 switched traffic within a single VLAN. Do not apply the **mac address-table static** command to Layer 3 switched traffic passing from one VLAN to another VLAN. Frames will not be discarded across VLANs because packets are routed across VLANs. This command only works on Layer 2 traffic.

Example

```
awplus# configure terminal
awplus(config)# mac address-table static 2222.2222.2222 forward
interface port1.0.4 vlan 3
```

Related Commands [clear mac address-table static](#)
[show mac address-table](#)

polarity

Overview This command sets the MDI/MDIX polarity on a copper-based switch port.

Syntax `polarity {auto|mdi|mdix}`

Parameter	Description
mdi	Sets the polarity to MDI (medium dependent interface).
mdix	Sets the polarity to MDI-X (medium dependent interface crossover).
auto	The switch port sets the polarity automatically. This is the default option.

Default By default, switch ports set the polarity automatically (**auto**).

Mode Interface Configuration

Usage We recommend the default **auto** setting for MDI/MDIX polarity. Polarity applies to copper 10BASE-T, 100BASE-T, and 1000BASE-T switch ports; it does not apply to fiber ports. See the “MDI/MDIX Connection Modes” section in the [Switching Feature Overview and Configuration Guide](#) for more information.

Example To set the polarity for `port1.0.6` to fixed MDI mode, use the following commands:

```
awplus# configure terminal
awplus(config)# interface port1.0.6
awplus(config-if)# polarity mdi
```

show debugging platform packet

Overview This command shows platform to CPU level packet debugging information.

Syntax `show debugging platform packet`

Mode User Exec and Privileged Exec

Example To display the platform packet debugging information, use the command:

```
awplus# show debugging platform packet
```

**Related
Commands** [debug platform packet](#)
[undebug platform packet](#)

show flowcontrol interface

Overview Use this command to display flow control information.

Syntax `show flowcontrol interface <port>`

Parameter	Description
<port>	Specifies the name of the port to be displayed.

Mode User Exec and Privileged Exec

Example To display the flow control for the `port1.0.5`, use the command:

```
awplus# show flowcontrol interface port1.0.5
```

Output Figure 15-1: Example output from the **show flowcontrol interface** command for a specific interface

Port	Send admin	FlowControl oper	Receive admin	FlowControl oper	RxPause	TxPause
port1.0.5	on	on	on	on	0	0

show interface err-disabled

Overview Use this command to show the ports which have been dynamically shut down by protocols running on the device and the protocols responsible for the shutdown.

Syntax `show interface [<interface-range> err-disabled]`

Parameter	Description
<code><interface-range></code>	Interface range
<code>err-disabled</code>	Brief summary of interfaces shut down by protocols

Mode User Exec and Privileged Exec

Example To show which protocols have shut down ports, use the commands:

```
awplus# show interface err-disabled
```

show interface switchport

Overview Use this command to show VLAN information about each switch port.

Syntax `show interface switchport`

Mode User Exec and Privileged Exec

Example To display VLAN information about each switch port, enter the command:

```
awplus# show interface switchport
```

Output Figure 15-2: Example output from the **show interface switchport** command

```
Interface name      : port1.0.1
Switchport mode    : access
Ingress filter     : enable
Acceptable frame types : all
Default Vlan       : 2
Configured Vlans   : 2

Interface name      : port1.0.2
Switchport mode    : trunk
Ingress filter     : enable
Acceptable frame types : all
Default Vlan       : 1
Configured Vlans   : 1 4 5 6 7 8
...
```

Related Commands [show interface memory](#)

show mac address-table

Overview Use this command to display the mac address-table for all configured VLANs.

Syntax show mac address-table

Mode User Exec and Privileged Exec

Usage The **show mac address-table** command is only applicable to view a mac address-table for Layer 2 switched traffic within VLANs.

Example To display the mac address-table, use the following command:

```
awplus# show mac address-table
```

Output See the below sample output captured when there was no traffic being switched:

```
awplus#show mac address-table
```

VLAN	Port	MAC	State
1	unknown	0000.cd28.0752	static
ARP	-	0000.cd00.0000	static

See the sample output captured when packets were switched and mac addresses were learned:

```
awplus#show mac address-table
```

VLAN	Port	MAC	State
1	unknown	0000.cd28.0752	static
1	port1.0.6	0030.846e.9bf4	dynamic
1	port1.0.4	0030.846e.bac7	dynamic
ARP	-	0000.cd00.0000	static

Note the new mac addresses learned for port1.0.4 and port1.0.6 added as dynamic entries.

Note the first column of the output below shows VLAN IDs if multiple VLANs are configured:

```
awplus#show mac address-table
```

VLAN	Port	MAC	State
1	unknown	0000.cd28.0752	static
1	port1.0.4	0030.846e.bac7	dynamic
2	unknown	0000.cd28.0752	static
2	port1.0.6	0030.846e.9bf4	dynamic
ARP	-	0000.cd00.0000	static

Also note manually configured static mac-addresses are shown to the right of the type column:

```
awplus(config)#mac address-table static 0000.1111.2222 for int
port1.0.3 vlan 2
awplus(config)#end
awplus#
awplus#show mac address-table
```

VLAN	Port	MAC	State
1	unknown	0000.cd28.0752	static
1	port1.0.2	0030.846e.bac7	dynamic
2	port1.0.3	0000.1111.2222	static
2	unknown	0000.cd28.0752	static
2	port1.0.5	0030.846e.9bf4	dynamic
ARP	-	0000.cd00.0000	static

Related Commands

- [clear mac address-table dynamic](#)
- [clear mac address-table static](#)
- [mac address-table static](#)

show platform

Overview This command displays the settings configured by using the **platform** commands.

Syntax `show platform`

Mode Privileged Exec

Usage This command displays the settings in the running config. For changes in some of these settings to take effect, the device must be rebooted with the new settings in the startup config.

Example To check the settings configured with **platform** commands on the device, use the following command:

```
awplus# show platform
```

Output Figure 15-3: Example output from the **show platform** command

```
awplus#show platform
MAC vlan hashing algorithm    unknown
```

Table 1: Parameters in the output of the **show platform** command

Parameter	Description
MAC vlan hashing algorithm	The MAC VLAN hash-key-generating algorithm. This setting is unused.

show platform port

Overview This command displays the various port registers or platform counters for specified switchports.

Syntax `show platform port [<port-list>|counters]`

Parameter	Description
<code><port-list></code>	The ports to display information about. A port-list can be: <ul style="list-style-type: none">• a continuous range of ports separated by a hyphen, e.g. port1.0.1-1.0.6• a comma-separated list of ports and port ranges, e.g. port1.0.1,port1.0.4-1.0.6.
<code>counters</code>	Show the platform counters.

Mode Privileged Exec

Examples To display port registers for port1.0.1 and port1.0.2 use the following command:

```
awplus# show platform port port1.0.1-port1.0.2
```

To display platform counters for port1.0.1 and port1.0.2 use the following command:

```
awplus# show platform port port1.0.1-port1.0.2 counters
```

Output Figure 15-4: Example output from the **show platform port** command

```
awplus#show platform port port1.0.1
Phy register value for port1.0.1 (ifindex: 5001)

00:1140 01:7949 02:0362 03:5e14 04:01e1 05:0000 06:0064 07:2001
08:0000 09:0600 0a:0000 0b:0000 0c:0000 0d:4007 0e:0000 0f:3000
10:0020 11:0000 12:0000 13:0000 14:0000 15:0000 16:0000 17:0000
18:7277 19:1000 1a:0000 1b:ffff 1c:6cc7 1d:0000 1e:0000 1f:0000
sfp phy
00:1140 01:7949 02:0362 03:5e14 04:01e1 05:0000 06:0064 07:2001
08:0000 09:0600 0a:0000 0b:0000 0c:0000 0d:4007 0e:0000 0f:3000
10:0020 11:0000 12:0000 13:0000 14:0000 15:0000 16:0000 17:0000
18:7277 19:1000 1a:0000 1b:ffff 1c:6cc7 1d:0000 1e:0000 1f:0000

Port configuration for lport 0x08000000:
Phy Driver: 54680 Gigabit PHY Driver
enabled: 1
loopback: 0
link: 0
speed: 0 max speed: 1000
duplex: 0
linkscan: 1
autonegotiate: 1
master: 2
tx pause: 0 rx pause: 0
untagged vlan: 1
vlan filter: 1
stp state: 1
learn: 5
discard: 0
jam: 0
max frame size: 1518
MC Disable SA: no
MC Disable TTL: no
MC egress untag: 0
MC egress vid: 0
MC TTL threshold: 0
```

Table 2: Parameters in the output from the **show platform port** command

Parameter	Description
Ethernet MAC counters	
Combined receive/transmit packets by size (octets) counters	Number of packets in each size range received and transmitted.
64	Number of 64 octet packets received and transmitted.
65 - 127	Number of 65 - 127 octet packets received and transmitted.

Table 2: Parameters in the output from the **show platform port** command

Parameter	Description
128 - 255	Number of 128 - 255 octet packets received and transmitted.
256 - 511	Number of 256 - 511 octet packets received and transmitted.
512 - 1023	Number of 512 - 1023 octet packets received and transmitted.
1024 - MaxPktSz	Number of packets received and transmitted with size 1024 octets to the maximum packet length.
1519 - 1522	Number of 1519 - 1522 octet packets received and transmitted.
1519 - 2047	Number of 1519 - 2047 octet packets received and transmitted.
2048 - 4095	Number of 2048 - 4095 octet packets received and transmitted.
4096 - 9216	Number of 4096 - 9216 octet packets received and transmitted.
General Counters	
Receive	Counters for traffic received.
Octets	Number of octets received.
Pkts	Number of packets received.
FCSErrors	Number of FCS (Frame Check Sequence) error events received.
UnicastPkts	Number of unicast packets received.
MulticastPkts	Number of multicast packets received.
BroadcastPkts	Number of broadcast packets received.
PauseMACCtlFrms	Number of Pause MAC Control Frames received.
OversizePkts	Number of oversize packets received.
Fragments	Number of fragments received.
Jabbers	Number of jabber frames received.
UnsupportOpcode	Number of MAC Control frames with unsupported opcode received.
AlignmentErrors	Receive Alignment Error Frame Counter.

Table 2: Parameters in the output from the **show platform port** command

Parameter	Description
SysErDurCarrier	Receive Code Error Counter.
CarrierSenseErr	Receive False Carrier Counter.
UndersizePkts	Number of undersized packets received.
Transmit	Counters for traffic transmitted.
Octets	Number of octets transmitted.
Pkts	Number of packets transmitted.
UnicastPkts	Number of unicast packets transmitted.
MulticastPkts	Number of multicast packets transmitted.
BroadcastPkts	Number of broadcast packets transmitted.
PauseMACCtlFrms	Number of Pause MAC Control Frames transmitted.
OversizePkts	Number of oversize packets transmitted.
FrameWDeferrdTx	Transmit Single Deferral Frame counter.
FrmWExcesDefer	Transmit Multiple Deferral Frame counter.
SingleCollsnFrm	Transmit Single Collision Frame counter.
MultCollsnFrm	Transmit Multiple Collision Frame counter.
LateCollisions	Transmit Late Collision Frame counter.
ExcessivCollsns	Transmit Excessive Collision Frame counter.
Collisions	Transmit Total Collision counter
Layer 3 Counters	
ifInUcastPkts	Inbound interface Unicast counter.
ifInDiscards	Inbound interface Discarded Packets counter.
ipInHdrErrors	Inbound interface Header Errors counter.
ifOutUcastPkts	Outbound interface Unicast counter.
ifOutErrors	Outbound interface Error counter.
Miscellaneous Counters	
DropEvents	Drop Event counter

Table 2: Parameters in the output from the **show platform port** command

Parameter	Description
ifOutDiscards	Outbound interface Discarded Packets counter.
MTUExcdDiscard	Receive MTU Check Error Frame Counter

show storm-control

Overview Use this command to display storm-control information for all interfaces or a particular interface.

Syntax `show storm-control [<port>]`

Parameter	Description
<code><port></code>	The port to display information about. The port may be a switch port (e.g. port1.0.4), a static channel group (e.g. sa2), or a dynamic (LACP) channel group (e.g. po2).

Mode User Exec and Privileged Exec

Example To display storm-control information for port1.0.2, use the following command:

```
awplus# show storm-control port1.0.2
```

Output Figure 15-5: Example output from the **show storm-control** command for port1.0.2

Port	BcastLevel	McastLevel	DlfLevel
port1.0.2	40.0%	100.0%	100.0%

Related Commands [storm-control level](#)

speed

Overview This command changes the speed of the specified port. You can optionally specify the speed or speeds that get autonegotiated, so autonegotiation is only attempted at the specified speeds.

To see the currently-negotiated speed for ports whose links are up, use the [show interface](#) command. To see the configured speed (when different from the default), use the [show running-config](#) command.

Syntax `speed {10|100|1000}`
`speed auto [10] [100] [1000]`

The following table shows the speed options for each type of port.

Port type	Speed Options (units are Mbps)
RJ-45 copper ports	auto (default) 10 100 1000

Mode Interface Configuration

Default By default, ports autonegotiate speed.

Usage Switch ports in a static or dynamic (LACP) channel group must have the same port speed and be in full duplex mode. Once switch ports have been aggregated into a channel group, you can set the speed of all the switch ports in the channel group by applying this command to the channel group.

NOTE: *If multiple speeds are specified after the auto option to autonegotiate speeds, then the device only attempts autonegotiation at those specified speeds.*

Examples To set the speed of a tri-speed port to 100Mbps, enter the following commands:

```
awplus# configure terminal
awplus(config)# interface port1.0.2
awplus(config-if)# speed 100
```

To return the port to auto-negotiating its speed, enter the following commands:

```
awplus# configure terminal
awplus(config)# interface port1.0.2
awplus(config-if)# speed auto
```

To set the port to auto-negotiate its speed at 100Mbps and 1000Mbps, enter the following commands:

```
awplus# configure terminal
awplus(config)# interface port1.0.2
awplus(config-if)# speed auto 100 1000
```

To set the port to auto-negotiate its speed at 1000Mbps only, enter the following commands:

```
awplus# configure terminal
awplus(config)# interface port1.0.2
awplus(config-if)# speed auto 1000
```

**Related
Commands**

[duplex](#)

[polarity](#)

[show interface](#)

[speed \(asyn\)](#)

storm-control level

Overview Use this command to specify the speed limiting level for broadcasting, multicast, or destination lookup failure (DLF) traffic for the port. Storm-control limits the selected traffic type to the specified percentage of the maximum port speed.

Use the **no** variant of this command to disable storm-control for broadcast, multicast or DLF traffic.

Syntax `storm-control {broadcast|multicast|dlf} level <level>`
`no storm-control {broadcast|multicast|dlf} level`

Parameter	Description
<level>	<0-100> Specifies the percentage of the maximum port speed allowed for broadcast, multicast or destination lookup failure traffic.
broadcast	Applies the storm-control to broadcast frames.
multicast	Applies the storm-control to multicast frames.
dlf	Applies the storm-control to destination lookup failure traffic.

Default By default, storm-control is disabled.

Mode Interface Configuration

Usage Flooding techniques are used to block the forwarding of unnecessary flooded traffic. A packet storm occurs when a large number of broadcast packets are received on a port. Forwarding these packets can cause the network to slow down or time out.

Example To limit broadcast traffic on port1.0.2 to 30% of the maximum port speed, use the following commands:

```
awplus# configure terminal
awplus(config)# interface port1.0.2
awplus(config-if)# storm-control broadcast level 30
```

Related Commands [show storm-control](#)

undebbug platform packet

Overview This command applies the functionality of the no `debug platform packet` command.

16

Bridging Commands

Introduction

Overview This chapter provides an alphabetical reference of commands used to configure bridging. For more information, see the [Bridging Commands Feature Overview and Configuration Guide](#).

- Command List**
- [“ageing-time”](#) on page 482
 - [“bridge”](#) on page 483
 - [“bridge-group”](#) on page 484
 - [“clear mac-filter”](#) on page 485
 - [“l3-filtering enable”](#) on page 486
 - [“mac-filter”](#) on page 487
 - [“mac-filter-group”](#) on page 488
 - [“mac-learning”](#) on page 489
 - [“rule \(MAC Filter\)”](#) on page 490
 - [“show bridge”](#) on page 492
 - [“show bridge macaddr”](#) on page 494
 - [“show mac-filter”](#) on page 495

ageing-time

Overview This command specifies the time period that a learned MAC address will remain defined within the bridge's MAC address table.

Use the **no** variant of this command to set the ageing out time back to the default.

Syntax ageing-time <10-1000000>
no ageing-time

Parameter	Description
<10-1000000>	The number of seconds that the MAC addresses will remain in the table.

Default 300 seconds (5 minutes)

Mode Interface Configuration

Examples To change the ageing time on br2 to 60 seconds (1 minute), use the following commands:

```
awplus#configure terminal
awplus(config)#interface br2
awplus(config-if)#ageing-time 60
```

To reset the ageing time back to its default, use the following commands:

```
awplus#configure terminal
awplus(config-if)#no ageing-time
```

To reset the ageing time back to its default, you can also use the following commands:

```
awplus#configure terminal
awplus(config-if)#ageing-time 300
```

Output None

Related Commands [bridge](#)
[bridge-group](#)
[show bridge](#)
[show bridge macaddr](#)

bridge

Overview Use this command to create a software bridge.
Use the **no** variant of this command to remove the specified bridge.

Syntax `bridge [<bridge-id>]`
`no bridge [<bridge-id>]`

Parameter	Description
<bridge-id>	The bridge ID (from 1 to 64). This is made up of the bridge priority and the bridge's MAC address.

Default No configured bridges

Mode Global Configuration

Usage The bridge interface name will be prefixed with 'br' followed by the bridge ID.
*If interfaces exist on a bridge, then the bridge cannot be removed. For example if interface eth1 exists on bridge 2, then the **no bridge 2** command will give you the following message:*

```
% failed to remove interface br2, there are still configured sub-interfaces.
```

Example To create a bridge with the ID of 2, use the following commands:

```
awplus#configure terminal  
awplus(config)#bridge 2
```

To remove the bridge with the ID of 2, use the following commands:

```
awplus#configure terminal  
awplus(config)##no bridge 2
```

Related Commands

- [ageing-time](#)
- [bridge-group](#)
- [show bridge](#)
- [show bridge macaddr](#)

bridge-group

Overview Use this command to add an interface to a bridge.
Use the **no** variant of this command to remove an interface from a bridge.

Syntax `bridge-group <1-64>`
`no bridge-group`

Parameter	Description
<1-64>	The ID of the bridge that you are adding the interface to.

Default An interface is not part of any bridge by default.

Mode Interface configuration.

Usage Interfaces can only be part of one bridge, so when removing the bridge no parameters are required.

Interfaces that have been added to a bridge will lose their Layer 3 properties. The bridge will act as the Layer 3 interface. The bridge will provide Layer 2 connectivity between interfaces that are a part of the bridge.

You can only add eth, VLAN, OpenVPN (TAP only), and L2TPv3 ethernet pseudowire interfaces to your bridge.

Examples To add eth1 to bridge 2, use the following commands:

```
awplus#configure terminal
awplus(config)#interface eth1
awplus(config-if)#bridge-group 2
```

To remove eth1 from your bridge, use the following commands:

```
awplus#configure terminal
awplus(config)#interface eth1
awplus(config-if)#bridge-group
```

Related Commands

- [ageing-time](#)
- [bridge](#)
- [show bridge](#)
- [show bridge macaddr](#)

clear mac-filter

Overview This command clears all the mac-filter counters on a bridge.

Syntax `clear mac-filter counter bridge <bridge-id>`

Parameter	Description
<code><bridge-id></code>	The bridge ID (from 1 to 64).

Default None

Mode Privileged Exec

Examples To clear the mac-filter counters on bridge 1, use the following commands:

```
awplus#clear mac-filter counter bridge 1
```

Output Figure 16-1: Example output from the **clear mac-filter bridge** command displaying information about all rules:

```
Clears filter counters on bridge interface br1
```

Related Commands

- [mac-filter](#)
- [mac-filter-group](#)
- [show mac-filter](#)

I3-filtering enable

Overview Use this command to enable traffic control for bridged traffic on a bridge interface.

Use the **no** variant of this command to disable traffic control for bridged traffic on a bridge interface.

Syntax l3-filtering enable
no l3-filtering enable

Default Traffic control is disabled by default for bridged traffic.

Mode Interface mode for a bridge interface

Usage We do not recommend shaping bridged traffic on firewalls that are running Unified Threat Management (UTM) features, because both Traffic Control and UTM require significant CPU resources.

Example To enable traffic control for bridged traffic on br1, use the commands:

```
awplus# configure terminal
awplus(config)# interface br1
awplus(config-if)# l3-filtering enable
```

**Related
Commands** [traffic-control](#)

**Command
changes** Version 5.4.7-0.1: command added. Previously, traffic control was enabled by default on all bridge interfaces.

mac-filter

Overview This command creates a Layer 2 MAC filter that can be applied on a bridge. Use the **no** variant of this command to remove the MAC filter.

Syntax `mac-filter [<mac-filter-name>]`
`no mac-filter [<mac-filter-name>]`

Parameter	Description
<mac-filter-name>	The name of the mac-filter (maximum of 16 characters).

Default None

Mode Interface Configuration

Usage You can only create one MAC filter at one time.

Examples To create a mac-filter with the name of ATL-router1, use the following commands:

```
awplus#configure terminal  
awplus(config)#mac-filter ATL-router1
```

To delete a mac-filter, use the following commands:

```
awplus#configure terminal  
awplus(config)#no mac-filter ATL-router1
```

Output None

**Related
Commands** [clear mac-filter](#)
[mac-filter-group](#)
[show mac-filter](#)

mac-filter-group

Overview This command applies a Layer two MAC filter on a bridge.
Use the **no** variant of this command to remove the mac-filter on a bridge.

Syntax `mac-filter-group [<mac-filter-name>]`
`no mac-filter-group`

Parameter	Description
<code><mac-filter-name></code>	The name of the mac-filter (maximum 16 characters).

Default None

Mode Interface Configuration

Usage You can only apply one MAC filter at one time.

Examples To apply a mac-filter with the name of ATL-router1 on bridge interface br1, use the following commands:

```
awplus#configure terminal
awplus(config)#interface br1
awplus(config-if)#mac-filter-group ATL-router1
```

To remove the mac-filter on a bridge, use the following commands:

```
awplus#configure terminal
awplus(config)#interface br1
awplus(config-if)#no mac-filter-group
```

Output Figure 16-2: Example output from the **mac-filter-group** command displaying information about all bridges:

```
mac-filter "ATL-router1" will be applied to the bridge interface
br1
```

**Related
Commands**

- [clear mac-filter](#)
- [mac-filter](#)
- [show mac-filter](#)

mac-learning

Overview Use this command to enable FDB MAC address learning on a bridge interface. In some circumstances, FDB MAC address learning on a software-based router bridge is not useful, and it is better to flood the traffic within interfaces associated with the bridge instance, to ensure the traffic reaches its destination.

Use the **no** variant of this command to disable or enable FDB MAC address learning on a bridge.

Syntax `mac-learning`
`no mac-learning`

Default Learning is enabled by default.

Mode Interface mode for a bridge interface

Example To turn off learning on bridge 2, use the following commands:

```
awplus# configure terminal
awplus(config)# interface br2
awplus(config-if)# no mac-learning
```

To turn learning on bridge 2 back on, use the following commands:

```
awplus# configure terminal
awplus(config)# interface br2
awplus(config-if)# mac-learning
```

Command changes Version 5.4.7-0.1: command added

rule (MAC Filter)

Syntax This command adds a filter rule to a mac-filter. You can also add further rules to rules that you have already specified.

Use the **no** variant of this command to remove a rule.

Syntax `rule <rule-name> {deny|permit} [dmac {<MAC>|any}] [smac {<MAC>|any}] [proto {<rule-name>|any}] [{after|before} rule <rule-name>]`

`no rule <rule-name>`

Parameter	Description
<rule-name>	The name of the rule (maximum 16 characters).
deny	Drop the matched frame.
permit	Allow the matched frame.
dmac	Destination MAC address.
<MAC>	MAC address in HHHH.HHHH.HHHH format.
any	any MAC address.
smac	Source MAC address.
proto	Ethernet protocol type.
after	Insert a rule before an existing rule.
before	Insert a rule after an existing rule.
rule	MAC filter rule.

Default No rule

Mode MAC Filter Mode

Examples To add a rule called PC1 to a mac-filter-group called ATL-router1, use the following commands:

```
awplus#configure terminal
awplus(config)#mac-filter ATL-router1
awplus(config-macfilter)#rule PC1 permit dmac any smac
00c4.6d20.c0f4 proto any
```

To reset a mac-filter back to its default, use the following commands:

```
awplus#configure terminal
awplus(config)#mac-filter ATL-router1
awplus(config-macfilter)#no rule PC1
```

Output Figure 16-3: Example output from the **rule** command displaying information about all rules:

```
rule "PC1" will be added to the specified mac-filter.
```

**Related
Commands**

- clear mac-filter
- mac-filter
- mac-filter-group
- show mac-filter

show bridge

Syntax Use this command to display detailed information about your bridge(s).

Syntax `show bridge [<bridge-list>]`

Parameter	Description
<bridge-list>	The bridge/s to display the information about. The <bridge-list> can be: <ul style="list-style-type: none">• a single bridge(e.g. br2)• a continuous range of bridges (e.g. br1-3)• a comma separated list of bridges and/or ranges (e.g. br1,br2,br3-br5)

Default Displays detailed information about all bridges, if no <bridge-list> is specified.

Mode Privileged Exec

Examples To display information about all bridges, use the following command:

```
awplus#show bridge
```

To display information about bridge 2, use the following command:

```
awplus#show bridge br2
```

To display information about bridge in the range 1 to 3, use the following command:

```
awplus#show bridge br1-3
```

To display information about bridges 1, and from 3 to 5, use the following command:

```
awplus#show bridge br1,br3-5
```

Output Figure 16-4: Example output from the **show bridge** command displaying information about all bridges:

```
awplus#show bridge
```

Bridge Name	Aging Timer	Interfaces
br1	300	eth1
br2	300	vlan1 eth2
br3	300	
br4	300	
br5	300	

Figure 16-5: Example output from the **show bridge** command displaying information about bridge 2.

```
awplus#show bridge br2
Bridge Name      Aging Timer      Interfaces
-----
br2              300              vlan1
                  eth2
```

**Related
Commands**

- [ageing-time](#)
- [bridge](#)
- [bridge-group](#)
- [show bridge macaddr](#)

show bridge macaddr

Overview Use this command to display the MAC entries learned in the MAC table for your bridge.

Syntax `show bridge macaddr <bridge-list>`

Parameter	Description
<code><bridge-list></code>	The bridge interfaces to display the information about. The <code><bridge-list></code> can be: <ul style="list-style-type: none">• a single bridge (e.g. br2)• a continuous range of bridges (e.g. br1-3)• a comma separated list of bridges and/or ranges (e.g. br1,br2,br3-br5)

Mode Global Configuration

Example To display the learned MAC entries for bridge 2, use the following commands:

```
awplus#configure terminal
awplus(config)#show bridge macaddr br2
```

Output Figure 16-6: Example output from the **show bridge macaddr** command displaying information about bridge 2:

```
awplus#show bridge macaddr br2
```

Bridge Name	Interface	mac addr	is local?	ageing
br2	vlan10	ec:cd:6d:20:c0:fb	no	41
br2	vlan50	00:c4:6d:20:c0:e6	no	0
br2	vlan50	00:c4:6d:20:c0:e7	no	1
br2	vlan50	00:c4:6d:20:c0:e8	no	2
br2	vlan50	00:c4:6d:20:c0:f2	no	12
br2	vlan50	00:c4:6d:20:c0:f3	no	13
br2	vlan50	00:c4:6d:20:c0:f4	no	14
br2	vlan50	ec:cd:6d:20:c0:bd	yes	0
br2	vlan50	ec:cd:6d:48:e4:72	no	41

Related Commands

- [ageing-time](#)
- [bridge](#)
- [bridge-group](#)
- [show bridge](#)

show mac-filter

Overview This command displays all hit counters for all MAC filter rules applied to a bridge.

Syntax `show mac-filter [bridge <bridge-id>]`

Parameter	Description
<bridge-id>	The bridge ID (from 1 to 16).

Default Displays all counters for all mac-filters on a bridge

Mode Privileged Exec Mode

Examples To display all mac-filter bridge counters, use the following commands:

```
awplus#show mac-filter
```

To display mac-filter bridge counters for bridge 2, use the following commands:

```
awplus#show mac-filter bridge 2
```

Output Figure 16-7: Example output from the **show mac-filter bridge** command displaying information about all rules:

```
awplus#show mac-filter
```

Bridge	Rule	DMAC	SMAC	Pkt Count	Byte Count
br1	DENY_1	any	0000.1111.2222	112	148312
br1	DENY_2	aabb.ccdd.eeff	1234.5678.9123	30	40462
br1	PERMIT	any	any	2261	3364302
br2	BROADCAST	ffff.ffff.ffff	any	54	6653
br2	DENY_IPv6	any	any	1057	972605
br2	DENY_USER	any	aabb.ccdd.eeff	365	447433
br2	PERMIT	any	any	32581	36648579

Related Commands [mac-filter](#)
[mac-filter-group](#)

17

VLAN Commands

Introduction

Overview This chapter provides an alphabetical reference of commands used to configure VLANs. For more information see the [VLAN Feature Overview and Configuration Guide](#).

- Command List**
- [“show vlan”](#) on page 497
 - [“switchport access vlan”](#) on page 498
 - [“switchport mode access”](#) on page 499
 - [“switchport mode trunk”](#) on page 500
 - [“switchport trunk allowed vlan”](#) on page 501
 - [“switchport trunk native vlan”](#) on page 504
 - [“vlan”](#) on page 505
 - [“vlan database”](#) on page 506

show vlan

Overview Use this command to display information about a particular VLAN by specifying its VLAN ID. Selecting **all** will display information for all the VLANs configured.

Syntax `show vlan`
`{all|brief|dynamic|static|auto|static-ports|<1-4094>}`

Parameter	Description
<1-4094>	Display information about the VLAN specified by the VLAN ID.
all	Display information about all VLANs on the device.
brief	Display information about all VLANs on the device.
dynamic	Display information about all VLANs learned dynamically.
static	Display information about all statically configured VLANs.
auto	Display information about all auto-configured VLANs.
static-ports	Display static egress/forbidden ports.

Mode User Exec and Privileged Exec

Example To display information about VLAN 2, use the command:

```
awplus# show vlan 2
```

Output Figure 17-1: Example output from the **show vlan** command

VLAN ID	Name	Type	State	Member ports
				(u)-Untagged, (t)-Tagged
2	VLAN0002	STATIC	ACTIVE	port1.0.3(u) port1.0.4(u) port1.0.5(u) port1.0.6(u)
...				

Related Commands [vlan](#)

switchport access vlan

Overview Use this command to change the port-based VLAN of the current port.
Use the **no** variant of this command to change the port-based VLAN of this port to the default VLAN, vlan1.

Syntax `switchport access vlan <vlan-id>`
`no switchport access vlan`

Parameter	Description
<vlan-id>	<1-4094> The port-based VLAN ID for the port.

Default Reset the default VLAN 1 to specified switchports using the negated form of this command.

Mode Interface Configuration

Usage Any untagged frame received on this port will be associated with the specified VLAN.

Examples To change the port-based VLAN to VLAN 3 for port1.0.2, use the commands:

```
awplus# configure terminal
awplus(config)# interface port1.0.2
awplus(config-if)# switchport access vlan 3
```

To reset the port-based VLAN to the default VLAN 1 for port1.0.2, use the commands:

```
awplus# configure terminal
awplus(config)# interface port1.0.2
awplus(config-if)# no switchport access vlan
```

Related Commands [show interface switchport](#)
[show vlan](#)

switchport mode access

Overview Use this command to set the switching characteristics of the port to access mode. Received frames are classified based on the VLAN characteristics, then accepted or discarded based on the specified filtering criteria.

Syntax `switchport mode access [ingress-filter {enable|disable}]`

Parameter	Description
<code>ingress-filter</code>	Set the ingress filtering for the received frames.
<code>enable</code>	Turn on ingress filtering for received frames. This is the default.
<code>disable</code>	Turn off ingress filtering to accept frames that do not meet the classification criteria.

Default By default, ports are in access mode with ingress filtering on.

Usage Use access mode to send untagged frames only.

Mode Interface Configuration

Example

```
awplus# configure terminal
awplus(config)# interface port1.0.2
awplus(config-if)# switchport mode access ingress-filter enable
```

Validation Command `show interface switchport`

switchport mode trunk

Overview Use this command to set the switching characteristics of the port to trunk. Received frames are classified based on the VLAN characteristics, then accepted or discarded based on the specified filtering criteria.

Syntax `switchport mode trunk [ingress-filter {enable|disable}]`

Parameter	Description
<code>ingress-filter</code>	Set the ingress filtering for the frames received.
<code>enable</code>	Turn on ingress filtering for received frames. This is the default.
<code>disable</code>	Turn off ingress filtering to accept frames that do not meet the classification criteria.

Default By default, ports are in access mode, are untagged members of the default VLAN (vlan1), and have ingress filtering on.

Mode Interface Configuration

Usage A port in trunk mode can be a tagged member of multiple VLANs, and an untagged member of one native VLAN.

To configure which VLANs this port will trunk for, use the [switchport trunk allowed vlan](#) command.

Example

```
awplus# configure terminal
awplus(config)# interface port1.0.3
awplus(config-if)# switchport mode trunk ingress-filter enable
```

Validation Command [show interface switchport](#)

switchport trunk allowed vlan

Overview Use this command to add VLANs to be trunked over this switch port. Traffic for these VLANs can be sent and received on the port.

Use the **no** variant of this command to reset switching characteristics of a specified interface to negate a trunked configuration specified with **switchport trunk allowed vlan** command.

Syntax

```
switchport trunk allowed vlan all
switchport trunk allowed vlan none
switchport trunk allowed vlan add <vid-list>
switchport trunk allowed vlan remove <vid-list>
switchport trunk allowed vlan except <vid-list>
no switchport trunk
```

Parameter	Description
all	Allow all VLANs to transmit and receive through the port.
none	Allow no VLANs to transmit and receive through the port.
add	Add a VLAN to the list of VLANs that are allowed to transmit and receive through the port. Only use this parameter if a list of VLANs is already configured on a port.
remove	Remove a VLAN from the list of VLANs that are allowed to transmit and receive through the port. Only use this parameter if a list of VLANs is already configured on a port. If you are removing VLAN port membership for a large number of switchports and VLANs, note that this command may take a number of minutes to run.
except	All VLANs, except the VLAN for which the VID is specified, are part of its port member set. Only use this parameter to remove VLANs after either this parameter or the all parameter have added VLANs to a port.
<vid-list>	<2-4094> The ID of the VLAN or VLANs that will be added to, or removed from, the port. A single VLAN, VLAN range, or comma-separated VLAN list can be set. For a VLAN range, specify two VLAN numbers: lowest, then highest number in the range, separated by a hyphen. For a VLAN list, specify the VLAN numbers separated by commas. Do not enter spaces between hyphens or commas when setting parameters for VLAN ranges or lists.

Default By default, ports are untagged members of the default VLAN (vlan1).

Mode Interface Configuration

Usage The **all** parameter sets the port to be a tagged member of all the VLANs configured on the device. The **none** parameter removes all VLANs from the port's tagged member set. The **add** and **remove** parameters will add and remove VLANs to and from the port's member set. The **except** parameter creates an exception to the list.

If you use the **all** parameter, and then you want to remove VLANs from the port's member list, you must use the **except** parameter to remove the unwanted VLANs. Similarly, if you use the **except** parameter to remove a list of VLANs, and you want to change that list, you must use the **except** parameter to make that change (not the **add** and **remove** parameters).

For example, if you want to remove VLAN3-5 from a port and the port's configuration is currently **switchport trunk allowed vlan all**, then you should remove VLAN3-5 by entering the **except** parameter, instead of using the **remove** parameter. This means using the following commands:

```
awplus# configure terminal
awplus(config)# interface port1.0.6
awplus(config-if)# switchport trunk allowed vlan except 3-5
```

If you do this, then the configuration changes to:

```
awplus#show running-config

interface port1.0.6
switchport
switchport mode trunk
switchport trunk allowed vlan except 3-5
```

For example, if you want to add VLAN4 back in again, and the port configuration is currently **switchport trunk allowed vlan except 3-5**, then you should add VLAN4 by re-entering the **except** parameter with the list of VLANs to remove, instead of using the **add** parameter. This means using the following commands:

```
awplus# configure terminal
awplus(config)# interface port1.0.5
awplus(config-if)# switchport trunk allowed vlan except 3,5
```

If you do this, then the configuration changes to:

```
awplus#show running-config

interface port1.0.5
switchport
switchport mode trunk
switchport trunk allowed vlan except 3,5
```

Examples The following shows adding a single VLAN to the port's member set.

```
awplus# configure terminal
awplus(config)# interface port1.0.2
awplus(config-if)# switchport trunk allowed vlan add 2
```

The following shows adding a range of VLANs to the port's member set.

```
awplus# configure terminal
awplus(config)# interface port1.0.2
awplus(config-if)# switchport trunk allowed vlan add 2-4
```

The following shows adding a list of VLANs to the port's member set.

```
awplus# configure terminal
awplus(config)# interface port1.0.2
awplus(config-if)# switchport trunk allowed vlan add 2,3,4
```

switchport trunk native vlan

Overview Use this command to configure the native VLAN for this port. The native VLAN is used for classifying the incoming untagged packets. Use the **none** parameter with this command to remove the native VLAN from the port and set the acceptable frame types to vlan-tagged only.

Use the **no** variant of this command to revert the native VLAN to the default VLAN ID 1. Command negation removes tagged VLANs, and sets the native VLAN to the default VLAN.

Syntax `switchport trunk native vlan {<vid>|none}`
`no switchport trunk native vlan`

Parameter	Description
<vid>	The ID of the VLAN that will be used to classify the incoming untagged packets, in the range 2-2094. The VLAN ID must be a part of the VLAN member set of the port.
none	No native VLAN specified. This option removes the native VLAN from the port and sets the acceptable frame types to vlan-tagged only. Note: Use the no variant of this command to revert to the default VLAN 1 as the native VLAN for the specified interface switchport - not none .

Default VLAN 1 (the default VLAN), which is reverted to using the **no** form of this command.

Mode Interface Configuration

Examples The following commands show configuration of VLAN 2 as the native VLAN for port1.0.2:

```
awplus# configure terminal
awplus(config)# interface port1.0.2
awplus(config-if)# switchport trunk native vlan 2
```

The following commands show the removal of the native VLAN for interface port1.0.2:

```
awplus# configure terminal
awplus(config)# interface port1.0.2
awplus(config-if)# switchport trunk native vlan none
```

The following commands revert the native VLAN to the default VLAN 1 for interface port1.0.2:

```
awplus# configure terminal
awplus(config)# interface port1.0.2
awplus(config-if)# no switchport trunk native vlan
```

vlan

Overview This command creates VLANs, assigns names to them, and enables or disables them. Disabling the VLAN causes all forwarding over the specified VLAN ID to cease. Enabling the VLAN allows forwarding of frames on the specified VLAN.

The **no** variant of this command destroys the specified VLANs or returns their MTU to the default.

Syntax

```
vlan <vid> [name <vlan-name>] [state {enable|disable}]
vlan <vid-range> [state {enable|disable}]
vlan {<vid>|<vlan-name>} [mtu <mtu-value>]
no vlan {<vid>|<vid-range>} [mtu]
```

Parameter	Description
<vid>	The VID of the VLAN to enable or disable, in the range 1-4094.
<vlan-name>	The ASCII name of the VLAN. Maximum length: 32 characters.
<vid-range>	Specifies a range of VLAN identifiers.
<mtu-value>	Specifies the Maximum Transmission Unit (MTU) size in bytes, in the range 68 to 1500 bytes, for the VLAN.
enable	Puts the VLAN into an enabled state.
disable	Puts the VLAN into a disabled state.

Default By default, VLANs are enabled when they are created.

Mode VLAN Configuration

Examples To enable vlan 45, use the commands:

```
awplus# configure terminal
awplus(config)# vlan database
awplus(config-vlan)# vlan 45 name accounts state enable
```

To destroy vlan 45, use the commands:

```
awplus# configure terminal
awplus(config)# vlan database
awplus(config-vlan)# no vlan 45
```

Related Commands

- [mtu](#)
- [vlan database](#)
- [show vlan](#)

vlan database

Overview Use this command to enter the VLAN Configuration mode.

Syntax `vlan database`

Mode Global Configuration

Usage Use this command to enter the VLAN configuration mode. You can then add or delete a VLAN, or modify its values.

Example In the following example, note the change to VLAN configuration mode from Configure mode:

```
awplus# configure terminal
awplus(config)# vlan database
awplus(config-vlan)#
```

**Related
Commands** [vlan](#)

18

Spanning Tree Commands

Introduction

Overview This chapter provides an alphabetical reference for commands used to configure RSTP, STP or MSTP. For information about spanning trees, including configuration procedures, see the [STP Feature Overview and Configuration Guide](#).

- Command List**
- [“clear spanning-tree statistics”](#) on page 509
 - [“clear spanning-tree detected protocols \(RSTP and MSTP\)”](#) on page 510
 - [“debug mstp \(RSTP and STP\)”](#) on page 511
 - [“instance priority \(MSTP\)”](#) on page 515
 - [“instance vlan \(MSTP\)”](#) on page 517
 - [“region \(MSTP\)”](#) on page 519
 - [“revision \(MSTP\)”](#) on page 520
 - [“show debugging mstp”](#) on page 521
 - [“show spanning-tree”](#) on page 522
 - [“show spanning-tree brief”](#) on page 525
 - [“show spanning-tree mst”](#) on page 526
 - [“show spanning-tree mst config”](#) on page 527
 - [“show spanning-tree mst detail”](#) on page 528
 - [“show spanning-tree mst detail interface”](#) on page 530
 - [“show spanning-tree mst instance”](#) on page 532
 - [“show spanning-tree mst instance interface”](#) on page 533
 - [“show spanning-tree mst interface”](#) on page 534
 - [“show spanning-tree mst detail interface”](#) on page 535
 - [“show spanning-tree statistics”](#) on page 537

- [“show spanning-tree statistics instance”](#) on page 539
- [“show spanning-tree statistics instance interface”](#) on page 540
- [“show spanning-tree statistics interface”](#) on page 542
- [“show spanning-tree vlan range-index”](#) on page 544
- [“spanning-tree autoedge \(RSTP and MSTP\)”](#) on page 545
- [“spanning-tree cisco-interopability \(MSTP\)”](#) on page 546
- [“spanning-tree edgeport \(RSTP and MSTP\)”](#) on page 547
- [“spanning-tree enable”](#) on page 548
- [“spanning-tree errdisable-timeout enable”](#) on page 550
- [“spanning-tree errdisable-timeout interval”](#) on page 551
- [“spanning-tree force-version”](#) on page 552
- [“spanning-tree forward-time”](#) on page 553
- [“spanning-tree guard root”](#) on page 554
- [“spanning-tree hello-time”](#) on page 555
- [“spanning-tree link-type”](#) on page 556
- [“spanning-tree max-age”](#) on page 557
- [“spanning-tree max-hops \(MSTP\)”](#) on page 558
- [“spanning-tree mode”](#) on page 559
- [“spanning-tree mst configuration”](#) on page 560
- [“spanning-tree mst instance”](#) on page 561
- [“spanning-tree mst instance path-cost”](#) on page 562
- [“spanning-tree mst instance priority”](#) on page 564
- [“spanning-tree mst instance restricted-role”](#) on page 565
- [“spanning-tree mst instance restricted-tcn”](#) on page 567
- [“spanning-tree path-cost”](#) on page 568
- [“spanning-tree portfast \(STP\)”](#) on page 569
- [“spanning-tree portfast bpdu-filter”](#) on page 571
- [“spanning-tree portfast bpdu-guard”](#) on page 573
- [“spanning-tree priority \(bridge priority\)”](#) on page 575
- [“spanning-tree priority \(port priority\)”](#) on page 576
- [“spanning-tree restricted-role”](#) on page 577
- [“spanning-tree restricted-tcn”](#) on page 578
- [“spanning-tree transmit-holdcount”](#) on page 579
- [“undebg mstp”](#) on page 580

clear spanning-tree statistics

Overview Use this command to clear all the STP BPDU (Bridge Protocol Data Unit) statistics.

Syntax `clear spanning-tree statistics`
`clear spanning-tree statistics [instance <mstp-instance>]`
`clear spanning-tree statistics [interface <port> [instance <mstp-instance>]]`

Parameter	Description
<port>	The port to clear STP BPDU statistics for. The port may be a switch port (e.g. port1.0.4), a static channel group (e.g. sa2), or a dynamic (LACP) channel group (e.g. po2).
<mstp-instance>	The MSTP instance (MSTI - Multiple Spanning Tree Instance) to clear MSTP BPDU statistics.

Mode User Exec and Privileged Exec

Usage Use this command with the **instance** parameter in MSTP mode. Specifying this command with the **interface** parameter only not the instance parameter will work in STP and RSTP mode.

Examples `awplus# clear spanning-tree statistics`
`awplus# clear spanning-tree statistics instance 1`
`awplus# clear spanning-tree statistics interface port1.0.2`
`awplus# clear spanning-tree statistics interface port1.0.2 instance 1`

clear spanning-tree detected protocols (RSTP and MSTP)

Overview Use this command to clear the detected protocols for a specific port, or all ports.
Use this command in RSTP or MSTP mode only.

Syntax `clear spanning-tree detected protocols [interface <port>]`

Parameter	Description
<code><port></code>	The port to clear detected protocols for. The port may be a switch port (e.g. <code>port1.0.4</code>), a static channel group (e.g. <code>sa2</code>), or a dynamic (LACP) channel group (e.g. <code>po2</code>).

Mode Privileged Exec

Example `awplus# clear spanning-tree detected protocols`

debug mstp (RSTP and STP)

Overview Use this command to enable debugging for the configured spanning tree mode, and echo data to the console, at various levels. Note that although this command uses the keyword **mstp** it displays debugging output for RSTP and STP protocols as well the MSTP protocol.

Use the **no** variant of this command to disable spanning tree debugging.

Syntax

```
debug mstp {all|cli|protocol [detail]|timer [detail]}
debug mstp {packet {rx|tx} [decode] [interface <interface>]}
debug mstp {topology-change [interface <interface>]}
no debug mstp {all|cli|protocol [detail]|timer [detail]}
no debug mstp {packet {rx|tx} [decode] [interface <interface>]}
no debug mstp {topology-change [interface <interface>]}
```

Parameter	Description
all	Echoes all spanning tree debugging levels to the console.
cli	Echoes spanning tree commands to the console.
packet	Echoes spanning tree packets to the console.
rx	Received packets.
tx	Transmitted packets.
protocol	Echoes protocol changes to the console.
timer	Echoes timer information to the console.
detail	Detailed output.
decode	Interprets packet contents
topology-change	Interprets topology change messages
interface	Keyword before <interface> placeholder to specify an interface to debug
<interface>	Placeholder used to specify the name of the interface to debug.

Mode Privileged Exec and Global Configuration mode

Usage 1 Use the **debug mstp topology-change interface** command to generate debugging messages when the device receives an indication of a topology change in a BPDU from another device. The debugging can be activated on a per-port basis. Although this command uses the keyword **mstp**, it displays debugging output for RSTP and STP protocols as well as the MSTP protocol.

Due to the likely volume of output, these debug messages are best viewed using the [terminal monitor](#) command before issuing the relevant **debug mstp**

command. The default terminal monitor filter will select and display these messages. Alternatively, the messages can be directed to any of the other log outputs by adding a filter for the MSTP application using [log buffered \(filter\)](#) command:

```
awplus# configure terminal
awplus(config)# log buffered program mstp
```

Output 1

```
awplus#terminal monitor
awplus#debug mstp topology-change interface port1.0.4
10:09:09 awplus MSTP[1409]: Topology change rcvd on port1.0.4 (internal)
10:09:09 awplus MSTP[1409]: Topology change rcvd on MSTI 1 port1.0.4
aawplus#debug mstp topology-change interface port1.0.6
10:09:29 awplus MSTP[1409]: Topology change rcvd on port1.0.6 (external)
10:09:29 awplus MSTP[1409]: Topology change rcvd on MSTI 1 port1.0.6
```

Usage 2 Use the **debug mstp packet rx|tx decode interface** command to generate debugging messages containing the entire contents of a BPDU displayed in readable text for transmitted and received xSTP BPDUs. The debugging can be activated on a per-port basis and transmit and receive debugging is controlled independently. Although this command uses the keyword **mstp**, it displays debugging output for RSTP and STP protocols as well as the MSTP protocol.

Due to the likely volume of output, these debug messages are best viewed using the [terminal monitor](#) command before issuing the relevant **debug mstp** command. The default terminal monitor filter will select and display these messages. Alternatively, the messages can be directed to any of the other log outputs by adding a filter for the MSTP application using the [log buffered \(filter\)](#) command:

```
awplus(config)# log buffered program mstp
```

Output 2 In MSTP mode - an MSTP BPDU with 1 MSTI:

```
awplus#terminal monitor
awplus#debug mstp packet rx decode interface port1.0.4
17:23:42 awplus MSTP[1417]: port1.0.4 xSTP BPDU rx - start
17:23:42 awplus MSTP[1417]: Protocol version: MSTP, BPDU type: RST
17:23:42 awplus MSTP[1417]: CIST Flags: Agree Forward Learn role=Desig
17:23:42 awplus MSTP[1417]: CIST root id      : 0000:0000cd1000fe
17:23:42 awplus MSTP[1417]: CIST ext pathcost : 0
17:23:42 awplus MSTP[1417]: CIST reg root id  : 0000:0000cd1000fe
17:23:42 awplus MSTP[1417]: CIST port id     : 8001 (128:1)
17:23:42 awplus MSTP[1417]: msg age: 0 max age: 20 hellotime: 2 fwd delay: 15
17:23:42 awplus MSTP[1417]: Version 3 length : 80
17:23:42 awplus MSTP[1417]: Format id       : 0
17:23:42 awplus MSTP[1417]: Config name    : test
17:23:42 awplus MSTP[1417]: Revision level : 0
17:23:42 awplus MSTP[1417]: Config digest  : 3ab68794d602fdf43b21c0b37ac3bca8
17:23:42 awplus MSTP[1417]: CIST int pathcost : 0
17:23:42 awplus MSTP[1417]: CIST bridge id   : 0000:0000cd1000fe
17:23:42 awplus MSTP[1417]: CIST hops remaining : 20
17:23:42 awplus MSTP[1417]: MSTI flags      : Agree Forward Learn role=Desig
17:23:42 awplus MSTP[1417]: MSTI reg root id  : 8001:0000cd1000fe
17:23:42 awplus MSTP[1417]: MSTI pathcost   : 0
17:23:42 awplus MSTP[1417]: MSTI bridge priority : 32768 port priority : 128
17:23:42 awplus MSTP[1417]: MSTI hops remaining : 20
17:23:42 awplus MSTP[1417]: port1.0.4 xSTP BPDU rx - finish
```

In STP mode transmitting a TCN BPDU:

```
awplus#terminal monitor
awplus#debug mstp packet tx decode interface port1.0.4
17:28:09 awplus MSTP[1417]: port1.0.4 xSTP BPDU tx - start
17:28:09 awplus MSTP[1417]: Protocol version: STP, BPDU type: TCN
17:28:09 awplus MSTP[1417]: port1.0.4 xSTP BPDU tx - finish
```

In STP mode receiving an STP BPDU:

```
awplus#terminal monitor
awplus#debug mstp packet rx decode interface port1.0.4
17:31:36 awplus MSTP[1417]: port1.0.4 xSTP BPDU rx - start
17:31:36 awplus MSTP[1417]: Protocol version: STP, BPDU type: Config
17:31:36 awplus MSTP[1417]: Flags: role=none
17:31:36 awplus MSTP[1417]: Root id       : 8000:0000cd1000fe
17:31:36 awplus MSTP[1417]: Root pathcost : 0
17:31:36 awplus MSTP[1417]: Bridge id    : 8000:0000cd1000fe
17:31:36 awplus MSTP[1417]: Port id     : 8001 (128:1)
17:31:36 awplus MSTP[1417]: msg age: 0 max age: 20 hellotime: 2 fwd delay: 15
17:31:36 awplus MSTP[1417]: port1.0.4 xSTP BPDU rx - finish
```

In RSTP mode receiving an RSTP BPDU:

```
awplus#terminal monitor
awplus#debug mstp packet rx decode interface port1.0.4
awplus#17:30:17 awplus MSTP[1417]: port1.0.4 xSTP BPDU rx - start
17:30:17 awplus MSTP[1417]: Protocol version: RSTP, BPDU type: RST
17:30:17 awplus MSTP[1417]: CIST Flags: Forward Learn role=Desig
17:30:17 awplus MSTP[1417]: CIST root id      : 8000:0000cd1000fe
17:30:17 awplus MSTP[1417]: CIST ext pathcost : 0
17:30:17 awplus MSTP[1417]: CIST reg root id  : 8000:0000cd1000fe
17:30:17 awplus MSTP[1417]: CIST port id     : 8001 (128:1)
17:30:17 awplus MSTP[1417]: msg age: 0 max age: 20 hellotime: 2 fwd delay: 15
17:30:17 awplus MSTP[1417]: port1.0.4 xSTP BPDU rx - finish
```

Examples

```
awplus# debug mstp all
awplus# debug mstp cli
awplus# debug mstp packet rx
awplus# debug mstp protocol detail
awplus# debug mstp timer
awplus# debug mstp packet rx decode interface port1.0.2
awplus# debug mstp packet tx decode interface port1.0.6
```

Related Commands

- [log buffered \(filter\)](#)
- [show debugging mstp](#)
- [terminal monitor](#)
- [undebug mstp](#)

instance priority (MSTP)

Overview Use this command to set the priority for this device to become the root bridge for the specified MSTI (Multiple Spanning Tree Instance).

Use this command for MSTP only.

Use the **no** variant of this command to restore the root bridge priority of the device for the instance to the default.

Syntax `instance <instance-id> priority <priority>`
`no instance <instance-id> priority`

Parameter	Description
<code><instance-id></code>	Specify an MSTP instance in the range 1-5.
<code><priority></code>	Specify the root bridge priority for the device for the MSTI in the range <0-61440>. Note that a lower priority number indicates a greater likelihood of the device becoming the root bridge. The priority values can be set only in increments of 4096. If you specify a number that is not a multiple of 4096, it will be rounded down. The default priority is 32768.

Default The default priority value for all instances is 32768.

Mode MST Configuration

Usage MSTP lets you distribute traffic more efficiently across a network by blocking different links for different VLANs. You do this by making different devices into the root bridge for each MSTP instance, so that each instance blocks a different link.

If all devices have the same root bridge priority for the instance, MSTP selects the device with the lowest MAC address to be the root bridge. Give the device a higher priority for becoming the root bridge for a particular instance by assigning it a lower priority number, or vice versa.

Examples To set the root bridge priority for MSTP instance 2 to be the highest (0), so that it will be the root bridge for this instance when available, use the commands:

```
awplus# configure terminal
awplus(config)# spanning-tree mst configuration
awplus(config-mst)# instance 2 priority 0
```

To reset the root bridge priority for instance 2 to the default (32768), use the commands:

```
awplus# configure terminal
awplus(config)# spanning-tree mst configuration
awplus(config-mst)# no instance 2 priority
```

**Related
Commands**

- region (MSTP)
- revision (MSTP)
- show spanning-tree mst config
- spanning-tree mst instance
- spanning-tree mst instance priority

instance vlan (MSTP)

Overview Use this command to create an MST Instance (MSTI), and associate the specified VLANs with it. An MSTI is a spanning tree instance that exists within an MST region (MSTR).

When a VLAN is associated with an MSTI the member ports of the VLAN are automatically configured to send and receive spanning-tree information for the associated MSTI. You can disable this automatic configuration of member ports of the VLAN to the associated MSTI by using a **no spanning-tree mst instance** command to remove the member port from the MSTI.

Use the **instance vlan** command for MSTP only.

Use the **no** variant of this command to remove the specified VLANs from the MSTI.

Syntax `instance <instance-id> vlan <vid-list>`
`no instance <instance-id> vlan <vid-list>`

Parameter	Description
<code><instance-id></code>	Specify an MSTP instance in the range 1-5.
<code><vid-list></code>	Specify one or more VLAN identifiers (VID) to be associated with the MSTI specified. This can be a single VID in the range 1-4094, or a hyphen-separated range or a comma-separated list of VLAN IDs.

Mode MST Configuration

Usage The VLANs must be created before being associated with an MST instance (MSTI). If the VLAN range is not specified, the MSTI will not be created.

This command removes the specified VLANs from the CIST and adds them to the specified MSTI. If you use the **no** variant of this command to remove the VLAN from the MSTI, it returns it to the CIST. To move a VLAN from one MSTI to another, you must first use the **no** variant of this command to return it to the CIST.

Ports in these VLANs will remain in the control of the CIST until you associate the ports with the MSTI using the **spanning-tree mst instance** command.

Example To associate VLAN 30 with MSTI 2, use the commands:

```
awplus# configure terminal
awplus(config)# spanning-tree mode mstp
awplus(config)# spanning-tree mst configuration
awplus(config-mst)# instance 2 vlan 30
```

**Related
Commands** region (MSTP)
revision (MSTP)
show spanning-tree mst config
spanning-tree mst instance
vlan

region (MSTP)

Overview Use this command to assign a name to the device's MST Region. MST Instances (MSTI) of a region form different spanning trees for different VLANs.

Use this command for MSTP only.

Use the **no** variant of this command to remove this region name and reset it to the default.

Syntax `region <region-name>`
`no region`

Parameter	Description
<code><region-name></code>	Specify the name of the region, up to 32 characters. Valid characters are upper-case, lower-case, digits, underscore.

Default By default, the region name is My Name.

Mode MST Configuration

Usage The region name, the revision number, and the digest of the VLAN to MSTI configuration table must be the same on all devices that are intended to be in the same MST region.

Example `awplus# configure terminal`
`awplus(config)# spanning-tree mst configuration`
`awplus(config-mst)# region ATL`

Related Commands [revision \(MSTP\)](#)
[show spanning-tree mst config](#)

revision (MSTP)

Overview Use this command to specify the MST revision number to be used in the configuration identifier.

Use this command for MSTP only.

Syntax `revision <revision-number>`

Parameter	Description
<code><revision-number></code>	<code><0-65535></code> Revision number.

Default The default of revision number is 0.

Mode MST Configuration

Usage The region name, the revision number, and the digest of the VLAN to MSTI configuration table must be the same on all devices that are intended to be in the same MST region.

Example

```
awplus# configure terminal
awplus(config)# spanning-tree mst configuration
awplus(config-mst)# revision 25
```

Related Commands

- [region \(MSTP\)](#)
- [show spanning-tree mst config](#)
- [instance vlan \(MSTP\)](#)

show debugging mstp

Overview Use this command to show the MSTP debugging options set.

For information on filtering and saving command output, see the [“Getting Started with AlliedWare Plus” Feature Overview and Configuration Guide](#).

Syntax `show debugging mstp`

Mode User Exec and Privileged Exec mode

Example To display the MSTP debugging options set, enter the command:

```
awplus# show debugging mstp
```

Output Figure 18-1: Example output from **show debugging mstp**

```
MSTP debugging status:  
MSTP receiving packet debugging is on
```

Related Commands [debug mstp \(RSTP and STP\)](#)

show spanning-tree

Overview Use this command to display detailed spanning tree information on the specified port or on all ports. Use this command for RSTP, MSTP or STP.

For information on filtering and saving command output, see the [“Getting Started with AlliedWare Plus” Feature Overview and Configuration Guide](#).

Syntax `show spanning-tree [interface <port-list>]`

Parameter	Description
<code>interface</code>	Display information about the following port only.
<code><port-list></code>	The ports to display information about. A port-list can be: <ul style="list-style-type: none">• a switch port (e.g. port1.0.6) a static channel group (e.g. sa2) or a dynamic (LACP) channel group (e.g. po2)• a continuous range of ports separated by a hyphen, e.g. port1.0.1-1.0.4, or sa1-2, or po1-2• a comma-separated list of ports and port ranges, e.g. port1.0.1,port1.0.4-1.0.6. Do not mix switch ports, static channel groups, and dynamic (LACP) channel groups in the same list

Mode User Exec and Privileged Exec

Usage Note that any list of interfaces specified must not span any interfaces that are not installed.

A topology change counter has been included for RSTP and MSTP. You can see the topology change counter for RSTP by using the **show spanning-tree** command. You can see the topology change counter for MSTP by using the **show spanning-tree mst instance** command.

Example To display spanning tree information about port1.0.3, use the command:

```
awplus# show spanning-tree interface port1.0.3
```

Output Figure 18-2: Example output from **show spanning-tree** in RSTP mode

```
awplus#show spanning-tree
% 1: Bridge up - Spanning Tree Enabled
% 1: Root Path Cost 0 - Root Port 0 - Bridge Priority 32768
% 1: Forward Delay 15 - Hello Time 2 - Max Age 20
% 1: Root Id 80000000cd24ff2d
% 1: Bridge Id 80000000cd24ff2d
% 1: last topology change Mon Oct 3 02:06:26 2016
% 1: portfast bpdu-filter disabled
% 1: portfast bpdu-guard disabled
% 1: portfast errdisable timeout disabled
% 1: portfast errdisable timeout interval 300 sec
% port1.0.1: Port 5001 - Id 8389 - Role Disabled - State Discarding
% port1.0.1: Designated Path Cost 0
% port1.0.1: Configured Path Cost 20000000 - Add type Explicit ref count 1
% port1.0.1: Designated Port Id 8389 - Priority 128 -
% port1.0.1: Root 80000000cd24ff2d
% port1.0.1: Designated Bridge 80000000cd24ff2d
% port1.0.1: Message Age 0 - Max Age 20
% port1.0.1: Hello Time 2 - Forward Delay 15
% port1.0.1: Forward Timer 0 - Msg Age Timer 0 - Hello Timer 0 - topo change
timer 0
% port1.0.1: forward-transitions 0
% port1.0.1: Version Rapid Spanning Tree Protocol - Received None - Send STP
% port1.0.1: No portfast configured - Current portfast off
% port1.0.1: portfast bpdu-guard default - Current portfast bpdu-guard off
% port1.0.1: portfast bpdu-filter default - Current portfast bpdu-filter off
% port1.0.1: no root guard configured - Current root guard off
% port1.0.1: Configured Link Type point-to-point - Current shared
%
% port1.0.2: Port 5002 - Id 838a - Role Disabled - State Discarding
% port1.0.2: Designated Path Cost 0
% port1.0.2: Configured Path Cost 20000000 - Add type Explicit ref count 1
% port1.0.2: Designated Port Id 838a - Priority 128 -
% port1.0.2: Root 80000000cd24ff2d
% port1.0.2: Designated Bridge 80000000cd24ff2d
% port1.0.2: Message Age 0 - Max Age 20
% port1.0.2: Hello Time 2 - Forward Delay 15
% port1.0.2: Forward Timer 0 - Msg Age Timer 0 - Hello Timer 0 - topo change
timer 0
% port1.0.2: forward-transitions 0
% port1.0.2: Version Rapid Spanning Tree Protocol - Received None - Send STP
% port1.0.2: No portfast configured - Current portfast off
% port1.0.2: portfast bpdu-guard default - Current portfast bpdu-guard off
% port1.0.2: portfast bpdu-filter default - Current portfast bpdu-filter off
% port1.0.2: no root guard configured - Current root guard off
% port1.0.2: Configured Link Type point-to-point - Current shared
```

Output Figure 18-3: Example output from **show spanning-tree**

```
% 1: Bridge up - Spanning Tree Enabled
% 1: Root Path Cost 0 - Root Port 0 - Bridge Priority 32768
% 1: Forward Delay 15 - Hello Time 2 - Max Age 20
% 1: Root Id 80000000cd20f093
% 1: Bridge Id 80000000cd20f093
% 1: last topology change Mon Oct 3 02:06:26 2016
% 1: portfast bpdu-filter disabled
% 1: portfast bpdu-guard disabled
% 1: portfast errdisable timeout disabled
% 1: portfast errdisable timeout interval 300 sec
%   port1.0.3: Port 5023 - Id 839f - Role Designated - State Forwarding
%   port1.0.3: Designated Path Cost 0
%   port1.0.3: Configured Path Cost 200000 - Add type Explicit ref count 1
%   port1.0.3: Designated Port Id 839f - Priority 128 -
%   port1.0.3: Root 80000000cd20f093
%   port1.0.3: Designated Bridge 80000000cd20f093
%   port1.0.3: Message Age 0 - Max Age 20
%   port1.0.3: Hello Time 2 - Forward Delay 15
%   port1.0.3: Forward Timer 0 - Msg Age Timer 0 - Hello Timer 1 - topo change
timer 0
%   port1.0.3: forward-transitions 32
%   port1.0.3: Version Rapid Spanning Tree Protocol - Received None - Send RSTP
%   port1.0.3: No portfast configured - Current portfast off
%   port1.0.3: portfast bpdu-guard default - Current portfast bpdu-guard off
%   port1.0.3: portfast bpdu-filter default - Current portfast bpdu-filter off
%   port1.0.3: no root guard configured - Current root guard off
%   port1.0.3: Configured Link Type point-to-point - Current point-to-point
...

```

show spanning-tree brief

Overview Use this command to display a summary of spanning tree status information on all ports. Use this command for RSTP, MSTP or STP.

Syntax `show spanning-tree brief`

Parameter	Description
brief	A brief summary of spanning tree information.

Mode User Exec and Privileged Exec

Usage Note that any list of interfaces specified must not span any interfaces that are not installed.

A topology change counter has been included for RSTP and MSTP. You can see the topology change counter for RSTP by using the **show spanning-tree** command. You can see the topology change counter for MSTP by using the **show spanning-tree mst instance** command.

Example To display a summary of spanning tree status information, use the command:

```
awplus# show spanning-tree brief
```

Output Figure 18-4: Example output from **show spanning-tree brief**

```
Default: Bridge up - Spanning Tree Enabled
Default: Root Path Cost 40000 - Root Port 4501 - Bridge Priority 32768
Default: Root Id 8000:0000cd250001
Default: Bridge Id 8000:0000cd296eb1

Port          Designated Bridge  Port Id  Role          State
sa1           8000:001577c9744b  8195    Rootport     Forwarding
po1           8000:0000cd296eb1  81f9    Designated   Forwarding
port1.0.1     8000:0000cd296eb1  8389    Disabled     Discarding
port1.0.2     8000:0000cd296eb1  838a    Disabled     Discarding
port1.0.3     8000:0000cd296eb1  838b    Disabled     Discarding
...
```

Related Commands [show spanning-tree](#)

show spanning-tree mst

Overview This command displays bridge-level information about the CIST and VLAN to MSTI mappings.

For information on filtering and saving command output, see the [“Getting Started with AlliedWare Plus” Feature Overview and Configuration Guide](#).

Syntax `show spanning-tree mst`

Mode User Exec, Privileged Exec and Interface Configuration

Example To display bridge-level information about the CIST and VLAN to MSTI mappings, enter the command:

```
awplus# show spanning-tree mst
```

Output Figure 18-5: Example output from **show spanning-tree mst**

```
% 1: Bridge up - Spanning Tree Enabled
% 1: CIST Root Path Cost 0 - CIST Root Port 0 - CIST Bridge
Priority 32768
% 1: Forward Delay 15 - Hello Time 2 - Max Age 20 - Max-hops 20
% 1: CIST Root Id 8000000475e93ffe
% 1: CIST Reg Root Id 8000000475e93ffe
% 1: CST Bridge Id 8000000475e93ffe
% 1: portfast bpdu-filter disabled
% 1: portfast bpdu-guard disabled
% 1: portfast errdisable timeout disabled
% 1: portfast errdisable timeout interval 300 sec
%
% Instance      VLAN
% 0:            1
% 2:            4
```

Related Commands [show spanning-tree mst interface](#)

show spanning-tree mst config

Overview Use this command to display MSTP configuration identifier for the device.

Syntax `show spanning-tree mst config`

Mode User Exec, Privileged Exec and Interface Configuration

Usage The region name, the revision number, and the digest of the VLAN to MSTI configuration table must be the same on all devices that are intended to be in the same MST region.

Example To display MSTP configuration identifier information, enter the command:

```
awplus# show spanning-tree mst config
```

Output Figure 18-6: Example output from **show spanning-tree mst config**

```
awplus#show spanning-tree mst config
%
% MSTP Configuration Information:
%-----
% Format Id      : 0
% Name          : My Name
% Revision Level : 0
% Digest        : 0x80DEE46DA92A98CF21C603291B22880A
%-----
%
```

Related Commands

- [instance vlan \(MSTP\)](#)
- [region \(MSTP\)](#)
- [revision \(MSTP\)](#)

show spanning-tree mst detail

Overview This command displays detailed information about each instance, and all interfaces associated with that particular instance.

For information on filtering and saving command output, see the [“Getting Started with AlliedWare Plus” Feature Overview and Configuration Guide](#).

Syntax show spanning-tree mst detail

Mode User Exec, Privileged Exec and Interface Configuration

Example To display detailed information about each instance, and all interfaces associated with them, enter the command:

```
awplus# show spanning-tree mst detail
```

Output Figure 18-7: Example output from **show spanning-tree mst detail**

```
% 1: Bridge up - Spanning Tree Enabled
% 1: CIST Root Path Cost 0 - CIST Root Port 0 - CIST Bridge Priority 32768
% 1: Forward Delay 15 - Hello Time 2 - Max Age 20 - Max-hops 20
% 1: CIST Root Id 80000000cd24ff2d
% 1: CIST Reg Root Id 80000000cd24ff2d
% 1: CIST Bridge Id 80000000cd24ff2d
% 1: portfast bpdu-filter disabled
% 1: portfast bpdu-guard disabled
% 1: portfast errdisable timeout disabled
% 1: portfast errdisable timeout interval 300 sec
% port1.0.1: Port 5001 - Id 8389 - Role Disabled - State Discarding
% port1.0.1: Designated External Path Cost 0 -Internal Path Cost 0
% port1.0.1: Configured Path Cost 20000000 - Add type Explicit ref count 1
% port1.0.1: Designated Port Id 8389 - CIST Priority 128 -
% port1.0.1: CIST Root 80000000cd24ff2d
% port1.0.1: Regional Root 80000000cd24ff2d
% port1.0.1: Designated Bridge 80000000cd24ff2d
% port1.0.1: Message Age 0 - Max Age 20
% port1.0.1: CIST Hello Time 2 - Forward Delay 15
% port1.0.1: CIST Forward Timer 0 - Msg Age Timer 0 - Hello Timer 0 - topo
change timer 0
...
% port1.0.2: forward-transitions 0
% port1.0.2: Version Multiple Spanning Tree Protocol - Received None - Send STP
% port1.0.2: No portfast configured - Current portfast off
% port1.0.2: portfast bpdu-guard default - Current portfast bpdu-guard off
% port1.0.2: portfast bpdu-filter default - Current portfast bpdu-filter off
% port1.0.2: no root guard configured - Current root guard off
% port1.0.2: Configured Link Type point-to-point - Current shared
%
```



```
% port1.0.3: Port 5003 - Id 838b - Role Disabled - State Discarding
% port1.0.3: Designated External Path Cost 0 -Internal Path Cost 0
% port1.0.3: Configured Path Cost 20000000 - Add type Explicit ref count 1
% port1.0.3: Designated Port Id 838b - CIST Priority 128 -
% port1.0.3: CIST Root 80000000cd24ff2d
% port1.0.3: Regional Root 80000000cd24ff2d
% port1.0.3: Designated Bridge 80000000cd24ff2d
% port1.0.3: Message Age 0 - Max Age 20
% port1.0.3: CIST Hello Time 2 - Forward Delay 15
% port1.0.3: CIST Forward Timer 0 - Msg Age Timer 0 - Hello Timer 0 - topo
change timer 0
% port1.0.3: forward-transitions 0
% port1.0.3: Version Multiple Spanning Tree Protocol - Received None - Send STP
% port1.0.3: No portfast configured - Current portfast off
% port1.0.3: portfast bpdu-guard default - Current portfast bpdu-guard off
% port1.0.3: portfast bpdu-filter default - Current portfast bpdu-filter off
% port1.0.3: no root guard configured - Current root guard off
% port1.0.3: Configured Link Type point-to-point - Current shared
```

show spanning-tree mst detail interface

Overview This command displays detailed information about the specified switch port, and the MST instances associated with it.

For information on filtering and saving command output, see the [“Getting Started with AlliedWare Plus” Feature Overview and Configuration Guide](#).

Syntax `show spanning-tree mst detail interface <port>`

Parameter	Description
<code><port></code>	The port to display information about. The port may be a switch port (e.g. <code>port1.0.4</code>), a static channel group (e.g. <code>sa2</code>), or a dynamic (LACP) channel group (e.g. <code>po2</code>).

Mode User Exec, Privileged Exec and Interface Configuration

Example To display detailed information about `port1.0.3` and the instances associated with it, enter the command:

```
awplus# show spanning-tree mst detail interface port1.0.3
```

Output Figure 18-8: Example output from **show spanning-tree mst detail interface**

```
% 1: Bridge up - Spanning Tree Enabled
% 1: CIST Root Path Cost 0 - CIST Root Port 0 - CIST Bridge Priority 32768
% 1: Forward Delay 15 - Hello Time 2 - Max Age 20 - Max-hops 20
% 1: CIST Root Id 80000000cd24ff2d
% 1: CIST Reg Root Id 80000000cd24ff2d
% 1: CIST Bridge Id 80000000cd24ff2d
% 1: portfast bpdu-filter disabled
% 1: portfast bpdu-guard disabled
% 1: portfast errdisable timeout disabled
% 1: portfast errdisable timeout interval 300 sec
% port1.0.2: Port 5002 - Id 838a - Role Disabled - State Discarding
% port1.0.2: Designated External Path Cost 0 -Internal Path Cost 0
% port1.0.2: Configured Path Cost 20000000 - Add type Explicit ref count 2
% port1.0.2: Designated Port Id 838a - CIST Priority 128 -
% port1.0.2: CIST Root 80000000cd24ff2d
% port1.0.2: Regional Root 80000000cd24ff2d
% port1.0.2: Designated Bridge 80000000cd24ff2d
% port1.0.2: Message Age 0 - Max Age 20
% port1.0.2: CIST Hello Time 2 - Forward Delay 15
% port1.0.2: CIST Forward Timer 0 - Msg Age Timer 0 - Hello Timer 0 - topo
change timer 0
% port1.0.2: forward-transitions 0
% port1.0.2: Version Multiple Spanning Tree Protocol - Received None - Send STP
```

```
% port1.0.2: No portfast configured - Current portfast off
% port1.0.2: portfast bpdu-guard default - Current portfast bpdu-guard off
% port1.0.2: portfast bpdu-filter default - Current portfast bpdu-filter off
% port1.0.2: no root guard configured - Current root guard off
% port1.0.2: Configured Link Type point-to-point - Current shared
%
% Instance 2: Vlans: 2
% 1: MSTI Root Path Cost 0 -MSTI Root Port 0 - MSTI Bridge Priority 32768
% 1: MSTI Root Id 80020000cd24ff2d
% 1: MSTI Bridge Id 80020000cd24ff2d
% port1.0.2: Port 5002 - Id 838a - Role Disabled - State Discarding
% port1.0.2: Designated Internal Path Cost 0 - Designated Port Id 838a
% port1.0.2: Configured Internal Path Cost 20000000
% port1.0.2: Configured CST External Path cost 20000000
% port1.0.2: CST Priority 128 - MSTI Priority 128
% port1.0.2: Designated Root 80020000cd24ff2d
% port1.0.2: Designated Bridge 80020000cd24ff2d
% port1.0.2: Message Age 0 - Max Age 0
% port1.0.2: Hello Time 2 - Forward Delay 15
% port1.0.2: Forward Timer 0 - Msg Age Timer 0 - Hello Timer 0
```

show spanning-tree mst instance

Overview This command displays detailed information for the specified instance, and all switch ports associated with that instance.

A topology change counter has been included for RSTP and MSTP. You can see the topology change counter for RSTP by using the [show spanning-tree](#) command. You can see the topology change counter for MSTP by using the **show spanning-tree mst instance** command.

For information on filtering and saving command output, see the [“Getting Started with AlliedWare Plus” Feature Overview and Configuration Guide](#).

Syntax `show spanning-tree mst instance <instance-id>`

Parameter	Description
<instance-id>	Specify an MSTP instance in the range 1-5.

Mode User Exec, Privileged Exec, and Interface Configuration

Example To display detailed information for **instance 2**, and all switch ports associated with that instance, use the command:

```
awplus# show spanning-tree mst instance 2
```

Output Figure 18-9: Example output from **show spanning-tree mst instance**

```
% 1: MSTI Root Path Cost 0 - MSTI Root Port 0 - MSTI Bridge Priority 32768
% 1: MSTI Root Id 80020000cd24ff2d
% 1: MSTI Bridge Id 80020000cd24ff2d
% port1.0.2: Port 5002 - Id 838a - Role Disabled - State Discarding
% port1.0.2: Designated Internal Path Cost 0 - Designated Port Id 838a
% port1.0.2: Configured Internal Path Cost 20000000
% port1.0.2: Configured CST External Path cost 20000000
% port1.0.2: CST Priority 128 - MSTI Priority 128
% port1.0.2: Designated Root 80020000cd24ff2d
% port1.0.2: Designated Bridge 80020000cd24ff2d
% port1.0.2: Message Age 0 - Max Age 0
% port1.0.2: Hello Time 2 - Forward Delay 15
% port1.0.2: Forward Timer 0 - Msg Age Timer 0 - Hello Timer 0
%
```

show spanning-tree mst instance interface

Overview This command displays detailed information for the specified MST (Multiple Spanning Tree) instance, and the specified switch port associated with that MST instance.

For information on filtering and saving command output, see the [“Getting Started with AlliedWare Plus” Feature Overview and Configuration Guide](#).

Syntax `show spanning-tree mst instance <instance-id> interface <port>`

Parameter	Description
<instance-id>	Specify an MSTP instance in the range 1-5.
<port>	The port to display information about. The port may be a switch port (e.g. port1.0.4), a static channel group (e.g. sa2), or a dynamic (LACP) channel group (e.g. po2).

Mode User Exec, Privileged Exec, and Interface Configuration

Example To display detailed information for instance 2, interface port1.0.2, use the command:

```
awplus# show spanning-tree mst instance 2 interface port1.0.2
```

Output Figure 18-10: Example output from **show spanning-tree mst instance**

```
% 1: MSTI Root Path Cost 0 - MSTI Root Port 0 - MSTI Bridge Priority 32768
% 1: MSTI Root Id 80020000cd24ff2d
% 1: MSTI Bridge Id 80020000cd24ff2d
% port1.0.2: Port 5002 - Id 838a - Role Disabled - State Discarding
% port1.0.2: Designated Internal Path Cost 0 - Designated Port Id 838a
% port1.0.2: Configured Internal Path Cost 20000000
% port1.0.2: Configured CST External Path cost 20000000
% port1.0.2: CST Priority 128 - MSTI Priority 128
% port1.0.2: Designated Root 80020000cd24ff2d
% port1.0.2: Designated Bridge 80020000cd24ff2d
% port1.0.2: Message Age 0 - Max Age 0
% port1.0.2: Hello Time 2 - Forward Delay 15
% port1.0.2: Forward Timer 0 - Msg Age Timer 0 - Hello Timer 0
%
```

show spanning-tree mst interface

Overview This command displays the number of instances created, and VLANs associated with it for the specified switch port.

For information on filtering and saving command output, see the [“Getting Started with AlliedWare Plus” Feature Overview and Configuration Guide](#).

Syntax `show spanning-tree mst interface <port>`

Parameter	Description
<code><port></code>	The port to display information about. The port may be a switch port (e.g. <code>port1.0.4</code>), a static channel group (e.g. <code>sa2</code>), or a dynamic (LACP) channel group (e.g. <code>po2</code>).

Mode User Exec, Privileged Exec, and Interface Configuration

Example To display detailed information about each instance, and all interfaces associated with them, for `port1.0.4`, use the command:

```
awplus# show spanning-tree mst interface port1.0.4
```

Output Figure 18-11: Example output from **show spanning-tree mst interface**

```
% 1: Bridge up - Spanning Tree Enabled
% 1: CIST Root Path Cost 0 - CIST Root Port 0 - CIST Bridge Priority 32768
% 1: Forward Delay 15 - Hello Time 2 - Max Age 20 - Max-hops 20
% 1: CIST Root Id 80000008c73a2b22
% 1: CIST Reg Root Id 80000008c73a2b22
% 1: CST Bridge Id 80000008c73a2b22
% 1: portfast bpdu-filter disabled
% 1: portfast bpdu-guard disabled
% 1: portfast errdisable timeout disabled
% 1: portfast errdisable timeout interval 1 sec
%
% Instance      VLAN
% 0:            1
% 1:            2-3
% 2:            4-5
```

show spanning-tree mst detail interface

Overview This command displays detailed information about the specified switch port, and the MST instances associated with it.

For information on filtering and saving command output, see the [“Getting Started with AlliedWare Plus” Feature Overview and Configuration Guide](#).

Syntax `show spanning-tree mst detail interface <port>`

Parameter	Description
<code><port></code>	The port to display information about. The port may be a switch port (e.g. <code>port1.0.4</code>), a static channel group (e.g. <code>sa2</code>), or a dynamic (LACP) channel group (e.g. <code>po2</code>).

Mode User Exec, Privileged Exec and Interface Configuration

Example To display detailed information about `port1.0.3` and the instances associated with it, enter the command:

```
awplus# show spanning-tree mst detail interface port1.0.3
```

Output Figure 18-12: Example output from **show spanning-tree mst detail interface**

```
% 1: Bridge up - Spanning Tree Enabled
% 1: CIST Root Path Cost 0 - CIST Root Port 0 - CIST Bridge Priority 32768
% 1: Forward Delay 15 - Hello Time 2 - Max Age 20 - Max-hops 20
% 1: CIST Root Id 80000000cd24ff2d
% 1: CIST Reg Root Id 80000000cd24ff2d
% 1: CIST Bridge Id 80000000cd24ff2d
% 1: portfast bpdu-filter disabled
% 1: portfast bpdu-guard disabled
% 1: portfast errdisable timeout disabled
% 1: portfast errdisable timeout interval 300 sec
% port1.0.2: Port 5002 - Id 838a - Role Disabled - State Discarding
% port1.0.2: Designated External Path Cost 0 -Internal Path Cost 0
% port1.0.2: Configured Path Cost 20000000 - Add type Explicit ref count 2
% port1.0.2: Designated Port Id 838a - CIST Priority 128 -
% port1.0.2: CIST Root 80000000cd24ff2d
% port1.0.2: Regional Root 80000000cd24ff2d
% port1.0.2: Designated Bridge 80000000cd24ff2d
% port1.0.2: Message Age 0 - Max Age 20
% port1.0.2: CIST Hello Time 2 - Forward Delay 15
% port1.0.2: CIST Forward Timer 0 - Msg Age Timer 0 - Hello Timer 0 - topo
change timer 0
% port1.0.2: forward-transitions 0
% port1.0.2: Version Multiple Spanning Tree Protocol - Received None - Send STP
```

```
% port1.0.2: No portfast configured - Current portfast off
% port1.0.2: portfast bpdu-guard default - Current portfast bpdu-guard off
% port1.0.2: portfast bpdu-filter default - Current portfast bpdu-filter off
% port1.0.2: no root guard configured - Current root guard off
% port1.0.2: Configured Link Type point-to-point - Current shared
%
% Instance 2: Vlans: 2
% 1: MSTI Root Path Cost 0 -MSTI Root Port 0 - MSTI Bridge Priority 32768
% 1: MSTI Root Id 80020000cd24ff2d
% 1: MSTI Bridge Id 80020000cd24ff2d
% port1.0.2: Port 5002 - Id 838a - Role Disabled - State Discarding
% port1.0.2: Designated Internal Path Cost 0 - Designated Port Id 838a
% port1.0.2: Configured Internal Path Cost 20000000
% port1.0.2: Configured CST External Path cost 20000000
% port1.0.2: CST Priority 128 - MSTI Priority 128
% port1.0.2: Designated Root 80020000cd24ff2d
% port1.0.2: Designated Bridge 80020000cd24ff2d
% port1.0.2: Message Age 0 - Max Age 0
% port1.0.2: Hello Time 2 - Forward Delay 15
% port1.0.2: Forward Timer 0 - Msg Age Timer 0 - Hello Timer 0
```

show spanning-tree statistics

Overview This command displays BPDU (Bridge Protocol Data Unit) statistics for all spanning-tree instances, and all switch ports associated with all spanning-tree instances.

For information on filtering and saving command output, see the [“Getting Started with AlliedWare Plus” Feature Overview and Configuration Guide](#).

Syntax show spanning-tree statistics

Mode Privileged Exec

Usage To display BPDU statistics for all spanning-tree instances, and all switch ports associated with all spanning-tree instances, use the command:

```
awplus# show spanning-tree statistics
```

Output Figure 18-13: Example output from **show spanning-tree statistics**

```
=====
% BPDU Related Parameters
% -----
% Port Spanning Tree           : Disable
% Spanning Tree Type          : Rapid Spanning Tree Protocol
% Current Port State           : Discarding
% Port ID                      : 8393
% Port Number                  : 393
% Path Cost                    : 20000000
% Message Age                  : 0
% Designated Root              : ec:cd:6d:20:c0:ed
% Designated Cost              : 0
% Designated Bridge            : ec:cd:6d:20:c0:ed
% Designated Port Id          : 8393
% Top Change Ack               : FALSE
% Config Pending               : FALSE
% PORT Based Information & Statistics
% -----
% Config Bpdu's xmitted        : 0
% Config Bpdu's received       : 0
% TCN Bpdu's xmitted           : 0
% TCN Bpdu's received          : 0
% Forward Trans Count          : 0
```

```
% STATUS of Port Timers
% -----
% Hello Time Configured           : 2
% Hello timer                     : INACTIVE
% Hello Time Value                : 0
% Forward Delay Timer             : INACTIVE
% Forward Delay Timer Value       : 0
% Message Age Timer               : INACTIVE
% Message Age Timer Value        : 0
% Topology Change Timer          : INACTIVE
% Topology Change Timer Value    : 0
% Hold Timer                      : INACTIVE
% Hold Timer Value               : 0
% Other Port-Specific Info
% -----
% Max Age Transitions             : 1
% Msg Age Expiry                  : 0
% Similar BPDUS Rcvd             : 0
% Src Mac Count                   : 0
% Total Src Mac Rcvd              : 0
% Next State                      : Learning
% Topology Change Time           : 0
```

show spanning-tree statistics instance

Overview This command displays BPDU (Bridge Protocol Data Unit) statistics for the specified MST (Multiple Spanning Tree) instance, and all switch ports associated with that MST instance.

For information on filtering and saving command output, see the [“Getting Started with AlliedWare Plus” Feature Overview and Configuration Guide](#).

Syntax `show spanning-tree statistics instance <instance-id>`

Parameter	Description
<code><instance-id></code>	Specify an MSTP instance in the range 1-5.

Mode Privileged Exec

Example To display BPDU statistics information for MST instance 2, and all switch ports associated with that MST instance, use the command:

```
awplus# show spanning-tree statistics instance 2
```

Output Figure 18-14: Example output from **show spanning-tree statistics instance**

```
% % INST_PORT port1.0.3 Information & Statistics
% -----
% Config Bpdu's xmitted (port/inst)      : (0/0)
% Config Bpdu's received (port/inst)    : (0/0)
% TCN Bpdu's xmitted (port/inst)        : (0/0)
% TCN Bpdu's received (port/inst)       : (0/0)
% Message Age (port/Inst)                : (0/0)
% port1.0.3: Forward Transitions          : 0
% Next State                             : Learning
% Topology Change Time                   : 0
...

```

Related Commands [show spanning-tree statistics](#)

show spanning-tree statistics instance interface

Overview This command displays BPDU (Bridge Protocol Data Unit) statistics for the specified MST (Multiple Spanning Tree) instance and the specified switch port associated with that MST instance.

For information on filtering and saving command output, see the [“Getting Started with AlliedWare Plus” Feature Overview and Configuration Guide](#).

Syntax `show spanning-tree statistics instance <instance-id> interface <port>`

Parameter	Description
<instance-id>	Specify an MSTP instance in the range 1-5.
<port>	The port to display information about. The port may be a switch port (e.g. port1.0.4), a static channel group (e.g. sa2), or a dynamic (LACP) channel group (e.g. po2).

Mode Privileged Exec

Example To display BPDU statistics for MST instance 2, interface port1.0.2, use the command:

```
awplus# show spanning-tree statistics instance 2 interface port1.0.2
```

Output Figure 18-15: Example output from **show spanning-tree statistics instance interface**

```
awplus#sh spanning-tree statistics interface port1.0.2 instance 1
Spanning Tree Enabled for Instance : 1
=====
% INST_PORT port1.0.2 Information & Statistics
% -----
% Config Bpdu's xmitted (port/inst)      : (0/0)
% Config Bpdu's received (port/inst)    : (0/0)
% TCN Bpdu's xmitted (port/inst)        : (0/0)
% TCN Bpdu's received (port/inst)       : (0/0)
% Message Age (port/Inst)                : (0/0)
% port1.0.2: Forward Transitions         : 0
% Next State                             : Learning
% Topology Change Time                   : 0

% Other Inst/Vlan Information & Statistics
% -----
% Bridge Priority                         : 0
% Bridge Mac Address                     : ec:cd:6d:20:c0:ed
% Topology Change Initiator               : 5023
% Last Topology Change Occured           : Mon Oct 3 05:42:06 2016
% Topology Change                        : FALSE
% Topology Change Detected                : FALSE
% Topology Change Count                   : 1
% Topology Change Last Recvd from        : 00:00:00:00:00:00
```

Related Commands [show spanning-tree statistics](#)

show spanning-tree statistics interface

Overview This command displays BPDU (Bridge Protocol Data Unit) statistics for the specified switch port, and all MST instances associated with that switch port.

For information on filtering and saving command output, see the [“Getting Started with AlliedWare Plus” Feature Overview and Configuration Guide](#).

Syntax `show spanning-tree statistics interface <port>`

Parameter	Description
<code><port></code>	The port to display information about. The port may be a switch port (e.g. port1.0.4), a static channel group (e.g. sa2), or a dynamic (LACP) channel group (e.g. po2).

Mode Privileged Exec

Example To display BPDU statistics about each MST instance for port1.0.2, use the command:

```
awplus# show spanning-tree statistics interface port1.0.2
```

Output Figure 18-16: Example output from **show spanning-tree statistics interface**

```
awplus#show spanning-tree statistics interface port1.0.2

      Port number = 906 Interface = port1.0.2
      =====
% BPDU Related Parameters
% -----
% Port Spanning Tree           : Disable
% Spanning Tree Type          : Multiple Spanning Tree Protocol
% Current Port State          : Discarding
% Port ID                      : 838a
% Port Number                  : 38a
% Path Cost                    : 20000000
% Message Age                  : 0
% Designated Root              : ec:cd:6d:20:c0:ed
% Designated Cost              : 0
% Designated Bridge            : ec:cd:6d:20:c0:ed
% Designated Port Id          : 838a
% Top Change Ack               : FALSE
% Config Pending               : FALSE
```

```
% PORT Based Information & Statistics
% -----
% Config Bpdu's xmitted           : 0
% Config Bpdu's received          : 0
% TCN Bpdu's xmitted              : 0
% TCN Bpdu's received             : 0
% Forward Trans Count             : 0

% STATUS of Port Timers
% -----
% Hello Time Configured           : 2
% Hello timer                     : INACTIVE
% Hello Time Value                : 0
% Forward Delay Timer             : INACTIVE
% Forward Delay Timer Value       : 0
% Message Age Timer               : INACTIVE
% Message Age Timer Value         : 0
% Topology Change Timer          : INACTIVE
% Topology Change Timer Value     : 0
% Hold Timer                      : INACTIVE
% Hold Timer Value                : 0

% Other Port-Specific Info
% -----
% Max Age Transitions             : 1
% Msg Age Expiry                  : 0
% Similar BPDUS Rcvd             : 0
% Src Mac Count                   : 0
% Total Src Mac Rcvd             : 0
% Next State                      : Learning
% Topology Change Time            : 0
% Other Bridge information & Statistics
% -----
% STP Multicast Address           : 01:80:c2:00:00:00
% Bridge Priority                  : 32768
% Bridge Mac Address              : ec:cd:6d:20:c0:ed
% Bridge Hello Time               : 2
% Bridge Forward Delay            : 15
% Topology Change Initiator       : 5023
% Last Topology Change Occured    : Mon Oct 3 05:41:20 2016
% Topology Change                 : FALSE
% Topology Change Detected        : TRUE
% Topology Change Count           : 1
% Topology Change Last Recvd from : 00:00:00:00:00:00
```

Related Commands [show spanning-tree statistics](#)

show spanning-tree vlan range-index

Overview Use this command to display information about MST (Multiple Spanning Tree) instances and the VLANs associated with them including the VLAN range-index value for the device.

Syntax `show spanning-tree vlan range-index`

Mode Privileged Exec

Example To display information about MST instances and the VLANs associated with them for the device, including the VLAN range-index value, use the following command:

```
awplus# show spanning-tree vlan range-index
```

Output Figure 18-17: Example output from **show spanning-tree vlan range-index**

```
awplus#show spanning-tree vlan range-index
% MST Instance  VLAN      RangeIdx
%      1         1         1%
```

Related Commands [show spanning-tree statistics](#)

spanning-tree autoedge (RSTP and MSTP)

Overview Use this command to enable the autoedge feature on the port.

The autoedge feature allows the port to automatically detect that it is an edge port. If it does not receive any BPDUs in the first three seconds after linkup, enabling, or entering RSTP or MSTP mode, it sets itself to be an edgeport and enters the forwarding state.

Use this command for RSTP or MSTP.

Use the **no** variant of this command to disable this feature.

Syntax `spanning-tree autoedge`
`no spanning-tree autoedge`

Default Disabled

Mode Interface Configuration

Example `awplus# configure terminal`
`awplus(config)# interface port1.0.3`
`awplus(config-if)# spanning-tree autoedge`

Related Commands [spanning-tree edgeport \(RSTP and MSTP\)](#)

spanning-tree cisco-interoperability (MSTP)

Overview Use this command to enable/disable Cisco-interoperability for MSTP.
Use this command for MSTP only.

Syntax `spanning-tree cisco-interoperability {enable|disable}`

Parameter	Description
enable	Enable Cisco interoperability for MSTP.
disable	Disable Cisco interoperability for MSTP.

Default If this command is not used, Cisco interoperability is disabled.

Mode Global Configuration

Usage For compatibility with certain Cisco devices, all devices in the switched LAN running the AlliedWare Plus™ Operating System must have Cisco-interoperability enabled. When the AlliedWare Plus Operating System is interoperating with Cisco, the only criteria used to classify a region are the region name and revision level. VLAN to instance mapping is not used to classify regions when interoperating with Cisco.

Examples To enable Cisco interoperability on a Layer 2 device:

```
awplus# configure terminal
awplus(config)# spanning-tree cisco-interoperability enable
```

To disable Cisco interoperability on a Layer 2 device:

```
awplus# configure terminal
awplus(config)# spanning-tree cisco-interoperability disable
```

spanning-tree edgeport (RSTP and MSTP)

Overview Use this command to set a port as an edge-port.

Use this command for RSTP or MSTP.

This command has the same effect as the [spanning-tree portfast \(STP\)](#) command, but the configuration displays differently in the output of some show commands.

Use the **no** variant of this command to set a port to its default state (not an edge-port).

Syntax `spanning-tree edgeport`
`no spanning-tree edgeport`

Default Not an edge port.

Mode Interface Configuration

Usage Use this command on a switch port connected to a LAN that has no other bridges attached. If a BPDU is received on the port that indicates that another bridge is connected to the LAN, then the port is no longer treated as an edge port.

Example

```
awplus# configure terminal
awplus(config)# interface port1.0.2
awplus(config-if)# spanning-tree edgeport
```

Related Commands [spanning-tree autoedge \(RSTP and MSTP\)](#)

spanning-tree enable

Overview Use this command in Global Configuration mode to enable the specified spanning tree protocol for all switch ports. Note that this must be the spanning tree protocol that is configured on the device by the [spanning-tree mode](#) command.

Use the **no** variant of this command to disable the configured spanning tree protocol. This places all switch ports in the forwarding state.

Syntax `spanning-tree {mstp|rstp|stp} enable`
`no spanning-tree {mstp|rstp|stp} enable`

Parameter	Description
mstp	Enables or disables MSTP (Multiple Spanning Tree Protocol).
rstp	Enables or disables RSTP (Rapid Spanning Tree Protocol).
stp	Enables or disables STP (Spanning Tree Protocol).

Default RSTP is enabled by default for all switch ports.

Mode Global Configuration

Usage With no configuration, spanning tree is enabled, and the spanning tree mode is set to RSTP. To change the mode, see [spanning-tree mode](#) command.

Examples To enable STP in Global Configuration mode, enter the below commands:

```
awplus# configure terminal
awplus(config)# spanning-tree stp enable
```

To disable STP in Global Configuration mode, enter the below commands:

```
awplus# configure terminal
awplus(config)# no spanning-tree stp enable
```

To enable MSTP in Global Configuration mode, enter the below commands:

```
awplus# configure terminal
awplus(config)# spanning-tree mstp enable
```

To disable MSTP in Global Configuration mode, enter the below commands:

```
awplus# configure terminal
awplus(config)# no spanning-tree mstp enable
```

To enable RSTP in Global Configuration mode, enter the below commands:

```
awplus# configure terminal
awplus(config)# spanning-tree rstp enable
```

To disable RSTP in Global Configuration mode, enter the below commands:

```
awplus# configure terminal
```

```
awplus(config)# no spanning-tree rstp enable
```

**Related
Commands** [spanning-tree mode](#)

spanning-tree errdisable-timeout enable

Overview Use this command to enable the errdisable-timeout facility, which sets a timeout for ports that are disabled due to the BPDU guard feature.

Use this command for RSTP or MSTP.

Use the **no** variant of this command to disable the errdisable-timeout facility.

Syntax `spanning-tree errdisable-timeout enable`
`no spanning-tree errdisable-timeout enable`

Default By default, the errdisable-timeout is disabled.

Mode Global Configuration

Usage The BPDU guard feature shuts down the port on receiving a BPDU on a BPDU-guard enabled port. This command associates a timer with the feature such that the port is re-enabled without manual intervention after a set interval. This interval can be configured by the user using the [spanning-tree errdisable-timeout interval](#) command.

Example `awplus# configure terminal`
`awplus(config)# spanning-tree errdisable-timeout enable`

Related Commands [show spanning-tree](#)
[spanning-tree errdisable-timeout interval](#)
[spanning-tree portfast bpdu-guard](#)

spanning-tree errdisable-timeout interval

Overview Use this command to specify the time interval after which a port is brought back up when it has been disabled by the BPDU guard feature.

Use this command for RSTP or MSTP.

Syntax `spanning-tree errdisable-timeout interval <10-1000000>`
`no spanning-tree errdisable-timeout interval`

Parameter	Description
<code><10-1000000></code>	Specify the errdisable-timeout interval in seconds.

Default By default, the port is re-enabled after 300 seconds.

Mode Global Configuration

Example `awplus# configure terminal`
`awplus(config)# spanning-tree errdisable-timeout interval 34`

Related Commands [show spanning-tree](#)
[spanning-tree errdisable-timeout enable](#)
[spanning-tree portfast bpdu-guard](#)

spanning-tree force-version

Overview Use this command in Interface Configuration mode for a switch port interface only to force the protocol version for the switch port. Use this command for RSTP or MSTP only.

Syntax `spanning-tree force-version <version>`
`no spanning-tree force-version`

Parameter	Description
<version>	<0-3> Version identifier.
0	Forces the port to operate in STP mode.
1	Not supported.
2	Forces the port to operate in RSTP mode. If it receives STP BPDUs, it can automatically revert to STP mode.
3	Forces the port to operate in MSTP mode (this option is only available if MSTP mode is configured). If it receives RSTP or STP BPDUs, it can automatically revert to RSTP or STP mode.

Default By default, no version is forced for the port. The port is in the spanning tree mode configured for the device, or a lower version if it automatically detects one.

Mode Interface Configuration mode for a switch port interface only.

Examples Set the value to enforce the spanning tree protocol (STP):

```
awplus# configure terminal
awplus(config)# interface port1.0.2
awplus(config-if)# spanning-tree force-version 0
```

Set the default protocol version:

```
awplus# configure terminal
awplus(config)# interface port1.0.2
awplus(config-if)# no spanning-tree force-version
```

Related Commands [show spanning-tree](#)

spanning-tree forward-time

Overview Use this command to set the forward delay value. Use the **no** variant of this command to reset the forward delay value to the default setting of 15 seconds.

The **forward delay** sets the time (in seconds) to control how fast a port changes its spanning tree state when moving towards the forwarding state. If the mode is set to STP, the value determines how long the port stays in each of the listening and learning states which precede the forwarding state. If the mode is set to RSTP or MSTP, this value determines the maximum time taken to transition from discarding to learning and from learning to forwarding.

This value is used only when the device is acting as the root bridge. Devices not acting as the Root Bridge use a dynamic value for the **forward delay** set by the root bridge. The **forward delay**, **max-age**, and **hello time** parameters are interrelated.

Syntax `spanning-tree forward-time <forward-delay>`
`no spanning-tree forward-time`

Parameter	Description
<code><forward-delay></code>	<code><4-30></code> The forwarding time delay in seconds.

Default The default is 15 seconds.

Mode Global Configuration

Usage The allowable range for forward-time is 4-30 seconds.

The **forward delay**, **max-age**, and **hello time** parameters should be set according to the following formula, as specified in IEEE Standard 802.1d:

$2 \times (\text{forward delay} - 1.0 \text{ seconds}) \geq \text{max-age}$

$\text{max-age} \geq 2 \times (\text{hello time} + 1.0 \text{ seconds})$

Example

```
awplus# configure terminal
awplus(config)# spanning-tree forward-time 6
```

Related Commands [show spanning-tree](#)
[spanning-tree forward-time](#)
[spanning-tree hello-time](#)
[spanning-tree mode](#)

spanning-tree guard root

Overview Use this command in Interface Configuration mode for a switch port only to enable the Root Guard feature for the switch port. The root guard feature disables reception of superior BPDUs. You can use this command for RSTP, STP or MSTP.

Use the **no** variant of this command to disable the root guard feature for the port.

Syntax `spanning-tree guard root`
`no spanning-tree guard root`

Mode Interface Configuration mode for a switch port interface only.

Usage The Root Guard feature makes sure that the port on which it is enabled is a designated port. If the Root Guard enabled port receives a superior BPDU, it goes to a Listening state (for STP) or discarding state (for RSTP and MSTP).

Example `awplus# configure terminal`
`awplus(config)# interface port1.0.2`
`awplus(config-if)# spanning-tree guard root`

spanning-tree hello-time

Overview Use this command to set the hello-time. This sets the time in seconds between the transmission of device spanning tree configuration information when the device is the Root Bridge of the spanning tree or is trying to become the Root Bridge.

Use this command for RSTP, STP or MSTP.

Use the **no** variant of this command to restore the default of the hello time.

Syntax `spanning-tree hello-time <hello-time>`
`no spanning-tree hello-time`

Parameter	Description
<code><hello-time></code>	<code><1-10></code> The hello BPDU interval in seconds.

Default Default is 2 seconds.

Mode Global Configuration and Interface Configuration for switch ports.

Usage The allowable range of values is 1-10 seconds.

The forward delay, max-age, and hello time parameters should be set according to the following formula, as specified in IEEE Standard 802.1d:

$2 \times (\text{forward delay} - 1.0 \text{ seconds}) \geq \text{max-age}$

$\text{max-age} \geq 2 \times (\text{hello time} + 1.0 \text{ seconds})$

Example `awplus# configure terminal`
`awplus(config)# spanning-tree hello-time 3`

Related Commands [spanning-tree forward-time](#)
[spanning-tree max-age](#)
[show spanning-tree](#)

spanning-tree link-type

Overview Use this command in Interface Configuration mode for a switch port interface only to enable or disable point-to-point or shared link types on the switch port.

Use this command for RSTP or MSTP only.

Use the **no** variant of this command to return the port to the default link type.

Syntax `spanning-tree link-type {point-to-point|shared}`
`no spanning-tree link-type`

Parameter	Description
shared	Disable rapid transition.
point-to-point	Enable rapid transition.

Default The default link type is point-to-point.

Mode Interface Configuration mode for a switch port interface only.

Usage You may want to set link type to shared if the port is connected to a hub with multiple devices connected to it.

Examples `awplus# configure terminal`
`awplus(config)# interface port1.0.2`
`awplus(config-if)# spanning-tree link-type point-to-point`

spanning-tree max-age

Overview Use this command to set the max-age. This sets the maximum age, in seconds, that dynamic spanning tree configuration information is stored in the device before it is discarded.

Use this command for RSTP, STP or MSTP.

Use the **no** variant of this command to restore the default of max-age.

Syntax `spanning-tree max-age <max-age>`
`no spanning-tree max-age`

Parameter	Description
<code><max-age></code>	<code><6-40></code> The maximum time, in seconds.

Default The default of spanning-tree max-age is 20 seconds.

Mode Global Configuration

Usage Max-age is the maximum time in seconds for which a message is considered valid. Configure this value sufficiently high, so that a frame generated by the root bridge can be propagated to the leaf nodes without exceeding the max-age.

The **forward delay**, **max-age**, and **hello time** parameters should be set according to the following formula, as specified in IEEE Standard 802.1d:

$2 \times (\text{forward delay} - 1.0 \text{ seconds}) \geq \text{max-age}$

$\text{max-age} \geq 2 \times (\text{hello time} + 1.0 \text{ seconds})$

Example `awplus# configure terminal`
`awplus(config)# spanning-tree max-age 12`

Related Commands [show spanning-tree](#)
[spanning-tree forward-time](#)
[spanning-tree hello-time](#)

spanning-tree max-hops (MSTP)

Overview Use this command to specify the maximum allowed hops for a BPDU in an MST region. This parameter is used by all the instances of the MST region.

Use the **no** variant of this command to restore the default.

Use this command for MSTP only.

Syntax `spanning-tree max-hops <hop-count>`
`no spanning-tree max-hops <hop-count>`

Parameter	Description
<code><hop-count></code>	Specify the maximum hops the BPDU will be valid for in the range <1-40>.

Default The default max-hops in a MST region is 20.

Mode Global Configuration

Usage Specifying the max hops for a BPDU prevents the messages from looping indefinitely in the network. The hop count is decremented by each receiving port. When a device receives an MST BPDU that has a hop count of zero, it discards the BPDU.

Examples

```
awplus# configure terminal
awplus(config)# spanning-tree max-hops 25
awplus# configure terminal
awplus(config)# no spanning-tree max-hops
```

spanning-tree mode

Overview Use this command to change the spanning tree protocol mode on the device. The spanning tree protocol mode on the device can be configured to either STP, RSTP or MSTP.

Syntax `spanning-tree mode {stp|rstp|mstp}`

Default The default spanning tree protocol mode on the device is RSTP.

Mode Global Configuration

Usage With no configuration, the device will have spanning tree enabled, and the spanning tree mode will be set to RSTP. Use this command to change the spanning tree protocol mode on the device. MSTP is VLAN aware, but RSTP and STP are not VLAN aware. To enable or disable spanning tree operation, see the [spanning-tree enable](#) command.

Examples To change the spanning tree mode from the default of RSTP to MSTP, use the following commands:

```
awplus# configure terminal
awplus(config)# spanning-tree mode mstp
```

Related Commands [spanning-tree enable](#)

spanning-tree mst configuration

Overview Use this command to enter the MST Configuration mode to configure the Multiple Spanning-Tree Protocol.

Syntax `spanning-tree mst configuration`

Mode Global Configuration

Examples The following example uses this command to enter MST Configuration mode. Note the change in the command prompt.

```
awplus# configure terminal
awplus(config)# spanning-tree mst configuration
awplus(config-mst)#
```

spanning-tree mst instance

Overview Use this command to assign a Multiple Spanning Tree instance (MSTI) to a switch port or channel group.

Note that ports are automatically configured to send and receive spanning-tree information for the associated MSTI when VLANs are assigned to MSTIs using the [instance vlan \(MSTP\)](#) command.

Use the **no** variant of this command in Interface Configuration mode to remove the MSTI from the specified switch port or channel group.

Syntax

```
spanning-tree mst instance <instance-id>  
no spanning-tree mst instance <instance-id>
```

Parameter	Description
<instance-id>	Specify an MSTP instance in the range 1-5. The MST instance must have already been created using the instance vlan (MSTP) command.

Default A port automatically becomes a member of an MSTI when it is assigned to a VLAN.

Mode Interface Configuration mode for a switch port or channel group.

Usage You can disable automatic configuration of member ports of a VLAN to an associated MSTI by using a **no spanning-tree mst instance** command to remove the member port from the MSTI. Use the **spanning-tree mst instance** command to add a VLAN member port back to the MSTI.

Examples To assign instance 3 to a switch port, use the commands:

```
awplus# configure terminal  
awplus(config)# interface port1.0.2  
awplus(config-if)# spanning-tree mst instance 3
```

To remove instance 3 from a switch port, use the commands:

```
awplus# configure terminal  
awplus(config)# interface port1.0.2  
awplus(config-if)# no spanning-tree mst instance 3
```

Related Commands

- [instance vlan \(MSTP\)](#)
- [spanning-tree mst instance path-cost](#)
- [spanning-tree mst instance priority](#)
- [spanning-tree mst instance restricted-role](#)
- [spanning-tree mst instance restricted-tcn](#)

spanning-tree mst instance path-cost

Overview Use this command to set the cost of a path associated with a switch port, for the specified MSTI.

This specifies the switch port's contribution to the cost of a path to the MSTI regional root via that port. This applies when the port is the root port for the MSTI.

Use the **no** variant of this command to restore the default cost value of the path.

Syntax `spanning-tree mst instance <instance-id> path-cost <path-cost>`
`no spanning-tree mst instance <instance-id> path-cost`

Parameter	Description
<code><instance-id></code>	Specify an MSTP instance in the range 1-5.
<code><path-cost></code>	Specify the cost of path in the range of <1-200000000>, where a lower path-cost indicates a greater likelihood of the specific interface becoming a root.

Default The default path cost values and the range of recommended path cost values depend on the port speed, as shown in the following table from the IEEE 802.1q-2003 standard.

Port speed	Default path cost	Recommended path cost range
Less than 100 Kb/s	200,000,000	20,000,000-200,000,000
1Mbps	20,000,000	2,000,000-20,000,000
10Mbps	2,000,000	200,000-2,000,000
100 Mbps	200,000	20,000-200,000
1 Gbps	20,000	2,000-20,000
10 Gbps	2,000	200-2,000
100 Gbps	200	20-200
1Tbps	20	2-200
10 Tbps	2	2-20

Mode Interface Configuration mode for a switch port interface only.

Usage Before you can use this command to set a path-cost in a VLAN configuration, you must explicitly add an MST instance to a port using the [spanning-tree mst instance](#) command.

Examples To set a path cost of 1000 on instance 3, use the commands:

```
awplus# configure terminal
awplus(config)# interface port1.0.2
awplus(config-if)# spanning-tree mst instance 3 path-cost 1000
```

To return the path cost to its default value on instance 3, use the commands:

```
awplus# configure terminal
awplus(config)# interface port1.0.2
awplus(config-if)# no spanning-tree mst instance 3 path-cost
```

**Related
Commands**

[instance vlan \(MSTP\)](#)
[spanning-tree mst instance](#)
[spanning-tree mst instance priority](#)
[spanning-tree mst instance restricted-role](#)
[spanning-tree mst instance restricted-tcn](#)

spanning-tree mst instance priority

Overview Use this command in Interface Configuration mode for a switch port interface only to set the port priority for an MST instance (MSTI).

Use the **no** variant of this command to restore the default priority value (128).

Syntax `spanning-tree mst instance <instance-id> priority <priority>`
`no spanning-tree mst instance <instance-id> [priority]`

Parameter	Description
<code><instance-id></code>	Specify an MSTP instance in the range 1-5.
<code><priority></code>	This must be a multiple of 16 and within the range <0-240>. A lower priority indicates greater likelihood of the port becoming the root port.

Default The default is 128.

Mode Interface Configuration mode for a switch port interface.

Usage This command sets the value of the priority field contained in the port identifier. The MST algorithm uses the port priority when determining the root port for the switch in the MSTI. The port with the lowest value has the highest priority, so it will be chosen as root port over a port that is equivalent in all other aspects but with a higher priority value.

Examples To set the priority to 112 on instance 3, use the commands:

```
awplus# configure terminal
awplus(config)# interface port1.0.2
awplus(config-if)# spanning-tree mst instance 3 priority 112
```

To return the priority to its default value of 128 on instance 3, use the commands:

```
awplus# configure terminal
awplus(config)# interface port1.0.2
awplus(config-if)# no spanning-tree mst instance 3 priority
```

Related Commands

- [instance vlan \(MSTP\)](#)
- [spanning-tree priority \(port priority\)](#)
- [spanning-tree mst instance](#)
- [spanning-tree mst instance path-cost](#)
- [spanning-tree mst instance restricted-role](#)
- [spanning-tree mst instance restricted-tcn](#)

spanning-tree mst instance restricted-role

Overview Use this command in Interface Configuration mode for a switch port interface only to enable the restricted role for an MSTI (Multiple Spanning Tree Instance) on a switch port. Configuring the restricted role for an MSTI on a switch port prevents the switch port from becoming the root port in a spanning tree topology.

Use the **no** variant of this command to disable the restricted role for an MSTI on a switch port. Removing the restricted role for an MSTI on a switch port allows the switch port to become the root port in a spanning tree topology.

Syntax `spanning-tree mst instance <instance-id> restricted-role`
`no spanning-tree mst instance <instance-id> restricted-role`

Parameter	Description
<code><instance-id></code>	Specify an MSTP instance in the range 1-5. The MST instance must have already been created using the instance vlan (MSTP) command.

Default The restricted role for an MSTI instance on a switch port is disabled by default.

Mode Interface Configuration mode for a switch port interface only.

Usage The root port is the port providing the best path from the bridge to the root bridge. Use this command to disable a port from becoming a root port. Use the **no** variant of this command to enable a port to become a root port. See the [STP Feature Overview and Configuration Guide](#) for root port information.

Examples To prevent a switch port from becoming the root port, use the commands:

```
awplus# configure terminal
awplus(config)# interface port1.0.2
awplus(config-if)# spanning-tree mst instance 3 restricted-role
```

To stop preventing the switch port from becoming the root port, use the commands:

```
awplus# configure terminal
awplus(config)# interface port1.0.2
awplus(config-if)# no spanning-tree mst instance 3
restricted-role
```

**Related
Commands** instance vlan (MSTP)
spanning-tree priority (port priority)
spanning-tree mst instance
spanning-tree mst instance path-cost
spanning-tree mst instance restricted-tcn

spanning-tree mst instance restricted-tcn

Overview Use this command to prevent a switch port from propagating received topology change notifications and topology changes to other switch ports. This is named restricted TCN (Topology Change Notification). A TCN is a simple Bridge Protocol Data Unit (BPDU) that a bridge sends out to its root port to signal a topology change.

Use the **no** variant of this command to stop preventing the switch port from propagating received topology change notifications and topology changes to other switch ports for the specified MSTI (Multiple Spanning Tree Instance).

The restricted TCN setting applies only to the specified MSTI (Multiple Spanning Tree Instance).

Syntax `spanning-tree mst instance <instance-id> restricted-tcn`
`no spanning-tree mst instance <instance-id> restricted-tcn`

Parameter	Description
<code><instance-id></code>	Specify an MSTP instance in the range 1-5. The MST instance must have already been created using the instance vlan (MSTP) command.

Default Disabled. By default, switch ports propagate TCNs.

Mode Interface Configuration mode for a switch port interface only.

Examples To prevent a switch port from propagating received topology change notifications and topology changes to other switch ports, use the commands:

```
awplus# configure terminal
awplus(config)# interface port1.0.2
awplus(config-if)# spanning-tree mst instance 3 restricted-tcn
```

To stop preventing a switch port from propagating received topology change notifications and topology changes to other switch ports, use the commands:

```
awplus# configure terminal
awplus(config)# interface port1.0.2
awplus(config-if)# no spanning-tree mst instance 3
restricted-tcn
```

Related Commands

- [instance vlan \(MSTP\)](#)
- [spanning-tree priority \(port priority\)](#)
- [spanning-tree mst instance](#)
- [spanning-tree mst instance path-cost](#)
- [spanning-tree mst instance restricted-role](#)

spanning-tree path-cost

Overview Use this command in Interface Configuration mode for a switch port interface only to set the cost of a path for the specified port. This value then combines with others along the path to the root bridge in order to determine the total cost path value from the particular port, to the root bridge. The lower the numeric value, the higher the priority of the path. This applies when the port is the root port.

Use this command for RSTP, STP or MSTP. When MSTP mode is configured, this will apply to the port's path cost for the CIST.

Syntax `spanning-tree path-cost <pathcost>`
`no spanning-tree path-cost`

Parameter	Description
<code><pathcost></code>	<code><1-200000000></code> The cost to be assigned to the port.

Default The default path cost values and the range of recommended path cost values depend on the port speed, as shown in the following table from the IEEE 802.1q-2003 and IEEE 802.1d-2004 standards.

Port speed	Default path cost	Recommended path cost range
Less than 100 Kb/s	200,000,000	20,000,000-200,000,000
1Mbps	20,000,000	2,000,000-20,000,000
10Mbps	2,000,000	200,000-2,000,000
100 Mbps	200,000	20,000-200,000
1 Gbps	20,000	2,000-20,000
10 Gbps	2,000	200-2,000
100 Gbps	200	20-200
1Tbps	20	2-200
10 Tbps	2	2-20

Mode Interface Configuration mode for switch port interface only.

Example `awplus# configure terminal`
`awplus(config)# interface port1.0.2`
`awplus(config-if)# spanning-tree path-cost 123`

spanning-tree portfast (STP)

Overview Use this command in Interface Configuration mode for a switch port interface only to set a port as an edge-port. The portfast feature enables a port to rapidly move to the forwarding state, without having first to pass through the intermediate spanning tree states. This command has the same effect as the [spanning-tree edgeport \(RSTP and MSTP\)](#) command, but the configuration displays differently in the output of some show commands.

NOTE: You can run either of two additional parameters with this command. To simplify the syntax these are documented as separate commands. See the following additional portfast commands:

- [spanning-tree portfast bpdu-filter](#) command
- [spanning-tree portfast bpdu-guard](#) command.

You can obtain the same effect by running the [spanning-tree edgeport \(RSTP and MSTP\)](#) command. However, the configuration output may display differently in some show commands.

Use the **no** variant of this command to set a port to its default state (not an edge-port).

Syntax `spanning-tree portfast`
`no spanning-tree portfast`

Default Not an edge port.

Mode Interface Configuration mode for a switch port interface only.

Usage Portfast makes a port move from a blocking state to a forwarding state, bypassing both listening and learning states. The portfast feature is meant to be used for ports connected to end-user devices. Enabling portfast on ports that are connected to a workstation or server allows devices to connect to the network without waiting for spanning-tree to converge.

For example, you may need hosts to receive a DHCP address quickly and waiting for STP to converge would cause the DHCP request to time out. Ensure you do not use portfast on any ports connected to another device to avoid creating a spanning-tree loop on the network.

Use this command on a switch port that connects to a LAN with no other bridges attached. An edge port should never receive BPDUs. Therefore if an edge port receives a BPDU, the portfast feature takes one of three actions.

- Cease to act as an edge port and pass BPDUs as a member of a spanning tree network ([spanning-tree portfast \(STP\)](#) command disabled).
- Filter out the BPDUs and pass only the data and continue to act as a edge port ([spanning-tree portfast bpdu-filter](#) command enabled).
- Block the port to all BPDUs and data ([spanning-tree portfast bpdu-guard](#) command enabled).

Example awplus# configure terminal
awplus(config)# interface port1.0.2
awplus(config-if)# spanning-tree portfast

**Related
Commands** spanning-tree edgeport (RSTP and MSTP)
show spanning-tree
spanning-tree portfast bpdu-filter
spanning-tree portfast bpdu-guard

spanning-tree portfast bpdu-filter

Overview This command sets the bpdu-filter feature and applies a filter to any BPDUs (Bridge Protocol Data Units) received. Enabling this feature ensures that configured ports will not transmit any BPDUs and will ignore (filter out) any BPDUs received. BPDU Filter is not enabled on a port by default.

Using the **no** variant of this command to turn off the bpdu-filter, but retain the port's status as an enabled port. If the port then receives a BPDU it will change its role from an **edge-port** to a **non edge-port**.

Syntax (Global Configuration)

```
spanning-tree portfast bpdu-filter  
no spanning-tree portfast bpdu-filter
```

Syntax (Interface Configuration)

```
spanning-tree portfast bpdu-filter {default|disable|enable}  
no spanning-tree portfast bpdu-filter
```

Parameter	Description
bpdu-filter	A port that has bpdu-filter enabled will not transmit any BPDUs and will ignore any BPDUs received. This port type has one of the following parameters (in Interface Configuration mode):
default	Takes the setting that has been configured for the whole device, i.e. the setting made from the Global configuration mode.
disable	Turns off BPDU filter.
enable	Turns on BPDU filter.

Default BPDU Filter is not enabled on any ports by default.

Mode Global Configuration and Interface Configuration

Usage This command filters the BPDUs and passes only data to continue to act as an edge port. Using this command in Global Configuration mode applies the portfast bpdu-filter feature to all ports on the device. Using it in Interface mode applies the feature to a specific port, or range of ports. The command will operate in both RSTP and MSTP networks.

Use the [show spanning-tree](#) command to display status of the bpdu-filter parameter for the switch ports.

Example To enable STP BPDU filtering in Global Configuration mode, enter the commands:

```
awplus# configure terminal  
awplus(config)# spanning-tree portfast bpdu-filter
```

To enable STP BPDU filtering in Interface Configuration mode, enter the commands:

```
awplus# configure terminal
awplus(config)# interface port1.0.2
awplus(config-if)# spanning-tree portfast bpdu-filter enable
```

**Related
Commands**

[spanning-tree edgeport \(RSTP and MSTP\)](#)
[show spanning-tree](#)
[spanning-tree portfast \(STP\)](#)
[spanning-tree portfast bpdu-guard](#)

spanning-tree portfast bpdu-guard

Overview The AR3050S and AR4050S devices don't support BPDU protection in 5.4.5-0.1 release.

This command applies a BPDU (Bridge Protocol Data Unit) guard to the port. A port with the bpdu-guard feature enabled will block all traffic (BPDUs and user data), if it starts receiving BPDUs.

Use this command in Global Configuration mode to apply BPDU guard to all ports on the device. Use this command in Interface mode for an individual interface or a range of interfaces specified. BPDU Guard is not enabled on a port by default.

Use the **no** variant of this command to disable the BPDU Guard feature on a device in Global Configuration mode or to disable the BPDU Guard feature on a port in Interface mode.

Syntax (Global Configuration)

```
spanning-tree portfast bpdu-guard  
no spanning-tree portfast bpdu-guard
```

Syntax (Interface Configuration)

```
spanning-tree portfast bpdu-guard {default|disable|enable}  
no spanning-tree portfast bpdu-guard
```

Parameter	Description
bpdu-guard	A port that has bpdu-guard turned on will enter the STP blocking state if it receives a BPDU. This port type has one of the following parameters (in Interface Configuration mode):
default	Takes the setting that has been configured for the whole device, i.e. the setting made from the Global configuration mode.
disable	Turns off BPDU guard.
enable	Turns on BPDU guard and will also set the port as an edge port.

Default BPDU Guard is not enabled on any ports by default.

Mode Global Configuration or Interface Configuration

Usage This command blocks the port(s) to all devices and data when enabled. BPDU Guard is a port-security feature that changes how a portfast-enabled port behaves if it receives a BPDU. When **bpdu-guard** is set, then the port shuts down if it receives a BPDU. It does not process the BPDU as it is considered suspicious. When **bpdu-guard** is not set, then the port will negotiate spanning-tree with the device sending the BPDUs. By default, bpdu-guard is not enabled on a port.

You can configure a port disabled by the bpdu-guard to re-enable itself after a specific time interval. This interval is set with the [spanning-tree errdisable-timeout](#)

`interval` command. If you do not use the **errdisable-timeout** feature, then you will need to manually re-enable the port by using the **no shutdown** command.

Use the `show spanning-tree` command to display the device and port configurations for the BPDU Guard feature. It shows both the administratively configured and currently running values of `bpdu-guard`.

Example To enable STP BPDU guard in Global Configuration mode, enter the below commands:

```
awplus# configure terminal
awplus(config)# spanning-tree portfast bpdu-guard
```

To enable STP BPDU guard in Interface Configuration mode, enter the below commands:

```
awplus# configure terminal
awplus(config)# interface port1.0.2
awplus(config-if)# spanning-tree portfast bpdu-guard enable
```

Related Commands

- `spanning-tree edgeport (RSTP and MSTP)`
- `show spanning-tree`
- `spanning-tree portfast (STP)`
- `spanning-tree portfast bpdu-filter`

spanning-tree priority (bridge priority)

Overview Use this command to set the bridge priority for the device. A lower priority value indicates a greater likelihood of the device becoming the root bridge.

Use this command for RSTP, STP or MSTP. When MSTP mode is configured, this will apply to the CIST.

Use the **no** variant of this command to reset it to the default.

Syntax `spanning-tree priority <priority>`
`no spanning-tree priority`

Parameter	Description
<code><priority></code>	<code><0-61440></code> The bridge priority, which will be rounded to a multiple of 4096.

Default The default priority is 32678.

Mode Global Configuration

Usage To force a particular device to become the root bridge use a lower value than other devices in the spanning tree.

Example `awplus# configure terminal`
`awplus(config)# spanning-tree priority 4096`

Related Commands [spanning-tree mst instance priority](#)
[show spanning-tree](#)

spanning-tree priority (port priority)

Overview Use this command in Interface Configuration mode for a switch port interface only to set the port priority for port. A lower priority value indicates a greater likelihood of the port becoming part of the active topology.

Use this command for RSTP, STP, or MSTP. When the device is in MSTP mode, this will apply to the CIST.

Use the **no** variant of this command to reset it to the default.

Syntax `spanning-tree priority <priority>`
`no spanning-tree priority`

Parameter	Description
<code><priority></code>	<code><0-240></code> , in increments of 16. The port priority, which will be rounded down to a multiple of 16.

Default The default priority is 128.

Mode Interface Configuration mode for a switch port interface only.

Usage To force a port to be part of the active topology (for instance, become the root port or a designated port) use a lower value than other ports on the device. (This behavior is subject to network topology, and more significant factors, such as bridge ID.)

Example

```
awplus# configure terminal
awplus(config)# interface port1.0.2
awplus(config-if)# spanning-tree priority 16
```

Related Commands

- [spanning-tree mst instance priority](#)
- [spanning-tree priority \(bridge priority\)](#)
- [show spanning-tree](#)

spanning-tree restricted-role

Overview Use this command in Interface Configuration mode for a switch port interface only to restrict the port from becoming a root port.

Use the **no** variant of this command to disable the restricted role functionality.

Syntax `spanning-tree restricted-role`
`no spanning-tree restricted-role`

Default The restricted role is disabled.

Mode Interface Configuration mode for a switch port interface only.

Example

```
awplus# configure terminal
awplus(config)# interface port1.0.2
awplus(config-if)# spanning-tree restricted-role
```

spanning-tree restricted-tcn

Overview Use this command in Interface Configuration mode for a switch port interface only to prevent TCN (Topology Change Notification) BPDUs (Bridge Protocol Data Units) from being sent on a port. If this command is enabled, after a topology change a bridge is prevented from sending a TCN to its designated bridge.

Use the **no** variant of this command to disable the restricted TCN functionality.

Syntax `spanning-tree restricted-tcn`
`no spanning-tree restricted-tcn`

Default The restricted TCN is disabled.

Mode Interface Configuration mode for a switch port interface only.

Example `awplus# configure terminal`
`awplus(config)# interface port1.0.2`
`awplus(config-if)# spanning-tree restricted-tcn`

spanning-tree transmit-holdcount

Overview Use this command to set the maximum number of BPDU transmissions that are held back.

Use the **no** variant of this command to restore the default transmit hold-count value.

Syntax `spanning-tree transmit-holdcount`
`no spanning-tree transmit-holdcount`

Default Transmit hold-count default is 3.

Mode Global Configuration

Example `awplus# configure terminal`
`awplus(config)# spanning-tree transmit-holdcount`

undebbug mstp

Overview This command applies the functionality of the no `debug mstp` (RSTP and STP) command.

19

Link Aggregation Commands

Introduction

Overview This chapter provides an alphabetical reference of commands used to configure a static channel group (static aggregator) and dynamic channel group (LACP channel group, etherchannel or LACP aggregator). Link aggregation is also sometimes referred to as channeling.

NOTE: *AlliedWare Plus™ supports IEEE 802.3ad link aggregation and uses the Link Aggregation Control Protocol (LACP). LACP does not interoperate with devices that use Port Aggregation Protocol (PAgP).*

Link aggregation does not necessarily achieve exact load balancing across the links. The load sharing algorithm is designed to ensure that any given data flow always goes down the same link. It also aims to spread data flows across the links as evenly as possible.

For example, for a 2 Gbps LAG that is a combination of two 1 Gbps ports, any one flow of traffic can only ever reach a maximum throughput of 1 Gbps. However, the hashing algorithm should spread the flows across the links so that when many flows are operating, the full 2 Gbps can be utilized.

For a description of static and dynamic link aggregation (LACP), and configuration examples, see the [Link Aggregation Feature Overview and Configuration Guide](#).

- Command List**
- “channel-group” on page 583
 - “clear lacp counters” on page 585
 - “debug lacp” on page 586
 - “lacp global-passive-mode enable” on page 587
 - “lacp port-priority” on page 588
 - “lacp system-priority” on page 589
 - “lacp timeout” on page 590
 - “show debugging lacp” on page 592
 - “show diagnostic channel-group” on page 593

- [“show etherchannel”](#) on page 594
- [“show etherchannel detail”](#) on page 595
- [“show etherchannel summary”](#) on page 596
- [“show lacp sys-id”](#) on page 597
- [“show lacp-counter”](#) on page 598
- [“show port etherchannel”](#) on page 599
- [“show static-channel-group”](#) on page 600
- [“static-channel-group”](#) on page 601
- [“undebbug lacp”](#) on page 603

channel-group

Overview Use this command to either create a new dynamic channel group while at the same time adding a port to it, or to add a port to an existing dynamic channel group. Note that you must also set the LACP mode to be either active or passive.

You can create up to 2 dynamic (LACP) channel groups (or up to 2 static channel groups).

Use the **no** variant of this command to turn off link aggregation on the device port. You will be returned to Global Configuration mode from Interface Configuration mode.

Syntax

```
channel-group <dynamic-channel-group-number> mode  
{active|passive}  
  
no channel-group
```

Parameter	Description
<dynamic-channel-group-number>	<1-32> Specify a dynamic channel group number for an LACP link. You can create up to 2 dynamic (LACP) channel groups (in addition to up to 2 static channel groups). Each channel group can include up to 4 ports.
active	Enables initiation of LACP negotiation on a port. The port will transmit LACP dialogue messages whether or not it receives them from the partner device.
passive	Disables initiation of LACP negotiation on a port. The port will only transmit LACP dialogue messages if the partner device is transmitting them, i.e., the partner is in the active mode.

Mode Interface Configuration

Usage All the device ports in a channel-group must belong to the same VLANs, have the same tagging status, and can only be operated on as a group. All device ports within a channel group must have the same port speed and be in full duplex mode.

Once the LACP channel group has been created, it is treated as a device port, and can be referred to in most other commands that apply to device ports.

To refer to an LACP channel group in other LACP commands, use the channel group number. To specify an LACP channel group (LACP aggregator) in other commands, prefix the channel group number with **po**. For example, 'po2' refers to the LACP channel group with channel group number 2.

For more information about LACP, see the [Link Aggregation Feature Overview and Configuration Guide](#) which is available on our website at alliedtelesis.com.

Examples To add device port1.0.6 to a newly created LACP channel group 2 use the commands below:

```
awplus# configure terminal
awplus(config)# interface port1.0.6
awplus(config-if)# channel-group 2 mode active
```

To remove device port1.0.6 from any created LACP channel groups use the command below:

```
awplus# configure terminal
awplus(config)# interface port1.0.6
awplus(config-if)# no channel-group
```

To reference channel group 2 as an interface, use the following commands:

```
awplus# configure terminal
awplus(config)# interface po2
awplus(config-if)#
```

Related Commands

- [show etherchannel](#)
- [show etherchannel detail](#)
- [show etherchannel summary](#)
- [show port etherchannel](#)

clear lacp counters

Overview Use this command to clear all counters of all present LACP aggregators (channel groups) or a given LACP aggregator.

Syntax `clear lacp [<1-32>] counters`

Parameter	Description
<1-32>	Channel-group number.

Mode Privileged Exec

Example `awplus# clear lacp 2 counters`

debug lacp

Overview Use this command to enable all LACP troubleshooting functions.

Use the **no** variant of this command to disable this function.

Syntax `debug lacp {all|cli|event|ha|packet|sync|timer[detail]}`
`no debug lacp {all|cli|event|ha|packet|sync|timer[detail]}`

Parameter	Description
all	Turn on all debugging for LACP.
cli	Specifies debugging for CLI messages. Echoes commands to the console.
event	Specifies debugging for LACP events. Echoes events to the console.
ha	Specifies debugging for HA (High Availability) events. Echoes High Availability events to the console.
packet	Specifies debugging for LACP packets. Echoes packet contents to the console.
sync	Specifies debugging for LACP synchronization. Echoes synchronization to the console.
timer	Specifies debugging for LACP timer. Echoes timer expiry to the console.
detail	Optional parameter for LACP timer-detail. Echoes timer start/stop details to the console.

Mode Privileged Exec and Global Configuration

Examples `awplus# debug lacp timer detail`
`awplus# debug lacp all`

Related Commands [show debugging lacp](#)
[undebug lacp](#)

lacp global-passive-mode enable

Overview Use this command to enable LACP channel-groups to dynamically self-configure when they are connected to another device that has LACP channel-groups configured with Active Mode.

Syntax lacp global-passive-mode enable
no lacp global-passive-mode enable

Default Enabled

Mode Global Configuration

Usage Do not mix LACP configurations (manual and dynamic). When LACP global passive mode is turned on (by using the **lacp global-passive-mode enable** command), we do not recommend using a mixed configuration in a LACP channel-group; i.e. some links are manually configured (by the **channel-group** command) and others are dynamically learned in the same channel-group.

Example To enable global passive mode for LACP channel groups, use the command:

```
awplus(config)# lacp global-passive-mode enable
```

To disable global passive mode for LACP channel groups, use the command:

```
awplus(config)# no lacp global-passive-mode enable
```

Related Commands [show etherchannel](#)
[show etherchannel detail](#)

lacp port-priority

Overview Use this command to set the priority of a device port. Ports are selected for aggregation based on their priority, with the higher priority (numerically lower) ports selected first.

Use the **no** variant of this command to reset the priority of port to the default.

Syntax lacp port-priority <1-65535>
no lacp port-priority

Parameter	Description
<1-65535>	Specify the LACP port priority.

Default The default is 32768.

Mode Interface Configuration

Example awplus# configure terminal
awplus(config)# interface port1.0.5
awplus(config-if)# lacp port-priority 34

lacp system-priority

Overview Use this command to set the system priority of a local system. This is used in determining the system responsible for resolving conflicts in the choice of aggregation groups.

Use the **no** variant of this command to reset the system priority of the local system to the default.

Syntax lacp system-priority <1-65535>
no lacp system-priority

Parameter	Description
<1-65535>	LACP system priority. Lower numerical values have higher priorities.

Default The default is 32768.

Mode Global Configuration

Example awplus# configure terminal
awplus(config)# lacp system-priority 6700

lacp timeout

Overview Use this command to set the short or long timeout on a port. Ports will time out of the aggregation if three consecutive updates are lost.

Syntax lacp timeout {short|long}

Parameter	Description
timeout	Number of seconds before invalidating a received LACP data unit (DU).
short	LACP short timeout. The short timeout value is 1 second.
long	LACP long timeout. The long timeout value is 30 seconds.

Default The default is **long** timeout (30 seconds).

Mode Interface Configuration

Usage This command enables the device to indicate the rate at which it expects to receive LACPDUs from its neighbor.

If the timeout is set to **long**, then the device expects to receive an update every **30** seconds, and this will time a port out of the aggregation if no updates are seen for 90 seconds (i.e. 3 consecutive updates are lost).

If the timeout is set to **short**, then the device expects to receive an update every second, and this will time a port a port out of the aggregation if no updates are seen for 3 seconds (i.e. 3 consecutive updates are lost).

The device indicates its preference by means of the Timeout field in the Actor section of its LACPDUs. If the Timeout field is set to 1, then the device has set the **short** timeout. If the Timeout field is set to 0, then the device has set the **long** timeout.

Setting the **short** timeout enables the device to be more responsive to communication failure on a link, and does not add too much processing overhead to the device (1 packet per second).

NOTE: It is not possible to configure the rate that the device sends LACPDUs; the device must send at the rate which the neighbor indicates it expects to receive LACPDUs.

Examples The following commands set the LACP long timeout period for 30 seconds on port1.0.2.

```
awplus# configure terminal
awplus(config)# interface port1.0.2
awplus(config-if)# lacp timeout long
```

The following commands set the LACP short timeout for 1 second on port1.0.2.

```
awplus# configure terminal
awplus(config)# interface port1.0.2
awplus(config-if)# lacp timeout short
```

show debugging lacp

Overview Use this command to display the LACP debugging option set.

For information on filtering and saving command output, see the [“Getting Started with AlliedWare Plus” Feature Overview and Configuration Guide](#).

Syntax `show debugging lacp`

Mode User Exec and Privileged Exec

Example `awplus# show debugging lacp`

Output Figure 19-1: Example output from the **show debugging lacp** command

```
LACP debugging status:
LACP timer debugging is on
LACP timer-detail debugging is on
LACP cli debugging is on
LACP packet debugging is on
LACP event debugging is on
LACP sync debugging is on
```

Related Commands [debug lacp](#)

show diagnostic channel-group

Overview This command displays dynamic and static channel group interface status information. The output of this command is useful for Allied Telesis authorized service personnel for diagnostic purposes.

For information on filtering and saving command output, see the [“Getting Started with AlliedWare Plus” Feature Overview and Configuration Guide](#).

Syntax `show diagnostic channel-group`

Mode User Exec and Privileged Exec

Example `awplus# show diagnostic channel-group`

Output Figure 19-2: Example output from the **show diagnostic channel-group** command

```
awplus# show diagnostic channel-group

Channel Group Info based on NSM:
Note: Pos - position in hardware table
-----
Dev  Interface  IfIndex  Member port  IfIndex  Active  Pos
-----
    po1       4601     port1.0.4   5004        No
    po1       4601     port1.0.5   5005        No

Channel Group Info based on HSL:
Note: Pos - position in hardware table
-----
Dev  Interface  IfIndex  Member port  IfIndex  Active  Pos
-----
    po1       4601                                N/a

Channel Group Info based on IPIFWD:
Note: Pos - position in hardware table
-----
Dev  Interface  IfIndex  Member port  IfIndex  Active  Pos
-----
    po1       4601                                N/a

No error found
```

Related Commands [show tech-support](#)

show etherchannel

Overview Use this command to display information about a LACP channel specified by the channel group number.

For information on filtering and saving command output, see the [“Getting Started with AlliedWare Plus” Feature Overview and Configuration Guide](#), which is available on our website at alliedtelesis.com.

Syntax show etherchannel [<1-32>]

Parameter	Description
<1-32>	Channel-group number.

Mode User Exec and Privileged Exec

Example awplus# show etherchannel

Output Figure 19-3: Example output from **show etherchannel**

```
awplus#show etherchannel
LAG Maximum          : 2
LAG Static Maximum: 2
LAG Dynamic Maximum: 2
LAG Static Count     : 0
LAG Dynamic Count    : 1
LAG Total Count      : 1
Lacp Aggregator: pol
Member:
  port1.0.1
  port1.0.2
```

Example awplus# show etherchannel 1

Output Figure 19-4: Example output from **show etherchannel** for a particular channel

```
awplus#show etherchannel 1
Aggregator pol (4601)
  Mac address: 00:00:00:00:00:00
  Admin Key: 0001 - Oper Key 0000
  Receive link count: 0 - Transmit link count: 0
  Individual: 0 - Ready: 0
  Partner LAG: 0x0000,00-00-00-00-00-00
  Link: port1.0.1 (5001) disabled
  Link: port1.0.2 (5002) disabled
```

show etherchannel detail

Overview Use this command to display detailed information about all LACP channels. For information on filtering and saving command output, see the [“Getting Started with AlliedWare Plus” Feature Overview and Configuration Guide](#), which is available on our website at alliedtelesis.com.

Syntax `show etherchannel detail`

Mode User Exec and Privileged Exec

Example `awplus# show etherchannel detail`

Output Example output from **show etherchannel detail**

```
awplus#show etherchannel detail
Aggregator po1 (IfIndex: 4601)
  Mac address: 00:00:cd:37:05:17
  Admin Key: 0001 - Oper Key 0001
  Receive link count: 2 - Transmit link count: 2
  Individual: 0 - Ready: 1
  Partner LAG: 0x8000,00-00-cd-37-02-9a,0x0001
    Link: port1.0.1 (IfIndex: 8002) synchronized
    Link: port1.0.2 (IfIndex: 20002) synchronized
Aggregator po2 (IfIndex: 4602)
  Mac address: 00:00:cd:37:05:17
  Admin Key: 0002 - Oper Key 0002
  Receive link count: 2 - Transmit link count: 2
  Individual: 0 - Ready: 1
  Partner LAG: 0x8000,ec-cd-6d-aa-c8-56,0x0002
    Link: port1.0.3 (IfIndex: 8001) synchronized
    Link: port1.0.4 (IfIndex: 20001) synchronized
```

show etherchannel summary

Overview Use this command to display a summary of all LACP channels.

For information on filtering and saving command output, see the [“Getting Started with AlliedWare Plus” Feature Overview and Configuration Guide](#), which is available on our website at alliedtelesis.com.

Syntax `show etherchannel summary`

Mode User Exec and Privileged Exec

Example `awplus# show etherchannel summary`

Output Example output from **show etherchannel summary**

```
awplus#show etherchannel summary
Aggregator po10 (IfIndex: 4610)
Admin Key: 0010 - Oper Key 0010
  Link: port1.0.1 (IfIndex: 7007) synchronized
  Link: port1.0.2 (IfIndex: 8007) synchronized
  Link: port1.0.3 (IfIndex: 11007) synchronized
```

show lacp sys-id

Overview Use this command to display the LACP system ID and priority.

For information on filtering and saving command output, see the [“Getting Started with AlliedWare Plus” Feature Overview and Configuration Guide](#), which is available on our website at alliedtelesis.com.

Syntax `show lacp sys-id`

Mode User Exec and Privileged Exec

Example `awplus# show lacp sys-id`

Output Example output from **show lacp sys-id**

```
System Priority: 0x8000 (32768)
MAC Address: 0200.0034.5684
```

show lacp-counter

Overview Use this command to display the packet traffic on all ports of all present LACP aggregators, or a given LACP aggregator.

For information on filtering and saving command output, see the [“Getting Started with AlliedWare Plus” Feature Overview and Configuration Guide](#), which is available on our website at alliedtelesis.com.

Syntax `show lacp-counter [<1-32>]`

Parameter	Description
<1-32>	Channel-group number.

Mode User Exec and Privileged Exec

Example `awplus# show lacp-counter 2`

Output Example output from **show lacp-counter**

```
% Traffic statistics
Port          LACPDU      Marker      Pckt err
              Sent   Recv   Sent   Recv   Sent   Recv
% Aggregator po2 (IfIndex: 4604)
port1.0.2    0      0      0      0      0      0
```

show port etherchannel

Overview Use this command to show LACP details of the device port specified.

For information on filtering and saving command output, see the [“Getting Started with AlliedWare Plus” Feature Overview and Configuration Guide](#), which is available on our website at alliedtelesis.com.

Syntax `show port etherchannel <port>`

Parameter	Description
<code><port></code>	Name of the device port to display LACP information about.

Mode User Exec and Privileged Exec

Example `awplus# show port etherchannel port1.0.2`

Output Example output from **show port etherchannel**

```
awplus#show port etherchannel port1.0.2
LACP link info: port1.0.2 - 7007
Link: port1.0.2 (IfIndex: 7007)
Aggregator: po10 (IfIndex: 4610)
Receive machine state: Current
Periodic Transmission machine state: Slow periodic
Mux machine state: Collecting/Distributing
Actor Information:
Selected ..... Selected
Physical Admin Key ..... 2
Port Key ..... 10
Port Priority ..... 32768
Port Number ..... 7007
Mode ..... Active
Timeout ..... Long
Individual ..... Yes
Synchronised ..... Yes
Collecting ..... Yes
Distributing ..... Yes
Defaulted ..... No
Expired ..... No
Partner Information:
Partner Sys Priority ..... 0x8000
Partner System .. ec-cd-6d-d1-64-d0
Port Key ..... 10
Port Priority ..... 32768
Port Number ..... 5001
Mode ..... Active
Timeout ..... Long
Individual ..... Yes
Synchronised ..... Yes
Collecting ..... Yes
Distributing ..... Yes
Defaulted ..... No
Expired ..... No
```

show static-channel-group

Overview Use this command to display all configured static channel groups and their corresponding member ports. Note that a static channel group is the same as a static aggregator.

For information on filtering and saving command output, see the [“Getting Started with AlliedWare Plus” Feature Overview and Configuration Guide](#), which is available on our website at alliedtelesis.com.

Syntax `show static-channel-group`

Mode User Exec and Privileged Exec

Example `awplus# show static-channel-group`

Output Example output from **show static-channel-group**

```
awplus#show static-channel-group
LAG Maximum      : 2
LAG Static  Maximum: 2
LAG Dynamic Maximum: 2
LAG Static  Count  : 0
LAG Dynamic Count  : 1
LAG Total   Count  : 1
```

Related Commands [static-channel-group](#)

static-channel-group

Overview Use this command to create a static channel group, or add a member port to an existing static channel group. Static channel groups are also known as static aggregators.

You can create up to 2 static channel groups (or up to 2 dynamic channel groups).

Use the **no** variant of this command to remove the device port from the static channel group.

Syntax `static-channel-group <static-channel-group-number>`
`[member-filters]`
`no static-channel-group`

Parameter	Description
<code><static-channel-group-number></code>	<1-96> Static channel group number.
<code>member-filters</code>	Allow QoS and ACL settings to be configured on the aggregator's individual member ports, instead of the aggregator itself. This configuration is required when using QoS Storm Protection on a static aggregator.

Mode Interface Configuration

Usage This command adds the device port to the static channel group with the specified channel group number. If the channel group does not exist, it is created, and the port is added to it. The **no** prefix detaches the port from the static channel group. If the port is the last member to be removed, the static channel group is deleted.

All the ports in a channel group must have the same VLAN configuration: they must belong to the same VLANs and have the same tagging status, and can only be operated on as a group.

Once the static channel group has been created, it is treated as a device port, and can be referred to in other commands that apply to device ports.

To refer to a static channel group in other static channel group commands, use the channel group number. To specify a static channel group in other commands, prefix the channel group number with **sa**. For example, 'sa2' refers to the static channel group with channel group number 2.

Examples To define static channel group 2 on a device port, use the commands:

```
awplus# configure terminal
awplus(config)# interface port1.0.4
awplus(config-if)# static-channel-group 2
```

To reference static channel group 2 as an interface, use the commands:

```
awplus# configure terminal
awplus(config)# interface sa2
awplus(config-if)#
```

**Related
Commands** [show static-channel-group](#)

undebbug lacp

Overview This command applies the functionality of the no `debug lacp` command.

20

802.1Q Encapsulation Commands

Introduction

This chapter provides an alphabetical reference of commands used to configure 802.1Q Encapsulation. For more information, see the [AAA and Port Authentication Feature Overview and Configuration Guide](#).

Command List • “encapsulation dot1q” on page 605

encapsulation dot1q

Overview Use this command to enable 802.1Q encapsulation on Ethernet interfaces or L2 tunnel interfaces—OpenVPN and L2TPv3 Ethernet pseudowire.

Use the no variant of this command to disable 802.1Q encapsulation for the VLAN identified by the VLAN ID (VID).

Syntax `encapsulation dot1q <vid>`
`no encapsulation dot1q <vid>`

Parameter	Description
<code><vid></code>	Enter a VLAN ID in the range from 1 through 4094. The VLAN ID identifies the VLAN to which the frames belong. It also identifies the index of the subinterface of the Ethernet interface or Layer 2 tunnel interface.

Default 802.1Q encapsulation is disabled by default on any Ethernet interface or Layer 2 tunnel interface.

Mode Interface Configuration

Usage You should enter the Ethernet interface or tunnel interface configuration mode to enable 802.1Q encapsulation and configure the VID first. Then you can use the VID to configure the subinterface associated with the Ethernet interface or tunnel interface. Subinterfaces are logical interfaces. The subinterface index must be the same as the VID. For example, if you configure VID 1 for eth1, then the subinterface for eth1 is eth1.1. If you configure VID 2 for tunnel20, then the subinterface for tunnel20 is tunnel20.2.

Examples To enable 802.1Q encapsulation on Ethernet interface eth1, use the commands:

```
awplus#configure terminal
awplus(config)#interface eth1
awplus(config-if)#encapsulation dot1q 1
```

To enable 802.1Q encapsulation on tunnel interface tunnel20, use the commands:

```
awplus#configure terminal
awplus(config)#interface tunnel20
awplus(config-if)#encapsulation dot1q 2
```

To enable multiple 802.1Q encapsulation on Ethernet interface eth2, use the commands:

```
awplus#configure terminal
awplus(config)#interface eth2
awplus(config-if)#encapsulation dot1q 1
awplus(config-if)#encapsulation dot1q 2
awplus(config-if)#encapsulation dot1q 3
```

To disable 802.1Q encapsulation on eth1, use the commands:

```
awplus#configure terminal
awplus(config)#interface eth1
awplus(config-if)#no encapsulation dot1q 1
```

Related Commands [interface \(to configure\)](#)

Validation Commands [show interface](#)

21

PPP Commands

Introduction

Overview This chapter provides an alphabetical reference of commands used to configure and validate the PPP (Point-To-Point) protocol. For more information about PPP, see the [Point-to-Point Protocol \(PPP\) Feature Overview and Configuration Guide](#).

- Command List**
- [“debug ppp”](#) on page 609
 - [“encapsulation ppp”](#) on page 612
 - [“interface \(PPP\)”](#) on page 614
 - [“ip address negotiated”](#) on page 615
 - [“ip tcp adjust-mss”](#) on page 617
 - [“ip unnumbered”](#) on page 619
 - [“ipv6 tcp adjust-mss”](#) on page 621
 - [“keepalive \(PPP\)”](#) on page 623
 - [“mtu \(PPP\)”](#) on page 625
 - [“peer default ip address”](#) on page 626
 - [“peer neighbor-route”](#) on page 628
 - [“ppp authentication”](#) on page 630
 - [“ppp authentication refuse”](#) on page 632
 - [“ppp hostname”](#) on page 634
 - [“ppp ipcp dns”](#) on page 636
 - [“ppp ipcp dns suffix-list”](#) on page 638
 - [“ppp ipcp ip-override”](#) on page 640
 - [“ppp password”](#) on page 641
 - [“ppp service-name \(PPPoE\)”](#) on page 642

- [“ppp timeout idle”](#) on page 643
- [“ppp username”](#) on page 644
- [“show debugging ppp”](#) on page 645
- [“show interface \(PPP\)”](#) on page 646
- [“undebug ppp”](#) on page 650

debug ppp

Overview Use this command to enable PPP protocol debugging on an optionally specified PPP interface or range of PPP interfaces to analyze PPP behavior when diagnosing PPP connectivity issues. If no interface is specified then debugging for all PPP interfaces is enabled.

Use the **no** variant of this command to disable PPP protocol debugging on the specified PPP interface. If no PPP interface is specified then PPP debugging for all PPP interfaces is disabled.

Syntax `debug ppp [interface <ppp-interface-list>]`
`no debug ppp [interface <ppp-interface-list>]`

Parameter	Description
<code><ppp-interface- list></code>	Specify a PPP interface or a range of PPP interfaces in the range ppp<0-255>. Use a hyphen between PPP interfaces to include all PPP interfaces in a given range, or use commas between PPP interfaces to specify non-contiguous PPP interfaces.

Default No diagnostic messages are enabled for PPP debugging. PPP debugging is disabled by default.

Mode Global Configuration and Privileged Exec

Usage Debugging messages are sent to the logging system and can be viewed in log output, filtered in permanent or buffered logs, and viewed on the terminal using the [terminal monitor](#) command. See the status of PPP debugging with the [show debugging ppp](#) command.

Note that debugging output for PPP shows packet debugging and events debugging, see output below.

Note that disabling all debugging with the [no debug all](#) or the [undebug all](#) commands also disables PPP debugging configured with this command.

Note that the negated form of this command is an alias of the [undebug ppp](#) command.

Examples To enable PPP debugging on all PPP interfaces and send diagnostic messages to the system log, use the below command:

```
awplus# debug ppp
```

To enable PPP debugging on PPP interfaces ppp0 through ppp2 and display them on the console, use the below commands:

```
awplus# terminal monitor
```

```
awplus# debug ppp interface ppp0-ppp2
```

Output of packet debugging

Figure 21-1: Example output from the **debug ppp** command on the console

```
awplus#terminal monitor
awplus#debug ppp

05:35:46 awplus pppd[24767]: [ppp0] [05:35:46.901] sent [IPCP
ConfReq id=0x1 <addr
0.0.0.0> <ms-dns1 0.0.0.0> <ms-dns2 0.0.0.0>]
05:35:46 awplus pppd[24767]: [ppp0] [05:35:46.901] sent [IPV6CP
ConfReq id=0x1
<addr fe80::eecd:6dff:fe3a:0d23>]
05:35:46 awplus pppd[24767]: [ppp0] [05:35:46.901] rcvd [LCP
ConfAck id=0x1 <magic
0xd9153444>]
05:35:46 awplus pppd[24767]: [ppp0] [05:35:46.919] rcvd [IPCP
ConfReq id=0x1 <addr
192.168.1.1>]
05:35:46 awplus pppd[24767]: [ppp0] [05:35:46.919] sent [IPCP
ConfAck id=0x1 <addr
192.168.1.1>]
05:35:46 awplus pppd[24767]: [ppp0] [05:35:46.919] rcvd [IPCP
ConfNak id=0x1 <addr
192.168.1.2> <ms-dns1 1.1.1.1> <ms-dns2 2.2.2.2>]
05:35:46 awplus pppd[24767]: [ppp0] [05:35:46.920] sent [IPCP
ConfReq id=0x2 <addr
192.168.1.2> <ms-dns1 1.1.1.1> <ms-dns2 2.2.2.2>]
05:35:46 awplus pppd[24767]: [ppp0] [05:35:46.921] rcvd [LCP
ProtRej id=0x2 80 57
01 01 00 0e 01 0a ee cd 6d ff fe 3a 0d 23]
05:35:46 awplus pppd[24767]: [ppp0] [05:35:46.921] Protocol-Reject
for 'IPv6
Control Protocol' (0x8057) received
05:35:46 awplus pppd[24767]: [ppp0] [05:35:46.922] rcvd [IPCP
ConfAck id=0x2 <addr
192.168.1.2> <ms-dns1 1.1.1.1> <ms-dns2 2.2.2.2>]
02:25:35 awplus pppd[2388]: [ppp1] [02:25:35.990] sent [LCP
EchoReq id=0x3b
magic=0xe1e041db]
02:25:35 awplus pppd[2388]: [ppp1] [02:25:35.991] rcvd [LCP
EchoReq id=0x3b
magic=0xe3e331b1]
02:25:35 awplus pppd[2388]: [ppp1] [02:25:35.991] sent [LCP
EchoRep id=0x3b
magic=0xe1e041db]
02:25:35 awplus pppd[2388]: [ppp1] [02:25:35.992] rcvd [LCP
EchoRep id=0x3b
magic=0xe3e331b1]
```

Output of event debugging

Figure 21-2: Example output from the **debug ppp** command for a PPP interface

```
awplus#terminal monitor
awplus#debug ppp interface ppp0

05:35:43 awplus pppd[24767]: [ppp0] [05:35:43.710] using channel 1
05:35:43 awplus pppd[24767]: [ppp0] [05:35:43.712] Using interface
ppp0
05:35:43 awplus pppd[24767]: [ppp0] [05:35:43.712] Connect: ppp0
<--> hdlc0
05:35:46 awplus PPP: IP is up on interface ppp0 [local-IP:
192.168.1.2, remote-IP:
192.168.1.1]
05:35:46 awplus PPP: IPCP [ppp0]: add IP interface [IP-addr:
192.168.1.2, mask: ]
05:35:46 awplus PPP: IPCP [ppp0]: add host route [peer-IP:
192.168.1.1]
05:35:47 awplus PPP: IPCP [ppp0]: add domain name server [DNS:
1.1.1.1]
05:35:47 awplus PPP: IPCP [ppp0]: add domain name server [DNS:
2.2.2.2]
```

To record messages relating to PPP packets in the buffered log, first configure a buffered log filter to select the messages using the commands:

```
awplus# configure terminal
awplus(config)# log buffered level debug program pppd
awplus(config)# end
```

Then configure PPP debugging, using the below command:

```
awplus# debug ppp
```

To disable PPP debugging for all PPP interfaces, use the below command:

```
awplus# no debug ppp
```

Related Commands

- [terminal monitor](#)
- [encapsulation ppp](#)
- [no debug all](#)
- [ppp authentication](#)
- [show debugging ppp](#)
- [show interface \(PPP\)](#)
- [undebug all](#)

encapsulation ppp

Overview Use this command to enable PPP encapsulation and create one or more PPP interfaces over Ethernet, a cellular interface, or a L2TPv2 managed VPN.

Use the **no** variant of this command to disable PPP encapsulation and remove the specified PPP interface.

Syntax encapsulation ppp <index>
no encapsulation ppp <index>

Parameter	Description
<index>	The PPP interface index number in the range from 0 to 255.

Default No PPP encapsulation or interfaces are configured by default.

Mode Interface Configuration mode for an Ethernet interface (e.g. **interface eth1**), or an Ethernet sub-interface (e.g. **interface eth1.1**), or a cellular interface (e.g. **interface cellular0**).

L2TP Tunnel Configuration mode for an L2TP tunnel (e.g. **l2tp tunnel tunnel0**).

Examples To configure a PPP interface with index 0 for Ethernet interface eth1, use the commands:

```
awplus# configure terminal
awplus(config)# interface eth1
awplus(config-if)# encapsulation ppp 0
```

To shut down the ppp0 interface and remove it from Ethernet interface eth1, use the commands:

```
awplus# configure terminal
awplus(config)# interface ppp0
awplus(config-if)# shutdown
awplus(config-if)# interface eth1
awplus(config-if)# no encapsulation ppp 0
```

To set the L2TP tunnel tunnel1 to encapsulate the PPP interface with index 1, use the commands:

```
awplus# configure terminal
awplus(config)# l2tp tunnel tunnel1
awplus(config-l2tp-tunnel)# encapsulation ppp 1
```

To remove the PPP interface with index 1 from L2TP tunnel tunnel1, use the commands:

```
awplus# configure terminal
awplus(config)# l2tp tunnel tunnel1
awplus(config-l2tp-tunnel)# no encapsulation ppp 1
```

**Related
Commands**

[l2tp tunnel](#)
[ppp service-name \(PPPoE\)](#)
[show interface \(PPP\)](#)

interface (PPP)

Overview Use this command to select a PPP interface to configure.

You need to use the [encapsulation ppp](#) command to enable PPP encapsulation and create PPP interfaces first.

Syntax `interface <PPP-interface-list>`

Parameter	Description
<code><PPP-interface-list></code>	The PPP interfaces or ports to configure. An interface-list can be: <ul style="list-style-type: none">• a PPP interface (e.g. ppp0)• a continuous range of PPP interfaces, separated by a hyphen (e.g. ppp0-ppp2)• a comma-separated non-continuous list of PPP interfaces (e.g. ppp0, ppp2) The specified interfaces must exist.

Mode Global Configuration

Example The following example shows how to enter Interface mode to configure a PPP interface.

```
awplus# configure terminal
awplus(config)# interface ppp0
awplus(config-if)#
```

Related Commands

- [ip address \(IP Addressing and Protocol\)](#)
- [show interface](#)
- [show interface brief](#)

ip address negotiated

Overview Use this command to obtain an IP address with the peer for a PPP interface via IPCP (Internet Protocol Control Protocol) address negotiation when configuring a PPP link for IP traffic.

Use the **no** variant of this command to remove IP address negotiation settings.

Syntax `ip address negotiated [<default-ip-address>]`
`no ip address negotiated`

Parameter	Description
<code><default-ip-addr></code>	Specify an optional default IP address for use instead of an IP address assigned from the peer that is otherwise configured for a PPP interface.

Default No IP address negotiation with the peer is configured by default.

Mode Interface Configuration for a PPP interface

Usage Use this command to enable the device to automatically negotiate an IP address for a PPP interface, and to enable all remote hosts to access the device using this IP address. When the peer does not send an IP address via IPCP negotiation, the specified default IP address will be used.

Examples To configure the PPP interface `ppp0` to use IPCP to negotiate an IP address for itself, use the below commands:

```
awplus# configure terminal
awplus(config)# interface ppp0
awplus(config-if)# ip address negotiated
```

To configure the PPP interface `ppp0` to a default IP address of `10.9.9.2`, for use when the peer does not send an IP address via IPCP negotiation, use the below commands:

```
awplus# configure terminal
awplus(config)# interface ppp0
awplus(config-if)# ip address negotiated 10.9.9.2
```

To stop the PPP interface `ppp0` from using IPCP to negotiate an IP address for itself, use the below commands:

```
awplus# configure terminal
awplus(config)# interface ppp0
awplus(config-if)# no ip address negotiated
```

Output To verify IPCP address negotiation is configured on PPP interface `ppp0`, use the following command:

```
awplus# show running-config interface ppp0
```

Figure 21-3: Example output from a **show running-config interface** `ppp0` to verify IPCP configuration:

```
!  
interface ppp0  
 ip address negotiated  
!
```

Related Commands the [show ip interface](#) chapter
[encapsulation ppp](#)
[peer default ip address](#)
[show running-config interface](#)

ip tcp adjust-mss

Overview Use this command to set the Maximum Segment Size (MSS) size for an interface, where MSS is the maximum TCP data packet size that the interface can transmit before fragmentation.

Use the **no** variant of this command to remove a previously specified MSS size for a PPP interface, and restore the default MSS size.

Syntax `ip tcp adjust-mss {<mss-size>|pmtu}`
`no ip tcp adjust-mss`

Parameter	Description
<code><mss-size></code>	<code><64-1460></code> Specifies the MSS size in bytes.
<code>pmtu</code>	Adjust TCP MSS automatically with respect to the MTU on the interface.

Default The default setting allows a TCP server or a TCP client to set the MSS value for itself.

Mode Interface Configuration

Usage When a host initiates a TCP session with a server it negotiates the IP segment size by using the MSS option field in the TCP packet. The value of the MSS option field is determined by the Maximum Transmission Unit (MTU) configuration on the host.

You can set a feasible MSS value on the following interfaces:

- PPPoE
- Ethernet
- VTI Tunnels (IPsec, GRE, IPv6, L2TP, OpenVPN)
- VLAN

Examples To configure an MSS size of 1452 bytes on PPP interface ppp0, use the commands:

```
awplus# configure terminal
awplus(config)# interface ppp0
awplus(config-if)# ip tcp adjust-mss 1452
```

To configure an MSS size of 1452 bytes on Ethernet interface eth1, use the commands:

```
awplus# configure terminal
awplus(config)# interface eth1
awplus(config-if)# ip tcp adjust-mss 1452
```

To restore the MSS size to the default size on PPP interface `ppp0`, use the commands:

```
awplus# configure terminal
awplus(config)# interface ppp0
awplus(config-if)# no ip tcp adjust-mss
```

**Related
Commands**

[mtu \(PPP\)](#)
[show interface](#)
[show interface \(PPP\)](#)
[show interface tunnel \(GRE\)](#)

ip unnumbered

Overview Use this command to borrow an IP address from the specified interface, on an unnumbered ppp interface.

Use the **no** variant of this command to remove the borrowed IP address.

Syntax `ip unnumbered <interface_name>`
`no ip unnumbered`

Parameter	Description
<code><interface_name></code>	Name of the Interface from which the IP address is to be borrowed. Valid interface types from which the IP address can be borrowed from are: VLAN, ethernet, loopback and bridge.

Default IP unnumbered is disabled by default.

Mode Interface Configuration for a PPP interface

Usage An unnumbered PPP interface can process IP packets without explicitly assigning an IP address. This is achieved by borrowing the primary IP address from the specified interface. Valid interface types from which the IP address can be borrowed from are: VLAN, ethernet, loopback and bridge.

Examples To borrow an IP address on unnumbered PPP from the vlan2 interface, use the following commands:

```
awplus# configure terminal
awplus(config)# interface vlan2
awplus(config-if)# ip address 6.6.6.6/24
awplus(config-if)# exit
awplus(config)# interface ppp0
awplus(config-if)# ip unnumbered
vlan2
```

To remove the borrowed IP address, use the following commands:

```
awplus# configure terminal
awplus(config)# interface ppp0
awplus(config-if)# no ip unnumbered
```

To verify borrowed address is configured on PPP interface ppp0, use the following command:

```
awplus# show interface ppp0
```

Figure 21-4: Example output from a **show interface** ppp0 to verify PPP IP borrow configuration:

```
awplus#show interface ppp0
Interface ppp0
  Link is UP, administrative state is UP
  Hardware is PPP
  Interface is unnumbered. Using IPv4 address of vlan10 (2.2.2.2)
  index 16778240 metric 1 mtu 1492
  <UP,POINT-TO-POINT,RUNNING,NOARP,MULTICAST>
  PPP is running over interface eth2
  LCP Opened IPCP Opened
  MRU(bytes): Local config 1492, Local negotiated 1492, Peer
  negotiated 1492
  Magic number: Local config ON, Local negotiated ON, Peer
  negotiated ON
  Authentication: Local config None, Local neg None, Peer neg CHAP
  IPv4 addresses: Local config 0.0.0.0
                  Local neg 2.2.2.2, Peer neg 1.1.1.1
  IPv6 Id Local config: 0000:0000:0000:0000
  PPPoE is using the default service
  SNMP link-status traps: Disabled
    input packets 2, bytes 20, dropped 0, multicast packets 0
    output packets 2, bytes 20, multicast packets 0 broadcast
  packets 0
  Time since last state change: 0 days 00:00:13
```

**Related
Commands**

- [show ip interface](#)
- [show interface tunnel \(L2TPv3\)](#)
- [show running-config interface](#)

ipv6 tcp adjust-mss

Overview Use this command to set the IPv6 Maximum Segment Size (MSS) size for an interface, where MSS is the maximum TCP data packet size that the interface can transmit before fragmentation.

Use the **no** variant of this command to remove a previously specified MSS size for a PPP interface, and restore the default MSS size.

Syntax `ip tcp adjust-mss {<mss-size>|pmtu}`
`no ip tcp adjust-mss`

Parameter	Description
<code><mss-size></code>	<code><64-1460></code> Specifies the MSS size in bytes.
<code>pmtu</code>	Adjust TCP MSS automatically with respect to the MTU on the interface.

Default The default setting allows a TCP server or a TCP client to set the MSS value for itself.

Mode Interface Configuration

Usage When a host initiates a TCP session with a server it negotiates the IP segment size by using the MSS option field in the TCP packet. The value of the MSS option field is determined by the Maximum Transmission Unit (MTU) configuration on the host.

You can set a feasible MSS value on the following interfaces:

- PPPoE
- Ethernet
- VTI Tunnels (IPSec, GRE, IPv6, L2TP, OpenVPN)
- VLAN

Examples To configure an IPv6 MSS size of 1452 bytes on PPP interface ppp0, use the commands:

```
awplus# configure terminal
awplus(config)# interface ppp0
awplus(config-if)# ipv6 tcp adjust-mss 1452
```

To configure an IPv6 MSS size of 1452 bytes on Ethernet interface eth1, use the commands:

```
awplus# configure terminal
awplus(config)# interface eth1
awplus(config-if)# ip tcp adjust-mss 1452
```

To restore the MSS size to the default size on PPP interface `ppp0`, use the commands:

```
awplus# configure terminal
awplus(config)# interface ppp0
awplus(config-if)# no ip tcp adjust-mss
```

**Related
Commands**

[mtu \(PPP\)](#)
[show interface](#)
[show interface \(PPP\)](#)
[show interface tunnel \(GRE\)](#)

keepalive (PPP)

Overview Use this command to enable LCP (Link Control Protocol) Echo keepalive request messages and change LCP echo parameters on a given PPP interface in Interface Configuration mode.

Use the **no** variant of this command to disable LCP Echo keepalive request messages on a given PPP interface in Interface Configuration mode. Note that disabling the sending of LCP Echo keepalive request messages does not stop a device responding to LCP Echo requests.

Syntax `keepalive [[interval <interval>] [attempts <attempt-limit>]]no keepalive`

Parameter	Description
<interval>	Specify the interval in seconds in the range <1-600> seconds between LCP Echo keepalive request messages, for a PPP interface. Default: 10
<attempt-limit>	Specify the number of missing LCP Echo keepalive response messages, in the range <1-10> for a PPP interface, before the link is considered as being link down and link renegotiation starts to reestablish the link. Default: 3

Default The sending of LCP Echo keepalive messages on a PPP interface is disabled by default. If no optional **interval** is specified then the default interval duration is configured to 10 seconds. If no optional **attempts** are specified then the default attempt limit is configured to 3 attempts.

Mode Interface Configuration for a PPP interface

Example To enable the device to send LCP Echo keepalive messages on the PPP interface `ppp0` with the default 10 second interval when no interval is specified and the default 3 attempts when no attempt is specified, enter the below commands:

```
awplus# configure terminal
awplus(config)# interface ppp0
awplus(config-if)# keepalive
```

To enable the device to send LCP Echo keepalive messages on the PPP interface `ppp0` with double the default values for a 20 second interval and 6 attempts, enter the below commands:

```
awplus# configure terminal
awplus(config)# interface ppp0
awplus(config-if)# keepalive interval 20 attempts 6
```

To disable the device from sending LCP Echo keepalive messages on the PPP interface `ppp0`, enter the below commands:

```
awplus# configure terminal
awplus(config)# interface ppp0
awplus(config-if)# no keepalive
```

Related Commands [show running-config interface](#)

mtu (PPP)

Overview Use this command to set the Maximum Transmission Unit (MTU) size for a PPP interface, where MTU is the maximum packet size that PPP interfaces can transmit.

Use the **no** variant of this command to remove a previously specified MTU size for a PPP interface, and restore the default MTU size (1492 bytes) for PPP interfaces.

Syntax `mtu <mtu-size>`
`no mtu`

Parameter	Description
<code><mtu-size></code>	<code><68-1492></code> Specifies the Maximum Transmission Unit (MTU) size in bytes, where 1492 bytes is the default MTU size for a PPPoE interface and 1500 bytes for PPP via other lower layer interface types. This allows for the 8-byte PPPoE header that is added to make up the total of a 1582 byte packet that matches the default MTU size for the Ethernet link..

NOTE: For PPPoE the minimum MTU value is 128.

Default The default MTU size is 1492 bytes for PPPoE interfaces. The MTU should be greater than, or equal to, the MSS.

Mode Interface Configuration for PPP interfaces.

Usage If a router receives an IPv4 packet for another PPP interface with an MTU size smaller than the packet size, and if the packet has the '**don't fragment**' bit set, then the switch will send an ICMP '**destination unreachable**' (3) packet type and a '**fragmentation needed and DF set**' (4) code back to the source.

See the [ip tcp adjust-mss](#) command to set the Maximum Segment Size (MSS) after first setting the MTU size.

Examples To configure an MTU size of 1492 bytes on PPP interface ppp0, use the commands:

```
awplus# configure terminal
awplus(config)# interface ppp0
awplus(config-if)# mtu 1492
```

To restore the MTU size to the default MTU size of 1492 bytes on PPP interface ppp0, use the commands

```
awplus# configure terminal
awplus(config)# interface ppp0
awplus(config-if)# no mtu
```

Related Commands [ip tcp adjust-mss](#)
[show interface \(PPP\)](#)

peer default ip address

Overview Use this command to set the default IP address assigned to the peer if required for a given PPP interface.

Use the optional **required** keyword with this command to specify that the peer must use this address for a given PPP interface, or drop the connection.

Use the **no** variant of this command to remove the previously specified peer default IP address for a given PPP interface.

Syntax peer default ip address <default-ip-address> [required]
no peer default ip address

Parameter	Description
<default-ip-address>	Specify the IPv4 address to be assigned to the peer upon request.
required	Optionally specify the peer to acknowledge the default IP address, which requires the peer to use the address or drop the connection.

Default No default IP address is configured to be assigned to the peer.

Mode Interface Configuration for a PPP interface

Examples To configure the PPP interface `ppp0` to assign the IP address of `192.168.0.1` to its peer upon request, use the below commands:

```
awplus# configure terminal
awplus(config)# interface ppp0
awplus(config-if)# peer default ip address 192.168.0.1
```

To configure the PPP interface `ppp0` to have the default peer IP address of `192.168.0.1`, and be required to use it or drop the connection, use the below commands:

```
awplus# configure terminal
awplus(config)# interface ppp0
awplus(config-if)# peer default ip address 192.168.0.1
required
```

To remove the default peer IP address of `192.168.0.1` from the PPP interface `ppp0`, enter the below commands:

```
awplus# configure terminal
awplus(config)# interface ppp0
awplus(config-if)# no peer default ip address
```

To verify the required peer default IP address 192.168.0.1 is configured on PPP interface ppp0, use the following command:

```
awplus# show running-config interface ppp0
```

Output

Table 1: Example output from the **show running-config interface ppp0** command

```
awplus# show running-config interface ppp0
!
interface ppp0
  peer default ip address 192.168.0.1 required
!
```

Related Commands [ip address negotiated](#)
[show running-config interface](#)

peer neighbor-route

Overview Use this command in Interface Configuration mode for a PPP interface to re-enable the creation of peer neighbor routes after the default behavior has been disabled.

Use the **no** form of this command in Interface Configuration mode for a PPP interface to disable the default behavior of creating a neighbor route for the peer.

Syntax peer neighbor-route
no peer neighbor-route

Default A 32-bit host route (with a /32 mask) is created to the peer address on a PPP interface after PPP IPCP negotiation finishes.

Usage Use the **no** form of this command if the default behavior creates issues within your network. Use the [show ip route](#) command to validate the route behavior after issuing this command.

Mode Interface Configuration for a PPP interface

Examples To re-enable the default behavior for the PPP interface `ppp1`, where a 32-bit host route (with a /32 mask) is created to the peer address on a PPP interface after PPP IPCP negotiation finishes, enter the commands:

```
awplus# configure terminal
awplus(config)# interface ppp1
awplus(config-if)# peer neighbor-route
```

To disable the default behavior for the PPP interface `ppp0`, to prevent a 32-bit host route being added to the IP router table, enter the commands:

```
awplus# configure terminal
awplus(config)# interface ppp0
awplus(config-if)# no peer neighbor-route
```

Related Commands [show interface \(PPP\)](#)
[show ip route](#)

Output Figure 21-5: Example validation output from the **show interface** and **show ip route** commands issued before and after the **no peer neighbor-route** command (see IPv4 address in **show interface** output and see connected routes **show ip route** output):

```
awplus#show interface pppl
Interface pppl
  Scope: both
  Link is UP, administrative state is UP
  Hardware is PPP
  IPv4 address 4.1.1.2/32 pointopoint 4.1.1.1
  index 16778241 metric 1 mtu 1460
  <UP,POINTOPOINT,RUNNING,NOARP,MULTICAST>
  VRF Binding: Not bound
  PPP is running over interface tunnell
  LCP Opened IPCP Opened
  L2TP session ID is 59451
  SNMP link-status traps: Disabled
    input packets 5, bytes 66, dropped 0, multicast packets 0
    output packets 4, bytes 46, multicast packets 0 broadcast packets 0
  Time since last state change: 0 days 00:02:24
awplus#show ip route
Codes: C - connected, S - static, R - RIP, B - BGP
       O - OSPF, IA - OSPF inter area
       N1 - OSPF NSSA external type 1, N2 - OSPF NSSA external type 2
       E1 - OSPF external type 1, E2 - OSPF external type 2
       * - candidate default

C       4.1.1.1/32 is directly connected, pppl
C       4.1.1.2/32 is directly connected, pppl
C       192.168.10.0/24 is directly connected, vlan1
awplus#configure terminal
Enter configuration commands, one per line.  End with CNTL/Z.
awplus(config)#interface pppl
awplus(config-if)#no peer neighbor-route
awplus(config-if)#exit
awplus(config)#exit
awplus#show interface pppl
Interface pppl
  Scope: both
  Link is UP, administrative state is UP
  Hardware is PPP
  IPv4 address 4.1.1.2/32
  index 16778241 metric 1 mtu 1460
  <UP,POINTOPOINT,RUNNING,NOARP,MULTICAST>
  VRF Binding: Not bound
  PPP is running over interface tunnell
  LCP Opened IPCP Opened
  L2TP session ID is 6262
  SNMP link-status traps: Disabled
    input packets 5, bytes 66, dropped 0, multicast packets 0
    output packets 4, bytes 46, multicast packets 0 broadcast packets 0
  Time since last state change: 0 days 00:00:09
awplus#show ip route
Codes: C - connected, S - static, R - RIP, B - BGP
       O - OSPF, IA - OSPF inter area
       N1 - OSPF NSSA external type 1, N2 - OSPF NSSA external type 2
       E1 - OSPF external type 1, E2 - OSPF external type 2
       * - candidate default

C       4.1.1.2/32 is directly connected, pppl
C       192.168.10.0/24 is directly connected, vlan1
```

ppp authentication

Overview Use this command in Interface Configuration mode for a PPP interface to configure PAP (Password Authentication Protocol), CHAP (Challenge Authentication Protocol), or EAP (Extensible Authentication Protocol).

Use the **no** form of this command in Interface Configuration mode for a PPP interface to disable all PAP, CHAP, and EAP authentication for a specified PPP interface.

Syntax `ppp authentication {eap|chap|pap}`
`no ppp authentication`

Parameter	Description
eap	Specify this parameter to enable EAP on a PPP interface
chap	Specify this parameter to enable CHAP on a PPP interface.
pap	Specify this parameter to enable PAP on a PPP interface.

Default There is no PPP authentication protocol defined or configured to a PPP interface by default.

Mode Interface Configuration for a PPP interface

Examples To enable PPP PAP authentication on the PPP interface `ppp0`, enter the commands:

```
awplus# configure terminal
awplus(config)# interface ppp0
awplus(config-if)# ppp authentication pap
```

To enable PPP CHAP authentication on the PPP interface `ppp0`, enter the commands:

```
awplus# configure terminal
awplus(config)# interface ppp0
awplus(config-if)# ppp authentication chap
```

To enable PPP EAP authentication on the PPP interface `ppp0`, enter the commands:

```
awplus# configure terminal
awplus(config)# interface ppp0
awplus(config-if)# ppp authentication eap
```

To attempt PPP EAP authentication, then fall back to PPP CHAP authentication if the attempt to enable PPP EAP authentication fails on the PPP interface `ppp0`, enter the commands:

```
awplus# configure terminal
awplus(config)# interface ppp0
awplus(config-if)# ppp authentication eap chap
```

To attempt PPP CHAP authentication, then fall back to PPP PAP authentication if the attempt to enable PPP CHAP authentication fails on the PPP interface `ppp0`, enter the commands:

```
awplus# configure terminal
awplus(config)# interface ppp0
awplus(config-if)# ppp authentication chap pap
```

To disable all PPP authentication on the PPP interface `ppp0`, enter the commands:

```
awplus# configure terminal
awplus(config)# interface ppp0
awplus(config-if)# no ppp authentication
```

**Related
Commands**

- [ppp authentication refuse](#)
- [ppp hostname](#)
- [ppp password](#)
- [ppp username](#)

ppp authentication refuse

Overview Use this command in Interface Configuration mode for a PPP interface to refuse EAP, CHAP (Challenge Handshake Authentication Protocol) or PAP (Password Authentication Protocol) authentication from peers requesting it.

Use the **no** form of this command in Interface Configuration mode for a PPP interface to allow authentication from peers requesting it.

Syntax `ppp authentication refuse {eap|chap|pap}`
`no ppp authentication refuse`

Parameter	Description
eap	Use this parameter to specify the router will refuse LCP configuration requests containing the authentication protocol option with EAP received on this PPP interface.
chap	Use this parameter to specify the router will refuse LCP configuration requests containing the authentication protocol option with CHAP received on this PPP interface.
pap	Use this parameter to specify the router will refuse LCP configuration requests containing the authentication protocol option with PAP on this PPP interface.

Mode Interface Configuration for a PPP interface

Usage This command specifies that EAP, CHAP or PAP authentication is disabled, so all requests by the peer for the user to authenticate using EAP, CHAP or PAP are refused.

Examples To refuse the use of PAP authentication if a peer requests PAP authentication, enter the commands:

```
awplus# configure terminal
awplus(config)# interface ppp0
awplus(config-if)# ppp authentication refuse pap
```

To refuse the use of CHAP authentication if a peer requests CHAP authentication, enter the commands:

```
awplus# configure terminal
awplus(config)# interface ppp0
awplus(config-if)# ppp authentication refuse chap
```

To refuse the use of EAP authentication if a peer requests EAP authentication, enter the commands:

```
awplus# configure terminal
awplus(config)# interface ppp0
awplus(config-if)# ppp authentication refuse eap
```

To allow the use of EAP, CHAP or PAP authentication if a peer requests EAP, CHAP or PAP authentication, enter the commands:

```
awplus# configure terminal
awplus(config)# interface ppp0
awplus(config-if)# no ppp authentication refuse
```

**Related
Commands** [ppp authentication](#)

ppp hostname

Overview Use this command in Interface Configuration mode for a PPP interface to configure a unique identifier for that PPP authenticator. This is used by the authenticator to fill the Name field in a CHAP challenge packet, or is used to fill the Server Name field in an EAP SRP-SHA1 (Subtype 1 Request) packet. The hostname sent with PPP packet exchanges is normally the hostname of the router, as configured with the [hostname](#) command.

Use the **no** form of this command in Interface Configuration mode for a PPP interface to disable a configured alternate hostname and revert to using the hostname, as configured with the [hostname](#) command.

See the Usage section below for information about when you may want to specify another hostname, instead of the system hostname configured from the [hostname](#) command, using this command.

Syntax `ppp hostname <hostname>`
`no ppp hostname <hostname>`

Parameter	Description
<code><hostname></code>	Specify this parameter to use an alternate hostname for PPP EAP and CHAP authentication instead of the hostname specified by the hostname command. The name can contain up to 255 characters. The name can contain any printable ASCII characters (ASCII 32-126). If the name contains the special characters backslash, double-quote or space, those characters should be escaped with a backslash.

Default The default PPP hostname is the system hostname as specified with the [hostname](#) command.

Mode Interface Configuration for a PPP interface

Usage This command allows the PPP username that is sent to be independent of the router hostname for a specific PPP interface.

Examples To enable the use of the alternate hostname `remote_router` for PPP authentication, enter the commands:

```
awplus# configure terminal
awplus(config)# interface ppp0
awplus(config-if)# ppp hostname remote_router
```

To disable the use of the alternate hostname `remote_router` for PPP authentication, enter the commands:

```
awplus# configure terminal
awplus(config)# interface ppp0
awplus(config-if)# no ppp hostname remote_router
```

**Related
Commands** [hostname](#)
[ppp authentication](#)

ppp ipcp dns

Overview Use this command to configure the primary and secondary DNS (Domain Name System) IP addresses for IPCP (Internet Protocol Control Protocol) on a given PPP interface.

Use the **no** variant of this command to remove the primary and secondary DNS IP addresses for IPCP on a given PPP interface, and remove any optional parameters configured for DNS.

Syntax `ppp ipcp dns [<primary> [<secondary>]] [required|reject|request]`
`no ppp ipcp dns`

Parameter	Description
<code><primary></code>	Specify the primary DNS address for a given PPP interface to the peer.
<code><secondary></code>	Specify the secondary DNS address for a given PPP interface to the peer.
<code>required</code>	Request DNS addresses from the peer, and close the link if none is given.
<code>reject</code>	Reject negotiations with the peer (default).
<code>request</code>	Request DNS addresses from the peer.

Default By default no IPCP DNS server request is sent to the peer.

Mode Interface Configuration

Usage Use the optional parameters to configure PPP IPCP DNS options for accepting, rejecting or requesting DNS addresses from the peer. Use the optional primary and secondary or primary only DNS server address placeholders to specify DNS server addresses to the peer.

The no variant of this command also stops IPCP DNS request messages being sent to the peer.

Examples To configure the PPP interface `ppp0` to require a DNS IP address from the peer, and close the link if a DNS IP address is not given, enter the below commands:

```
awplus# configure terminal
awplus(config)# interface ppp0
awplus(config-if)# ppp ipcp dns required
```

To configure the PPP interface `ppp0` to require a DNS IP address from the peer, enter the below commands:

```
awplus# configure terminal
awplus(config)# interface ppp0
awplus(config-if)# ppp ipcp dns request
```

To configure the PPP interface `ppp0` to reject a DNS IP address from the peer, enter the below commands:

```
awplus# configure terminal
awplus(config)# interface ppp0
awplus(config-if)# ppp ipcp dns reject
```

To configure the PPP interface `ppp0` to supply primary and secondary DNS server addresses to the peer, enter the below commands:

```
awplus# configure terminal
awplus(config)# interface ppp0
awplus(config-if)# ppp ipcp dns 10.1.1.2 10.1.1.3
```

To configure the PPP interface `ppp0` to supply a primary but not a secondary DNS server address to the peer, enter the below commands:

```
awplus# configure terminal
awplus(config)# interface ppp0
awplus(config-if)# ppp ipcp dns 10.1.1.2
```

**Related
Commands**

- [ip address negotiated](#)
- [peer default ip address](#)
- [peer neighbor-route](#)
- [show running-config interface](#)

ppp ipcp dns suffix-list

Overview Use this command to configure a suffix-list to be associated with DNS name-servers learned over the PPP connection.

Use the **no** variant of this command to remove the suffix-list.

Syntax `ppp ipcp dns suffix-list <domain-list-name>`
`no ppp ipcp dns suffix-list`

Parameter	Description
<code><domain-list-name></code>	The name of the DNS domain-list

Mode Interface Configuration

Usage A PPP connection can be configured to learn DNS servers from the remote peer by using the command `ppp ipcp dns` command.

This command allows a user to associate a domain-list to be used to match against the suffixes of incoming DNS requests. For example, a customer branch office may have a router that is used to give remote-access to their head office, over which they learn the IP address of the head office's DNS server. A domain list can be created that contains a suffix used for services internal to that company, for example, "example.lc". This domain-list is associated as a suffix-list to the PPP connection. So when the PPP connection is completed with the head office, users at the branch office that browse to "intranet.example.lc" will have the DNS request forwarded to the DNS server learned over the PPP connection. Without having the suffix-list configured, the DNS request for "intranet.example.lc" would instead be sent to the primary DNS server, which is likely to be the branch office's ISP, and they will simply respond with a negative reply, because .example.lc is not a globally routable domain.

Examples At a branch office, to direct DNS lookups for domains with suffixes of "engineering.acme" or "intranet.acme" to an internal corporate name-server run at head-office that was learned over a PPP connection, use the commands:

```
awplus# configure terminal
awplus(config)# ip dns forwarding domain-list corporatedomains
host(config-domain-list)# description Our internal network
domains; do not send DNS requests to internet
host(config-domain-list)# domain engineering.acme
host(config-domain-list)# domain intranet.acme
awplus(config)# interface ppp0
awplus(config-if)# ppp ipcp dns required
awplus(config-if)# ppp ipcp dns suffix-list corporatedomains
```

**Related
Commands** [ip dns forwarding domain-list](#)
[ppp ipcp dns](#)

ppp ipcp ip-override

Overview Use this command to override the IP address negotiated via IPCP with peer and use the statically configured address on a given PPP interface.

Use the **no** variant of this command to use any address negotiated with the peer via IPCP on a given PPP interface.

Syntax ppp ipcp ip-override
no ppp ipcp ip-override

Default By default the address is negotiated with the peer via IPCP.

Mode Interface Configuration

Examples To override the IP address negotiated with the peer via IPCP and use statically configured address on interface ppp0, use the commands below:

```
awplus# configure terminal
awplus(config)# interface ppp0
awplus(config-if)# ip address 192.168.1.100/24
awplus(config-if)# ppp ipcp ip-override
```

Related Commands [show running-config interface](#)

ppp password

Overview Use this command in Interface Configuration mode for a PPP interface to configure a PPP secret password to be used in response to a challenge from an unknown remote peer.

Use the **no** form of this command in Interface Configuration mode for a PPP interface to disable a configured PPP secret password.

Syntax `ppp password <password>`
`no ppp password`

Parameter	Description
<code><password></code>	Specify this parameter to configure a PPP secret password to be used in response to an unknown remote peer. You can use any printable characters, including spaces. A password can contain up to 255 printable characters.

Default There is no PPP password defined or configured to a PPP interface by default.

Mode Interface Configuration for a PPP interface

Examples To enable the use of the PPP secret password `bobs_secret` for PPP authentication, enter the commands:

```
awplus# configure terminal
awplus(config)# interface ppp0
awplus(config-if)# ppp password bobs_secret
```

To disable the use of the PPP secret password `bobs_secret` for PPP authentication, enter the commands:

```
awplus# configure terminal
awplus(config)# interface ppp0
awplus(config-if)# no ppp password
```

Related Commands [ppp authentication](#)
[ppp username](#)

ppp service-name (PPPoE)

Overview This command configures the PPPoE service name used to select a service from an access concentrator. This can only be applied when the PPP interface has been configured over an underlying eth interface.

Use the **no** variant of this command to set the service name for the connection back to the default (unset).

Syntax `ppp service-name <service-name>`
`no ppp service-name`

Parameter	Description
<code><service-name></code>	Specifies the PPPoE service name to select from an access concentrator. The service-name is 1 to 18 characters long, is case-sensitive, and for a PPPoE client is usually supplied by the ISP. The name can contain any printable ASCII characters (ASCII 32-126). If the name contains the special characters backslash, double-quote or space, those characters should be escaped with a backslash. The default is no service name.

Default The default option is not to specify a service name. This results in a connection to the default service specified by the access concentrator.

Mode Interface Configuration for a PPP interface

Usage You can only apply a single service name to each PPPoE interface.

Examples To connect to a service called "Internet", use the command:

```
awplus(config)# interface ppp0  
awplus(config-if)# ppp service-name Internet
```

Related Commands [encapsulation ppp](#)
[show interface \(PPP\)](#)

ppp timeout idle

Overview Use this command to specify an idle time when a PPP connection is disconnected. Use the **no** variant of this command to reset the idle time to the default of 60 seconds.

Syntax `ppp timeout idle <0-99999>`
`no ppp timeout idle`

Parameter	Description
<0-99999>	The time in seconds before the idle timeout disconnects. If this is not specified the default value of 60 seconds is used.

Default PPP timeout idle is not set and the PPP Dial on Demand feature is disabled. If no idle time is set, the default value of 60 seconds is used.

Mode Interface Configuration

Usage This command allows an idle timer to disconnect a PPP connection after a specified time. The timer is reset upon either ingress or regress user traffic. Non-user traffic such as Link Control Protocol (LCP) keepalives and Network Control Protocol (NCP) negotiation packets do not reset the idle timer.

Examples To set the idle time to 30 seconds, enter the below commands:

```
awplus# configure terminal
awplus(config)# interface ppp0
awplus(config-if)# ppp timeout idle
30
```

To disable the use of the timer and disable the PPP Dial on Demand feature, enter the below commands:

```
awplus# configure terminal
awplus(config)# interface ppp0
awplus(config-if)# no ppp timeout
idle 30
```

Validation Commands `show running-config interface`

ppp username

Overview This command creates or modifies a username for a PPP user on a configured PPP interface.

Syntax `ppp username <username>`
`no ppp username`

Parameter	Description
<code><username></code>	Specify a login name for the user. The name can contain up to 255 characters. The name can contain any printable ASCII characters (ASCII 32-126). If the name contains the special characters backslash, double-quote or space, those characters should be escaped with a backslash.

Default There is no default PPP username defined or configured to a PPP interface.

Mode Interface Configuration for a PPP interface.

Examples To create the PPP username `bob`, for the PPP interface `ppp0`, use the commands:

```
awplus# configure terminal
awplus(config)# interface ppp0
awplus(config-if)# ppp username bob
```

To remove the PPP username `bob`, for the PPP interface `ppp0`, use the commands:

```
awplus# configure terminal
awplus(config)# interface ppp0
awplus(config-if)# no ppp username
```

Related Commands [ppp authentication](#)
[ppp password](#)

show debugging ppp

Overview Use this command to display PPP debug settings for optionally specified PPP interfaces. If no PPP interfaces are specified then PPP debug settings are shown for all available PPP interfaces.

Syntax `show debugging ppp [interface <0-255>]`

Parameter	Description
<0-255>	Specify a PPP interface or a range of PPP interfaces in the range <code>ppp<0-255></code> . Use a hyphen between PPP interfaces to include all PPP interfaces in a given range, or use commas between PPP interfaces to specify non-contiguous PPP interfaces.

Mode Privileged Exec

Examples The following example shows how to display PPP debug information for PPP interface `ppp0`:

```
awplus# show debugging ppp interface ppp0
```

The following example shows how to display PPP debug information for PPP interface `ppp0` through `ppp2`:

```
awplus# show debugging ppp interface ppp0-ppp2
```

The following example shows how to display PPP debug information for PPP interface `ppp0` and `ppp2`:

```
awplus# show debugging ppp interface ppp0,ppp2
```

The following example shows how to display PPP debug information for all available PPP interfaces:

```
awplus# show debugging ppp
```

Figure 21-6: Example output from the **show debugging ppp** command

```
awplus# show debugging ppp
PPP debugging status:
  PPP debug on interface ppp0: enabled
  PPP debug on interface ppp1: disabled
```

Related Commands

- [debug ppp](#)
- [no debug all](#)
- [undebug all](#)
- [show interface \(PPP\)](#)

show interface (PPP)

Overview Use this command to display configuration and status information for a configured PPP (Point-to-Point) interface.

Syntax `show interface ppp<ppp_index>`

Parameter	Description
<code><ppp_index></code>	Display configuration and status information for the specified and configured PPP interface (0 to 255).

Mode User Exec and Privileged Exec

Usage See the [show interface brief](#) command for brief interface, configuration and status information.

Note the negotiated options, including those for DNS addresses, are shown in console output:

- Local DNS addresses as displayed in console output are provided from the peer.
- Peer DNS addresses as displayed in console output are provided to the peer.
- Only Peer DNS addresses or Local DNS addresses are shown, but not both.
- Echo Request Timer value as displayed in console output is the local setting.

Example The following example shows how to display the configuration and status information for a configured PPP interface named `ppp0`.

```
awplus# show interface ppp0
```

Figure 21-7: Example output from the **show interface** command for a PPPoE interface

```
awplus#show interface ppp0

Interface ppp0
  Scope: both
  Link is UP, administrative state is UP
  Hardware is PPP
  IPv4 address 10.1.0.2/32
  IPv6 address fe80::200:cdff:fe28:8a1/10
  index 16778440 metric 1
  <UP, POINTOPOINT, RUNNING, NOARP, MULTICAST>
  VRF Binding: Not bound
  PPP is running over interface eth0
  PPPoE is using the default service
  SNMP link-status traps: Disabled
    input packets 12, bytes 458, dropped 0, multicast packets 0
    output packets 6, bytes 122, multicast packets 0 broadcast
  packets 0
  Time since last state change: 0 days 00:01:57
```

Figure 21-8: Example output from the **show interface ppp1** command showing negotiated DNS addresses, where the peer provided the DNS information (see the **Local DNS addresses** field output below):

```
awplus#sh interface ppp1
Interface ppp1
  Scope: both
  Link is UP, administrative state is UP
  Hardware is PPP
  IPv4 address 192.168.1.1/30 pointopoint 192.168.1.2
  IPv6 address fe80::200:cdff:fe28:89f/10
  index 16778241 metric 1 mtu 1460
  <UP, POINTOPOINT, RUNNING, NOARP, MULTICAST>
  VRF Binding: Not bound
  PPP is running over interface tunnel1
  LCP Opened IPCP Opened IPV6CP Opened
  MRU(bytes): Local config 1460, Local negotiated 1460, Peer
  negotiated 1460
  Magic number: Local config ON, Local negotiated ON, Peer
  negotiated ON
  Authentication: Local config None, Local neg None, Peer neg None
  Echo Request Timer (seconds): 10
  IPv4 addresses: Local config 192.168.1.1, Peer neg 192.168.1.2
  IPv6 interface ID: Local eecd:6dff:fe3a:0d18, Peer neg
  eecd:6dff:fe3a:0d18
  Local DNS addresses: 192.168.60.1, 192.168.60.2
  L2TP session ID is 15288
  SNMP link-status traps: Disabled
    input packets 5, bytes 96, dropped 0, multicast packets 0
    output packets 5, bytes 96, multicast packets 0 broadcast
  packets 0
  Time since last state change: 0 days 00:06:29
awplus#
```

Figure 21-9: Example output from the **show interface ppp1** command showing negotiated DNS addresses, where the peer was provided with DNS information (see the **Peer DNS addresses** field output below):

```
awplus#sh interface ppp1
Interface ppp1
  Scope: both
  Link is UP, administrative state is UP
  Hardware is PPP
  IPv4 address 192.168.1.1/30 pointopoint 192.168.1.2
  IPv6 address fe80::200:cdff:fe28:89f/10
  index 16778241 metric 1 mtu 1460
  <UP, POINTOPOINT, RUNNING, NOARP, MULTICAST>
  VRF Binding: Not bound
  PPP is running over interface tunnell1
  LCP Opened IPCP Opened IPV6CP Opened
  MRU(bytes): Local config 1460, Local negotiated 1460, Peer
  negotiated 1460
  Magic number: Local config ON, Local negotiated ON, Peer
  negotiated ON
  Authentication: Local config None, Local neg None, Peer neg None
  Echo Request Timer (seconds): 10
  IPv4 addresses: Local config 192.168.1.1, Peer neg 192.168.1.2
  IPv6 interface ID: Local eecd:6dff:fe3a:0d18, Peer neg
  eecd:6dff:fe3a:0d18
  Peer DNS addresses: 1.1.1.1, 2.2.2.2
  L2TP session ID is 15288
  SNMP link-status traps: Disabled
    input packets 5, bytes 96, dropped 0, multicast packets 0
    output packets 5, bytes 96, multicast packets 0 broadcast
  packets 0
  Time since last state change: 0 days 00:06:29
awplus#
```

**Related
Commands**

- [encapsulation ppp](#)
- [ppp service-name \(PPPoE\)](#)
- [show interface](#)
- [show interface brief](#)

undebbug ppp

Overview Use this command to disable PPP protocol debugging on the specified PPP interface or interfaces. If no PPP interface is specified then PPP debugging for all PPP interfaces is disabled.

This command has the same functionality as the **no** variant of the [debug ppp](#) command.

Syntax `undebbug ppp [interface <ppp-interface-list>]`

Parameter	Description
<code><ppp-interface-list></code>	Specify a PPP interface or a range of PPP interfaces in the range <code>ppp<0-255></code> . Use a hyphen between PPP interfaces to include all PPP interfaces in a given range, or use commas between PPP interfaces to specify non-contiguous PPP interfaces.

Default No diagnostic messages are enabled for PPP debugging. PPP debugging is disabled by default.

Mode Privileged Exec

Usage Note that this command is an alias of the negated form of the [debug ppp](#) command.

Examples To disable PPP debugging for all PPP interfaces, enter the below command:

```
awplus# undebbug ppp
```

To disable PPP debugging for PPP interfaces `ppp0`, enter the below command:

```
awplus# undebbug ppp interface ppp0
```

To disable PPP debugging for PPP interfaces `ppp0` through `ppp2`, enter the below command:

```
awplus# undebbug ppp interface ppp0-ppp2
```

To disable PPP debugging for PPP interfaces `ppp0` and `ppp2`, enter the below command:

```
awplus# undebbug ppp interface ppp0,ppp2
```

Related Commands

- [debug ppp](#)
- [no debug all](#)
- [show debugging ppp](#)
- [undebbug all](#)

22

PPP over Ethernet (PPPoE) Commands

Introduction

Overview This chapter provides an alphabetical reference of commands used to configure a PPP over Ethernet (PPPoE) Access Concentrator (AC).

For more information, see the [L2TPv2 Tunneling of PPP Feature Overview and Configuration Guide](#).

- Command List**
- [“clear pppoe-ac statistics”](#) on page 652
 - [“debug pppoe-ac”](#) on page 653
 - [“destination l2tp”](#) on page 654
 - [“l2tp peer-address dns-lookup”](#) on page 655
 - [“l2tp peer-address radius-lookup group”](#) on page 657
 - [“l2tp peer-address static”](#) on page 658
 - [“l2tp profile”](#) on page 660
 - [“ppp-auth-protocol”](#) on page 662
 - [“pppoe-ac”](#) on page 663
 - [“pppoe-ac-service”](#) on page 664
 - [“proxy-auth”](#) on page 665
 - [“service-name”](#) on page 666
 - [“show debugging pppoe ac”](#) on page 668
 - [“show pppoe-ac config-check”](#) on page 669
 - [“show pppoe-ac connections”](#) on page 671
 - [“show pppoe-ac statistics”](#) on page 673
 - [“show running-config pppoe-ac”](#) on page 676

clear pppoe-ac statistics

Overview Use this command to zero all the PPPoE Access Concentrator statistics counters, and restart the counters incrementing from zero.

To see the affected counter values, use the command [show pppoe-ac statistics](#).

Syntax `clear pppoe-ac statistics`

Default n/a

Mode Privileged Exec

Example To set all the PPPoE Access Concentrator statistics counters to zero, use the command:

```
awplus# clear pppoe-ac statistics
```

Related Commands [show pppoe-ac statistics](#)

debug pppoe-ac

Overview Use this command to enable debugging of the PPPoE Access Concentrator. Use the **no** variant of this command to disable debugging of the PPPoE Access Concentrator.

Syntax debug pppoe-ac
no debug pppoe-ac

Parameter	Description
<varname>	Description of varname

Default PPPoE Access Concentrator debugging is disabled by default.

Mode Privileged Exec

Example To enable PPPoE AC debugging, use the commands:

```
awplus# debug pppoe-ac  
awplus# terminal monitor  
% Warning: Console logging enabled
```

Related Commands debug l2tp
show debugging pppoe ac

destination l2tp

Overview Use this command to set the destination to forward all PPPoE packets to the peer over L2TP.

Use the **no** variant of this command to unset the destination for PPPoE packets.

Syntax `destination l2tp`
`no destination`

Default This command is not configured by default.

Mode PPPoE Access Concentrator Configuration

Example To sets the destination to forward all PPPoE packets for the service 'ISP-service' to the peer over L2TP, use the commands:

```
awplus# configure terminal
awplus(config)# pppoe-ac ISP-service
awplus(config-pppoe-ac)# destination l2tp
```

To unset the destination for PPPoE packets for the service 'ISP-service', use the commands:

```
awplus# configure terminal
awplus(config)# pppoe-ac ISP-service
awplus(config-pppoe-ac)# no destination
```

Related Commands

- [l2tp peer-address dns-lookup](#)
- [l2tp peer-address radius-lookup group](#)
- [l2tp peer-address static](#)
- [l2tp profile](#)
- [pppoe-ac](#)
- [ppp-auth-protocol](#)
- [service-name](#)
- [show running-config pppoe-ac](#)

l2tp peer-address dns-lookup

Overview Use this command to set the LNS address to use via a DNS lookup from the username email domain for this PPPoE Access Concentrator service.

Use the **no** variant of this command to remove the DNS lookup setting for this PPPoE AC service.

Syntax `l2tp peer-address dns-lookup [prefix <prefix>|]`
`no l2tp peer-address`

Parameter	Description
<prefix>	A string to prepend to the domain name portion of the username.

Default This command is not set by default.

Mode PPPoE Access Concentrator Configuration

Example To set the LNS address to use via a DNS lookup for the PPPoE AC service 'ISP-service', use the commands:

```
awplus# configure terminal
awplus(config)# pppoe-ac ISP-service
awplus(config-pppoe-ac)# l2tp peer-address dns-lookup
```

To set the LNS address to use via a DNS lookup and prepend "lns" to the domain name portion of the username, use the commands:

```
awplus# configure terminal
awplus(config)# pppoe-ac ISP-service
awplus(config-pppoe-ac)# l2tp peer-address dns-lookup prefix
lns
```

To remove the DNS lookup setting for the PPPoE AC service 'ISP-service', use the commands:

```
awplus# configure terminal
awplus(config)# pppoe-ac ISP-service
awplus(config-pppoe-ac)# no l2tp peer-address
```

Related Commands

- [destination l2tp](#)
- [l2tp peer-address radius-lookup group](#)
- [l2tp peer-address static](#)
- [l2tp profile](#)
- [pppoe-ac](#)
- [ppp-auth-protocol](#)

service-name

show running-config pppoe-ac

l2tp peer-address radius-lookup group

Overview Use this command to set this PPPoE Access Concentrator (AC) service to get the LNS address by a RADIUS lookup.

Use the **no** variant of this command to remove the L2TP peer address setting.

Syntax `l2tp peer-address radius-lookup group <radius-group-name>`
`no l2tp peer-address`

Parameter	Description
<code><radius-group-name></code>	The name of the RADIUS group to lookup.

Default No L2TP peer address is set by default.

Mode PPPoE Access Concentrator Configuration

Example To find peer address via RADIUS lookup from Radius server group called "GROUP1", use the commands:

```
awplus# configure terminal
awplus(config)# pppoe-ac ISP-service
awplus(config-pppoe-ac)# l2tp peer-address radius-lookup group
GROUP1
```

To remove the RADIUS lookup setting for the PPPoE AC service 'ISP-service', use the commands:

```
awplus# configure terminal
awplus(config)# pppoe-ac ISP-service
awplus(config-pppoe-ac)# no l2tp peer-address
```

Related Commands

[aaa group server](#)
[destination l2tp](#)
[l2tp peer-address dns-lookup](#)
[l2tp peer-address static](#)
[l2tp profile](#)
[pppoe-ac](#)
[ppp-auth-protocol](#)
[service-name](#)
[show running-config pppoe-ac](#)

l2tp peer-address static

Overview Use this command to set the IP address or fully qualified domain name of the L2TP peer (LNS) to which the L2TP tunnel should be established for this PPPoE Access Concentrator route.

Use the **no** variant of this command to remove the configured L2TP peer (LNS) address.

Syntax `l2tp peer-address static`
`{<l2tp-peer-ip-address>|<l2tp-peer-domain-name>}`
`no l2tp peer-address`

Parameter	Description
<code><l2tp-peer-ip-address></code>	The IPv4 address of the L2TP peer (LNS) for this PPPoE AC route, in dotted-decimal format.
<code><l2tp-peer-domain-name></code>	The fully-qualified domain name of the L2TP peer (LNS) for this PPPoE AC route.

Default No L2TP peer address is configured by default.

Mode PPPoE Access Concentrator Configuration

Example To configure L2TP to tunnel all users to the LNS located at IP address 192.168.11.2, use the commands:

```
awplus# configure terminal
awplus(config)# pppoe-ac ISP-service
awplus(cinfig-pppoe-ac)# l2tp peer-address static 192.168.11.2
```

To configure L2TP to tunnel all users to the LNS located at domain foo.mydomain.org, use the commands:

```
awplus# configure terminal
awplus(config)# pppoe-ac ISP-service
awplus(config-pppoe-ac)# l2tp peer-address static
foo.mydomain.org
```

To remove the configured peer (LNS) address, use the commands:

```
awplus# configure terminal
awplus(config)# pppoe-ac ISP-service
awplus(cinfig-pppoe-ac)# no l2tp peer-address
```

Related Commands [destination l2tp](#)
[l2tp peer-address dns-lookup](#)
[l2tp peer-address radius-lookup group](#)

l2tp profile
ppp-auth-protocol
service-name
show running-config pppoe-ac

I2tp profile

Overview Use this command to set the profile to use for L2TP traffic for this PPPoE Access Concentrator (AC).

Use the **no** variant of this command to remove L2TP profile setting from this PPPoE AC.

Syntax `l2tp profile <l2tp-profile-name>`
`no l2tp profile <l2tp-profile-name>`

Parameter	Description
<code><l2tp-profile-name></code>	The name of the L2TP profile that the PPPoE AC is to use. to use.

Default This command is not configured by default.

Mode PPPoE Access Concentrator Configuration

Usage The L2TP profile name used in this command is created by the **l2tp-profile** command.

Example To allow AC service "ISP-service" to use the L2TP profile called "PUBLIC", use the commands:

```
awplus# configure terminal
awplus(config)# pppoe-ac ISP-service
awplus(config-pppoe-ac)# l2tp profile PUBLIC
```

To unset the L2TP profile for the AC service "ISP-service", use the commands:

```
awplus# configure terminal
awplus(config)# pppoe-ac ISP-service
awplus(config-pppoe-ac)# no l2tp profile PUBLIC
```

Related Commands

[destination l2tp](#)
[l2tp-profile](#)
[l2tp peer-address dns-lookup](#)
[l2tp peer-address radius-lookup group](#)
[l2tp peer-address static](#)
[l2tp-profile](#)
[pppoe-ac](#)
[ppp-auth-protocol](#)
[service-name](#)

`show running-config pppoe-ac`

ppp-auth-protocol

Overview Use this command to set the authentication protocol to be used for this PPPoE Access Concentrator (AC) service.

Use the **no** variant of this command to reset the authentication protocol to the default.

Syntax `ppp-auth-protocol {chap|pap|eap}`
`no ppp-auth-protocol`

Parameter	Description
chap	Set the PPP authentication protocol to Challenge Handshake Authentication Protocol (default).
pap	Set the PPP authentication protocol to Password Authentication Protocol.
eap	Set the PPP authentication protocol to Extensible Authentication Protocol.

Default Default PPP authentication protocol is CHAP.

Mode PPPoE Access Concentrator Configuration

Example To set PPP authentication for the PPPoE AC service 'ISP-service' to use PAP, use the commands:

```
awplus# configure terminal
awplus(config)# pppoe-ac ISP-service
awplus(config-pppoe-ac)# ppp-auth-protocol pap
```

To set PPP authentication to use the default (CHAP), use the commands:

```
awplus# configure terminal
awplus(config)# pppoe-ac ISP-service
awplus(config-pppoe-ac)# no ppp-auth-protocol
```

**Related
Commands**

- [destination l2tp](#)
- [l2tp peer-address dns-lookup](#)
- [l2tp peer-address radius-lookup group](#)
- [l2tp peer-address static](#)
- [l2tp profile](#)
- [pppoe-ac](#)
- [service-name](#)
- [show running-config pppoe-ac](#)

pppoe-ac

Overview Use this command to create a PPPoE Access Concentrator (AC) and put the device into PPPoE Access Concentrator Configuration mode, in which subsequent commands can be entered.

Use the **no** variant of this command to remove the PPPoE AC and all its configuration.

Syntax `pppoe-ac <label>`
`no pppoe-ac <label>`

Parameter	Description
<code><label></code>	A unique label for the PPPoE AC service.

Default No PPPoE AC services are configured by default.

Mode Global Configuration

Example To configure a PPPoE AC called "ISP-service", use the commands:

```
awplus# configure terminal
awplus(config)# pppoe-ac ISP-service
awplus(config-pppoe-ac)#
```

To remove a PPPoE AC called "ISP-service" and its configuration, use the commands:

```
awplus# configure terminal
awplus(config)# no pppoe-ac ISP-service
```

Related Commands

- [destination l2tp](#)
- [l2tp peer-address dns-lookup](#)
- [l2tp peer-address radius-lookup group](#)
- [l2tp peer-address static](#)
- [l2tp profile](#)
- [pppoe-ac](#)
- [ppp-auth-protocol](#)
- [pppoe-ac-service](#)
- [service-name](#)
- [show running-config pppoe-ac](#)

pppoe-ac-service

Overview Use this command to attach the specified PPPoE Access Concentrator (AC) service to the interface. An AC service can be offered on several interfaces. Up to six PPPoE AC services can be set for one interface. Only ETH and VLAN interfaces accept this command.

Use the **no** variant of this command to remove the AC service from the interface.

Syntax `pppoe-ac-service <label>`
`no pppoe-ac-service <label>`

Parameter	Description
<code><label></code>	The name (label) of the PPPoE AC service to be attached to the interface.

Default No PPPoE AC service is attached to an interface by default.

Mode Interface Configuration

Usage The label of the PPPoE AC service specified in this command is created by the **pppoe-ac** command.

Example To provide a PPPoE AC service labeled 'ISP-service' for client requests received on interface eth1, use the commands:

```
awplus# configure terminal
awplus(config)# interface eth1
awplus(config-if)# pppoe-ac-service ISP-service
```

To remove the PPPoE AC service 'isp1' from interface eth1, use the commands:

```
awplus# configure terminal
awplus(config)# interface eth1
awplus(config-if)# no pppoe-ac-service isp1
```

Related Commands [pppoe-ac](#)

proxy-auth

Overview Use this command to enable the proxy authentication to allow PPP authentication data to be collected and sent to an L2TP peer in additional L2TP AVPs when the L2TP session is established.

Use the **no** variant of this command to disable the proxy authentication.

Syntax proxy-auth
no proxy-auth

Default Proxy authentication is enabled by default.

Mode PPPoE Access Concentrator Configuration

Example To enable proxy authentication for the PPPoE AC service "ISP-service", use the commands:

```
awplus# configure terminal
awplus(config)# pppoe-ac ISP-service
awplus(config-pppoe-ac)# proxy-auth
```

Disable proxy authentication for PPPoE AC service "ISP-service:

```
awplus# configure terminal
awplus(config)# pppoe-ac ISP-service
awplus(config-pppoe-ac)# no proxy-auth
```

**Related
Commands**

[destination l2tp](#)
[l2tp peer-address dns-lookup](#)
[l2tp peer-address radius-lookup group](#)
[ppp-auth-protocol](#)
[pppoe-ac-service](#)
[service-name](#)
[show running-config pppoe-ac](#)

service-name

Overview Use this command to configure the PPPoE service name offered by the Access Concentrator (AC).

Use the **no** variant of this command to remove the service offered by the AC.

Syntax `service-name {any|<service-name> [advertised]}`
`no service-name {any|<service-name>}`

Parameter	Description
<code><service-name></code>	The name of the service to be offered.
<code>any</code>	The service should be provided to any client requesting it, regardless of the service name they request.
<code>advertised</code>	Whether the service is advertised to other clients.

Default No PPPoE service is configured by default.

Mode PPPoE Access Concentrator Configuration

Example To set the PPPoE AC labelled 'ISP-service' to provide service to any client requesting it, regardless of the service name they request, use the commands:

```
awplus# configure terminal
awplus(config)# pppoe-ac ISP-service
awplus(config-pppoe-ac)# service-name any
```

To offer a private (unadvertised) PPPoE service "internet" and an advertised PPPoE service "remote-office" to a client, use the commands:

```
awplus# configure terminal
awplus(config)# pppoe-ac ISP-service
awplus(config-pppoe-ac)# service-name internet
awplus(config-pppoe-ac)# service-name remote-office advertised
```

To remove the non-matching (any) PPPoE service so that it is no longer offered to a client, use the commands:

```
awplus# configure terminal
awplus(config)# pppoe-ac ISP-service
awplus(config-pppoe-ac)# no service-name any
```

To remove the private PPPoE service "internet" and advertised service "remote-office", so they are no longer offered to a client, use the commands:

```
awplus# configure terminal
awplus(config)# pppoe-ac ISP-service
awplus(config-pppoe-ac)# no service-name internet
awplus(config-pppoe-ac)# no service-name remote-office
```

**Related
Commands**

[destination l2tp](#)
[l2tp peer-address dns-lookup](#)
[l2tp peer-address radius-lookup group](#)
[l2tp peer-address static](#)
[l2tp profile](#)
[pppoe-ac](#)
[ppp-auth-protocol](#)
[show running-config pppoe-ac](#)

show debugging pppoe ac

Overview Use this command to display the status of the PPPoE AC debugging.

Syntax `show debugging pppoe ac`

Mode Privileged Exec

Usage Enable PPPoE AC debugging with the **debug pppoe-ac** command.

Example To display the status of PPPoE AC debugging, use the command:

```
awplus# show debugging pppoe ac
```

Output Figure 22-1: Example output from **show debugging pppoe ac**

```
awplus#show debugging pppoe ac
PPPoE-AC Debugging is on
```

Related Commands [debug pppoe-ac](#)

show pppoe-ac config-check

Overview Use this command to display information about the validity of the configurations for PPPoE AC routes.

Syntax show pppoe-ac [*<label>*] config-check

Parameter	Description
<i><label></i>	The label for the PPPoE AC service.

Mode Privileged Exec

Example To display the validity of the configurations for all PPPoE AC services, use the command:

```
awplus# show pppoe-ac config-check
```

To display the validity of the configurations for the PPPoE AC labelled "ac1" only, use the command:

```
awplus# show pppoe-ac ac1 config-check
```

Output Figure 22-2: Example output from **show pppoe-ac config-check**

```
awplus#sh pppoe-ac config-check

PPPoE Access Concentrator ac:
  Incomplete Configuration
  Required: add pppoe-ac-service to one or more interfaces
  Required: destination
  Required: service-name
  Required: l2tp peer-address
  Required: l2tp profile

PPPoE Access Concentrator ac1:
  Incomplete Configuration
  Required: add pppoe-ac-service to one or more interfaces

PPPoE Access Concentrator pppoeservice:
  Complete Configuration
```

Table 22-1: Parameters in the output from **show pppoe-ac config-check**

Parameter	Description
Incomplete configuration	Further configuration is required to create a valid PPPoE AC service.

Table 22-1: Parameters in the output from **show pppoe-ac config-check** (cont.)

Parameter	Description
Complete configuration	There is sufficient configuration of this PPPoE AC service to be valid.
Required	Parameters that still need to be configured for this PPPoE AC service.

Related Commands [pppoe-ac](#)
[show running-config pppoe-ac](#)

show pppoe-ac connections

Overview Use this command to display information about current routes for the specified PPPoE Access Concentrator (AC) service or for all PPPoE AC services.

Syntax show pppoe-ac [*<label>*] connections

Parameter	Description
<i><label></i>	The label for the PPPoE AC service.

Mode User Exec/Privileged Exec

Example To display current routes information for all PPPoE AC services, use the command:

```
awplus# show pppoe-ac connections
```

To display information about connected routes for the PPPoE AC service "pppoeservice" only, use the command:

```
awplus# show pppoe-ac pppoeservice connections
```

Output Figure 22-3: Example output from **show pppoe-ac connections**

```
awplus#show pppoe-ac connections
PPPoE Access Concentrator Connection Status
-----
Route Name: pppoeservice-eth1
Route ID: 29785
Source Information
  Interface: eth1
  Session ID: 14204
  Service Name: test
  State: Open
  Peer MAC: 00:00:cd:38:01:4f
Destination Information
  Type: L2TP
  Tunnel ID: 11223
  Session ID: 57309

Route Name: acl-eth2
Route ID: 34409
Source Information
  Interface: eth2
  Session ID: 14108
  Service Name: my_isp
  State: Open
  Peer MAC: 00:00:cd:38:01:4d
Destination Information
  Type L2TP
  Tunnel ID 47432
  Session ID 10056
```

Table 22-2: Parameters in the output from **show pppoe-ac connections**

Parameter	Description
Route Name	The name of the route.
Route ID	The ID of the route.
Source Information	Information about the source of the PPPoE route.
Interface	The incoming interface name.
Session ID	The PPPoE session ID.
Service Name	The service name that this PPPoE AC is offering. This is the service name assigned by the service-name command.
State	The state of the PPPoE connection; e.g. open.
peer MAC	The MAC address of the LNS.
Destination information	Information about the destination for this PPPoE route.
Type	The type of destination of the this PPPoE connection, for example, L2TP.
Tunnel ID	The ID of the L2TP tunnel.
Session ID	The ID of the PPPoE session.

Related Commands [pppoe-ac](#)

show pppoe-ac statistics

Overview Use this command to displays the statistics for the PPPoE Access Concentrator (AC).

Syntax show pppoe-ac statistics

Mode Privileged Exec

Example To display statistics for PPPoE AC, use the command:

```
awplus# show pppoe-ac statistics
```

Output Figure 22-4: Example output from **show pppoe-ac statistics**

```
awplus#sh pppoe-ac statistics
PPPoE Access Concentrator Statistics
Name                                     Value
-----
lnsLookupSuccessfulRequests             0
lnsLookupFailedRequests                 0
lnsLookupDnsFailures                    0
lnsLookupRadiusFailures                 0
l2tpTunnelsOpened                       2
l2tpSessionsOpened                      2
l2tpSessionsClosed                      0
l2tpDnsFailures                         0
pppoePadiReceived                       2
pppoeInvalidPadi                       0
pppoePadoSent                           2
pppoePadsSent                           2
pppoePadrReceived                       2
pppoeInvalidPadr                       0
pppoeResentPadr                         0
pppoePadtReceived                       0
pppoeInvalidPadt                       0
pppoePadtSent                           0
routesCreated                           2
routesCreateFail                        0
routesDeleted                           0
routesDeleteFail                        0
routesDstOpenFail                       0
routesDestCloseFail                     0
routesSourceCloseFail                   0
routesClosedByDest                      0
routesClosedBySource                     0
```

Table 22-3: Parameters in the output from **show pppoe-ac statistic**

Parameter	Description
lnsLookupSuccessfulRequests	The number of successful LNS address lookup requests.
lnsLookupFailedRequests	The number of failed LNS address lookup requests.
lnsLookupDnsFailures	The number of LNS address DNS lookup failures.
lnsLookupRadiusFailures	The number of LNS address RADIUS lookup failures.
l2tpTunnelsOpened	The number of L2TP tunnels opened.
l2tpSessionsOpened	The number of L2TP sessions opened.
l2tpSessionsClosed	The number of L2TP sessions closed.
l2tpDnsFailures	The number of L2TP DNS lookup failures.
pppoePadiReceived	The number of PADI packets received.
pppoeInvalidPadi	The number of invalid PADI packets received.
pppoePadoSent	The number of PADO packets sent.
pppoePadsSent	The number of PADS packets sent.
pppoePadrReceived	The number of PADR packets received.
pppoeInvalidPadr	The number of invalid PADR packets received.
pppoeResentPadr	The number of resent PADR packets received.
pppoePadtReceived	The number of PADT packets received.
pppoeInvalidPadt	The number of invalid PADT packets received.
pppoePadtSent	The number of PADT packets sent.
routesCreated	The number of routes created.
routesCreateFail	The number of route create failures.
routesDeleted	The number of routes deleted.
routesDeleteFail	The number of route delete failures.
routesDstOpenFail	The number of destination open failures.

Table 22-3: Parameters in the output from **show pppoe-ac statistic** (cont.)

Parameter	Description
routesDestCloseFail	The number of destination close failures.
routesSourceCloseFail	The number of source close failures.
routesClosedByDest	The number of routes closed by the destination.
routesClosedBySource	The number of routes closed by the source.

**Related
Commands** [clear pppoe-ac statistics](#)
[pppoe-ac](#)

show running-config pppoe-ac

Overview Use this command to display the PPPoE Access Concentrator (AC) running configuration.

Syntax `show running-config pppoe-ac`

Mode Privileged Exec

Example To display the running configuration for the PPPoE AC, use the command:

```
awplus# running-config pppoe-ac
```

Output Figure 22-5: Example output from **show running-config pppoe-ac**

```
awplus#show running-config pppoe-ac
pppoe-ac-service ISP-service
  service-name remote-office advertised
  ppp-auth-protocols pap
  destination l2tp
  l2tp peer-address static 192.168.11.2
  l2tp profile PUBLIC
```

**Related
Commands**

[destination l2tp](#)
[l2tp peer-address dns-lookup](#)
[l2tp peer-address radius-lookup group](#)
[l2tp peer-address static](#)
[l2tp profile](#)
[pppoe-ac](#)
[ppp-auth-protocol](#)
[proxy-auth](#)
[service-name](#)
[show pppoe-ac config-check](#)

Part 3: Routing

23

IP Addressing and Protocol Commands

Introduction

Overview This chapter provides an alphabetical reference of commands used to configure various IP features, including the following protocols:

- Address Resolution Protocol (ARP)

For more information, see the [IP Feature Overview and Configuration Guide](#).

- Command List**
- [“arp-aging-timeout”](#) on page 680
 - [“arp \(IP address MAC\)”](#) on page 681
 - [“arp log”](#) on page 683
 - [“arp opportunistic-nd”](#) on page 686
 - [“arp-reply-bc-dmac”](#) on page 688
 - [“clear arp-cache”](#) on page 689
 - [“debug ip packet interface”](#) on page 691
 - [“ip address \(IP Addressing and Protocol\)”](#) on page 693
 - [“ip directed-broadcast”](#) on page 695
 - [“ip forward-protocol udp”](#) on page 697
 - [“ip gratuitous-arp-link”](#) on page 699
 - [“ip helper-address”](#) on page 701
 - [“ip limited-local-proxy-arp”](#) on page 703
 - [“ip local-proxy-arp”](#) on page 705
 - [“ip proxy-arp”](#) on page 706
 - [“ip redirects”](#) on page 707
 - [“ip tcp synack-retries”](#) on page 708
 - [“ip tcp timeout established”](#) on page 709

- ["ip unreachable"](#) on page 710
- ["local-proxy-arp"](#) on page 712
- ["optimistic-nd"](#) on page 713
- ["ping"](#) on page 714
- ["show arp"](#) on page 716
- ["show debugging ip packet"](#) on page 719
- ["show ip forwarding"](#) on page 721
- ["show ip interface"](#) on page 722
- ["show ip interface vrf"](#) on page 723
- ["show ip sockets"](#) on page 725
- ["show ip traffic"](#) on page 728
- ["tcpdump"](#) on page 730
- ["traceroute"](#) on page 731
- ["undebg ip packet interface"](#) on page 732

arp-aging-timeout

Overview This command sets a timeout period on dynamic ARP entries associated with a specific interface. If your device stops receiving traffic for the host specified in a dynamic ARP entry, it deletes the ARP entry from the ARP cache after this timeout is reached.

Your device times out dynamic ARP entries to ensure that the cache does not fill with entries for hosts that are no longer active. Static ARP entries are not aged or automatically deleted.

By default the time limit for dynamic ARP entries is 300 seconds on all interfaces. The **no** variant of this command sets the time limit to the default of 300 seconds.

Syntax `arp-aging-timeout <0-432000>`
`no arp-aging timeout`

Parameter	Description
<code><0-432000></code>	The timeout period in seconds.

Default 300 seconds (5 minutes)

Mode Interface Configuration for a VLAN interface.

Example To set the ARP entries on interface `vlan30` to time out after two minutes, use the commands:

```
awplus# configure terminal
awplus(config)# interface vlan30
awplus(config-if)# arp-aging-timeout 120
```

Related Commands [clear arp-cache](#)
[show arp](#)

arp (IP address MAC)

Overview This command adds a static ARP entry to the ARP cache. This is typically used to add entries for hosts that do not support ARP or to speed up the address resolution function for a host. The ARP entry must not already exist. Use the **alias** parameter to allow your device to respond to ARP requests for this IP address.

If VRF-lite is configured, you can add ARP entries to either the global cache or for a specific VRF instance.

The **no** variant of this command removes the static ARP entry. Use the **clear arp-cache** command to remove the dynamic ARP entries in the ARP cache.

Syntax `arp <ip-addr> <mac-address> [<port-number>] [alias]`
`no arp <ip-addr>`

Syntax (VRF-lite) `arp [vrf <vrf-name>] <ip-addr> <mac-address> [<port-number>]`
`[alias]`
`no arp [vrf <vrf-name>] <ip-addr>`

Parameter	Description
<code><ip-addr></code>	The IPv4 address of the device you are adding as a static ARP entry.
<code><mac-address></code>	The MAC address of the device you are adding as a static ARP entry, in hexadecimal notation with the format HHHH.HHHH.HHHH.
<code><port-number></code>	The port number associated with the IP address. Specify this when the IP address is part of a VLAN.
<code>alias</code>	Allows your device to respond to ARP requests for the IP address. Proxy ARP must be enabled on the interface before using this parameter.
<code>vrf</code>	Apply this command to a VRF instance.
<code><vrf-name></code>	The name of the VRF instance.

Mode Global Configuration

Examples To add the IP address 10.10.10.9 with the MAC address 0010.2533.4655 into the ARP cache, and have your device respond to ARP requests for this address, use the commands:

```
awplus# configure terminal
awplus(config)# arp 10.10.10.9 0010.2355.4566 alias
```

Example (VRF-lite) To apply the above example within a VRF instance called `red` use the following commands:

```
awplus# configure terminal
awplus(config)# arp vrf red 10.10.10.9 0010.2355.4566 alias
```

Related Commands

- `clear arp-cache`
- `ip proxy-arp`
- `show arp`

Command changes Version 5.4.6-2.1: VRF-lite support added.

arp log

Overview This command enables the logging of dynamic and static ARP entries in the ARP cache. The ARP cache contains mappings of device ports, VLAN IDs, and IP addresses to physical MAC addresses for hosts.

This command can display the MAC addresses in the ARP log either using the notation HHHH.HHHH.HHHH, or using the IEEE standard hexadecimal notation (HH-HH-HH-HH-HH-HH).

Use the **no** variant of this command to disable the logging of ARP entries.

Syntax `arp log [mac-address-format ieee]`
`no arp log [mac-address-format ieee]`

Parameter	Description
<code>mac-address-format ieee</code>	Display the MAC address in the standard IEEE format (HH-HH-HH-HH-HH-HH), instead of displaying the MAC address with the format HHHH.HHHH.HHHH.

Default The ARP logging feature is disabled by default.

Mode Global Configuration

Usage You have the option to change how the MAC address is displayed in the ARP log message. The output can either use the notation HHHH.HHHH.HHHH or HH-HH-HH-HH-HH-HH.

Enter **arp log** to use HHHH.HHHH.HHHH notation.

Enter **arp log mac-address-format ieee** to use HH-HH-HH-HH-HH-HH notation.

Enter **no arp log mac-address-format ieee** to revert from HH-HH-HH-HH-HH-HH to HHHH.HHHH.HHHH.

Enter **no arp log** to disable ARP logging.

To display ARP log messages use the command **show log | include ARP_LOG**.

Examples To enable ARP logging and specify that the MAC address in the log message is displayed in HHHH.HHHH.HHHH notation, use the following commands:

```
awplus# configure terminal
awplus(config)# arp log
```

To disable ARP logging on the device, use the following commands:

```
awplus# configure terminal
awplus(config)# no arp log
```

To enable ARP logging and specify that the MAC address in the log message is displayed in the standard IEEE format hexadecimal notation (HH-HH-HH-HH-HH-HH), use the following commands:

```
awplus# configure terminal
awplus(config)# arp log mac-address-format ieee
```

To leave ARP logging enabled, but stop using HH-HH-HH-HH-HH-HH format and use HHHH.HHHH.HHHH format instead, use the following commands:

```
awplus# configure terminal
awplus(config)# no arp log mac-address-format ieee
```

To display ARP log messages, use the following command:

```
awplus# show log | include ARP_LOG
```

Output Figure 23-1: Output from **show log | include ARP_LOG** after enabling ARP logging using **arp log**. Note that this output uses HHHH.HHHH.HHHH format.

```
awplus#configure terminal
awplus(config)#arp log
awplus(config)#exit
awplus#show log | include ARP_LOG
2016 Oct 6 06:21:01 user.notice awplus HSL[1007]: ARP_LOG port1.0.1 vlan1 add
0013.4078.3b98 (192.168.2.4)
2016 Oct 6 06:22:30 user.notice awplus HSL[1007]: ARP_LOG port1.0.1 vlan1 del
0013.4078.3b98 (192.168.2.4)
2016 Oct 6 06:23:26 user.notice awplus HSL[1007]: ARP_LOG port1.0.1 vlan1 add
0030.940e.136b (192.168.2.20)
2016 Oct 6 06:23:30 user.notice awplus IMISH[1830]: show log | include ARP_LOG
```

Figure 23-2: Output from **show log | include ARP_LOG** after enabling ARP logging using **arp log mac-address format ieee**. Note that this output uses HH-HH-HH-HH-HH-HH format.

```
awplus#configure terminal
awplus(config)#arp log mac-address-format ieee
awplus(config)#exit
awplus#show log | include ARP_LOG
2016 Oct 6 06:25:28 user.notice awplus HSL[1007]: ARP_LOG port1.0.1 vlan1 add
00-17-9a-b6-03-69 (192.168.2.12)
2016 Oct 6 06:25:30 user.notice awplus HSL[1007]: ARP_LOG port1.0.1 vlan1 add
00-03-37-6b-a6-a5 (192.168.2.10)
2016 Oct 6 06:26:53 user.notice awplus HSL[1007]: ARP_LOG port1.0.1 vlan1 del
00-30-94-0e-13-6b (192.168.2.20)
2016 Oct 6 06:27:31 user.notice awplus HSL[1007]: ARP_LOG port1.0.1 vlan1 del
00-17-9a-b6-03-69 (192.168.2.12)
2016 Oct 6 06:28:09 user.notice awplus HSL[1007]: ARP_LOG port1.0.1 vlan1 del
00-03-37-6b-a6-a5 (192.168.2.10)
2016 Oct 6 06:28:14 user.notice awplus IMISH[1830]: show log | include ARP_LOG
```

The following table lists the parameters in output of the **show log | include ARP_LOG** command. The ARP log message format is:

```
<date> <time> <severity> <hostname> <program-name>  
ARP_LOG <port-number> <vid> <operation> <MAC> <IP>
```

Table 23-1: Parameters in the output from **show log | include ARP_LOG**

Parameter	Description
ARP_LOG	Indicates that ARP log entry information follows.
<port-number>	Indicates device port number for the ARP log entry.
<vid>	Indicates the VLAN ID for the ARP log entry.
<operation>	Indicates "add" if the ARP log entry displays an ARP addition. Indicates "del" if the ARP log entry displays an ARP deletion.
<MAC>	Indicates the MAC address for the ARP log entry, either in the default hexadecimal notation (HHHH.HHHH.HHHH) or in the IEEE standard format hexadecimal notation (HH-HH-HH-HH-HH-HH) as specified with the arp log mac-address-format ieee command.
<IP>	Indicates the IP address for the ARP log entry.

Related Commands [show log](#)
[show running-config](#)

arp opportunistic-nd

Overview Use this command to enable opportunistic neighbor discovery for the global ARP cache. This command changes the behavior for unsolicited ARP packet forwarding on the device.

When using VRF-lite, you can use this command to enable opportunistic neighbor discovery for a named VRF instance.

Use the **no** variant of this command to disable opportunistic neighbor discovery for the global ARP cache.

Syntax `arp opportunistic-nd`
`no arp opportunistic-nd`

Syntax (VRF-lite) `arp opportunistic-nd [vrf <vrf-name>]`
`no arp opportunistic-nd [vrf <vrf-name>]`

Parameter	Description
<code>vrf</code>	Apply this command to a VRF instance.
<code><vrf-name></code>	The name of the VRF instance.

Default Opportunistic neighbor discovery is disabled by default.

Mode Global Configuration

Usage When opportunistic neighbor discovery is enabled, the device will reply to any received unsolicited ARP packets (but not gratuitous ARP packets). The source MAC address for the unsolicited ARP packet is added to the ARP cache, so the device forwards the ARP packet. When opportunistic neighbor discovery is disabled, the source MAC address for the ARP packet is not added to the ARP cache, so the ARP packet is not forwarded by the device.

Note this command enables or disables opportunistic neighbor discovery for a VRF instance if the **vrf** parameter and an instance name are applied. If a VRF instance is not specified, then opportunistic neighbor discovery is enabled or disabled for device ports configured for IPv4.

Examples To enable opportunistic neighbor discovery for the global ARP cache, enter:

```
awplus# configure terminal
awplus(config)# arp opportunistic-nd
```

To disable opportunistic neighbor discovery for the global ARP cache, enter:

```
awplus# configure terminal
awplus(config)# no arp opportunistic-nd
```

Example (VRF-lite) To enable opportunistic neighbor discovery for the VRF instance 'blue', enter:

```
awplus# configure terminal
awplus(config)# arp opportunistic-nd vrf blue
```

To disable opportunistic neighbor discovery for the VRF instance 'blue', enter:

```
awplus# configure terminal
awplus(config)# no arp opportunistic-nd vrf blue
```

Related Commands

- ipv6 opportunistic-nd
- show arp
- show running-config interface

Command changes Version 5.4.6-2.1: VRF-lite support added.

arp-reply-bc-dmac

Overview Use this command to allow processing of ARP replies that arrive with a broadcast destination MAC (ffff.ffff.ffff). This makes neighbors reachable if they send ARP responses that contain a broadcast destination MAC.

Use the **no** variant of this command to turn off processing of ARP replies that arrive with a broadcast destination MAC.

Syntax `arp-reply-bc-dmac`
`no arp-reply-bc-dmac`

Default By default, this functionality is disabled.

Mode Interface Configuration for VLAN, Eth and bridge interfaces

Example To allow processing of ARP replies that arrive on VLAN2 with a broadcast destination MAC, use the commands:

```
awplus# configure terminal
awplus(config)# interface vlan2
awplus(config-if)# arp-reply-bc-dmac
```

**Related
Commands** `clear arp-cache`
`show arp`

clear arp-cache

Overview This command deletes dynamic ARP entries from the ARP cache. You can optionally specify the IPv4 address of an ARP entry to be cleared from the ARP cache.

When running VRF-lite, this command deletes dynamic ARP entries either from the ARP cache of a specific VRF instance, or from the ARP cache of the Global VRF instance. To delete all ARP entries from both the Global VRF instance and all VRF instances, use the command with no parameters. You can optionally specify the IPv4 address for the VRF instance to clear an ARP entry from the ARP cache.

Syntax `clear arp-cache [<ip-address>]`

Syntax (VRF-lite) `clear arp-cache [vrf <vrf-name>|global] [<ip-address>]`

Parameter	Description
<ip-address>	Specifies a specific IPv4 address for a VRF instance whose entries are to be cleared from the ARP cache.
global	When VRF-lite is configured, apply this command to the global routing and forwarding table.
vrf	Apply this command to the specified VRF instance.
<vrf-name>	The VRF instance name

Mode Privileged Exec

Usage To display the entries in the ARP cache, use the [show arp](#) command. To remove static ARP entries, use the no variant of the [arp \(IP address MAC\)](#) command.

Example To clear all dynamic ARP entries, use the command:

```
awplus# clear arp-cache
```

To clear all dynamic ARP entries associated with the IPv4 address 192.168.1.1, use the command:

```
awplus# clear arp-cache 192.168.1.1
```

Example (VRF-lite) To clear the dynamic ARP entries from the VRF instance named blue, use the commands:

```
awplus# clear arp-cache vrf blue
```

To clear the dynamic ARP entries from the VRF instance named blue with the IPv4 address 192.168.1.1, use the commands:

```
awplus# clear arp-cache vrf blue 192.168.1.1
```

When running VRF-lite, to clear the dynamic ARP entries from the global VRF-lite and all VRF instances, use the command:

```
awplus# clear arp-cache
```

**Related
Commands** [arp \(IP address MAC\)](#)
 [show arp](#)

debug ip packet interface

Overview The **debug ip packet interface** command enables IP packet debug and is controlled by the **terminal monitor** command.

If the optional **icmp** keyword is specified then ICMP packets are shown in the output.

The **no** variant of this command disables the **debug ip interface** command.

Syntax

```
debug ip packet interface {<interface-name>|all} [address <ip-address>|verbose|hex|arp|udp|tcp|icmp]
no debug ip packet interface [<interface-name>]
```

Parameter	Description
<interface>	Specify a single Layer 3 interface name (not a range of interfaces). This keyword can be specified as either all or as a single Layer 3 interface to show debugging for either all interfaces or a single interface.
all	Specify all Layer 3 interfaces on the device.
<ip-address>	Specify an IPv4 address. If this keyword is specified, then only packets with the specified IP address as specified in the ip-address placeholder are shown in the output.
verbose	Specify verbose to output more of the IP packet. If this keyword is specified then more of the packet is shown in the output.
hex	Specify hex to output the IP packet in hexadecimal. If this keyword is specified, then the output for the packet is shown in hex.
arp	Specify arp to output ARP protocol packets. If this keyword is specified, then ARP packets are shown in the output.
udp	Specify udp to output UDP protocol packets. If this keyword is specified then UDP packets are shown in the output.
tcp	Specify tcp to output TCP protocol packets. If this keyword is specified, then TCP packets are shown in the output.
icmp	Specify icmp to output ICMP protocol packets. If this keyword is specified, then ICMP packets are shown in the output.

Mode Privileged Exec and Global Configuration

Examples To turn on ARP packet debugging on `vlan1`, use the command:

```
awplus# debug ip packet interface vlan1 arp
```

To turn on all packet debugging on all interfaces on the device, use the command:

```
awplus# debug ip packet interface all
```

To turn on TCP packet debugging on `vlan1` and IP address `192.168.2.4`, use the command:

```
awplus# debug ip packet interface vlan1 address 192.168.2.4 tcp
```

To turn off IP packet interface debugging on all interfaces, use the command:

```
awplus# no debug ip packet interface
```

To turn off IP packet interface debugging on interface `vlan2`, use the command:

```
awplus# no debug ip packet interface vlan2
```

**Related
Commands**

[no debug all](#)

[show debugging ip dns forwarding](#)

[tcpdump](#)

[terminal monitor](#)

[undebug ip packet interface](#)

ip address (IP Addressing and Protocol)

Overview This command sets a static IP address on an interface.

The **no** variant of this command removes the IP address from the interface. You cannot remove the primary address when a secondary address is present.

Syntax `ip address <ip-addr/prefix-length> [secondary] [label <label>]`
`no ip address [<ip-addr/prefix-length>] [secondary]`

Parameter	Description
<ip-addr/prefix-length>	The IPv4 address and prefix length you are assigning to the interface.
secondary	Secondary IP address.
label	Adds a user-defined description of the secondary IP address.
<label>	A user-defined description of the secondary IP address. Valid characters are any printable character and spaces.

Mode Interface Configuration for a VLAN interface, a local loopback interface, or a PPP interface.

Usage To set the primary IP address on the interface, specify only **ip address** <ip-address/m>. This overwrites any configured primary IP address. To add additional IP addresses on this interface, use the **secondary** parameter. You must configure a primary address on the interface before configuring a secondary address.

NOTE: Use **show running-config interface** not **show ip interface brief** when you need to view a secondary address configured on an interface. **show ip interface brief** will only show the primary address not a secondary address for an interface.

Examples To add the primary IP address 10.10.10.50/24 to the interface `vlan3`, use the following commands:

```
awplus# configure terminal
awplus(config)# interface vlan3
awplus(config-if)# ip address 10.10.10.50/24
```

To add the secondary IP address 10.10.11.50/24 to the same interface, use the following commands:

```
awplus# configure terminal
awplus(config)# interface vlan3
awplus(config-if)# ip address 10.10.11.50/24 secondary
```

To add the IP address 10.10.11.50/24 to the local loopback interface lo, use the following commands:

```
awplus# configure terminal
awplus(config)# interface lo
awplus(config-if)# ip address 10.10.11.50/24
```

To add the IP address 10.10.11.50/24 to the PPP interface ppp0, use the following commands:

```
awplus# configure terminal
awplus(config)# interface ppp0
awplus(config-if)# ip address 10.10.11.50/24
```

**Related
Commands**

[interface \(to configure\)](#)
[show ip interface](#)
[show running-config interface](#)

ip directed-broadcast

Overview Use this command to enable flooding of directed broadcast packets into a directly connected subnet. If this command is configured on a VLAN interface, then directed broadcasts received on other VLAN interfaces, destined for the subnet on this VLAN, will be flooded to the subnet broadcast address of this VLAN.

Use the **no** variant of this command to disable **ip directed-broadcast**. When this feature is disabled using the **no** variant of this command, directed broadcasts are not forwarded.

Syntax `ip directed-broadcast`
`no ip directed-broadcast`

Default The **ip directed-broadcast** command is disabled by default.

Mode Interface Configuration for a VLAN interface, a local loopback interface, or a PPP interface.

Usage IP directed-broadcast is enabled and disabled per VLAN interface. When enabled a directed broadcast packet is forwarded to an enabled VLAN interface if received on another subnet.

An IP directed broadcast is an IP packet whose destination address is a broadcast address for some IP subnet, but originates from a node that is not itself part of that destination subnet. When a directed broadcast packet reaches a device that is directly connected to its destination subnet, that packet is flooded as a broadcast on the destination subnet.

The **ip directed-broadcast** command controls the flooding of directed broadcasts when they reach target subnets. The command affects the final transmission of the directed broadcast on its destination subnet. It does not affect the transit unicast routing of IP directed broadcasts. If directed broadcast is enabled for an interface, incoming directed broadcast IP packets intended for the subnet assigned to interface will be flooded as broadcasts on that subnet.

If the **no ip directed-broadcast** command is configured for an interface, directed broadcasts destined for the subnet where the interface is attached will be dropped instead of broadcast.

Examples To enable the flooding of broadcast packets out via the PPP interface ppp0, use the following commands:

```
awplus# configure terminal
awplus(config)# interface ppp0
awplus(config-if)# ip directed-broadcast
```

To disable the flooding of broadcast packets via PPP interface ppp0, use the following commands:

```
awplus# configure terminal
awplus(config)# interface ppp0
awplus(config-if)# no ip directed-broadcast
```

**Related
Commands**

- [ip forward-protocol udp](#)
- [ip helper-address](#)
- [show running-config](#)

ip forward-protocol udp

Overview This command enables you to control which UDP broadcasts will be forwarded to the helper address(es). A UDP broadcast will only be forwarded if the destination UDP port number in the packet matches one of the port numbers specified using this command.

Refer to the IANA site (www.iana.org) for a list of assigned UDP port numbers for protocols to forward using **ip forward-protocol udp**.

Use the **no** variant of this command to remove a port number from the list of destination port numbers that are used as the criterion for deciding if a given UDP broadcast should be forwarded to the IP helper address(es).

Syntax `ip forward-protocol udp <port>`
`no ip forward-protocol udp <port>`

Parameter	Description
<port>	UDP Port Number.

Default The **ip forward-protocol udp** command is not enabled by default.

Mode Global Configuration

Usage Combined with the **ip helper-address** command in interface mode, the **ip forward-protocol udp** command in Global Configuration mode allows control of which protocols (destination port numbers) are forwarded. The **ip forward-protocol udp** command configures protocols for forwarding, and the **ip helper-address** command configures the destination address(es).

NOTE:

*The types of UDP broadcast packets that the device will forward are ONLY those specified by the **ip forward-protocol** command(s). There are no other UDP packet types that the IP helper process forwards by default.*

Examples To configure forwarding of packets on a UDP port, use the following commands:

```
awplus# configure terminal
awplus(config)# ip forward-protocol udp <port>
```

To delete a UDP port from the UDP ports that the device forwards, use the following commands:

```
awplus# configure terminal
awplus(config)# no ip forward-protocol udp <port>
```

**Related
Commands** [ip helper-address](#)
[ip directed-broadcast](#)
[show running-config](#)

ip gratuitous-arp-link

Overview This command sets the Gratuitous ARP time limit for all switchports. The time limit restricts the sending of Gratuitous ARP packets to one Gratuitous ARP packet within the time in seconds.

NOTE: *This command specifies time between sequences of Gratuitous ARP packets, and time between individual Gratuitous ARP packets occurring in a sequence, to allow legacy support for older devices and interoperation between other devices that are not ready to receive and forward data until several seconds after linkup.*

Additionally, jitter has been applied to the delay following linkup, so Gratuitous ARP packets applicable to a given port are spread over a period of 1 second so are not all sent at once. Remaining Gratuitous ARP packets in the sequence occur after a fixed delay from the first one.

Syntax ip gratuitous-arp-link <0-300>
no ip gratuitous-arp-link

Parameter	Description
<0-300>	Specify the minimum time between sequences of Gratuitous ARPs and the fixed time between Gratuitous ARPs occurring in a sequence, in seconds. 0 disables the sending of Gratuitous ARP packets. The default is 8 seconds.

Default The default Gratuitous ARP time limit for all switchports is 8 seconds.

Mode Global Configuration

Usage Every switchport will send a sequence of 3 Gratuitous ARP packets to each VLAN that the switchport is a member of, whenever the switchport moves to the forwarding state. The first Gratuitous ARP packet is sent 1 second after the switchport becomes a forwarding switchport. The second and third Gratuitous ARP packets are each sent after the time period specified by the Gratuitous ARP time limit.

Additionally, the Gratuitous ARP time limit specifies the minimum time between the end of one Gratuitous ARP sequence and the start of another Gratuitous ARP sequence. When a link is flapping, the switchport's state is set to forwarding several times. The Gratuitous ARP time limit is imposed to prevent Gratuitous ARP packets from being sent undesirably often.

Examples To disable the sending of Gratuitous ARP packets, use the commands :

```
awplus# configure terminal
awplus(config)# ip gratuitous-arp-link 0
```

To restrict the sending of Gratuitous ARP packets to one every 20 seconds, use the commands:

```
awplus# configure terminal  
awplus(config)# ip gratuitous-arp-link 20
```

**Validation
Commands** `show running-config`

ip helper-address

Overview This command adds a forwarding destination address for IP Helper to enable forwarding of User Datagram Protocol (UDP) broadcasts on an interface. Use the **no** variant of this command to disable the forwarding of broadcast packets to specific addresses.

Syntax `ip helper-address <ip-addr>`
`no ip helper-address <ip-addr>`

Parameter	Description
<code><ip-addr></code>	Forwarding destination IP address for IP Helper.

Default The destination address for the **ip helper-address** command is not configured by default.

Mode Interface Configuration for a VLAN interface, a local loopback interface, or a PPP interface.

Usage Combined with the **ip forward-protocol udp** command in global configuration mode, the **ip helper-address** command in interface mode allows control of which protocols (destination port numbers) are forwarded. The **ip forward-protocol udp** command configures protocols for forwarding, and the **ip helper-address** command configures the destination address(es).

The destination address can be a unicast address or a subnet broadcast address. The UDP destination port is configured separately with the **ip forward-protocol udp** command. If multiple destination addresses are registered then UDP packets are forwarded to each IP address added to an IP Helper. Up to 32 destination addresses may be added using IP Helper.

The device will only forward the types of UDP broadcast packets that are specified by the **ip forward-protocol** command(s). The device does not forward any other UDP packet types by default.

The **ip helper-address** command does not support BOOTP / DHCP Relay. The **service dhcp-relay** command must be used instead. For this reason, you may not configure UDP ports 67 and 68 with the **ip forward-protocol** command.

See the [IP Feature Overview and Configuration Guide](#) for more information about DHCP Relay.

Examples The following example defines IPv4 address 192.168.1.100 as an IP Helper destination address to which to forward UDP broadcasts received on ppp0:

```
awplus# configure terminal
awplus(config)# interface ppp0
awplus(config-if)# ip helper-address 192.168.1.100
```

The following example removes IPv4 address 192.168.1.100 as an IP Helper destination address to which to forward UDP broadcasts received on ppp0:

```
awplus# configure terminal
awplus(config)# interface ppp0
awplus(config-if)# no ip helper-address 192.168.1.100
```

**Related
Commands**

- [ip forward-protocol udp](#)
- [ip directed-broadcast](#)
- [show running-config](#)

ip limited-local-proxy-arp

Overview Use this command to enable local proxy ARP, but only for a specified set of IP addresses. This makes the device respond to ARP requests for those IP addresses when the addresses are reachable via the interface you are configuring.

To specify the IP addresses, use the command [local-proxy-arp](#).

Use the **no** variant of this command to disable limited local proxy ARP. This stops your device from intercepting and responding to ARP requests for the specified hosts. This allows the hosts to use MAC address resolution to communicate directly with one another.

Syntax `ip limited-local-proxy-arp`
`no ip limited-local-proxy-arp`

Default Limited local proxy ARP is disabled by default.

Mode Interface Configuration

Usage Limited local proxy ARP supports Static NAT configurations in which the NAT configuration's public address is different to the ethernet interface's address.

On such ethernet interfaces, the device needs to respond to ARP requests for the public address so that it will receive packets targeted at that address.

Limited local proxy ARP makes this possible. It is especially useful when you have a number of 1-1 NAT configurations and each public address falls within the public interface's subnet. If you enable limited local proxy ARP on the public interface and specify suitable addresses, the device will respond to ARP requests for those addresses, as long as the addresses are routed out the interface the ARP requests are received on. The device responds with its own MAC address.

Example The following configuration snippet shows how to use limited local proxy ARP, if you are using NAT for an HTTP server with an address of 172.22.0.3 connected via eth1, and eth1 has an address of 172.22.0.1:

```
! Create a private zone for the HTTP server with address 172.22.200.3:
zone private
network vlan1
ip subnet 172.22.200.0/24
host http_server
ip address 172.22.200.3
!
! Create a public zone for the HTTP server with address 172.22.0.3:
zone public
network eth1
ip subnet 0.0.0.0/0 interface eth1
host http_server
ip address 172.22.0.3
!
! Create a NAT rule to map from the public to the private zone:
nat
rule 10 portfwd http from public.eth1 to public.eth1.http_server with dst
private.vlan1.http_server
enable
!
! Configure eth1. It has a different public address than the HTTP server:
interface eth1
ip limited local-proxy-arp
ip address 172.22.0.1/24
!
! Configure vlan1:
interface vlan1
ip address 172.22.200.5/24
!
! Tell the device to respond to ARPs for the HTTP server public address:
local-proxy-arp 172.22.0.3/32
```

**Related
Commands** [ip local-proxy-arp](#)
[local-proxy-arp](#)

ip local-proxy-arp

Overview This command allows you to stop MAC address resolution between hosts within a private VLAN edge interface. Local Proxy ARP works by intercepting ARP requests between hosts within a subnet and responding with your device's own MAC address details instead of the destination host's details. This stops hosts from learning the MAC address of other hosts within its subnet through ARP requests.

Local Proxy ARP ensures that devices within a subnet cannot send traffic that bypasses Layer 3 routing on your device. This lets you monitor and filter traffic between hosts in the same subnet, and enables you to have control over which hosts may communicate with one another.

When Local Proxy ARP is operating on an interface, your device does not generate or forward any ICMP-Redirect messages on that interface. This command does not enable proxy ARP on the interface; see the [ip proxy-arp](#) command for more information on enabling proxy ARP.

The **no** variant of this command disables Local Proxy ARP to stop your device from intercepting and responding to ARP requests between hosts within a subnet. This allows the hosts to use MAC address resolution to communicate directly with one another. Local Proxy ARP is disabled by default.

Syntax `ip local-proxy-arp`
`no ip local-proxy-arp`

Default Local proxy ARP is disabled by default

Mode Interface Configuration for a VLAN interface or a local loopback interface.

Examples To enable your device to apply Local Proxy ARP on the interface `vlan7`, use the following commands:

```
awplus# configure terminal
awplus(config)# interface vlan7
awplus(config-if)# ip local-proxy-arp
```

To disable your device to apply Local Proxy ARP on the interface `vlan7`, use the following commands:

```
awplus# configure terminal
awplus(config)# interface vlan7
awplus(config-if)# no ip local-proxy-arp
```

**Related
Commands** [ip proxy-arp](#)
[show arp](#)
[show running-config](#)

ip proxy-arp

Overview This command enables Proxy ARP responses to ARP requests on an interface. When enabled, your device intercepts ARP broadcast packets and substitutes its own physical address for that of the remote host. By responding to the ARP request, your device ensures that subsequent packets from the local host are directed to its physical address, and it can then forward these to the remote host.

Your device responds only when it has a specific route to the address being requested, excluding the interface route that the ARP request arrived from. It ignores all other ARP requests. See the [ip local-proxy-arp](#) command about enabling your device to respond to other ARP messages.

The **no** variant of this command disables Proxy ARP responses on an interface. Proxy ARP is disabled by default.

Syntax `ip proxy-arp`
`no ip proxy-arp`

Default Proxy ARP is disabled by default.

Mode Interface Configuration for a VLAN interface or a local loopback interface.

Examples To enable your device to Proxy ARP on the interface `vlan13`, use the following commands:

```
awplus# configure terminal
awplus(config)# interface vlan13
awplus(config-if)# ip proxy-arp
```

To disable your device to Proxy ARP on the interface `vlan13`, use the following commands:

```
awplus# configure terminal
awplus(config)# interface vlan13
awplus(config-if)# no ip proxy-arp
```

Related Commands [arp \(IP address MAC\)](#)
[ip local-proxy-arp](#)
[show arp](#)
[show running-config](#)

ip redirects

Overview This command enables the device to send ICMP redirects.

Use the **no** variant of this command to stop the device from sending ICMP redirects.

Syntax `ip redirects`
`no ip redirects`

Default ICMP redirects are disabled by default.

Mode Global Configuration.

Usage ICMP redirect messages are used to notify hosts that a better route is available to a destination.

ICMP redirects are used when a packet is routed into the device on the same interface that the packet is routed out of the device. ICMP redirects are only sent to packet sources that are directly connected to the device.

Examples To enable the switch to send ICMP redirects, use the following commands:

```
awplus# configure terminal
awplus(config)# ip redirects
```

To stop the switch from sending ICMP redirects, use the following commands:

```
awplus# configure terminal
awplus(config)# no ip redirects
```

ip tcp synack-retries

Overview Use this command to specify how many times the switch will retry sending a SYN ACK for a TCP connection for which it has received a SYN but not an ACK. Such connections are called half-open TCP connections. This command allows you to influence how long half-open TCP connections take to time out.

Use the **no** variant of this command to return to the default setting of 5 retries.

Syntax `ip tcp synack-retries <0-255>`
`no ip tcp synack-retries`

Parameter	Description
<0-255>	Number of times to retry sending the SYN ACK

Default 5 retries

Mode Global Configuration

Usage The following table shows the approximate correlation between the number of retries and the time half-open TCP connections take to time out.

Number of retries	Approximate lower bound for the timeout
0 retries	1 second
1 retry	3 seconds
2 retries	7 seconds
3 retries	15 seconds
4 retries	31 seconds
5 retries	63 seconds

Example To retry twice, which leads to a timeout of approximately 7 seconds, use the commands:

```
awplus# configure terminal  
awplus(config)# ip tcp synack-retries 2
```

Related Commands [show running-config](#)

Command changes Version 5.4.7-0.2: command added

ip tcp timeout established

Overview Use this command to set the idle timeout for all established TCP connections. Use the **no** variant of this command to set the idle timeout back to the default of 3600 seconds.

Syntax `ip tcp timeout established <1-31536000>`
`no ip tcp timeout established`

Parameter	Description
<code><1-31536000></code>	Idle timeout for established TCP connections in seconds from 1 to 3153600.

Default 3600 seconds (1 hour)

Mode Global Configuration

Usage By default, when a TCP session is successfully established through the firewall, when the session goes idle, it automatically times out of the firewall connection tracking table after 3600 seconds. In some situations it may be beneficial to time out unused established TCP sessions earlier.

For example, in a busy environment where there is an excessive number of sessions being established, the firewall connection tracking table could become oversubscribed, with new connections being blocked until older sessions are timed out.

Example To set a non-default TCP session timeout for established idle sessions of 1800 seconds (30 minutes), use the commands:

```
awplus# configure terminal
awplus(config)# ip tcp timeout established 1800
```

Example To set the TCP session timeout for established idle sessions back to the default setting of 3600 seconds, use the commands:

```
awplus# configure terminal
awplus(config)# no ip tcp timeout established
```

Related Commands [show running-config](#)

Command changes Version 5.4.6-1.1: command added

ip unreachables

Overview Use this command to enable ICMP (Internet Control Message Protocol) type 3, destination unreachable, messages.

Use the **no** variant of this command to disable destination unreachable messages. This prevents an attacker from using these messages to discover the topology of a network.

Syntax `ip unreachables`
`no ip unreachables`

Default Destination unreachable messages are enabled by default.

Mode Global Configuration

Usage When a device receives a packet for a destination that is unreachable it returns an ICMP type 3 message, this message includes a reason code, as per the table below. An attacker can use these messages to obtain information regarding the topology of a network. Disabling destination unreachable messages, using the **no ip unreachables** command, secures your network against this type of probing.

NOTE: *Disabling ICMP destination unreachable messages breaks applications such as traceroute and Path MTU Discovery (PMTUD), which depend on these messages to operate correctly.*

Table 23-2: ICMP type 3 reason codes and description

Code	Description [RFC]
0	Network unreachable [RFC792]
1	Host unreachable [RFC792]
2	Protocol unreachable [RFC792]
3	Port unreachable [RFC792]
4	Fragmentation required, and DF flag set [RFC792]
5	Source route failed [RFC792]
6	Destination network unknown [RFC1122]
7	Destination host unknown [RFC1122]
8	Source host isolated [RFC1122]
9	Network administratively prohibited [RFC768]
10	Host administratively prohibited [RFC869]
11	Network unreachable for Type of Service [RFC908]
12	Host unreachable for Type of Service [RFC938]
13	Communication administratively prohibited [RFC905]

Table 23-2: ICMP type 3 reason codes and description (cont.)

Code	Description [RFC]
14	Host Precedence Violation [RFC1812]
15	Precedence cutoff in effect [RFC1812]

Example To disable destination unreachable messages, use the commands

```
awplus# configure terminal  
awplus(config)# no ip unreachable
```

To enable destination unreachable messages, use the commands

```
awplus# configure terminal  
awplus(config)# ip unreachable
```

local-proxy-arp

Overview Use this command to specify an IP subnet for use with limited local proxy ARP. When limited local proxy ARP is enabled with the command `ip limited-local-proxy-arp`, the device will respond to ARP requests for addresses in that subnet.

Use the **no** variant of this command to stop specifying a subnet for use with limited local proxy ARP.

Syntax `local-proxy-arp [<ip-add/mask>]`
`no local-proxy-arp [<ip-add/mask>]`

Parameter	Description
<code><ip-add/mask></code>	The IP subnet to use with limited local proxy ARP, in dotted decimal format (A.B.C.D/M). To specify a single IP address, use a 32-bit mask.

Default No subnets are specified for use with limited local proxy ARP.

Mode Global Configuration

Example To specify limited local proxy ARP for the address 172.22.0.3, use the following commands:

```
awplus# configure terminal
awplus(config)# local-proxy-arp 172.22.0.3/32
```

This is part of a configuration snippet that shows how to use limited local proxy ARP with static NAT. See the command `ip limited-local-proxy-arp` for the whole example.

Related Commands `ip limited-local-proxy-arp`

optimistic-nd

Overview Use this command to enable the optimistic neighbor discovery feature for both IPv4 and IPv6.

Use the **no** variant of this command to disable the optimistic neighbor discovery feature.

Syntax `optimistic-nd`
`no optimistic-nd`

Default The optimistic neighbor discovery feature is enabled by default.

Mode Interface Configuration for a VLAN interface.

Usage The optimistic neighbor discovery feature allows the device, after learning an IPv4 or IPv6 neighbor, to refresh the neighbor before the neighbor is deleted from the hardware L3 switching table. The neighbor is put into the “stale” state in the software switching table if it is not refreshed, then the ‘stale’ neighbors are deleted from the hardware L3 switching table.

The optimistic neighbor discovery feature enables the device to sustain L3 traffic switching to a neighbor without interruption. Without the optimistic neighbor discovery feature enabled L3 traffic is interrupted when a neighbor is “stale” and is then deleted from the L3 switching table.

If a neighbor receiving optimistic neighbor solicitations does not answer optimistic neighbor solicitations with neighbor advertisements, then the neighbor will be put into the “stale” state, and subsequently deleted from both the software and the hardware L3 switching tables.

Examples To enable the optimistic neighbor discovery feature on vlan100, use the following commands:

```
awplus# configure terminal
awplus(config)# interface vlan100
awplus(config-if)# optimistic-nd
```

To disable the optimistic neighbor discovery feature on vlan100, use the following commands:

```
awplus# configure terminal
awplus(config)# interface vlan100
awplus(config-if)# no optimistic-nd
```

Related Commands [show running-config](#)

ping

Overview This command sends a query to another IPv4 host (send Echo Request messages).

Syntax ping [ip] <host> [broadcast] [df-bit {yes|no}] [interval <0-128>] [pattern <hex-data-pattern>] [repeat {<1-2147483647>|continuous}] [size <36-18024>] [source <ip-addr>] [timeout <1-65535>] [tos <0-255>]

Syntax (VRF-lite) ping [vrf <vrf-name>] [ip] <host> [broadcast] [df-bit {yes|no}] [interval <0-128>] [pattern <hex-data-pattern>] [repeat {<1-2147483647>|continuous}] [size <36-18024>] [source <ip-addr>] [timeout <1-65535>] [tos <0-255>]

Parameter	Description
<host>	The destination IP address or hostname.
broadcast	Allow pinging of a broadcast address.
df-bit	Enable or disable the do-not-fragment bit in the IP header.
interval <0-128>	Specify the time interval in seconds between sending ping packets. The default is 1. You can use decimal places to specify fractions of a second. For example, to ping every millisecond, set the interval to 0.001.
pattern <hex-data-pattern>	Specify the hex data pattern.
repeat	Specify the number of ping packets to send.
<1-2147483647>	Specify repeat count. The default is 5.
continuous	Continuous ping
size <36-18024>	The number of data bytes to send, excluding the 8 byte ICMP header. The default is 56 (64 ICMP data bytes).
source <ip-addr>	The IP address of a configured IP interface to use as the source in the IP header of the ping packet.
timeout <1-65535>	The time in seconds to wait for echo replies if the ARP entry is present, before reporting that no reply was received. If no ARP entry is present, it does not wait.
tos <0-255>	The value of the type of service in the IP header.
vrf	Apply the command to the specified VRF instance.
<vrf-name>	The name of the VRF instance.

Mode User Exec and Privileged Exec

Example To ping the IP address 10.10.0.5 use the following command:

```
awplus# ping 10.10.0.5
```

Example (VRF-lite) To ping the IP address 10.10.0.5 from VRF instance 'red', use the following command:

```
awplus# ping vrf red 10.10.0.5
```

NOTE: *Unless a cross-domain static or leaked route exists to the destination IP address, you must run this command from within the same routing domain as the address being pinged.*

Command changes Version 5.4.6-2.1: VRF-lite support added.

show arp

Overview Use this command to display entries in the ARP routing and forwarding table—the ARP cache contains mappings of IP addresses to physical addresses for hosts. To have a dynamic entry in the ARP cache, a host must have used the ARP protocol to access another host.

For information on filtering and saving command output, see the [“Getting Started with AlliedWare Plus” Feature Overview and Configuration Guide](#).

Syntax `show arp [security [interface [<interface-list>]]`
`show arp [statistics [detail][interface [<interface-list>]]`

Syntax (VRF-lite) `show arp [global|security|vrf <vrf-name>]`

Parameter	Description
<code>security</code>	Specify the DHCP Snooping ARP security output option.
<code>interface</code>	Specify an interface list for DHCP Snooping ARP security output.
<code><interface-list></code>	Specify a single Layer 3 interface name, or a range of interfaces.
<code>statistics</code>	Specify brief DHCP Snooping ARP security statistics.
<code>detail</code>	Specify detailed DHCP Snooping ARP security statistics.
<code>global</code>	When VRF-lite is configured, apply this command to the global routing and forwarding table
<code>vrf</code>	Apply this command to the specified VRF instance.
<code><vrf-name></code>	The VRF instance name

Mode User Exec and Privileged Exec

Usage Running this command with no additional parameters will display all entries in the ARP routing and forwarding table.

With VRF-lite configured, and no additional parameters entered, the command output displays all entries, listed by their VRF instance. By adding either a specific VRF instance or global parameter entry, you can selectively list ARP entries by their membership of a specific VRF instance.

Example To display all ARP entries in the ARP cache, use the following command:

```
awplus# show arp
```

Output Figure 23-3: Example output from the **show arp** command

```
awplus#show arp
IP Address      MAC Address    Interface      Port           Type
192.168.10.2   0015.77ad.fad8 vlan1          port1.0.1     dynamic
192.168.20.2   0015.77ad.fa48 vlan2          port1.0.2     dynamic
192.168.1.100  00d0.6b04.2a42 vlan2          port1.0.6     static
```

Example (VRF-lite) To display the dynamic ARP entries in the global routing instance, use the command:

```
awplus# show arp global
```

Output Figure 23-4: Example output from the **show arp global** command

```
awplus#show arp global
IP Address      MAC Address    Interface      Port           Type
192.168.10.2   0015.77ad.fad8 vlan1          port1.0.1     dynamic
192.168.20.2   0015.77ad.fa48 vlan2          port1.0.2     dynamic
192.168.1.100  00d0.6b04.2a42 vlan2          port1.0.8     static
```

Example (VRF-lite) To display the dynamic ARP entries for a VRF instance 'red', use the command:

```
awplus# show arp vrf red
```

Output Figure 23-5: Example output from the **show arp vrf red** command

```
awplus# show arp vrf red
[VRF: red]
IP Address      MAC Address    Interface      Port           Type
192.168.10.2   0015.77ad.fad8 vlan1          port1.0.1     dynamic
```

Table 24: Parameters in the output of the **show arp** command

Parameter	Meaning
IP Address	IP address of the network device this entry maps to.
MAC Address	Hardware address of the network device.
Interface	Interface over which the network device is accessed.
Port	Physical port that the network device is attached to.
Type	Whether the entry is a static or dynamic entry. Static entries are added using the arp (IP address MAC) command. Dynamic entries are learned from ARP request/reply message exchanges.
VRF	The name of the VRF instance. The VRF-lite components only display when VRF-lite is configured.

**Related
Commands** arp (IP address MAC)
clear arp-cache

**Command
changes** Version 5.4.6-2.1: VRF-lite support added.

show debugging ip packet

Overview Use this command to show the IP interface debugging status. IP interface debugging is set using the **debug ip packet interface** command.

For information on filtering and saving command output, see the [“Getting Started with AlliedWare Plus” Feature Overview and Configuration Guide](#).

Syntax show debugging ip packet

Mode User Exec and Privileged Exec

Example To display the IP interface debugging status when the terminal monitor off, use the command:

```
awplus# terminal no monitor
awplus# show debug ip packet
```

Output Figure 23-6: Example output from the **show debugging ip packet** command with **terminal monitor** off

```
awplus#terminal no monitor

awplus#show debug ip packet

IP debugging status:

interface all tcp (stopped)

interface vlan1 arp verbose (stopped)
```

Example To display the IP interface debugging status when the terminal monitor is on, use the command:

```
awplus# terminal monitor
awplus# show debug ip packet
```

Output Figure 23-7: Example output from the **show debugging ip packet** command with **terminal monitor** on

```
awplus#terminal monitor

awplus#show debug ip packet

IP debugging status:

interface all tcp (running)

interface vlan1 arp verbose (running)
```

**Related
Commands** [debug ip packet interface](#)
[terminal monitor](#)

show ip forwarding

Overview Use this command to display the IP forwarding status.

For information on filtering and saving command output, see the [“Getting Started with AlliedWare Plus” Feature Overview and Configuration Guide](#).

Syntax `show ip forwarding`

Mode User Exec and Privileged Exec

Example `awplus# show ip forwarding`

Output Figure 23-8: Example output from the **show ip forwarding** command

```
awplus#show ip forwarding
IP forwarding is on
```

show ip interface

Overview Use this command to display information about interfaces and the IP addresses assigned to them. To display information about a specific interface, specify the interface name with the command.

For information on filtering and saving command output, see the [“Getting Started with AlliedWare Plus” Feature Overview and Configuration Guide](#).

Syntax `show ip interface [<interface-list>] [brief]`

Parameter	Description
<interface-list>	The interfaces to display information about. An interface-list can be: <ul style="list-style-type: none">• an interface, e.g. <code>vlan2</code>• a continuous range of interfaces separated by a hyphen, e.g. <code>vlan2-8</code> or <code>vlan2-vlan5</code>• a comma-separated list of interfaces or interface ranges, e.g. <code>vlan2, vlan5, vlan8-10</code> The specified interfaces must exist.

Mode User Exec and Privileged Exec

Examples To show brief information for the assigned IP address for interface `port1.0.2` use the command:

```
awplus# show ip interface port1.0.2 brief
```

To show the IP addresses assigned to `vlan2` and `vlan3`, use the command:

```
awplus# show ip interface vlan2-3 brief
```

To show the IP addresses assigned to `ppp0`, use the command:

```
awplus# show ip interface ppp0 brief
```

Output Figure 23-9: Example output from the **show ip interface brief** command

Interface	IP-Address	Status	Protocol
port1.0.2	unassigned	admin up	down
vlan1	192.168.1.1	admin up	running
vlan2	192.168.2.1	admin up	running
vlan3	192.168.3.1	admin up	running
vlan8	unassigned	admin up	down

show ip interface vrf

Overview Use this command to display protocol and status information about configured interfaces and their assigned IP addresses in VRF instances.

For information on filtering and saving command output, see the [“Getting Started with AlliedWare Plus” Feature Overview and Configuration Guide](#).

Syntax `show ip interface [vrf <vrf-name>|global]`

Parameter	Description
vrf	A VRF instance.
<vrf-name>	The name of a specific VRF instance.
global	The global routing and forwarding table.

Mode User Exec and Privileged Exec

Examples To display all interfaces and IP addresses associated with a VRF instance ‘red’, use the command:

```
awplus# show ip interface vrf red
```

Output Figure 23-10: Example output from **show ip interface vrf red**

[VRF: red]			
Interface	IP-Address	Status	Protocol
lo1	unassigned	admin up	running
vlan1	192.168.10.1/24	admin up	running

Example To display all interfaces and IP addresses associated with all VRF instances, use the command:

```
awplus# show ip interface
```

Output Figure 23-11: Example output from the **show ip interface** with VRF-lite configured

Interface	IP-Address	Status	Protocol
eth0	unassigned	admin up	down
lo	unassigned	admin up	running
vlan1	192.168.1.1/24	admin up	running
vlan4	172.30.4.43/24	admin up	down
[VRF: red]			
Interface	IP-Address	Status	Protocol
lo1	unassigned	admin up	running
[VRF: blue]			
Interface	IP-Address	Status	Protocol
lo2	unassigned	admin up	running

Command changes Version 5.4.6-2.1: VRF-lite support added.

show ip sockets

Overview Use this command to display information about the IP or TCP sockets that are present on the device. It includes TCP and UDP listen sockets, and displays the associated IP address and port.

The information displayed for established TCP sessions includes the remote IP address, port, and session state. Raw IP protocol listen socket information is also displayed for protocols such as VRRP and ICMP6, which are configured to receive IP packets with the associated protocol number.

For information on filtering and saving command output, see the [“Getting Started with AlliedWare Plus” Feature Overview and Configuration Guide](#).

Syntax `show ip sockets`

Mode Privileged Exec

Usage Use this command to verify that the socket being used is opening correctly. If there is a local and remote endpoint, a connection is established with the ports indicated.

Note that this command does not display sockets that are used internally for exchanging data between the various processes that exist on the device and are involved in its operation and management. It only displays sockets that are present for the purposes of communicating with other external devices.

Example To display IP sockets currently present on the device, use the command:

```
awplus# show ip sockets
```

Output Figure 23-12: Example output from **show ip sockets**

```
Socket information

Not showing 40 local connections
Not showing 7 local listening ports
```

Typ	Local Address	Remote Address	State
tcp	0.0.0.0:111	0.0.0.0:*	LISTEN
tcp	0.0.0.0:80	0.0.0.0:*	LISTEN
tcp	0.0.0.0:23	0.0.0.0:*	LISTEN
tcp	0.0.0.0:443	0.0.0.0:*	LISTEN
tcp	0.0.0.0:4743	0.0.0.0:*	LISTEN
tcp	0.0.0.0:873	0.0.0.0:*	LISTEN
tcp	:::23	:::*	LISTEN
udp	0.0.0.0:111	0.0.0.0:*	
udp	226.94.1.1:5405	0.0.0.0:*	
udp	0.0.0.0:161	0.0.0.0:*	
udp	:::161	:::*	
raw	0.0.0.0:112	0.0.0.0:*	112
raw	:::58	:::*	58
raw	:::112	:::*	112

Table 23-1: Parameters in the output from **show ip sockets**

Parameter	Description
Not showing <number> local connections	This field refers to established sessions between processes internal to the device, that are used in its operation and management. These sessions are not displayed as they are not useful to the user. <number> is some positive integer.
Not showing <number> local listening ports	This field refers to listening sockets belonging to processes internal to the device, that are used in its operation and management. They are not available to receive data from other devices. These sessions are not displayed as they are not useful to the user. <number> is some positive integer.
Typ	This column displays the type of the socket. Possible values for this column are: tcp : IP Protocol 6 udp : IP Protocol 17 raw : Indicates that socket is for a non port-orientated protocol (i.e. a protocol other than TCP or UDP) where all packets of a specified IP protocol type are accepted. For raw socket entries the protocol type is indicated in subsequent columns.
Local Address	For TCP and UDP listening sockets this shows the destination IP address and destination TCP or UDP port number for which the socket will receive packets. The address and port are separated by ':'. If the socket will accept packets addressed to any of the device's IP addresses, the IP address will be 0.0.0.0 for IPv4 or :: for IPv6. For active TCP sessions the IP address will display which of the devices addresses the session was established with. For raw sockets this displays the IP address and IP protocol for which the socket will accept IP packets. The address and protocol are separated by ':'. If the socket will accept packets addressed to any of the device's IP addresses, the IP address will be 0.0.0.0 for IPv4 and :: for IPv6. IP Protocol assignments are described at: www.iana.org/assignments/protocol-numbers

Table 23-1: Parameters in the output from **show ip sockets** (cont.)

Parameter	Description
Remote Address	For TCP and UDP listening sockets this shows the source IP address (either IPv4 or IPv6) and source TCP or UDP port number for which the socket will accept packets. The address and port are separated by ':'. If the socket will accept packets addressed from any IP address, the IP address will be 0.0.0.0 for IPv4 . This is the usual case for a listening socket. Normally for a listen socket any source port will be accepted. This is indicated by '. For active TCP sessions the IP address will display the remote address and port the session was established with. For raw sockets the entry in this column will be 0.0.0.0: for IPv4 .
State	This column shows the state of the socket. For TCP sockets this shows the state of the TCP state machine. For UDP sockets this column is blank. For raw sockets it contains the IP protocol number. The possible TCP states are: LISTEN SYN-SENT SYN-RECEIVED ESTABLISHED FIN-WAIT-1 FIN-WAIT-2 CLOSE-WAIT CLOSING LAST-ACK TIME-WAIT CLOSED RFC793 contains the TCP state machine diagram with Section 3.2 describing each of the states.

show ip traffic

Overview Use this command to display statistics regarding IP traffic sent and received by all interfaces on the device, showing totals for IP and IPv6 and then broken down into sub-categories such as TCP, UDP, ICMP and their IPv6 equivalents when appropriate.

For information on filtering and saving command output, see the [“Getting Started with AlliedWare Plus” Feature Overview and Configuration Guide](#).

Syntax show ip traffic

Mode Privileged Exec

Example To display IP traffic statistics, use the command:

```
awplus# show ip traffic
```

Output Figure 23-13: Example output from the **show ip traffic** command

```
IP:
    261998 packets received
    261998 delivered
    261998 sent
    69721 multicast packets received
    69721 multicast packets sent
    23202841 bytes received
    23202841 bytes sent
    7669296 multicast bytes received
    7669296 multicast bytes sent
IPv6:
    28 packets discarded on transmit due to no route
ICMP6:
UDP6:
UDPLite6:
TCP:
    0 remote connections established
    40 local connections established
    7 remote listening ports
    7 local listening ports
    261 active connection openings
    247 passive connection openings
    14 connection attempts failed
    122535 segments received
    122535 segments transmitted
    14 resets transmitted
    227 TCP sockets finished time wait in fast timer
```



```
155 delayed acks sent
21187 headers predicted
736 pure ACKs
80497 pure ACKs predicted
UDP:
  139468 datagrams received
  139468 datagrams sent
UDPLite:
```

tcpdump

Overview Use this command to start a tcpdump, which gives the same output as the Unix-like **tcpdump** command to display TCP/IP traffic. Press <ctrl> + c to stop a running tcpdump.

Syntax tcpdump <line>

Syntax (VRF-lite) tcpdump [vrf <vrf-name>] <line>

Parameter	Description
<line>	Specify the dump options. For more information on the options for this placeholder see http://www.tcpdump.org/tcpdump_man.html
vrf	Apply the command to the specified VRF instance.
<vrf-name>	The name of the VRF instance.

Mode Privileged Exec

Example To start a tcpdump running to capture IP packets, enter the command:

```
awplus# tcpdump ip
```

Example (VRF-lite) To start a tcpdump on interface vlan2 associated with a VRF instance red, enter the command:

```
awplus# tcpdump vrf red vlan2
```

Output Figure 23-14: Example output from the **tcpdump** command

```
03:40:33.221337 IP 192.168.1.1 > 224.0.0.13: PIMv2, Hello,
length: 34
1 packets captured
2 packets received by filter
0 packets dropped by kernel
```

Related Commands [debug ip packet interface](#)

Command changes Version 5.4.6-2.1: VRF-lite support added.

traceroute

Overview Use this command to trace the route to the specified IPv4 host.

Syntax `traceroute {<ip-addr>|<hostname>}`

Syntax (VRF-lite) `traceroute [vrf <vrf-name>] {<ip-addr>|<hostname>}`

Parameter	Description
<code><ip-addr></code>	The destination IPv4 address. The IPv4 address uses the format A.B.C.D.
<code><hostname></code>	The destination hostname.
<code>vrf</code>	Apply the command to the specified VRF instance.
<code><vrf-name></code>	The name of the VRF instance.

Mode User Exec and Privileged Exec

Example `awplus# traceroute 10.10.0.5`

Example (VRF-lite) `awplus# traceroute vrf red 192.168.0.1`

Command changes Version 5.4.6-2.1: VRF-lite support added.

undebug ip packet interface

Overview This command applies the functionality of the no `debug ip packet interface` command.

24

Domain Name Service (DNS) Commands

Introduction

Overview This chapter provides an alphabetical reference of commands used to configure Domain Name Service (DNS) features, including the following:

- DNS client
- DNS forwarding (DNS relay)
- Domain lists
- DDNS (Dynamic Domain Name System)

For more information about DNS and DDNS for AR-Series Firewalls, see the [Domain Name System \(DNS\) for AlliedWare Plus AR-Series Firewalls Feature Overview and Configuration Guide](#).

- Command List**
- “clear ip dns forwarding cache” on page 735
 - “ddns enable” on page 736
 - “ddns-update-method” on page 737
 - “ddns-update now” on page 738
 - “debug ddns” on page 739
 - “debug ip dns forwarding” on page 740
 - “description (Domain List)” on page 741
 - “domain (Domain List)” on page 742
 - “host-name (DDNS)” on page 743
 - “ip ddns-update-method” on page 744
 - “ip dns forwarding” on page 745
 - “ip dns forwarding cache” on page 746
 - “ip dns forwarding dead-time” on page 747
 - “ip dns forwarding domain-list” on page 748

- [“ip dns forwarding retry”](#) on page 749
- [“ip dns forwarding source-interface”](#) on page 750
- [“ip dns forwarding timeout”](#) on page 751
- [“ip domain-list”](#) on page 752
- [“ip domain-lookup”](#) on page 753
- [“ip domain-name”](#) on page 754
- [“ip name-server”](#) on page 755
- [“ipv6 ddns-update-method”](#) on page 757
- [“password \(DDNS\)”](#) on page 758
- [“ppp ipcp dns”](#) on page 759
- [“ppp ipcp dns suffix-list”](#) on page 761
- [“retry-interval \(DDNS\)”](#) on page 763
- [“show ddns-update-method status”](#) on page 764
- [“show debugging ip dns forwarding”](#) on page 765
- [“show hosts”](#) on page 766
- [“show ip dns forwarding”](#) on page 767
- [“show ip dns forwarding cache”](#) on page 768
- [“show ip dns forwarding server”](#) on page 770
- [“show ip domain-list”](#) on page 772
- [“show ip domain-name”](#) on page 773
- [“show ip name-server”](#) on page 774
- [“suppress-ipv4-updates \(DDNS\)”](#) on page 776
- [“undebug \(DDNS\)”](#) on page 777
- [“update-interval \(DDNS\)”](#) on page 778
- [“update-url \(DDNS\)”](#) on page 779
- [“use-ipv4-for-ipv6-updates \(DDNS\)”](#) on page 782
- [“username \(DDNS\)”](#) on page 783

clear ip dns forwarding cache

Overview Use this command to clear the DNS Relay name resolver cache.

When using VRF-lite, use this command to clear the DNS Relay name resolver cache for either the whole device or for a specific VRF instance.

Syntax `clear ip dns forwarding cache`

Syntax (VRF-lite) `clear ip dns [vrf <name>|global] forwarding cache`

Parameter	Description
vrf	Apply this command to the specified VRF instance.
<name>	The name of the specific VRF instance
global	When VRF-lite is configured, apply this command to the global routing and forwarding table.

Mode Privileged Exec

Examples To clear all cached data, use the command:

```
awplus# clear ip dns forwarding cache
```

Example (VRF-lite) To clear the cached data for VRF instance red, use the command:

```
awplus# clear ip dns vrf red forwarding cache
```

To clear the cached data for the default global VRF instance only, use the command:

```
awplus# clear ip dns global forwarding cache
```

Related Commands [ip dns forwarding cache](#)

Command changes Version 5.4.6-2.1: VRF-lite support added.

ddns enable

Overview Use this command to enable DDNS updates.
Use the **no** variant of this command to disable DDNS updates.

Syntax `ddns enable`
`no ddns enable`

Default Disabled

Mode Global Configuration

Example To globally enable DDNS updates, use the commands:

```
awplus# configure terminal  
awplus(config)# ddns enable
```

To globally disable DDNS updates, use the commands:

```
awplus# configure terminal  
awplus(config)# no ddns enable
```

Related Commands [ddns-update-method](#)

Command changes Version 5.4.7-0.1: command added

ddns-update-method

Overview Use this command to create a new DDNS update method and enter DDNS Update Method Configuration mode.

Use the **no** variant of this command to remove a DDNS update method.

Syntax `ddns-update-method <method-name>`
`no ddns-update-method <method-name>`

Parameter	Description
<code><method-name></code>	The name of the DDNS method.

Default None

Mode Global Configuration

Example To create a method named "dyndns", use the commands:

```
awplus# configure terminal
awplus(config)# ddns-update-method dyndns
awplus(config-ddns-update-method)#
```

**Related
Commands**

`ddns enable`
`ddns-update now`
`debug ddns`
`host-name (DDNS)`
`ip ddns-update-method`
`ipv6 ddns-update-method`
`password (DDNS)`
`retry-interval (DDNS)`
`show ddns-update-method status`
`suppress-ipv4-updates (DDNS)`
`undebug (DDNS)`
`update-interval (DDNS)`
`update-url (DDNS)`
`use-ipv4-for-ipv6-updates (DDNS)`
`username (DDNS)`

**Command
changes** Version 5.4.7-0.1: command added

ddns-update now

Overview Use this command to manually update DDNS methods.

Syntax `ddns-update now`
`ddns-update method <method-name> now`

Parameter	Description
<code><method-name></code>	The DDNS update method name to use for the manual update.

Default None

Mode Privileged Exec

Usage When no method name is entered, all DDNS update methods are updated. If a method name is specified, then only that method will update.

Example To manually update all DDNS update methods, use the command:

```
awplus# ddns-update now
```

To manually update the method "dyndns", use the command:

```
awplus# ddns-update method dyndns now
```

Related Commands [ddns-update-method](#)

Command changes Version 5.4.7-0.1: command added

debug ddns

Overview Use this command to enable debugging for the DDNS process.
Use the **no** variant of this command to disable debugging for the DDNS process.

Syntax debug ddns
no debug ddns

Default Disabled

Mode Privileged Exec

Example To enable debugging for the DDNS process, use the command:

```
awplus# debug ddns
```

To disable debugging for the DDNS process, use the command:

```
awplus# no debug ddns
```

Related Commands [ddns-update-method](#)
[undebug \(DDNS\)](#)

Command changes Version 5.4.7-0.1: command added

debug ip dns forwarding

Overview Use this command to enable DNS Relay debugging.
Use the **no** variant of this command to disable DNS Relay debugging.

Syntax `debug ip dns forwarding`
`no debug ip dns forwarding`

Default DNS Relay debugging is disabled by default.

Mode Privileged Exec

Examples To enable DNS forwarding debugging, use the commands:

```
awplus# debug ip dns forwarding
```

To disable DNS forwarding debugging, use the commands:

```
awplus# no debug ip dns forwarding
```

Related Commands [ip dns forwarding](#)
[show debugging ip dns forwarding](#)

description (Domain List)

Overview Use this command to give a description to a domain-list.
Use the **no** variant of this command to delete the description.

Syntax `description <text>`
`no description`

Parameter	Description
<code><text></code>	Description string, 128 characters maximum. The string may contain spaces.

Mode Domain List Mode

Usage When creating a domain-list, it is helpful to write a short description of what the list is to be used for.

Examples To add a description to a domain list, use the commands:

```
awplus# configure terminal
awplus(config)# ip dns forwarding domain-list mydomains
awplus(config-domain-list)# description This is a useful
description of my domain list
```

To delete the description, use the commands:

```
awplus# configure terminal
awplus(config)# ip dns forwarding domain-list mydomains
awplus(config-domain-list)# no description
```

Related Commands [ip dns forwarding domain-list](#)

domain (Domain List)

Overview Use this command to add a domain to a domain list.
Use the **no** variant of this command to delete the domain.

Syntax `domain <domain-string>`
`no domain <domain-string>`

Parameter	Description
<code><domain-string></code>	<ul style="list-style-type: none">• A domain name must only contain a-z, A-Z, 0-9, '-' (en-dash) and '.' (period) characters.• Each sub-section of the domain must not start or end with the '-' character.• Each sub-section must have no more than 64 characters including the '.'.• The last section must not have a '.' at the end.• The whole domain must be less than 254 characters long.

Mode Domain List Mode

Usage Domain lists are objects that contain unsorted lists of domain names. After a domain list has been created, you can use this command to add domains to the domain list. There is no limit on the number of domains that can be added to a domain list.

Examples To add the domain "acme-solutions.com" to a domain list, use the commands:

```
awplus# configure terminal
awplus(config)# ip dns forwarding domain-list acme-corporation
awplus(config-domain-list)# domain acme-solutions.com
```

To delete the domain, use the commands:

```
awplus# configure terminal
awplus(config)# ip dns forwarding domain-list acme-corporation
awplus(config-domain-list)# no domain acme-solutions.com
```

Related Commands [ip dns forwarding domain-list](#)

host-name (DDNS)

Overview Use this command to add a host name for the current DDNS update method.

NOTE: A DDNS update method can only have one host name.

Use the **no** variant of this command to remove the host name from the current DDNS update method.

Syntax `host-name <host-name>`
`no host-name`

Parameter	Description
<code><host-name></code>	The name of the host to be configured in conjunction with the user name and password.

Default None

Mode DDNS Update Method Configuration

Example To add the host name "test.dyndns.org" for the DDNS update method "dyndns", use the commands:

```
awplus# configure terminal
awplus(config)# ddns-update-method dyndns
awplus(config-ddns-update-mthod)# host-name test.dyndns.org
```

To remove the host name "test.dyndns.org" from the DDNS update method "dyndns", use the commands:

```
awplus# configure terminal
awplus(config)# ddns-update-method dyndns
awplus(config-ddns-update-mthod)# no host-name
```

Related Commands [ddns-update-method](#)

Command changes Version 5.4.7-0.1: command added

ip ddns-update-method

Overview Use this command to enable an IPv4 interface to update DDNS with the specified DDNS update method.

Use the **no** variant of this command to disable an IPv4 interface to update DDNS with the specified DDNS update method.

Syntax `ip ddns-update-method <method-name>`
`no ip ddns-update-method <method-name>`

Parameter	Description
<code><method-name></code>	A name given to a DDNS update method.

Default None

Mode Interface Configuration

Usage A DDNS update method cannot be attached to multiple interfaces, however multiple DDNS update methods can be assigned to the same interface.

Example To enable IPv4 DDNS updates for a DDNS update method named "dyndns" using interface eth1, use the commands:

```
awplus# configure terminal
awplus(config)# interface eth1
awplus(config-if)# ip ddns-update-method dyndns
```

To disable IPv4 DDNS updates for a DDNS update method named "dyndns" using interface eth1, use the commands:

```
awplus# configure terminal
awplus(config)# interface eth1
awplus(config-if)# no ip ddns-update-method dyndns
```

Related Commands [ddns-update-method](#)

Command changes Version 5.4.7-0.1: command added

ip dns forwarding

Overview Use this command to enable DNS Relay, the forwarding of incoming DNS queries for IP hostname-to-address translation.

Use the **no** variant of this command to disable the forwarding of incoming DNS queries for IP hostname-to-address translation.

Syntax `ip dns forwarding`
`no ip dns forwarding`

Default The forwarding of incoming DNS query packets is disabled by default.

Mode Global Configuration

Usage DNS Relay requires that IP domain lookup is enabled. IP domain lookup is enabled by default, but if it has been disabled, you can re-enable it by using the command [ip domain-lookup](#).

See the [ip dns forwarding dead-time](#) command used with this command.

NOTE: *When running VRF-lite, the DNS Relay functions will apply separately within each VRF instance.*

Examples To enable the forwarding of incoming DNS query packets, use the commands:

```
awplus# configure terminal
awplus(config)# ip dns forwarding
```

To disable the forwarding of incoming DNS query packets, use the commands:

```
awplus# configure terminal
awplus(config)# no ip dns forwarding
```

Related Commands

- [clear ip dns forwarding cache](#)
- [debug ip dns forwarding](#)
- [ip dns forwarding cache](#)
- [ip dns forwarding dead-time](#)
- [ip dns forwarding retry](#)
- [ip dns forwarding source-interface](#)
- [ip dns forwarding timeout](#)
- [ip name-server](#)
- [show ip dns forwarding](#)
- [show ip dns forwarding cache](#)
- [show ip dns forwarding server](#)

ip dns forwarding cache

Overview Use this command to set the DNS Relay name resolver cache size and cache entry lifetime period. The DNS Relay name resolver cache stores the mappings between domain names and IP addresses.

Use the **no** variant of this command to set the default DNS Relay name resolver cache size and cache entry lifetime period.

Note that the lifetime period of the cache entry can be overwritten by the time-out period of the DNS reply from the DNS server if the time-out period of the DNS reply from the DNS server is smaller than the configured time-out period. The time-out period of the cache entry will only be used when the time-out period of the DNS reply from the DNS server is bigger than the time-out period configured on the device.

Syntax `ip dns forwarding cache [size <0-1000>] [timeout <60-3600>]`
`no ip dns forwarding cache [size|timeout]`

Parameter	Description
<0-1000>	Number of entries in the DNS Relay name resolver cache.
<60-3600>	Timeout value in seconds. Note that when running VRF-lite the number of entries configured will apply to each VRF instance.

Default The default cache size is 0 (no entries) and the default lifetime is 1800 seconds.

Mode Global Configuration

Examples To set the cache size to 10 entries and the lifetime to 500 seconds, use the commands:

```
awplus# configure terminal
awplus(config)# ip dns forwarding cache size 10 time 500
```

To set the cache size to the default, use the commands:

```
awplus# configure terminal
awplus(config)# no ip dns forwarding cache size
```

Related Commands

- [clear ip dns forwarding cache](#)
- [debug ip dns forwarding](#)
- [ip dns forwarding](#)
- [show ip dns forwarding](#)
- [show ip dns forwarding cache](#)

ip dns forwarding dead-time

Overview Use this command to set the time period in seconds when the device stops sending any DNS requests to an unresponsive server and all retries set using [ip dns forwarding retry](#) are used. This time period is the DNS forwarding dead-time. The device stops sending DNS requests at the DNS forwarding dead-time configured and when all of the retries are used.

Use the **no** variant of this command to restore the default DNS forwarding dead-time value of 3600 seconds.

Syntax `ip dns forwarding dead-time <60-43200>`
`no ip dns forwarding retry`

Default The default time to stop sending DNS requests to an unresponsive server is 3600 seconds.

Mode Global Configuration

Usage See the [ip dns forwarding retry](#) command used with this command.

Examples To set the DNS forwarding retry count to 50 and to set the DNS forwarding dead-time to 1800 seconds, use the commands:

```
awplus# configure terminal
awplus(config)# ip dns forwarding dead-time 1800
awplus(config)# ip dns forwarding retry 50
```

To reset the DNS retry count to the default of 2 and the DNS forwarding dead-time to the default of 3600, use the commands:

```
awplus# configure terminal
awplus(config)# no ip dns forwarding dead-time
awplus(config)# no ip dns forwarding retry
```

Related Commands

- [debug ip dns forwarding](#)
- [ip dns forwarding](#)
- [ip dns forwarding retry](#)
- [show ip dns forwarding](#)
- [show ip dns forwarding server](#)

ip dns forwarding domain-list

Overview Use this command to create a domain-list that can be used as a suffix-list for DNS lookups. This command puts the device into a new mode where subsequent commands can be entered. The new mode is "Domain List Configuration" mode.

Use the **no** variant of this command to delete the domain-list.

Syntax `ip dns forwarding domain-list <domain-list-name>`
`no ip dns forwarding domain-list <domain-list-name>`

Parameter	Description
<code><domain-list-name></code>	Name of the list.

Mode Global Configuration

Usage The domain list can be used by features that need to match against domains. A domain list by itself does nothing; it must be attached to another feature to have functionality (like a prefix-list). For example, the domain list can be used as a suffix list on an DNS name-server. The DNS server can be either statically configured, or learned over a PPP connection.

Note that this command is separate from the **ip domain-list** command, which is used by DNS client to append a domain on to the end of a partial hostname to form a fully-qualified domain.

Examples To create a domain list to include domains that are internal to the company such as "engineering.acme" or "intranet.acme", use the commands:

```
awplus# configure terminal
awplus(config)# ip dns forwarding domain-list corporatedomains
awplus(config-domain-list)# description internal network domain
awplus(config-domain-list)# domain engineering.acme
awplus(config-domain-list)# domain intranet.acme
```

To delete the domain list, use the commands:

```
awplus# configure terminal
awplus(config)# no ip dns forwarding domain-list
corporatedomains
```

Related Commands [description \(Domain List\)](#)
[domain \(Domain List\)](#)

ip dns forwarding retry

Overview Use this command to set the number of times DNS Relay will retry to forward DNS queries. The device stops sending DNS requests to an unresponsive server at the time set using the [ip dns forwarding dead-time](#) command and when all of the retries are used.

Use the **no** variant of this command to set the number of retries to the default of 2.

Syntax `ip dns forwarding retry <0-100>`
`no ip dns forwarding retry`

Default The default number of retries is 2 DNS requests to an unresponsive server.

Mode Global Configuration

Usage See the [ip dns forwarding dead-time](#) command used with this command.

Examples To set the DNS forwarding retry count to 50 and to set the DNS forwarding dead-time to 1800 seconds, use the commands:

```
awplus# configure terminal
awplus(config)# ip dns forwarding retry 50
awplus(config)# ip dns forwarding dead-time 1800
```

To reset the DNS retry count to the default of 2 and the DNS forwarding dead-time to the default of 3600 seconds, use the commands:

```
awplus# configure terminal
awplus(config)# no ip dns forwarding retry
awplus(config)# no ip dns forwarding dead-time
```

Related Commands

- [debug ip dns forwarding](#)
- [ip dns forwarding](#)
- [ip dns forwarding dead-time](#)
- [show ip dns forwarding](#)

ip dns forwarding source-interface

Overview Use this command to set the interface to use for forwarding and receiving DNS queries.

Use the **no** variant of this command to unset the interface used for forwarding and receiving DNS queries.

Syntax `ip dns forwarding source-interface <interface-name>`
`no ip dns forwarding source-interface`

Default The default is that no interface is set and the device selects the appropriate source IP address automatically.

Mode Global Configuration

Examples To set `vlan1` as the source interface for relayed DNS queries, use the commands:

```
awplus# configure terminal
awplus(config)# ip dns forwarding source-interface vlan1
```

To clear the source interface for relayed DNS queries, use the commands:

```
awplus# configure terminal
awplus(config)# no ip dns forwarding source-interface
```

Related Commands [debug ip dns forwarding](#)
[ip dns forwarding](#)
[show ip dns forwarding](#)

ip dns forwarding timeout

Overview Use this command to set the time period for the DNS Relay to wait for a DNS response.

Use the **no** variant of this command to set the time period to wait for a DNS response to the default of 3 seconds.

Syntax `ip dns forwarding timeout <0-3600>`
`no ip dns forwarding timeout`

Default The default timeout value is 3 seconds.

Mode Global Configuration

Examples To set the timeout value to 12 seconds, use the commands:

```
awplus# configure terminal
awplus(config)# ip dns forwarding timeout 12
```

To set the timeout value to the default of 3 seconds, use the commands:

```
awplus# configure terminal
awplus(config)# no ip dns forwarding timeout
```

Related Commands [debug ip dns forwarding](#)
[ip dns forwarding](#)
[show ip dns forwarding](#)

ip domain-list

Overview This command adds a domain to the DNS list. Domains are appended to incomplete host names in DNS requests. Each domain in this list is tried in turn in DNS lookups. This list is ordered so that the first entry you create is checked first.

The **no** variant of this command deletes a domain from the list.

Syntax `ip domain-list <domain-name>`
`no ip domain-list <domain-name>`

Parameter	Description
<code><domain-name></code>	Domain string, for example "company.com".

Mode Global Configuration

Usage If there are no domains in the DNS list, then your device uses the domain specified with the `ip domain-name` command. If any domain exists in the DNS list, then the device does not use the domain set using the **ip domain-name** command.

Example To add the domain `example.net` to the DNS list, use the following commands:

```
awplus# configure terminal
awplus(config)# ip domain-list example.net
```

Related Commands [ip domain-lookup](#)
[ip domain-name](#)
[show ip domain-list](#)

ip domain-lookup

Overview This command enables the DNS client on your device. This allows you to use domain names instead of IP addresses in commands. The DNS client resolves the domain name into an IP address by sending a DNS inquiry to a DNS server, specified with the [ip name-server](#) command.

The **no** variant of this command disables the DNS client. The client will not attempt to resolve domain names. You must use IP addresses to specify hosts in commands.

Syntax `ip domain-lookup`
`no ip domain-lookup`

Mode Global Configuration

Usage The client is enabled by default. However, it does not attempt DNS inquiries unless there is a DNS server configured.

If you are using DNS Relay (see the command [ip dns forwarding](#)), you must have IP domain lookup enabled.

Examples To enable the DNS client on your device, use the following commands:

```
awplus# configure terminal
awplus(config)# ip domain-lookup
```

To disable the DNS client on your device, use the following commands:

```
awplus# configure terminal
awplus(config)# no ip domain-lookup
```

Related Commands [ip domain-list](#)
[ip domain-name](#)
[ip name-server](#)
[show hosts](#)
[show ip name-server](#)

ip domain-name

Overview This command sets a default domain for the DNS. The DNS client appends this domain to incomplete host-names in DNS requests.

The **no** variant of this command removes the domain-name previously set by this command.

Syntax `ip domain-name <domain-name>`
`no ip domain-name <domain-name>`

Mode Global Configuration

Usage If there are no domains in the DNS list (created using the [ip domain-list](#) command) then your device uses the domain specified with this command. If any domain exists in the DNS list, then the device does not use the domain configured with this command.

When your device is using its DHCP client for an interface, it can receive Option 15 from the DHCP server. This option replaces the domain name set with this command.

Example To configure the domain name, enter the following commands:

```
awplus# configure terminal
awplus(config)# ip domain-name company.com
```

**Related
Commands** [ip domain-list](#)
[show ip domain-list](#)
[show ip domain-name](#)

ip name-server

Overview This command adds IPv4 or IPv6 DNS server addresses. The DNS client on your device sends DNS queries to IP addresses in this list when trying to resolve a host name. Host names cannot be resolved until you have added at least one server to this list. A maximum of three name servers can be added to this list.

If you are running VRF-lite, you can add IPv4 or IPv6 DNS server addresses for either the global VRF instance or for a specific VRF instance. Host names cannot be resolved from within a VRF instance until you have added at least one name-server to that VRF instance.

The **no** variant of this command removes the specified DNS name-server address.

Syntax `ip name-server <ip-addr> [suffix-list <domain-list>]`
`no ip name-server <ip-addr> [suffix-list]`

Syntax (VRF-lite) `ip name-server [vrf <name>] <ip-addr>`
`no ip name-server [vrf <name>] <ip-addr>`

Parameter	Description
<code><ip-addr></code>	The IP address of the DNS server that is being added to the name server list. The address is entered in the form A.B.C.D for an IPv4 address, or in the form X::X:X for an IPv6 address.
<code>vrf</code>	Apply this command to the specified VRF instance.
<code><name></code>	The name of the specific VRF instance
<code>suffix-list</code>	Specify domain suffixes that should be directed to this name server
<code><domain-list></code>	The name of the DNS domain-list

Mode Global Configuration

Usage To allow the device to operate as a DNS proxy, your device must have learned about a DNS name-server to forward requests to. Name-servers can be learned through the following means:

- Manual configuration, using the **ip name-server** command
- Learned from DHCP server with Option 6
- Learned over a PPP tunnel if the neighbor advertises the DNS server

This command is used to statically configure a DNS name-server for the device to use.

For more information about PPP and DNS, see the [PPP Feature Overview and Configuration Guide](#).

Examples To allow a device to send DNS queries to a DNS server with the IPv4 address 10.10.10.5, use the commands:

```
awplus# configure terminal
awplus(config)# ip name-server 10.10.10.5
```

To enable your device to send DNS queries to a DNS server with the IPv6 address 2001:0db8:010d::1, use the commands:

```
awplus# configure terminal
awplus(config)# ip name-server 2001:0db8:010d::1
```

For DNS relay, to direct DNS lookups for domains with suffixes of "engineering.acme" or "intranet.acme" to an internal corporate name-server, use the commands:

```
awplus# configure terminal
awplus(config)# ip dns forwarding domain-list corporatedomains
awplus(config-domain-list)# description Our internal network
domains; do not send DNS requests to internet
awplus(config-domain-list)# domain engineering.acme
awplus(config-domain-list)# domain intranet.acme
awplus(config-domain-list)# exit
awplus(config)# ip name-server 172.16.0.1 suffix-list
corporatedomains
```

Example (VRF-lite) To enable your switch to send DNS queries (on VRF instance RED) to a DNS server with the IPv4 address 10.10.10.5 use the commands:

```
awplus# configure terminal
awplus(config)# ip name-server vrf RED 10.10.10.5
```

Related Commands

- [ip domain-list](#)
- [ip domain-lookup](#)
- [ip domain-name](#)
- [show ip dns forwarding cache](#)
- [show ip name-server](#)

Command changes Version 5.4.6-2.1: VRF-lite support added.

ipv6 ddns-update-method

Overview Use this command to enable an IPv6 interface to update DDNS with the specified DDNS update method.

Use the **no** variant of this command to disable an IPv6 interface to update DDNS with the specified DDNS update method.

Syntax `ipv6 ddns-update-method <method-name>`
`no ipv6 ddns-update-method <method-name>`

Parameter	Description
<code><method-name></code>	A name given to a DDNS update method.

Default None

Mode Interface Configuration

Usage A DDNS update method cannot be attached to multiple interfaces, however multiple DDNS update methods can be assigned to the same interface.

Example To enable IPv6 DDNS updates for a DDNS update method named "dyndns" using interface eth1, use the following commands:

```
awplus# configure terminal
awplus(config)# interface eth1
awplus(config-if)# ipv6 ddns-update-method dyndns
```

To disable IPv6 DDNS updates for a DDNS update method named "dyndns" using interface eth1, use the following commands:

```
awplus# configure terminal
awplus(config)# interface eth1
awplus(config-if)# no ipv6 ddns-update-method dyndns
```

Related Commands [ddns-update-method](#)

Command changes Version 5.4.7-0.1: command added

password (DDNS)

Overview Use this command to add a password to the current DDNS update method.
Use the **no** variant of this command to remove a password from the current DDNS update method.

Syntax password <password>
no password

Parameter	Description
<password>	The password to be configured in conjunction with the user name and host name.

Default None

Mode DDNS Update Method Configuration

Example To configure the password "test" for the method "dyndns", use the following commands:

```
awplus# configure terminal
awplus(config)# ddns-update-method dyndns
awplus(config-ddns-update-mthod)# password test
```

To remove the password "test" from the method "dyndns", use the following commands:

```
awplus# configure terminal
awplus(config)# ddns-update-method dyndns
awplus(config-ddns-update-mthod)# no password
```

Related Commands [ddns-update-method](#)

Command changes Version 5.4.7-0.1: command added

ppp ipcp dns

Overview Use this command to configure the primary and secondary DNS (Domain Name System) IP addresses for IPCP (Internet Protocol Control Protocol) on a given PPP interface.

Use the **no** variant of this command to remove the primary and secondary DNS IP addresses for IPCP on a given PPP interface, and remove any optional parameters configured for DNS.

Syntax `ppp ipcp dns [<primary> [<secondary>]] [required|reject|request]`
`no ppp ipcp dns`

Parameter	Description
<code><primary></code>	Specify the primary DNS address for a given PPP interface to the peer.
<code><secondary></code>	Specify the secondary DNS address for a given PPP interface to the peer.
<code>required</code>	Request DNS addresses from the peer, and close the link if none is given.
<code>reject</code>	Reject negotiations with the peer (default).
<code>request</code>	Request DNS addresses from the peer.

Default By default no IPCP DNS server request is sent to the peer.

Mode Interface Configuration

Usage Use the optional parameters to configure PPP IPCP DNS options for accepting, rejecting or requesting DNS addresses from the peer. Use the optional primary and secondary or primary only DNS server address placeholders to specify DNS server addresses to the peer.

The no variant of this command also stops IPCP DNS request messages being sent to the peer.

Examples To configure the PPP interface `ppp0` to require a DNS IP address from the peer, and close the link if a DNS IP address is not given, enter the below commands:

```
awplus# configure terminal
awplus(config)# interface ppp0
awplus(config-if)# ppp ipcp dns required
```

To configure the PPP interface `ppp0` to require a DNS IP address from the peer, enter the below commands:

```
awplus# configure terminal
awplus(config)# interface ppp0
awplus(config-if)# ppp ipcp dns request
```

To configure the PPP interface `ppp0` to reject a DNS IP address from the peer, enter the below commands:

```
awplus# configure terminal
awplus(config)# interface ppp0
awplus(config-if)# ppp ipcp dns reject
```

To configure the PPP interface `ppp0` to supply primary and secondary DNS server addresses to the peer, enter the below commands:

```
awplus# configure terminal
awplus(config)# interface ppp0
awplus(config-if)# ppp ipcp dns 10.1.1.2 10.1.1.3
```

To configure the PPP interface `ppp0` to supply a primary but not a secondary DNS server address to the peer, enter the below commands:

```
awplus# configure terminal
awplus(config)# interface ppp0
awplus(config-if)# ppp ipcp dns 10.1.1.2
```

**Related
Commands**

[ip address negotiated](#)
[peer default ip address](#)
[peer neighbor-route](#)
[show running-config interface](#)

ppp ipcp dns suffix-list

Overview Use this command to configure a suffix-list to be associated with DNS name-servers learned over the PPP connection.

Use the **no** variant of this command to remove the suffix-list.

Syntax `ppp ipcp dns suffix-list <domain-list-name>`
`no ppp ipcp dns suffix-list`

Parameter	Description
<code><domain-list-name></code>	The name of the DNS domain-list

Mode Interface Configuration

Usage A PPP connection can be configured to learn DNS servers from the remote peer by using the command `ppp ipcp dns` command.

This command allows a user to associate a domain-list to be used to match against the suffixes of incoming DNS requests. For example, a customer branch office may have a router that is used to give remote-access to their head office, over which they learn the IP address of the head office's DNS server. A domain list can be created that contains a suffix used for services internal to that company, for example, "example.lc". This domain-list is associated as a suffix-list to the PPP connection. So when the PPP connection is completed with the head office, users at the branch office that browse to "intranet.example.lc" will have the DNS request forwarded to the DNS server learned over the PPP connection. Without having the suffix-list configured, the DNS request for "intranet.example.lc" would instead be sent to the primary DNS server, which is likely to be the branch office's ISP, and they will simply respond with a negative reply, because .example.lc is not a globally routable domain.

Examples At a branch office, to direct DNS lookups for domains with suffixes of "engineering.acme" or "intranet.acme" to an internal corporate name-server run at head-office that was learned over a PPP connection, use the commands:

```
awplus# configure terminal
awplus(config)# ip dns forwarding domain-list corporatedomains
host(config-domain-list)# description Our internal network
domains; do not send DNS requests to internet
host(config-domain-list)# domain engineering.acme
host(config-domain-list)# domain intranet.acme
awplus(config)# interface ppp0
awplus(config-if)# ppp ipcp dns required
awplus(config-if)# ppp ipcp dns suffix-list corporatedomains
```

**Related
Commands** [ip dns forwarding domain-list](#)
[ppp ipcp dns](#)

retry-interval (DDNS)

Overview Use this command to enable DDNS update retries. Retries are attempted after a DDNS update fails after the specified interval. If the DDNS update keeps failing, then no more than the specified maximum retries are attempted.

NOTE: *The retry interval is used for one DDNS update at one time, so if an update is not complete within the specified interval, an update will not begin until it has completed.*

Use the **no** variant of this command to disable DDNS update retries.

Syntax `retry-interval <1-3888000> maximum-retries <1-100>`
`no retry-interval`

Parameter	Description
<code><1-3888000></code>	The retry interval in seconds (from 1 second to 4.5 days), after which a failed DDNS update will be retried.
<code><1-100></code>	The maximum number of times a retry is allowed.

Default Disabled

Mode DDNS Update Method Configuration

Usage If an update is triggered by another source, such as an IP address change or a manual update, then the retry counter will start again from the beginning.

Example To enable DDNS update retry attempts every hour up to 5 times for the method "dyndns", use the commands:

```
awplus# configure terminal
awplus(config)# ddns-update-method dyndns
awplus(config-ddns-update-method)# retry-interval 3600
maximum-retries 5
```

To disable DDNS update retry attempts for the method "dyndns", use the commands:

```
awplus# configure terminal
awplus(config)# ddns-update-method dyndns
awplus(config-ddns-update-method)# no retry-interval
```

Related Commands [ddns-update-method](#)

Command changes Version 5.4.7-0.1: command added

show ddns-update-method status

Overview Use this command to show the status of the configured DDNS update methods.

Syntax show ddns-update-method status

Mode User Exec and Privileged Exec

Example To display the status of DDNS update methods currently configured on your device, use the command:

```
awplus# show ddns-update-method status
```

Output Figure 24-1: Example output from **show ddns-update-method status**

```
awplus#show ddns-update-method status

Dynamic DNS updates are disabled

-----
Update Method Name      test
Hostname                 test.dnsalias.org
IPv4 Interface          vlan1000
IPv4 Address            192.168.10.100
IPv4 Status             Update succeeded
IPv4 Update Result      good 192.168.10.100
IPv6 Interface          vlan1000
IPv6 Address            333::f195
IPv6 Status             Update succeeded
IPv6 Update Result      good 0333:0000:0000:0000:0000:0000:f195
Last update             2017-02-23T00:09:07Z
```

Related Commands [ddns-update-method](#)

Command changes Version 5.4.7-0.1: command added

show debugging ip dns forwarding

Overview Use this command to display the DNS Relay debugging status. DNS Relay debugging is set using the **debug ip dns forwarding** command.

For information on filtering and saving command output, see the [“Getting Started with AlliedWare Plus” Feature Overview and Configuration Guide](#).

Syntax `show debugging ip dns forwarding`

Mode User Exec and Privileged Exec

Example To display the DNS Relay debugging status, use the command:

```
awplus# show debugging ip dns forwarding
```

Output Figure 24-2: Example output from the **show debugging ip dns forwarding** command

```
awplus#show debugging ip dns forwarding

DNS Relay debugging status:
debugging is on
```

Related Commands [debug ip dns forwarding](#)

show hosts

Overview This command shows the default domain, domain list, and name servers configured on your device.

For information on filtering and saving command output, see the [“Getting Started with AlliedWare Plus” Feature Overview and Configuration Guide](#).

Syntax `show hosts`

Mode User Exec and Privileged Exec

Example To display the default domain, use the command:

```
awplus# show hosts
```

Output Figure 24-3: Example output from the **show hosts** command

```
awplus#show hosts

Default domain is mycompany.com
Domain list: company.com
Name/address lookup uses domain service
Name servers are 10.10.0.2 10.10.0.88
```

Related Commands

- [ip domain-list](#)
- [ip domain-lookup](#)
- [ip domain-name](#)
- [ip name-server](#)

show ip dns forwarding

Overview Use this command to display the DNS Relay status.

Syntax `show ip dns forwarding`

Mode User Exec and Privileged Exec

Examples To display the DNS Relay status, use the command:

```
awplus# show ip dns forwarding
```

Output Figure 24-4: Example output from the **show ip dns forwarding** command

```
awplus#show ip dns forwarding
Max-Retry      : 2
Timeout        : 3 second(s)
Dead-Time      : 3600 second(s)
Source-Interface: not specified
DNS Cache      : disabled
```

Related Commands [ip dns forwarding](#)

show ip dns forwarding cache

Overview Use this command to display the DNS Relay name resolver cache.

Syntax show ip dns forwarding cache

Syntax (VRF-lite) show ip dns [vrf <name>|global] forwarding cache

Parameter	Description
vrf	Apply this command to the specified VRF instance.
<name>	The name of the specific VRF instance
global	When VRF-lite is configured, apply this command to the global routing and forwarding table.

Mode User Exec and Privileged Exec

Example To display the DNS Relay name resolver cache, use the command:

```
awplus# show ip dns forwarding cache
```

Output Figure 24-5: Example output from the **show ip dns forwarding cache** command

```
awplus#show ip dns forwarding cache
```

Host	Address	Expires	Flags
www.example.com	172.16.1.1.	180	
mail.example.com	www.example.com	180	CNAME
www.example.com	172.16.1.1.	180	REVERSE
mail.example.com	172.16.1.5.	180	

Example (VRF-lite) To display the DNS Relay name resolver cache with output for VRF instance RED, use the command:

```
awplus# show ip dns vrf RED forwarding cache
```

Output Figure 24-6: Example output from the **show ip dns forwarding cache** command that includes output for VRF instance RED.

```
awplus#show ip dns vrf RED forwarding cache
```

Host	Address	Expires	Flags
www.example.com	172.16.1.1.	180	
mail.example.com	www.example.com	180	CNAME
www.example.com	172.16.1.1.	180	REVERSE
mail.example.com	172.16.1.5.	180	
[VRF: RED]			
www.example2.com	10.25.1.1.	180	
mail.example2.com	www.example2.com	180	CNAME
www.example2.com	10.25.1.1.	180	REVERSE
mail.example2.com	10.25.1.6.	180	

Related Commands [ip dns forwarding cache](#)
[ip name-server](#)

Command changes Version 5.4.6-2.1: VRF-lite support added.

show ip dns forwarding server

Overview Use this command to display the status of DNS forwarding name servers.

If you are running VRF, you can also use this command to display the status for DNS forwarding name servers operating on a specific VRF instance.

Syntax `show ip dns forwarding server`

Syntax (VRF-lite) `show ip dns [vrf <name>|global] forwarding server`

Parameter	Description
vrf	Apply this command to the specified VRF instance.
<name>	The name of the specific VRF instance
global	When VRF-lite is configured, apply this command to the global routing and forwarding table.
forwarding server	Display information about the DNS forwarding name servers for either the switch (when not using VRF-lite) or for a specific VRF instance (when using VRF-lite).

Mode User Exec and Privileged Exec

Examples To display the status of DNS Relay name servers, use the command:

```
awplus# show ip dns forwarding server
```

Output Figure 24-7: Example output from the **show ip dns forwarding server** command

```
awplus#show ip dns forwarding server

Servers          Forwards    Fails      Dead-Time
172.16.1.1       12          0          active
172.16.1.2       6           3          3900
```

Example (VRF-lite) To display the status of DNS Relay name-servers for VRF-lite instance red, use the command:

```
awplus# show ip dns vrf red forwarding server
```

Output Figure 24-8: Example output from the **show ip dns forwarding server** command

```
awplus#show ip dns forwarding server

[VRF: red]
Servers          Forwards    Fails      Dead-Time
172.16.1.1       12          0          active
172.16.1.2       6           3          3900
```

**Related
Commands** [ip dns forwarding](#)
[ip dns forwarding dead-time](#)

**Command
changes** Version 5.4.6-2.1: VRF-lite support added.

show ip domain-list

Overview This command shows the domains configured in the domain list. The DNS client uses the domains in this list to append incomplete hostnames when sending a DNS inquiry to a DNS server.

For information on filtering and saving command output, see the [“Getting Started with AlliedWare Plus” Feature Overview and Configuration Guide](#).

Syntax `show ip domain-list`

Mode User Exec and Privileged Exec

Example To display the list of domains in the domain list, use the command:

```
awplus# show ip domain-list
```

Output Figure 24-9: Example output from the **show ip domain-list** command

```
awplus#show ip domain-list
alliedtelesis.com
mycompany.com
```

Related Commands [ip domain-list](#)
[ip domain-lookup](#)

show ip domain-name

Overview This command shows the default domain configured on your device. When there are no entries in the DNS list, the DNS client appends this domain to incomplete hostnames when sending a DNS inquiry to a DNS server.

For information on filtering and saving command output, see the [“Getting Started with AlliedWare Plus” Feature Overview and Configuration Guide](#).

Syntax `show ip domain-name`

Mode User Exec and Privileged Exec

Example To display the default domain configured on your device, use the command:

```
awplus# show ip domain-name
```

Output Figure 24-10: Example output from the **show ip domain-name** command

```
awplus#show ip domain-name
alliedtelesis.com
```

Related Commands [ip domain-name](#)
[ip domain-lookup](#)

show ip name-server

Overview This command displays a list of IPv4 and IPv6 DNS server addresses that your device will send DNS requests to. This is a static list configured using the `ip name-server` command.

The command will also show any domain-list that has been associated as suffix-list with the DNS server, and the domains that will be preferentially directed to that DNS server.

When running VRF-lite, this command displays a list of IPv4 and IPv6 addresses of DNS servers that your device will send DNS requests to for either the global VRF instance or a selected VRF instance.

For information on filtering and saving command output, see the [“Getting Started with AlliedWare Plus” Feature Overview and Configuration Guide](#).

Syntax `show ip name-server`

Syntax (VRF-lite) `show ip name-server [vrf <name>|global]`

Parameter	Description
vrf	A VRF instance
<name>	The name of the specific VRF instance
global	The global VRF instance

Mode User Exec and Privileged Exec

Example To display the list of DNS servers that your device sends DNS requests to, use the command:

```
awplus# show ip name-server
```

Output Figure 24-11: Example output from the `show ip name-server` command

```
awplus# show ip name-server
10.10.0.123
10.10.0.124
2001:0db8:010d::1
```

Example To display the list of DNS servers that your device sends DNS requests to, use the command:

```
awplus# show ip name-server
```

Output Figure 24-12: Example output from the **show ip name-server** command

```
awplus#show ip name-server
Currently learned name-servers
10.36.200.165 dynamic (ppp0)
10.35.12.20 dynamic (ppp1), using suffix-list mysuffixlist:
    test.com
    intranet.interslice.com
10.37.84.97 static
130.37.84.97 static
```

Output (VRF-lite) Figure 24-13: Example output from the **show ip name-server** command for the VRF instance "red"

```
awplus# show ip name-server vrf red

[VRF: red]
10.10.0.123
10.10.0.124
2001:0db8:010d::1
```

Related Commands [ip domain-lookup](#)
[ip name-server](#)

Command changes Version 5.4.6-2.1: VRF-lite support added.

suppress-ipv4-updates (DDNS)

- Overview** Use this command to suppress IPv4 updates from being sent.
- Use the **no** variant of this command to stop suppressing IPv4 updates from being sent.
- Syntax** `suppress-ipv4-updates`
`no suppress-ipv4-updates`
- Default** Disabled
- Mode** DDNS Update Method Configuration
- Usage** This command is used in conjunction with the **use-ipv4-for-ipv6-updates** command. IPv4 DDNS updates are suppressed so that only IPv6 updates are sent.
- NOTE:** *The IPv4 DNS entry may be updated using the source IPv4 address used.*
- Example** To suppress IPv4 updates and send IPv6 updates instead for the method "dyndns", use the commands:
- ```
awplus# configure terminal
awplus(config)# ddns-update-method-dyndns
awplus(config-ddns-update-method)# use-ipv4-for-ipv6-updates
awplus(config-ddns-update-method)# suppress-ipv4-updates
```
- Related Commands** [ddns-update-method](#)  
[use-ipv4-for-ipv6-updates \(DDNS\)](#)
- Command changes** Version 5.4.7-0.1: command added



# undebug (DDNS)

**Overview** Use this command to disable debugging for the DDNS process.

**Syntax** undebug ddns

**Default** Disabled

**Mode** Privileged Exec

**Example** To disable debugging for the DDNS process, use the command:

```
awplus# undebug ddns
```

**Related  
Commands** [ddns-update-method](#)  
[debug ddns](#)

**Command  
changes** Version 5.4.7-0.1: command added

# update-interval (DDNS)

**Overview** Use this command to specify the time interval between periodic DDNS updates. Use the **no** variant of this command to disable periodic DDNS updates.

**Syntax** `update-interval <1-64800>`  
`no update-interval`

| Parameter                    | Description                                                 |
|------------------------------|-------------------------------------------------------------|
| <code>&lt;1-64800&gt;</code> | Update interval time in minutes (from 1 minute to 45 days). |

**Default** Disabled

**Mode** DDNS Update Method Configuration

**Examples** To enable periodic DDNS updates every day for the method "dyndns", use the commands:

```
awplus# configure terminal
awplus(config)# ddns-update-method dyndns
awplus(config-ddns-update-method)# update-interval 1440
```

To enable periodic DDNS updates every 28 days for the method "dyndns", use the commands:

```
awplus# configure terminal
awplus(config)# ddns-update-method dyndns
awplus(config-ddns-update-method)# update-interval 40320
```

To disable periodic DDNS updates for the method "dyndns", use the commands:

```
awplus# configure terminal
awplus(config)# ddns-update-method dyndns
awplus(config-ddns-update-method)# no update-interval
```

**Related Commands** [ddns-update-method](#)

**Command changes** Version 5.4.7-0.1: command added

# update-url (DDNS)

**Overview** Use this command to configure a URL for DDNS updates for the current DDNS update method.

Use the **no** variant of this command to remove an update URL from a DDNS update method.

**Syntax** `update-url <url-name>`  
`no update-url <url-name>`

| Parameter                     | Description                                                                                                                                                                                                                                                                                                                                                                                                                                                                                                                                                                                                                                    |
|-------------------------------|------------------------------------------------------------------------------------------------------------------------------------------------------------------------------------------------------------------------------------------------------------------------------------------------------------------------------------------------------------------------------------------------------------------------------------------------------------------------------------------------------------------------------------------------------------------------------------------------------------------------------------------------|
| <code>&lt;url-name&gt;</code> | <p>The update URL is provided by the DDNS provider and can be configured with the following placeholder tokens:</p> <ul style="list-style-type: none"><li>• <code>&lt;USERNAME&gt;</code></li><li>• <code>&lt;PASSWORD&gt;</code></li><li>• <code>&lt;HOST-NAME&gt;</code></li><li>• <code>&lt;IPADDRESS&gt;</code></li></ul> <p>To specify the values for <code>&lt;USERNAME&gt;</code>, <code>&lt;PASSWORD&gt;</code> and <code>&lt;HOST-NAME&gt;</code>, use the commands <b>username</b>, <b>password</b> and <b>hostname</b>. The value for <code>&lt;IPADDRESS&gt;</code> is populated automatically from the interface IP settings.</p> |

**Default** None

**Mode** DDNS Update Method Configuration

**Usage** The update URL (provided by the DDNS provider) can include a user name, password, host name and/or IP address. These user values are optional because they may vary depending on the DDNS provider's update URLs. AlliedWare Plus requires you to enter the required parameters for the update URL using the following placeholder tokens:

- for the user name enter "`<USERNAME>`"
- for the password enter "`<PASSWORD>`"
- for the host name enter "`<HOST-NAME>`"
- for the IP address enter "`<IPADDRESS>`"

For example, for DynDNS the following update URL can be used:

```
http://username:password@members.dyndns.org/nic/update?
SYSTEM=dyndns&hostname=<h>&myip=<a>
```

To configure this URL, use the following command including the placeholder tokens as written here:

```
awplus(config-ddns-update-method)# update-url
http://<USERNAME>:<PASSWORD>@members.dyndns.org/nic/update?
SYSTEM=dyndns&hostname=<HOST-NAME>&myip=<IPADDRESS>
```

DynDNS also has the following update URL that can be used instead:

```
http://<USERNAME>:<PASSWORD>@members.dyndns.org/v3/update?
hostname=<HOST-NAME>&myip=<IPADDRESS>
```

**NOTE:** URLs that contain the character "?" activate help from the command line. To stop the help from activating enter the "?" in the command line, then press Ctrl+v.

For more information and examples, see the [Domain Name System \(DNS\) for AlliedWare Plus AR-Series Firewalls Feature Overview and Configuration Guide](#).

**Examples** To use members.dyndns.org/nic/update as the update URL for the provider DynDNS, with the method called "dyndns" that uses HTTP, use the following commands:

```
awplus# configure terminal
awplus(config)# ddns-update-method dyndns
awplus(config-ddns-update-method)# update-url
http://<USERNAME>:<PASSWORD>@members.dyndns.org/nic/update?
SYSTEM=dyndns&hostname=<HOST-NAME>&myip=<IPADDRESS>
```

To use members.dyndns.org/v3/update as the update URL for the provider DynDNS, with the method called "dyndns" that uses HTTP, use the following commands:

```
awplus# configure terminal
awplus(config)# ddns-update-method dyndns
awplus(config-ddns-update-method)# update-url
http://<USERNAME>:<PASSWORD>@members.dyndns.org/v3/update?
hostname=<HOST-NAME>&myip=<IPADDRESS>
```

To use members.dyndns.org/v3/update as the update URL for the provider DynDNS, with the method called "dyndns" that uses HTTPS/SSL, use the following commands:

```
awplus# configure terminal
awplus(config)# ddns-update-method dyndns
awplus(config-ddns-update-method)# update-url
https://<USERNAME>:<PASSWORD>@members.dyndns.org/v3/update?
hostname=<HOST-NAME>&myip=<IPADDRESS>
```

To use members.dyndns.org/v3/update as the update URL for the provider DynDNS, with the method called "dyndns" that uses HTTP on port 8245, use the following commands:

```
awplus# configure terminal
awplus(config)# ddns-update-method dyndns
awplus(config-ddns-update-method)# update-url
http://<USERNAME>:<PASSWORD>@members.dyndns.org:8245/v3/
update?hostname=<HOST-NAME>&myip=<IPADDRESS>
```

To remove the update URL from the method called “dyndns”, use the following commands:

```
awplus# configure terminal
awplus(config)# ddns-update-method dyndns
awplus(config-ddns-update-method)# no update-url
```

**Related Commands** [ddns-update-method](#)

**Command changes** Version 5.4.7-0.1: command added

# use-ipv4-for-ipv6-updates (DDNS)

**Overview** Use this command to send IPv6 updates using IPv4.  
Use the **no** variant of this command to stop sending IPv6 updates using IPv4.

**Syntax** `use-ipv4-for-ipv6-updates`  
`no use-ipv4-for-ipv6-updates`

**Default** Disabled

**Mode** DDNS Update Method Configuration

**Usage** If your DDNS provider supports IPv6 but does not support sending updates in IPv6 then this command is used so IPv6 updates can be sent using IPv4 instead. The **suppress-ipv4-updates** command is used in conjunction with this command to suppress IPv4 updates and send only IPv6 updates instead.

**example** To send IPv6 updates using IPv4 for the method "dyndns" and to suppress IPv4 updates, use the commands:

```
awplus# configure terminal
awplus(config)# ddns-update-method dyndns
awplus(config-ddns-update-method)# use-ipv4-for-ipv6-updates
awplus(config-ddns-update-method)# suppress-ipv4-updates
```

**Related Commands** [ddns-update-method](#)  
[suppress-ipv4-updates \(DDNS\)](#)

**Command changes** Version 5.4.7-0.1: command added

# username (DDNS)

**Overview** Use this command to add a user name to the current DDNS update method.  
Use the **no** variant of this command to remove a user name from the current DDNS update method.

**Syntax** `username <user-name>`  
`no username`

| Parameter                      | Description                                                                           |
|--------------------------------|---------------------------------------------------------------------------------------|
| <code>&lt;user-name&gt;</code> | The name of the user to be configured in conjunction with the password and host name. |

**Default** None

**Mode** DDNS Update Method Configuration

**Example** To configure the username "atlnz" for the method "dyndns", use the following commands:

```
awplus# configure terminal
awplus(config)# ddns-update-method dyndns
awplus(config-ddns-update-mthod)# username atlnz
```

To remove the username "atlnz" from the method "dyndns", use the following commands:

```
awplus# configure terminal
awplus(config)# ddns-update-method dyndns
awplus(config-ddns-update-mthod)# no username
```

**Related Commands** [ddns-update-method](#)

**Command changes** Version 5.4.7-0.1: command added

# 25

# IPv6 Commands

## Introduction

**Overview** This chapter provides an alphabetical reference of commands used to configure IPv6. For more information, see the [IPv6 Feature Overview and Configuration Guide](#).

- Command List**
- “clear ipv6 neighbors” on page 786
  - “ipv6 address” on page 787
  - “ipv6 address autoconfig” on page 789
  - “ipv6 enable” on page 791
  - “ipv6 eui64-linklocal” on page 793
  - “ipv6 forwarding” on page 794
  - “ipv6 multicast forward-slow-path-packet” on page 795
  - “ipv6 nd accept-ra-pinfo” on page 796
  - “ipv6 nd current-hoplimit” on page 797
  - “ipv6 nd managed-config-flag” on page 799
  - “ipv6 nd minimum-ra-interval” on page 800
  - “ipv6 nd other-config-flag” on page 802
  - “ipv6 nd prefix” on page 803
  - “ipv6 nd ra-interval” on page 805
  - “ipv6 nd ra-lifetime” on page 806
  - “ipv6 nd reachable-time” on page 807
  - “ipv6 nd retransmission-time” on page 809
  - “ipv6 nd suppress-ra” on page 811
  - “ipv6 neighbor” on page 812



- [“ipv6 opportunistic-nd”](#) on page 813
- [“ipv6 route”](#) on page 814
- [“ipv6 unreachable”](#) on page 815
- [“ping ipv6”](#) on page 816
- [“show ipv6 forwarding”](#) on page 817
- [“show ipv6 interface brief”](#) on page 818
- [“show ipv6 neighbors”](#) on page 819
- [“show ipv6 route”](#) on page 820
- [“show ipv6 route summary”](#) on page 822
- [“traceroute ipv6”](#) on page 823

# clear ipv6 neighbors

**Overview** Use this command to clear all dynamic IPv6 neighbor entries.

**Syntax** `clear ipv6 neighbors`

**Mode** Privileged Exec

**Example** `awplus# clear ipv6 neighbors`

# ipv6 address

**Overview** Use this command to set the IPv6 address of an interface. The command also enables IPv6 on the interface, which creates an EUI-64 link-local address as well as enabling RA processing and SLAAC.

To stop the device from processing prefix information (routes and addresses from the received Router Advertisements) use the command **no ipv6 nd accept-ra-pinfo**.

To remove the EUI-64 link-local address, use the command **no ipv6 eui64-linklocal**.

Use the **no** variant of this command to remove the IPv6 address assigned and disable IPv6. Note that if no global addresses are left after removing the IPv6 address then IPv6 is disabled.

**Syntax** `ipv6 address <ipv6-addr/prefix-length>`  
`no ipv6 address <ipv6-addr/prefix-length>`

| Parameter                                    | Description                                                                                                                                     |
|----------------------------------------------|-------------------------------------------------------------------------------------------------------------------------------------------------|
| <code>&lt;ipv6-addr/prefix-length&gt;</code> | Specifies the IPv6 address to be set. The IPv6 address uses the format X:X::X/Prefix-Length. The prefix-length is usually set between 0 and 64. |

**Mode** Interface Configuration for a VLAN interface or a PPP interface.

**Usage** Note that link-local addresses are retained in the system until they are negated by using the **no** variant of the command that established them. See the [ipv6 enable](#) command for more information.

Also note that the link-local address is retained in the system if the global address is removed using another command, which was not used to establish the link-local address. For example, if a link local address is established with the [ipv6 enable](#) command then it will not be removed using a **no ipv6 address** command.

**Examples** To assign the IPv6 address 2001:0db8::a2/64 to the VLAN interface vlan2, use the following commands:

```
awplus# configure terminal
awplus(config)# interface vlan2
awplus(config-if)# ipv6 address 2001:0db8::a2/64
```

To remove the IPv6 address 2001:0db8::a2/64 from the VLAN interface vlan2, use the following commands:

```
awplus# configure terminal
awplus(config)# interface vlan2
awplus(config-if)# no ipv6 address 2001:0db8::a2/64
```

To assign the IPv6 address to the PPP interface ppp0, use the following commands:

```
awplus# configure terminal
awplus(config)# interface ppp0
awplus(config-fr-subif)# ipv6 address 2001:0db8::a2/64
```

To remove the IPv6 address 2001:0db8::a2/64 from the PPP interface ppp0, use the following commands:

```
awplus# configure terminal
awplus(config)# interface ppp0
awplus(config-if)# no ipv6 address 2001:0db8::a2/64
```

**Related  
Commands**

- [ipv6 address autoconfig](#)
- [ipv6 address dhcp](#)
- [ipv6 dhcp server](#)
- [ipv6 enable](#)
- [ipv6 eui64-linklocal](#)
- [show running-config](#)
- [show ipv6 interface brief](#)
- [show ipv6 route](#)

# ipv6 address autoconfig

**Overview** Use this command to enable IPv6 stateless address autoconfiguration (SLAAC) for an interface. This configures an IPv6 address on an interface derived from the MAC address on the interface.

Use the **no** variant of this command to disable IPv6 SLAAC on an interface. Note that if no global addresses are left after removing all IPv6 autoconfigured addresses then IPv6 is disabled.

**Syntax** `ipv6 address autoconfig`  
`no ipv6 address autoconfig`

**Mode** Interface Configuration for a VLAN interface or a PPP interface.

**Usage** This command enables automatic configuration of IPv6 addresses using stateless autoconfiguration on an interface and enables IPv6, but does not enable IPv6 forwarding. See the [ipv6 forwarding](#) command for further description and examples.

IPv6 hosts can configure themselves when connected to an IPv6 network using ICMPv6 (Internet Control Message Protocol version 6) router discovery messages. Configured routers respond with a Router Advertisement (RA) containing configuration parameters for IPv6 hosts.

The SLAAC process derives the interface identifier of the IPv6 address from the MAC address of the interface. When applying SLAAC to an interface, note that the MAC address of the default VLAN is applied to the interface if the interface does not have its own MAC address.

If SLAAC is not suitable then a network can use stateful configuration with DHCPv6 (Dynamic Host Configuration Protocol version 6) Relay, or hosts can be configured statically. See [ip dhcp-relay server-address](#) for the DHCPv6 Relay server command description and examples. See the [IP Feature Overview and Configuration Guide](#) for more information about DNS Relay.

Note that link-local addresses are retained in the system until they are negated by using the no variant of the command that established them. See the [ipv6 enable](#) command for more information.

Also note that the link-local address is retained in the system if the global address is removed using another command that was not used to establish the link-local address. For example, if a link local address is established with the [ipv6 enable](#) command then it will not be removed using a **no ipv6 address** command.

**Examples** To enable SLAAC on the PPP interface `ppp0`, use the following commands:

```
awplus# configure terminal
awplus(config)# interface ppp0
awplus(config-if)# ipv6 address autoconfig
```

To disable SLAAC on the PPP interface `ppp0`, use the following commands:

```
awplus# configure terminal
awplus(config)# interface vlan2
awplus(config-if)# no ipv6 address autoconfig
```

**Related  
Commands**

- [ipv6 address](#)
- [ipv6 enable](#)
- [show ipv6 interface brief](#)
- [show ipv6 route](#)
- [show running-config](#)

# ipv6 enable

**Overview** Use this command to enable automatic configuration of a link-local IPv6 address on an interface using Stateless Automatic Address Configuration (SLAAC). By default, the EUI-64 method is used to generate the link-local address.

Use the **no** variant of this command to disable IPv6 on an interface without a global address. Note, to stop EUI-64 from generating the automatic link-local address, use the command **no ipv6 eui64-linklocal**.

**Syntax** `ipv6 enable`  
`no ipv6 enable`

**Mode** Interface Configuration for a VLAN interface or a PPP interface.

**Usage** The **ipv6 enable** command automatically configures an IPv6 link-local address on the interface and enables the interface for IPv6 processing.

A link-local address is an IP (Internet Protocol) address that is only used for communications in the local network, or for a point-to-point connection. Routing does not forward packets with link-local addresses. IPv6 requires that a link-local address is assigned to each interface that has the IPv6 protocol enabled, and when addresses are assigned to interfaces for routing IPv6 packets.

Note that link-local addresses are retained in the system until they are negated by using the no variant of the command that established them.

Also note that the link-local address is retained in the system if the global address is removed using another command that was not used to establish the link-local address. For example, if a link local address is established with the **ipv6 enable** command then it will not be removed using a **no ipv6 address** command.

**Default** All interfaces default to IPv6-down with no address.

**Examples** To enable IPv6 with only a link-local IPv6 address on the VLAN interface `vlan2`, use the following commands:

```
awplus# configure terminal
awplus(config)# interface vlan2
awplus(config-if)# ipv6 enable
```

To disable IPv6 with only a link-local IPv6 address on the VLAN interface `vlan2`, use the following commands:

```
awplus# configure terminal
awplus(config)# interface vlan2
awplus(config-if)# no ipv6 enable
```

To enable IPv6 with only a link-local IPv6 address on the PPP interface `ppp0`, use the following commands:

```
awplus# configure terminal
awplus(config)# interface ppp0
awplus(config-if)# ipv6 enable
```

To disable IPv6 with only a link-local IPv6 address on the PPP interface `ppp0`, use the following commands:

```
awplus# configure terminal
awplus(config)# interface ppp0
awplus(config-if)# no ipv6 enable
```

**Related  
Commands**

- [ipv6 address](#)
- [ipv6 address autoconfig](#)
- [ipv6 address dhcp](#)
- [ipv6 address \(DHCPv6 PD\)](#)
- [ipv6 dhcp client pd](#)
- [ipv6 nd prefix](#)
- [show ipv6 interface brief](#)
- [show ipv6 route](#)
- [show running-config](#)



# ipv6 eui64-linklocal

**Overview** When IPv6 is enabled on an interface, an EUI link-local address is generated and installed on the interface. In other words, **ipv6 eui64-linklocal** is enabled by default on any IPv6 enabled interface.

Use the **no** variant of this command to disallow the automatic generation of the EUI-64 link-local address on an IPv6 enabled interface.

**Syntax** `ipv6 eui64-linklocal`  
`no ipv6 eui64-linklocal`

**Default** The command **ipv6 eui64-linklocal** is enabled by default on any IPv6 enabled interface.

**Mode** Interface

**Example** To enable IPv6 on an interface eth1, and use the link-local address of fe80::1/10 instead of the EUI-64 link-local that is automatically generated, use the following commands:

```
awplus# configure terminal
awplus(config)# interface eth1
awplus(config-if)# ipv6 enable
awplus(config-if)# no ipv6 eui64-linklocal
awplus(config-if)# ipv6 address fe80::1/10
```

**Related Commands** [ipv6 address](#)  
[ipv6 address autoconfig](#)  
[ipv6 enable](#)

**Command changes** Version 5.4.7-0.1: command added

# ipv6 forwarding

**Overview** Use this command to turn on IPv6 unicast routing for IPv6 packet forwarding. Execute this command globally on your device prior to issuing [ipv6 enable](#) on individual interfaces.

Use this **no** variant of this command to turn off IPv6 unicast routing. Note IPv6 unicast routing is disabled by default.

**Syntax** `ipv6 forwarding`  
`no ipv6 forwarding`

**Mode** Global Configuration

**Default** IPv6 unicast forwarding is disabled by default.

**Usage** Enable IPv6 unicast forwarding globally for all interface on your device with this command. Use the **no** variant of this command to disable IPv6 unicast forwarding globally for all interfaces on your device.

IPv6 unicast forwarding allows devices to communicate with devices that are more than one hop away, providing that there is a route to the destination address. If IPv6 forwarding is not enabled then pings to addresses on devices that are more than one hop away will fail, even if there is a route to the destination address.

**Examples** To enable IPv6 unicast routing, use this command as shown below:

```
awplus# configure terminal
awplus(config)# ipv6 forwarding
```

To disable IPv6 unicast routing, use the no variant of this command as shown below:

```
awplus# configure terminal
awplus(config)# no ipv6 forwarding
```

**Related Commands** [ipv6 enable](#)  
[ipv6 multicast-routing](#)

# ipv6 multicast forward-slow-path-packet

**Overview** Use this command to enable multicast packets to be forwarded to the CPU. Enabling this command will ensure that the layer L3 MTU is set correctly for each IP multicast group and will apply the value of the smallest MTU among the outgoing interfaces for the multicast group.

It will also ensure that a received packet that is larger than the MTU value will result in the generation of an ICMP Too Big message.

Use the **no** variant of this command to disable the above functionality.

**Syntax** `ipv6 multicast forward-slow-path-packet`  
`no ipv6 multicast forward-slow-path-packet`

**Default** Disabled.

**Mode** Privileged Exec

**Example** To enable the ipv6 multicast forward-slow-path-packet function, use the following commands:

```
awplus# configure terminal
awplus(config)# ip multicast forward-slow-path-packet
```

**Related Commands** [show ipv6 forwarding](#)

# ipv6 nd accept-ra-pinfo

**Overview** Use this command to allow the processing of the prefix information included in a received RA (Router Advertisement) on an IPv6 enabled interface.

Use the **no** variant of this command to disable an IPv6 interface from using the prefix information within a received RA.

**Syntax** `ipv6 nd accept-ra-pinfo`  
`no ipv6 nd accept-ra-pinfo`

**Default** The command **ipv6 nd accept-ra-pinfo** is enabled by default on any IPv6 interface.

**Mode** Interface

**Usage** By default, when IPv6 is enabled on an interface, SLAAC is also enabled. SLAAC addressing along with the EUI-64 process, uses the prefix information included in a received RA to generate an automatic link-local address on the IPv6 interface.

Note, an AlliedWare Plus device will, by default, add a prefix for the connected interface IPv6 address(es) to the RA it transmits. However, this behavior can be changed by using the command **no ipv6 nd prefix auto-advertise**, so there is no guarantee that an RA will contain a prefix.

**Example** To enable IPv6 on eth1 without installing a SLAAC address on the interface, use the following commands:

```
awplus# configure terminal
awplus(config)# interface eth1
awplus(config-if)# ipv6 enable
awplus(config-if)# no ipv6 nd accept-ra-pinfo
```

**Related Commands** [ipv6 address](#)  
[ipv6 address autoconfig](#)  
[ipv6 enable](#)

**Command changes** Version 5.4.7-0.1: command added

# ipv6 nd current-hoplimit

**Overview** Use this command to specify the advertised current hop limit used between IPv6 Routers.

Use the **no** variant of this command to reset the current advertised hop limit to its default "0".

**Syntax** `ipv6 nd current-hoplimit <hoplimit>`  
`no ipv6 nd current-hoplimit`

| Parameter                     | Description                                                                            |
|-------------------------------|----------------------------------------------------------------------------------------|
| <code>&lt;hoplimit&gt;</code> | Specifies the advertised current hop limit value. Valid values are from 0 to 255 hops. |

**Default** 0 (No advertised current hop limit specified)

**Mode** Interface Configuration for a VLAN interface or a PPP interface.

**Examples** To set the advertised current hop limit to "2" between IPv6 Routers on the VLAN interface "vlan2", use the following commands:

```
awplus# configure terminal
awplus(config)# interface vlan2
awplus(config-if)# ipv6 nd current-hoplimit 2
```

To reset the advertised current hop limit to the default "0" on the VLAN interface "vlan2", use the following commands:

```
awplus# configure terminal
awplus(config)# interface vlan2
awplus(config-if)# no ipv6 nd current-hoplimit
```

To set the advertised current hop limit to "2" between IPv6 Routers on the PPP interface "ppp0", use the following commands:

```
awplus# configure terminal
awplus(config)# interface ppp0
awplus(config-if)# ipv6 nd current-hoplimit 2
```

To reset the advertised current hop limit to the default "0" on the PPP interface "ppp0", use the following commands:

```
awplus# configure terminal
awplus(config)# interface ppp0
awplus(config-if)# no ipv6 nd current-hoplimit
```

**Related  
Commands** [ipv6 nd managed-config-flag](#)  
[ipv6 nd prefix](#)  
[ipv6 nd suppress-ra](#)

# ipv6 nd managed-config-flag

**Overview** Use this command to set the managed address configuration flag, contained within the router advertisement field.

Setting this flag indicates the operation of a stateful autoconfiguration protocol such as DHCPv6 for address autoconfiguration, and that address information (i.e. the network prefix) and other (non-address) information can be requested from the device.

An unset flag enables hosts receiving the advertisements to use a stateless autoconfiguration mechanism to establish their IPv6 addresses. The default is flag unset.

Use the **no** variant of this command to reset this command to its default of, flag unset.

**Syntax** `ipv6 nd managed-config-flag`  
`no ipv6 nd managed-config-flag`

**Default** Unset

**Mode** Interface Configuration for a VLAN interface or a PPP interface.

**Usage** Advertisement flags will not be transmitted unless you have applied the [ipv6 nd suppress-ra](#) command. This step is included in the example below.

**Example** To set the managed address configuration flag on the VLAN interface `vlan2`, use the following commands:

```
awplus# configure terminal
awplus(config)# interface vlan2
awplus(config-if)# ipv6 nd managed-config-flag
awplus(config-if)# no ipv6 nd suppress-ra
```

To set the managed address configuration flag on the PPP interface `ppp0`, use the following commands:

```
awplus# configure terminal
awplus(config)# interface ppp0
awplus(config-if)# ipv6 nd managed-config-flag
awplus(config-if)# no ipv6 nd suppress-ra
```

**Related Commands** [ipv6 nd suppress-ra](#)  
[ipv6 nd prefix](#)  
[ipv6 nd other-config-flag](#)

# ipv6 nd minimum-ra-interval

**Overview** Use this command in Interface Configuration mode to set a minimum Router Advertisement (RA) interval for a VLAN interface.

Use the **no** variant of this command in Interface Configuration mode to remove the minimum RA interval for a VLAN interface.

**Syntax** `ipv6 nd minimum-ra-interval <seconds>`  
`no ipv6 nd minimum-ra-interval`

| Parameter                    | Description                                                                                                        |
|------------------------------|--------------------------------------------------------------------------------------------------------------------|
| <code>&lt;seconds&gt;</code> | Specifies the number of seconds between IPv6 Router Advertisements (RAs). Valid values are from 3 to 1350 seconds. |

**Default** The RA interval for a VLAN interface is unset by default.

**Mode** Interface Configuration for a VLAN interface or a PPP interface.

**Examples** To set the minimum RA interval for the VLAN interface `vlan2`, use the following commands:

```
awplus# configure terminal
awplus(config)# interface vlan2
awplus(config-if)# ipv6 nd minimum-ra-interval 60
```

To remove the minimum RA interval for the VLAN interface `vlan2`, use the following commands:

```
awplus# configure terminal
awplus(config)# interface vlan2
awplus(config-if)# no ipv6 nd minimum-ra-interval
```

To set the minimum RA interval for the PPP interface `ppp0`, use the following commands:

```
awplus# configure terminal
awplus(config)# interface ppp0
awplus(config-if)# ipv6 nd minimum-ra-interval 60
```

To remove the minimum RA interval for the PPP interface `ppp0`, use the following commands:

```
awplus# configure terminal
awplus(config)# interface ppp0
awplus(config-if)# no ipv6 nd minimum-ra-interval
```



**Related  
Commands**

- ipv6 nd ra-interval
- ipv6 nd suppress-ra
- ipv6 nd prefix
- ipv6 nd other-config-flag

# ipv6 nd other-config-flag

**Overview** Use this command to set the **other** stateful configuration flag (contained within the router advertisement field) to be used for IPv6 address auto-configuration. This flag is used to request the router to provide information in addition to providing addresses.

**NOTE:**

*Setting the `ipv6 nd managed-config-flag` command implies that the `ipv6 nd other-config-flag` will also be set.*

Use **no** variant of this command to reset the value to the default.

**Syntax** `ipv6 nd other-config-flag`  
`no ipv6 nd other-config-flag`

**Default** Unset

**Mode** Interface Configuration for a VLAN interface or a PPP interface.

**Usage** Advertisement flags will not be transmitted unless you have applied the `ipv6 nd suppress-ra` command. This step is included in the example below.

**Example** To set the IPv6 other-config-flag on the VLAN interface `vlan4`, use the following commands:

```
awplus# configure terminal
awplus(config)# interface vlan4
awplus(config-if)# ipv6 nd other-config-flag
awplus(config-if)# no ipv6 nd suppress-ra
```

To set the IPv6 other-config-flag on the PPP interface `ppp0`, use the following commands:

```
awplus# configure terminal
awplus(config)# interface ppp0
awplus(config-if)# ipv6 nd other-config-flag
awplus(config-if)# no ipv6 nd suppress-ra
```

**Related Commands** `ipv6 nd suppress-ra`  
`ipv6 nd prefix`  
`ipv6 nd managed-config-flag`

# ipv6 nd prefix

**Overview** Use this command in Interface Configuration mode for a VLAN interface to specify the IPv6 prefix information that is advertised by the router advertisement for IPv6 address auto-configuration.

Use the **no** parameter with this command to reset the IPv6 prefix for a VLAN interface in Interface Configuration mode.

**Syntax**

```

ipv6 nd prefix <ipv6-prefix/length>
ipv6 nd prefix <ipv6-prefix/length> [<valid-lifetime>]
ipv6 nd prefix <ipv6-prefix/length>
<valid-lifetime><preferred-lifetime> [no-autoconfig]
ipv6 nd prefix <ipv6-prefix/length>
<valid-lifetime><preferred-lifetime> off-link [no-autoconfig]
no ipv6 nd prefix [<ipv6-addr/prefix-length>|all]

```

| Parameter            | Description                                                                                                                                                                                                                                                                                                                                                                                                                               |
|----------------------|-------------------------------------------------------------------------------------------------------------------------------------------------------------------------------------------------------------------------------------------------------------------------------------------------------------------------------------------------------------------------------------------------------------------------------------------|
| <ipv6-prefix/length> | The prefix to be advertised by the router advertisement message.<br>The IPv6 address prefix uses the format X:X::/prefix-length. The prefix-length is usually set between 0 and 64. The default is X:X::/64.                                                                                                                                                                                                                              |
| <valid-lifetime>     | The the period during which the specified IPv6 address prefix is valid. This can be set to a value between 0 and 4294967295 seconds. The default is 2592000 (30 days). Note that this period should be set to a value greater than that set for the prefix preferred-lifetime.                                                                                                                                                            |
| <preferred-lifetime> | Specifies the IPv6 prefix preferred lifetime. This is the period during which the IPv6 address prefix is considered a current (undeprecated) value. After this period, the command is still valid but should not be used in new communications. Set to a value between 0 and 4294967295 seconds. The default is 604800 seconds (7 days). Note that this period should be set to a value less than that set for the prefix valid-lifetime. |
| off-link             | Specify the IPv6 prefix off-link flag. The default is flag set.                                                                                                                                                                                                                                                                                                                                                                           |
| no-autoconfig        | Specify the IPv6 prefix no autoconfiguration flag. Setting this flag indicates that the prefix is not to be used for autoconfiguration. The default is flag set.                                                                                                                                                                                                                                                                          |
| all                  | Specify all IPv6 prefixes associated with the VLAN interface.                                                                                                                                                                                                                                                                                                                                                                             |

**Default** Valid-lifetime default is 2592000 seconds (30 days). Preferred-lifetime default is 604800 seconds (7 days).

**Mode** Interface Configuration for a VLAN interface or a PPP interface.

**Usage** This command specifies the IPv6 prefix flags that are advertised by the router advertisement message.

**Examples** The following example configures the device to issue router advertisements on the VLAN interface `vlan4`, and advertises the address prefix of `2001:0db8::/64`.

```
awplus# configure terminal
awplus(config)# interface vlan4
awplus(config-if)# ipv6 nd prefix 2001:0db8::/64
```

The following example configures the router to issue router advertisements on the PPP interface `ppp0`, and advertises the address prefix of `2001:0db8::/64`.

```
awplus# configure terminal
awplus(config)# interface ppp0
awplus(config-if)# ipv6 nd prefix 2001:0db8::/64
```

The following example configures the device to issue router advertisements on the VLAN interface `vlan4`, and advertises the address prefix of `2001:0db8::/64` with a valid lifetime of 10 days and a preferred lifetime of 5 days.

```
awplus# configure terminal
awplus(config)# interface vlan4
awplus(config-if)# ipv6 nd prefix 2001:0db8::/64 864000 432000
```

The following example configures the device to issue router advertisements on the VLAN interface `vlan4`, and advertises the address prefix of `2001:0db8::/64` with a valid lifetime of 10 days, a preferred lifetime of 5 days and no prefix used for autoconfiguration.

```
awplus# configure terminal
awplus(config)# interface vlan4
awplus(config-if)# ipv6 nd prefix 2001:0db8::/64 864000 432000
no-autoconfig
```

The following example resets router advertisements on the VLAN interface `vlan4`, so the address prefix of `2001:0db8::/64` is not advertised from the device.

```
awplus# configure terminal
awplus(config)# interface vlan4
awplus(config-if)# no ipv6 nd prefix 2001:0db8::/64
```

The following example resets all router advertisements on the VLAN interface `vlan4`:

```
awplus# configure terminal
awplus(config)# interface vlan4
awplus(config-if)# no ipv6 nd prefix all
```

**Related Commands** [ipv6 nd suppress-ra](#)

# ipv6 nd ra-interval

**Overview** Use this command to specify the interval between IPv6 Router Advertisements (RA) transmissions.

Use **no** parameter with this command to reset the value to the default value (600 seconds).

**Syntax** `ipv6 nd ra-interval <seconds>`  
`no ipv6 nd ra-interval`

| Parameter                    | Description                                                                                                        |
|------------------------------|--------------------------------------------------------------------------------------------------------------------|
| <code>&lt;seconds&gt;</code> | Specifies the number of seconds between IPv6 Router Advertisements (RAs). Valid values are from 4 to 1800 seconds. |

**Default** 600 seconds.

**Mode** Interface Configuration for a VLAN interface or a PPP interface.

**Usage** Advertisement flags will not be transmitted unless you have applied the `ipv6 nd suppress-ra` command as shown in the example below.

**Example** To set the advertisements interval on the VLAN interface "vlan4" to be 60 seconds, use the following commands:

```
awplus# configure terminal
awplus(config)# interface vlan4
awplus(config-if)# ipv6 nd ra-interval 60
awplus(config-if)# no ipv6 nd suppress-ra
```

**Related Commands** [ipv6 nd minimum-ra-interval](#)  
[ipv6 nd suppress-ra](#)  
[ipv6 nd prefix](#)

# ipv6 nd ra-lifetime

**Overview** Use this command to specify the time period that this router can usefully act as a default gateway for the network. Each router advertisement resets this time period.

Use **no** parameter with this command to reset the value to default.

**Syntax** `ipv6 nd ra-lifetime <seconds>`  
`no ipv6 nd ra-lifetime`

**Default** 1800 seconds

**Mode** Interface Configuration for a VLAN interface or a PPP interface.

**Usage** This command specifies the lifetime of the current router to be announced in IPv6 Router Advertisements.

Advertisement flags will not be transmitted unless you have applied the [ipv6 nd suppress-ra](#) command. This instruction is included in the example shown below.

**Examples** To set the advertisement lifetime of 8000 seconds on the VLAN interface `vlan4`, use the following commands:

```
awplus# configure terminal
awplus(config)# interface vlan4
awplus(config-if)# ipv6 nd ra-lifetime 8000
awplus(config-if)# no ipv6 nd suppress-ra
```

To set the advertisement lifetime of 8000 seconds on the PPP interface `ppp0`, use the following commands:

```
awplus# configure terminal
awplus(config)# interface ppp0
awplus(config-if)# ipv6 nd ra-lifetime 8000
awplus(config-if)# no ipv6 nd suppress-ra
```

**Related Commands** [ipv6 nd suppress-ra](#)  
[ipv6 nd prefix](#)

# ipv6 nd reachable-time

**Overview** Use this command to specify the reachable time in the router advertisement to be used for detecting reachability of the IPv6 neighbor.

Use the **no** variant of this command to reset the value to default.

**Syntax** `ipv6 nd reachable-time <milliseconds>`  
`no ipv6 nd reachable-time`

**Default** 0 milliseconds

**Mode** Interface Configuration for a VLAN interface or a PPP interface.

**Usage** This command specifies the reachable time of the current router to be announced in IPv6 Router Advertisements.

Advertisement flags will not be transmitted unless you have applied the [ipv6 nd suppress-ra](#) command. This instruction is included in the example shown below.

**Example** To set the reachable-time in router advertisements on the VLAN interface `vlan4` to be 1800000 milliseconds, enter the following commands:

```
awplus# configure terminal
awplus(config)# interface vlan4
awplus(config-if)# ipv6 nd reachable-time 1800000
awplus(config-if)# no ipv6 nd suppress-ra
```

To reset the reachable-time in router advertisements on the VLAN interface `vlan4` to an unspecified reachable-time (0 milliseconds), enter the following commands:

```
awplus# configure terminal
awplus(config)# interface vlan4
awplus(config-if)# no ipv6 nd reachable-time
```

To set the reachable-time in router advertisements on the PPP interface `ppp0` to be 1800000 milliseconds, enter the following commands:

```
awplus# configure terminal
awplus(config)# interface ppp0
awplus(config-if)# ipv6 nd reachable-time 1800000
awplus(config-if)# no ipv6 nd suppress-ra
```

To reset the reachable-time in router advertisements on the PPP interface `ppp0` to an unspecified reachable-time (0 milliseconds), enter the following commands:

```
awplus# configure terminal
awplus(config)# interface ppp0
awplus(config-if)# no ipv6 nd reachable-time
```

**Related  
Commands** [ipv6 nd suppress-ra](#)  
[ipv6 nd prefix](#)



# ipv6 nd retransmission-time

**Overview** Use this command to specify the advertised retransmission interval for Neighbor Solicitation in milliseconds between IPv6 Routers.

Use the **no** variant of this command to reset the retransmission time to the default (1 second).

**Syntax** `ipv6 nd retransmission-time <milliseconds>`  
`no ipv6 nd retransmission-time`

| Parameter                         | Description                                                         |
|-----------------------------------|---------------------------------------------------------------------|
| <code>&lt;milliseconds&gt;</code> | Time period in milliseconds. Valid values are from 1000 to 3600000. |

**Default** 1000 milliseconds (1 second)

**Mode** Interface Configuration for a VLAN interface or a PPP interface.

**Examples** To set the retransmission-time of Neighbor Solicitation on the VLAN interface `vlan2` to be 800000 milliseconds, enter the following commands:

```
awplus# configure terminal
awplus(config)# interface vlan2
awplus(config-if)# ipv6 nd retransmission-time 800000
```

To reset the retransmission-time of Neighbor Solicitation on the VLAN interface `vlan2` to the default 1000 milliseconds (1 second), enter the following commands:

```
awplus# configure terminal
awplus(config)# interface vlan2
awplus(config-if)# no ipv6 nd retransmission-time
```

To set the retransmission-time of Neighbor Solicitation on the PPP interface `ppp0` to be 800000 milliseconds, enter the following commands:

```
awplus# configure terminal
awplus(config)# interface ppp0
awplus(config-if)# ipv6 nd retransmission-time 800000
```

To reset the retransmission-time of Neighbor Solicitation on the PPP interface `ppp0` to the default 1000 milliseconds (1 second), enter the following commands:

```
awplus# configure terminal
awplus(config)# interface ppp0
awplus(config-if)# no ipv6 nd retransmission-time
```

**Related  
Commands** [ipv6 nd suppress-ra](#)  
[ipv6 nd prefix](#)

# ipv6 nd suppress-ra

**Overview** Use this command to inhibit IPv6 Router Advertisement (RA) transmission for the current interface. Router advertisements are used when applying IPv6 stateless auto-configuration.

Use **no** parameter with this command to enable Router Advertisement transmission.

**Syntax** `ipv6 nd suppress-ra`  
`no ipv6 nd suppress-ra`

**Default** Router Advertisement (RA) transmission is suppressed by default.

**Mode** Interface Configuration for a VLAN interface or a PPP interface.

**Example** To enable the transmission of router advertisements from the VLAN interface `vlan4` on the device, use the following commands:

```
awplus# configure terminal
awplus(config)# interface vlan4
awplus(config-if)# no ipv6 nd suppress-ra
```

To enable the transmission of router advertisements from the PPP interface `ppp0` on the router, use the following commands:

```
awplus# configure terminal
awplus(config)# interface ppp0
awplus(config-if)# no ipv6 nd suppress-ra
```

**Related  
Commands** [ipv6 nd ra-interval](#)  
[ipv6 nd prefix](#)

# ipv6 neighbor

**Overview** Use this command to add a static IPv6 neighbor entry.  
Use the **no** variant of this command to remove a specific IPv6 neighbor entry.

**Syntax** `ipv6 neighbor <ipv6-address> <vlan-name> <mac-address>  
<port-list>`  
`no ipv6 neighbor <ipv6-address> <vlan-name> <port-list>`

| Parameter                         | Description                                                                                |
|-----------------------------------|--------------------------------------------------------------------------------------------|
| <code>&lt;ipv6-address&gt;</code> | Specify the neighbor's IPv6 address in the format X:X::X:X.                                |
| <code>&lt;vlan-name&gt;</code>    | Specify the neighbor's VLAN name.                                                          |
| <code>&lt;mac-address&gt;</code>  | Specify the MAC hardware address in hexadecimal notation in the format HHHH . HHHH . HHHH. |
| <code>&lt;port-list&gt;</code>    | Specify the port number, or port range.                                                    |

**Mode** Global Configuration

**Usage** Use this command to clear a specific IPv6 neighbor entry. To clear all dynamic address entries, use the [clear ipv6 neighbors](#) command.

**Example** To create a static neighbor entry for IPv6 address 2001:0db8::a2, on vlan 4, MAC address 0000.cd28.0880, on port1.0.6, use the command:

```
awplus# configure terminal
awplus(config)# ipv6 neighbor 2001:0db8::a2 vlan4
0000.cd28.0880 port1.0.6
```

**Related Commands** [clear ipv6 neighbors](#)

# ipv6 opportunistic-nd

**Overview** Use this command to enable opportunistic neighbor discovery for the global IPv6 ND cache. Opportunistic neighbor discovery changes the behavior for unsolicited ICMPv6 ND packet forwarding on the device.

Use the **no** variant of this command to disable opportunistic neighbor discovery for the global IPv6 ND cache.

**Syntax** `ipv6 opportunistic-nd`  
`no ipv6 opportunistic-nd`

**Default** Opportunistic neighbor discovery is disabled by default.

**Mode** Global Configuration

**Usage** When opportunistic neighbor discovery is enabled, the device will reply to any received unsolicited ICMPv6 ND packets. The source MAC address for the unsolicited ICMPv6 ND packet is added to the IPv6 ND cache, so the device forwards the ICMPv6 ND packet. When opportunistic neighbor discovery is disabled, the source MAC address for the ICMPv6 packet is not added to the IPv6 ND cache, so the ICMPv6 ND packet is not forwarded by the device.

**Examples** To enable opportunistic neighbor discovery for the IPv6 ND cache, enter:

```
awplus# configure terminal
awplus(config)# ipv6 opportunistic-nd
```

To disable opportunistic neighbor discovery for the IPv6 ND cache, enter:

```
awplus# configure terminal
awplus(config)# no ipv6 opportunistic-nd
```

**Related Commands** [arp opportunistic-nd](#)  
[show ipv6 neighbors](#)  
[show running-config interface](#)

# ipv6 route

**Overview** This command adds a static IPv6 route to the Routing Information Base (RIB). If this route is the best route for the destination, then your device adds it to the Forwarding Information Base (FIB). Your device uses the FIB to advertise routes to neighbors and forward packets.

The **no** variant of this command removes the static route.

**Syntax** `ipv6 route <dest-prefix> <dest-prefix/length> {<gateway-ip>|<gateway-name>} [<distvalue>]`  
`no ipv6 route <dest-prefix> <dest-prefix/length> {<gateway-ip>|<gateway-name>} [<distvalue>]`

| Parameter                               | Description                                                                                                                                               |
|-----------------------------------------|-----------------------------------------------------------------------------------------------------------------------------------------------------------|
| <code>&lt;dest-prefix/length&gt;</code> | Specifies the IP destination prefix. The IPv6 address prefix uses the format X:X::/prefix-length. The prefix-length is usually set between 0 and 64.      |
| <code>&lt;gateway-ip&gt;</code>         | Specifies the IP gateway (or next hop) address. The IPv6 address uses the format X:X::X:Prefix-Length. The prefix-length is usually set between 0 and 64. |
| <code>&lt;gateway-name&gt;</code>       | Specifies the name of the gateway (or next hop) interface.                                                                                                |
| <code>&lt;distvalue&gt;</code>          | Specifies the administrative distance for the route. Valid values are from 1 to 255.                                                                      |

**Mode** Global Configuration

**Usage** Administrative distance can be modified so static routes do not take priority over other routes.

**Example** `awplus# configure terminal`  
`awplus(config)# ipv6 route 2001:0db8::1/128 vlan2 32`

**Validation Commands** `show running-config`  
`show ipv6 route`

# ipv6 unreachable

**Overview** Use this command to enable ICMPv6 (Internet Control Message Protocol version 6) type 1, destination unreachable, messages.

Use the **no** variant of this command to disable destination unreachable messages. This prevents an attacker from using these messages to discover the topology of a network.

**Syntax** `ipv6 unreachable`  
`no ipv6 unreachable`

**Default** Destination unreachable messages are enabled by default.

**Mode** Global Configuration

**Usage** When a device receives a packet for a destination that is unreachable it returns an ICMPv6 type 1 message. This message includes a reason code, as per the table below. An attacker can use these messages to obtain information regarding the topology of a network. Disabling destination unreachable messages, using the **no ipv6 unreachable** command, secures your network against this type of probing.

**NOTE:** *Disabling ICMPv6 destination unreachable messages breaks applications such as traceroute, which depend on these messages to operate correctly.*

Table 25-1: ICMPv6 type 1 reason codes and description

| Code | Description [RFC]                                                    |
|------|----------------------------------------------------------------------|
| 0    | No route to destination [RFC4443]                                    |
| 1    | Communication with destination administratively prohibited [RFC4443] |
| 2    | Beyond scope of source address [RFC4443]                             |
| 3    | Address unreachable [RFC4443]                                        |
| 4    | Port unreachable [RFC4443]                                           |
| 5    | Source address failed ingress/egress policy [RFC4443]                |
| 6    | Reject route to destination [RFC4443]                                |
| 7    | Error in Source Routing Header [RFC6554]                             |

**Example** To disable destination unreachable messages, use the commands

```
awplus# configure terminal
awplus(config)# no ipv6 unreachable
```

To enable destination unreachable messages, use the commands

```
awplus# configure terminal
awplus(config)# ipv6 unreachable
```

# ping ipv6

**Overview** This command sends a query to another IPv6 host (send Echo Request messages).

**Syntax** ping ipv6 {<host>|<ipv6-address>} [repeat {<1-2147483647>|continuous}] [size <10-1452>] [interface <interface-list>] [timeout <1-65535>]

| Parameter                  | Description                                                                                                                                                                        |
|----------------------------|------------------------------------------------------------------------------------------------------------------------------------------------------------------------------------|
| <ipv6-addr>                | The destination IPv6 address. The IPv6 address uses the format X:X::X:X.                                                                                                           |
| <hostname>                 | The destination hostname.                                                                                                                                                          |
| repeat                     | Specify the number of ping packets to send.                                                                                                                                        |
| <1-2147483647>             | Specify repeat count. The default is 5.                                                                                                                                            |
| size <10-1452>             | The number of data bytes to send, excluding the 8 byte ICMP header. The default is 56 (64 ICMP data bytes).                                                                        |
| interface <interface-list> | The interface or range of configured IP interfaces to use as the source in the IP header of the ping packet. You can only specify the interface when pinging a link local address. |
| timeout <1-65535>          | The time in seconds to wait for echo replies if the ARP entry is present, before reporting that no reply was received. If no ARP entry is present, it does not wait.               |
| repeat                     | Specify the number of ping packets to send.                                                                                                                                        |
| <1-2147483647>             | Specify repeat count. The default is 5.                                                                                                                                            |
| continuous                 | Continuous ping.                                                                                                                                                                   |
| size <10-1452>             | The number of data bytes to send, excluding the 8 byte ICMP header. The default is 56 (64 ICMP data bytes).                                                                        |
| timeout <1-65535>          | The time in seconds to wait for echo replies if the ARP entry is present, before reporting that no reply was received. If no ARP entry is present, it does not wait.               |

**Mode** User Exec and Privileged Exec

**Example** awplus# ping ipv6 2001:0db8::a2

**Related Commands** [traceroute ipv6](#)



# show ipv6 forwarding

**Overview** Use this command to display IPv6 forwarding status.

**Syntax** `show ipv6 forwarding`

**Mode** User Exec and Privileged Exec

**Example** `awplus# show ipv6 forwarding`

**Output** Figure 25-1: Example output from the **show ipv6 forwarding** command

```
ipv6 forwarding is on
```

# show ipv6 interface brief

**Overview** Use this command to display brief information about interfaces and the IPv6 address assigned to them.

For information on filtering and saving command output, see the [“Getting Started with AlliedWare Plus” Feature Overview and Configuration Guide](#).

**Syntax** `show ipv6 interface [brief]`

| Parameter | Description                                                                  |
|-----------|------------------------------------------------------------------------------|
| brief     | Specify this optional parameter to display brief IPv6 interface information. |

**Mode** User Exec and Privileged Exec

**Examples** `awplus# show ipv6 interface brief`

**Output** Figure 25-2: Example output from the **show ipv6 interface brief** command

```
awplus#show ipv6 interface brief
Interface IPv6-Address Status Protocol
lo unassigned admin up running
vlan1 2001:db8::1/48 admin up down
 fe80::215:77ff:fee9:5c50/64
```

**Related Commands** [show interface brief](#)

# show ipv6 neighbors

**Overview** Use this command to display all IPv6 neighbors.

For information on filtering and saving command output, see the [“Getting Started with AlliedWare Plus” Feature Overview and Configuration Guide](#).

**Syntax** `show ipv6 neighbors`

**Mode** User Exec and Privileged Exec

# show ipv6 route

**Overview** Use this command to display the IPv6 routing table for a protocol or from a particular table.

For information on filtering and saving command output, see the [“Getting Started with AlliedWare Plus” Feature Overview and Configuration Guide](#).

**Syntax** `show ipv6 route`  
`[connected|database|ospf|rip|static|summary|<ipv6-address>|<ipv6-addr/prefix-length>]`

| Parameter            | Description                                                                                                                                                                        |
|----------------------|------------------------------------------------------------------------------------------------------------------------------------------------------------------------------------|
| connected            | Displays only the routes learned from connected interfaces.                                                                                                                        |
| database             | Displays only the IPv6 routing information extracted from the database.                                                                                                            |
| ospf                 | Displays only the routes learned from IPv6 Open Shortest Path First (OSPFv3).                                                                                                      |
| rip                  | Displays only the routes learned from IPv6 Routing Information Protocol (RIPng).                                                                                                   |
| static               | Displays only the IPv6 static routes you have configured.                                                                                                                          |
| summary              | Displays summary information from the IPv6 routing table.                                                                                                                          |
| <ipv6-address>       | Displays the routes for the specified address in the IP routing table. The IPv6 address uses the format X:X::X:X/Prefix-Length. The prefix-length is usually set between 0 and 64. |
| <ipv6-prefix/length> | Displays only the routes for the specified IP prefix.                                                                                                                              |

**Mode** User Exec and Privileged Exec

**Example 1** To display an IP route with all parameters turned on, use the following command:

```
awplus# show ipv6 route
```

**Output** Figure 25-3: Example output of the **show ipv6 route** command

```
IPv6 Routing Table
Codes: C - connected, S - static, R - RIP, O - OSPF, B - BGP
S ::/0 [1/0] via 2001::a:0:0:c0a8:a6, vlan10
C 2001:db8::a:0:0:0/64 via ::, vlan10
C 2001:db8::14:0:0:0/64 via ::, vlan20
C 2001:db8::0:0:0:0/64 via ::, vlan30
C 2001:db8::28:0:0:0/64 via ::, vlan40
C 2001:db8::fa:0:0:0/64 via ::, vlan250
C 2001:db8::/64 via ::, vlan250
C 2001:db8::/64 via ::, vlan40
C 2001:db8::/64 via ::, vlan20
C 2001:db8::/64 via ::, vlan10
```

**Example 2** To display all database entries for an IP route, use the following command:

```
awplus# show ipv6 route database
```

**Output** Figure 25-4: Example output of the **show ipv6 route database** command

```
IPv6 Routing Table
Codes: C - connected, S - static, R - RIP, O - OSPF, B - BGP
> - selected route, * - FIB route, p - stale info
Timers: Uptime

S ::/0 [1/0] via 2001::a:0:0:c0a8:a01 inactive, 6d22h12m
 [1/0] via 2001::fa:0:0:c0a8:fa01 inactive, 6d22h12m
```

# show ipv6 route summary

**Overview** Use this command to display the summary of the current NSM RIB entries.  
For information on filtering and saving command output, see the [“Getting Started with AlliedWare Plus” Feature Overview and Configuration Guide](#).

**Syntax** `show ipv6 route summary`

**Mode** User Exec and Privileged Exec

**Example** To display IP route summary, use the following command:

```
awplus# show ipv6 route summary
```

**Output** Figure 25-5: Example output from the **show ipv6 route summary** command

```
IPv6 routing table name is Default-IPv6-Routing-Table(0)
IPv6 routing table maximum-paths is 4
RouteSource Networks
connected 4
rip 5
Total 9
FIB 5
```

**Related Commands** [show ip route database](#)

# traceroute ipv6

**Overview** Use this command to trace the route to the specified IPv6 host.

**Syntax** `traceroute ipv6 {<ipv6-addr>|<hostname>}`

| Parameter                      | Description                                                              |
|--------------------------------|--------------------------------------------------------------------------|
| <code>&lt;ipv6-addr&gt;</code> | The destination IPv6 address. The IPv6 address uses the format X:X::X:X. |
| <code>&lt;hostname&gt;</code>  | The destination hostname.                                                |

**Mode** User Exec and Privileged Exec

**Example** To run a traceroute for the IPv6 address 2001:0db8::a2, use the following command:

```
awplus# traceroute ipv6 2001:0db8::a2
```

**Related Commands** [ping ipv6](#)

# 26

# Routing Commands

## Introduction

**Overview** This chapter provides an alphabetical reference of routing commands that are common across the routing IP protocols. For more information, see the [Route Selection Feature Overview and Configuration Guide](#).

- Command List**
- [“ip route”](#) on page 825
  - [“ipv6 route”](#) on page 828
  - [“max-fib-routes”](#) on page 829
  - [“max-static-routes”](#) on page 831
  - [“maximum-paths”](#) on page 832
  - [“show ip route”](#) on page 833
  - [“show ip route database”](#) on page 836
  - [“show ip route summary”](#) on page 839
  - [“show ipv6 route”](#) on page 841
  - [“show ipv6 route summary”](#) on page 843



# ip route

**Overview** This command adds a static route to the Routing Information Base (RIB). If this route is the best route for the destination, then your device adds it to the Forwarding Information Base (FIB). Your device uses the FIB to advertise routes to neighbors and forward packets.

When using VRF (Virtual Routing and Forwarding), you can use this command to configure a static inter-VRF route to a destination network that is reachable by a remote gateway located in a different VRF instance. Note that to apply the command in this way, the `ip route static inter-vrf` command must be enabled (its default condition). For more information about VRF, see the [VRF Feature Overview and Configuration Guide](#) and the [VRF-lite Commands](#) chapter.

The **no** variant of this command removes the static route from the RIB and FIB.

**Syntax** `ip route <subnet&mask> {<gateway-ip>|<interface>} [<distance>]`  
`no ip route <subnet&mask> {<gateway-ip>|<interface>} [<distance>]`

**Syntax (VRF-lite)** `ip route [vrf <vrf-name>] <subnet&mask> [<gateway-ip>] [<interface>] [<distance>]`  
`no ip route [vrf <vrf-name>] <subnet&mask> [<gateway-ip>] [<interface>] [<distance>]`

| Parameter                            | Description                                                                                                                                                                                                                                                                                                                                                                                                                                                                                                                                           |
|--------------------------------------|-------------------------------------------------------------------------------------------------------------------------------------------------------------------------------------------------------------------------------------------------------------------------------------------------------------------------------------------------------------------------------------------------------------------------------------------------------------------------------------------------------------------------------------------------------|
| <code>&lt;subnet&amp;mask&gt;</code> | The IPv4 address of the destination subnet defined using either a prefix length or a separate mask specified in one of the following formats: <ul style="list-style-type: none"> <li>The IPv4 subnet address in dotted decimal notation followed by the subnet mask, also in dotted decimal notation.</li> <li>The IPv4 subnet address in dotted decimal notation, followed by a forward slash, then the prefix length</li> </ul>                                                                                                                     |
| <code>&lt;gateway-ip&gt;</code>      | The IPv4 address of the gateway device.                                                                                                                                                                                                                                                                                                                                                                                                                                                                                                               |
| <code>&lt;interface&gt;</code>       | The interface that connects your device to the network. Enter the name of the VLAN or its VID. You can also enter 'null' as an interface. Specify a 'null' interface to add a null or blackhole route to the switch.<br>The gateway IP address or the interface is required if VRF-lite is not configured.<br>If VRF-lite is configured: When adding a static intra-VRF route, you must specify either the gateway IP address or the interface. When adding a static inter-VRF route, you must specify both the gateway IP address and the interface. |
| <code>&lt;distance&gt;</code>        | The administrative distance for the static route in the range <1-255>. Static routes by default have an administrative distance of 1.                                                                                                                                                                                                                                                                                                                                                                                                                 |

| Parameter  | Description                                                         |
|------------|---------------------------------------------------------------------|
| vrf        | Applies the command to the specified VRF instance.                  |
| <vrf-name> | The name of the VRF instance to enter IPv4 Address-Family mode for. |

**Mode** Global Configuration

**Default** The default administrative distance for a static route is 1 for priority over non-static routes.

**Usage** Administrative distance can be modified so that static routes do not take priority over other routes.

Specify a 'Null' interface to add a null or blackhole route to the switch. A null or blackhole route is a routing table entry that does not forward packets, so any packets sent to it are dropped.

**Examples** To add the destination 192.168.3.0 with the mask 255.255.255.0 as a static route available through the device at "10.10.0.2" with the default administrative distance, use the commands:

```
awplus# configure terminal
awplus(config)# ip route 192.168.3.0 255.255.255.0 10.10.0.2
```

To remove the destination 192.168.3.0 with the mask 255.255.255.0 as a static route available through the device at "10.10.0.2" with the default administrative distance, use the commands:

```
awplus# configure terminal
awplus(config)# no ip route 192.168.3.0 255.255.255.0 10.10.0.2
```

To specify a null or blackhole route 192.168.4.0/24, so packets forwarded to this route are dropped, use the commands:

```
awplus# configure terminal
awplus(config)# ip route 192.168.4.0/24 null
```

To add the destination 192.168.3.0 with the mask 255.255.255.0 as a static route available through the device at "10.10.0.2" with an administrative distance of 128, use the commands:

```
awplus# configure terminal
awplus(config)# ip route 192.168.3.0 255.255.255.0 10.10.0.2
128
```

**Examples (VRF-lite)** To create a static route from source VRF instance red, to the subnet 192.168.50.0/24 with a next hop of 192.168.20.6, use the following commands for static intra-VRF routing configuration:

```
awplus# configure terminal
awplus(config)# ip route vrf red 192.168.50.0/24 192.168.20.6
```

To remove a static route from source VRF red, to the subnet 192.168.50.0/24 with a next hop of 192.168.20.6, use the following commands for static intra-VRF routing configuration:

```
awplus# configure terminal
awplus(config)# no ip route vrf red 192.168.50.0/24
192.168.20.6
```

To create a static route from source VRF red, to the subnet 192.168.50.0/24 with a next hop of 192.168.20.6 via vlan10, use the following commands for static inter-VRF routing configuration:

```
awplus# configure terminal
awplus(config)# ip route vrf red 192.168.50.0/24 192.168.20.6
vlan10
```

**Related  
Commands** [show ip route](#)  
[show ip route database](#)

**Command  
changes** Version 5.4.6-2.1: VRF-lite support added.

# ipv6 route

**Overview** This command adds a static IPv6 route to the Routing Information Base (RIB). If this route is the best route for the destination, then your device adds it to the Forwarding Information Base (FIB). Your device uses the FIB to advertise routes to neighbors and forward packets.

The **no** variant of this command removes the static route.

**Syntax** `ipv6 route <dest-prefix> <dest-prefix/length> {<gateway-ip>|<gateway-name>} [<distvalue>]`  
`no ipv6 route <dest-prefix> <dest-prefix/length> {<gateway-ip>|<gateway-name>} [<distvalue>]`

| Parameter                               | Description                                                                                                                                               |
|-----------------------------------------|-----------------------------------------------------------------------------------------------------------------------------------------------------------|
| <code>&lt;dest-prefix/length&gt;</code> | Specifies the IP destination prefix. The IPv6 address prefix uses the format X:X::/prefix-length. The prefix-length is usually set between 0 and 64.      |
| <code>&lt;gateway-ip&gt;</code>         | Specifies the IP gateway (or next hop) address. The IPv6 address uses the format X:X::X:Prefix-Length. The prefix-length is usually set between 0 and 64. |
| <code>&lt;gateway-name&gt;</code>       | Specifies the name of the gateway (or next hop) interface.                                                                                                |
| <code>&lt;distvalue&gt;</code>          | Specifies the administrative distance for the route. Valid values are from 1 to 255.                                                                      |

**Mode** Global Configuration

**Usage** Administrative distance can be modified so static routes do not take priority over other routes.

**Example** `awplus# configure terminal`  
`awplus(config)# ipv6 route 2001:0db8::1/128 vlan2 32`

**Validation Commands** `show running-config`  
`show ipv6 route`

# max-fib-routes

**Overview** This command enables you to control the maximum number of FIB routes configured. It operates by providing parameters that enable you to configure preset maximums and warning message thresholds.

**NOTE:** When using VRF-lite, this command applies to the Global VRF instance; to set the max-fib-routes for a user-defined VRF instance use the *max-fib-routes (VRF)* command. For static routes use the *max-static-routes* command for the Global VRF instance and the *max-static-routes (VRF)* command for a user-defined VRF instance.

Use the **no** variant of this command to set the maximum number of FIB routes to the default of 4294967294 FIB routes.

**Syntax** `max-fib-routes <1-4294967294> [<1-100>|warning-only]`  
`no max-fib-routes`

| Parameter      | Description                                                                                                                                                                                                                                                                                                                                  |
|----------------|----------------------------------------------------------------------------------------------------------------------------------------------------------------------------------------------------------------------------------------------------------------------------------------------------------------------------------------------|
| max-fib-routes | This is the maximum number of routes that can be stored in the device's Forwarding Information dataBase. In practice, other practical system limits would prevent this maximum being reached.                                                                                                                                                |
| <1-4294967294> | The allowable configurable range for setting the maximum number of FIB-routes.                                                                                                                                                                                                                                                               |
| <1-100>        | This parameter enables you to optionally apply a percentage value. This percentage will be based on the maximum number of FIB routes you have specified. This will cause a warning message to appear when your routes reach your specified percentage value. Routes can continue to be added until your configured maximum value is reached. |
| warning-only   | This parameter enables you to optionally apply a warning message. If you set this option a warning message will appear if your maximum configured value is reached. Routes can continue to be added until your device reaches either the maximum capacity value of 4294967294, or a practical system limit.                                  |

**Default** The default number of FIB routes is the maximum number of FIB routes (4294967294).

**Mode** Global Configuration

**Examples** To set the maximum number of dynamic routes to 2000 and warning threshold of 75%, use the following commands:

```
awplus# config terminal
awplus(config)# max-fib-routes 2000 75
```

**Related  
Commands** [max-fib-routes \(VRF\)](#)

# max-static-routes

**Overview** Use this command to set the maximum number of static routes, excluding FIB (Forwarding Information Base) routes.

**NOTE:** For FIB routes use the [max-fib-routes](#) command.

Use the **no** variant of this command to set the maximum number of static routes to the default of 1024 static routes.

**Syntax** `max-static-routes <1-1024>`  
`no max-static-routes`

**Default** The default number of static routes is the maximum number of static routes (1024).

**Mode** Global Configuration

**Example** To reset the maximum number of static routes to the default maximum, use the command:

```
awplus# configure terminal
awplus(config)# no max-static-routes
```

**NOTE:** Static routes are applied before adding routes to the RIB (Routing Information Base). Therefore, rejected static routes will not appear in the running config.

**Related Commands** [max-fib-routes](#)

# maximum-paths

**Overview** This command enables ECMP on your device, and sets the maximum number of paths that each route has in the Forwarding Information Base (FIB). ECMP is enabled by default.

The **no** variant of this command sets the maximum paths to the default of 4.

ECMP path calculations are flow-based. This means that packets from the same flow will always be sent on the same path.

**Syntax** `maximum-paths <1-8>`  
`no maximum-paths`

| Parameter                | Description                                                   |
|--------------------------|---------------------------------------------------------------|
| <code>&lt;1-8&gt;</code> | The maximum number of paths that a route can have in the FIB. |

**Default** By default the maximum number of paths is 4.

**Mode** Global Configuration

**Examples** To set the maximum number of paths for each route in the FIB to 5, use the command:

```
awplus# configure terminal
awplus(config)# maximum-paths 5
```

To set the maximum paths for a route to the default of 4, use the command:

```
awplus# configure terminal
awplus(config)# no maximum-paths
```



# show ip route

**Overview** Use this command to display routing entries in the FIB (Forwarding Information Base). The FIB contains the best routes to a destination, and your device uses these routes when forwarding traffic. You can display a subset of the entries in the FIB based on protocol.

To modify the lines displayed, use the | (output modifier token); to save the output to a file, use the > output redirection token.

**VRF-lite** If VRF-lite is configured, you can display routing entries in the FIB associated with either the global routing domain or a named VRF.

**Syntax** `show ip route [bgp|connected|ospf|rip|static|<ip-addr>|<ip-addr/prefix-length>]`

**Syntax (VRF-lite)** `show ip route {vrf <vrf-name>|global}  
[bgp|connected|ospf|rip|static]`

| Parameter               | Description                                                                              |
|-------------------------|------------------------------------------------------------------------------------------|
| global                  | If VRF-lite is configured, apply the command to the global routing and forwarding table. |
| vrf                     | Apply the command to the specified VRF instance.                                         |
| <vrf-name>              | The name of the VRF instance.                                                            |
| bgp                     | Displays only the routes learned from BGP.                                               |
| connected               | Displays only the routes learned from connected interfaces.                              |
| ospf                    | Displays only the routes learned from OSPF.                                              |
| rip                     | Displays only the routes learned from RIP.                                               |
| static                  | Displays only the static routes you have configured.                                     |
| <ip-addr>               | Displays the routes for the specified address. Enter an IPv4 address.                    |
| <ip-addr/prefix-length> | Displays the routes for the specified network. Enter an IPv4 address and prefix length.  |

**Mode** User Exec and Privileged Exec

**Example** To display the static routes in the FIB, use the command:

```
awplus# show ip route static
```

To display the OSPF routes in the FIB, use the command:

```
awplus# show ip route ospf
```

**Example (VRF-lite)** To display all routing entries in the FIB associated with a VRF instance `red`, use the command:

```
awplus# show ip route vrf red
```

**Output** Each entry in the output from this command has a code preceding it, indicating the source of the routing entry. For example, O indicates OSPF as the origin of the route. The first few lines of the output list the possible codes that may be seen with the route entries.

Typically, route entries are composed of the following elements:

- code
- a second label indicating the sub-type of the route
- network or host IP address
- administrative distance and metric
- next hop IP address
- outgoing interface name
- time since route entry was added

Figure 26-1: Example output from the **show ip route** command

```
Codes: C - connected, S - static, R - RIP, B - BGP
O - OSPF, IA - OSPF inter area
N1 - OSPF NSSA external type 1, N2 - OSPF NSSA external type 2
E1 - OSPF external type 1, E2 - OSPF external type 2
* - candidate default

O 10.10.37.0/24 [110/11] via 10.10.31.16, vlan2, 00:20:54
C 3.3.3.0/24 is directly connected, vlan1
C 10.10.31.0/24 is directly connected, vlan2
C 10.70.0.0/24 is directly connected, vlan4
O E2 14.5.1.0/24 [110/20] via 10.10.31.16, vlan2, 00:18:56
C 33.33.33.33/32 is directly connected, lo
```

**Connected Route** The connected route entry consists of:

```
C 10.10.31.0/24 is directly connected, vlan2
```

This route entry denotes:

- Route entries for network `10.10.31.0/24` are derived from the IP address of local interface `vlan2`.
- These routes are marked as Connected routes (C) and always preferred over routes for the same network learned from other routing protocols.

**OSPF Route** The OSPF route entry consists of:

```
O 10.10.37.0/24 [110/11] via 10.10.31.16, vlan2, 00:20:54
```

This route entry denotes:

- This route in the network 10.10.37.0/24 was added by OSPF.
- This route has an administrative distance of 110 and metric/cost of 11.
- This route is reachable via next hop 10.10.31.16.
- The outgoing local interface for this route is `vlan2`.
- This route was added 20 minutes and 54 seconds ago.

### OSPF External Route

The OSPF external route entry consists of:

```
O E2 14.5.1.0/24 [110/20] via 10.10.31.16, vlan2, 00:18:56
```

This route entry denotes that this route is the same as the other OSPF route explained above; the main difference is that it is a Type 2 External OSPF route.

### Related Commands

[ip route](#)  
[maximum-paths](#)  
[show ip route database](#)

### Command changes

Version 5.4.6-2.1: VRF-lite support added.

# show ip route database

**Overview** This command displays the routing entries in the RIB (Routing Information Base).

When multiple entries are available for the same prefix, RIB uses the routes' administrative distances to choose the best route. All best routes are entered into the FIB (Forwarding Information Base). To view the routes in the FIB, use the [show ip route](#) command.

To modify the lines displayed, use the | (output modifier token); to save the output to a file, use the > output redirection token.

**Syntax** `show ip route database [bgp|connected|ospf|rip|static]`

**Syntax (VRF-lite)** `show ip route [vrf <vrf-name>|global] database [bgp|connected|ospf|rip|static]`

| Parameter  | Description                                                                              |
|------------|------------------------------------------------------------------------------------------|
| global     | If VRF-lite is configured, apply the command to the global routing and forwarding table. |
| vrf        | Apply the command to the specified VRF instance.                                         |
| <vrf-name> | The name of the VRF instance.                                                            |
| bgp        | Displays only the routes learned from BGP.                                               |
| connected  | Displays only the routes learned from connected interfaces.                              |
| ospf       | Displays only the routes learned from OSPF.                                              |
| rip        | Displays only the routes learned from RIP.                                               |
| static     | Displays only the static routes you have configured.                                     |

**Mode** User Exec and Privileged Exec

**Example** To display the static routes in the RIB, use the command:

```
awplus# show ip route database static
```

**Output** Figure 26-2: Example output from the **show ip route database** command

```
Codes: C - connected, S - static, R - RIP, B - BGP
 O - OSPF, IA - OSPF inter area
 N1 - OSPF NSSA external type 1, N2 - OSPF NSSA external type 2
 E1 - OSPF external type 1, E2 - OSPF external type 2
 > - selected route, * - FIB route, p - stale info

O *> 9.9.9.9/32 [110/31] via 10.10.31.16, vlan2, 00:19:21
O 10.10.31.0/24 [110/1] is directly connected, vlan2, 00:28:20
C *> 10.10.31.0/24 is directly connected, vlan2
S *> 10.10.34.0/24 [1/0] via 10.10.31.16, vlan2
O 10.10.34.0/24 [110/31] via 10.10.31.16, vlan2, 00:21:19
O *> 10.10.37.0/24 [110/11] via 10.10.31.16, vlan2, 00:21:19
C *> 10.30.0.0/24 is directly connected, vlan6
S *> 11.22.11.0/24 [1/0] via 10.10.31.16, vlan2
O E2 *> 14.5.1.0/24 [110/20] via 10.10.31.16,vlan2, 00:19:21
O 16.16.16.16/32 [110/11] via 10.10.31.16, vlan2, 00:21:19
S *> 16.16.16.16/32 [1/0] via 10.10.31.16, vlan2
O *> 17.17.17.17/32 [110/31] via 10.10.31.16, vlan2, 00:21:19
C *> 45.45.45.45/32 is directly connected, lo
O *> 55.55.55.55/32 [110/21] via 10.10.31.16, vlan2, 00:21:19
C *> 127.0.0.0/8 is directly connected, lo
```

**Example (VRF-lite)** To display all routing entries in the RIB associated with a VRF instance `red`, use the command:

```
awplus# show ip route vrf red database
```

**Output** Figure 26-3: Example output from the **show ip route vrf red database** command

```
[VRF: red]
Codes: C - connected, S - static, R - RIP, B - BGP
 O - OSPF, IA - OSPF inter area
 N1 - OSPF NSSA external type 1, N2 - OSPF NSSA external type 2
 E1 - OSPF external type 1, E2 - OSPF external type 2
 > - selected route, * - FIB route, p - stale info

O 192.168.10.0/24 [110/1] is directly connected, vlan1, 06:45:51
C *> 192.168.10.0/24 is directly connected, vlan1
B > 192.168.33.0/24 [20/0] via 192.168.30.3, 06:45:52
O E2 *> 192.168.110.0/24 [110/20] via 192.168.10.2, vlan1, 06:45:00
O E2 *> 192.168.111.0/24 [110/20] via 192.168.10.2, vlan1, 06:45:00
```

The routes added to the FIB are marked with a \*. When multiple routes are available for the same prefix, the best route is indicated with the > symbol. All unselected routes have neither the \* nor the > symbol.

```
S *> 10.10.34.0/24 [1/0] via 10.10.31.16, vlan2
O 10.10.34.0/24 [110/31] via 10.10.31.16, vlan2, 00:21:19
```

These route entries denote:

- The same prefix was learned from OSPF and from static route configuration.

- Since this static route has a lower administrative distance than the OSPF route (110), the static route (1) is selected and installed in the FIB.

If the static route becomes unavailable, then the device automatically selects the OSPF route and installs it in the FIB.

**Related  
Commands** [maximum-paths](#)  
[show ip route](#)

**Command  
changes** Version 5.4.6-2.1: VRF-lite support added.

# show ip route summary

**Overview** This command displays a summary of the current RIB (Routing Information Base) entries.

To modify the lines displayed, use the | (output modifier token); to save the output to a file, use the > output redirection token.

**Syntax** `show ip route summary`

**Syntax (VRF-lite)** `show ip route summary [vrf <vrf-name>|global]`

| Parameter  | Description                              |
|------------|------------------------------------------|
| vrf        | Specific VRF instance.                   |
| <vrf-name> | The name of the VRF instance.            |
| global     | The global routing and forwarding table. |

**Mode** User Exec and Privileged Exec

**Example** To display a summary of the current RIB entries, use the command:

```
awplus# show ip route summary
```

**Output** Figure 26-4: Example output from the **show ip route summary** command

```
IP routing table name is Default-IP-Routing-Table(0)
IP routing table maximum-paths is 4
Route Source Networks
connected 5
ospf 2
Total 8
```

**Example (VRF-lite)** To display a summary of the current RIB entries associated with a VRF instance red, use the command:

```
awplus# show ip route summary vrf red
```

**Output** Figure 26-5: Example output from the **show ip route summary vrf red** command

```
IP routing table name is Default-IP-Routing-Table(0)
IP routing table maximum-paths is 4
Route Source Networks
connected 1
Total 1
FIB 0

[VRF: red]
Route Source Networks
connected 1
ospf 2
Total 3
```

**Related Commands** [show ip route](#)  
[show ip route database](#)

**Command changes** Version 5.4.6-2.1: VRF-lite support added.



# show ipv6 route

**Overview** Use this command to display the IPv6 routing table for a protocol or from a particular table.

For information on filtering and saving command output, see the [“Getting Started with AlliedWare Plus” Feature Overview and Configuration Guide](#).

**Syntax** `show ipv6 route`  
`[connected|database|ospf|rip|static|summary|<ipv6-address>|<ipv6-addr/prefix-length>]`

| Parameter            | Description                                                                                                                                                                        |
|----------------------|------------------------------------------------------------------------------------------------------------------------------------------------------------------------------------|
| connected            | Displays only the routes learned from connected interfaces.                                                                                                                        |
| database             | Displays only the IPv6 routing information extracted from the database.                                                                                                            |
| ospf                 | Displays only the routes learned from IPv6 Open Shortest Path First (OSPFv3).                                                                                                      |
| rip                  | Displays only the routes learned from IPv6 Routing Information Protocol (RIPng).                                                                                                   |
| static               | Displays only the IPv6 static routes you have configured.                                                                                                                          |
| summary              | Displays summary information from the IPv6 routing table.                                                                                                                          |
| <ipv6-address>       | Displays the routes for the specified address in the IP routing table. The IPv6 address uses the format X:X::X:X/Prefix-Length. The prefix-length is usually set between 0 and 64. |
| <ipv6-prefix/length> | Displays only the routes for the specified IP prefix.                                                                                                                              |

**Mode** User Exec and Privileged Exec

**Example 1** To display an IP route with all parameters turned on, use the following command:

```
awplus# show ipv6 route
```

**Output** Figure 26-6: Example output of the **show ipv6 route** command

```
IPv6 Routing Table
Codes: C - connected, S - static, R - RIP, O - OSPF, B - BGP
S ::/0 [1/0] via 2001::a:0:0:c0a8:a6, vlan10
C 2001:db8::a:0:0:0/64 via ::, vlan10
C 2001:db8::14:0:0:0/64 via ::, vlan20
C 2001:db8::0:0:0:0/64 via ::, vlan30
C 2001:db8::28:0:0:0/64 via ::, vlan40
C 2001:db8::fa:0:0:0/64 via ::, vlan250
C 2001:db8::/64 via ::, vlan250
C 2001:db8::/64 via ::, vlan40
C 2001:db8::/64 via ::, vlan20
C 2001:db8::/64 via ::, vlan10
```

**Example 2** To display all database entries for an IP route, use the following command:

```
awplus# show ipv6 route database
```

**Output** Figure 26-7: Example output of the **show ipv6 route database** command

```
IPv6 Routing Table
Codes: C - connected, S - static, R - RIP, O - OSPF, B - BGP
> - selected route, * - FIB route, p - stale info
Timers: Uptime

S ::/0 [1/0] via 2001::a:0:0:c0a8:a01 inactive, 6d22h12m
 [1/0] via 2001::fa:0:0:c0a8:fa01 inactive, 6d22h12m
```

# show ipv6 route summary

**Overview** Use this command to display the summary of the current NSM RIB entries.  
For information on filtering and saving command output, see the [“Getting Started with AlliedWare Plus” Feature Overview and Configuration Guide](#).

**Syntax** `show ipv6 route summary`

**Mode** User Exec and Privileged Exec

**Example** To display IP route summary, use the following command:

```
awplus# show ipv6 route summary
```

**Output** Figure 26-8: Example output from the **show ipv6 route summary** command

```
IPv6 routing table name is Default-IPv6-Routing-Table(0)
IPv6 routing table maximum-paths is 4
RouteSource Networks
connected 4
rip 5
Total 9
FIB 5
```

**Related Commands** [show ip route database](#)

# 27

# RIP Commands

## Introduction

**Overview** This chapter provides an alphabetical reference of commands used to configure RIP.

For information about configuring RIP, see the [RIP Feature Overview and Configuration Guide](#).

- Command List**
- ["accept-lifetime"](#) on page 846
  - ["address-family ipv4 \(RIP\)"](#) on page 848
  - ["alliedware-behavior"](#) on page 849
  - ["cisco-metric-behavior \(RIP\)"](#) on page 851
  - ["clear ip rip route"](#) on page 852
  - ["debug rip"](#) on page 854
  - ["default-information originate \(RIP\)"](#) on page 855
  - ["default-metric \(RIP\)"](#) on page 856
  - ["distance \(RIP\)"](#) on page 857
  - ["distribute-list \(RIP\)"](#) on page 858
  - ["fullupdate \(RIP\)"](#) on page 859
  - ["ip rip authentication key-chain"](#) on page 860
  - ["ip rip authentication mode"](#) on page 862
  - ["ip rip authentication string"](#) on page 865
  - ["ip rip receive-packet"](#) on page 867
  - ["ip rip receive version"](#) on page 868
  - ["ip rip send-packet"](#) on page 869
  - ["ip rip send version"](#) on page 870

- ["ip rip send version 1-compatible"](#) on page 873
- ["ip rip split-horizon"](#) on page 875
- ["key"](#) on page 876
- ["key chain"](#) on page 877
- ["key-string"](#) on page 878
- ["maximum-prefix"](#) on page 879
- ["neighbor \(RIP\)"](#) on page 880
- ["network \(RIP\)"](#) on page 881
- ["passive-interface \(RIP\)"](#) on page 883
- ["recv-buffer-size \(RIP\)"](#) on page 884
- ["redistribute \(RIP\)"](#) on page 885
- ["restart rip graceful"](#) on page 887
- ["rip restart grace-period"](#) on page 888
- ["route \(RIP\)"](#) on page 889
- ["router rip"](#) on page 890
- ["send-lifetime"](#) on page 891
- ["show debugging rip"](#) on page 893
- ["show ip protocols rip"](#) on page 894
- ["show ip rip"](#) on page 895
- ["show ip rip database"](#) on page 896
- ["show ip rip interface"](#) on page 897
- ["show ip rip vrf database"](#) on page 898
- ["show ip rip vrf interface"](#) on page 899
- ["timers \(RIP\)"](#) on page 900
- ["undebug rip"](#) on page 902
- ["version \(RIP\)"](#) on page 903

# accept-lifetime

**Overview** Use this command to specify the time period during which the authentication key on a key chain is received as valid.

Use the **no** variant of this command to remove a specified time period for an authentication key on a key chain as set previously with the **accept-lifetime** command.

**Syntax** `accept-lifetime <start-date> {<end-date>|  
duration <seconds>|infinite}`  
`no accept-lifetime`

| Parameter                       | Description                                                                                                                                                                                                  |
|---------------------------------|--------------------------------------------------------------------------------------------------------------------------------------------------------------------------------------------------------------|
| <code>&lt;start-date&gt;</code> | Specifies the start time and date in the format:<br><code>&lt;hh:mm:ss&gt; &lt;day&gt; &lt;month&gt; &lt;year&gt;</code> or<br><code>&lt;hh:mm:ss&gt; &lt;month&gt; &lt;day&gt; &lt;year&gt;</code> , where: |
| <code>&lt;hh:mm:ss&gt;</code>   | The time of the day, in hours, minutes and seconds                                                                                                                                                           |
| <code>&lt;day&gt;</code>        | <1-31> The day of the month                                                                                                                                                                                  |
| <code>&lt;month&gt;</code>      | The month of the year (the first three letters of the month, for example, Jan)                                                                                                                               |
| <code>&lt;year&gt;</code>       | <1993-2035> The year                                                                                                                                                                                         |
| <code>&lt;end-date&gt;</code>   | Specifies the end time and date in the format:<br><code>&lt;hh:mm:ss&gt; &lt;day&gt; &lt;month&gt; &lt;year&gt;</code> or<br><code>&lt;hh:mm:ss&gt; &lt;month&gt; &lt;day&gt; &lt;year&gt;</code> , where:   |
| <code>&lt;hh:mm:ss&gt;</code>   | The time of the day, in hours, minutes and seconds                                                                                                                                                           |
| <code>&lt;day&gt;</code>        | <1-31> The day of the month                                                                                                                                                                                  |
| <code>&lt;month&gt;</code>      | The month of the year (the first three letters of the month, for example, Jan)                                                                                                                               |
| <code>&lt;year&gt;</code>       | <1993-2035> The year                                                                                                                                                                                         |
| <code>&lt;seconds&gt;</code>    | <1-2147483646> Duration of the key in seconds.                                                                                                                                                               |
| <code>infinite</code>           | Never expires.                                                                                                                                                                                               |

**Mode** Keychain-key Configuration

**Examples** The following examples show the setting of accept-lifetime for key 1 on the key chain named "mychain".

```
awplus# configure terminal
awplus(config)# key chain mychain
awplus(config-keychain)# key 1
awplus(config-keychain-key)# accept-lifetime 03:03:01 Sep 3
2016 04:04:02 Oct 6 2016
```

or:

```
awplus# configure terminal
awplus(config)# key chain mychain
awplus(config-keychain)# key 1
awplus(config-keychain-key)# accept-lifetime 03:03:01 3 Sep
2016 04:04:02 6 Oct 2016
```

**Related  
Commands**

[key](#)  
[key-string](#)  
[key chain](#)  
[send-lifetime](#)

# address-family ipv4 (RIP)

**Overview** This command enters the IPv4 address-family command mode. In this mode you can configure address-family specific parameters for a specific VRF (RIP) instance.

**Syntax** `address-family ipv4 vrf <vrf-name>`  
`no address-family ipv4 vrf <vrf-name>`

| Parameter                     | Description                                                         |
|-------------------------------|---------------------------------------------------------------------|
| <code>ipv4</code>             | Configure parameters relating to the RIP exchange of IPv4 prefixes. |
| <code>vrf</code>              | Apply this command to a VRF instance.                               |
| <code>&lt;vrf-name&gt;</code> | The name of the VRF instance.                                       |

**Mode** Router Configuration

**Usage** To leave Address Family mode and return to Router Configuration mode, use the [exit-address-family](#) command.

**Example** In this example the address family "green" is entered, and then exited by using the [exit-address-family](#) command.

```
awplus# configure terminal
awplus(config)# router rip
awplus(config-router)# address-family ipv4 vrf green
awplus(config-router-af)# exit-address-family
awplus(config-router)#
```

**Related Commands** [exit-address-family](#)

**Command changes** Version 5.4.6-2.1: VRF-lite support added.



# alliedware-behavior

**Overview** This command configures your device to exhibit AlliedWare behavior when sending RIPv1 response/update messages. Configuring for this behavior may be necessary if you are replacing an AlliedWare device with an AlliedWare Plus device and wish to ensure consistent RIPv1 behavior.

Use the `no` variant of this command to implement AlliedWare Plus behavior.

This command has no impact on devices running RIPv2. Reception and transmission can be independently altered to conform to AlliedWare standard.

**Syntax** `alliedware-behavior {rip1-send|rip1-recv}`  
`no alliedware-behavior {rip1-send|rip1-recv}`

| Parameter              | Description                                                                               |
|------------------------|-------------------------------------------------------------------------------------------|
| <code>rip1-send</code> | Configures the router to behave in AlliedWare mode when <b>sending</b> update messages.   |
| <code>rip1-recv</code> | Configures the router to behave in AlliedWare mode when <b>receiving</b> update messages. |

**Default** By default when sending out RIPv1 updates on an interface, if the prefix (learned through RIPv2 or otherwise redistributed into RIP) being advertised does not match the subnetting used on the outgoing RIPv1 interface it will be filtered. The **alliedware-behavior** command returns your router's RIPv1 behavior to the AlliedWare format, where the prefix will be advertised as-is.

For example, if a RIPv1 update is being sent over interface 192.168.1.4/26, by default the prefix 192.168.1.64/26 will be advertised, but the prefix 192.168.1.144/28 will be filtered because the mask /28 does not match the interface's mask of /26. If **alliedware-behavior rip1-send** is configured, the prefix 192.168.1.144 would be sent as-is.

**Mode** Router Configuration

**Examples** To configure your device for **alliedware-behavior** when sending and receiving RIPv1 update messages, enter the commands:

```
awplus# configure terminal
awplus(config)# router rip
awplus(config-router)# alliedware-behavior rip1-send
awplus(config-router)# alliedware-behavior rip1-recv
```

To return your device to **AlliedWare Plus**-like behavior when sending and receiving RIPv1 update messages, enter the commands:

```
awplus# configure terminal
awplus(config)# router rip
awplus(config-router)# no alliedware-behavior rip1-send
awplus(config-router)# no alliedware-behavior rip1-recv
```

**Validation  
Commands**    [show ip protocols rip](#)  
                  [show running-config](#)

**Related  
Commands**    [fullupdate \(RIP\)](#)

# cisco-metric-behavior (RIP)

**Overview** Use this command to enable or disable the RIP routing metric update to conform to Cisco's implementation. This command is provided to allow inter-operation with older Cisco devices that do not conform to the RFC standard for RIP route metrics.

Use the **no** variant of this command to disable this feature.

**Syntax** `cisco-metric-behavior {enable|disable}`  
`no cisco-metric-behavior`

| Parameter | Description                                         |
|-----------|-----------------------------------------------------|
| enable    | Enables updating the metric consistent with Cisco.  |
| disable   | Disables updating the metric consistent with Cisco. |

**Default** By default, the Cisco metric-behavior is disabled.

**Mode** Router Configuration

**Examples** To enable the routing metric update to behave as per the Cisco implementation, enter the commands:

```
awplus# configure terminal
awplus(config)# router rip
awplus(config-router)# cisco-metric-behavior enable
```

To disable the routing metric update to behave as per the default setting, enter the commands:

```
awplus# configure terminal
awplus(config)# router rip
awplus(config-router)# no cisco-metric-behavior
```

**Validation Commands** `show running-config`

# clear ip rip route

**Overview** Use this command to clear specific data from the RIP routing table.

**Syntax** `clear ip rip route {<ip-dest-network/prefix-length>|static|connected|rip|ospf|bgp|invalid-routes|all}`

**Syntax (VRF-lite)** `clear ip rip [vrf <vrf-name>] route {<ip-dest-network/prefix-length>|static|connected|rip|ospf|bgp|invalid-routes|all}`

| Parameter                       | Description                                                                                                                                             |
|---------------------------------|---------------------------------------------------------------------------------------------------------------------------------------------------------|
| vrf                             | Apply this command to a VRF instance.                                                                                                                   |
| <vrf-name>                      | The name of the VRF instance.                                                                                                                           |
| <ip-dest-network/prefix-length> | Removes entries which exactly match this destination address from RIP routing table. Enter the IP address and prefix length of the destination network. |
| static                          | Removes static entries from the RIP routing table.                                                                                                      |
| connected                       | Removes entries for connected routes from the RIP routing table.                                                                                        |
| rip                             | Removes only RIP routes from the RIP routing table.                                                                                                     |
| ospf                            | Removes only OSPF routes from the RIP routing table.                                                                                                    |
| bgp                             | Removes only BGP routes from the RIP routing table.                                                                                                     |
| invalid-routes                  | Removes routes with metric 16 immediately. Otherwise, these routes are not removed until RIP times out the route after 2 minutes.                       |
| all                             | Clears the entire RIP routing table.                                                                                                                    |

**Mode** Privileged Exec

**Usage** Using this command with the **all** parameter clears the RIP table of all the routes.

**Examples** To clear the route 10.0.0.0/8 from the RIP routing table, use the following command:

```
awplus# clear ip rip route 10.0.0.0/8
```

**Examples (VRF-lite)** To clear RIP routes associated with the VRF instance 'red' for OSPF routes, use the following command:

```
awplus# clear ip rip vrf red route ospf
```

To clear the route 10.0.0.0/8 from the RIP routing table for the VRF instance 'red', use the following command:

```
awplus# clear ip rip vrf red route 10.0.0.0/8
```

**Command changes** Version 5.4.6-2.1: VRF-lite support added.

# debug rip

**Overview** Use this command to specify the options for the displayed debugging information for RIP events and RIP packets.

Use the **no** variant of this command to disable the specified debug option.

**Syntax** `debug rip {events|nsm|<packet>|all}`  
`no debug rip {events|nsm|<packet>|all}`

| Parameter | Description                                                    |
|-----------|----------------------------------------------------------------|
| events    | RIP events debug information is displayed.                     |
| nsm       | RIP and NSM communication is displayed.                        |
| <packet>  | packet [recv send] [detail] Specifies RIP packets only.        |
| recv      | Specifies that information for received packets be displayed.  |
| send      | Specifies that information for sent packets be displayed.      |
| detail    | Displays detailed information for the sent or received packet. |
| all       | Displays all RIP debug information.                            |

**Default** Disabled

**Mode** Privileged Exec and Global Configuration

**Example** The following example displays information about the RIP packets that are received and sent out from the device.

```
awplus# debug rip packet
```

**Related Commands** [undebug rip](#)

# default-information originate (RIP)

**Overview** Use this command to generate a default route into the Routing Information Protocol (RIP).

Use the **no** variant of this command to disable this feature.

**Syntax** `default-information originate`  
`no default-information originate`

**Default** Disabled

**Mode** Router Configuration

**Usage** If routes are being redistributed into RIP and the router's route table contains a default route, within one of the route categories that are being redistributed, the RIP protocol will advertise this default route, irrespective of whether the **default-information originate** command has been configured or not. However, if the router has not redistributed any default route into RIP, but you want RIP to advertise a default route anyway, then use this command.

This will cause RIP to create a default route entry in the RIP database. The entry will be of type RS (Rip Static). Unless actively filtered out, this default route will be advertised out every interface that is sending RIP. Split horizon does not apply to this route, as it is internally generated. This operates quite similarly to the OSPF **default-information originate always** command.

**Example** `awplus# configure terminal`  
`awplus(config)# router rip`  
`awplus(config-router)# default-information originate`

# default-metric (RIP)

**Overview** Use this command to specify the metrics to be assigned to redistributed RIP routes. Use the **no** variant of this command to reset the RIP metric back to its default (1).

**Syntax** `default-metric <metric>`  
`no default-metric [<metric>]`

| Parameter | Description                                       |
|-----------|---------------------------------------------------|
| <metric>  | <1-16> Specifies the value of the default metric. |

**Default** By default, the RIP metric value is set to 1.

**Mode** RIP Router Configuration or RIP Router Address Family Configuration for a VRF instance.

**Usage** This command is used with the [redistribute \(RIP\)](#) command to make the routing protocol use the specified metric value for all redistributed routes, regardless of the original protocol that the route has been redistributed from.

**Examples** This example assigns the cost of 10 to the routes that are redistributed into RIP.

```
awplus# configure terminal
awplus(config)# router rip
awplus(config-router)# default-metric 10
awplus(config-router)# redistribute ospf
awplus(config-router)# redistribute connected
```

**Example (VRF-lite)** This example assigns the cost of 10 to the routes which are redistributed into RIP for the VRF instance blue.

```
awplus# configure terminal
awplus(config)# router rip
awplus(config-router)# address family ipv4 vrf blue
awplus(config-router-af)# default-metric 10
awplus(config-router-af)# redistribute ospf
awplus(config-router-af)# redistribute connected
```

**Related Commands** [redistribute \(RIP\)](#)

**Command changes** Version 5.4.6-2.1: VRF-lite support added.



# distance (RIP)

**Overview** This command sets the administrative distance for RIP routes. Your device uses this value to select between two or more routes to the same destination obtained from two different routing protocols. The route with the smallest administrative distance value is added to the Forwarding Information Base (FIB). For more information, see the [Route Selection Feature Overview and Configuration Guide](#).

The **no** variant of this command sets the administrative distance for the RIP route to the default of 120.

**Syntax** `distance <1-255> [<ip-addr/prefix-length>]`  
`no distance [<1-255>] [<ip-addr/prefix-length>]`

| Parameter               | Description                                                                                     |
|-------------------------|-------------------------------------------------------------------------------------------------|
| <1-255>                 | The administrative distance value you are setting for this RIP route.                           |
| <ip-addr/prefix-length> | The network IP address and prefix-length that you are changing the administrative distance for. |

**Mode** RIP Router Configuration or RIP Router Address Family Configuration for a VRF instance.

**Examples** To set the administrative distance to 8 for the RIP routes within the 10.0.0.0/8 network, use the commands:

```
awplus# configure terminal
awplus(config)# router rip
awplus(config-router)# distance 8 10.0.0.0/8
```

To set the administrative distance to the default of 120 for the RIP routes within the 10.0.0.0/8 network, use the commands:

```
awplus# configure terminal
awplus(config)# router rip
awplus(config-router)# no distance 8 10.0.0.0/8
```

**Example (VRF-lite)** This example assigns a cost of 10 to the routes for the VRF instance blue, when redistributed into RIP.

```
awplus# configure terminal
awplus(config)# router rip
awplus(config-router)# address family ipv4 blue
awplus(config-router-af)# distance 10
```

**Command changes** Version 5.4.6-2.1: VRF-lite support added.

# distribute-list (RIP)

**Overview** Use this command to filter incoming or outgoing route updates using the prefix-list.

When running VRF-lite, this command can be applied to a specific VRF instance.

Use the **no** variant of this command to disable this feature.

**Syntax** `distribute-list prefix <prefix-list> {in|out} [<interface>]`  
`no distribute-list prefix <prefix-list> {in|out} [<interface>]`

| Parameter     | Description                                                                      |
|---------------|----------------------------------------------------------------------------------|
| prefix        | Filter prefixes in routing updates.                                              |
| <prefix-list> | Specifies the name of the IPv4 prefix-list to use.                               |
| in            | Filter incoming routing updates.                                                 |
| out           | Filter outgoing routing updates.                                                 |
| <interface>   | The interface on which distribute-list applies. For instance: <code>vlan2</code> |

**Default** Disabled

**Mode** RIP Router Configuration or RIP Router Address Family Configuration for a VRF instance.

**Usage** Filter out incoming or outgoing route updates using prefix-list. If you do not specify the name of the interface, the filter will be applied to all interfaces.

**Examples** In this example the following commands are used to apply a prefix list called `myfilter` to filter incoming routing updates in `vlan2`

```
awplus# configure terminal
awplus(config)# router rip
awplus(config-router)# distribute-list prefix myfilter in vlan2
```

**Example (VRF-lite)** This example applies the commands of the previous example, but to a specific VRF named `blue`:

```
awplus# configure terminal
awplus(config)# router rip
awplus(config-router)# address-family ipv4 vrf blue
awplus(config-router-af)# distribute-list prefix myfilter in
vlan2
```

**Command changes** Version 5.4.6-2.1: VRF-lite support added.

# fullupdate (RIP)

**Overview** Use this command to specify which routes RIP should advertise when performing a triggered update. By default, when a triggered update is sent, RIP will only advertise those routes that have changed since the last update. When **fullupdate** is configured, the device advertises the full RIP route table in outgoing triggered updates, including routes that have not changed. This enables faster convergence times, or allows inter-operation with legacy network equipment, but at the expense of larger update messages.

Use the **no** variant of this command to disable this feature.

**Syntax** fullupdate  
no fullupdate

**Default** By default this feature is disabled.

**Mode** RIP Router Configuration or RIP Router Address Family Configuration for a VRF instance.

**Usage (VRF-lite)** If VRF-lite is configured, you can apply this command for either the global routing environment, or to a specific VRF instance.

**Example** To enable the fullupdate (RIP) function, use the commands:

```
awplus# configure terminal
awplus(config)# router rip
awplus(config-router)# fullupdate
```

**Example (VRF-lite)** To enable the full update (RIP) function on the VRF instance named 'blue', use the commands:

```
awplus# configure terminal
awplus(config)# router rip
awplus(config-router)# address-family ipv4 vrf blue
awplus(config-router-af)# fullupdate
```

**Command changes** Version 5.4.6-2.1: VRF-lite support added.

# ip rip authentication key-chain

**Overview** Use this command to enable RIPv2 authentication on an interface and specify the name of the key chain to be used.

Use the **no** variant of this command to disable this function.

**Syntax** `ip rip authentication key-chain <key-chain-name>`  
`no ip rip authentication key-chain`

| Parameter                           | Description                                                                                       |
|-------------------------------------|---------------------------------------------------------------------------------------------------|
| <code>&lt;key-chain-name&gt;</code> | Specify the name of the key chain. This is an alpha-numeric string, but it cannot include spaces. |

**Mode** Interface Configuration for a VLAN interface or a PPP interface.

**Usage** Use this command to perform authentication on the interface. Not configuring the key chain results in no authentication at all.

The AlliedWare Plus™ implementation provides the choice of configuring authentication for single key or multiple keys at different times. Use the [ip rip authentication string](#) command for single key authentication. Use the [ip rip authentication key-chain](#) command for multiple keys authentication. See the [RIP Feature Overview and Configuration Guide](#) for illustrated RIP configuration examples.

For multiple key authentication, use the following steps to configure a route to enable RIPv2 authentication using multiple keys at different times:

- 1) Define a key chain with a key chain name, using the following commands:

```
awplus# configure terminal
awplus(config)# key chain <key-chain-name>
```

- 2) Define a key on this key chain, using the following command:

```
awplus(config-keychain)# key <keyid>
```

- 3) Define the password used by the key, using the following command:

```
awplus(config-keychain-key)# key-string <key-password>
```

- 4) Enable authentication on the desired interface and specify the key chain to be used, using the following commands:

```
awplus# configure terminal
awplus(config)# interface <id>
awplus(config-if)# ip rip authentication key-chain
<key-chain-name>
```

- 5) Specify the mode of authentication for the given interface (text or MD5), using the following command:

```
awplus(config-if)# ip rip authentication mode {md5|text}
```

**Example** In the following example of a configuration for multiple keys authentication, a password “toyota” is set for key 1 in key chain “cars”. Authentication is enabled on vlan2 and the authentication mode is set to MD5:

```
awplus# configure terminal
awplus(config)# key chain cars
awplus(config-keychain)# key 1
awplus(config-keychain-key)# key-string toyota
awplus(config-keychain-key)# accept-lifetime 10:00:00 Oct 08
2016 duration 43200
awplus(config-keychain-key)# send-lifetime 10:00:00 Oct 08 2016
duration 43200
awplus(config-keychain-key)# exit
awplus(config-keychain)# exit
awplus(config)# interface vlan2
awplus(config-if)# ip rip authentication key-chain cars
awplus(config-if)# ip rip authentication mode md5
```

**Example** In the following example, the VLAN interface vlan23 is configured to use key-chain authentication with the keychain “mykey”. See the [key](#) command for a description of how a key chain is created.

```
awplus# configure terminal
awplus(config)# interface vlan23
awplus(config-if)# ip rip authentication key-chain mykey
```

The following example shows md5 authentication configured on the PPP interface ppp0, ensuring authentication of RIP packets received on this interface.

```
awplus# configure terminal
awplus(config)# interface ppp0
awplus(config-if)# ip rip authentication key-chain mykey
```

**Related  
Commands**

[accept-lifetime](#)  
[send-lifetime](#)  
[ip rip authentication mode](#)  
[ip rip authentication string](#)  
[key](#)  
[key chain](#)

# ip rip authentication mode

**Overview** Use this command to specify the type of authentication mode used for RIP v2 packets.

Use the **no** variant of this command to restore clear text authentication.

**Syntax** `ip rip authentication mode {md5|text}`  
`no ip rip authentication mode`

| Parameter | Description                                             |
|-----------|---------------------------------------------------------|
| md5       | Uses the keyed MD5 authentication algorithm.            |
| text      | Specifies clear text or simple password authentication. |

**Default** Text authentication is enabled

**Mode** Interface Configuration for a VLAN interface or a PPP interface.

**Usage** The AlliedWare Plus™ implementation provides the choice of configuring authentication for single key or multiple keys at different times. Use the [ip rip authentication string](#) command for single key authentication. Use the [ip rip authentication key-chain](#) command for multiple keys authentication. See the [RIP Feature Overview and Configuration Guide](#) for illustrated RIP configuration examples.

**Usage: single key** Use the following steps to configure a route to enable RIPv2 authentication using a single key or password:

- 1) Define the authentication string or password used by the key for the desired interface, using the following commands:

```
awplus# configure terminal
awplus(config)# interface <id>
awplus(config-if)# ip rip authentication string
<auth-string>
```

- 2) Specify the mode of authentication for the given interface (text or MD5), using the following commands:

```
awplus# configure terminal
awplus(config)# interface <id>
awplus(config-if)# ip rip authentication mode {md5|text}
```

**Usage: multiple key** For multiple keys authentication, use the following steps to configure a route to enable RIPv2 authentication using multiple keys at different times:

- 1) Define a key chain with a key chain name, using the following commands:

```
awplus# configure terminal
awplus(config)# key chain <key-chain-name>
```

- 2) Define a key on this key chain using the following command:

```
awplus(config-keychain)# key <keyid>
```

- 3) Define the password used by the key, using the following command:

```
awplus(config-keychain-key)# key-string <key-password>
```

- 4) Enable authentication on the desired interface and specify the key chain to be used, using the following commands:

```
awplus(config-if)# ip rip authentication key-chain
<key-chain-name>
```

- 5) Specify the mode of authentication for the given interface (text or MD5), using the following commands:

```
awplus(config-if)# ip rip authentication mode {md5|text}
```

**Example 1** In the following example of a configuration for multiple keys authentication, a password of "toyota" is set for key 1 in key chain "cars". Authentication is enabled on vlan2 and the authentication mode is set to MD5:

```
awplus# configure terminal
awplus(config)# key chain cars
awplus(config-keychain)# key 1
awplus(config-keychain-key)# key-string toyota
awplus(config-keychain-key)# accept-lifetime 10:00:00 Oct 08
2016 duration 43200
awplus(config-keychain-key)# send-lifetime 10:00:00 Oct 08 2016
duration 43200
awplus(config-keychain-key)# exit
awplus(config-keychain)# exit
awplus(config)# interface vlan2
awplus(config-if)# ip rip authentication key-chain cars
awplus(config-if)# ip rip authentication mode md5
```

**Example 2** The following example shows MD5 authentication configured on VLAN interface vlan2, ensuring authentication of RIP packets received on this interface.

```
awplus# configure terminal
awplus(config)# interface vlan2
awplus(config-if)# ip rip authentication mode md5
```

The following example shows md5 authentication configured on the PPP interface ppp0, ensuring authentication of RIP packets received on this interface.

```
awplus# configure terminal
awplus(config)# interface ppp0
awplus(config-if)# ip rip authentication mode md5
```

**Example 3** The following example specifies “mykey” as the authentication string with MD5 authentication, for the VLAN interface vlan2:

```
awplus# configure terminal
awplus(config)# interface vlan2
awplus(config-if)# ip rip authentication string mykey
awplus(config-if)# ip rip authentication mode md5
```

**Related Commands** [ip rip authentication string](#)  
[ip rip authentication key-chain](#)



# ip rip authentication string

**Overview** Use this command to specify the authentication string or password used by a key. Use the **no** variant of this command to remove the authentication string.

**Syntax** `ip rip authentication string <auth-string>`  
`no ip rip authentication string`

| Parameter                        | Description                                                                                               |
|----------------------------------|-----------------------------------------------------------------------------------------------------------|
| <code>&lt;auth-string&gt;</code> | The authentication string or password used by a key. It is an alphanumeric string and can include spaces. |

**Mode** Interface Configuration for a VLAN interface or a PPP interface.

**Usage** The AlliedWare Plus™ implementation provides the choice of configuring authentication for single key or multiple keys at different times. Use this command to specify the password for a single key on an interface. Use the [ip rip authentication key-chain](#) command for multiple keys authentication. For information about configuring RIP, see the [RIP Feature Overview and Configuration Guide](#).

Use the following steps to configure a route to enable RIPv2 authentication using a single key or password:

- 1) Define the authentication string or password used by the key for the desired interface, using the following commands:

```
awplus# configure terminal
awplus(config)# interface <id>
```

- 2) Specify the mode of authentication for the given interface (text or MD5), using the following commands:

```
awplus# configure terminal
awplus(config-if)# ip rip authentication string
<auth-string>
awplus(config)# interface <id>
awplus(config-if)# ip rip authentication mode {md5|text}
```

**Example** See the example below to specify `mykey` as the authentication string with MD5 authentication for the VLAN interface `vlan2`:

```
awplus# configure terminal
awplus(config)# interface vlan2
awplus(config-if)# ip rip authentication string mykey
awplus(config-if)# ip rip authentication mode md5
```

See the example below to specify `mykey` as the authentication string with MD5 authentication for the PPP interface `ppp0`:

```
awplus# configure terminal
awplus(config)# interface ppp0
awplus(config-if)# ip rip authentication string mykey
awplus(config-if)# ip rip authentication mode md5
```

**Example** In the following example, the VLAN interface `vlan2` is configured to have an authentication string as `guest`. Any received RIP packet in that interface should have the same string as password.

```
awplus# configure terminal
awplus(config)# interface vlan2
awplus(config-if)# ip rip authentication string guest
```

In the following example, the PPP interface `ppp0` is configured to have an authentication string as `guest`. Any received RIP packet in that interface should have the same string as password.

```
awplus# configure terminal
awplus(config)# interface ppp0
awplus(config-if)# ip rip authentication string guest
```

**Related commands** [ip rip authentication key-chain](#)  
[ip rip authentication mode](#)

# ip rip receive-packet

**Overview** Use this command to configure the interface to enable the reception of RIP packets.

Use the **no** variant of this command to disable this feature.

**Syntax** ip rip receive-packet  
no ip rip receive-packet

**Default** Receive-packet is enabled

**Mode** Interface Configuration for a VLAN interface or a PPP interface.

**Example** This example shows packet receiving being turned on for the VLAN interface vlan3:

```
awplus# configure terminal
awplus(config)# interface vlan3
awplus(config-if)# ip rip receive-packet
```

This example shows packet receiving being turned on for the PPP interface ppp0:

```
awplus# configure terminal
awplus(config)# interface ppp0
awplus(config-if)# ip rip receive-packet
```

**Related Commands** [ip rip send-packet](#)

# ip rip receive version

**Overview** Use this command to specify the version of RIP packets accepted on an interface and override the setting of the version command.

Use the **no** variant of this command to use the setting specified by the [version \(RIP\)](#) command.

**Syntax** `ip rip receive version {[1][2]}`  
`no ip rip receive version`

| Parameter | Description                                                     |
|-----------|-----------------------------------------------------------------|
| 1         | Specifies acceptance of RIP version 1 packets on the interface. |
| 2         | Specifies acceptance of RIP version 2 packets on the interface. |

**Default** Version 2

**Mode** Interface Configuration for a VLAN interface or a PPP interface.

**Usage** This command applies to a specific VLAN interface and overrides any the version specified by the [version \(RIP\)](#) command.

RIP can be run in version 1 or version 2 mode. Version 2 has more features than version 1; in particular RIP version 2 supports authentication and classless routing. Once the RIP version is set, RIP packets of that version will be received and sent on all the RIP-enabled interfaces.

**Example** In the following example, the VLAN interface `vlan3` is configured to receive both RIP version 1 and 2 packets:

```
awplus# configure terminal
awplus(config)# interface vlan3
awplus(config-if)# ip rip receive version 1 2
```

In the following example, PPP interface `ppp0` is configured to receive both RIP version 1 and 2 packets:

```
awplus# configure terminal
awplus(config)# interface ppp0
awplus(config-if)# ip rip receive version 1 2
```

**Related Commands** [version \(RIP\)](#)

# ip rip send-packet

**Overview** Use this command to enable sending RIP packets through the current interface. Use the **no** variant of this command to disable this feature.

**Syntax** ip rip send-packet  
no ip rip send-packet

**Default** Send packet is enabled

**Mode** Interface Configuration for a VLAN interface or a PPP interface.

**Example** This example shows packet sending being turned on for the VLAN interface vlan4:

```
awplus# configure terminal
awplus(config)# interface vlan4
awplus(config-if)# ip rip send-packet
```

This example shows packet sending being turned on for the PPP interface ppp0:

```
awplus# configure terminal
awplus(config)# interface ppp0
awplus(config-if)# ip rip send-packet
```

**Related Commands** [ip rip receive-packet](#)

# ip rip send version

**Overview** Use this command in Interface Configuration mode to specify the version of RIP packets sent on an interface and override the setting of the [version \(RIP\)](#) command. This mechanism causes RIP version 2 interfaces to send multicast packets instead of broadcasting packets.

Use the **no** variant of this command to use the setting specified by the [version \(RIP\)](#) command.

**Syntax** `ip rip send version {1|2|1 2|2 1}`  
`no ip rip send version`

| Parameter | Description                                                                                |
|-----------|--------------------------------------------------------------------------------------------|
| 1         | Specifies the sending of RIP version 1 packets out of an interface.                        |
| 2         | Specifies the sending of RIP version 2 packets out of an interface.                        |
| 12        | Specifies the sending of both RIP version 1 and RIP version 2 packets out of an interface. |
| 21        | Specifies the sending of both RIP version 2 and RIP version 1 packets out of an interface. |

**Default** RIP version 2 is enabled by default.

**Mode** Interface Configuration for a VLAN interface or a PPP interface.

**Usage** This command applies to a specific interface and overrides the version specified by the [version \(RIP\)](#) command.

RIP can be run in version 1 or version 2 mode. Version 2 has more features than version 1; in particular RIP version 2 supports authentication and classless routing. Once the RIP version is set, RIP packets of that version will be received and sent on all the RIP-enabled interfaces. Selecting version parameters 1 2 or 2 1 sends RIP version 1 and 2 packets.

Use the [ip rip send version 1-compatible](#) command in an environment where you cannot send multicast packets. For example, in environments where multicast is not enabled and where hosts do not listen to multicast.

**Examples** In the following example, the VLAN interface `vlan4` is configured to send both RIP version 1 and 2 packets.

```
awplus# configure terminal
awplus(config)# interface vlan4
awplus(config-if)# ip rip send version 1 2
```

In the following example, the VLAN interface `vlan4` is configured to send both RIP version 2 and 1 packets.

```
awplus# configure terminal
awplus(config)# interface vlan4
awplus(config-if)# ip rip send version 2 1
```

In the following example, the VLAN interface `vlan4` is configured to send RIP version 1 packets only.

```
awplus# configure terminal
awplus(config)# interface vlan4
awplus(config-if)# ip rip send version 1
```

In the following example, the VLAN interface `vlan4` is configured to send RIP version 2 packets only.

```
awplus# configure terminal
awplus(config)# interface vlan4
awplus(config-if)# ip rip send version 2
```

In the following example, the VLAN interface `vlan3` is configured to use the RIP version specified by the `version (RIP)` command.

```
awplus# configure terminal
awplus(config)# interface vlan3
awplus(config-if)# no ip rip send version
```

In the following example, the PPP interface `ppp0` is configured to send both RIP version 1 and 2 packets.

```
awplus# configure terminal
awplus(config)# interface ppp0
awplus(config-if)# ip rip send version 1 2
```

In the following example, the PPP interface `ppp0` is configured to send both RIP version 2 and 1 packets.

```
awplus# configure terminal
awplus(config)# interface ppp0
awplus(config-if)# ip rip send version 2 1
```

In the following example, the PPP interface `ppp0` is configured to send RIP version 1 packets only.

```
awplus# configure terminal
awplus(config)# interface ppp0
awplus(config-if)# ip rip send version 1
```

In the following example, the PPP interface `ppp0` is configured to send RIP version 2 packets only.

```
awplus# configure terminal
awplus(config)# interface ppp0
awplus(config-if)# ip rip send version 2
```

In the following example, the PPP interface `ppp2` is configured to use the RIP version specified by the [version \(RIP\)](#) command.

```
awplus# configure terminal
awplus(config)# interface ppp2
awplus(config-if)# no ip rip send version
```

**Related Commands** [ip rip send version 1-compatible](#)  
[version \(RIP\)](#)



# ip rip send version 1-compatible

**Overview** Use this command in Interface Configuration mode to send RIP version 1 compatible packets from a RIP version 2 interfaces to other RIP Interfaces. This mechanism causes RIP version 2 interfaces to send broadcast packets instead of multicasting packets, and is used in environments where multicast is not enabled or where hosts do not listen to multicast.

Use the **no** variant of this command to use the setting specified by the [version \(RIP\)](#) command, and disable the broadcast of RIP version 2 packets that are sent as broadcast packets.

**Syntax** `ip rip send version 1-compatible`  
`no ip rip send version`

| Parameter    | Description                                                                                                                                                                                                                  |
|--------------|------------------------------------------------------------------------------------------------------------------------------------------------------------------------------------------------------------------------------|
| 1-compatible | Specify this parameter to send RIP version 1 compatible packets from a version 2 RIP interface to other RIP interfaces. This mechanism causes version 2 RIP interfaces to broadcast packets instead of multicasting packets. |

**Default** RIP version 2 is enabled by default.

**Mode** Interface Configuration for a VLAN interface or a PPP interface.

**Usage** This command applies to a specific interface and overrides the version specified by the [version \(RIP\)](#) command.

RIP can be run in version 1 compatible mode. Version 2 has more features than version 1; in particular RIP version 2 supports authentication and classless routing. Once the RIP version is set, RIP packets of that version will be received and sent on all the RIP-enabled interfaces.

Use the [ip rip send version](#) command in an environment where you can send multicast packets. For example, in environments where multicast is enabled and where hosts listen to multicast.

**Examples** In the following example, the VLAN interface `vlan2` is configured to send RIP version 1-compatible packets.

```
awplus# configure terminal
awplus(config)# interface vlan2
awplus(config-if)# ip rip send version 1-compatible
```

In the following example, the VLAN interface `vlan3` is configured to use the RIP version specified by the [version \(RIP\)](#) command.

```
awplus# configure terminal
awplus(config)# interface vlan3
awplus(config-if)# no ip rip send version
```

In the following example, the PPP interface `ppp1` is configured to send RIP version 1-compatible packets; so it broadcasts both RIP version 1 and 2 packets.

```
awplus# configure terminal
awplus(config)# interface ppp1
awplus(config-if)# ip rip send version 1-compatible
```

In the following example, the PPP interface `ppp2` is configured to use the RIP version specified by the [version \(RIP\)](#) command.

```
awplus# configure terminal
awplus(config)# interface ppp2
awplus(config-if)# no ip rip send version
```

**Related  
Commands**    [ip rip send version](#)  
                  [version \(RIP\)](#)

# ip rip split-horizon

**Overview** Use this command to turn on the split-horizon mechanism on the interface. Use the **no** variant of this command to disable this mechanism.

**Syntax**

```
ip rip split-horizon [poisoned]
no ip rip split-horizon
```

| Parameter | Description                                                                         |
|-----------|-------------------------------------------------------------------------------------|
| poisoned  | Performs split-horizon with poison-reverse. See "Usage" below for more information. |

**Default** Split horizon poisoned

**Mode** Interface Configuration for a VLAN interface or a PPP interface.

**Usage** Use this command to avoid including routes in updates sent to the same gateway from which they were learned. Without the **poisoned** parameter, using this command causes routes learned from a neighbor to be omitted from updates sent to that neighbor. With the **poisoned** parameter, using this command causes such routes to be included in updates, but sets their metrics to infinity. This advertises that these routes are not reachable.

**Example** To turn on split horizon poisoned on ppp0, use the following commands:

```
awplus# configure terminal
awplus(config)# interface ppp0
awplus(config-if)# ip rip split-horizon poisoned
```

# key

**Overview** Use this command to manage, add and delete authentication keys in a key-chain. Use the **no** variant of this command to delete the authentication key.

**Syntax** `key <keyid>`  
`no key <keyid>`

| Parameter | Description                           |
|-----------|---------------------------------------|
| <keyid>   | <0-2147483647> Key identifier number. |

**Mode** Keychain Configuration

**Usage** This command allows you to enter the keychain-key mode where a password can be set for the key.

**Example** The following example configures a key number 1 and shows the change into a **keychain- key** command mode prompt.

```
awplus# configure terminal
awplus(config)# key chain mychain
awplus(config-keychain)# key 1
awplus(config-keychain-key)#
```

**Related Commands** [key chain](#)  
[key-string](#)  
[accept-lifetime](#)  
[send-lifetime](#)

# key chain

**Overview** Use this command to enter the key chain management mode and to configure a key chain with a key chain name.

Use the **no** variant of this command to remove the key chain and all configured keys.

**Syntax** `key chain <key-chain-name>`  
`no key chain <key-chain-name>`

| Parameter                           | Description                                  |
|-------------------------------------|----------------------------------------------|
| <code>&lt;key-chain-name&gt;</code> | Specify the name of the key chain to manage. |

**Mode** Global Configuration

**Usage** This command allows you to enter the keychain mode from which you can specify keys on this key chain.

**Example** The following example shows the creation of a key chain named `mychain` and the change into **keychain** mode prompt.

```
awplus# configure terminal
awplus(config)# key chain mychain
awplus(config-keychain)#
```

**Related Commands** [key](#)  
[key-string](#)  
[accept-lifetime](#)  
[send-lifetime](#)

# key-string

**Overview** Use this command to define the password to be used by a key.

Use the **no** variant of this command to remove a password.

**Syntax** `key-string <key-password>`  
`no key-string`

| Parameter                         | Description                                                 |
|-----------------------------------|-------------------------------------------------------------|
| <code>&lt;key-password&gt;</code> | A string of characters to be used as a password by the key. |

**Mode** Keychain-key Configuration

**Usage** Use this command to specify passwords for different keys.

**Examples** In the following example, the password for `key1` in the key chain named `mychain` is set to password **prime**:

```
awplus# configure terminal
awplus(config)# key chain mychain
awplus(config-keychain)# key 1
awplus(config-keychain-key)# key-string prime
```

In the following example, the password for `key1` in the key chain named `mychain` is removed:

```
awplus# configure terminal
awplus(config)# key chain mychain
awplus(config-keychain)# key 1
awplus(config-keychain-key)# no key-string
```

**Related Commands** [key](#)  
[key chain](#)  
[accept-lifetime](#)  
[send-lifetime](#)

# maximum-prefix

**Overview** Use this command to configure the maximum number of RIP routes stored in the routing table.

Use the **no** variant of this command to disable all limiting of the number of RIP routes stored in the routing table.

**Syntax** `maximum-prefix <maxprefix> [<threshold>]`  
`no maximum-prefix`

| Parameter                      | Description                                                                                                  |
|--------------------------------|--------------------------------------------------------------------------------------------------------------|
| <code>&lt;maxprefix&gt;</code> | <code>&lt;1-65535&gt;</code> The maximum number of RIP routes allowed.                                       |
| <code>&lt;threshold&gt;</code> | <code>&lt;1-100&gt;</code> Percentage of maximum routes to generate a warning. The default threshold is 75%. |

**Mode** Router Configuration

**Example** To configure the maximum number of RIP routes to 150, use the following command:

```
awplus# configure terminal
awplus(config)# router rip
awplus(config-router)# maximum-prefix 150
```

# neighbor (RIP)

**Overview** Use this command to specify a neighbor router. It is used for each router to which you wish to send unicast RIP updates.

Use the **no** variant of this command to stop sending unicast updates to the specific router.

**Syntax** `neighbor <ip-address>`  
`no neighbor <ip-address>`

| Parameter                       | Description                                                                                  |
|---------------------------------|----------------------------------------------------------------------------------------------|
| <code>&lt;ip-address&gt;</code> | The IP address of a neighboring router with which the routing information will be exchanged. |

**Default** Disabled

**Mode** Router Configuration

**Usage** Use this command to exchange nonbroadcast routing information. It can be used multiple times for additional neighbors.

The [passive-interface \(RIP\)](#) command disables sending routing updates on an interface. Use the `neighbor` command in conjunction with the [passive-interface \(RIP\)](#) to send routing updates to specific neighbors.

**Example** To specify the neighbor router to 1.1.1.1, use the following command:

```
awplus# configure terminal
awplus(config)# router rip
awplus(config-router)# passive-interface vlan1
awplus(config-router)# neighbor 1.1.1.1
```

**Related Commands** [passive-interface \(RIP\)](#)



# network (RIP)

**Overview** Use this command to activate the transmission of RIP routing information on the defined network.

Use the **no** variant of this command to remove the specified network or VLAN as one that runs RIP.

**Syntax** `network {<network-address>[/<subnet-mask>] | <vlan-name>}`  
`no network {<network-address>[/<subnet-mask>] | <vlan-name>}`

| Parameter                                                                   | Description                                                                                                                                                                                                                                                                                                                                   |
|-----------------------------------------------------------------------------|-----------------------------------------------------------------------------------------------------------------------------------------------------------------------------------------------------------------------------------------------------------------------------------------------------------------------------------------------|
| <code>&lt;network-address&gt;</code><br><code>[/&lt;subnet-mask&gt;]</code> | Specifies the network address to run RIP. Entering a subnet mask (or prefix length) for the network address is optional. Where no mask is entered, the device will attempt to apply a mask that is appropriate to the class (A, B, or C) of the address entered, e.g. an IP address of 10.0.0.0 will have a prefix length of 8 applied to it. |
| <code>&lt;vlan-name&gt;</code>                                              | Specify a VLAN name with up to 32 alphanumeric characters to run RIP.                                                                                                                                                                                                                                                                         |

**Default** Disabled

**Mode** RIP Router Configuration or RIP Router Address Family Configuration for a VRF instance.

**Usage** Use this command to specify networks, or VLANs, to which routing updates will be sent and received. The connected routes corresponding to the specified network, or VLANs, will be automatically advertised in RIP updates. RIP updates will be sent and received within the specified network or VLAN.

When running VRF-lite, this command can be applied to a VRF instance.

**Example** Use the following commands to activate RIP routing updates on network 172.16.20.0/24:

```
awplus# configure terminal
awplus(config)# router rip
awplus(config-router)# network 172.16.20.0/24
```

**Example (VRF-lite)** To activate RIP routing updates on vlan3 for VRF instance 'blue'.

```
awplus# configure terminal
awplus(config)# router rip
awplus(config-router)# address-family ipv4 vrf blue
awplus(config-router-af)# network vlan3
```

**Related  
Commands** `show ip rip`  
`show running-config`  
`clear ip rip route`

**Command  
changes** Version 5.4.6-2.1: VRF-lite support added.

# passive-interface (RIP)

**Overview** Use this command to block RIP broadcasts on the interface.  
Use the **no** variant of this command to disable this function.

**Syntax** `passive-interface <interface>`  
`no passive-interface <interface>`

| Parameter                      | Description                   |
|--------------------------------|-------------------------------|
| <code>&lt;interface&gt;</code> | Specifies the interface name. |

**Default** Disabled

**Mode** RIP Router Configuration or RIP Router Address Family Configuration for a VRF instance.

**Example** Use the following commands to block RIP broadcasts on vlan20:

```
awplus# configure terminal
awplus(config)# router rip
awplus(config-router)# passive-interface vlan20
```

**Example (VRF-lite)** To apply this above example to a specific VRF instance named 'green', use the following commands:

```
awplus# configure terminal
awplus(config)# router rip
awplus(config-router)# address-family ipv4 vrf green
awplus(config-router-af)# passive-interface vlan20
```

**Related Commands** [show ip rip](#)

**Command changes** Version 5.4.6-2.1: VRF-lite support added.

# recv-buffer-size (RIP)

**Overview** Use this command to run-time configure the RIP UDP (User Datagram Protocol) receive-buffer size to improve UDP reliability by avoiding UDP receive buffer overrun.

Use the **no** variant of this command to reset the configured RIP UDP receive-buffer size to the system default (196608 bits).

**Syntax** `recv-buffer-size <8192-2147483647>`  
`no recv-buffer-size [<8192-2147483647>]`

| Parameter                            | Description                                                             |
|--------------------------------------|-------------------------------------------------------------------------|
| <code>&lt;8192-2147483647&gt;</code> | Specify the RIP UDP (User Datagram Protocol) buffer size value in bits. |

**Default** 196608 bits is the system default when reset using the **no** variant of this command.

**Mode** Router Configuration

**Examples** To run-time configure the RIP UDP, use the following commands:

```
awplus# configure terminal
awplus(config)# router rip
awplus(config-router)# recv-buffer-size 23456789
awplus# configure terminal
awplus(config)# router rip
awplus(config-router)# no recv-buffer-size 23456789
```

# redistribute (RIP)

**Overview** Use this command to redistribute information from other routing protocols into RIP.

When using VRF-lite, you can apply this command to a specific VRF instance.

Use the **no** variant of this command to disable the specified redistribution. The parameters **metric** and **route-map** may be used on this command, but have no effect.

**Syntax** `redistribute {connected|static|ospf|bgp} [metric <0-16>]  
[route-map <route-map>]`  
`no redistribute {connected|static|ospf|bgp} [metric] [route-map]`

| Parameter     | Description                                                                                                                                                                                                                                           |
|---------------|-------------------------------------------------------------------------------------------------------------------------------------------------------------------------------------------------------------------------------------------------------|
| route-map     | Optional. Specifies route-map that controls how routes are redistributed.                                                                                                                                                                             |
| <route-map>   | Optional. The name of the route map.                                                                                                                                                                                                                  |
| connected     | Redistribute from connected routes.                                                                                                                                                                                                                   |
| static        | Redistribute from static routes.                                                                                                                                                                                                                      |
| ospf          | Redistribute from Open Shortest Path First (OSPF).                                                                                                                                                                                                    |
| bgp           | Redistribute from Border Gateway Protocol (BGP).                                                                                                                                                                                                      |
| metric <0-16> | Optional. Sets the value of the metric that will be applied to routes redistributed into RIP from other protocols. If a value is not specified, and no value is specified using the <a href="#">default-metric (RIP)</a> command, the default is one. |

**Default** By default, the RIP metric value is set to 1.

**Mode** RIP Router Configuration or RIP Router Address Family Configuration for a VRF instance.

**Example** To apply the metric value 15 to static routes being redistributed into RIP, use the commands:

```
awplus# configure terminal
awplus(config)# router rip
awplus(config-router)# redistribute static metric 15
```

**Example (VRF-lite)** To apply the metric value 15 to static routes in address-family ipv4 VRF instance blue being redistributed into RIP, use the following commands:

```
awplus# configure terminal
awplus(config)# router rip
awplus(config-router)# address-family ipv4 vrf blue
awplus(config-router-af)# redistribute static metric 15
```

**Related Commands** [default-metric \(RIP\)](#)

**Command changes** Version 5.4.6-2.1: VRF-lite support added.

# restart rip graceful

**Overview** Use this command to force the RIP process to restart, and optionally set the grace-period.

**Syntax** `restart rip graceful [grace-period <1-65535>]`

**Mode** Privileged Exec

**Default** The default RIP grace-period is 60 seconds.

**Usage** After this command is executed, the RIP process immediately shuts down. It notifies the system that RIP has performed a graceful shutdown. Routes that have been installed into the route table by RIP are preserved until the specified grace-period expires.

When a **restart rip graceful** command is issued, the RIP configuration is reloaded from the last saved configuration. Ensure you first enter the command `copy running-config startup-config`.

**Example** To apply a restart rip graceful setting, grace-period to 100 seconds use the following commands:

```
awplus# copy running-config startup-config
awplus# restart rip graceful grace-period 100
```

# rip restart grace-period

**Overview** Use this command to change the grace period of RIP graceful restart.  
Use the **no** variant of this command to disable this function.

**Syntax** `rip restart grace-period <1-65535>`  
`no rip restart grace-period <1-65535>`

**Mode** Global Configuration

**Default** The default RIP grace-period is 60 seconds.

**Usage** Use this command to enable the **Graceful Restart** feature on the RIP process.  
Entering this command configures a grace period for RIP.

**Example** `awplus# configure terminal`  
`awplus(config)# rip restart grace-period 200`



# route (RIP)

**Overview** Use this command to add a static RIP route.  
Use the **no** variant of this command to remove a static RIP route.

**Syntax** `route <ip-addr/prefix-length>`  
`no route <ip-addr/prefix-length>`

| Parameter                                  | Description                         |
|--------------------------------------------|-------------------------------------|
| <code>&lt;ip-addr/prefix-length&gt;</code> | The IPv4 address and prefix length. |

**Default** No static RIP route is added by default.

**Mode** RIP Router Configuration or RIP Router Address Family Configuration for a VRF instance.

**Usage** Use this command to add a static RIP route. After adding the RIP route, the route can be checked in the RIP routing table.

**Example** To create a static RIP route to IP subnet 192.168.1.0/24, use the following commands:

```
awplus# configure terminal
awplus(config)# router rip
awplus(config-router)# route 192.168.1.0/24
```

**Example (VRF-lite)** To create a static RIP route to IP subnet 192.168.1.0/24, for the VRF instance red, use the following commands

```
awplus# configure terminal
awplus(config)# router rip
awplus(config-router)# address-family ipv4 vrf red
awplus(config-router-af)# route 192.168.1.0/24
```

**Related Commands** [show ip rip](#)  
[clear ip rip route](#)

**Command changes** Version 5.4.6-2.1: VRF-lite support added.

# router rip

**Overview** Use this global command to enter Router Configuration mode to enable the RIP routing process.

Use the **no** variant of this command to disable the RIP routing process.

**Syntax** `router rip`  
`no router rip`

**Mode** Global Configuration

**Example** This command is used to begin the RIP routing process:

```
awplus# configure terminal
awplus(config)# router rip
awplus(config-router)# version 1
awplus(config-router)# network 10.10.10.0/24
awplus(config-router)# network 10.10.11.0/24
awplus(config-router)# neighbor 10.10.10.10
```

**Related  
Commands** [network \(RIP\)](#)  
[version \(RIP\)](#)

# send-lifetime

**Overview** Use this command to specify the time period during which the authentication key on a key chain can be sent.

**Syntax** `send-lifetime <start-date> {<end-date>|  
duration <seconds>|infinite}`  
`no send-lifetime`

| Parameter                       | Description                                                                                                                                                                                                  |
|---------------------------------|--------------------------------------------------------------------------------------------------------------------------------------------------------------------------------------------------------------|
| <code>&lt;start-date&gt;</code> | Specifies the start time and date in the format:<br><code>&lt;hh:mm:ss&gt; &lt;day&gt; &lt;month&gt; &lt;year&gt;</code> or<br><code>&lt;hh:mm:ss&gt; &lt;month&gt; &lt;day&gt; &lt;year&gt;</code> , where: |
| <code>&lt;hh:mm:ss&gt;</code>   | The time of the day, in hours, minutes and seconds                                                                                                                                                           |
| <code>&lt;day&gt;</code>        | <1-31> The day of the month                                                                                                                                                                                  |
| <code>&lt;month&gt;</code>      | The month of the year (the first three letters of the month, for example, Jan)                                                                                                                               |
| <code>&lt;year&gt;</code>       | <1993-2035> The year                                                                                                                                                                                         |
| <code>&lt;end-date&gt;</code>   | Specifies the end time and date in the format:<br><code>&lt;hh:mm:ss&gt; &lt;day&gt; &lt;month&gt; &lt;year&gt;</code> or<br><code>&lt;hh:mm:ss&gt; &lt;month&gt; &lt;day&gt; &lt;year&gt;</code> , where:   |
| <code>&lt;hh:mm:ss&gt;</code>   | The time of the day, in hours, minutes and seconds                                                                                                                                                           |
| <code>&lt;day&gt;</code>        | <1-31> The day of the month                                                                                                                                                                                  |
| <code>&lt;month&gt;</code>      | The month of the year (the first three letters of the month, for example, Jan)                                                                                                                               |
| <code>&lt;year&gt;</code>       | <1993-2035> The year                                                                                                                                                                                         |
| <code>&lt;seconds&gt;</code>    | <1-2147483646> Duration of the key in seconds.                                                                                                                                                               |
| <code>infinite</code>           | Never expires.                                                                                                                                                                                               |

**Mode** Keychain-key Configuration

**Example** The following example shows the setting of send-lifetime for key 1 on the key chain named "mychain".

```
awplus# configure terminal
awplus(config)# key chain mychain
awplus(config-keychain)# key 1
awplus(config-keychain-key)# send-lifetime 03:03:01 Jan 3 2016
04:04:02 Dec 6 2016
```

**Related  
Commands** [key](#)  
[key-string](#)  
[key chain](#)  
[accept-lifetime](#)

# show debugging rip

**Overview** Use this command to display the RIP debugging status for these debugging options: nsm debugging, RIP event debugging, RIP packet debugging and RIP nsm debugging.

For information on filtering and saving command output, see the [“Getting Started with AlliedWare Plus” Feature Overview and Configuration Guide](#).

**Syntax** `show debugging rip`

**Mode** User Exec and Privileged Exec

**Usage** Use this command to display the debug status of RIP.

**Example** `awplus# show debugging rip`

# show ip protocols rip

**Overview** Use this command to display RIP process parameters and statistics.  
For information on filtering and saving command output, see the [“Getting Started with AlliedWare Plus” Feature Overview and Configuration Guide](#).

**Syntax** `show ip protocols rip`

**Mode** User Exec and Privileged Exec

**Example** `awplus# show ip protocols rip`

**Output** Figure 27-1: Example output from the **show ip protocols rip** command

```
Routing Protocol is "rip"
Sending updates every 30 seconds with +/-50%, next due in 12
seconds
Timeout after 180 seconds, garbage collect after 120 seconds
Outgoing update filter list for all interface is not set
Incoming update filter list for all interface is not set
Default redistribution metric is 1
Redistributing: connected static
Default version control: send version 2, receive version 2
Interface Send Recv Key-chain
 vlan25 2 2
Routing for Networks:
 10.10.0.0/24
Routing Information Sources:
 Gateway BadPackets BadRoutes Distance Last Update
Distance: (default is 120
```

# show ip rip

**Overview** Use this command to show RIP routes.

For information on filtering and saving command output, see the [“Getting Started with AlliedWare Plus” Feature Overview and Configuration Guide](#).

**Syntax** `show ip rip`

**Mode** User Exec and Privileged Exec

**Example** `awplus# show ip rip`

**Output** Figure 27-2: Example output from the **show ip rip** command

```
awplus#show ip rip
Codes: R - RIP, Rc - RIP connected, Rs - RIP static
 C - Connected, S - Static, O - OSPFNetwork Next Hop
Metric From If Time
C 10.0.1.0/24 1 vlan20
S 10.10.10.0/24 1 vlan20
C 10.10.11.0/24 1 vlan20
S 192.168.101.0/24 1 vlan20
R 192.192.192.0/24 1 --
```

**Related Commands** [route \(RIP\)](#)  
[network \(RIP\)](#)

[clear ip rip route](#)  
[show ip rip vrf interface](#)

**Command changes** Version 5.4.6-2.1: VRF-lite support added.

# show ip rip database

**Overview** Use this command to display information about the RIP database.

For information on filtering and saving command output, see the [“Getting Started with AlliedWare Plus” Feature Overview and Configuration Guide](#).

**Syntax** `show ip rip database [full]`

| Parameter | Description                                                     |
|-----------|-----------------------------------------------------------------|
| full      | Specify the full RIP database including sub-optimal RIP routes. |

**Mode** User Exec and Privileged Exec

**Example**  
`awplus# show ip rip database`  
`awplus# show ip rip database full`

**Related Commands** [show ip rip](#)



# show ip rip interface

**Overview** Use this command to display information about the RIP interfaces. You can specify an interface name to display information about a specific interface.

**Syntax** `show ip rip interface [<interface>]`

| Parameter   | Description                                                                    |
|-------------|--------------------------------------------------------------------------------|
| <interface> | The interface to display information about. For instance: <code>vlan2</code> . |

**Mode** User Exec and Privileged Exec

**Example** `awplus# show ip rip interface`

# show ip rip vrf database

**Overview** Use this command to display information about the RIP database that is associated with a specific VRF instance.

Entering this command with the **full** option included, will display information about the full RIP database (including sub-optimal routes) associated with a specific VRF instance.

For information on filtering and saving command output, see the [“Getting Started with AlliedWare Plus” Feature Overview and Configuration Guide](#).

**Syntax** `show ip rip {vrf <vrf-name>|global} database [full]`

| Parameter  | Description                                                     |
|------------|-----------------------------------------------------------------|
| vrf        | Specific VRF instance.                                          |
| <vrf-name> | The name of the VRF instance.                                   |
| global     | The global routing and forwarding table.                        |
| full       | Specify the full RIP database including sub-optimal RIP routes. |

**Mode** User Exec and Privileged Exec

**Example** To display information about the RIP database associated with a VRF instance 'blue', use the command:

```
awplus# show ip rip vrf blue database
```

**Output** Figure 27-3: Example output from the **show ip rip vrf blue database** command

```
Codes: R - RIP, Rc - RIP connected, Rs - RIP static
 C - Connected, S - Static, O - OSPF, B - BGP
```

| Network            | Next Hop     | Metric | From         | If    | Time  |
|--------------------|--------------|--------|--------------|-------|-------|
| Rc 192.168.30.0/24 |              | 1      |              | vlan3 |       |
| R 192.168.45.0/24  | 192.168.30.1 | 2      | 192.168.30.1 | vlan3 | 02:46 |

**Related Commands** [show ip rip](#)

**Command changes** Version 5.4.6-2.1: VRF-lite support added.

# show ip rip vrf interface

**Overview** Use this command to display information about the RIP interfaces that are associated with a specific VRF instance.

For information on filtering and saving command output, see the [“Getting Started with AlliedWare Plus” Feature Overview and Configuration Guide](#).

**Syntax** `show ip rip {vrf <vrf-name>|global} interface [<interface-name>]`

| Parameter        | Description                              |
|------------------|------------------------------------------|
| vrf              | Specific VRF instance.                   |
| <vrf-name>       | The name of the VRF instance.            |
| global           | The global routing and forwarding table. |
| <interface-name> | The IP RIP interface (VLAN).             |

**Mode** User Exec and Privileged Exec

**Example** To display information about the RIP database associated with a VRF instance 'blue', use the command:

```
awplus# show ip rip vrf blue interface
```

**Output** Figure 27-4: Example output from **show ip rip vrf blue interface vlan3**

```
Codes: R - RIP, Rc - RIP connected, Rs - RIP static
 C - Connected, S - Static, O - OSPF, B - BGP
```

| Network            | Next Hop     | Metric | From         | If    | Time  |
|--------------------|--------------|--------|--------------|-------|-------|
| Rc 192.168.30.0/24 |              | 1      |              | vlan3 |       |
| R 192.168.45.0/24  | 192.168.30.1 | 2      | 192.168.30.1 | vlan3 | 02:46 |

**NOTE:** The Time parameter operates as follows:

- RIP updates occur approximately every 30 seconds.
- Each update resets a count-down timer to 180 seconds (3 minutes).
- The Time parameter displays the count-down from the last reset.

**Related Commands** [show ip rip](#)

**Command changes** Version 5.4.6-2.1: VRF-lite support added.

# timers (RIP)

**Overview** Use this command to adjust routing network timers.  
Use the **no** variant of this command to restore the defaults.

**Syntax** `timers basic <update> <timeout> <garbage>`  
`no timers basic`

| Parameter                    | Description                                                                                                                                                                                                                          |
|------------------------------|--------------------------------------------------------------------------------------------------------------------------------------------------------------------------------------------------------------------------------------|
| <code>&lt;update&gt;</code>  | <code>&lt;5-2147483647&gt;</code><br>Specifies the period at which RIP route update packets are transmitted. The default is 30 seconds.                                                                                              |
| <code>&lt;timeout&gt;</code> | <code>&lt;5-2147483647&gt;</code><br>Specifies the routing information timeout timer in seconds. The default is 180 seconds. After this interval has elapsed and no updates for a route are received, the route is declared invalid. |
| <code>&lt;garbage&gt;</code> | <code>&lt;5-2147483647&gt;</code><br>Specifies the routing garbage collection timer in seconds. The default is 120 seconds.                                                                                                          |

**Default** Enabled

**Mode** RIP Router Configuration or RIP Router Address Family Configuration for a VRF instance.

**Usage** This command adjusts the RIP timing parameters.

The update timer is the time between sending out updates, that contain the complete routing table, to every neighboring router.

If an update for a given route has not been seen for the time specified by the timeout parameter, that route is no longer valid. However, it is retained in the routing table for a short time, with metric 16, so that neighbors are notified that the route has been dropped.

When the time specified by the garbage parameter expires the metric 16 route is finally removed from the routing table. Until the garbage time expires, the route is included in all updates sent by the router.

All the routers in the network must have the same timers to ensure the smooth operation of RIP throughout the network.

**Examples** To set the update timer to 30, the routing information timeout timer to 180, and the routing garbage collection timer to 120, use the following command:

```
awplus# configure terminal
awplus(config)# router rip
awplus(config-router)# timers basic 30 180 120
```

To set the update timer to 30, the routing information timeout timer to 180, and the routing garbage collection timer to 120 with VRF, use the following command:

```
awplus# configure terminal
awplus(config)# router rip
awplus(config-router)# address-family ipv4 vrf blue
awplus(config-router-af)# timers basic 30 180 120
```

**Command changes** Version 5.4.6-2.1: VRF-lite support added.

# undebg rip

**Overview** Use this command to disable the options set for debugging information of RIP events, packets and communication between RIP and NSM.

This command has the same effect as the **no debug rip** command.

**Syntax** `undebg rip {all|events|nsm|<packet>}`

| Parameter | Description                                                           |
|-----------|-----------------------------------------------------------------------|
| all       | Disables all RIP debugging.                                           |
| events    | Disables the logging of RIP events.                                   |
| nsm       | Disables the logging of RIP and NSM communication.                    |
| <packet>  | packet [recv send] [detail]<br>Disables the debugging of RIP packets. |
| recv      | Disables the logging of received packet information.                  |
| send      | Disables the logging of sent packet information.                      |
| detail    | Disables the logging of sent or received RIP packets.                 |

**Mode** Privileged Exec

**Example** To disable the options set for debugging RIP information events, use the following command:

```
awplus# undebg rip packet
```

**Related Commands** [debug rip](#)

# version (RIP)

**Overview** Use this command to specify a RIP version used globally by the router. If VRF-lite is configured, you can specify a RIP version either globally, or for a particular VRF instance. Use the **no** variant of this command to restore the default version.

**Syntax** `version {1|2}`  
`no version`

| Parameter | Description                              |
|-----------|------------------------------------------|
| 1 2       | Specifies the version of RIP processing. |

**Default** Version 2

**Mode** RIP Router Configuration or RIP Router Address Family Configuration for a VRF instance.

**Usage** RIP can be run in version 1 or version 2 mode. Version 2 has more features than version 1; in particular RIP version 2 supports authentication and classless routing. Once the RIP version is set, RIP packets of that version will be received and sent on all the RIP-enabled interfaces.

Setting the version command has no impact on receiving updates, only on sending them. The `ip rip send version` command overrides the value set by the `version (RIP)` command on an interface-specific basis. The `ip rip receive version` command allows you to configure a specific interface to accept only packets of the specified RIP version. The `ip rip receive version` command and the `ip rip send version` command override the value set by this command.

**Examples** To specify a RIP version, use the following commands:

```
awplus# configure terminal
awplus(config)# router rip
awplus(config-router)# version 1
```

To specify a RIP version with VRF, use the following commands:

```
awplus# configure terminal
awplus(config)# router rip
awplus(config-router)# address-family ipv4 vrf blue
awplus(config-router-af)# version 1
```

**Related Commands** [ip rip receive version](#)  
[ip rip send version](#)  
[show running-config](#)

**Command changes** Version 5.4.6-2.1: VRF-lite support added.



# 28

# RIPng for IPv6 Commands

## Introduction

**Overview** This chapter contains RIPng commands. RIPng (Routing Information Protocol next generation) is an extension of RIPv2 to support IPv6. RFC 2080 specifies RIPng. The differences between RIPv2 and RIPng are:

- RIPng does not support RIP updates authentication
- RIPng does not allow the attachment of arbitrary tags to routes
- RIPng requires the encoding of the next-hop for a set of routes

For more information, see the [RIPng Feature Overview and Configuration Guide](#).

- Command List**
- [“aggregate-address \(IPv6 RIPng\)”](#) on page 907
  - [“clear ipv6 rip route”](#) on page 908
  - [“debug ipv6 rip”](#) on page 909
  - [“default-information originate \(IPv6 RIPng\)”](#) on page 910
  - [“default-metric \(IPv6 RIPng\)”](#) on page 911
  - [“distribute-list \(IPv6 RIPng\)”](#) on page 912
  - [“ipv6 rip metric-offset”](#) on page 913
  - [“ipv6 rip split-horizon”](#) on page 915
  - [“ipv6 router rip”](#) on page 917
  - [“neighbor \(IPv6 RIPng\)”](#) on page 918
  - [“passive-interface \(IPv6 RIPng\)”](#) on page 919
  - [“recv-buffer-size \(IPv6 RIPng\)”](#) on page 920
  - [“redistribute \(IPv6 RIPng\)”](#) on page 921
  - [“route \(IPv6 RIPng\)”](#) on page 922
  - [“router ipv6 rip”](#) on page 923

- [“show debugging ipv6 rip”](#) on page 924
- [“show ipv6 protocols rip”](#) on page 925
- [“show ipv6 rip”](#) on page 926
- [“show ipv6 rip database”](#) on page 927
- [“show ipv6 rip interface”](#) on page 928
- [“timers \(IPv6 RIPng\)”](#) on page 929
- [“undebug ipv6 rip”](#) on page 930

# aggregate-address (IPv6 RIPng)

**Overview** Use this command to add an aggregate route to RIPng.  
Use the **no** variant of this command to remove the aggregate route from RIPng.

**Syntax** `aggregate-address <ipv6-addr/prefix-length>`  
`no aggregate-address <ipv6-addr/prefix-length>`

| Parameter                                    | Description                                                                                                                           |
|----------------------------------------------|---------------------------------------------------------------------------------------------------------------------------------------|
| <code>&lt;ipv6-addr/prefix-length&gt;</code> | Specify the IPv6 Address in the format <code>X:X::X:/Prefix-Length</code> . The prefix-length is a decimal integer between 1 and 128. |

**Mode** Router Configuration

**Usage** The route will not be added to the RIPng database unless the database contains at least one route which is contained within the address range covered by the aggregate route. As soon as there are any such component routes in the RIPng database, then the following occurs:

- the aggregate route is added to the RIPng database
- all the component routes that are within the address range covered by the aggregate route are retained in the RIPng database, but are marked as suppressed routes. The aggregate route will be advertised in RIPng updates, and the component route will no longer be advertised.

Note that simply having a component route in the IPv6 route database is not a sufficient condition for the aggregate route to be included into the RIPng database. The component route(s) must be in the RIPng database before the aggregate route will be included in the RIPng database. There is no restriction on the method by which the component routes have arrived into the RIPng database, it can be by being connected RIP interfaces, by redistribution or by direct inclusion using the **route** command in router IPv6 RIP configuration mode.

**Example**

```
awplus# configure terminal
awplus(config)# router ipv6 rip
awplus(config-router)# aggregate-address 2001:db8::/32
```

# clear ipv6 rip route

**Overview** Use this command to clear specific data from the RIPng routing table.

**Syntax** `clear ipv6 rip route`  
{<ipv6-addr/prefix-length>|all|connected|rip|static|ospf}

| Parameter                     | Description                                                                                                                                                                                                   |
|-------------------------------|---------------------------------------------------------------------------------------------------------------------------------------------------------------------------------------------------------------|
| <ipv6-addr/<br>prefix-length> | Specify the IPv6 Address in format X:X::X:Prefix-Length. The prefix-length is a decimal integer between 1 and 128. Removes entries which exactly match this destination address from the RIPng routing table. |
| connected                     | Removes redistributed connected entries from RIPng routing table.                                                                                                                                             |
| static                        | Removes redistributed static entries from the RIPng routing table.                                                                                                                                            |
| rip                           | Removes RIPng routes from the RIPng routing table.                                                                                                                                                            |
| ospf                          | Removes redistributed OSPFv3 routes from the RIPng routing table.                                                                                                                                             |
| all                           | Clears the entire RIPng routing table.                                                                                                                                                                        |

**Mode** Privileged Exec

**Example** `awplus# clear ipv6 rip route all`  
`awplus# clear ipv6 rip route 2001:db8::/32`

# debug ipv6 rip

**Overview** Use this command to enable RIPng debugging and specify debugging for RIPng events, RIPng packets, or RIPng communication with NSM processes.

Use the **no** variant of this command to disable RIPng debugging.

**Syntax** `debug ipv6 rip [all|events|nsm|packet [detail]|recv [detail]|send [detail]]`  
`no debug ipv6 rip [all|events|nsm|packet [detail]|recv [detail]|send [detail]]`

| Parameter | Description                                                                                                                                  |
|-----------|----------------------------------------------------------------------------------------------------------------------------------------------|
| all       | Displays all RIPng debugging showing RIPng events debug information, RIPng received packets information, and RIPng sent packets information. |
| events    | Displays RIPng events debug information.                                                                                                     |
| nsm       | Displays RIPng and NSM communication.                                                                                                        |
| packet    | Displays RIPng packets only.                                                                                                                 |
| recv      | Displays information for received packets.                                                                                                   |
| send      | Displays information for sent packets.                                                                                                       |
| detail    | Displays detailed information for the sent or received packet.                                                                               |

**Default** RIPng debugging is disabled by default.

**Mode** Privileged Exec and Global Configuration

**Example** `awplus# debug ipv6 rip events`  
`awplus# debug ipv6 rip packet send detail`  
`awplus# debug ipv6 rip nsm`

**Related Commands** [undebug ipv6 rip](#)

# default-information originate (IPv6 RIPng)

**Overview** Use this command to generate a default route into RIPng.  
Use the **no** variant of this command to disable this feature.

**Syntax** default-information originate  
no default-information originate

**Default** Disabled

**Mode** Router Configuration

**Example** awplus# configure terminal  
awplus(config)# router ipv6 rip  
awplus(config-router)# default-information originate

# default-metric (IPv6 RIPng)

**Overview** Use this command to specify the metrics to be assigned to redistributed RIPng routes.

Use the **no** variant of this command to reset the RIPng metric back to its default (1).

**Syntax** `default-metric <1-16>`  
`no default-metric [<1-16>]`

| Parameter | Description   |
|-----------|---------------|
| <1-16>    | Metric value. |

**Default** By default, the RIPng metric value is set to 1.

**Mode** Router Configuration

**Usage** This command is used with the [redistribute \(IPv6 RIPng\)](#) command to make the routing protocol use the specified metric value for all redistributed RIPng routes, regardless of the original protocol that the route has been redistributed from.

Note, this metric is not applied to routes that are brought into RIPng by using the **route** command in router IPv6 RIP configuration mode. This metric is, though, applied to any RIPng aggregate routes that have been brought into the RIPng database due to the presence of a component route that was redistributed into RIPng.

Also note that the default-metric is applied to routes redistributed into RIPng with no metric assignment in the routemap associated with redistribution.

**Example**

```
awplus# configure terminal
awplus(config)# router ipv6 rip
awplus(config-router)# default-metric 8
```

**Related Commands** [ipv6 rip metric-offset](#)  
[redistribute \(IPv6 RIPng\)](#)

# distribute-list (IPv6 RIPng)

**Overview** Use this command to filter incoming or outgoing route updates using the prefix-list.

Use the **no** variant of this command to disable this feature.

**Syntax** `distribute-list [prefix <prefix-list-name>] [in|out]  
[<interface>]`  
`no distribute-list [prefix <prefix-list-name>] [in|out]  
[<interface>]`

| Parameter                             | Description                                                                          |
|---------------------------------------|--------------------------------------------------------------------------------------|
| <code>&lt;prefix-list-name&gt;</code> | Filter prefixes in routing updates. Specify the name of the IPv6 prefix-list to use. |
| <code>&lt;interface&gt;</code>        | The interface for which distribute-list applies. For instance: <code>vlan2</code> .  |
| <code>in</code>                       | Filter incoming routing updates.                                                     |
| <code>out</code>                      | Filter outgoing routing updates.                                                     |

**Default** Disabled

**Mode** Router Configuration

**Usage** Filter out incoming or outgoing route updates using the prefix-list. If you do not specify the name of the interface, the filter is applied to all the interfaces.

**Example** To filter incoming or outgoing route updates, use the following commands:

```
awplus# configure terminal
awplus(config)# router ipv6 rip
awplus(config-router)# distribute-list prefix myfilter in vlan2
```

**Related Commands** [ipv6 nd prefix](#)



# ipv6 rip metric-offset

**Overview** Use this command to increment the metric value on incoming routes for a specified interface. This command can be used to artificially inflate the metric value for routes learned on the specified interface. Routes learned on the specified interface are only used if the routes to the same destination with a lower metric value in the routing table are down.

Use the **no** variant of this command to reset the metric value on incoming routes to the default value (1). You can set the metric value for redistributed routes with [default-metric \(IPv6 RIPng\)](#) and [redistribute \(IPv6 RIPng\)](#) commands in Router Configuration mode.

**Syntax** `ipv6 rip metric-offset <1-16>`  
`no ipv6 rip metric-offset <1-16>`

| Parameter | Description                                                                                                                      |
|-----------|----------------------------------------------------------------------------------------------------------------------------------|
| <1-16>    | Specify an increment to the metric value on an incoming route. The metric value for RIPng routes is the hop count for the route. |

**Default** The default RIPng metric value is 1.

**Mode** Interface Configuration for a VLAN interface or a PPP interface.

**Usage** When a RIPng route is received on a VLAN interface, the metric value for the interface set by this command is added to the metric value of the route in the routing table. Note this command only increments the metric for incoming routes on a specified interface. Increasing the metric value for a VLAN interface increases the metric value of routes received on that VLAN interface. This changes the route selected from the routing table.

The RIPng metric is the hop count. At regular intervals of the routing update timer (which has a default value of 30 seconds), and at the time of change in the topology, the RIPng router sends update messages to other routers. The listening routers update their route table with the new route, and increase the metric value of the path by one (referred to as a hop count). The router recognizes the IPv6 address advertising router as the next hop, then sends the routing updates to other routers. A maximum allowable hop count is 15. If a router reaches a metric value of 16 or more, the destination is identified as unreachable.

For information about how AlliedWare Plus adds routes, see the [“Route Selection” Feature Overview and Configuration Guide](#). See also the [default-metric \(IPv6 RIPng\)](#) and [redistribute \(IPv6 RIPng\)](#) commands to specify the metric for redistributed RIPng routes.

**Examples** To increment the metric-offset on the VLAN interface `vlan2`, enter the below commands:

```
awplus# configure terminal
awplus(config)# router ipv6 rip
awplus(config-router)# exit
awplus(config)# interface vlan2
awplus(config-if)# ipv6 rip metric-offset 1
```

To reset the metric-offset on the VLAN interface `vlan2` to the default value, enter the below commands:

```
awplus# configure terminal
awplus(config)# interface vlan2
awplus(config-if)# no ipv6 rip metric-offset 1
```

To increment the metric-offset on the PPP interface `ppp0`, enter the below commands:

```
awplus# configure terminal
awplus(config)# router ipv6 rip
awplus(config-router)# exit
awplus(config)# interface ppp0
awplus(config-if)# ipv6 rip metric-offset
```

To reset the metric-offset on the PPP interface `ppp0` to the default value, enter the below commands:

```
awplus# configure terminal
awplus(config)# interface ppp0
awplus(config-if)# no ipv6 router rip
```

**Validation Commands** [show running-config](#)

**Related Commands** [default-metric \(IPv6 RIPng\)](#)

# ipv6 rip split-horizon

**Overview** Use this command to perform the split-horizon action on the interface. The default is split-horizon with poisoned reverse.

Use the **no** variant of this command to disable this function.

**Syntax** `ipv6 rip split-horizon [poisoned]`  
`no ipv6 rip split-horizon`

| Parameter                  | Description                                    |
|----------------------------|------------------------------------------------|
| <code>split-horizon</code> | Perform split-horizon without poisoned reverse |
| <code>poisoned</code>      | Performs split-horizon with poisoned reverse.  |

**Default** Split-horizon with poisoned reverse is the default.

**Mode** Interface Configuration for a VLAN interface or a PPP interface.

**Usage** Use this command to avoid including routes in updates sent to the same gateway from which they were learned. Using the **split horizon** command omits routes learned from one neighbor, in updates sent to that neighbor. Using the **poisoned** parameter with this command includes such routes in updates, but sets their metrics to infinity. Thus, advertising that these routes are not reachable.

**Examples** To perform split-horizon with poisoned reverse on the VLAN interface `vlan2`, enter the below commands:

```
awplus# configure terminal
awplus(config)# router ipv6 rip
awplus(config-router)# exit
awplus(config)# interface vlan2
awplus(config-if)# ipv6 rip split-horizon poisoned
```

To disable split-horizon on the VLAN interface `vlan2`, enter the below commands:

```
awplus# configure terminal
awplus(config)# interface vlan2
awplus(config-if)# no ipv6 rip split-horizon
```

To perform split-horizon with poisoned reverse on the PPP interface `ppp0`, enter the below commands:

```
awplus# configure terminal
awplus(config)# router ipv6 rip
awplus(config-router)# exit
awplus(config)# interface ppp0
awplus(config-if)# ipv6 rip split-horizon poisoned
```

To disable split-horizon on the PPP interface ppp0, enter the below commands:

```
awplus# configure terminal
awplus(config)# interface ppp0
awplus(config-if)# no ipv6 router rip
```

**Validation  
Commands** [show running-config](#)

# ipv6 router rip

**Overview** Use this command to enable RIPng routing on an interface.  
Use the **no** variant of this command to disable RIPng routing on an interface.

**Syntax** `ipv6 router rip`  
`no ipv6 router rip`

**Default** RIPng routing is disabled by default.

**Mode** Interface Configuration for a VLAN interface or a PPP interface.

**Usage** This command can only be configured on VLAN interfaces.

**Examples** To enable RIPng routing on the VLAN interface `vlan2`, enter the below commands:

```
awplus# configure terminal
awplus(config)# router ipv6 rip
awplus(config-router)# exit
awplus(config)# interface vlan2
awplus(config-if)# ipv6 router rip
```

To disable RIPng routing on the VLAN interface `vlan2`, enter the below commands:

```
awplus# configure terminal
awplus(config)# interface vlan2
awplus(config-if)# no ipv6 router rip
```

To enable RIPng routing on the PPP interface `ppp0`, enter the below commands:

```
awplus# configure terminal
awplus(config)# router ipv6 rip
awplus(config-router)# exit
awplus(config)# interface ppp0
awplus(config-if)# ipv6 router rip
```

To disable RIPng routing on the PPP interface `ppp0`, enter the below commands:

```
awplus# configure terminal
awplus(config)# interface ppp0
awplus(config-if)# no ipv6 router rip
```

# neighbor (IPv6 RIPng)

**Overview** Use this command to specify a neighbor router.  
Use the **no** variant of this command to disable the specific router.

**Syntax** `neighbor <ipv6-link-local-addr> <interface>`  
`no neighbor <ipv6-link-local-addr> <interface>`

| Parameter                                 | Description                                                                                                                |
|-------------------------------------------|----------------------------------------------------------------------------------------------------------------------------|
| <code>&lt;ipv6-link-local-addr&gt;</code> | Specify the link-local IPv6 address (in the format X:X::X:X) of a neighboring router to exchange routing information with. |
| <code>&lt;interface&gt;</code>            | The interface. For instance: <code>vlan2</code> .                                                                          |

**Mode** Router Configuration

**Usage** Use this command to exchange non broadcast routing information. It can be used multiple times for additional neighbors.

The [passive-interface \(IPv6 RIPng\)](#) command disables sending routing updates on an interface. Use the `neighbor` command in conjunction with the [passive-interface \(IPv6 RIPng\)](#) command to send routing updates to specific neighbors.

**Examples**

```
awplus# configure terminal
awplus(config)# router ipv6 rip
awplus(config-router)# neighbor 2001:db8:1::1 vlan2
awplus# configure terminal
awplus(config)# router ipv6 rip
awplus(config-router)# no neighbor 2001:db8:1::1 vlan2
```

**Related Commands** [passive-interface \(IPv6 RIPng\)](#)

## passive-interface (IPv6 RIPng)

**Overview** Use this command to enable suppression of routing updates on an interface. Use the **no** variant of this command to disable this function.

**Syntax** `passive-interface <interface>`  
`no passive-interface <interface>`

| Parameter                      | Description                                       |
|--------------------------------|---------------------------------------------------|
| <code>&lt;interface&gt;</code> | The interface. For instance: <code>vlan2</code> . |

**Default** Disabled

**Mode** Router Configuration

**Examples** To enable suppression of routing updates, use the following commands:

```
awplus# configure terminal
awplus(config)# router ipv6 rip
awplus(config-router)# passive-interface vlan2
awplus# configure terminal
awplus(config)# router ipv6 rip
awplus(config-router)# no passive-interface vlan2
```

## recv-buffer-size (IPv6 RIPng)

**Overview** Use this command to configure the RIPng UDP (User Datagram Protocol) receive-buffer size. This should improve UDP reliability by avoiding UDP receive buffer overruns.

Use the **no** variant of this command to unset the configured RIPng UDP receive-buffer size and set it back to the system default of 196608 bits.

**Syntax** `recv-buffer-size <8192-2147483647>`  
`no recv-buffer-size [<8192-2147483647>]`

**Default** The RIPng UDP receive-buffer-size is 196608 bits by default, and is reset to the default using the **no** variant of this command.

**Mode** Router Configuration

**Examples** To configure the RIPng UPD, use the following commands:

```
awplus# configure terminal
awplus(config)# router ipv6 rip
awplus(config-router)# recv-buffer-size 23456789
awplus# configure terminal
awplus(config)# router ipv6 rip
awplus(config-router)# no recv-buffer-size 23456789
awplus# configure terminal
awplus(config)# router ipv6 rip
awplus(config-router)# no recv-buffer-size
```



# redistribute (IPv6 RIPng)

**Overview** Use this command to redistribute information from other routing protocols into RIPng.

Use the **no** variant of this command to disable the specified redistribution. The parameters **metric** and **route-map** may be used on this command, but have no effect.

**Syntax** redistribute {connected|static|ospf} [metric <0-16>] [route-map <route-map>]  
no redistribute {connected|static|ospf} [metric <0-16>] [route-map <route-map>]

| Parameter   | Description                                                                                                                                                                                                                |
|-------------|----------------------------------------------------------------------------------------------------------------------------------------------------------------------------------------------------------------------------|
| <0-16>      | Optional. Specifies the metric value to be used when redistributing information. If a value is not specified, and no value is specified using the <a href="#">default-metric (IPv6 RIPng)</a> command, the default is one. |
| <route-map> | Optional. Specifies route-map to be used to redistribute information.                                                                                                                                                      |
| connected   | Redistribute from connected routes.                                                                                                                                                                                        |
| static      | Redistribute from static routes.                                                                                                                                                                                           |
| ospf        | Redistribute from Open Shortest Path First (OSPF).                                                                                                                                                                         |

**Default** By default, the RIPng metric value is set to 1.

**Mode** Router Configuration

**Example** To redistribute information from other routing protocols into RIPng, use the following commands:

```
awplus# configure terminal
awplus(config)# router ipv6 rip
awplus(config-router)# redistribute static route-map mymap
awplus(config-router)# redistribute static metric 8
```

**Related Commands** [default-metric \(IPv6 RIPng\)](#)

# route (IPv6 RIPng)

**Overview** Use this command to configure static RIPng routes.  
Use the **no** variant of this command to disable this function.

**Syntax** `route <ipv6-addr/prefix-length>`  
`no route <ipv6-addr/prefix-length>`

| Parameter                                    | Description                                                                                                                      |
|----------------------------------------------|----------------------------------------------------------------------------------------------------------------------------------|
| <code>&lt;ipv6-addr/prefix-length&gt;</code> | Specify the IPv6 Address in format <code>X:X::X:Prefix-Length</code> . The prefix-length is a decimal integer between 1 and 128. |

**Mode** Router Configuration

**Usage** Use this command to add a static RIPng route. After adding the RIPng route, the route can be checked in the RIPng routing table.

**Example** To configure static RIPng routes, use the following commands:

```
awplus# configure terminal
awplus(config)# router ipv6 rip
awplus(config-router)# route 2001:db8::1/64
```

**Related Commands** [show ipv6 rip](#)  
[clear ipv6 rip route](#)

# router ipv6 rip

**Overview** Use this global command to enter Router Configuration mode to enable a RIPng routing process.

Use the **no** variant of this command to disable the RIPng routing process.

**Syntax** `router ipv6 rip`  
`no router ipv6 rip`

**Mode** Global Configuration

**Example** To enable a RIPng routing process, use the following commands:

```
awplus# configure terminal
awplus(config)# router ipv6 rip
awplus(config-router)#
```

# show debugging ipv6 rip

**Overview** Use this command to display the RIPng debugging status for the debugging options of: nsm debugging, RIPng event debugging, RIPng packet debugging, and RIPng nsm debugging.

For information on filtering and saving command output, see the [“Getting Started with AlliedWare Plus” Feature Overview and Configuration Guide](#).

**Syntax** `show debugging ipv6 rip`

**Mode** User Exec and Privileged Exec

**Usage** Use this command to display the debug status of RIPng.

**Example** To display the RIPng debugging status, use the following command:

```
awplus# show debugging ipv6 rip
```

# show ipv6 protocols rip

**Overview** Use this command to display RIPng process parameters and statistics.

For information on filtering and saving command output, see the [“Getting Started with AlliedWare Plus” Feature Overview and Configuration Guide](#).

**Syntax** `show ipv6 protocols rip`

**Mode** User Exec and Privileged Exec

**Example** To display RIPng process parameters and statistics, use the following command:

```
awplus# show ipv6 protocols rip
```

## Output

```
awplus#show ipv6 protocols rip
Routing Protocol is "RIPng"
 Sending updates every 30 seconds with +/-5 seconds, next due
in 6 seconds
 Timeout after 180 seconds, garbage collect after 120 seconds
 Outgoing update filter list for all interface is not set
 Incoming update filter list for all interface is not set
 Default redistribute metric is 1
 Redistributing:
 Interface
 vlan3
 Routing for Networks:
 fe80::200:cdff:fe27:c086 vlan1
```

# show ipv6 rip

**Overview** Use this command to show RIPng routes.

For information on filtering and saving command output, see the [“Getting Started with AlliedWare Plus” Feature Overview and Configuration Guide](#).

**Syntax** `show ipv6 rip`

**Mode** User Exec and Privileged Exec

**Example** To display RIPng routes, use the following command:

```
awplus# show ipv6 rip
```

## Output

```
Codes: R - RIP, Rc - RIP connected, Rs - RIP static, Ra - RIP
aggregated, Rcx - RIP connect suppressed, Rsx - RIP static
suppressed, C - Connected, S - Static, O - OSPF
```

|    | Network         | Next Hop        | If    | Met | Tag | Time  |
|----|-----------------|-----------------|-------|-----|-----|-------|
| R  | 2001:db8:1::/48 | 2001:db8:2::/48 | vlan3 | 3   | 0   | 02:28 |
| C  | 2001:db8:3::/48 | ::              | vlan2 | 1   | 0   |       |
| Ra | 2001:db8:4::/48 |                 | --    | 1   | 0   |       |
| Rs | 2001:db8:5::/48 | 2001:db8:1::/48 | vlan3 | 3   | 0   | 02:32 |
| Cs | 2001:db8:6::/48 | ::              | vlan3 | 1   | 0   |       |

**Related Commands** [show ipv6 rip database](#)

# show ipv6 rip database

**Overview** Use this command to display information about the RIPng database.

For information on filtering and saving command output, see the [“Getting Started with AlliedWare Plus” Feature Overview and Configuration Guide](#).

**Syntax** `show ipv6 rip database [full]`

| Parameter | Description                                                                |
|-----------|----------------------------------------------------------------------------|
| full      | Display all IPv6 RIPng full database entries including sub-optimal routes. |

**Mode** User Exec and Privileged Exec

**Example** To display information about the RIPng database, use the following command:

```
awplus# show ipv6 rip database
```

## Output

```
Codes: R - RIP, Rc - RIP connected, Rs - RIP static, Ra - RIP
aggregated, Rcx - RIP connect suppressed, Rsx - RIP static
suppressed, C - Connected, S - Static, O - OSPF
 Network Next Hop If Met Tag Time
R 2001:db8:1::/48 2001:db8:2::/48 vlan3 3 0 02:28
C 2001:db8:3::/48 :: vlan2 1 0
Ra 2001:db8:4::/48 -- 1 0
Rs 2001:db8:5::/48 2001:db8:1::/48 vlan3 3 0 02:32
Cs 2001:db8:6::/48 :: vlan3 1 0
```

**Related Commands** [show ipv6 rip](#)

# show ipv6 rip interface

**Overview** Use this command to display information about the RIPng interfaces. You can specify an interface name to display information about a specific interface.

For information on filtering and saving command output, see the [“Getting Started with AlliedWare Plus” Feature Overview and Configuration Guide](#).

**Syntax** `show ipv6 rip interface [<interface>]`

| Parameter   | Description                                                                    |
|-------------|--------------------------------------------------------------------------------|
| <interface> | The interface to display information about. For instance: <code>vlan2</code> . |

**Mode** User Exec and Privileged Exec

**Example** To display RIPng interface information, use the following command:

```
awplus# show ipv6 rip interface
```

## Output

```
lo is up, line protocol is up
RIPng is not enabled on this interface
vlan1 is up, line protocol is up
RIPng is not enabled on this interface
vlan2 is down, line protocol is down
RIPng is not enabled on this interface
vlan3 is up, line protocol is up
Routing Protocol: RIPng
Passive interface: Disabled
Split horizon: Enabled with Poisoned Reversed
IP interface address:
2001:db8:1::1/64
2001:db8:1::2/64
```



# timers (IPv6 RIPng)

**Overview** Use this command to adjust the RIPng routing network timers.

Use the **no** variant of this command to restore the defaults.

**Syntax** `timers basic <update> <timeout> <garbage>`  
`no timers basic`

| Parameter                    | Description                                                                                                                                                                                                                             |
|------------------------------|-----------------------------------------------------------------------------------------------------------------------------------------------------------------------------------------------------------------------------------------|
| <code>&lt;update&gt;</code>  | <code>&lt;5-2147483647&gt;</code> Specifies the RIPng routing table update timer in seconds. The default is 30 seconds.                                                                                                                 |
| <code>&lt;timeout&gt;</code> | <code>&lt;5-2147483647&gt;</code> Specifies the RIPng routing information timeout timer in seconds. The default is 180 seconds. After this interval has elapsed and no updates for a route are received, the route is declared invalid. |
| <code>&lt;garbage&gt;</code> | <code>&lt;5-2147483647&gt;</code> Specifies the RIPng routing garbage collection timer in seconds. The default is 120 seconds.                                                                                                          |

**Default** The default RIPng routing table update timer default is 30 seconds, the default RIPng routing information timeout timer is 180 seconds, and the default RIPng routing garbage collection timer is 120 seconds. The **no** variant of this command restores the default RIPng routing timers.

**Mode** Router Configuration

**Example** To adjust the RIPng routing network timers, use the following commands:

```
awplus# configure terminal
awplus(config)# router ipv6 rip
awplus(config-router)# timers basic 30 180 120
```

# undebg ipv6 rip

**Overview** Use this command to disable debugging options of RIPng events, RIPng packets, and communication between RIPng and NSM processes.

**Syntax** `undebg ipv6 rip [all|events|nsm|packet [recv|send][detail]]`

| Parameter | Description                                                               |
|-----------|---------------------------------------------------------------------------|
| all       | Disables all RIPng debugging.                                             |
| events    | Disable the display of RIPng events information.                          |
| nsm       | Disable the display of RIPng and NSM communication.                       |
| packet    | Disable debugging of specified RIPng packets only.                        |
| recv      | Disable the display of information for received packets.                  |
| send      | Disable the display of information for sent packets.                      |
| detail    | Disable the display of detailed information for sent or received packets. |

**Mode** Privileged Exec and Global Configuration

**Example** To disable debugging options, use the following command:

```
awplus# undebg ipv6 rip events
awplus# undebg ipv6 rip all
awplus# undebg ipv6 rip packet send
awplus# undebg ipv6 rip packet recv detail
```

**Related Commands** [debug ipv6 rip](#)

# 29

# OSPF Commands

## Introduction

**Overview** This chapter provides an alphabetical reference of commands used to configure OSPF. For more information, see the [OSPF Feature Overview and Configuration Guide](#).

- Command List**
- ["area default-cost"](#) on page 934
  - ["area authentication"](#) on page 935
  - ["area filter-list"](#) on page 936
  - ["area nssa"](#) on page 937
  - ["area range"](#) on page 939
  - ["area stub"](#) on page 941
  - ["area virtual-link"](#) on page 942
  - ["auto-cost reference bandwidth"](#) on page 945
  - ["bandwidth"](#) on page 947
  - ["capability opaque"](#) on page 948
  - ["capability restart"](#) on page 949
  - ["clear ip ospf process"](#) on page 950
  - ["compatible rfc1583"](#) on page 951
  - ["debug ospf events"](#) on page 952
  - ["debug ospf ifsm"](#) on page 953
  - ["debug ospf lsa"](#) on page 954
  - ["debug ospf n fsm"](#) on page 955
  - ["debug ospf nsm"](#) on page 956
  - ["debug ospf packet"](#) on page 957

- [“debug ospf route”](#) on page 958
- [“default-information originate”](#) on page 959
- [“default-metric \(OSPF\)”](#) on page 960
- [“distance \(OSPF\)”](#) on page 961
- [“enable db-summary-opt”](#) on page 963
- [“host area”](#) on page 964
- [“ip ospf authentication”](#) on page 965
- [“ip ospf authentication-key”](#) on page 966
- [“ip ospf cost”](#) on page 968
- [“ip ospf database-filter”](#) on page 969
- [“ip ospf dead-interval”](#) on page 970
- [“ip ospf disable all”](#) on page 971
- [“ip ospf hello-interval”](#) on page 972
- [“ip ospf message-digest-key”](#) on page 973
- [“ip ospf mtu”](#) on page 975
- [“ip ospf mtu-ignore”](#) on page 976
- [“ip ospf network”](#) on page 977
- [“ip ospf priority”](#) on page 978
- [“ip ospf resync-timeout”](#) on page 979
- [“ip ospf retransmit-interval”](#) on page 980
- [“ip ospf transmit-delay”](#) on page 981
- [“max-concurrent-dd”](#) on page 982
- [“maximum-area”](#) on page 983
- [“neighbor \(OSPF\)”](#) on page 984
- [“network area”](#) on page 985
- [“ospf abr-type”](#) on page 987
- [“ospf restart grace-period”](#) on page 988
- [“ospf restart helper”](#) on page 989
- [“ospf router-id”](#) on page 991
- [“overflow database”](#) on page 992
- [“overflow database external”](#) on page 993
- [“passive-interface \(OSPF\)”](#) on page 994
- [“redistribute \(OSPF\)”](#) on page 995
- [“restart ospf graceful”](#) on page 997
- [“router ospf”](#) on page 998

- ["router-id"](#) on page 1000
- ["show debugging ospf"](#) on page 1001
- ["show ip ospf"](#) on page 1002
- ["show ip ospf border-routers"](#) on page 1005
- ["show ip ospf database"](#) on page 1006
- ["show ip ospf database asbr-summary"](#) on page 1008
- ["show ip ospf database external"](#) on page 1009
- ["show ip ospf database network"](#) on page 1011
- ["show ip ospf database nssa-external"](#) on page 1012
- ["show ip ospf database opaque-area"](#) on page 1014
- ["show ip ospf database opaque-as"](#) on page 1015
- ["show ip ospf database opaque-link"](#) on page 1016
- ["show ip ospf database router"](#) on page 1017
- ["show ip ospf database summary"](#) on page 1019
- ["show ip ospf interface"](#) on page 1022
- ["show ip ospf neighbor"](#) on page 1023
- ["show ip ospf route"](#) on page 1025
- ["show ip ospf virtual-links"](#) on page 1026
- ["show ip protocols ospf"](#) on page 1027
- ["summary-address"](#) on page 1028
- ["timers spf exp"](#) on page 1029
- ["undebug ospf events"](#) on page 1030
- ["undebug ospf ifsm"](#) on page 1031
- ["undebug ospf lsa"](#) on page 1032
- ["undebug ospf nfm"](#) on page 1033
- ["undebug ospf nsm"](#) on page 1034
- ["undebug ospf packet"](#) on page 1035
- ["undebug ospf route"](#) on page 1036

# area default-cost

**Overview** This command specifies a cost for the default summary route sent into a stub or NSSA area.

The **no** variant of this command removes the assigned default-route cost.

**Syntax** `area <area-id> default-cost <0-16777215>`  
`no area <area-id> default-cost`

| Parameter                         | Description                                                                                                                                                                               |
|-----------------------------------|-------------------------------------------------------------------------------------------------------------------------------------------------------------------------------------------|
| <code>&lt;area-id&gt;</code>      | The OSPF area that you are specifying the default summary route cost for. Use one of the following formats: This can be entered in either dotted decimal format or normal decimal format. |
| <code>&lt;ip-addr&gt;</code>      | OSPF Area ID expressed in IPv4 address format A.B.C.D.                                                                                                                                    |
| <code>&lt;0-4294967295&gt;</code> | OSPF Area ID expressed as a decimal number within the range shown.                                                                                                                        |
|                                   | For example the values dotted decimal 0.0.1.2 and decimal 258 would both define the same area ID.                                                                                         |
| <code>default-cost</code>         | Indicates the cost for the default summary route used for a stub or NSSA area.<br>Default: <b>1</b>                                                                                       |

**Mode** Router Configuration

**Usage** The default-cost option provides the metric for the summary default route, generated by the area border router, into the NSSA or stub area. Use this option only on an area border router that is attached to the NSSA or stub area. Refer to the RFC 3101 for information on NSSA.

**Example** To set the default cost to 10 in area 1 for the OSPF instance 100, use the commands:

```
awplus# configure terminal
awplus(config)# router ospf 100
awplus(config-router)# area 1 default-cost 10
```

**Related Commands** [area nssa](#)  
[area stub](#)

# area authentication

**Overview** Use this command to enable authentication for an OSPF area. Specifying the area authentication sets the authentication to Type 1 authentication or the Simple Text password authentication (details in RFC 2328).

The **no** variant of this command removes the authentication specification for an area.

**Syntax** `area <area-id> authentication [message-digest]`  
`no area <area-id> authentication`

| Parameter                         | Description                                                                                                                           |
|-----------------------------------|---------------------------------------------------------------------------------------------------------------------------------------|
| <code>&lt;area-id&gt;</code>      | The OSPF area that you are enabling authentication for. This can be entered in either dotted decimal format or normal decimal format. |
| <code>&lt;ip-addr&gt;</code>      | OSPF Area ID expressed in IPv4 address, entered in the form A.B.C.D.                                                                  |
| <code>&lt;0-4294967295&gt;</code> | OSPF Area ID expressed as a decimal number within the range shown.                                                                    |
|                                   | For example the values dotted decimal 0.0.1.2 and decimal 258 would both define the same area OSPF Area ID.                           |
| <code>message-digest</code>       | Enables MD5 authentication in the OSPF area.                                                                                          |

**Default** By default, no authentication occurs.

**Mode** Router Configuration

**Usage** All OSPF packets transmitted in this **area** must have the same password in their OSPF header. This ensures that only routers that have the correct password may join the routing domain.

Give all routers that are to communicate with each other through OSPF the same authentication password.

Use the [ip ospf authentication-key](#) command to specify a Simple Text password. Use the [ip ospf message-digest-key](#) command to specify MD5 password.

**Example**

```
awplus# configure terminal
awplus(config)# router ospf 100
awplus(config-router)# area 1 authentication
```

**Related Commands** [ip ospf authentication](#)  
[ip ospf message-digest-key](#)

# area filter-list

**Overview** This command configures filters to advertise summary routes on Area Border Routers (ABR).

This command is used to suppress particular intra-area routes from/to an area to/from the other areas. You can use this command in conjunction with the prefix-list command.

The **no** variant of this command removes the filter configuration.

**Syntax** `area <area-id> filter-list prefix <prefix-list> {in|out}`  
`no area <area-id> filter-list prefix <prefix-list> {in|out}`

| Parameter      | Description                                                                                                                                                            |
|----------------|------------------------------------------------------------------------------------------------------------------------------------------------------------------------|
| <area-id>      | The OSPF area that you are configuring the filter for. Use one of the following formats: This can be entered in either dotted decimal format or normal decimal format. |
| <ip-addr>      | OSPF Area ID expressed in IPv4 address format A.B.C.D.                                                                                                                 |
| <0-4294967295> | OSPF Area ID expressed as a decimal number within the range shown.                                                                                                     |
|                | For example the values dotted decimal 0.0.1.2 and decimal 258 would both define the same area ID.                                                                      |
| prefix         | Use prefix-list to filter summary.                                                                                                                                     |
| <prefix-list>  | Name of a prefix-list.                                                                                                                                                 |
| in             | Filter routes from the other areas to this area.                                                                                                                       |
| out            | Filter routes from this area to the other areas.                                                                                                                       |

**Mode** Router Configuration



## area nssa

**Overview** This command sets an area as a Not-So-Stubby-Area (NSSA). By default, no NSSA area is defined.

Use this command to simplify administration if you are connecting a central site using OSPF to a remote site that is using a different routing protocol. You can extend OSPF to cover the remote connection by defining the area between the central router and the remote router as an NSSA.

There are no external routes in an OSPF stub area, so you cannot redistribute from another protocol into a stub area. A NSSA allows external routes to be flooded within the area. These routes are then leaked into other areas. Although, the external routes from other areas still do not enter the NSSA. You can either configure an area to be a stub area or an NSSA, not both.

The **no** variant of this command removes this designation.

**Syntax**

```
area <area-id> nssa [default-information-originate <metric> |
no-redistribution | no-summary | translator-role <role>]
no area <area-id> nssa [default-information-originate |
no-redistribution | no-summary | translator-role]
```

| Parameter                     | Description                                                                                                                                                                                                                                                                                                                                                                                                                                                                                                                             |                    |                                                        |                  |                                                                    |
|-------------------------------|-----------------------------------------------------------------------------------------------------------------------------------------------------------------------------------------------------------------------------------------------------------------------------------------------------------------------------------------------------------------------------------------------------------------------------------------------------------------------------------------------------------------------------------------|--------------------|--------------------------------------------------------|------------------|--------------------------------------------------------------------|
| <area-id>                     | The OSPF area that you are configuring as an NSSA. Use one of the following formats: This can be entered in either dotted decimal format or normal decimal format.<br><br><table border="1"> <tr> <td>&lt;ip-addr&gt;</td> <td>OSPF Area ID expressed in IPv4 address format A.B.C.D.</td> </tr> <tr> <td>&lt;0-4294967295&gt;</td> <td>OSPF Area ID expressed as a decimal number within the range shown.</td> </tr> </table> <p>For example the values dotted decimal 0.0.1.2 and decimal 258 would both define the same area ID.</p> | <ip-addr>          | OSPF Area ID expressed in IPv4 address format A.B.C.D. | <0-4294967295>   | OSPF Area ID expressed as a decimal number within the range shown. |
| <ip-addr>                     | OSPF Area ID expressed in IPv4 address format A.B.C.D.                                                                                                                                                                                                                                                                                                                                                                                                                                                                                  |                    |                                                        |                  |                                                                    |
| <0-4294967295>                | OSPF Area ID expressed as a decimal number within the range shown.                                                                                                                                                                                                                                                                                                                                                                                                                                                                      |                    |                                                        |                  |                                                                    |
| default-information-originate | Originate Type-7 default LSA into NSSA.                                                                                                                                                                                                                                                                                                                                                                                                                                                                                                 |                    |                                                        |                  |                                                                    |
| <metric>                      | The external or internal metric. Specify the following:<br><br><table border="1"> <tr> <td>metric&lt;0-16777214&gt;</td> <td>The metric value.</td> </tr> <tr> <td>metric-type&lt;1-2&gt;</td> <td>External metric type.</td> </tr> </table>                                                                                                                                                                                                                                                                                            | metric<0-16777214> | The metric value.                                      | metric-type<1-2> | External metric type.                                              |
| metric<0-16777214>            | The metric value.                                                                                                                                                                                                                                                                                                                                                                                                                                                                                                                       |                    |                                                        |                  |                                                                    |
| metric-type<1-2>              | External metric type.                                                                                                                                                                                                                                                                                                                                                                                                                                                                                                                   |                    |                                                        |                  |                                                                    |
| no-redistribution             | Do not redistribute external route into NSSA.                                                                                                                                                                                                                                                                                                                                                                                                                                                                                           |                    |                                                        |                  |                                                                    |
| no-summary                    | Do not inject inter-area route into NSSA.                                                                                                                                                                                                                                                                                                                                                                                                                                                                                               |                    |                                                        |                  |                                                                    |
| translator-role               | Specify NSSA-ABR translator-role.                                                                                                                                                                                                                                                                                                                                                                                                                                                                                                       |                    |                                                        |                  |                                                                    |

| Parameter                 | Description                                                   |
|---------------------------|---------------------------------------------------------------|
| <code>&lt;role&gt;</code> | The role type. Specify one of the following keywords:         |
| <code>always</code>       | Router always translate NSSA-LSA to Type-5 LSA.               |
| <code>candidate</code>    | Router may translate NSSA-LSA to Type-5 LSA if it is elected. |
| <code>never</code>        | Router never translate NSSA-LSA.                              |

**Mode** Router Configuration

**Example**

```
awplus# configure terminal
awplus(config)# router ospf 100
awplus(config-router)# area 0.0.0.51 nssa
awplus(config-router)# area 3 nssa translator-role candidate
no-redistribution default-information-originate metric 34
metric-type 2
```

**Related Commands** [area default-cost](#)

# area range

**Overview** Use this command to summarize OSPF routes at an area boundary, configuring an IPv4 address range which consolidates OSPF routes. By default, this feature is not enabled.

A summary route created by this command is then advertised to other areas by the Area Border Routers (ABRs). In this way, routing information is condensed at area boundaries and outside the area so that routes are exchanged between areas in an efficient manner.

If the network numbers in an area are arranged into sets of contiguous routes, the ABRs can be configured to advertise a summary route that covers all the individual networks within the area that fall into the specified range.

The **no** variant of this command disables this function and restores default behavior.

**Syntax** `area <area-id> range <ip-addr/prefix-length> [advertise|not-advertise]`  
`no area <area-id> range <ip-addr/prefix-length>`

| Parameter                                  | Description                                                                                                                                                        |
|--------------------------------------------|--------------------------------------------------------------------------------------------------------------------------------------------------------------------|
| <code>&lt;area-id&gt;</code>               | The OSPF area that you summarizing the routes for. Use one of the following formats: This can be entered in either dotted decimal format or normal decimal format. |
| <code>&lt;ip-addr&gt;</code>               | OSPF Area ID expressed in IPv4 address format A.B.C.D.                                                                                                             |
| <code>&lt;0-4294967295&gt;</code>          | OSPF Area ID expressed as a decimal number within the range shown.                                                                                                 |
|                                            | For example the values dotted decimal 0.0.1.2 and decimal 258 would both define the same area ID.                                                                  |
| <code>&lt;ip-addr/prefix-length&gt;</code> | The area range prefix and length.                                                                                                                                  |
| <code>advertise</code>                     | Advertise this range as a summary route into other areas.                                                                                                          |
| <code>not-advertise</code>                 | Does not advertise this range.                                                                                                                                     |

**Default** The area range is not configured by default. The area range is advertised if it is configured.

**Mode** Router Configuration

**Usage** You can configure multiple ranges on a single area with multiple instances of this command, so OSPF summarizes addresses for different sets of IPv4 address ranges.

Ensure OSPF IPv4 routes exist in the area range for advertisement before using this command.

**Example** awplus# configure terminal  
awplus(config)# router ospf 100  
awplus(config-router)# area 1 range 192.16.0.0/16  
awplus(config-router)# area 1 range 203.18.0.0/16

# area stub

**Overview** This command defines an OSPF area as a stub area. By default, no stub area is defined.

Use this command when routers in the area do not require learning about summary LSAs from other areas. You can define the area as a totally stubby area by configuring the Area Border Router of that area using the **area stub no-summary** command.

There are two stub area router configuration commands: the **area stub** and **area default-cost** commands. In all routers attached to the stub area, configure the area by using the **area stub** command. For an area border router (ABR) attached to the stub area, also use the **area default-cost** command.

The **no** variant of this command removes this definition.

**Syntax** `area <area-id> stub [no-summary]`  
`no area <area-id> stub [no-summary]`

| Parameter                         | Description                                                                                                                                                                                                                                                              |
|-----------------------------------|--------------------------------------------------------------------------------------------------------------------------------------------------------------------------------------------------------------------------------------------------------------------------|
| <code>&lt;area-id&gt;</code>      | The OSPF area that you are configuring as a stub area. Use one of the following formats: This can be entered in either dotted decimal format or normal decimal format. For example the values dotted decimal 0.0.1.2 and decimal 258 would both define the same area ID. |
| <code>&lt;ip-addr&gt;</code>      | OSPF Area ID expressed in IPv4 address in the format A.B.C.D.                                                                                                                                                                                                            |
| <code>&lt;0-4294967295&gt;</code> | OSPF Area ID expressed as a decimal number within the range shown.                                                                                                                                                                                                       |
|                                   | For example the values dotted decimal 0.0.1.2 and decimal 258 would both define the same area ID.                                                                                                                                                                        |
| <code>no-summary</code>           | Stops an ABR from sending summary link advertisements into the stub area.                                                                                                                                                                                                |

**Mode** Router Configuration

**Example** `awplus# configure terminal`  
`awplus(config)# router ospf 100`  
`awplus(config-router)# area 1 stub`

**Related Commands** [area default-cost](#)

# area virtual-link

**Overview** This command configures a link between two backbone areas that are physically separated through other non-backbone areas.

In OSPF, all non-backbone areas must be connected to a backbone area. If the connection to the backbone is lost, the virtual link repairs the connection.

The **no** variant of this command removes the virtual link.

**Syntax**

```

area <area-id> virtual-link <ip-addr> [<auth-key>|<msg-key>]
no area <area-id> virtual-link <ip-addr> [<auth-key>|<msg-key>]
area <area-id> virtual-link <ip-addr> authentication
[message-digest|null] [<auth-key>|<msg-key>]
no area <area-id> virtual-link <ip-addr> authentication
[message-digest|null] [<auth-key>|<msg-key>]
area <area-id> virtual-link <ip-addr> [authentication]
[dead-interval <1-65535>] [hello-interval <1-65535>]
[retransmit-interval <1-3600>] [transmit-delay <1-3600>]
no area <area-id> virtual-link <ip-addr> [authentication]
[dead-interval] [hello-interval] [retransmit-interval]
[transmit-delay]

```

| Parameter      | Description                                                                                                                                                                                                                                                                                                                                                                                                                                                                                                                                                |              |                                                        |                |                                                                    |
|----------------|------------------------------------------------------------------------------------------------------------------------------------------------------------------------------------------------------------------------------------------------------------------------------------------------------------------------------------------------------------------------------------------------------------------------------------------------------------------------------------------------------------------------------------------------------------|--------------|--------------------------------------------------------|----------------|--------------------------------------------------------------------|
| <area-id>      | <p>The area ID of the transit area that the virtual link passes through. Use one of the following formats: This can be entered in either dotted decimal format or normal decimal format.</p> <table border="1"> <tr> <td>&lt;ip-addr&gt;</td> <td>OSPF Area ID expressed in IPv4 address format A.B.C.D.</td> </tr> <tr> <td>&lt;0-4294967295&gt;</td> <td>OSPF Area ID expressed as a decimal number within the range shown.</td> </tr> </table> <p>For example the values dotted decimal 0.0.1.2 and decimal 258 would both define the same area ID.</p> | <ip-addr>    | OSPF Area ID expressed in IPv4 address format A.B.C.D. | <0-4294967295> | OSPF Area ID expressed as a decimal number within the range shown. |
| <ip-addr>      | OSPF Area ID expressed in IPv4 address format A.B.C.D.                                                                                                                                                                                                                                                                                                                                                                                                                                                                                                     |              |                                                        |                |                                                                    |
| <0-4294967295> | OSPF Area ID expressed as a decimal number within the range shown.                                                                                                                                                                                                                                                                                                                                                                                                                                                                                         |              |                                                        |                |                                                                    |
| <ip-address>   | The OSPF router ID of the virtual link neighbor.                                                                                                                                                                                                                                                                                                                                                                                                                                                                                                           |              |                                                        |                |                                                                    |
| <auth-key>     | <p>Specifies the password used for this virtual link. Use the format: <b>authentication-key</b>&lt;pswd-short&gt;</p> <table border="1"> <tr> <td>&lt;pswd-short&gt;</td> <td>An 8 character password.</td> </tr> </table>                                                                                                                                                                                                                                                                                                                                 | <pswd-short> | An 8 character password.                               |                |                                                                    |
| <pswd-short>   | An 8 character password.                                                                                                                                                                                                                                                                                                                                                                                                                                                                                                                                   |              |                                                        |                |                                                                    |
| <msg-key>      | <p>Specifies a message digest key using the MD5 encryption algorithm. Use the following format: <b>message-digest-key</b>&lt;1-255&gt; md5 &lt;pswd-long&gt;</p> <table border="1"> <tr> <td>&lt;1-255&gt;</td> <td>The key ID.</td> </tr> <tr> <td>&lt;pswd-long&gt;</td> <td>Authentication password of 16 characters.</td> </tr> </table>                                                                                                                                                                                                               | <1-255>      | The key ID.                                            | <pswd-long>    | Authentication password of 16 characters.                          |
| <1-255>        | The key ID.                                                                                                                                                                                                                                                                                                                                                                                                                                                                                                                                                |              |                                                        |                |                                                                    |
| <pswd-long>    | Authentication password of 16 characters.                                                                                                                                                                                                                                                                                                                                                                                                                                                                                                                  |              |                                                        |                |                                                                    |
| authentication | Enables authentication on this virtual link.                                                                                                                                                                                                                                                                                                                                                                                                                                                                                                               |              |                                                        |                |                                                                    |

| Parameter           | Description                                                                                                                                                             |
|---------------------|-------------------------------------------------------------------------------------------------------------------------------------------------------------------------|
| message-digest      | Use message-digest authentication.                                                                                                                                      |
| null                | Use null authentication to override password or message digest.                                                                                                         |
| dead-interval       | If no packets are received from a particular neighbor for dead-interval seconds, the router considers that neighboring router as being off-line.<br>Default: 40 seconds |
|                     | <1-65535>      The number of seconds in the interval.                                                                                                                   |
| hello-interval      | The interval the router waits before it sends a hello packet.<br>Default: 10 seconds                                                                                    |
|                     | <1-65535>      The number of seconds in the interval.                                                                                                                   |
| retransmit-interval | The interval the router waits before it retransmits a packet.<br>Default: 5 seconds                                                                                     |
|                     | <1-3600>      The number of seconds in the interval.                                                                                                                    |
| transmit-delay      | The interval the router waits before it transmits a packet.<br>Default: 1 seconds                                                                                       |
|                     | <1-3600>      The number of seconds in the interval.                                                                                                                    |

**Mode** Router Configuration

**Usage** You can configure virtual links between any two backbone routers that have an interface to a common non-backbone area. The protocol treats these two routers, joined by a virtual link, as if they were connected by an unnumbered point-to-point network. To configure a virtual link, you require:

- The transit area ID, i.e. the area ID of the non backbone area that the two backbone routers are both connected to.
- The corresponding virtual link neighbor's router ID. To see the router ID use the [show ip ospf](#) command.

Configure the **hello-interval** to be the same for all routers attached to a common network. A short **hello-interval** results in the router detecting topological changes faster but also an increase in the routing traffic.

The **retransmit-interval** is the expected round-trip delay between any two routers in a network. Set the value to be greater than the expected round-trip delay to avoid needless retransmissions.

The **transmit-delay** is the time taken to transmit a link state update packet on the interface. Before transmission, the link state advertisements in the update packet, are incremented by this amount. Set the **transmit-delay** to be greater than zero. Also, take into account the transmission and propagation delays for the interface.

**Example**

```
awplus# configure terminal
awplus(config)# router ospf 100
awplus(config-router)# area 1 virtual-link 10.10.11.50 hello 5
dead 10
```

**Related  
Commands**    area authentication  
                  show ip ospf  
                  show ip ospf virtual-links



# auto-cost reference bandwidth

**Overview** This command controls how OSPF calculates default metrics for the interface. Use the **no** variant of this command to assign cost based only on the interface bandwidth.

**Syntax** `auto-cost reference-bandwidth <1-4294967>`  
`no auto-cost reference-bandwidth`

| Parameter                      | Description                                                  |
|--------------------------------|--------------------------------------------------------------|
| <code>&lt;1-4294967&gt;</code> | The reference bandwidth in terms of Mbits per second (Mbps). |

**Default** 1000 Mbps

**Usage** By default, OSPF calculates the OSPF metric for an interface by dividing the reference bandwidth by the interface bandwidth. The default for the reference bandwidth is 1000 Mbps. As a result, if this default is used, there is very little difference between the metrics applied to interfaces of increasing bandwidth beyond 1000 Mbps.

The auto-cost command is used to alter this reference bandwidth in order to give a real difference between the metrics of high bandwidth links of differing bandwidths. In a network that has multiple links with high bandwidths, specify a larger reference bandwidth value to differentiate the costs on those links.

Cost is calculated by dividing the reference bandwidth (Mbps) by the layer 3 interface (Switched Virtual Interface (SVI), Loopback or Ethernet interface) bandwidth. Interface bandwidth may be altered by using the [bandwidth](#) command as the SVI does not auto detect the bandwidth based on the speed of associated switch ports.

When the reference bandwidth calculation results in a cost integer greater than 1 but contains a fractional value (value after the decimal point), the result rounds down to the nearest integer. The following example shows how the cost is calculated.

The reference bandwidth is 1000 Mbps and the interface bandwidth is 7 Mbps.

Calculation =  $1000/7$

Calculation result = 142.85 (integer of 142, fractional value of 0.85)

Result after rounding down to the nearest integer = 142 (Interface cost is 142)

When the reference bandwidth calculation results in a cost less than 1, it is rounded up to the nearest integer which is 1. The following example shows how the cost is calculated.

The reference bandwidth is 1000 Mbps and the interface bandwidth is 10000 Mbps.

Calculation =  $1000/10000$

Calculation result = 0.1

Result after rounding up to the nearest integer = 1 (Interface cost is 1)

The auto-cost reference bandwidth value should be consistent across all OSPF routers in the OSPF process.

Note that using the [ip ospf cost](#) command on a layer 3 interface will override the cost calculated by this command.

**Mode** Router Configuration

**Example**

```
awplus# configure terminal
awplus(config)# router ospf 100
awplus(config-router)# auto-cost reference-bandwidth 1000
```

**Related  
Commands** [ip ospf cost](#)

# bandwidth

**Overview** Use this command to specify the maximum bandwidth to be used for each VLAN interface. The bandwidth value is in bits per second. OSPF uses this to calculate metrics for the VLAN interface.

The **no** variant of this command removes any applied bandwidth value and replaces it with a value equal to the lowest port speed within that VLAN.

**Syntax** `bandwidth <bandwidth-setting>`  
`no bandwidth`

| Parameter                              | Description                                                                                                                                                                                                                                                                      |
|----------------------------------------|----------------------------------------------------------------------------------------------------------------------------------------------------------------------------------------------------------------------------------------------------------------------------------|
| <code>&lt;bandwidth-setting&gt;</code> | Sets the bandwidth for the interface. Enter a value in the range 1 to 10000000000 bits per second. Note that to avoid entering many zeros, you can add k, m, or g to internally add 3, 6 or 9 zeros to the number entered. For example entering 1k is the same as entering 1000. |

**Mode** Interface Configuration for a VLAN interface.

**Example** To set the bandwidth on VLAN2 to be 1 Mbps, use the following commands:

```
awplus# configure terminal
awplus(config)# interface vlan2
awplus(config-if)# bandwidth 1000000
```

Or

```
awplus(config-if)# bandwidth 1m
```

**Related Commands** [show interface](#)

# capability opaque

**Overview** This command enables opaque-LSAs. Opaque-LSAs are Type 9, 10 and 11 LSAs that deliver information used by external applications.

Use the **no** variant of this command to disable opaque-LSAs.

**Syntax** `capability opaque`  
`no capability opaque`

**Default** By default, opaque-LSAs are enabled.

**Mode** Router Configuration

**Example**

```
awplus# configure terminal
awplus(config)# router ospf 100
awplus(config-router)# no capability opaque
```

# capability restart

**Overview** This command enables OSPF Graceful Restart or restart signaling features. By default, this is enabled.

Use the **no** variant of this command to disable OSPF Graceful Restart and restart signaling features.

**Syntax** `capability restart [graceful|signaling]`  
`no capability restart`

| Parameter              | Description                    |
|------------------------|--------------------------------|
| <code>graceful</code>  | Enable graceful OSPF restart.  |
| <code>signaling</code> | Enable OSPF restart signaling. |

**Default** Graceful restart

**Mode** Router Configuration

**Example** `awplus# configure terminal`  
`awplus(config)# router ospf 100`  
`awplus(config-router)# capability restart graceful`

# clear ip ospf process

**Overview** This command clears and restarts the OSPF routing process. Specify the Process ID to clear one particular OSPF process. When no Process ID is specified, this command clears all running OSPF processes.

**Syntax** `clear ip ospf [<0-65535>] process`

| Parameter | Description             |
|-----------|-------------------------|
| <0-65535> | The Routing Process ID. |

**Mode** Privileged Exec

**Example** `awplus# clear ip ospf process`

## compatible rfc1583

**Overview** This command changes the method used to calculate summary route to the that specified in RFC 1583. By default, OSPF uses the method specified in RFC 2328.

RFC 1583 specifies a method for calculating the metric for summary routes based on the minimum metric of the component paths available. RFC 2328 specifies a method for calculating metrics based on maximum cost.

It is possible that some ABRs in an area might conform to RFC 1583 and others support RFC 2328, which could lead to incompatibility in their interoperation. This command addresses this issue by allowing you to selectively disable compatibility with RFC 2328.

Use the **no** variant of this command to disable RFC 1583 compatibility.

**Syntax** compatible rfc1583  
no compatible rfc1583

**Mode** Router Configuration

**Example** awplus# configure terminal  
awplus(config)# router ospf 100  
awplus(config-router)# compatible rfc1583

# debug ospf events

**Overview** This command enables OSPF debugging for OSPF event troubleshooting.

To enable all debugging options, specify **debug ospf event** with no additional parameters.

The **no** and **undebug** variant of this command disable OSPF debugging. Use this command without parameters to disable all the options.

**Syntax**

```
debug ospf events [abr] [asbr] [lsa] [nssa] [os] [router] [vlink]
no debug ospf events [abr] [asbr] [lsa] [nssa] [os] [router] [vlink]
```

| Parameter | Description                  |
|-----------|------------------------------|
| abr       | Shows ABR events.            |
| asbr      | Shows ASBR events.           |
| lsa       | Shows LSA events.            |
| nssa      | Shows NSSA events.           |
| os        | Shows OS interaction events. |
| router    | Shows other router events.   |
| vlink     | Shows virtual link events.   |

**Mode** Privileged Exec and Global Configuration

**Example** awplus# debug ospf events asbr lsa

**Related Commands** [terminal monitor](#)  
[undebug ospf events](#)



# debug ospf ifsm

**Overview** This command specifies debugging options for OSPF Interface Finite State Machine (IFSM) troubleshooting.

To enable all debugging options, specify **debug ospf ifsm** with no additional parameters.

The **no** and **undebug** variant of this command disable OSPF IFSM debugging. Use this command without parameters to disable all the options.

**Syntax** `debug ospf ifsm [status] [events] [timers]`  
`no debug ospf ifsm [status] [events] [timers]`

| Parameter | Description                       |
|-----------|-----------------------------------|
| events    | Displays IFSM event information.  |
| status    | Displays IFSM status information. |
| timers    | Displays IFSM timer information.  |

**Mode** Privileged Exec and Global Configuration

**Example** `awplus# no debug ospf ifsm events status`  
`awplus# debug ospf ifsm status`  
`awplus# debug ospf ifsm timers`

**Related Commands** [terminal monitor](#)  
[undebug ospf ifsm](#)

# debug ospf lsa

**Overview** This command enables debugging options for OSPF Link State Advertisements (LSA) troubleshooting. This displays information related to internal operations of LSAs.

To enable all debugging options, specify **debug ospf lsa** with no additional parameters.

The **no** and **undebug** variant of this command disable OSPF LSA debugging. Use this command without parameters to disable all the options.

**Syntax**

```
debug ospf lsa [flooding] [generate] [install] [maxage] [refresh]
no debug ospf lsa [flooding] [generate] [install] [maxage] [refresh]
```

| Parameter | Description                              |
|-----------|------------------------------------------|
| flooding  | Displays LSA flooding.                   |
| generate  | Displays LSA generation.                 |
| install   | Show LSA installation.                   |
| maxage    | Shows maximum age of the LSA in seconds. |
| refresh   | Displays LSA refresh.                    |

**Mode** Privileged Exec and Global Configuration

**Examples** awplus# undebug ospf lsa refresh

**Output** Figure 29-1: Example output from the **debug ospf lsa** command

```
2002/05/09 14:08:11 OSPF: LSA[10.10.10.10:10.10.10.70]: instance(0x8139cd0)
created with Link State Update
2002/05/09 14:08:11 OSPF: RECV[LS-Upd]: From 10.10.10.70 via vlan5:10.10.10.50
(10.10.10.10 -> 224.0.0.5)
2002/05/09 14:12:33 OSPF: SEND[LS-Upd]: Begin send queue
2002/05/09 14:12:33 OSPF: SEND[LS-Upd]: # of LSAs 1, destination 224.0.0.5
2002/05/09 14:12:33 OSPF: SEND[LS-Upd]: End send queue
2002/05/09 14:12:33 OSPF: SEND[LS-Upd]: To 224.0.0.5 via vlan5:10.10.10.50
```

**Related Commands** [terminal monitor](#)  
[undebug ospf lsa](#)

# debug ospf nfsm

**Overview** This command enables debugging options for OSPF Neighbor Finite State Machines (NFSMs).

To enable all debugging options, specify **debug ospf nfsm** with no additional parameters.

The **no** and **undebug** variant of this command disable OSPF NFSM debugging. Use this command without parameters to disable all the options.

**Syntax** `debug ospf nfsm [events] [status] [timers]`  
`no debug ospf nfsm [events] [status] [timers]`

| Parameter | Description                       |
|-----------|-----------------------------------|
| events    | Displays NFSM event information.  |
| status    | Displays NFSM status information. |
| timers    | Displays NFSM timer information.  |

**Mode** Privileged Exec and Global Configuration

**Examples** `awplus# debug ospf nfsm events`  
`awplus# no debug ospf nfsm timers`  
`awplus# undebug ospf nfsm events`

**Related Commands** [terminal monitor](#)  
[undebug ospf nfsm](#)

# debug ospf nsm

**Overview** This command enables debugging options for the OSPF Network Service Module. To enable both debugging options, specify **debug ospf nsm** with no additional parameters.

The **no** and **undebug** variant of this command disable OSPF NSM debugging. Use this command without parameters to disable both options.

**Syntax** `debug ospf nsm [interface] [redistribute]`  
`no debug ospf nsm [interface] [redistribute]`

| Parameter    | Description                           |
|--------------|---------------------------------------|
| interface    | Specify NSM interface information.    |
| redistribute | Specify NSM redistribute information. |

**Mode** Privileged Exec and Global Configuration

**Examples** `awplus# debug ospf nsm interface`  
`awplus# no debug ospf nsm redistribute`  
`awplus# undebug ospf nsm interface`

**Related Commands** [terminal monitor](#)  
[undebug ospf nsm](#)

# debug ospf packet

**Overview** This command enables debugging options for OSPF packets.

To enable all debugging options, specify **debug ospf packet** with no additional parameters.

The **no** and **undebug** variant of this command disable OSPF packet debugging. Use this command without parameters to disable all options.

**Syntax** `debug ospf packet [dd] [detail] [hello] [ls-ack] [ls-request] [ls-update] [recv] [send]`  
`no debug ospf packet [dd] [detail] [hello] [ls-ack] [ls-request] [ls-update] [recv] [send]`

| Parameter  | Description                                              |
|------------|----------------------------------------------------------|
| dd         | Specifies debugging for OSPF database descriptions.      |
| detail     | Sets the debug option to detailed information.           |
| hello      | Specifies debugging for OSPF hello packets.              |
| ls-ack     | Specifies debugging for OSPF link state acknowledgments. |
| ls-request | Specifies debugging for OSPF link state requests.        |
| ls-update  | Specifies debugging for OSPF link state updates.         |
| recv       | Specifies the debug option set for received packets.     |
| send       | Specifies the debug option set for sent packets.         |

**Mode** Privileged Exec and Global Configuration

**Examples** `awplus# debug ospf packet detail`  
`awplus# debug ospf packet dd send detail`  
`awplus# no debug ospf packet ls-request recv detail`  
`awplus# undebug ospf packet ls-request recv detail`

**Related Commands** [terminal monitor](#)  
[undebug ospf packet](#)

# debug ospf route

**Overview** This command enables debugging of route calculation. Use this command without parameters to turn on all the options.

To enable all debugging options, specify **debug ospf route** with no additional parameters.

The **no** and **undebug** variant of this command disable OSPF route debugging. Use this command without parameters to disable all options.

**Syntax** `debug ospf route [ase] [ia] [install] [spf]`  
`no debug ospf route [ase] [ia] [install] [spf]`

| Parameter | Description                                              |
|-----------|----------------------------------------------------------|
| ia        | Specifies the debugging of Inter-Area route calculation. |
| ase       | Specifies the debugging of external route calculation.   |
| install   | Specifies the debugging of route installation.           |
| spf       | Specifies the debugging of SPF calculation.              |

**Mode** Privileged Exec and Global Configuration

**Examples** `awplus# debug ospf route`  
`awplus# no debug ospf route ia`  
`awplus# debug ospf route install`  
`awplus# undebug ospf route install`

**Related Commands** [terminal monitor](#)  
[undebug ospf route](#)

# default-information originate

**Overview** This command creates a default external route into an OSPF routing domain.

When you use the **default-information originate** command to redistribute routes into an OSPF routing domain, then the system acts like an Autonomous System Boundary Router (ASBR). By default, an ASBR does not generate a default route into the OSPF routing domain.

When using this command, also specify the **route-map <route-map>** option to avoid a dependency on the default network in the routing table.

The **metric-type** is an external link type associated with the default route advertised into the OSPF routing domain. The value of the external route could be either Type 1 or 2. The default is Type 2.

The **no** variant of this command disables this feature.

**Syntax**

```
default-information originate [always] [metric <metric>]
[metric-type <1-2>] [route-map <route-map>]

no default-information originate [always] [metric]
[metric-type] [route-map]
```

| Parameter   | Description                                                                                                                                                                |
|-------------|----------------------------------------------------------------------------------------------------------------------------------------------------------------------------|
| always      | Used to advertise the default route regardless of whether there is a default route.                                                                                        |
| <metric>    | The metric value used in creating the default route. Enter a value in the range 0 to 16777214. The default metric value is 10. The value used is specific to the protocol. |
| <1-2>       | External metric type for default routes, either OSPF External Type 1 or Type 2 metrics. Enter the value 1 or 2.                                                            |
| route-map   | Specifies to use a specific route-map.                                                                                                                                     |
| <route-map> | The route-map name. It is a string comprised of any characters, numbers or symbols.                                                                                        |

**Mode** Router Configuration

**Example**

```
awplus# configure terminal
awplus(config)# router ospf 100
awplus(config-router)# default-information originate always
metric 23 metric-type 2 route-map myinfo
```

**Related Commands** [route-map](#)

# default-metric (OSPF)

**Overview** This command sets default metric values for the OSPF routing protocol. The **no** variant of this command returns OSPF to using built-in, automatic metric translations, as appropriate for each routing protocol.

**Syntax** `default-metric <1-16777214>`  
`no default-metric [<1-16777214>]`

| Parameter                       | Description                                                          |
|---------------------------------|----------------------------------------------------------------------|
| <code>&lt;1-16777214&gt;</code> | Default metric value appropriate for the specified routing protocol. |

**Mode** Router Configuration

**Usage** A default metric facilitates redistributing routes even with incompatible metrics. If the metrics do not convert, the default metric provides an alternative and enables the redistribution to continue. The effect of this command is that OSPF will use the same metric value for **all** redistributed routes. Use this command in conjunction with the [redistribute \(OSPF\)](#) command.

**Examples**

```
awplus# configure terminal
awplus(config)# router ospf 100
awplus(config-router)# default-metric 100
awplus# configure terminal
awplus(config)# router ospf 100
awplus(config-router)# no default-metric
```

**Related commands** [redistribute \(OSPF\)](#)



# distance (OSPF)

**Overview** This command sets the administrative distance for OSPF routes based on the route type. Your device uses this value to select between two or more routes to the same destination from two different routing protocols. The route with the smallest administrative distance value is added to the Forwarding Information Base (FIB). See the [Route Selection Feature Overview and Configuration Guide](#) for more information.

Use the command **distance ospf** to set the distance for an entire category of OSPF routes, rather than the specific routes that pass an access list.

Use the command **distance <1-255>**, with no other parameter, to set the same distance for all OSPF route types.

The **no** variant of this command sets the administrative distance for all OSPF routes to the default of 110.

**Syntax**

```
distance <1-255>
distance ospf {external <1-255>|inter-area <1-255>|intra-area <1-255>}
no distance {ospf|<1-255>}
```

| Parameter  | Description                                                                                                                                 |
|------------|---------------------------------------------------------------------------------------------------------------------------------------------|
| <1-255>    | Specify the Administrative Distance value for OSPF routes.                                                                                  |
| external   | Sets the distance for routes from other routing domains, learned by redistribution. Specify an OSPF external distance in the range <1-255>. |
| inter-area | Sets the distance for all routes from one area to another area. Specify an OSPF inter-area distance in the range <1-255>.                   |
| intra-area | Sets the distance for all routes within an area. Specify an OSPF intra-area distance in the range <1-255>.                                  |

**Default** The default OSPF administrative distance is 110. The default Administrative Distance for each type of route (intra, inter, or external) is 110.

**Mode** Router Configuration

**Usage** The administrative distance rates the trustworthiness of a routing information source. The distance could be any integer from 0 to 255. A higher distance value indicates a lower trust rating. For example, an administrative distance of 255 indicates that the routing information source cannot be trusted and should be ignored.

Use this command to set the distance for an entire group of routes, rather than a specific route that passes an access list.

**Examples** To set the following administrative distances for route types in OSPF 100:

- 20 for inter-area routes

- 10 for intra-area routes
- 40 for external routes

use the commands:

```
awplus(config)# router ospf 100
awplus(config-router)# distance ospf inter-area 20 intra-area
10 external 40
```

To set the administrative distance for all routes in OSPF 100 back to the default of 110, use the commands:

```
awplus(config)# router ospf 100
awplus(config-router)# no distance ospf
```

# enable db-summary-opt

**Overview** This command enables OSPF database summary list optimization.  
The **no** variant of this command disables database summary list optimization.

**Syntax** enable db-summary-opt  
no enable db-summary-opt

**Default** The default setting is disabled.

**Mode** Router Configuration

**Usage** When this feature is enabled, the database exchange process is optimized by removing the LSA from the database summary list for the neighbor, if the LSA instance in the database summary list is the same as, or less recent than, the listed LSA in the database description packet received from the neighbor.

**Examples** To enable OSPF database summary list optimization, use the commands:

```
awplus# configure terminal
awplus(config)# router ospf
awplus(config-router)# enable db-summary-opt
```

To disable OSPF database summary list optimization, use the commands:

```
awplus# configure terminal
awplus(config)# router ospf
awplus(config-router)# no enable db-summary-opt
```

**Validation  
Commands** show running-config

# host area

**Overview** This command configures a stub host entry belonging to a particular area. You can use this command to advertise specific host routes in the router-LSA as stub link. Since stub host belongs to the specified router, specifying cost is optional.

The **no** variant of this command removes the host area configuration.

**Syntax** `host <ip-address> area <area-id> [cost <0-65535>]`  
`no host <ip-address> area <area-id> [cost <0-65535>]`

| Parameter                         | Description                                                                                                                                                                                                                                                                      |
|-----------------------------------|----------------------------------------------------------------------------------------------------------------------------------------------------------------------------------------------------------------------------------------------------------------------------------|
| <code>&lt;ip-address&gt;</code>   | The IPv4 address of the host, in dotted decimal notation.                                                                                                                                                                                                                        |
| <code>&lt;area-id&gt;</code>      | The OSPF area ID of the transit area that configuring the stub host entry for. Use one of the following formats: <ul style="list-style-type: none"><li>dotted decimal format, e.g. 0.0.1.2.</li><li>normal decimal format in the range &lt;0-4294967295&gt;, e.g. 258.</li></ul> |
| <code>cost &lt;0-65535&gt;</code> | The cost for the stub host entry.                                                                                                                                                                                                                                                |

**Default** By default, no host entry is configured.

**Mode** Router Configuration

**Example**

```
awplus# configure terminal
awplus(config)# router ospf 100
awplus(config-router)# host 172.16.10.100 area 1
awplus(config-router)# host 172.16.10.101 area 2 cost 10
```

# ip ospf authentication

**Overview** This command sets the authentication method used when sending and receiving OSPF packets on the current VLAN interface. The default is to use no authentication. If no authentication method is specified in this command, then plain text authentication will be used.

The **no** variant of this command disables the authentication.

**Syntax** `ip ospf [<ip-address>] authentication [message-digest|null]`  
`no ip ospf [<ip-address>] authentication`

| Parameter      | Description                                                                                     |
|----------------|-------------------------------------------------------------------------------------------------|
| <ip-address>   | The IP address of the interface.                                                                |
| message-digest | Use the message digest authentication.                                                          |
| null           | Use no authentication. It overrides password or message-digest authentication of the interface. |

**Mode** Interface Configuration for a VLAN interface or a PPP interface.

**Usage** Use the [ip ospf authentication](#) command to specify a Simple Text password. Use the [ip ospf message-digest-key](#) command to specify MD5 password.

**Example** In this example, VLAN interface `vlan2` is configured to have no authentication. This will override any text or MD5 authentication configured on this interface.

```
awplus# configure terminal
awplus(config)# interface vlan2
awplus(config-if)# ip ospf authentication null
```

In this example, PPP interface `ppp0` is configured to have no authentication. This will override any text or MD5 authentication configured on this interface.

```
awplus# configure terminal
awplus(config)# interface ppp0
awplus(config-if)# ip ospf authentication null
```

**Related Commands**

- [ip ospf authentication-key](#)
- [area authentication](#)
- [ip ospf message-digest-key](#)

# ip ospf authentication-key

**Overview** This command specifies an OSPF authentication password for the neighboring routers.

The **no** variant of this command removes the OSPF authentication password.

**Syntax** `ip ospf [<ip-address>] authentication-key <pswd-long>`  
`no ip ospf [<ip-address>] authentication-key`

| Parameter    | Description                                                                           |
|--------------|---------------------------------------------------------------------------------------|
| <ip-address> | The IPv4 address of the interface, in dotted decimal notation.                        |
| <pswd-long>  | Specifies the authentication password.<br>The string by the end of line will be used. |

**Default** By default, an authentication password is not specified.

**Mode** Interface Configuration for a VLAN interface or a PPP interface.

**Usage** This command creates a password (key) that is inserted into the OSPF header when AlliedWare Plus™ software originates routing protocol packets. Assign a separate password to each network for different VLAN interfaces. All neighboring routers on the same network with the same password exchange OSPF routing data.

The key can be used only when authentication is enabled for an area. Use the **area authentication** command to enable authentication.

Simple password authentication allows a password to be configured for each area. Configure the routers in the same routing domain with the same password.

**Example** In the following example, an authentication key test is created on VLAN interface `vlan2` in area 0. Note that first authentication is enabled for area 0.

```
awplus# configure terminal
awplus(config)# router ospf 100
awplus(config-router)# network 10.10.10.0/24 area 0
awplus(config-router)# area 0 authentication
awplus(config-router)# exit
awplus(config)# interface vlan2
awplus(config-if)# ip ospf 3.3.3.3 authentication-key test
```

In the following example, an authentication key test is created on PPP interface ppp0 in area 0. Note that first authentication is enabled for area 0.

```
awplus# configure terminal
awplus(config)# router ospf 100
awplus(config-router)# network 10.10.10.0/24 area 0
awplus(config-router)# area 0 authentication
awplus(config-router)# exit
awplus(config)# interface ppp0
awplus(config-if)# ip ospf 3.3.3.3 authentication-key test
```

**Related  
Commands** [area authentication](#)  
[ip ospf authentication](#)

# ip ospf cost

**Overview** This command explicitly specifies the cost of the link-state metric in a router-LSA. The **no** variant of this command resets the VLAN interface cost to the default.

**Syntax** `ip ospf [<ip-address>] cost <1-65535>`  
`no ip ospf [<ip-address>] cost`

| Parameter    | Description                                                    |
|--------------|----------------------------------------------------------------|
| <ip-address> | The IPv4 address of the interface, in dotted decimal notation. |
| <1-65535>    | The link-state metric.                                         |

**Default** By default there is no static value set and the OSPF cost is automatically calculated by using the [auto-cost reference bandwidth](#) command.

**Mode** Interface Configuration for a VLAN interface or a PPP interface.

**Usage** This command explicitly sets a user specified cost of sending packets out the interface. Using this command overrides the cost value calculated automatically with the auto-cost reference bandwidth feature.

The interface cost indicates the overhead required to send packets across a certain VLAN interface. This cost is stated in the Router-LSA's link. Typically, the cost is inversely proportional to the bandwidth of an interface. By default, the cost of a VLAN interface is calculated according to the following formula:

$$\text{reference bandwidth} / \text{interface bandwidth}$$

To set the VLAN interface cost manually, use this command.

**Example** The following example shows setting ospf cost to 10 on VLAN interface `vlan25` for IP address `10.10.10.50`

```
awplus# configure terminal
awplus(config)# interface vlan25
awplus(config-if)# ip ospf 10.10.10.50 cost 10
```

The following example shows setting ospf cost to 10 on PPP interface `ppp0` for IP address `10.10.10.50`

```
awplus# configure terminal
awplus(config)# interface ppp0
awplus(config-if)# ip ospf 10.10.10.50 cost 10
```

**Related Commands** [show ip ospf interface](#)  
[auto-cost reference bandwidth](#)



# ip ospf database-filter

**Overview** This command turns on the LSA database-filter for a particular VLAN interface. The **no** variant of this command turns off the LSA database-filter.

**Syntax** `ip ospf [<ip-address>] database-filter all out`  
`no ip ospf [<ip-address>] database-filter`

| Parameter    | Description                                                    |
|--------------|----------------------------------------------------------------|
| <ip-address> | The IPv4 address of the interface, in dotted decimal notation. |

**Default** By default, all outgoing LSAs are flooded to the interface.

**Mode** Interface Configuration for a VLAN interface or a PPP interface.

**Usage** OSPF floods new LSAs over all interfaces in an area, except the interface on which the LSA arrives. This redundancy ensures robust flooding. However, too much redundancy can waste bandwidth and might lead to excessive link and CPU usage in certain topologies, resulting in destabilizing the network. To avoid this, use the **ip ospf database-filter** command to block flooding of LSAs over specified interfaces.

**Example**

```
awplus# configure terminal
awplus(config)# interface vlan1
awplus(config-if# ip ospf database-filter all out
awplus# configure terminal
awplus(config)# interface ppp0
awplus(config-if# ip ospf database-filter all out
```

# ip ospf dead-interval

**Overview** This command sets the interval during which no hello packets are received and after which a neighbor is declared dead.

The dead-interval is the amount of time that OSPF waits to receive an OSPF hello packet from the neighbor before declaring the neighbor is down. This value is advertised in the router's hello packets. It must be a multiple of the hello-interval and be the same for all routers on a specific network.

The **no** variant of this command returns the interval to the default of 40 seconds. If you have configured this command specifying the IP address of the interface and want to remove the configuration, specify the IP address ( **no ip ospf**<ip-address> **dead-interval**).

**Syntax** ip ospf [<ip-address>] dead-interval <1-65535>  
no ip ospf [<ip-address>] dead-interval

| Parameter    | Description                                                    |
|--------------|----------------------------------------------------------------|
| <ip-address> | The IPv4 address of the interface, in dotted decimal notation. |
| <1-65545>    | The interval in seconds.<br>Default: 40                        |

**Mode** Interface Configuration for a VLAN interface or a PPP interface.

**Example** The following example shows configuring the dead-interval to 10 seconds on the VLAN interface vlan2.

```
awplus# configure terminal
awplus(config)# interface vlan2
awplus(config-if)# ip ospf dead-interval 10
```

The following example shows configuring the dead-interval to 10 seconds on the PPP interface ppp0.

```
awplus# configure terminal
awplus(config)# interface ppp0
awplus(config-if)# ip ospf dead-interval 10
```

**Related Commands** ip ospf hello-interval  
show ip ospf interface

# ip ospf disable all

**Overview** This command completely disables OSPF packet processing on a VLAN interface. It overrides the [network area](#) command and disables the processing of packets on the specific interface.

Use the **no** variant of this command to restore OSPF packet processing on a selected interface.

**Syntax** ip ospf disable all  
no ip ospf disable all

**Mode** Interface Configuration for a VLAN interface or a PPP interface.

**Example**

```
awplus# configure terminal
awplus(config)# interface vlan2
awplus(config-if)# ip ospf disable all
awplus# configure terminal
awplus(config)# interface ppp0
awplus(config-if)# ip ospf disable all
```

# ip ospf hello-interval

**Overview** This command specifies the interval between hello packets.

The hello-interval is advertised in the hello packets. Configure the same hello-interval for all routers on a specific network. A shorter hello interval ensures faster detection of topological changes, but results in more routing traffic.

The **no** variant of this command returns the interval to the default of 10 seconds.

**Syntax** `ip ospf [<ip-address>] hello-interval <1-65535>`  
`no ip ospf [<ip-address>] hello-interval`

| Parameter    | Description                                                  |
|--------------|--------------------------------------------------------------|
| <ip-address> | The IP address of the interface, in dotted decimal notation. |
| <1-65535>    | The interval in seconds.<br>Default: 10                      |

**Default** The default interval is 10 seconds.

**Mode** Interface Configuration for a VLAN interface or a PPP interface.

**Example** The following example shows setting the hello-interval to 3 seconds on VLAN interface vlan2.

```
awplus# configure terminal
awplus(config)# interface vlan2
awplus(config-if)# ip ospf hello-interval 3
```

The following example shows setting the hello-interval to 3 seconds on the PPP interface ppp0.

```
awplus# configure terminal
awplus(config)# interface ppp0
awplus(config-if)# ip ospf hello-interval 3
```

**Related Commands** [ip ospf dead-interval](#)  
[show ip ospf interface](#)

# ip ospf message-digest-key

**Overview** This command registers an MD5 key for OSPF MD5 authentication.

Message Digest Authentication is a cryptographic authentication. A key (password) and key-id are configured on each router. The router uses an algorithm based on the OSPF packet, the key, and the key-id to generate a message digest that gets appended to the packet.

The **no** variant of this command removes the MD5 key.

**Syntax**

```
ip ospf [<ip-address>] message-digest-key <key-id> md5
<pswd-long>

no ip ospf [<ip-address>] message-digest-key <key-id>
```

| Parameter    | Description                                                                 |
|--------------|-----------------------------------------------------------------------------|
| <ip-address> | The IPv4 address of the interface, in dotted decimal notation.              |
| <key-id>     | A key ID number specified as an integer between 1 and 255.                  |
| md5          | Use the MD5 algorithm.                                                      |
| <pswd-long>  | The OSPF password. This is a string of 1 to 16 characters including spaces. |

**Default** By default, there is no MD5 key registered.

**Mode** Interface Configuration for a VLAN interface or a PPP interface.

**Usage** Use this command for uninterrupted transitions between passwords. It allows you to add a new key without having to delete the existing key. While multiple keys exist, all OSPF packets will be transmitted in duplicate; one copy of the packet will be transmitted for each of the current keys. This is helpful for administrators who want to change the OSPF password without disrupting communication. The system begins a rollover process until all the neighbors have adopted the new password. This allows neighboring routers to continue communication while the network administrator is updating them with a new password. The router will stop sending duplicate packets once it detects that all of its neighbors have adopted the new password.

Maintain only one password per interface, removing the old password whenever you add a new one. This will prevent the local system from continuing to communicate with the system that is using the old password. Removing the old password also reduces overhead during rollover. All neighboring routers on the same network must have the same password value to enable exchange of OSPF routing data.

**Examples** The following example shows OSPF authentication on the VLAN interface `vlan5` when IP address has not been specified.

```
awplus# configure terminal
awplus(config)# interface vlan5
awplus(config-if)# ip ospf authentication message-digest
awplus(config-if)# ip ospf message-digest-key 1 md5 yourpass
```

The following example shows OSPF authentication on the PPP interface `ppp0` when IP address has not been specified.

```
awplus# configure terminal
awplus(config)# interface ppp0
awplus(config-if)# ip ospf authentication message-digest
awplus(config-if)# ip ospf message-digest-key 1 md5 yourpass
```

The following example shows configuring OSPF authentication on the VLAN interface `vlan2` for the IP address `1.1.1.1`. (If the interface has two IP addresses assigned-- `1.1.1.1` & `2.2.2.2`, OSPF authentication will be enabled only for the IP address `1.1.1.1`).

```
awplus# configure terminal
awplus(config)# interface vlan2
awplus(config-if)# ip ospf 1.1.1.1 authentication
message-digest
awplus(config-if)# ip ospf 1.1.1.1 message-digest-key 2 md5
yourpass
```

## ip ospf mtu

**Overview** This command sets the MTU size for OSPF. Whenever OSPF constructs packets, it uses VLAN interface MTU size as Maximum IP packet size. This command forces OSPF to use the specified value, overriding the actual VLAN interface MTU size.

Use the **no** variant of this command to return the MTU size to the default.

**Syntax** `ip ospf mtu <576-65535>`  
`no ip ospf mtu`

**Default** By default, OSPF uses interface MTU derived from the VLAN interface.

**Mode** Interface Configuration for a VLAN interface or a PPP interface.

**Usage** This command allows an administrator to configure the MTU size recognized by the OSPF protocol. It does not configure the MTU settings on the VLAN interface. OSPF will not recognize MTU size configuration changes made to the kernel until the MTU size is updated through the CLI.

**Example**

```
awplus# configure terminal
awplus(config)# interface vlan2
awplus(config-if)# ip ospf mtu 1480
awplus# configure terminal
awplus(config)# interface pp0
awplus(config-if)# ip ospf mtu 1480
```

# ip ospf mtu-ignore

**Overview** Use this command to configure OSPF so that OSPF does not check the MTU size during DD (Database Description) exchange.

Use the **no** variant of this command to make sure that OSPF checks the MTU size during DD exchange.

**Syntax** `ip ospf [<ip-address>] mtu-ignore`  
`no ip ospf [<ip-address>] mtu-ignore`

| Parameter                       | Description                                                |
|---------------------------------|------------------------------------------------------------|
| <code>&lt;ip-address&gt;</code> | IPv4 address of the interface, in dotted decimal notation. |

**Mode** Interface Configuration for a VLAN interface or a PPP interface.

**Usage** By default, during the DD exchange process, OSPF checks the MTU size described in the DD packets received from the neighbor. If the MTU size does not match the interface MTU, the neighbor adjacency is not established. Using this command makes OSPF ignore this check and allows establishing of adjacency regardless of MTU size in the DD packet.

**Example**

```
awplus# configure terminal
awplus(config)# interface vlan2
awplus(config-if)# ip ospf mtu-ignore
awplus# configure terminal
awplus(config)# interface ppp0
awplus(config-if)# ip ospf mtu-ignore
```



# ip ospf network

**Overview** This command configures the OSPF network type to a type different from the default for the particular VLAN interface.

The **no** variant of this command returns the network type to the default for the particular VLAN interface.

**Syntax** `ip ospf network [broadcast|non-broadcast|point-to-point|point-to-multipoint]`  
`no ip ospf network`

| Parameter                        | Description                                   |
|----------------------------------|-----------------------------------------------|
| <code>broadcast</code>           | Sets the network type to broadcast.           |
| <code>non-broadcast</code>       | Sets the network type to NBMA.                |
| <code>point-to-multipoint</code> | Sets the network type to point-to-multipoint. |
| <code>point-to-point</code>      | Sets the network type to point-to-point.      |

**Default** The default is the `broadcast` OSPF network type for a VLAN interface.

**Mode** Interface Configuration for a VLAN interface or a PPP interface.

**Usage** This command forces the interface network type to the specified type. Depending on the network type, OSPF changes the behavior of the packet transmission and the link description in LSAs.

**Example** The following example shows setting the network type to `point-to-point` on the VLAN interface `vlan2`.

```
awplus# configure terminal
awplus(config)# interface vlan2
awplus(config-if)# ip ospf network point-to-point
```

The following example shows setting the network type to `point-to-point` on the PPP interface `ppp0`.

```
awplus# configure terminal
awplus(config)# interface ppp0
awplus(config-if)# ip ospf network point-to-point
```

# ip ospf priority

**Overview** This command sets the router priority, which is a parameter used in the election of the designated router for the network.

The **no** variant of this command returns the router priority to the default of 1.

**Syntax** `ip ospf [<ip-address>] priority <priority>`  
`no ip ospf [<ip-address>] priority`

| Parameter    | Description                                             |
|--------------|---------------------------------------------------------|
| <ip-address> | The IP address of the interface.                        |
| <priority>   | <0-255> Specifies the Router Priority of the interface. |

**Default** The router priority for an interface is set to 1 by default.

**Mode** Interface Configuration for a VLAN interface or a PPP interface.

**Usage** Set the priority to help determine the OSPF Designated Router (DR) for a network. If two routers attempt to become the DR, the router with the higher router priority becomes the DR. If the router priority is the same for two routers, the router with the higher router ID takes precedence.

Only routers with nonzero router priority values are eligible to become the designated or backup designated router.

Configure router priority for multi-access networks only and not for point-to-point networks.

**Example** The following example shows setting the OSPF priority value to 3 on the VLAN interface `vlan2`.

```
awplus# configure terminal
awplus(config)# interface vlan2
awplus(config-if)# ip ospf priority 3
```

The following example shows setting the OSPF priority value to 3 on the PPP interface `ppp0`.

```
awplus# configure terminal
awplus(config)# interface ppp0
awplus(config-if)# ip ospf priority 3
```

**Related Commands** [ip ospf network](#)

# ip ospf resync-timeout

**Overview** Use this command to set the interval after which adjacency is reset if out-of-band resynchronization has not occurred. The interval period starts from the time a restart signal is received from a neighbor.

Use the **no** variant of this command to return to the default.

**Syntax** `ip ospf [<ip-address>] resync-timeout <1-65535>`  
`no ip ospf [<ip-address>] resync-timeout`

| Parameter    | Description                                                                |
|--------------|----------------------------------------------------------------------------|
| <ip-address> | The IP address of the interface.                                           |
| <1-65535>    | Specifies the resynchronization timeout value of the interface in seconds. |

**Mode** Interface Configuration for a VLAN interface or a PPP interface.

**Example** The following example shows setting the OSPF resynchronization timeout value to 65 seconds on the VLAN interface `vlan2`.

```
awplus# configure terminal
awplus(config)# interface vlan2
awplus(config-if)# ip ospf resync-timeout 65
```

The following example shows setting the OSPF resynchronization timeout value to 65 seconds on the PPP interface `ppp0`.

```
awplus# configure terminal
awplus(config)# interface ppp0
awplus(config-if)# ip ospf resync-timeout 65
```

# ip ospf retransmit-interval

**Overview** Use this command to specify the time between link-state advertisement (LSA) retransmissions for adjacencies belonging to the interface.

Use the **no** variant of this command to return to the default of 5 seconds.

**Syntax** `ip ospf [<ip-address>] retransmit-interval <1-65535>`  
`no ip ospf [<ip-address>] retransmit-interval`

| Parameter    | Description                        |
|--------------|------------------------------------|
| <ip-address> | The IP address of the interface.   |
| <1-65535>    | Specifies the interval in seconds. |

**Default** The default interval is 5 seconds.

**Mode** Interface Configuration for a VLAN interface or a PPP interface.

**Usage** After sending an LSA to a neighbor, the router keeps the LSA until it receives an acknowledgment. In case the router does not receive an acknowledgment during the set time (the retransmit interval value) it retransmits the LSA. Set the retransmission interval value conservatively to avoid needless retransmission. The interval should be greater than the expected round-trip delay between two routers.

**Example** The following example shows setting the `ospf retransmit interval` to 6 seconds on the VLAN interface `vlan2`.

```
awplus# configure terminal
awplus(config)# interface vlan2
awplus(config-if)# ip ospf retransmit-interval 6
```

The following example shows setting the `ospf retransmit interval` to 6 seconds on the PPP interface `ppp0`.

```
awplus# configure terminal
awplus(config)# interface ppp0
awplus(config-if)# ip ospf retransmit-interval 6
```

# ip ospf transmit-delay

**Overview** Use this command to set the estimated time it takes to transmit a link-state-update packet on the VLAN interface.

Use the **no** variant of this command to return to the default of 1 second.

**Syntax** `ip ospf [<ip-address>] transmit-delay <1-65535>`  
`no ip ospf [<ip-address>] transmit-delay`

| Parameter    | Description                                                      |
|--------------|------------------------------------------------------------------|
| <ip-address> | The IP address of the VLAN interface.                            |
| <1-65535>    | Specifies the time, in seconds, to transmit a link-state update. |

**Default** The default interval is 1 second.

**Mode** Interface Configuration for a VLAN interface or a PPP interface.

**Usage** The transmit delay value adds a specified time to the age field of an update. If the delay is not added, the time in which the LSA transmits over the link is not considered. This command is especially useful for low speed links. Add transmission and propagation delays when setting the transmit delay value.

**Example** The following example shows setting the OSPF transmit delay time to 3 seconds on the VLAN interface `vlan2`.

```
awplus# configure terminal
awplus(config)# interface vlan2
awplus(config-if)# ip ospf transmit-delay 3
```

The following example shows setting the OSPF transmit delay time to 3 seconds on the PPP interface `ppp0`.

```
awplus# configure terminal
awplus(config)# interface ppp0
awplus(config-if)# ip ospf transmit-delay 3
```

# max-concurrent-dd

**Overview** Use this command to set the limit for the number of Database Descriptors (DD) that can be processed concurrently.

Use the **no** variant of this command to reset the limit for the number of Database Descriptors (DD) that can be processed concurrently.

**Syntax** `max-concurrent-dd <1-65535>`  
`no max-concurrent-dd`

| Parameter | Description                         |
|-----------|-------------------------------------|
| <1-65535> | Specify the number of DD processes. |

**Mode** Router Configuration

**Usage** This command is useful when a router's performance is affected from simultaneously bringing up several OSPF adjacencies. This command limits the maximum number of DD exchanges that can occur concurrently per OSPF instance, thus allowing for all of the adjacencies to come up.

**Example** The following example sets the max-concurrent-dd value to 4, so that only 4 DD exchanges will be processed at a time.

```
awplus# configure terminal
awplus(config)# router ospf 100
awplus(config-router)# max-concurrent-dd 4
```

# maximum-area

**Overview** Use this command to set the maximum number of OSPF areas.

Use the **no** variant of this command to set the maximum number of OSPF areas to the default.

**Syntax** `maximum-area <1-4294967294>`  
`no maximum-area`

| Parameter                         | Description                               |
|-----------------------------------|-------------------------------------------|
| <code>&lt;1-4294967294&gt;</code> | Specify the maximum number of OSPF areas. |

**Default** The default for the maximum number of OSPF areas is 4294967294.

**Mode** Router Configuration

**Usage** Use this command in router OSPF mode to specify the maximum number of OSPF areas.

**Examples** The following example sets the maximum number of OSPF areas to 2:

```
awplus# configure terminal
awplus(config)# router ospf 100
awplus(config-router)# maximum-area 2
```

The following example removes the maximum number of OSPF areas and resets to default:

```
awplus# configure terminal
awplus(config)# router ospf 100
awplus(config-router)# no maximum-area
```

# neighbor (OSPF)

**Overview** Use this command to inform the router of other neighboring routers that are connected to the same NBMA network.

Use the **no** variant of this command to remove a configuration.

**Syntax** `neighbor <ip-address> [<cost>]{<priority>|<poll-interval>}`  
`no neighbor <ip-address> [<cost>]{<priority>|<poll-interval>}`

| Parameter                          | Description                                                                                                                                                                                                                   |
|------------------------------------|-------------------------------------------------------------------------------------------------------------------------------------------------------------------------------------------------------------------------------|
| <code>&lt;ip-address&gt;</code>    | Specifies the interface IP address of the neighbor.                                                                                                                                                                           |
| <code>&lt;priority&gt;</code>      | <i>priority &lt;0-255&gt;</i><br>Specifies the router priority value of the non-broadcast neighbor associated with the specified IP address. The default is 0. This keyword does not apply to point-to-multipoint interfaces. |
| <code>&lt;poll-interval&gt;</code> | <i>poll-interval &lt;1-2147483647&gt;</i><br>Dead neighbor polling interval in seconds. It is recommended to set this value much higher than the hello interval. The default is 120 seconds.                                  |
| <code>&lt;cost&gt;</code>          | <i>cost &lt;1-65535&gt;</i><br>Specifies the link-state metric to this neighbor.                                                                                                                                              |

**Mode** Router Configuration

**Usage** To configure a neighbor on an NBMA network manually, use the `neighbor` command and include one neighbor entry for each known nonbroadcast network neighbor. The IP address used in this command is the neighbor's primary IP address on the interface where that neighbor connects to the NBMA network.

The poll interval is the reduced rate at which routers continue to send hello packets, when a neighboring router has become inactive. Set the poll interval to be much larger than hello interval.

**Examples** This example shows a neighbor configured with a priority value, poll interval time, and cost.

```
awplus# configure terminal
awplus(config)# router ospf 100
awplus(config-router)# neighbor 1.2.3.4 priority 1
poll-interval 90
awplus(config-router)# neighbor 1.2.3.4 cost 15
```



# network area

**Overview** Use this command to enable OSPF routing with a specified Area ID on any interfaces with IP addresses that match the specified network address.

Use the **no** variant of this command to disable OSPF routing on the interfaces.

**Syntax** `network <network-address> area <area-id>`  
`no network <network-address> area <area-id>`

| Parameter                   | Description                                                                                                                                                                                                                     |
|-----------------------------|---------------------------------------------------------------------------------------------------------------------------------------------------------------------------------------------------------------------------------|
| <network-address>           | {<ip-network/m> <ip-addr><br><reverse-mask>}                                                                                                                                                                                    |
| <ip-network/m>              | IP address of the network, entered in the form A.B.C.D/M.<br>Dotted decimal notation followed by a forward slash, and then the subnet mask length.                                                                              |
| <ip-addr><br><reverse-mask> | IPv4 network address, entered in the form A.B.C.D, followed by the mask. Enter the mask as a wildcard, or reverse, mask (e.g. 0.0.0.255). Note that the device displays the mask as a subnet mask in the running configuration. |
| <area-id>                   | {<ip-addr> <0-4294967295>}                                                                                                                                                                                                      |
| <ip-addr>                   | OSPF Area ID in IPv4 address format, in the form A.B.C.D.                                                                                                                                                                       |
| <0-4294967295>              | OSPF Area ID as 4 octets unsigned integer value.                                                                                                                                                                                |

**Default** No **network area** is configured by default.

**Mode** Router Configuration

**Usage** OSPF routing can be enabled per IPv4 subnet. The network address can be defined using either the prefix length or a wild card mask. A wild card mask is comprised of consecutive 0's as network bits and consecutive 1's as host bits.

**Examples** The following commands show the use of the **network area** command with OSPF multiple instance support disabled:

```
awplus# configure terminal
awplus(config)# router ospf 100
awplus(config-router)# network 10.0.0.0/8 area 3
awplus(config-router)# network 10.0.0.0/8 area 1.1.1.1
```

The following commands disable OSPF routing with Area ID 3 on all interfaces:

```
awplus# configure terminal
awplus(config)# router ospf 100
awplus(config-router)# no network 10.0.0.0/8 area3
```

# ospf abr-type

**Overview** Use this command to set an OSPF Area Border Router (ABR) type.  
Use the **no** variant of this command to revert the ABR type to the default setting (Cisco).

**Syntax** `ospf abr-type {cisco|ibm|standard}`  
`no ospf abr-type {cisco|ibm|standard}`

| Parameter | Description                                                                                       |
|-----------|---------------------------------------------------------------------------------------------------|
| cisco     | Specifies an alternative ABR using Cisco implementation (RFC 3509). This is the default ABR type. |
| ibm       | Specifies an alternative ABR using IBM implementation (RFC 3509).                                 |
| standard  | Specifies a standard behavior ABR (RFC 2328).                                                     |

**Default** ABR type `Cisco`

**Mode** Router Configuration

**Usage** Specifying the ABR type allows better interoperability between different implementations. This command is specially useful in a multi-vendor environment. The different ABR types are:

- Cisco ABR Type: By this definition, a router is considered an ABR if it has more than one area actively attached and one of them is the backbone area.
- IBM ABR Type: By this definition, a router is considered an ABR if it has more than one area actively attached and the backbone area is configured. In this case the configured backbone need not be actively connected.
- Standard ABR Type: By this definition, a router is considered an ABR if it has more than one area actively attached to it.

**Example** `awplus# configure terminal`  
`awplus(config)# router ospf 100`  
`awplus(config-router)# ospf abr-type ibm`

# ospf restart grace-period

**Overview** Use this command to configure the grace-period for restarting OSPF routing. Use the **no** variant of this command to revert to the default grace-period.

**Syntax** ospf restart grace-period <1-1800>  
no ospf restart grace-period

| Parameter | Description                            |
|-----------|----------------------------------------|
| <1-1800>  | Specifies the grace period in seconds. |

**Default** In the AlliedWare Plus™ OSPF implementation, the default OSPF grace-period is 180 seconds.

**Mode** Global Configuration

**Usage** Use this command to enable the OSPF Graceful Restart feature and set the restart grace-period. Changes from the default restart grace-period are displayed in the running- config. The restart grace-period is not displayed in the running-config if it has been reset to the default using the **no** variant of this command.

**Example** To set the OSPF restart grace-period to 250 seconds, use the commands:

```
awplus# configure terminal
awplus(config)# ospf restart grace-period 250
```

To reset the OSPF restart grace-period to the default (180 seconds), use the commands:

```
awplus# configure terminal
awplus(config)# no ospf restart grace-period
```

**Validation Commands** [show running-config](#)

**Related Commands** [ospf restart helper](#)  
[restart ospf graceful](#)

# ospf restart helper

**Overview** Use this command to configure the **helper** behavior for the OSPF Graceful Restart feature.

Use the **no** variant of this command to revert to the default grace-period.

**Syntax**

```
ospf restart helper {max-grace-period
<grace-period>|only-reload|only-upgrade}
ospf restart helper {never router-id <router-id>}
no ospf restart helper [max-grace-period]
```

| Parameter        | Description                                                                                                                       |
|------------------|-----------------------------------------------------------------------------------------------------------------------------------|
| max-grace-period | Specify help if received grace-period is less than a specified value.                                                             |
| <grace-period>   | Maximum grace period accepted in seconds in range <1-1800>.                                                                       |
| never            | Specify the local policy to never to act as a helper for this feature.                                                            |
| only-reload      | Specify help only on software reloads not software upgrades.                                                                      |
| only-upgrade     | Specify help only on software upgrades not software reloads.                                                                      |
| router-id        | Enter the router-id keyword to specify the OSPF Router ID that is never to act as a helper for the OSPF Graceful Restart feature. |
| <router-id>      | <A.B.C.D><br>Specify the OSPF Router ID in dotted decimal format A.B.C.D                                                          |

**Default** In the AlliedWare Plus™ OSPF implementation, the default OSPF grace-period is 180 seconds.

**Mode** Global Configuration

**Usage** The **ospf restart helper** command requires at least one parameter, but you may use more than one in the same command (excluding parameter **never**).

The **no** version of this command turns off the OSPF restart helper, while the **no ospf restart helper max-grace-period** command resets the max-grace-period, rather than the helper policy itself.

**Example**

```
awplus# configure terminal
awplus(config)# ospf restart helper only-reload
awplus# configure terminal
awplus(config)# ospf restart helper never router-id 10.10.10.1
awplus# configure terminal
awplus(config)# no ospf restart helper max-grace-period
```

**Related  
Commands** ospf restart grace-period  
restart ospf graceful

# ospf router-id

**Overview** Use this command to specify a router ID for the OSPF process.  
Use the **no** variant of this command to disable this function.

**Syntax** ospf router-id *<ip-address>*  
no ospf router-id

| Parameter                 | Description                                     |
|---------------------------|-------------------------------------------------|
| <i>&lt;ip-address&gt;</i> | Specifies the router ID in IPv4 address format. |

**Mode** Router Configuration

**Usage** Configure each router with a unique router-id. In an OSPF router process that has active neighbors, a new router-id takes effect at the next reload or when you restart OSPF manually.

**Example** The following example shows a specified router ID 2.3.4.5.

```
awplus# configure terminal
awplus(config)# router ospf 100
awplus(config-router)# ospf router-id 2.3.4.5
```

**Related Commands** [show ip ospf](#)

# overflow database

**Overview** Use this command to limit the maximum number of Link State Advertisements (LSAs) that can be supported by the current OSPF instance.

Use the **no** variant of this command to have no limit on the maximum number of LSAs.

**Syntax** `overflow database <0-4294967294> {hard|soft}`  
`no overflow database`

| Parameter      | Description                                                                |
|----------------|----------------------------------------------------------------------------|
| <0-4294967294> | The maximum number of LSAs.                                                |
| hard           | Shutdown occurs if the number of LSAs exceeds the specified value.         |
| soft           | Warning message appears if the number of LSAs exceeds the specified value. |

**Mode** Router Configuration

**Usage** Use **hard** with this command if a shutdown is required if the number of LSAs exceeds the specified number. Use **soft** with this command if a shutdown is not required, but a warning message is required, if the number of LSAs exceeds the specified number.

**Example** The following example shows setting the database overflow to 500, and a shutdown to occur, if the number of LSAs exceeds 500.

```
awplus# configure terminal
awplus(config)# router ospf 100
awplus(config-router)# overflow database 500 hard
```



# overflow database external

**Overview** Use this command to configure the size of the external database and the time the router waits before it tries to exit the overflow state.

Use the **no** variant of this command to revert to default.

**Syntax** `overflow database external <max-lsas> <recover-time>`  
`no overflow database external`

| Parameter                         | Description                                                                                                                                                                                                                  |
|-----------------------------------|------------------------------------------------------------------------------------------------------------------------------------------------------------------------------------------------------------------------------|
| <code>&lt;max-lsas&gt;</code>     | <code>&lt;0-2147483647&gt;</code> The maximum number of Link State Advertisements (LSAs). Note that this value should be the same on all routers in the AS.                                                                  |
| <code>&lt;recover-time&gt;</code> | <code>&lt;0-65535&gt;</code> the number of seconds the router waits before trying to exit the database overflow state. If this parameter is 0, router exits the overflow state only after an explicit administrator command. |

**Mode** Router Configuration

**Usage** Use this command to limit the number of AS-external-LSAs a router can receive, once it is in the wait state. It takes the number of seconds specified as the `<recover-time>` to recover from this state.

**Example** The following example shows setting the maximum number of LSAs to 5 and the time to recover from overflow state to be 3:

```
awplus# configure terminal
awplus(config)# router ospf 100
awplus(config-router)# overflow database external 50 3
```

# passive-interface (OSPF)

**Overview** Use this command to suppress the sending of Hello packets on all interfaces, or on a specified interface. If you use the **passive-interface** command without the optional parameters then **all** interfaces are put into passive mode.

Use the **no** variant of this command to allow the sending of Hello packets on all interfaces, or on the specified interface. If you use the **no** variant of this command without the optional parameters then **all** interfaces are removed from passive mode.

**Syntax** `passive-interface [<interface>] [<ip-address>]`  
`no passive-interface [<interface>] [<ip-address>]`

| Parameter    | Description                                               |
|--------------|-----------------------------------------------------------|
| <interface>  | The name of the interface.                                |
| <ip-address> | IP address of the interface, entered in the form A.B.C.D. |

**Mode** Router Configuration

**Usage** Configure an interface to be passive if you wish its connected route to be treated as an OSPF route (rather than an AS-external route), but do not wish to actually exchange any OSPF packets via this interface.

**Examples** To configure passive interface mode on **all** interfaces, enter the following commands:

```
awplus(config)# router ospf 100
awplus(config-router)# passive-interface
```

To remove passive interface mode on interface vlan2, enter the following commands:

```
awplus(config)# router ospf 100
awplus(config-router)# no passive-interface vlan2
```

To remove passive interface mode on **all** interfaces, enter the following commands:

```
awplus(config)# router ospf 100
awplus(config-router)# no passive-interface
```

# redistribute (OSPF)

**Overview** Use this command to redistribute routes from other routing protocols, static routes and connected routes into an OSPF routing table.

Use the **no** variant of this command to disable this function.

**Syntax**

```
redistribute {bgp|connected|rip|static} {metric
<0-16777214>|metric-type {1|2}|route-map <name>|tag
<0-4294967295>}

no redistribute {bgp|connected|rip|static} {metric
<0-16777214>|metric-type {1|2}|route-map <name>|tag
<0-4294967295>}
```

| Parameter   | Description                                                            |
|-------------|------------------------------------------------------------------------|
| bgp         | Specifies that this applies to the redistribution of BGP routes.       |
| connected   | Specifies that this applies to the redistribution of connected routes. |
| rip         | Specifies that this applies to the redistribution of RIP routes.       |
| static      | Specifies that this applies to the redistribution of static routes.    |
| metric      | Specifies the external metric.                                         |
| metric-type | Specifies the external metric-type.                                    |
| route-map   | Specifies name of the route-map.                                       |
| tag         | Specifies the external route tag.                                      |

**Default** The default metric value for routes redistributed into OSPF is 20. The metric can also be defined using the [set metric](#) command for a route map. Note that a metric defined using the [set metric](#) command for a route map overrides a metric defined with this command.

**Mode** Router Configuration

**Usage** You use this command to inject routes, learned from other routing protocols, into the OSPF domain to generate AS-external-LSAs. If a route-map is configured by this command, then that route-map is used to control which routes are redistributed and can set metric and tag values on particular routes.

The metric, metric-type, and tag values specified on this command are applied to any redistributed routes that are not explicitly given a different metric, metric-type, or tag value by the route map.

See the [OSPF Feature Overview and Configuration Guide](#) for more information about metrics, and about behavior when configured in route maps.

Note that this command does not redistribute the default route. To redistribute the default route, use the [default-information originate](#) command.

**Example** The following example shows the configuration of a route-map named `rmap2`, which is then applied using the **redistribute route-map** command, so routes learned via interface `vlan1` can be redistributed as type-1 external LSAs:

```
awplus# configure terminal
awplus(config)# route-map rmap2 permit 3
awplus(config-route-map)# match interface vlan1
awplus(config-route-map)# set metric-type 1
awplus(config-route-map)# exit
awplus(config)# router ospf 100
awplus(config-router)# redistributebgp rip route-map rmap2
```

Note that configuring a route-map and applying it with the **redistribute route-map** command allows you to filter which routes are distributed from another routing protocol (such as RIP). A route-map can also set the metric, tag, and metric-type of the redistributed routes.

**Related Commands**

- [match interface](#)
- [route-map](#)
- [show ip ospf database external](#)

# restart ospf graceful

**Overview** Use this command to force the OSPF process to restart, and optionally set the grace-period.

**Syntax** `restart ospf graceful [grace-period <1-1800>]`

| Parameter                   | Description                  |
|-----------------------------|------------------------------|
| <code>grace-period</code>   | Specify the grace period.    |
| <code>&lt;1-1800&gt;</code> | The grace period in seconds. |

**Default** In the AlliedWare Plus™ OSPF implementation, the default OSPF grace-period is 180 seconds.

**Mode** Privileged Exec

**Usage** After this command is executed, the OSPF process immediately shuts down. It notifies the system that OSPF has performed a graceful shutdown. Routes installed by OSPF are preserved until the grace-period expires.

When a **restart ospf graceful** command is issued, the OSPF configuration is reloaded from the last saved configuration. Ensure you first enter the command [copy running-config startup-config](#).

**Example**

```
awplus# copy running-config startup-config
awplus# restart ospf graceful grace-period 200
```

**Related Commands** [ospf restart grace-period](#)  
[ospf restart helper](#)

# router ospf

**Overview** Use this command to enter Router Configuration mode to configure an OSPF routing process. You must specify the process ID with this command for multiple OSPF routing processes on the device.

Use the **no** variant of this command to terminate an OSPF routing process.

Use the **no** parameter with the **process-id** parameter, to terminate and delete a specific OSPF routing process. If no **process-id** is specified on the **no** variant of this command, then all OSPF routing processes are terminated, and all OSPF configuration is removed.

**Syntax** `router ospf [<process-id>]`  
`no router ospf [<process-id>]`

**Syntax (VRF-lite)** `router ospf [<process-id>] [<vrf-instance>]`  
`no router ospf [<process-id>]`

| Parameter                         | Description                                                                  |
|-----------------------------------|------------------------------------------------------------------------------|
| <code>&lt;process-id&gt;</code>   | A positive number from 1 to 65535, that is used to define a routing process. |
| <code>&lt;vrf-instance&gt;</code> | The VRF instance to be associated with the OSPF routing process.             |

**Default** No routing process is defined by default.

**Mode** Global Configuration

**Usage** The process ID of OSPF is an optional parameter for the **no** variant of this command only. When removing all instances of OSPF, you do not need to specify each Process ID, but when removing particular instances of OSPF you must specify each Process ID to be removed.

When using VRF-lite, this command can be used to associate a process-id with a VRF instance that has been created using the [ip vrf](#) command.

**Example** To enter Router Configuration mode to configure an existing OSPF routing process 100, use the commands:

```
awplus# configure terminal
awplus(config)# router ospf 100
awplus(config-router)#
```

**Example (VRF-lite)** To enter Router Configuration mode to configure an existing OSPF routing process 100 for VRF instance `red`, use the commands:

```
awplus# configure terminal
awplus(config)# router ospf 100 red
awplus(config-router)#
```

**Command changes** Version 5.4.6-2.1: VRF-lite support added.

# router-id

**Overview** Use this command to specify a router ID for the OSPF process.  
Use the **no** variant of this command to force OSPF to use the previous OSPF router-id behavior.

**Syntax** `router-id <ip-address>`  
`no router-id`

| Parameter                       | Description                                     |
|---------------------------------|-------------------------------------------------|
| <code>&lt;ip-address&gt;</code> | Specifies the router ID in IPv4 address format. |

**Mode** Router Configuration

**Usage** Configure each router with a unique router-id. In an OSPF router process that has active neighbors, a new router-id is used at the next reload or when you restart OSPF manually.

**Example** The following example shows a fixed router ID 10.10.10.60

```
awplus# configure terminal
awplus(config)# router ospf 100
awplus(config-router)# router-id 10.10.10.60
```

**Related Commands** [show ip ospf](#)



# show debugging ospf

**Overview** Use this command to display which OSPF debugging options are currently enabled.

For information on filtering and saving command output, see the [“Getting Started with AlliedWare Plus” Feature Overview and Configuration Guide](#).

**Syntax** `show debugging ospf`

**Mode** User Exec and Privileged Exec

**Example** `awplus# show debugging ospf`

**Output** Figure 29-2: Example output from the **show debugging ospf** command

```
OSPF debugging status:
OSPF packet Link State Update debugging is on
OSPF all events debugging is on
```

# show ip ospf

**Overview** Use this command to display general information about all OSPF routing processes. Include the process ID parameter with this command to display information about specified instances.

For information on filtering and saving command output, see the [“Getting Started with AlliedWare Plus” Feature Overview and Configuration Guide](#).

**Syntax** `show ip ospf`  
`show ip ospf <process-id>`

| Parameter                       | Description                                                                                                                                                                                            |
|---------------------------------|--------------------------------------------------------------------------------------------------------------------------------------------------------------------------------------------------------|
| <code>&lt;process-id&gt;</code> | <code>&lt;0-65535&gt;</code> The ID of the router process for which information will be displayed. If this parameter is included, only the information for the specified routing process is displayed. |

**Mode** User Exec and Privileged Exec

**Examples** To display general information about all OSPF routing processes, use the command:

```
awplus# show ip ospf
```

To display general information about OSPF routing process 100, use the command:

```
awplus# show ip ospf 100
```

**Table 1:** Example output from the **show ip ospf** command

```
Route Licence: Route : Limit=0, Allocated=0, Visible=0, Internal=0
Route Licence: Breach: Current=0, Watermark=0
Routing Process "ospf 10" with ID 192.168.1.1
Process uptime is 10 hours 24 minutes
Process bound to VRF default
Conforms to RFC2328, and RFC1583 Compatibility flag is disabled
Supports only single TOS(TOS0) routes
Supports opaque LSA
Supports Graceful Restart
SPF schedule delay min 0.500 secs, SPF schedule delay max 50.0 secs
Refresh timer 10 secs
Number of incoming current DD exchange neighbors 0/5
Number of outgoing current DD exchange neighbors 0/5
Number of external LSA 0. Checksum 0x000000
Number of opaque AS LSA 0. Checksum 0x000000
Number of non-default external LSA 0
```

**Table 1:** Example output from the **show ip ospf** command (cont.)

```
External LSA database is unlimited.
Number of LSA originated 0
Number of LSA received 0
Number of areas attached to this router: 2
 Area 0 (BACKBONE) (Inactive)
 Number of interfaces in this area is 0(0)
 Number of fully adjacent neighbors in this area is 0
 Area has no authentication
 SPF algorithm executed 0 times
 Number of LSA 0. Checksum 0x000000

 Area 1 (Inactive)
 Number of interfaces in this area is 0(0)
 Number of fully adjacent neighbors in this area is 0
 Number of fully adjacent virtual neighbors through this area is 0
 Area has no authentication
 SPF algorithm executed 0 times
 Number of LSA 0. Checksum 0x000000
```

**Table 2:** Example output from the **show ip ospf <process-id>** command

```
Routing Process "ospf 100" with ID 10.10.11.146
Process uptime is 0 minute
Conforms to RFC2328, and RFC1583Compatibility flag is disabled
Supports only single TOS(TOS0) routes
Supports opaque LSA
SPF schedule delay 5 secs, Hold time between two SPFs 10 secs
Refresh timer 10 secs
Number of external LSA 0. Checksum Sum 0x0
Number of non-default external LSA 0
External LSA database is unlimited.
Number of areas attached to this router: 1
 Area 1
 Number of interfaces in this area is 1(1)
 Number of fully adjacent neighbors in this area is 0
 Number of fully adjacent virtual neighbors through this area is 0
 Area has no authentication
 SPF algorithm executed 0 times
 Number of LSA 1. Checksum Sum 0x00e3e2
```

**Table 3:** Parameters in the output of the **show ip ospf** command

| Output Parameter        |           | Meaning                                                                 |
|-------------------------|-----------|-------------------------------------------------------------------------|
| Route Licence: Route:   | Limit     | The maximum number of OSPF routes which may be used for forwarding.     |
|                         | Allocated | The current total number of OSPF routes allocated in the OSPF module.   |
|                         | Visible   | The current number of OSPF routes which may be used for forwarding.     |
|                         | Internal  | The number of OSPF internal routes used for calculating paths to ASBRs. |
| Number of external LSA  |           | The number of external link-state advertisements                        |
| Number of opaque AS LSA |           | Number of opaque link-state advertisements                              |

**Related Commands** [router ospf](#)

# show ip ospf border-routers

**Overview** Use this command to display the ABRs and ASBRs for all OSPF instances. Include the process ID parameter with this command to view data about specified instances.

For information on filtering and saving command output, see the [“Getting Started with AlliedWare Plus” Feature Overview and Configuration Guide](#).

**Syntax** `show ip ospf border-routers`  
`show ip ospf <process-id> border-routers`

| Parameter                       | Description                                                                                        |
|---------------------------------|----------------------------------------------------------------------------------------------------|
| <code>&lt;process-id&gt;</code> | <code>&lt;0-65535&gt;</code> The ID of the router process for which information will be displayed. |

**Mode** User Exec and Privileged Exec

**Output** Figure 29-3: Example output from the **show ip ospf border-routers** command

```
OSPF process 1 internal Routing Table
Codes: i - Intra-area route, I - Inter-area route
i 10.15.0.1 [10] via 10.10.0.1, vlan2, ASBR, Area 0.0.0.0
i 172.16.10.1 [10] via 10.10.11.50, vlan3, ABR, ASBR, Area
0.0.0.0
```

# show ip ospf database

**Overview** Use this command to display a database summary for OSPF information. Include the process ID parameter with this command to display information about specified instances.

For information on filtering and saving command output, see the [“Getting Started with AlliedWare Plus” Feature Overview and Configuration Guide](#).

**Syntax** `show ip ospf [<process-id>] database  
[self-originate|max-age|adv router <adv-router-id>]`

| Parameter       | Description                                                                                                                                                                                                  |
|-----------------|--------------------------------------------------------------------------------------------------------------------------------------------------------------------------------------------------------------|
| <process-id>    | <0-65535> The ID of the router process for which information will be displayed.                                                                                                                              |
| self-originate  | Displays self-originated link states.                                                                                                                                                                        |
| max-age         | Displays LSAs in MaxAge list. It maintains the list of the all LSAs in the database which have reached the max-age which is 3600 seconds.                                                                    |
| adv-router      | Advertising Router LSA.                                                                                                                                                                                      |
| <adv-router-id> | The Advertising Router ID (usually entered in IPv4 address format A.B.C.D).<br>Note that this ID component no longer represents an address; it is simply a character string that has an IPv4 address format. |

**Mode** User Exec and Privileged Exec

**Examples** To display the ABRs and ASBRs for all OSPF instances, use the command:

```
awplus# show ip ospf border-routers
```

To display the ABRs and ASBRs for the specific OSPF instance 721, use the command:

```
awplus# show ip ospf 721 border-routers
```

**Output** Figure 29-4: Example output from the **show ip ospf database** command

```

 OSPF Router process 1 with ID (10.10.11.60)
 Router Link States (Area 0.0.0.1)
Link ID ADV Router Age Seq# CkSum Link
count
10.10.11.60 10.10.11.60 32 0x80000002 0x472b 1
 OSPF Router process 100 with ID (10.10.11.60)
 Router Link States (Area 0.0.0.0)
Link ID ADV Router Age Seq# CkSum Link
count
10.10.11.60 10.10.11.60 219 0x80000001 0x4f5d 0

```

**Example** awplus# show ip ospf database external 1.2.3.4 self-originate  
awplus# show ip ospf database self-originate

Figure 29-5: Example output from the **show ip ospf database self-originate** command

```
OSPF Router process 100 with ID (10.10.11.50)
Router Link States (Area 0.0.0.1 [NSSA])
Link ID ADV Router Age Seq# CkSum Link
count
10.10.11.50 10.10.11.50 20 0x80000007 0x65c3 2
Area-Local Opaque-LSA (Area 0.0.0.1 [NSSA])
Link ID ADV Router Age Seq# CkSum Opaque ID
67.1.4.217 10.10.11.50 37 0x80000001 0x2129 66777
AS-Global Opaque-LSA
Link ID ADV Router Age Seq# CkSum Opaque ID
67.1.4.217 10.10.11.50 37 0x80000001 0x2daa 66777
```

# show ip ospf database asbr-summary

**Overview** Use this command to display information about the Autonomous System Boundary Router (ASBR) summary LSAs.

For information on filtering and saving command output, see the [“Getting Started with AlliedWare Plus” Feature Overview and Configuration Guide](#).

**Syntax** `show ip ospf database asbr-summary [<ip-addr>]  
[self-originate|<advrouter>]`

| Parameter      | Description                                    |
|----------------|------------------------------------------------|
| <advrouter>    | adv-router <ip-address>                        |
| adv-router     | Displays all the LSAs of the specified router. |
| <ip-addr>      | A link state ID, as an IP address.             |
| self-originate | Displays self-originated link states.          |

**Mode** User Exec and Privileged Exec

**Examples**

```
awplus# show ip ospf database asbr-summary 1.2.3.4
self-originate

awplus# show ip ospf database asbr-summary self-originate

awplus# show ip ospf database asbr-summary 1.2.3.4 adv-router
2.3.4.5
```



# show ip ospf database external

**Overview** Use this command to display information about the external LSAs.

For information on filtering and saving command output, see the [“Getting Started with AlliedWare Plus” Feature Overview and Configuration Guide](#).

**Syntax** `show ip ospf database external adv-router[<adv-router-id>]  
[self-originate|adv-router<adv-router-id>]`

| Parameter        | Description                                                                                                                                                                                                  |
|------------------|--------------------------------------------------------------------------------------------------------------------------------------------------------------------------------------------------------------|
| adv-router       | Displays all the LSAs of the specified router.                                                                                                                                                               |
| self-originate   | Displays self-originated link states.                                                                                                                                                                        |
| <adv-router- id> | The Advertising Router ID (usually entered in IPv4 address format A.B.C.D).<br>Note that this ID component no longer represents an address; it is simply a character string that has an IPv4 address format. |

**Mode** User Exec and Privileged Exec

**Examples**

```
awplus# show ip ospf database external 1.2.3.4 self-originate
awplus# show ip ospf database external self-originate
awplus# show ip ospf database external 1.2.3.4 adv-router
2.3.4.5
```

**Output** Figure 29-6: Example output from the **show ip ospf database external self-originate** command

```
OSPF Router process 100 with ID (10.10.11.50)
AS External Link States
LS age: 298
Options: 0x2 (*-|-|-|-|E|-)
LS Type: AS-external-LSA
Link State ID: 10.10.100.0 (External Network Number)
Advertising Router: 10.10.11.50
LS Seq Number: 80000001
Checksum: 0x7033
Length: 36
Network Mask: /24
Metric Type: 2 (Larger than any link state path)
TOS: 0
Metric: 20
Forward Address: 10.10.11.50
External Route Tag: 0
```

**Output** Figure 29-7: Example output from the **show ip ospf database external adv-router** command

```
awplus#show ip ospf database external adv-router 1.1.1.1

 AS External Link States
LS age: 273
Options: 0x2 (-|-|-|-|-|E|-)
LS Type: AS-external-LSA
Link State ID: 172.16.0.0 (External Network Number)
Advertising Router: 1.1.1.1
LS Seq Number: 80000004
Checksum: 0x02f8
Length: 36
Network Mask: /24
 Metric Type: 2 (Larger than any link state path)
 TOS: 0
 Metric: 20
 Forward Address: 0.0.0.0
 External Route Tag: 0
```

# show ip ospf database network

**Overview** Use this command to display information about the network LSAs.

For information on filtering and saving command output, see the [“Getting Started with AlliedWare Plus” Feature Overview and Configuration Guide](#).

**Syntax** `show ip ospf database network [<adv-router-id>]  
[self-originate|<adv-router-id>]`

| Parameter       | Description                                                                                                                   |
|-----------------|-------------------------------------------------------------------------------------------------------------------------------|
| <adv-router-id> | The router ID of the advertising router, in IPv4 address format. Note however, that this no longer represents a real address. |
| self-originate  | Displays self-originated link states.                                                                                         |
| adv-router      | Displays all the LSAs of the specified router.                                                                                |

**Mode** User Exec and Privileged Exec

**Examples** `awplus# show ip ospf database network 1.2.3.4 self-originate`  
`awplus# show ip ospf database network self-originate`  
`awplus# show ip ospf database network 1.2.3.4 adv-router 2.3.4.5`

**Output** Figure 29-8: Example output from the **show ip ospf database network** command

```
OSPF Router process 200 with ID (192.30.30.2)
 Net Link States (Area 0.0.0.0)
LS age: 1387
Options: 0x2 (*|-|-|-|-|E|-)
LS Type: network-LSA
Link State ID: 192.10.10.9 (address of Designated Router)
Advertising Router: 192.30.30.3
LS Seq Number: 80000001
Checksum: 0xe1b0
Length: 32
Network Mask: /24
 Attached Router: 192.20.20.1
 Attached Router: 192.30.30.3
OSPF Router process 200 with ID (192.30.30.2)
 Net Link States (Area 0.0.0.0)
...
```

# show ip ospf database nssa-external

**Overview** Use this command to display information about the NSSA external LSAs.

For information on filtering and saving command output, see the [“Getting Started with AlliedWare Plus” Feature Overview and Configuration Guide](#).

**Syntax** `show ip ospf database nssa-external [<ip-address>]  
[self-originate|<advrouter>]`

| Parameter      | Description                                    |
|----------------|------------------------------------------------|
| <advrouter>    | adv-router <ip-address>                        |
| adv-router     | Displays all the LSAs of the specified router. |
| <ip-address>   | A link state ID, as an IP address.             |
| self-originate | Displays self-originated link states.          |

**Mode** User Exec and Privileged Exec

**Examples**

```
awplus# show ip ospf database nssa-external 1.2.3.4
self-originate

awplus# show ip ospf database nssa-external self-originate

awplus# show ip ospf database nssa-external 1.2.3.4 adv-router
2.3.4.5
```

**Output** Figure 29-9: Example output from the **show ip ospf database nssa-external adv-router** command

```
OSPF Router process 100 with ID (10.10.11.50)
 NSSA-external Link States (Area 0.0.0.0)
 NSSA-external Link States (Area 0.0.0.1 [NSSA])

LS age: 78
Options: 0x0 (*|-|-|-|-|-|-|-)
LS Type: AS-NSSA-LSA
Link State ID: 0.0.0.0 (External Network Number For NSSA)
Advertising Router: 10.10.11.50
LS Seq Number: 80000001
Checksum: 0xc9b6
Length: 36
Network Mask: /0
 Metric Type: 2 (Larger than any link state path)
 TOS: 0
 Metric: 1
 NSSA: Forward Address: 0.0.0.0
```

```
OSPF Router process 100 with ID (10.10.11.50)
 NSSA-external Link States (Area 0.0.0.0)
 NSSA-external Link States (Area 0.0.0.1 [NSSA])
LS age: 78
Options: 0x0 (*|---|---|---|)
LS Type: AS-NSSA-LSA
Link State ID: 0.0.0.0 (External Network Number For NSSA)
Advertising Router: 10.10.11.50
LS Seq Number: 80000001
Checksum: 0xc9b6
Length: 36
Network Mask: /0
 Metric Type: 2 (Larger than any link state path)
 TOS: 0
 Metric: 1
 NSSA: Forward Address: 0.0.0.0
 External Route Tag: 0
 NSSA-external Link States (Area 0.0.0.1 [NSSA])
```

# show ip ospf database opaque-area

**Overview** Use this command to display information about the area-local (link state type 10) scope LSAs. Type-10 Opaque LSAs are not flooded beyond the borders of their associated area.

For information on filtering and saving command output, see the [“Getting Started with AlliedWare Plus” Feature Overview and Configuration Guide](#).

**Syntax** `show ip ospf database opaque-area [<ip-address>]  
[self-originate|<advrouter>]`

| Parameter      | Description                                    |
|----------------|------------------------------------------------|
| <advrouter>    | adv-router <ip-address>                        |
| adv-router     | Displays all the LSAs of the specified router. |
| <ip-address>   | A link state ID, as an IP address.             |
| self-originate | Displays self-originated link states.          |

**Mode** User Exec and Privileged Exec

**Examples**

```
awplus# show ip ospf database opaque-area 1.2.3.4
self-originate

awplus# show ip ospf database opaque-area self-originate

awplus# show ip ospf database opaque-area 1.2.3.4 adv-router
2.3.4.5
```

**Output** Figure 29-10: Example output from the **show ip ospf database opaque-area** command

```
OSPF Router process 100 with ID (10.10.11.50)
Area-Local Opaque-LSA (Area 0.0.0.0)
LS age: 262
Options: 0x2 (*|---|---|E|---)
LS Type: Area-Local Opaque-LSA
Link State ID: 10.0.25.176 (Area-Local Opaque-Type/ID)
Opaque Type: 10
Opaque ID: 6576
Advertising Router: 10.10.11.50
LS Seq Number: 80000001
Checksum: 0xb413
Length: 26
```

# show ip ospf database opaque-as

**Overview** Use this command to display information about the link-state type 11 LSAs. This type of link-state denotes that the LSA is flooded throughout the Autonomous System (AS).

For information on filtering and saving command output, see the [“Getting Started with AlliedWare Plus” Feature Overview and Configuration Guide](#).

**Syntax** `show ip ospf database opaque-as [<ip-address>]  
[self-originate|<advrouter>]`

| Parameter      | Description                                    |
|----------------|------------------------------------------------|
| <advrouter>    | adv-router <ip-address>                        |
| adv-router     | Displays all the LSAs of the specified router. |
| <ip-address>   | A link state ID, as an IP address.             |
| self-originate | Displays self-originated link states.          |

**Mode** User Exec and Privileged Exec

**Examples**

```
awplus# show ip ospf database opaque-as 1.2.3.4 self-originate
awplus# show ip ospf database opaque-as self-originate
awplus# show ip ospf database opaque-as 1.2.3.4 adv-router
2.3.4.5
```

**Output** Figure 29-11: Example output from the **show ip ospf database opaque-as** command

```
OSPF Router process 100 with ID (10.10.11.50)
AS-Global Opaque-LSA
LS age: 325
Options: 0x2 (*|---|---|E|)
LS Type: AS-external Opaque-LSA
Link State ID: 11.10.9.23 (AS-external Opaque-Type/ID)
Opaque Type: 11
Opaque ID: 657687
Advertising Router: 10.10.11.50
LS Seq Number: 80000001
Checksum: 0xb018
Length: 25
```

# show ip ospf database opaque-link

**Overview** Use this command to display information about the link-state type 9 LSAs. This type denotes a link-local scope. The LSAs are not flooded beyond the local network.

For information on filtering and saving command output, see the [“Getting Started with AlliedWare Plus” Feature Overview and Configuration Guide](#).

**Syntax** `show ip ospf database opaque-link [<ip-address>]  
[self-originate|<advrouter>]`

| Parameter      | Description                                    |
|----------------|------------------------------------------------|
| <advrouter>    | adv-router <ip-address>                        |
| adv-router     | Displays all the LSAs of the specified router. |
| <ip-address>   | A link state ID, as an IP address.             |
| self-originate | Displays self-originated link states.          |

**Mode** User Exec and Privileged Exec

**Examples**

```
awplus# show ip ospf database opaque-link 1.2.3.4
self-originate

awplus# show ip ospf database opaque-link self-originate

awplus# show ip ospf database opaque-link 1.2.3.4 adv-router
2.3.4.5
```

**Output** Figure 29-12: Example output from the **show ip ospf database opaque-link** command

```
OSPF Router process 100 with ID (10.10.11.50)
 Link-Local Opaque-LSA (Link hme0:10.10.10.50)
LS age: 276
Options: 0x2 (*|-|-|-|-|E|-)
LS Type: Link-Local Opaque-LSA
Link State ID: 10.0.220.247 (Link-Local Opaque-Type/ID)
Opaque Type: 10
Opaque ID: 56567
Advertising Router: 10.10.11.50
LS Seq Number: 80000001
Checksum: 0x744e
Length: 26
 Link-Local Opaque-LSA (Link hme1:10.10.11.50)
```



# show ip ospf database router

**Overview** Use this command to display information only about the router LSAs.

For information on filtering and saving command output, see the [“Getting Started with AlliedWare Plus” Feature Overview and Configuration Guide](#).

**Syntax** `show ip ospf database router [<adv-router-id>  
self-originate|<adv-router-id>]`

| Parameter        | Description                                                                                                                   |
|------------------|-------------------------------------------------------------------------------------------------------------------------------|
| adv-router       | Displays all the LSAs of the specified router.                                                                                |
| self-originate   | Displays self-originated link states.                                                                                         |
| <adv-router- id> | The router ID of the advertising router, in IPv4 address format. Note however, that this no longer represents a real address. |

**Mode** User Exec and Privileged Exec

**Examples** `awplus# show ip ospf database router 1.2.3.4 self-originate`  
`awplus# show ip ospf database router self-originate`  
`awplus# show ip ospf database router 1.2.3.4 adv-router 2.3.4.5`

**Output** Figure 29-13: Example output from the **show ip ospf database router** command

```
OSPF Router process 100 with ID (10.10.11.50)
 Router Link States (Area 0.0.0.0)
LS age: 878
Options: 0x2 (*|-|-|-|-|E|-)
Flags: 0x3 : ABR ASBR
LS Type: router-LSA
Link State ID: 10.10.11.50
Advertising Router: 10.10.11.50
LS Seq Number: 80000004
Checksum: 0xe39e
Length: 36
 Number of Links: 1
 Link connected to: Stub Network
 (Link ID) Network/subnet number: 10.10.10.0
 (Link Data) Network Mask: 255.255.255.0
 Number of TOS metrics: 0
 TOS 0 Metric: 10
```

```
Router Link States (Area 0.0.0.1)
LS age: 877
Options: 0x2 (*|-|-|-|-|E|-)
Flags: 0x3 : ABR ASBR
LS Type: router-LSA
Link State ID: 10.10.11.50
Advertising Router: 10.10.11.50
LS Seq Number: 80000003
Checksum: 0xee93
Length: 36
Number of Links: 1
 Link connected to: Stub Network
 (Link ID) Network/subnet number: 10.10.11.0
 (Link Data) Network Mask: 255.255.255.0
 Number of TOS metrics: 0
 TOS 0 Metric: 10
```

# show ip ospf database summary

**Overview** Use this command to display information about the summary LSAs.

For information on filtering and saving command output, see the [“Getting Started with AlliedWare Plus” Feature Overview and Configuration Guide](#).

**Syntax** `show ip ospf database summary [<ip-address>]  
[self-originate|<advrouter>]`

| Parameter      | Description                                    |
|----------------|------------------------------------------------|
| <advrouter>    | adv-router <ip-address>                        |
| adv-router     | Displays all the LSAs of the specified router. |
| <ip-address>   | A link state ID, as an IP address.             |
| self-originate | Displays self-originated link states.          |

**Mode** User Exec and Privileged Exec

**Examples** `awplus# show ip ospf database summary 1.2.3.4 self-originate`  
`awplus# show ip ospf database summary self-originate`  
`awplus# show ip ospf database summary 1.2.3.4 adv-router 2.3.4.5`

**Output** Figure 29-14: Example output from the **show ip ospf database summary** command

```
OSPF Router process 100 with ID (10.10.11.50)
 Summary Link States (Area 0.0.0.0)
 Summary Link States (Area 0.0.0.1)

LS age: 1124
Options: 0x2 (*|---|---|E|)
LS Type: summary-LSA
Link State ID: 10.10.10.0 (summary Network Number)
Advertising Router: 10.10.11.50
LS Seq Number: 80000001
Checksum: 0x41a2
Length: 28
Network Mask: /24
 TOS: 0 Metric: 10
```

Figure 29-15: Example output from the **show ip ospf database summary self-originate** command

```
OSPF Router process 100 with ID (10.10.11.50)
 Summary Link States (Area 0.0.0.0)
LS age: 1061
Options: 0x2 (*|-|-|-|-|E|-)
LS Type: summary-LSA
Link State ID: 10.10.11.0 (summary Network Number)
Advertising Router: 10.10.11.50
LS Seq Number: 80000001
Checksum: 0x36ac
Length: 28
Network Mask: /24
 TOS: 0 Metric: 10
 Summary Link States (Area 0.0.0.1)
LS age: 1061
Options: 0x2 (*|-|-|-|-|E|-)
LS Type: summary-LSA
Link State ID: 10.10.11.0 (summary Network Number)
Advertising Router: 10.10.11.50
LS Seq Number: 80000001
Checksum: 0x36ac
Length: 28
Network Mask: /24
 TOS: 0 Metric: 10
 Summary Link States (Area 0.0.0.1)
LS age: 1061
Options: 0x2 (*|-|-|-|-|E|-)
LS Type: summary-LSA
Link State ID: 10.10.10.0 (summary Network Number)
Advertising Router: 10.10.11.50
LS Seq Number: 80000001
Checksum: 0x41a2
Length: 28
Network Mask: /24
 TOS: 0 Metric: 10
```

Figure 29-16: Example output from the **show ip ospf database summary adv-router <ip-address>** command

```
OSPF Router process 100 with ID (10.10.11.50)
 Summary Link States (Area 0.0.0.0)
LS age: 989
Options: 0x2 (*|---|---|E|)
LS Type: summary-LSA
Link State ID: 10.10.11.0 (summary Network Number)
Advertising Router: 10.10.11.50
LS Seq Number: 80000001
Checksum: 0x36ac
Length: 28
Network Mask: /24
 TOS: 0 Metric: 10
 Summary Link States (Area 0.0.0.1)
LS age: 989
Options: 0x2 (*|---|---|E|)
LS Type: summary-LSA
Link State ID: 10.10.11.0 (summary Network Number)
Advertising Router: 10.10.11.50
LS Seq Number: 80000001
Checksum: 0x36ac
Length: 28
Network Mask: /24
 TOS: 0 Metric: 10
```

# show ip ospf interface

**Overview** Use this command to display interface information for OSPF.

For information on filtering and saving command output, see the [“Getting Started with AlliedWare Plus” Feature Overview and Configuration Guide](#).

**Syntax** `show ip ospf interface [<interface-name>]`

| Parameter        | Description                       |
|------------------|-----------------------------------|
| <interface-name> | The VLAN name, for example vlan3. |

**Mode** User Exec and Privileged Exec

**Examples** `awplus# show ip ospf interface vlan2`

**Output** Figure 29-17: Example output from the **show ip ospf interface** command

```
vlan2 is up, line protocol is up
Internet Address 1.1.1.1/24, Area 0.0.0.0, MTU 1500
Process ID 0, Router ID 33.33.33.33, Network Type BROADCAST, Cost: 10
Transmit Delay is 1 sec, State Waiting, Priority 1, TE Metric 0
No designated router on this network
No backup designated router on this network
Timer intervals configured, Hello 10, Dead 40, Wait 40, Retransmit 5
 Hello due in 00:00:02
Neighbor Count is 0, Adjacent neighbor count is 0
Crypt Sequence Number is 1106347721
Hello received 0 sent 1, DD received 0 sent 0
LS-Req received 0 sent 0, LS-Upd received 0 sent 0
LS-Ack received 0 sent 0, Discarded 0
```

# show ip ospf neighbor

**Overview** Use this command to display information on OSPF neighbors. Include the **ospf-id** parameter with this command to display information about specified instances.

For information on filtering and saving command output, see the [“Getting Started with AlliedWare Plus” Feature Overview and Configuration Guide](#).

**Syntax**

```
show ip ospf [<ospf-id>] neighbor <neighbor-ip-addr> [detail]
show ip ospf [<ospf-id>] neighbor detail [all]
show ip ospf [<ospf-id>] neighbor [all]
show ip ospf [<ospf-id>] neighbor interface <ip-addr>
```

| Parameter          | Description                                                                     |
|--------------------|---------------------------------------------------------------------------------|
| <ospf-id>          | <0-65535> The ID of the router process for which information will be displayed. |
| <neighbor-ip-addr> | The Neighbor ID, entered as an IP address.                                      |
| all                | Include downstatus neighbor.                                                    |
| detail             | Detail of all neighbors.                                                        |
| <ip-addr>          | IP address of the interface.                                                    |

**Mode** User Exec and Privileged Exec

**Examples**

```
awplus# show ip ospf neighbor detail
awplus# show ip ospf neighbor 1.2.3.4
awplus# show ip ospf neighbor interface 10.10.10.50 detail all
```

**Output** Note that before a device enters OSPF Graceful Restart it first informs its OSPF neighbors. In the **show** output, the \* symbol beside the **Dead Time** parameter indicates that the device has been notified of a neighbor entering the graceful restart state, as shown in the figures below.

Figure 29-18: Example output from the **show ip ospf neighbor** command

```
OSPF process 1:
Neighbor ID Pri State Dead Time Address Interface
10.10.10.50 1 Full/DR 00:00:38 10.10.10.50 vlan1
OSPF process 100:
Neighbor ID Pri State Dead Time Address Interface
10.10.11.50 1 Full/Backup 00:00:31 10.10.11.50 vlan2
awplus#show ip ospf 1 neighbor
OSPF process 1:
Neighbor ID Pri State Dead Time Address Interface
10.10.10.50 1 Full/DR 00:00:38* 10.10.10.50 vlan1
```

Figure 29-19: Example output from the **show ip ospf <ospf-id> neighbor** command

```
OSPF process 100:
```

| Neighbor ID | Pri | State         | Dead Time | Address       | Interface |
|-------------|-----|---------------|-----------|---------------|-----------|
| 192.168.0.3 | 50  | 2-Way/DROther | 00:01:59* | 192.168.200.3 | vlan200   |

Figure 29-20: Example output from the **show ip ospf neighbor detail** command

```
Neighbor 10.10.10.50, interface address 10.10.10.50
 In the area 0.0.0.0 via interface vlan5
 Neighbor priority is 1, State is Full, 5 state changes
 DR is 10.10.10.50, BDR is 10.10.10.10
 Options is 0x42 (*|O|---|E|)
 Dead timer due in 00:00:38
 Neighbor is up for 00:53:07
 Database Summary List 0
 Link State Request List 0
 Link State Retransmission List 0
 Crypt Sequence Number is 0
 Thread Inactivity Timer on
 Thread Database Description Retransmission off
 Thread Link State Request Retransmission off
 Thread Link State Update Retransmission on
Neighbor 10.10.11.50, interface address 10.10.11.50
 In the area 0.0.0.0 via interface vlan2
 Neighbor priority is 1, State is Full, 5 state changes
 DR is 10.10.11.10, BDR is 10.10.11.50
 Options is 0x42 (*|O|---|E|)
 Dead timer due in 00:00:31
 Neighbor is up for 00:26:50
 Database Summary List 0
 Link State Request List 0
 Link State Retransmission List 0
 Crypt Sequence Number is 0
 Thread Inactivity Timer on
 Thread Database Description Retransmission off
 Thread Link State Request Retransmission off
 Thread Link State Update Retransmission on
```



# show ip ospf route

**Overview** Use this command to display the OSPF routing table. Include the **ospf-id** parameter with this command to display the OSPF routing table for specified instances.

For information on filtering and saving command output, see the [“Getting Started with AlliedWare Plus” Feature Overview and Configuration Guide](#).

**Syntax** `show ip ospf [<ospf-id>] route`

| Parameter | Description                                                                                                                                                                          |
|-----------|--------------------------------------------------------------------------------------------------------------------------------------------------------------------------------------|
| <ospf-id> | <0-65535> The ID of the router process for which information will be displayed. If this parameter is included, only the information for this specified routing process is displayed. |

**Mode** User Exec and Privileged Exec

**Examples** To display the OSPF routing table, use the command:

```
awplus# show ip ospf route
```

**Output** Figure 29-21: Example output from the **show ip ospf route** command for a specific process

```
OSPF process 1:
Codes: C - connected, D - Discard, O - OSPF, IA - OSPF inter area
 N1 - OSPF NSSA external type 1, N2 - OSPF NSSA external type 2
 E1 - OSPF external type 1, E2 - OSPF external type 2
O 10.10.0.0/24 [10] is directly connected, vlan1, Area 0.0.0.0
O 10.10.11.0/24 [10] is directly connected, vlan2, Area 0.0.0.0
O 10.10.11.100/32 [10] is directly connected, lo, Area 0.0.0.0
E2 10.15.0.0/24 [10/50] via 10.10.0.1, vlan1
IA 172.16.10.0/24 [30] via 10.10.11.50, vlan2, Area 0.0.0.0
E2 192.168.0.0/16 [10/20] via 10.10.11.50, vlan2
```

# show ip ospf virtual-links

**Overview** Use this command to display virtual link information.

For information on filtering and saving command output, see the [“Getting Started with AlliedWare Plus” Feature Overview and Configuration Guide](#).

**Syntax** `show ip ospf virtual-links`

**Mode** User Exec and Privileged Exec

**Examples** To display virtual link information, use the command:

```
awplus# show ip ospf virtual-links
```

**Output** Figure 29-22: Example output from the **show ip ospf virtual-links** command

```
Virtual Link VLINK0 to router 10.10.0.9 is up
 Transit area 0.0.0.1 via interface vlan5
 Transmit Delay is 1 sec, State Point-To-Point,
 Timer intervals configured, Hello 10, Dead 40, Wait 40,
 Retransmit 5
 Hello due in 00:00:02
 Adjacency state Full
Virtual Link VLINK1 to router 10.10.0.123 is down
 Transit area 0.0.0.1 via interface *
 Transmit Delay is 1 sec, State Down,
 Timer intervals configured, Hello 10, Dead 40, Wait 40,
 Retransmit 5
 Hello due in inactive
 Adjacency state Down
```

# show ip protocols ospf

**Overview** Use this command to display OSPF process parameters and statistics.  
For information on filtering and saving command output, see the [“Getting Started with AlliedWare Plus” Feature Overview and Configuration Guide](#).

**Syntax** `show ip protocols ospf`

**Mode** User Exec and Privileged Exec

**Examples** To display OSPF process parameters and statistics, use the command:

```
awplus# show ip protocols ospf
```

**Output** Figure 29-23: Example output from the **show ip protocols ospf** command

```
Routing Protocol is "ospf 200"
 Invalid after 0 seconds, hold down 0, flushed after 0
 Outgoing update filter list for all interfaces is
 Redistributed kernel filtered by filter1
 Incoming update filter list for all interfaces is
 Redistributing: kernel
 Routing for Networks:
 192.30.30.0/24
 192.40.40.0/24
 Routing Information Sources:
 Gateway Distance Last Update
 Distance: (default is 110)
 Address Mask Distance List
```

# summary-address

**Overview** Use this command to summarize, or possibly suppress, external routes that have the specified address range.

Use the **no** variant of this command to stop summarizing, or suppressing, external routes that have the specified address range.

**Syntax** `summary-address <ip-addr/prefix-length> [not-advertise] [tag <0-4294967295>]`  
`no summary-address <ip-addr/prefix-length> [not-advertise] [tag <0-4294967295>]`

| Parameter                                  | Description                                                                                                                                                                                   |
|--------------------------------------------|-----------------------------------------------------------------------------------------------------------------------------------------------------------------------------------------------|
| <code>&lt;ip-addr/prefix-length&gt;</code> | Specifies the base IP address of the summary address. The range of addresses given as IPv4 starting address and a prefix length.                                                              |
| <code>not-advertise</code>                 | Set the <b>not-advertise</b> option if you do not want OSPF to advertise either the summary address or the individual networks within the range of the summary address.                       |
| <code>tag &lt;0-4294967295&gt;</code>      | The tag parameter specifies the tag value that OSPF places in the AS external LSAs created as a result of redistributing the summary route. The tag overrides tags set by the original route. |

**Default** The default tag value for a summary address is 0.

**Mode** Router Configuration

**Usage** An address range is a pairing of an address and a mask that is almost the same as IP network number. For example, if the specified address range is 192.168.0.0/255.255.240.0, it matches: 192.168.1.0/24, 192.168.4.0/22, 192.168.8.128/25 and so on.

Redistributing routes from other protocols into OSPF requires the router to advertise each route individually in an external LSA. Use the **summary address** command to advertise one summary route for all redistributed routes covered by a specified network address and mask. This helps decrease the size of the OSPF link state database.

Ensure OSPF routes exist in the summary address range for advertisement before using this command.

**Example** The following example uses the **summary-address** command to aggregate external LSAs that match the network 172.16.0.0/16 and assign a Tag value of 3.

```
awplus# configure terminal
awplus(config)# router ospf 100
awplus(config-router)# summary-address 172.16.0.0/16 tag 3
```

# timers spf exp

**Overview** Use this command to adjust route calculation timers using exponential back-off delays.

Use **no** form of this command to return to the default exponential back-off timer values.

**Syntax** `timers spf exp <min-holdtime> <max-holdtime>`  
`no timers spf exp`

| Parameter                         | Description                                                                                                                                                                                |
|-----------------------------------|--------------------------------------------------------------------------------------------------------------------------------------------------------------------------------------------|
| <code>&lt;min-holdtime&gt;</code> | <code>&lt;0-2147483647&gt;</code><br>Specifies the minimum delay between receiving a change to the SPF calculation in milliseconds. The default SPF min-holdtime value is 50 milliseconds. |
| <code>&lt;max-holdtime&gt;</code> | <code>&lt;0-2147483647&gt;</code><br>Specifies the maximum delay between receiving a change to the SPF calculation in milliseconds. The default SPF max-holdtime value is 50 seconds.      |

**Mode** Router Configuration

**Default** The default SPF min-holdtime is 50 milliseconds. The default SPF max-holdtime is 40 seconds.

**Usage** This command configures the minimum and maximum delay time between the receipt of a topology change and the calculation of the Shortest Path First (SPF).

**Examples** To set the minimum delay time to 5 milliseconds and maximum delay time to 10 milliseconds, use the commands:

```
awplus# configure terminal
awplus(config)# router ospf 100
awplus(config-router)# timers spf exp 5 10
```

To reset the minimum and maximum delay times to the default values, use the commands:

```
awplus# configure terminal
awplus(config)# router ospf 100
awplus(config-router)# no timers spf exp
```

**Related Commands** [timers spf exp](#)

# undebbug ospf events

**Overview** This command applies the functionality of the no `debug ospf events` command.

# undebbug ospf ifsm

**Overview** This command applies the functionality of the no `debug ospf ifsm` command.

# undebbug ospf lsa

**Overview** This command applies the functionality of the no `debug ospf lsa` command.



# undebbug ospf nfsm

**Overview** This command applies the functionality of the no `debug ospf nfsm` command.

# undebbug ospf nsm

**Overview** This command applies the functionality of the no `debug ospf nsm` command.

# undebug ospf packet

**Overview** This command applies the functionality of the no `debug ospf packet` command.

# undebg ospf route

**Overview** This command applies the functionality of the no `debug ospf route` command.

# 30

# OSPFv3 for IPv6 Commands

## Introduction

**Overview** This chapter provides an alphabetical reference of commands used to configure OSPFv3 for IPv6. See [How to Configure Basic OSPFv3\\_Scenarios](#) for more information and examples.

- Command List**
- [“abr-type”](#) on page 1040
  - [“area authentication ipsec spi”](#) on page 1041
  - [“area default-cost \(IPv6 OSPF\)”](#) on page 1043
  - [“area encryption ipsec spi esp”](#) on page 1044
  - [“area range \(IPv6 OSPF\)”](#) on page 1047
  - [“area stub \(IPv6 OSPF\)”](#) on page 1049
  - [“area virtual-link \(IPv6 OSPF\)”](#) on page 1050
  - [“area virtual-link authentication ipsec spi”](#) on page 1052
  - [“area virtual-link encryption ipsec spi”](#) on page 1054
  - [“auto-cost reference bandwidth \(IPv6 OSPF\)”](#) on page 1057
  - [“bandwidth”](#) on page 1059
  - [“clear ipv6 ospf process”](#) on page 1060
  - [“debug ipv6 ospf events”](#) on page 1061
  - [“debug ipv6 ospf ifsm”](#) on page 1062
  - [“debug ipv6 ospf lsa”](#) on page 1063
  - [“debug ipv6 ospf n fsm”](#) on page 1064
  - [“debug ipv6 ospf packet”](#) on page 1065
  - [“debug ipv6 ospf route”](#) on page 1066
  - [“default-information originate”](#) on page 1067

- [“default-metric \(IPv6 OSPF\)”](#) on page 1068
- [“distance \(IPv6 OSPF\)”](#) on page 1069
- [“ipv6 ospf authentication spi”](#) on page 1071
- [“ipv6 ospf cost”](#) on page 1073
- [“ipv6 ospf dead-interval”](#) on page 1075
- [“ipv6 ospf display route single-line”](#) on page 1076
- [“ipv6 ospf encryption spi esp”](#) on page 1077
- [“ipv6 ospf hello-interval”](#) on page 1080
- [“ipv6 ospf neighbor”](#) on page 1081
- [“ipv6 ospf network”](#) on page 1083
- [“ipv6 ospf priority”](#) on page 1084
- [“ipv6 ospf retransmit-interval”](#) on page 1085
- [“ipv6 ospf transmit-delay”](#) on page 1086
- [“ipv6 router ospf area”](#) on page 1087
- [“max-concurrent-dd \(IPv6 OSPF\)”](#) on page 1089
- [“passive-interface \(IPv6 OSPF\)”](#) on page 1090
- [“redistribute \(IPv6 OSPF\)”](#) on page 1091
- [“restart ipv6 ospf graceful”](#) on page 1093
- [“router ipv6 ospf”](#) on page 1094
- [“router-id \(IPv6 OSPF\)”](#) on page 1095
- [“show debugging ipv6 ospf”](#) on page 1096
- [“show ipv6 ospf”](#) on page 1097
- [“show ipv6 ospf database”](#) on page 1099
- [“show ipv6 ospf database external”](#) on page 1101
- [“show ipv6 ospf database grace”](#) on page 1102
- [“show ipv6 ospf database inter-prefix”](#) on page 1103
- [“show ipv6 ospf database inter-router”](#) on page 1104
- [“show ipv6 ospf database intra-prefix”](#) on page 1105
- [“show ipv6 ospf database link”](#) on page 1106
- [“show ipv6 ospf database network”](#) on page 1107
- [“show ipv6 ospf database router”](#) on page 1109
- [“show ipv6 ospf interface”](#) on page 1114
- [“show ipv6 ospf neighbor”](#) on page 1116
- [“show ipv6 ospf route”](#) on page 1118
- [“show ipv6 ospf virtual-links”](#) on page 1120

- [“summary-address \(IPv6 OSPF\)”](#) on page 1121
- [“timers spf \(IPv6 OSPF\) \(deprecated\)”](#) on page 1123
- [“timers spf exp \(IPv6 OSPF\)”](#) on page 1124
- [“undebug ipv6 ospf events”](#) on page 1125
- [“undebug ipv6 ospf ifsm”](#) on page 1126
- [“undebug ipv6 ospf lsa”](#) on page 1127
- [“undebug ipv6 ospf nfsm”](#) on page 1128
- [“undebug ipv6 ospf packet”](#) on page 1129
- [“undebug ipv6 ospf route”](#) on page 1130

# abr-type

**Overview** Use this command to set an OSPF Area Border Router (ABR) type.

Use the **no** variant of this command to revert the ABR type to the default setting (cisco).

**Syntax** `abr-type {cisco|ibm|standard}`  
`no abr-type {cisco|ibm|standard}`

| Parameter | Description                                                                                       |
|-----------|---------------------------------------------------------------------------------------------------|
| cisco     | Specifies an alternative ABR using Cisco implementation (RFC 3509). This is the default ABR type. |
| ibm       | Specifies an alternative ABR using IBM implementation (RFC 3509).                                 |
| standard  | Specifies a standard behavior ABR (RFC 2328).                                                     |

**Default** ABR type cisco

**Mode** Router Configuration

**Usage** Specifying the ABR type allows better interoperability between different implementations. This command is especially useful in a multi-vendor environment. The different ABR types are:

- Cisco ABR Type: By this definition, a router is considered an ABR if it has more than one area actively attached and one of them is the backbone area.
- IBM ABR Type: By this definition, a router is considered an ABR if it has more than one area actively attached and the backbone area is configured. In this case the configured backbone need not be actively connected.
- Standard ABR Type: By this definition, a router is considered an ABR if it has more than one area actively attached to it.

**Example** To set the ABR type to "ibm" use the following commands:

```
awplus# configure terminal
awplus(config)# router ipv6 ospf 100
awplus(config-router)# abr-type ibm
```



# area authentication ipsec spi

**Overview** Use this command in Router Configuration mode to enable either MD5 (Message-Digest 5) or SHA1 (Secure Hash Algorithm 1) authentication for a specified OSPF area.

Use the **no** variant of this command in Router Configuration mode to disable the authentication configured for a specified OSPF area.

**Syntax** `area <area-id> authentication ipsec spi <256-4294967295> {md5 <MD5-key>|sha1 <SHA1-key>}`  
`no area <area-id> authentication ipsec spi <256-4294967295>`

| Parameter        | Description                                                                                                                                                                                                                                                                                                                                                                                                                                                                                                                     |           |                                                        |                |                                                                    |
|------------------|---------------------------------------------------------------------------------------------------------------------------------------------------------------------------------------------------------------------------------------------------------------------------------------------------------------------------------------------------------------------------------------------------------------------------------------------------------------------------------------------------------------------------------|-----------|--------------------------------------------------------|----------------|--------------------------------------------------------------------|
| <area-id>        | The OSPF area that you are specifying the summary route default-cost for. This can be entered in either dotted decimal format or normal decimal format. Use one of the following formats:<br><table border="1"><tr><td>&lt;ip-addr&gt;</td><td>OSPF area-ID expressed in IPv4 address format A.B.C.D.</td></tr><tr><td>&lt;0-4294967295&gt;</td><td>OSPF area-ID expressed as a decimal number within the range shown.</td></tr></table><br>For example, the values 0.0.1.2 and decimal 258 would both define the same area-ID. | <ip-addr> | OSPF area-ID expressed in IPv4 address format A.B.C.D. | <0-4294967295> | OSPF area-ID expressed as a decimal number within the range shown. |
| <ip-addr>        | OSPF area-ID expressed in IPv4 address format A.B.C.D.                                                                                                                                                                                                                                                                                                                                                                                                                                                                          |           |                                                        |                |                                                                    |
| <0-4294967295>   | OSPF area-ID expressed as a decimal number within the range shown.                                                                                                                                                                                                                                                                                                                                                                                                                                                              |           |                                                        |                |                                                                    |
| <256-4294967295> | Specify an SPI (Security Parameters Index) value in the range 256 to 4294967295, entered as a decimal integer.                                                                                                                                                                                                                                                                                                                                                                                                                  |           |                                                        |                |                                                                    |
| md5              | Specify the MD5 (Message-Digest 5) hashing algorithm.                                                                                                                                                                                                                                                                                                                                                                                                                                                                           |           |                                                        |                |                                                                    |
| <MD5-key>        | Enter an MD5 key containing up to 32 hexadecimal characters.                                                                                                                                                                                                                                                                                                                                                                                                                                                                    |           |                                                        |                |                                                                    |
| sha1             | Specify the SHA-1 (Secure Hash Algorithm 1) hashing algorithm.                                                                                                                                                                                                                                                                                                                                                                                                                                                                  |           |                                                        |                |                                                                    |
| <SHA1-key>       | Enter an SHA-1 key containing up to 40 hexadecimal characters.                                                                                                                                                                                                                                                                                                                                                                                                                                                                  |           |                                                        |                |                                                                    |

**Mode** Router Configuration

**Usage** Use this command on an OSPFv3 area, use the [area virtual-link authentication ipsec spi](#) command on an OSPFv3 area virtual link. Configure the same SPI (Security Parameters Index) value on all interfaces that connect to the same link. SPI values are used by link interfaces. Use a different SPI value for a different link interface when using OSPFv3 with link interfaces.

Use the **sha1** keyword to choose SHA-1 authentication instead of entering the **md5** keyword to use MD5 authentication. The SHA-1 algorithm is more secure than the MD5 algorithm. SHA-1 uses a 40 hexadecimal character key instead of a 32 hexadecimal character key as used for MD5 authentication.

See the [OSPFv3 Feature Overview and Configuration Guide](#) for more information and examples.

**NOTE:** You can configure an authentication security policy (SPI) on an OSPFv3 area with this command, or on a VLAN interface with the [ipv6 ospf authentication spi](#) command.

When you configure authentication for an area, the security policy is applied to all VLAN interfaces in the area. However, Allied Telesis recommends a different authentication security policy is applied to each interface for higher security.

If you apply the `ipv6 ospf authentication null` command this affects authentication configured on both the VLAN interface and the OSPFv3 area.

This is due to OSPFv3 hello messages ingressing VLAN interfaces, which are part of area authentication, not being authenticated. So neighbors time out.

**Example** To enable MD5 authentication with a 32 hexadecimal character key for OSPF area 1, use the commands:

```
awplus# configure terminal
awplus(config)# router ipv6 ospf
awplus(config-router)# area 1 authentication ipsec spi 1000 md5
1234567890ABCDEF1234567890ABCDEF
```

To enable SHA-1 authentication with a 40 hexadecimal character key for OSPF area 1, use the commands:

```
awplus# configure terminal
awplus(config)# router ipv6 ospf
awplus(config-router)# area 1 authentication ipsec spi 1000
sha1 1234567890ABCDEF1234567890ABCDEF12345678
```

To disable authentication for OSPF area 1, use the commands:

```
awplus# configure terminal
awplus(config)# router ipv6 ospf
awplus(config-router)# no area 1 authentication ipsec spi 1000
```

**Related  
Commands**

[area encryption ipsec spi esp](#)  
[area virtual-link authentication ipsec spi](#)  
[area virtual-link encryption ipsec spi](#)  
[ipv6 ospf authentication spi](#)  
[ipv6 ospf encryption spi esp](#)  
[show ipv6 ospf](#)

# area default-cost (IPv6 OSPF)

**Overview** This command specifies a cost for the default summary route sent into a stub area. The **no** variant of this command removes the assigned default-route cost.

**Syntax** `area <area-id> default-cost <0-16777215>`  
`no area <area-id> default-cost`

| Parameter      | Description                                                                                                                                                                                                                                                                                                                                                                                                                                                                                                                                    |           |                                                        |                |                                                                    |
|----------------|------------------------------------------------------------------------------------------------------------------------------------------------------------------------------------------------------------------------------------------------------------------------------------------------------------------------------------------------------------------------------------------------------------------------------------------------------------------------------------------------------------------------------------------------|-----------|--------------------------------------------------------|----------------|--------------------------------------------------------------------|
| <area-id>      | The OSPF area that you are specifying the summary route default-cost for. This can be entered in either dotted decimal format or normal decimal format. Use one of the following formats:<br><table border="1"><tbody><tr><td>&lt;ip-addr&gt;</td><td>OSPF area-ID expressed in IPv4 address format A.B.C.D.</td></tr><tr><td>&lt;0-4294967295&gt;</td><td>OSPF area-ID expressed as a decimal number within the range shown.</td></tr></tbody></table><br>For example, the values 0.0.1.2 and decimal 258 would both define the same area-ID. | <ip-addr> | OSPF area-ID expressed in IPv4 address format A.B.C.D. | <0-4294967295> | OSPF area-ID expressed as a decimal number within the range shown. |
| <ip-addr>      | OSPF area-ID expressed in IPv4 address format A.B.C.D.                                                                                                                                                                                                                                                                                                                                                                                                                                                                                         |           |                                                        |                |                                                                    |
| <0-4294967295> | OSPF area-ID expressed as a decimal number within the range shown.                                                                                                                                                                                                                                                                                                                                                                                                                                                                             |           |                                                        |                |                                                                    |
| default-cost   | Indicates the cost for the default summary route used for a stub area.<br>Default: 1                                                                                                                                                                                                                                                                                                                                                                                                                                                           |           |                                                        |                |                                                                    |

**Mode** Router Configuration

**Usage** The default-cost option provides the metric for the summary default route, generated by the area border router, into the stub area. Use this option only on an area border router that is attached to the stub area.

**Example** To set the default cost to 10 in area 1 for the OSPF process P2, use the commands:

```
awplus# configure terminal
awplus(config)# router ipv6 ospf P2
awplus(config-router)# area 1 default-cost 10
```

**Related Commands** [area stub \(IPv6 OSPF\)](#)

# area encryption ipsec spi esp

**Overview** Use this command in Router Configuration mode to enable either AES-CBC (Advanced Encryption Standard-Cipher Block Chaining) or 3DES (Triple Data Encryption Standard) ESP (Encapsulating Security Payload) encryption for a specified OSPF area.

Use the **no** variant of this command in Router Configuration mode to disable the encryption configured for a specified OSPF area.

**Syntax**

```
area <area-id> encryption ipsec spi <256-4294967295> esp
{aes-cbc <AES-CBC-key>|3des <3DES-key>|null}{md5
<MD5-key>|sha1 <SHA1-key>}
no area <area-id> encryption ipsec spi <256-4294967295>
```

| Parameter        | Description                                                                                                                                                                                                                                                                                                                                                                                                                                                                                                                                                                                                                                                           |           |                                                        |                |                                                                    |
|------------------|-----------------------------------------------------------------------------------------------------------------------------------------------------------------------------------------------------------------------------------------------------------------------------------------------------------------------------------------------------------------------------------------------------------------------------------------------------------------------------------------------------------------------------------------------------------------------------------------------------------------------------------------------------------------------|-----------|--------------------------------------------------------|----------------|--------------------------------------------------------------------|
| <area-id>        | The OSPF area that you are specifying the summary route default-cost for. This can be entered in either dotted decimal format or normal decimal format. Use one of the following formats:<br><table border="1" style="width: 100%; border-collapse: collapse;"> <tr> <td style="width: 20%; text-align: center;">&lt;ip-addr&gt;</td> <td>OSPF area-ID expressed in IPv4 address format A.B.C.D.</td> </tr> <tr> <td style="width: 20%; text-align: center;">&lt;0-4294967295&gt;</td> <td>OSPF area-ID expressed as a decimal number within the range shown.</td> </tr> </table> For example, the values 0.0.1.2 and decimal 258 would both define the same area-ID. | <ip-addr> | OSPF area-ID expressed in IPv4 address format A.B.C.D. | <0-4294967295> | OSPF area-ID expressed as a decimal number within the range shown. |
| <ip-addr>        | OSPF area-ID expressed in IPv4 address format A.B.C.D.                                                                                                                                                                                                                                                                                                                                                                                                                                                                                                                                                                                                                |           |                                                        |                |                                                                    |
| <0-4294967295>   | OSPF area-ID expressed as a decimal number within the range shown.                                                                                                                                                                                                                                                                                                                                                                                                                                                                                                                                                                                                    |           |                                                        |                |                                                                    |
| <256-4294967295> | Specify an SPI (Security Parameters Index) value in the range 256 to 4294967295, entered as a decimal integer.                                                                                                                                                                                                                                                                                                                                                                                                                                                                                                                                                        |           |                                                        |                |                                                                    |
| esp              | Specify the esp keyword (Encapsulating Security Payload) to then apply either AES-CBC or 3DES encryption.                                                                                                                                                                                                                                                                                                                                                                                                                                                                                                                                                             |           |                                                        |                |                                                                    |
| aes-cbc          | Specify this keyword to enable AES-CBC (Advanced Encryption Standard-Cipher Block Chaining) encryption.                                                                                                                                                                                                                                                                                                                                                                                                                                                                                                                                                               |           |                                                        |                |                                                                    |
| <AES-CBC-key>    | Enter an AES-CBC key containing either 32, 48, or 64 hexadecimal characters.                                                                                                                                                                                                                                                                                                                                                                                                                                                                                                                                                                                          |           |                                                        |                |                                                                    |
| 3des             | Specify 3DES (Triple Data Encryption Standard) encryption.                                                                                                                                                                                                                                                                                                                                                                                                                                                                                                                                                                                                            |           |                                                        |                |                                                                    |
| <3DES-key>       | Enter a 3DES key containing 48 hexadecimal characters.                                                                                                                                                                                                                                                                                                                                                                                                                                                                                                                                                                                                                |           |                                                        |                |                                                                    |
| null             | Specify ESP without AES-CBC or 3DES encryption applied.                                                                                                                                                                                                                                                                                                                                                                                                                                                                                                                                                                                                               |           |                                                        |                |                                                                    |
| md5              | Specify the MD5 (Message-Digest 5) encryption algorithm.                                                                                                                                                                                                                                                                                                                                                                                                                                                                                                                                                                                                              |           |                                                        |                |                                                                    |
| <MD5-key>        | Enter an MD5 key containing 32 hexadecimal characters.                                                                                                                                                                                                                                                                                                                                                                                                                                                                                                                                                                                                                |           |                                                        |                |                                                                    |
| sha1             | Specify the SHA-1 (Secure Hash Algorithm 1) encryption algorithm.                                                                                                                                                                                                                                                                                                                                                                                                                                                                                                                                                                                                     |           |                                                        |                |                                                                    |
| <SHA1-key>       | Enter an SHA-1 key containing 40 hexadecimal characters.                                                                                                                                                                                                                                                                                                                                                                                                                                                                                                                                                                                                              |           |                                                        |                |                                                                    |

**Mode** Router Configuration

**Usage** When you issue this command, authentication and encryption are both enabled.

Use this command on an OSPFv3 area, use the [area virtual-link encryption ipsec spi](#) command on an OSPFv3 area virtual link. Configure the same SPI (Security Parameters Index) value on all interfaces that connect to the same link. SPI values are used by link interfaces. Use a different SPI value for a different link interface when using OSPFv3 with link interfaces.

Security is achieved using the IPv6 ESP extension header. The IPv6 ESP extension header is used to provide confidentiality, integrity, authentication, and confidentiality. Authentication fields are removed from OSPF for IPv6 packet headers, so applying IPv6 ESP extension headers are required for integrity, authentication, and confidentiality.

Use the **sha1** keyword to choose SHA-1 authentication instead of entering the **md5** keyword to use MD5 authentication. The SHA-1 algorithm is more secure than the MD5 algorithm. SHA-1 uses a 40 hexadecimal character key instead of a 32 hexadecimal character key as used for MD5 authentication.

See the [OSPFv3 Feature Overview and Configuration Guide](#) for more information and examples.

**NOTE:** You can configure an encryption security policy (SPI) on an OSPFv3 area with this command, or on a VLAN interface with the [ipv6 ospf encryption spi esp](#) command.

When you configure encryption for an area, the security policy is applied to all VLAN interfaces in the area. However, Allied Telesis recommends a different encryption security policy is applied to each interface for higher security.

If you apply the [ipv6 ospf encryption null](#) command this affects encryption configured on both the VLAN interface and the OSPFv3 area.

This is due to OSPFv3 hello messages ingressing VLAN interfaces, which are part of area encryption, not being encrypted. So neighbors time out.

**Example** To enable ESP encryption, but not apply an AES-CBC key or an 3DES key, and MD5 authentication with a 32 hexadecimal character key for OPSPF area 1, use the commands:

```
awplus# configure terminal
awplus(config)# router ipv6 ospf
awplus(config-router)# area 1 encryption ipsec spi 1000 esp null
md5 1234567890ABCDEF1234567890ABCDEF
```

To enable ESP encryption, but not apply an AES-CBC key or an 3DES key, and SHA-1 authentication with a 40 hexadecimal character key for OPSPF area 1, use the commands:

```
awplus# configure terminal
awplus(config)# router ipv6 ospf
awplus(config-router)# area 1 encryption ipsec spi 1000 esp null
sha1 1234567890ABCDEF1234567890ABCDEF12345678
```

To enable ESP encryption with a 48 hexadecimal character 3DES key and a 32 hexadecimal character MD5 authentication for OSPF area 1, use the commands:

```
awplus# configure terminal
awplus(config)# router ipv6 ospf
awplus(config-router)# area 1 encryption ipsec spi 1000 esp 3des
1234567890ABCDEF1234567890ABCDEF1234567890ABCDEF md5
1234567890ABCDEF1234567890ABCDEF
```

To enable ESP encryption with a 32 hexadecimal character AES-CBC key, and a 40 hexadecimal character SHA-1 authentication key for OSPF area 1, use the commands:

```
awplus# configure terminal
awplus(config)# router ipv6 ospf
awplus(config-router)# area 1 encryption ipsec spi 1000 esp
aes-cbc 1234567890ABCDEF1234567890ABCDEF sha1
1234567890ABCDEF1234567890ABCDEF12345678
```

To disable ESP encryption for OSPF area 1, use the commands:

```
awplus# configure terminal
awplus(config)# router ipv6 ospf
awplus(config-router)# no area 1 encryption ipsec spi 1000
```

**Related  
Commands**

[area authentication ipsec spi](#)  
[area virtual-link authentication ipsec spi](#)  
[area virtual-link encryption ipsec spi](#)  
[ipv6 ospf authentication spi](#)  
[ipv6 ospf encryption spi esp](#)  
[show ipv6 ospf](#)

# area range (IPv6 OSPF)

**Overview** Use this command to summarize OSPFv3 routes at an area boundary, configuring an IPv6 address range which consolidates OSPFv3 routes. By default, this feature is not enabled.

A summary route created by this command is then advertised to other areas by the Area Border Routers (ABRs). In this way, routing information is condensed at area boundaries and outside the area so that routes are exchanged between areas in an efficient manner.

If the network numbers in an area are arranged into sets of contiguous routes, the ABRs can be configured to advertise a summary route that covers all the individual networks within the area that fall into the specified range.

The **no** variant of this command disables this function and restores default behavior.

**Syntax** `area <area-id> range <ipv6address/prefix-length> [advertise|not-advertise]`  
`no area <area-id> range <ipv6address/prefix-length>`

| Parameter                                  | Description                                                                                                                                                                                                                                                                                                                                                                                                                                                           |
|--------------------------------------------|-----------------------------------------------------------------------------------------------------------------------------------------------------------------------------------------------------------------------------------------------------------------------------------------------------------------------------------------------------------------------------------------------------------------------------------------------------------------------|
| <code>&lt;area-id&gt;</code>               | The OSPFv3 area that you summarizing the routes for. Use one of the following formats: This can be entered in either dotted decimal format or normal decimal format.<br><br><code>&lt;A.B.C.D&gt;</code> OSPF area-ID expressed in IPv4 address format A.B.C.D.<br><br><code>&lt;0-4294967295&gt;</code> OSPF area-ID expressed as a decimal number within the range shown.<br><br>For example the values 0.0.1.2 and decimal 258 would both define the same area-ID. |
| <code>&lt;ip-addr/prefix-length&gt;</code> | The IPv6 address uses the format X::X:X/Prefix-Length. The prefix-length is usually set between 0 and 64.                                                                                                                                                                                                                                                                                                                                                             |
| <code>advertise</code>                     | Advertise this range as a summary route into other areas.                                                                                                                                                                                                                                                                                                                                                                                                             |
| <code>not-advertise</code>                 | Do not advertise this range.                                                                                                                                                                                                                                                                                                                                                                                                                                          |

**Default** The area range is not configured by default. The area range is advertised if it is configured.

**Mode** Router Configuration

**Usage** You can configure multiple ranges on a single area with multiple instances of this command, so OSPFv3 summarizes addresses for different sets of IPv6 address ranges.

Ensure OSPFv3 IPv6 routes exist in the area range for advertisement before using this command.

**Example** awplus# configure terminal  
awplus(config)# router ipv6 ospf P2  
awplus(config-router)# area 1 range 2000::/3



# area stub (IPv6 OSPF)

**Overview** This command defines an OSPF area as a stub area. By default, no stub area is defined.

Use this command when routers in the area do not require learning about external LSAs. You can define the area as a totally stubby area by configuring the Area Border Router of that area using the **area stub no-summary** command.

The **no** variant of this command removes this definition.

**Syntax** `area <area-id> stub [no-summary]`  
`no area <area-id> stub [no-summary]`

| Parameter                         | Description                                                                                                                                                                                                                                                              |
|-----------------------------------|--------------------------------------------------------------------------------------------------------------------------------------------------------------------------------------------------------------------------------------------------------------------------|
| <code>&lt;area-id&gt;</code>      | The OSPF area that you are configuring as a stub area. Use one of the following formats: This can be entered in either dotted decimal format or normal decimal format. For example the values dotted decimal 0.0.1.2 and decimal 258 would both define the same area-ID. |
| <code>&lt;A.B.C.D&gt;</code>      | OSPF area-ID, expressed in the IPv4 address format <code>&lt;A.B.C.D&gt;</code> .                                                                                                                                                                                        |
| <code>&lt;0-4294967295&gt;</code> | OSPF area-ID expressed as a decimal number within the range shown.                                                                                                                                                                                                       |
|                                   | For example the values dotted decimal 0.0.1.2 and decimal 258 would both define the same area-ID.                                                                                                                                                                        |
| <code>no-summary</code>           | Stops an ABR from sending summary link advertisements into the stub area.                                                                                                                                                                                                |

**Mode** Router Configuration

**Usage** There are two stub area router configuration commands: the **area stub** and **area default-cost** commands. In all routers attached to the stub area, configure the area by using the **area stub** command. For an area border router (ABR) attached to the stub area, also use the **area default-cost** command.

**Example**

```
awplus# configure terminal
awplus(config)# router ipv6 ospf 100
awplus(config-router)# area 100 stub
```

**Related Commands** [area default-cost \(IPv6 OSPF\)](#)

# area virtual-link (IPv6 OSPF)

**Overview** This command configures a link between a non-backbone area and the backbone, through other non-backbone areas.

In OSPF, all non-backbone areas must be connected to a backbone area. If the connection to the backbone is lost, the virtual link repairs the connection.

The **no** variant of this command removes the virtual link.

**Syntax**

```

area <area-id> virtual-link <router-id>
no area <area-id> virtual-link <router-id>
area <area-id> virtual-link <router-id>
no area <area-id> virtual-link <router-id>
area <area-id> virtual-link <router-id> [hello-interval
<1-65535>] [retransmit-interval <1-65535>] [transmit-delay
<1-65535>]
no area <area-id> virtual-link <router-id> [hello-interval]
[retransmit-interval] [transmit-delay]

```

| Parameter           | Description                                                                                                                                                        |
|---------------------|--------------------------------------------------------------------------------------------------------------------------------------------------------------------|
| <area-id>           | The area-ID of the transit area that the virtual link passes through. This can be entered in either dotted decimal format or normal decimal format as shown below. |
|                     | <A.B.C.D> OSPF area-ID, expressed in the IPv4 address format <A.B.C.D>.                                                                                            |
|                     | <0-4294967295> OSPF area-ID expressed as a decimal number within the range shown.                                                                                  |
|                     | For example the values dotted decimal 0.0.1.2 and decimal 258 would both define the same area-ID.                                                                  |
| <router-id>         | The OSPF router ID of the virtual link neighbor.                                                                                                                   |
| dead-interval       | If no packets are received from a particular neighbor for dead-interval seconds, the router considers the neighbor router to be off-line.<br>Default: 40 seconds   |
|                     | <1-65535> The number of seconds in the interval.                                                                                                                   |
| hello-interval      | The interval the router waits before it sends a hello packet.<br>Default: 10 seconds                                                                               |
|                     | <1-65535> The number of seconds in the interval.                                                                                                                   |
| retransmit-interval | The interval the router waits before it retransmits a packet.<br>Default: 5 seconds                                                                                |
|                     | <1-65535> The number of seconds in the interval.                                                                                                                   |

| Parameter      | Description                                                                       |
|----------------|-----------------------------------------------------------------------------------|
| transmit-delay | The interval the router waits before it transmits a packet.<br>Default: 1 seconds |
|                | <1-65535> The number of seconds in the interval.                                  |

**Mode** Router Configuration

**Usage** You can configure virtual links between any two backbone routers that have an interface to a common non-backbone area. The protocol treats these two routers, joined by a virtual link, as if they were connected by an unnumbered point-to-point network. To configure a virtual link, you require:

- The transit area-ID, i.e. the area-ID of the non-backbone area that the two backbone routers are both connected to.
- The corresponding virtual link neighbor's router ID. To see the router ID use the [show ipv6 ospf](#) command.

Configure the **hello-interval** to be the same for all routers attached to a common network. A short **hello-interval** results in the router detecting topological changes faster but also an increase in the routing traffic.

The **retransmit-interval** is the expected round-trip delay between any two routers in a network. Set the value to be greater than the expected round-trip delay to avoid needless retransmissions.

The **transmit-delay** is the time taken to transmit a link state update packet on the interface. Before transmission, the link state advertisements in the update packet, are incremented by this amount. Set the **transmit-delay** to be greater than zero. Also, take into account the transmission and propagation delays for the interface.

**Example** To configure a virtual link through area 1 to the router with router-ID 10.10.11.50, use the following commands:

```
awplus# configure terminal
awplus(config)# router ipv6 ospf 100
awplus(config-router)# area 1 virtual-link 10.10.11.50 hello 5
dead 10
```

**Related Commands** [show ipv6 ospf](#)

# area virtual-link authentication ipsec spi

**Overview** Use this command in Router Configuration mode to enable authentication for virtual links in a specified OSPF area.

Use the **no** variant of this command in Router Configuration mode to disable authentication for virtual links in a specified OSPF area.

**Syntax** `area <area-id> virtual-link <router-ID> authentication ipsec spi <256-4294967295> {md5 <MD5-key>|sha1 <SHA1-key>}`  
`no area <area-id> virtual-link <router-ID> authentication ipsec spi <256-4294967295>`

| Parameter        | Description                                                                                                                                                                               |
|------------------|-------------------------------------------------------------------------------------------------------------------------------------------------------------------------------------------|
| <area-id>        | The OSPF area that you are specifying the summary route default-cost for. This can be entered in either dotted decimal format or normal decimal format. Use one of the following formats: |
|                  | <ip-addr>      OSPF area-ID expressed in IPv4 address format A.B.C.D.                                                                                                                     |
|                  | <0-4294967295>      OSPF area-ID expressed as a decimal number within the range shown.                                                                                                    |
|                  | For example, the values 0.0.1.2 and decimal 258 would both define the same area-ID.                                                                                                       |
| virtual-link     | Specify a virtual link and its parameters.                                                                                                                                                |
| <router-ID>      | Enter a router ID associated with a virtual link neighbor in IPv4 address format A.B.C.D.                                                                                                 |
| authentication   | Specify this keyword to enable authentication.                                                                                                                                            |
| ipsec            | Specify this keyword to use IPsec authentication.                                                                                                                                         |
| spi              | Specify this keyword to set the SPI (Security Parameters Index).                                                                                                                          |
| <256-4294967295> | Specify an SPI (Security Parameters Index) value in the range 256 to 4294967295, entered as a decimal integer.                                                                            |
| md5              | Specify the MD5 (Message-Digest 5) encryption algorithm.                                                                                                                                  |
| <MD5-key>        | Enter an MD5 key containing 32 hexadecimal characters.                                                                                                                                    |
| sha1             | Specify the SHA-1 (Secure Hash Algorithm 1) encryption algorithm.                                                                                                                         |
| <SHA1-key>       | Enter an SHA-1 key containing 40 hexadecimal characters.                                                                                                                                  |

**Mode** Router Configuration

**Usage** Use this command on an OSPFv3 area virtual link, use the [area authentication ipsec spi](#) command on an OSPFv3 area. Configure the same SPI (Security Parameters Index) value on all interfaces that connect to the same link. SPI values are used by

link interfaces. Use a different SPI value for a different link interface when using OSPFv3 with link interfaces.

OSPFv3 areas are connected to a backbone area. Virtual links can be configured to repair lost connections to a backbone area for OSPFv3 areas. To configure an OSPFv3 virtual link, use a router ID instead of the IPv6 prefix of the router.

Use the **sha1** keyword to choose SHA-1 authentication instead of entering the **md5** keyword to use MD5 authentication. The SHA-1 algorithm is more secure than the MD5 algorithm. SHA-1 uses a 40 hexadecimal character key instead of a 32 hexadecimal character key as used for MD5 authentication.

See the [OSPFv3 Feature Overview and Configuration Guide](#) for more information and examples.

**Example** To enable MD5 authentication with a 32 hexadecimal character key for virtual links in OSPF area 1, use the commands:

```
awplus# configure terminal
awplus(config)# router ipv6 ospf
awplus(config-router)# area 1 virtual-link 10.0.0.1
authentication ipsec spi 1000 md5
1234567890ABCDEF1234567890ABCDEF
```

To enable SHA-1 authentication with a 40 hexadecimal character key for virtual links in OSPF area 1, use the commands:

```
awplus# configure terminal
awplus(config)# router ipv6 ospf
awplus(config-router)# area 1 virtual-link 10.0.0.1
authentication ipsec spi 1000 sha1
1234567890ABCDEF1234567890ABCDEF12345678
```

To disable authentication for virtual links in OSPF area 1, use the commands:

```
awplus# configure terminal
awplus(config)# router ipv6 ospf
awplus(config-router)# no area 1 virtual-link ipsec spi 1000
```

**Related Commands**

- [area authentication ipsec spi](#)
- [area encryption ipsec spi esp](#)
- [area virtual-link encryption ipsec spi](#)
- [show ipv6 ospf virtual-links](#)

# area virtual-link encryption ipsec spi

**Overview** Use this command in Router Configuration mode to enable either AES-CBC (Advanced Encryption Standard-Cipher Block Chaining) or 3DES (Triple Data Encryption Standard) ESP (Encapsulating Security Payload) encryption for virtual links in a specified OSPF area.

Use the **no** variant of this command in Router Configuration mode to disable encryption configured for virtual links in a specified OSPF area.

**Syntax**

```
area <area-id> virtual-link <router-ID> encryption ipsec spi
<256-4294967295> esp {aes-cbc <AES-CBC-key>|3des
<3DES-key>|null}{md5 <MD5-key>|sha1 <SHA1-key>}
no area <area-id> encryption ipsec spi <256-4294967295>
```

| Parameter                                                                           | Description                                                                                                                                                                                                                                                                                                                                                                                                                                                                                                                                                                                           |           |                                                        |                |                                                                    |                                                                                     |  |
|-------------------------------------------------------------------------------------|-------------------------------------------------------------------------------------------------------------------------------------------------------------------------------------------------------------------------------------------------------------------------------------------------------------------------------------------------------------------------------------------------------------------------------------------------------------------------------------------------------------------------------------------------------------------------------------------------------|-----------|--------------------------------------------------------|----------------|--------------------------------------------------------------------|-------------------------------------------------------------------------------------|--|
| <area-id>                                                                           | The OSPF area that you are specifying the summary route default- cost for. This can be entered in either dotted decimal format or normal decimal format. Use one of the following formats:<br><table border="1" data-bbox="730 1025 1423 1279"> <tr> <td>&lt;ip-addr&gt;</td> <td>OSPF area-ID expressed in IPv4 address format A.B.C.D.</td> </tr> <tr> <td>&lt;0-4294967295&gt;</td> <td>OSPF area-ID expressed as a decimal number within the range shown.</td> </tr> <tr> <td colspan="2">For example, the values 0.0.1.2 and decimal 258 would both define the same area-ID.</td> </tr> </table> | <ip-addr> | OSPF area-ID expressed in IPv4 address format A.B.C.D. | <0-4294967295> | OSPF area-ID expressed as a decimal number within the range shown. | For example, the values 0.0.1.2 and decimal 258 would both define the same area-ID. |  |
| <ip-addr>                                                                           | OSPF area-ID expressed in IPv4 address format A.B.C.D.                                                                                                                                                                                                                                                                                                                                                                                                                                                                                                                                                |           |                                                        |                |                                                                    |                                                                                     |  |
| <0-4294967295>                                                                      | OSPF area-ID expressed as a decimal number within the range shown.                                                                                                                                                                                                                                                                                                                                                                                                                                                                                                                                    |           |                                                        |                |                                                                    |                                                                                     |  |
| For example, the values 0.0.1.2 and decimal 258 would both define the same area-ID. |                                                                                                                                                                                                                                                                                                                                                                                                                                                                                                                                                                                                       |           |                                                        |                |                                                                    |                                                                                     |  |
| virtual-link                                                                        | Specify a virtual link and its parameters.                                                                                                                                                                                                                                                                                                                                                                                                                                                                                                                                                            |           |                                                        |                |                                                                    |                                                                                     |  |
| <router-ID>                                                                         | Enter a router ID associated with a virtual link neighbor in IPv4 address format A.B.C.D.                                                                                                                                                                                                                                                                                                                                                                                                                                                                                                             |           |                                                        |                |                                                                    |                                                                                     |  |
| encryption                                                                          | Specify this keyword to enable encryption.                                                                                                                                                                                                                                                                                                                                                                                                                                                                                                                                                            |           |                                                        |                |                                                                    |                                                                                     |  |
| ipsec                                                                               | Specify this keyword to use IPsec authentication.                                                                                                                                                                                                                                                                                                                                                                                                                                                                                                                                                     |           |                                                        |                |                                                                    |                                                                                     |  |
| spi                                                                                 | Specify this keyword to set the SPI (Security Parameters Index).                                                                                                                                                                                                                                                                                                                                                                                                                                                                                                                                      |           |                                                        |                |                                                                    |                                                                                     |  |
| <256-4294967295>                                                                    | Specify an SPI (Security Parameters Index) value in the range 256 to 4294967295, entered as a decimal integer.                                                                                                                                                                                                                                                                                                                                                                                                                                                                                        |           |                                                        |                |                                                                    |                                                                                     |  |
| esp                                                                                 | Specify the esp keyword (Encapsulating Security Payload) to then apply either AES-CBC or 3DES encryption.                                                                                                                                                                                                                                                                                                                                                                                                                                                                                             |           |                                                        |                |                                                                    |                                                                                     |  |
| aes-cbc                                                                             | Specify this keyword to enable AES-CBC (Advanced Encryption Standard-Cipher Block Chaining) encryption.                                                                                                                                                                                                                                                                                                                                                                                                                                                                                               |           |                                                        |                |                                                                    |                                                                                     |  |
| <AES-CBC-key>                                                                       | Enter an AES-CBC key containing either 32, 48, or 64 hexadecimal characters.                                                                                                                                                                                                                                                                                                                                                                                                                                                                                                                          |           |                                                        |                |                                                                    |                                                                                     |  |
| 3des                                                                                | Specify 3DES (Triple Data Encryption Standard) encryption.                                                                                                                                                                                                                                                                                                                                                                                                                                                                                                                                            |           |                                                        |                |                                                                    |                                                                                     |  |
| <3DES-key>                                                                          | Enter a 3DES key containing 48 hexadecimal characters.                                                                                                                                                                                                                                                                                                                                                                                                                                                                                                                                                |           |                                                        |                |                                                                    |                                                                                     |  |

| Parameter  | Description                                                       |
|------------|-------------------------------------------------------------------|
| null       | Specify ESP without AES-CBC or 3DES encryption applied.           |
| md5        | Specify the MD5 (Message-Digest 5) encryption algorithm.          |
| <MD5-key>  | Enter an MD5 key containing 32 hexadecimal characters.            |
| sha1       | Specify the SHA-1 (Secure Hash Algorithm 1) encryption algorithm. |
| <SHA1-key> | Enter an SHA-1 key containing 40 hexadecimal characters.          |

**Mode** Router Configuration

**Usage** When you issue this command, authentication and encryption are both enabled.

Use this command on an OSPFv3 area virtual link, use the [area encryption ipsec spi esp](#) command on an OSPFv3 area. Configure the same SPI (Security Parameters Index) value on all interfaces that connect to the same link. SPI values are used by link interfaces. Use a different SPI value for a different link interface when using OSPFv3 with link interfaces.

Security is achieved using the IPv6 ESP extension header. ESP is used to provide confidentiality, integrity, authentication, and confidentiality. Authentication fields are removed from OSPF for IPv6 packet headers. The IPv6 ESP extension header is required for integrity, authentication, and confidentiality.

Note that interface configuration takes priority over area configuration. If an interface configuration is removed then an area configuration is applied to an interface instead.

Use the **sha1** keyword to choose SHA-1 authentication instead of entering the **md5** keyword to use MD5 authentication. The SHA-1 algorithm is more secure than the MD5 algorithm. SHA-1 uses a 40 hexadecimal character key instead of a 32 hexadecimal character key as used for MD5 authentication.

See the [OSPFv3 Feature Overview and Configuration Guide](#) for more information and examples.

**Example** To enable ESP encryption, but not apply an AES-CBC key or a 3DES key, and MD5 authentication with a 32 hexadecimal character key for virtual links in OPSPF area 1, use the commands:

```
awplus# configure terminal
awplus(config)# router ipv6 ospf
awplus(config-router)# area 1 virtual-link 10.0.0.1 encryption
ipsec spi 1000 esp null md5 1234567890ABCDEF1234567890ABCDEF
```

To enable ESP encryption, but not apply an AES-CBC key or a 3DES key, and SHA-1 authentication with a 40 hexadecimal character key for virtual links in OSPF area 1, use the commands:

```
awplus# configure terminal
awplus(config)# router ipv6 ospf
awplus(config-router)# area 1 virtual-link 10.0.0.1 encryption
ipsec spi 1000 esp null sha1
1234567890ABCDEF1234567890ABCDEF12345678
```

To enable ESP encryption with a 32 hexadecimal character AES-CBC key and a 40 hexadecimal character SHA-1 authentication key for virtual links in OSPF area 1, use the commands:

```
awplus# configure terminal
awplus(config)# router ipv6 ospf
awplus(config-router)# area 1 virtual-link 10.0.0.1 encryption
ipsec spi 1000 esp aes-cbc 1234567890ABCDEF1234567890ABCDEF
sha1 1234567890ABCDEF1234567890ABCDEF12345678
```

To enable ESP encryption with a 48 hexadecimal character 3DES key and a 40 hexadecimal character SHA-1 authentication key for virtual links in OSPF area 1, use the commands:

```
awplus# configure terminal
awplus(config)# router ipv6 ospf
awplus(config-router)# area 1 virtual-link 10.0.0.1 encryption
ipsec spi 1000 esp 3des
1234567890ABCDEF1234567890ABCDEF1234567890ABCDEF sha1
1234567890ABCDEF1234567890ABCDEF12345678
```

To disable authentication for virtual links in OSPF area 1, use the commands:

```
awplus# configure terminal
awplus(config)# router ipv6 ospf
awplus(config-router)# no area 1 virtual-link 10.0.0.1
authentication ipsec spi 1000
```

**Related  
Commands**

[area authentication ipsec spi](#)  
[area encryption ipsec spi esp](#)  
[area virtual-link authentication ipsec spi](#)  
[show ipv6 ospf virtual-links](#)



# auto-cost reference bandwidth (IPv6 OSPF)

**Overview** This command controls how OSPF calculates default metrics for the interface. Use the **no** variant of this command to assign cost based only on the interface bandwidth.

**Syntax** `auto-cost reference-bandwidth <1-4294967>`  
`no auto-cost reference-bandwidth`

| Parameter                      | Description                                                   |
|--------------------------------|---------------------------------------------------------------|
| <code>&lt;1-4294967&gt;</code> | The reference bandwidth, measured in Mbits per second (Mbps). |

**Default** 1000 Mbps

**Usage** By default, OSPF calculates the OSPF metric for an interface by dividing the reference bandwidth by the interface bandwidth. The default for the reference bandwidth is 1000 Mbps. As a result, if this default is used, there is very little difference between the metrics applied to interfaces of increasing bandwidth beyond 1000 Mbps.

The auto-cost command is used to alter this reference bandwidth in order to give a real difference between the metrics of high bandwidth links of differing bandwidths. In a network that has multiple links with high bandwidths, specify a larger reference bandwidth value to differentiate the costs on those links.

Cost is calculated by dividing the reference bandwidth (Mbps) by the layer 3 interface (Switched Virtual Interface (SVI), Loopback or Ethernet interface) bandwidth. Interface bandwidth may be altered by using the [bandwidth](#) command as the SVI does not auto-detect the bandwidth based on the speed of associated device ports.

When the reference bandwidth calculation results in a cost integer greater than 1 but contains a fractional value (the value after the decimal point), the result rounds down to the nearest integer. The following example shows how the cost is calculated.

The reference bandwidth is 1000 Mbps and the interface bandwidth is 7 Mbps.

Calculation =  $1000/7$

Calculation result = 142.85 (integer of 142, fractional value of 0.85)

Result after rounding down to the nearest integer = 142 (Interface cost is 142)

When the reference bandwidth calculation results in a cost less than 1, it is rounded up to the nearest integer which is 1. The following example shows how the cost is calculated.

The reference bandwidth is 1000 Mbps and the interface bandwidth is 10000 Mbps.

Calculation =  $1000/10000$

Calculation result = 0.1

Result after rounding up to the nearest integer = 1 (Interface cost is 1)

The auto-cost reference bandwidth value should be consistent across all OSPF routers in the OSPF process.

Note that using the `ipv6 ospf cost` command on a layer 3 interface will override the cost calculated by this command.

**Mode** Router Configuration

**Example**

```
awplus# configure terminal
awplus(config)# router ipv6 ospf 20
awplus(config-router)# auto-cost reference-bandwidth 1000
```

**Related  
Commands** `ipv6 ospf cost`

# bandwidth

**Overview** Use this command to specify the maximum bandwidth to be used for each VLAN interface. The bandwidth value is in bits per second. OSPF uses this to calculate metrics for the VLAN interface.

The **no** variant of this command removes any applied bandwidth value and replaces it with a value equal to the lowest port speed within that VLAN.

**Syntax** `bandwidth <bandwidth-setting>`  
`no bandwidth`

| Parameter                              | Description                                                                                                                                                                                                                                                                      |
|----------------------------------------|----------------------------------------------------------------------------------------------------------------------------------------------------------------------------------------------------------------------------------------------------------------------------------|
| <code>&lt;bandwidth-setting&gt;</code> | Sets the bandwidth for the interface. Enter a value in the range 1 to 10000000000 bits per second. Note that to avoid entering many zeros, you can add k, m, or g to internally add 3, 6 or 9 zeros to the number entered. For example entering 1k is the same as entering 1000. |

**Mode** Interface Configuration for a VLAN interface.

**Example** To set the bandwidth on VLAN2 to be 1 Mbps, use the following commands:

```
awplus# configure terminal
awplus(config)# interface vlan2
awplus(config-if)# bandwidth 1000000
```

Or

```
awplus(config-if)# bandwidth 1m
```

**Related Commands** [show interface](#)

# clear ipv6 ospf process

**Overview** This command clears and restarts the IPv6 OSPF routing process. Specify the Process ID to clear one particular OSPF process. When no Process ID is specified, this command clears all running OSPF processes.

**Syntax** `clear ipv6 ospf [<0-65535>] process`

| Parameter | Description             |
|-----------|-------------------------|
| <0-65535> | The routing process ID. |

**Mode** Privileged Exec

**Example** `awplus# clear ipv6 ospf process`

# debug ipv6 ospf events

**Overview** This command enables IPv6 OSPF debugging for event troubleshooting.

To enable all debugging options, specify **debug ipv6 ospf event** with no additional parameters.

The **no** and **undebug** variants of this command disable OSPF debugging. Using this command with no parameters entered, will disable debugging for all parameter options.

**Syntax** `debug ipv6 ospf events [abr] [asbr] [os][router] [vlink]`  
`no debug ipv6 ospf events [abr] [asbr] [os] [router] [vlink]`

| Parameter | Description                |
|-----------|----------------------------|
| abr       | Shows ABR events.          |
| asbr      | Shows ASBR events.         |
| router    | Shows other router events. |
| os        | Shows OS events.           |
| vlink     | Shows virtual link events. |

**Mode** Privileged Exec and Global Configuration

**Example** To enable IPv6 event debugging and show ABR events, use the following command:

```
awplus# debug ipv6 ospf events asbr
```

# debug ipv6 ospf ifsm

**Overview** This command specifies debugging options for IPv6 OSPF Interface Finite State Machine (IFSM) troubleshooting.

To enable all debugging options, specify **debug ipv6 ospf ifsm** with no additional parameters.

The **no** and **undebug** variants of this command disable IPv6 OSPF IFSM debugging. Use these commands without parameters to disable all the options.

**Syntax** `debug ipv6 ospf ifsm [events] [status] [timers]`  
`no debug ipv6 ospf ifsm [events] [status] [timers]`

| Parameter | Description                       |
|-----------|-----------------------------------|
| events    | Displays IFSM event information.  |
| status    | Displays IFSM status information. |
| timers    | Displays IFSM timer information.  |

**Mode** Privileged Exec and Global Configuration

**Example** To specify IPv6 OSPF debugging options to display IPv6 OSPF IFSM events information, use the following commands:

```
awplus# debug ipv6 ospf ifsm events
```

**Related Commands** [terminal monitor](#)  
[undebug ipv6 ospf ifsm](#)

# debug ipv6 ospf lsa

**Overview** This command enables debugging options for IPv6 OSPF Link State Advertisements (LSA) troubleshooting. This displays information related to internal operations of LSAs.

To enable all debugging options, specify **debug ipv6 ospf lsa** with no additional parameters.

The **no** and **undebug** variants of this command disable IPv6 OSPF LSA debugging. Use this command without parameters to disable all the options.

**Syntax**

```
debug ipv6 ospf lsa [flooding] [generate] [install] [maxage] [refresh]
no debug ipv6 ospf lsa [flooding] [generate] [install] [maxage] [refresh]
```

| Parameter | Description                              |
|-----------|------------------------------------------|
| flooding  | Displays LSA flooding.                   |
| generate  | Displays LSA generation.                 |
| install   | Show LSA installation.                   |
| maxage    | Shows maximum age of the LSA in seconds. |
| refresh   | Displays LSA refresh.                    |

**Mode** Privileged Exec and Global Configuration

**Examples** To enable debugging for IPv6 OSPF refresh LSA, use the following commands:

```
awplus# debug ipv6 ospf lsa refresh
```

**Related Commands** [terminal monitor](#)  
[undebug ipv6 ospf lsa](#)

# debug ipv6 ospf nfsm

**Overview** This command enables debugging options for IPv6 OSPF Neighbor Finite State Machines (NFSMs).

To enable all debugging options, specify **debug ipv6 ospf nfsm** with no additional parameters.

The **no** and **undebug** variants of this command disable IPv6 OSPF NFSM debugging. Use this command without parameters to disable all the options.

**Syntax** `debug ipv6 ospf nfsm [events] [status] [timers]`  
`no debug ipv6 ospf nfsm [events] [status] [timers]`

| Parameter | Description                       |
|-----------|-----------------------------------|
| events    | Displays NFSM event information.  |
| status    | Displays NFSM status information. |
| timers    | Displays NFSM timer information.  |

**Mode** Privileged Exec and Global Configuration

**Examples** To enable IPv6 debugging option to display timer information, use the following command:

```
awplus# debug ipv6 ospf nfsm timers
```

**Related Commands** [terminal monitor](#)  
[undebug ipv6 ospf nfsm](#)



# debug ipv6 ospf packet

**Overview** This command enables debugging options for IPv6 OSPF packets.

To enable all debugging options, specify **debug ipv6 ospf packet** with no additional parameters.

The **no** and **undebug** variants of this command disable IPv6 OSPF packet debugging. Use this command without parameters to disable all options.

**Syntax**

```
debug ipv6 ospf packet [dd] [detail] [hello] [ls-ack]
[ls-request] [ls-update] [recv] [send]
no debug ipv6 ospf packet [dd] [detail] [hello] [ls-ack]
[ls-request] [ls-update] [recv] [send]
```

| Parameter  | Description                                                   |
|------------|---------------------------------------------------------------|
| dd         | Specifies debugging for IPv6 OSPF database descriptions.      |
| detail     | Sets the debug option to detailed information.                |
| hello      | Specifies debugging for IPv6 OSPF hello packets.              |
| ls-ack     | Specifies debugging for IPv6 OSPF link state acknowledgments. |
| ls-request | Specifies debugging for IPv6 OSPF link state requests.        |
| ls-update  | Specifies debugging for IPv6 OSPF link state updates.         |
| recv       | Specifies the debug option set for received packets.          |
| send       | Specifies the debug option set for sent packets.              |

**Mode** Privileged Exec and Global Configuration

**Examples** To enable debugging for hello packets, use the following command:

```
awplus# debug ipv6 ospf packet hello
```

**Related Commands** [terminal monitor](#)  
[undebug ipv6 ospf packet](#)

# debug ipv6 ospf route

**Overview** This command enables debugging of route calculation. Use this command without parameters to turn on all the options.

The **no** and **undebug** variants of this command disable IPv6 OSPF route debugging. Use this command without parameters to disable all options.

**Syntax** `debug ipv6 ospf route [ase] [ia] [install] [spf]`  
`no debug ipv6 ospf route [ase] [ia] [install] [spf]`

| Parameter | Description                                              |
|-----------|----------------------------------------------------------|
| ase       | Specifies the debugging of external route calculation.   |
| ia        | Specifies the debugging of inter-area route calculation. |
| install   | Specifies the debugging of route installation.           |
| spf       | Specifies the debugging of SPF calculation.              |

**Mode** Privileged Exec and Global Configuration

**Examples** To enable IPv6 route debugging of inter-area route calculations, use the following command:

```
awplus# debug ipv6 ospf route ia
```

**Related Commands** [terminal monitor](#)  
[undebug ipv6 ospf route](#)

# default-information originate

**Overview** This command creates a default external route into an OSPF routing domain.

When you use the **default-information originate** command to redistribute routes into an OSPF routing domain, then the system acts like an Autonomous System Boundary Router (ASBR). By default, an ASBR does not generate a default route into the OSPF routing domain.

When using this command, also specify the **route-map <route-map>** option to avoid a dependency on the default network in the routing table.

The **metric-type** is an external link type associated with the default route advertised into the OSPF routing domain. The value of the external route could be either Type 1 or 2. The default is Type 2.

The **no** variant of this command disables this feature.

**Syntax**

```
default-information originate [always] [metric <metric>]
[metric-type <1-2>] [route-map <route-map>]

no default-information originate [always] [metric]
[metric-type] [route-map]
```

| Parameter   | Description                                                                                                                                                                |
|-------------|----------------------------------------------------------------------------------------------------------------------------------------------------------------------------|
| always      | Used to advertise the default route regardless of whether there is a default route.                                                                                        |
| <metric>    | The metric value used in creating the default route. Enter a value in the range 0 to 16777214. The default metric value is 10. The value used is specific to the protocol. |
| <1-2>       | External metric type for default routes, either OSPF External Type 1 or Type 2 metrics. Enter the value 1 or 2.                                                            |
| route-map   | Specifies to use a specific route-map.                                                                                                                                     |
| <route-map> | The route-map name. It is a string comprised of any characters, numbers or symbols.                                                                                        |

**Mode** Router Configuration

**Example**

```
awplus# configure terminal
awplus(config)# router ospf 100
awplus(config-router)# default-information originate always
metric 23 metric-type 2 route-map myinfo
```

**Related Commands** [route-map](#)

# default-metric (IPv6 OSPF)

**Overview** This command sets default metric value for routes redistributed into the IPv6 OSPF routing protocol.

The **no** variant of this command returns IPv6 OSPF to using built-in, automatic metric translations, as appropriate for each routing protocol.

**Syntax** `default-metric <0-16777214>`  
`no default-metric [<0-16777214>]`

| Parameter                       | Description                                                          |
|---------------------------------|----------------------------------------------------------------------|
| <code>&lt;1-16777214&gt;</code> | Default metric value appropriate for the specified routing protocol. |

**Mode** Router Configuration

**Usage** A default metric facilitates redistributing routes even with incompatible metrics. If the metrics do not convert, the default metric provides an alternative and enables the redistribution to continue. The effect of this command is that IPv6 OSPF will use the same metric value for **all** redistributed routes. Use this command in conjunction with the [redistribute \(IPv6 OSPF\)](#) command.

**Examples**

```
awplus# configure terminal
awplus(config)# router ipv6 ospf 100
awplus(config-router)# default-metric 100
awplus# configure terminal
awplus(config)# router ipv6 ospf 100
awplus(config-router)# no default-metric
```

**Related commands** [redistribute \(IPv6 OSPF\)](#)

# distance (IPv6 OSPF)

**Overview** This command sets the administrative distance for OSPFv3 routes based on the route type. Your device uses this value to select between two or more routes to the same destination from two different routing protocols. The route with the smallest administrative distance value is added to the Forwarding Information Base (FIB). See the [Route Selection Feature Overview and Configuration Guide](#) for more information.

Use the command **distance ospfv3** to set the distance for an entire category of OSPFv3 routes, rather than the specific routes that pass an access list.

Use the command **distance <1-254>**, with no other parameter, to set the same distance for all OSPFv3 route types.

The **no** variant of this command sets the administrative distance for OSPFv3 routes to the default of 110.

**Syntax**

```
distance <1-254>
distance ospfv3 {external <1-254>|inter-area <1-254>|intra-area <1-254>}
no distance {ospfv3|<1-254>}
```

| Parameter  | Description                                                                                                                                      |
|------------|--------------------------------------------------------------------------------------------------------------------------------------------------|
| <1-254>    | Specify the Administrative Distance value for OSPFv3 routes.                                                                                     |
| external   | Sets the distance for routes from other routing domains, learned by redistribution.<br>Specify an OSPFv3 external distance in the range <1-254>. |
| inter-area | Sets the distance for all routes from one area to another area.<br>Specify an OSPFv3 inter-area distance in the range <1-254>.                   |
| intra-area | Sets the distance for all routes within an area.<br>Specify an OSPFv3 intra-area distance in the range <1-254>.                                  |

**Default** The default OSPFv3 administrative distance is 110. The default Administrative Distance for each type of route (intra, inter, or external) is 110.

**Mode** Router Configuration

**Usage** The administrative distance rates the trustworthiness of a routing information source. The distance could be any integer from 0 to 254. A higher distance value indicates a lower trust rating. For example, an administrative distance of 254 indicates that the routing information source cannot be trusted and should be ignored.

Use this command to set the distance for an entire group of routes, rather than a specific route that passes an access list.

**Examples** To set the following administrative distances for route types in OSPF 100:

- 20 for inter-area routes
- 10 for intra-area routes
- 40 for external routes

use the commands:

```
awplus(config)# router ipv6 ospf 100
awplus(config-router)# distance ospfv3 inter-area 20 intra-area
10 external 40
```

To set the administrative distance for all routes in OSPFv3 100 back to the default of 110, use the commands:

```
awplus(config)# router ipv6 ospf 100
awplus(config-router)# no distance ospfv3
```

# ipv6 ospf authentication spi

**Overview** Use this command in Interface Configuration mode to enable either MD5 (Message-Digest 5) or SHA1 (Secure Hash Algorithm 1) authentication for a specified interface.

Use the **no** variant of this command in Interface Configuration mode to disable the authentication configured for a specified interface.

**Syntax** `ipv6 ospf authentication ipsec spi <256-4294967295> {md5 <MD5-key>|sha1 <SHA1-key>}`  
`ipv6 ospf authentication null`  
`no ipv6 ospf authentication ipsec spi <256-4294967295>`

| Parameter        | Description                                                                                                                                                                                                   |
|------------------|---------------------------------------------------------------------------------------------------------------------------------------------------------------------------------------------------------------|
| authentication   | Specify this keyword to enable authentication.                                                                                                                                                                |
| ipsec            | Specify this keyword to use IPsec authentication.                                                                                                                                                             |
| spi              | Specify this keyword to set the SPI (Security Parameters Index).                                                                                                                                              |
| <256-4294967295> | Specify an SPI (Security Parameters Index) value in the range 256 to 4294967295, entered as a decimal integer.                                                                                                |
| md5              | Specify the MD5 (Message-Digest 5) hashing algorithm.                                                                                                                                                         |
| <MD5-key>        | Enter an MD5 key containing up to 32 hexadecimal characters.                                                                                                                                                  |
| sha1             | Specify the SHA-1 (Secure Hash Algorithm 1) hashing algorithm.                                                                                                                                                |
| <SHA1-key>       | Enter an SHA-1 key containing up to 40 hexadecimal characters.                                                                                                                                                |
| null             | Specify no authentication is applied when no other parameters are applied after this keyword ( <code>ipv6 ospf authentication null</code> ). Note this overrides any existing area authentication configured. |

**Mode** Interface Configuration

**Default** Authentication is not configured on an interface by default.

**Usage** Configure the same SPI (Security Parameters Index) value on all interfaces that connect to the same link. SPI values are used by link interfaces. Use a different SPI value for a different link interface when using OSPFv3 with link interfaces.

Use the **sha1** keyword to choose SHA-1 authentication instead of entering the **md5** keyword to use MD5 authentication. The SHA-1 algorithm is more secure than the MD5 algorithm. SHA-1 uses a 40 hexadecimal character key instead of a 32 hexadecimal character key as used for MD5 authentication.

Use the **null** keyword to override existing area authentication. Apply the null keyword if area authentication is already configured to configure authentication on an interface.

Use the **null** keyword to override existing area authentication. Apply the **null** keyword if area authentication is already configured to configure authentication on an interface.

See the [OSPFv3 Feature Overview and Configuration Guide](#) for more information and examples.

**NOTE:** You can configure an authentication security policy (SPI) on a VLAN interface with this command, or an OSPFv3 area with the [area authentication ipsec spi](#) command.

When you configure authentication for an area, the security policy is applied to all VLAN interfaces in the area. Allied Telesis recommends a different authentication security policy is applied to each interface for higher security.

If you apply the `ipv6 ospf authentication null` command this affects authentication configured on both the VLAN interface and the OSPFv3 area.

This is due to OSPFv3 hello messages ingressing VLAN interfaces, which are part of area authentication, not being authenticated. So neighbors time out.

**Example** To enable MD5 authentication with a 32 hexadecimal character key for interface VLAN 2, use the commands:

```
awplus# configure terminal
awplus(config)# interface vlan2
awplus(config-if)# area 1 authentication ipsec spi 1000 md5
1234567890ABCDEF1234567890ABCDEF
```

To enable SHA-1 authentication with a 32 hexadecimal character key for interface VLAN 2, use the commands:

```
awplus# configure terminal
awplus(config)# interface vlan2
awplus(config-if)# ipv6 ospf authentication ipsec spi 1000 sha1
1234567890ABCDEF1234567890ABCDEF12345678
```

To specify no authentication is applied to interface VLAN 2, use the commands:

```
awplus# configure terminal
awplus(config)# interface vlan2
awplus(config-if)# ipv6 ospf authentication null
```

To disable authentication for interface VLAN 2, use the commands:

```
awplus# configure terminal
awplus(config)# interface vlan2
awplus(config-if)# no ipv6 ospf authentication ipsec spi 1000
```

**Related Commands**

- [area authentication ipsec spi](#)
- [area encryption ipsec spi esp](#)
- [ipv6 ospf encryption spi esp](#)
- [show ipv6 ospf interface](#)



# ipv6 ospf cost

**Overview** This command explicitly specifies the cost of the link-state metric in a router-LSA. The interface cost indicates the overhead required to send packets across a certain VLAN interface. Use this command to set the VLAN interface cost manually. The **no** variant of this command resets the VLAN interface cost to the default.

**Syntax** `ipv6 ospf cost <1-65535>`  
`no ipv6 ospf cost`

| Parameter | Description            |
|-----------|------------------------|
| <1-65535> | The link-state metric. |

**Default** By default there is no static value set and the OSPF cost is automatically calculated by using the command [auto-cost reference bandwidth \(IPv6 OSPF\)](#).

**Mode** Interface Configuration for a VLAN interface or Interface Configuration for a PPP interface.

**Usage** This command explicitly sets a user specified cost of sending packets out the interface. Using this command overrides the cost value calculated automatically with the auto-cost reference bandwidth (IPv6 OSPF) feature.

The link-state metric cost is stated in the Router-LSA's link. Typically, the cost is inversely proportional to the bandwidth of an interface. By default, the cost of a VLAN interface is calculated according to the following formula:

$$\text{reference bandwidth} / \text{interface bandwidth}$$

The reference bandwidth is set by default at 1000000 kbps (or 1000 Mbps), but can be changed by the command [auto-cost reference bandwidth \(IPv6 OSPF\)](#).

The interface bandwidth is set by default to 1000000 kbps (or 1000 Mbps), but can be changed by the [bandwidth](#) command.

**Example** To set the IPv6 OSPF cost to 10 on the VLAN interface `vlan25`, use the following commands:

```
awplus# configure terminal
awplus(config)# interface vlan25
awplus(config-if)# ipv6 ospf cost 10
```

To set the IPv6 OSPF cost to 10 on the PPP interface `ppp0`, use the following commands:

```
awplus# configure terminal
awplus(config)# interface ppp0
awplus(config-if)# ipv6 ospf cost 10
```

**Related  
Commands** show ipv6 ospf interface  
auto-cost reference bandwidth (IPv6 OSPF)  
bandwidth

# ipv6 ospf dead-interval

**Overview** This command sets the interval during which no hello packets are received and after which a neighbor is declared dead.

The dead-interval is the amount of time that OSPF waits to receive an OSPF hello packet from the neighbor before declaring the neighbor is down. This value is advertised in the router's hello packets. It must be a multiple of the hello-interval and be the same for all routers on a specific network.

The **no** variant of this command returns the interval to the default of 40 seconds.

**Syntax** `ipv6 ospf dead-interval <1-65535> [<inst-id>]`  
`no ipv6 ospf dead-interval`

| Parameter | Description                             |
|-----------|-----------------------------------------|
| <1-65535> | The interval in seconds.<br>Default: 40 |
| <inst-id> | The instance ID<br>Default: 0           |

**Mode** Interface Configuration for a VLAN interface or Interface Configuration for a PPP interface.

**Example** The following example shows configuring the dead-interval to 10 seconds on the VLAN interface `vlan2`:

```
awplus# configure terminal
awplus(config)# interface vlan2
awplus(config-if)# ipv6 ospf dead-interval 10
```

The following example shows configuring the dead-interval to 10 seconds on the PPP interface `ppp0`:

```
awplus# configure terminal
awplus(config)# interface ppp0
awplus(config-if)# ipv6 ospf dead-interval 10
```

**Related Commands** [ipv6 ospf hello-interval](#)  
[show ipv6 ospf interface](#)

# ipv6 ospf display route single-line

**Overview** Use this command to change the result of the **show ipv6 route** command to display each route entry on a single line.

**Syntax** `ipv6 ospf display route single-line`  
`no ipv6 ospf display route single-line`

**Mode** Global Configuration

**Example** To display each route entry on a single line.

```
awplus# configure terminal
awplus(config)# ipv6 ospf display route single-line
```

**Related Commands** [show ipv6 ospf route](#)

# ipv6 ospf encryption spi esp

**Overview** Use this command in Interface Configuration mode to enable either AES-CBC (Advanced Encryption Standard-Cipher Block Chaining) or 3DES (Triple Data Encryption Standard) ESP (Encapsulating Security Payload) encryption for a specified interface.

Use the **no** variant of this command in Interface Configuration mode to disable the encryption configured for a specified interface.

**Syntax**

```
ipv6 ospf encryption ipsec spi <256-4294967295> esp {aes-cbc
<AES-CBC-key>|3des <3DES-key>|null}{md5 <MD5-key>|sha1
<SHA1-key>}

ipv6 ospf encryption null

no ipv6 ospf encryption ipsec spi <256-4294967295>
```

| Parameter        | Description                                                                                                                          |
|------------------|--------------------------------------------------------------------------------------------------------------------------------------|
| <256-4294967295> | Specify an SPI (Security Parameters Index) value in the range 256 to 4294967295, entered as a decimal integer.                       |
| esp              | Specify the esp keyword (Encapsulating Security Payload) to then apply either AES-CBC or 3DES encryption.                            |
| aes-cbc          | Specify this keyword to enable AES-CBC (Advanced Encryption Standard-Cipher Block Chaining) encryption.                              |
| <AES-CBC-key>    | Enter an AES-CBC key containing either 32, 48, or 64 hexadecimal characters.                                                         |
| 3des             | Specify 3DES (Triple Data Encryption Standard) encryption.                                                                           |
| <3DES-key>       | Enter a 3DES key containing 48 hexadecimal characters.                                                                               |
| null             | Specify ESP without AES-CBC or 3DES encryption applied.                                                                              |
| md5              | Specify the MD5 (Message-Digest 5) encryption algorithm.                                                                             |
| <MD5-key>        | Enter an MD5 key containing 32 hexadecimal characters.                                                                               |
| sha1             | Specify the SHA-1 (Secure Hash Algorithm 1) encryption algorithm.                                                                    |
| <SHA1-key>       | Enter an SHA-1 key containing 40 hexadecimal characters.                                                                             |
| null             | Specify no encryption is applied when no other parameters are applied after this keyword ( <code>ipv6 ospf encryption null</code> ). |

**Default** Authentication is not configured on an interface by default.

**Mode** Interface Configuration

**Usage** When you issue this command, authentication and encryption are both enabled. Configure the same SPI (Security Parameters Index) value on all interfaces that connect to the same link. SPI values are used by link interfaces. Use a different SPI value for a different link interface when using OSPFv3 with link interfaces.

Security is achieved using the IPv6 ESP extension header. The IPv6 ESP extension header is used to provide confidentiality, integrity, authentication, and confidentiality. Authentication fields are removed from OSPF for IPv6 packet headers, so applying IPv6 ESP extension headers are required for integrity, authentication, and confidentiality.

Use the **null** keyword to override existing area encryption. Apply the **null** keyword if area encryption is already configured to then configure encryption on an interface instead.

Use the **sha1** keyword to choose SHA-1 authentication instead of entering the **md5** keyword to use MD5 authentication. The SHA-1 algorithm is more secure than the MD5 algorithm. SHA-1 uses a 40 hexadecimal character key instead of a 32 hexadecimal character key as used for MD5 authentication.

See the [OSPFv3 Feature Overview and Configuration Guide](#) for more information and examples.

**NOTE:** You can configure an encryption security policy (SPI) on a VLAN interface with this command, or an OSPFv3 area with the [area encryption ipsec spi esp](#) command.

When you configure encryption for an area, the security policy is applied to all VLAN interfaces in the area. Allied Telesis recommends a different encryption security policy is applied for each interface for higher security.

If you apply the **ipv6 ospf encryption null** command this affects encryption configured on both the VLAN interface and the OSPFv3 area.

This is due to OSPFv3 hello messages ingressing VLAN interfaces, which are part of area encryption, not being encrypted. So neighbors time out.

**Example** To enable ESP encryption, but not apply an AES-CBC key or a 3DES key, for interface VLAN 2 and MD5 authentication with a 32 hexadecimal character key, use the commands:

```
awplus# configure terminal
awplus(config)# interface vlan2
awplus(config-if)# ipv6 ospf encryption ipsec spi 1000 esp null
md5 1234567890ABCDEF1234567890ABCDEF
```

To enable ESP encryption, but not apply an AES-CBC key or a 3DES key, for interface VLAN 2 and SHA-1 authentication with a 40 hexadecimal character key, use the commands:

```
awplus# configure terminal
awplus(config)# interface vlan2
awplus(config-if)# ipv6 ospf encryption ipsec spi 1000 esp null
sha1 1234567890ABCDEF1234567890ABCDEF12345678
```

To enable ESP encryption with an 3DES key with a 48 hexadecimal character key and MD5 authentication with a 32 hexadecimal character key for interface VLAN 2, use the commands:

```
awplus# configure terminal
awplus(config)# interface vlan2
awplus(config-if)# ipv6 ospf encryption ipsec spi 1000 esp 3des
1234567890ABCDEF1234567890ABCDEF1234567890ABCDEF md5
1234567890ABCDEF1234567890ABCDEF
```

To enable ESP encryption with an AES-CBC key with a 32 hexadecimal character key and SHA-1 authentication with a 40 hexadecimal character key for interface VLAN 2, use the commands:

```
awplus# configure terminal
awplus(config)# interface vlan2
awplus(config-if)# ipv6 ospf encryption ipsec spi 1000 esp
aes-cbc 1234567890ABCDEF1234567890ABCDEF sha1
1234567890ABCDEF1234567890ABCDEF12345678
```

To specify no ESP encryption is applied to interface VLAN 2, use the commands:

```
awplus# configure terminal
awplus(config)# interface vlan2
awplus(config-if)# ipv6 ospf encryption null
```

To disable ESP encryption for interface VLAN 2, use the commands:

```
awplus# configure terminal
awplus(config)# interface vlan2
awplus(config-if)# no ipv6 ospf encryption ipsec spi 1000
```

**Related  
Commands**

- [area authentication ipsec spi](#)
- [area encryption ipsec spi esp](#)
- [ipv6 ospf authentication spi](#)
- [show ipv6 ospf interface](#)

# ipv6 ospf hello-interval

**Overview** This command specifies the interval between hello packets.

The hello-interval is advertised in the hello packets. Configure the same hello-interval for all routers on a specific network. A shorter interval ensures faster detection of topological changes, but results in more routing traffic.

The **no** variant of this command returns the interval to the default of 10 seconds.

**Syntax** `ipv6 ospf hello-interval <1-65535>`  
`no ipv6 ospf hello-interval`

| Parameter | Description                                   |
|-----------|-----------------------------------------------|
| <1-65535> | The hello-interval in seconds.<br>Default: 10 |

**Default** The default interval is 10 seconds.

**Mode** Interface Configuration for a VLAN interface or Interface Configuration for a PPP interface.

**Example** The following example shows setting the `hello-interval` to 3 seconds on the VLAN interface `vlan2`:

```
awplus# configure terminal
awplus(config)# interface vlan2
awplus(config-if)# ipv6 ospf hello-interval 3
```

The following example shows setting the `hello-interval` to 3 seconds on the PPP interface `ppp0`:

```
awplus# configure terminal
awplus(config)# interface ppp0
awplus(config-if)# ipv6 ospf hello-interval 3
```

**Related Commands** [ipv6 ospf dead-interval](#)  
[show ipv6 ospf interface](#)



# ipv6 ospf neighbor

**Overview** Use this command to configure static OSPFv3 IPv6 neighbors when using the OSPFv3 "non-broadcast" (NBMA) and "point-to-multipoint non-broadcast" (P2MP NBMA) network types. OSPFv3 messages exchanged between the neighbors are unicast only.

Use the **no** variant of this command to remove a configuration.

**Syntax** `ipv6 ospf neighbor <ipv6-address>`  
`[<cost>|<instance-id>|<poll-interval>|<priority>]`  
`no ipv6 ospf neighbor <ipv6-address>`  
`[<cost>|<instance-id>|<poll-interval>|<priority>]`

| Parameter                          | Description                                                                                                                                                                                                                         |
|------------------------------------|-------------------------------------------------------------------------------------------------------------------------------------------------------------------------------------------------------------------------------------|
| <code>&lt;ipv6-address&gt;</code>  | Specifies the interface IPv6 address of the neighbor.                                                                                                                                                                               |
| <code>&lt;cost&gt;</code>          | <code>cost &lt;1-65535&gt;</code><br>OSPF cost for point-to-multipoint neighbor.                                                                                                                                                    |
| <code>&lt;instance-id&gt;</code>   | <code>instance-id &lt;0-255&gt;</code><br>Interface instance ID.                                                                                                                                                                    |
| <code>&lt;poll-interval&gt;</code> | <code>poll-interval &lt;0-4294967295&gt;</code><br>Dead neighbor polling interval in seconds. It is recommended to set this value much higher than the hello interval. The default is 120 seconds.                                  |
| <code>&lt;priority&gt;</code>      | <code>priority &lt;0-255&gt;</code><br>Specifies the router priority value of the non-broadcast neighbor associated with the specified IP address. The default is 0. This keyword does not apply to point-to-multipoint interfaces. |

**Mode** Interface Configuration

**Usage** To configure a neighbor on an NBMA network manually, use the **ipv6 ospf neighbor** command and include one neighbor entry for each known non-broadcast network neighbor. The IPv6 address used in this command is the neighbor's primary IPv6 address on the interface where that neighbor connects to the NBMA network.

The poll interval is the reduced rate at which routers continue to send hello packets, when a neighboring router has become inactive. Set the poll interval to be much larger than hello interval.

You can use this command to configure static OSPFv3 IPv6 neighbors for Layer 3 interfaces, such as Ethernet or tunnel interfaces on routers or a VLAN interface on switches or routers.

**Examples** This example shows a neighbor configured with a priority value, poll interval time, and cost.

```
awplus# configure terminal
awplus(config)# interface eth1
awplus(config-if)# ipv6 ospf neighbor fe80::c:20:0:1 priority 1
poll-interval 90
awplus(config-router)# ipv6 ospf neighbor fe80::c:20:0:1 cost
15
```

**Related  
Commands** [show ipv6 ospf neighbor](#)

# ipv6 ospf network

**Overview** This command configures the OSPF network type to a type different from the default for the particular VLAN interface.

The **no** variant of this command returns the network type to the default for the particular VLAN interface.

**Syntax** `ipv6 ospf network [broadcast | non-broadcast | point-to-point | point-to-multipoint]`  
`no ipv6 ospf network`

| Parameter                        | Description                                   |
|----------------------------------|-----------------------------------------------|
| <code>broadcast</code>           | Sets the network type to broadcast.           |
| <code>non-broadcast</code>       | Sets the network type to NBMA.                |
| <code>point-to-multipoint</code> | Sets the network type to point-to-multipoint. |
| <code>point-to-point</code>      | Sets the network type to point-to-point.      |

**Default** The default is the `broadcast` OSPF network type for a VLAN interface.

**Mode** Interface Configuration for a VLAN interface or Interface Configuration for a PPP interface.

**Usage** This command forces the interface network type to the specified type. Depending on the network type, OSPF changes the behavior of the packet transmission and the link description in LSAs.

**Example** The following example shows setting the network type to `point-to-point` on the VLAN interface `vlan1`:

```
awplus# configure terminal
awplus(config)# interface vlan1
awplus(config-if)# ipv6 ospf network point-to-point
```

The following example shows setting the network type to `point-to-point` on the PPP interface `ppp0`:

```
awplus# configure terminal
awplus(config)# interface ppp0
awplus(config-if)# ipv6 ospf network point-to-point
```

# ipv6 ospf priority

**Overview** This command sets the router priority, which is a parameter used in the election of the designated router for the link.

The **no** variant of this command returns the router priority to the default of 1.

**Syntax** `ipv6 ospf priority <priority>`  
`no ipv6 ospf priority`

| Parameter                     | Description                                                                                                                                                                                                                     |
|-------------------------------|---------------------------------------------------------------------------------------------------------------------------------------------------------------------------------------------------------------------------------|
| <code>&lt;priority&gt;</code> | <code>&lt;0-255&gt;</code><br>Specifies the router priority of the interface. The larger the value, the greater the priority level. The value 0 defines that the device cannot become either the DR, or backup DR for the link. |

**Default** The default priority is 1.

**Mode** Interface Configuration for a VLAN interface or Interface Configuration for a PPP interface.

**Usage** Set the priority to help determine the OSPF Designated Router (DR) for a link. If two routers attempt to become the DR, the router with the higher router priority becomes the DR. If the router priority is the same for two routers, the router with the higher router ID takes precedence.

Routers with zero router priority values cannot become the designated or backup designated router.

**Example** The following example shows setting the OSPFv3 priority value to 3 on the VLAN interface `vlan2`:

```
awplus# configure terminal
awplus(config)# interface vlan2
awplus(config-if)# ipv6 ospf priority 3
```

The following example shows setting the OSPFv3 priority value to 3 on the PPP interface `ppp0`:

```
awplus# configure terminal
awplus(config)# interface ppp0
awplus(config-if)# ipv6 ospf priority 3
```

# ipv6 ospf retransmit-interval

**Overview** Use this command to specify the time between link-state advertisement (LSA) retransmissions for adjacencies belonging to the interface.

Use the **no** variant of this command to return to the default of 5 seconds.

**Syntax** `ipv6 ospf retransmit-interval <1-65535>`  
`no ipv6 ospf retransmit-interval`

| Parameter                    | Description                        |
|------------------------------|------------------------------------|
| <code>&lt;1-65535&gt;</code> | Specifies the interval in seconds. |

**Default** The default interval is 5 seconds.

**Mode** Interface Configuration for a VLAN interface or Interface Configuration for a PPP interface.

**Usage** After sending an LSA to a neighbor, the router keeps the LSA until it receives an acknowledgment. In case the router does not receive an acknowledgment during the set time (the retransmit interval value) it retransmits the LSA. Set the retransmission interval value conservatively to avoid needless retransmission. The interval should be greater than the expected round-trip delay between two routers.

**Example** The following example shows setting the `ospf retransmit interval` to 6 seconds on the VLAN interface `vlan2`:

```
awplus# configure terminal
awplus(config)# interface vlan2
awplus(config-if)# ipv6 ospf retransmit-interval 6
```

The following example shows setting the `ospf retransmit interval` to 6 seconds on the PPP interface `ppp0`:

```
awplus# configure terminal
awplus(config)# interface ppp0
awplus(config-if)# ipv6 ospf retransmit-interval 6
```

# ipv6 ospf transmit-delay

**Overview** Use this command to set the estimated time it takes to transmit a link-state-update packet on the VLAN interface.

Use the **no** variant of this command to return to the default of 1 second.

**Syntax** `ipv6 ospf transmit-delay <1-65535>`  
`no ipv6 ospf transmit-delay`

| Parameter                    | Description                                                      |
|------------------------------|------------------------------------------------------------------|
| <code>&lt;1-65535&gt;</code> | Specifies the time, in seconds, to transmit a link-state update. |

**Default** The default interval is 1 second.

**Mode** Interface Configuration for a VLAN interface or Interface Configuration for a PPP interface.

**Usage** The transmit delay value adds a specified time to the age field of an update. If the delay is not added, the time in which the LSA transmits over the link is not considered. This command is especially useful for low speed links. Add transmission and propagation delays when setting the transmit delay value.

**Example** To set the IPv6 OSPF transmit delay time to 3 seconds on the VLAN interface `vlan2`, use the following commands:

```
awplus# configure terminal
awplus(config)# interface vlan2
awplus(config-if)# ipv6 ospf transmit-delay 3
```

To set the IPv6 OSPF transmit delay time to 3 seconds on the PPP interface `ppp0`, use the following commands:

```
awplus# configure terminal
awplus(config)# interface ppp0
awplus(config-if)# ipv6 ospf transmit-delay 3
```

# ipv6 router ospf area

**Overview** Use this command to enable IPv6 OSPF routing on an interface.  
Use the **no** variant of this command to disable IPv6 OSPF routing on an interface.

**Syntax** `ipv6 router ospf area <area-id> [tag <process-id>] [instance <inst-id>]`  
`no ipv6 router ospf area <area-id>`

| Parameter                        | Description                                                                                                                                                                                                                                                                                                                                                                                                              |
|----------------------------------|--------------------------------------------------------------------------------------------------------------------------------------------------------------------------------------------------------------------------------------------------------------------------------------------------------------------------------------------------------------------------------------------------------------------------|
| <code>&lt;area-id&gt;</code>     | The ID of the IPv6 OSPF routing area. Can be entered as either an IPv4 A.B.C.D address format, or as an unsigned integer in the range, 0 to 4294967295. Use either of the following forms when entering an area-ID: <ul style="list-style-type: none"><li><code>area-id &lt;A.B.C.D&gt;</code> where A.B.C.D is a number entered in IPv4 address format.</li><li><code>area-id &lt;0 to 4294967295&gt;</code>.</li></ul> |
| <code>&lt;process-id&gt;</code>  | The process tag denotes a separate router process. It can comprise any string of alphanumeric characters. Note that this tag is local to the router on which it is set and does not appear in any OSPF packets or LSA.                                                                                                                                                                                                   |
| <code>&lt;instance-id&gt;</code> | The OSPF instance ID, entered as an integer between 0 and 255. This is the value that will appear in the instance field of the IPv6 OSPF hello packet.                                                                                                                                                                                                                                                                   |

**Defaults** IPv6 OSPF routing is disabled by default.

When enabling IPv6 OSPF routing:

- the process-tag will default to a null value if not set.
- the Instance ID defaults to 0 if not set.

**Mode** Interface Configuration for a VLAN interface or Interface Configuration for a PPP interface.

**Usage** When enabling IPv6 OSPF routing on an interface, specifying the area-ID is mandatory, but the Process tag and Instance are optional.

See the [OSPFv3 Feature Overview and Configuration Guide](#) for more information and examples.

**Examples** The following commands enable IPv6 OSPF on VLAN interface `vlan2`, OSPF area 1, tag PT2, and instance 2:

```
awplus# configure terminal
awplus(config)# interface vlan2
awplus(config-if)# ipv6 router ospf area 1 tag PT2 instance-id 2
```

The following commands disable IPv6 OSPF on VLAN interface `vlan2` and OSPF area 1:

```
awplus# configure terminal
awplus(config)# interface vlan2
awplus(config-if)# no ipv6 router ospf area 1
```

The following commands enable IPv6 OSPF on PPP interface `ppp0`, OSPF area 1, tag `PT2`, and instance 2:

```
awplus# configure terminal
awplus(config)# interface ppp0
awplus(config-if)# ipv6 router ospf area 1 tag PT2 instance-id 2
```

The following commands disable IPv6 OSPF on PPP interface `ppp0` and OSPF area 1:

```
awplus# configure terminal
awplus(config)# interface ppp0
awplus(config-if)# no ipv6 router ospf area 1
```



# max-concurrent-dd (IPv6 OSPF)

**Overview** Use this command to limit the number of neighbors that can be concurrently processed in the database exchange. The specified value limits the number of neighbors from all interfaces, not per interface.

Use the **no** variant of this command to have no limit on the maximum number of LSAs.

**Syntax** `max-concurrent-dd <max-neighbors>`  
`no max-concurrent-dd`

| Parameter                          | Description                                                   |
|------------------------------------|---------------------------------------------------------------|
| <code>&lt;max-neighbors&gt;</code> | <code>&lt;1-65535&gt;</code> The maximum number of neighbors. |

**Mode** Router Configuration

**Usage** This command is useful where bringing up several adjacencies on a router is affecting performance. In this situation, you can often enhance the system performance by limiting the number of neighbors that can be processed concurrently.

**Example** The following example sets the max-concurrent-dd value to allow only 4 neighbors to be processed at a time.

```
awplus# configure terminal
awplus(config)# router ipv6 ospf
awplus(config-router)# max-concurrent-dd 4
```

**Related Commands** [router ipv6 ospf](#)

# passive-interface (IPv6 OSPF)

**Overview** Use this command to suppress the sending of Hello packets on a specified interface. If you use the **passive-interface** command without the optional parameters then **all** interfaces are put into passive mode.

Use the **no** variant of this command to allow the sending of Hello packets on all interfaces, or on the specified interface. If you use the **no** variant of this command without the optional parameters then **all** interfaces are removed from passive mode.

**Syntax** `passive-interface [<interface>]`  
`no passive-interface [<interface>]`

| Parameter   | Description                                |
|-------------|--------------------------------------------|
| <interface> | The name or the VID of the VLAN interface. |

**Mode** Router Configuration

**Usage** Configure an interface to be passive if you wish its connected route to be treated as an OSPF route (rather than an AS-external route), but do not wish to actually exchange any OSPF packets via this interface.

**Examples** To configure passive interface mode on interface vlan2, enter the following commands:

```
awplus(config)# router ipv6 ospf
awplus(config-router)# passive-interface vlan2
```

To configure passive interface mode on **all** interfaces, enter the following commands:

```
awplus(config)# router ipv6 ospf
awplus(config-router)# passive-interface
```

To remove passive interface mode on interface vlan2, enter the following commands:

```
awplus(config)# router ipv6 ospf
awplus(config-router)# no passive-interface vlan2
```

To remove passive interface mode on **all** interfaces, enter the following commands:

```
awplus(config)# router ipv6 ospf
awplus(config-router)# no passive-interface
```

# redistribute (IPv6 OSPF)

**Overview** Use this command to redistribute routes from other routing protocols, static routes and connected routes into an IPv6 OSPF routing table.

Use the **no** variant of this command to disable this function.

**Syntax** redistribute <protocol> [metric <0-16777214>] [metric-type {1|2}] [route-map <route-map-entry>]  
no redistribute <protocol>

| Parameter   | Description                                                                                                                                                                                                                                                                                                                                                                                                                                                                                        |
|-------------|----------------------------------------------------------------------------------------------------------------------------------------------------------------------------------------------------------------------------------------------------------------------------------------------------------------------------------------------------------------------------------------------------------------------------------------------------------------------------------------------------|
| <protocol>  | The routing protocol to be redistributed, can be one of:                                                                                                                                                                                                                                                                                                                                                                                                                                           |
| connected   | Connected routes                                                                                                                                                                                                                                                                                                                                                                                                                                                                                   |
| rip         | Routing Internet Protocol                                                                                                                                                                                                                                                                                                                                                                                                                                                                          |
| static      | Static Routes                                                                                                                                                                                                                                                                                                                                                                                                                                                                                      |
| metric      | Specifies the external metric.                                                                                                                                                                                                                                                                                                                                                                                                                                                                     |
| metric-type | Specifies the external metric-type, either type 1 or type 2. <ul style="list-style-type: none"><li>• <b>For Metric Type 1:</b> The best route is based on the external redistributed path cost plus the internal path cost presented by the native routing protocol.</li><li>• <b>For Metric Type 2:</b> The best route is based only on the external redistributed path cost. The internal path cost is only used to break a "tie" situation between two identical external path costs.</li></ul> |
| route-map   | The name of the specific route-map.                                                                                                                                                                                                                                                                                                                                                                                                                                                                |

**Default** The default metric value for routes redistributed into OSPFv3 is 20. The metric can also be defined using the [set metric](#) command for a route map. Note that a metric defined using the [set metric](#) command for a route map overrides a metric defined with this command.

**Mode** Router Configuration

**Usage** You use this command to inject routes, learned from other routing protocols, into the OSPF domain to generate AS-external-LSAs. If a route-map is configured by this command, then that route-map is used to control which routes are redistributed and can set metric and tag values on particular routes.

The metric, metric-type, and tag values specified on this command are applied to any redistributed routes that are not explicitly given a different metric, metric-type, or tag value by the route map.

See the [OSPF Feature Overview and Configuration Guide](#) for more information about metrics, and about behavior when configured in route maps.

Note that this command does not redistribute the default route. To redistribute the default route, use the [default-information originate](#) command.

**Example** The following example shows the redistribution of RIP routes into the IPv6 OSPF routing table, with a metric of 10 and a metric type of 1.

```
awplus# configure terminal
awplus(config)# router ipv6 ospf
awplus(config-router)# redistribute rip metric 10 metric-type 1
```

# restart ipv6 ospf graceful

**Overview** Use this command to force the OSPFv3 process to restart. You may optionally specify a grace-period value. If a grace-period is not specified then a default value of 120 seconds is applied.

You should specify a grace-period value of 120 seconds or more. Low grace-period values may cause the graceful restart process on neighboring routers to terminate with routes missing.

**Syntax** `restart ipv6 ospf graceful [grace-period <1-1800>]`

| Parameter    | Description                  |
|--------------|------------------------------|
| grace-period | Specify the grace period.    |
| <1-1800>     | The grace period in seconds. |

**Default** The default OSPF grace-period is 120 seconds.

**Mode** Privileged Exec

**Usage** After this command is executed, the OSPFv3 process immediately shuts down. It notifies the system that OSPF has performed a graceful shutdown. Routes installed by OSPF are preserved until the grace-period expires.

When a **restart ospf graceful** command is issued, the OSPF configuration is reloaded from the last saved configuration. Ensure you first enter the [copy running-config startup-config](#) command.

**Example** To restart OSPFv3, use the following commands:

```
awplus# copy running-config startup-config
awplus# restart ipv6 ospf graceful grace-period 200
```

To apply the default grace-period (120 seconds), use the following commands:

```
awplus# copy running-config startup-config
awplus# restart ipv6 ospf graceful
```

# router ipv6 ospf

**Overview** Use this command to create or remove an IPv6 OSPF routing process, or to enter the Router Configuration mode to configure a specific IPv6 OSPF routing process. Use the **no** variant of this command to terminate an IPv6 OSPF routing process.

Use the **no** parameter with the **process-id** parameter, to terminate and delete a specific IPv6 OSPF routing process.

**Syntax** `router ipv6 ospf [<process-id>]`  
`no router ipv6 ospf [<process-id>]`

| Parameter                       | Description                                                                                                                                                                                                                                                                                       |
|---------------------------------|---------------------------------------------------------------------------------------------------------------------------------------------------------------------------------------------------------------------------------------------------------------------------------------------------|
| <code>&lt;process-id&gt;</code> | A character string that identifies a routing process. If you do not specify the process-id a "null" process ID will be applied. Note that this will appear in show output as *null*. However you cannot select the null process by using the character string *null* as command entry characters. |

**Default** No routing process is defined by default.

**Mode** Global Configuration

**Usage** The process ID enables you to run more than one OSPF session within the same router, then configure each session to a different router port. Note that this function is internal to the router, and other routers (neighbors) have no knowledge of these different processes. The hello and LSAs issued from each process will appear as if coming from a separate physical router.

To a large extent the requirement for multiple processes has been replaced by the ability within IPv6 OSPF of running simultaneous router instances.

The process ID of IPv6 OSPF is an optional parameter for the **no** variant of this command only. When removing all IPv6 OSPF processes on the device, you do not need to specify each Process ID, but when removing particular IPv6 OSPF processes, you must specify each Process ID to be removed.

For a description of processes and instances and their configuration relationships, see the [OSPFv3 Feature Overview and Configuration Guide](#).

**Example** This example shows the use of this command to enter Router Configuration mode.

```
awplus# configure terminal
awplus(config)# router ipv6 ospf P100
awplus(config-router)#
```

# router-id (IPv6 OSPF)

**Overview** Use this command to specify a router ID for the IPv6 OSPF process.  
Use the **no** variant of this command to disable this function.

**Syntax** `router-id <router-id>`  
`no router-id`

| Parameter                      | Description                                     |
|--------------------------------|-------------------------------------------------|
| <code>&lt;router-id&gt;</code> | Specifies the router ID in IPv4 address format. |

**Mode** Router Configuration

**Usage** Configure each router with a unique router-id. In an IPv6 OSPF router process that has active neighbors, a new router-id takes effect at the next reload or when you restart OSPF manually.

**Example** The following example shows a specified router ID 0.0.4.5.

```
awplus# configure terminal
awplus(config)# router ipv6 ospf
awplus(config-router)# router-id 0.0.4.5
```

**Related Commands** [show ipv6 ospf](#)

# show debugging ipv6 ospf

**Overview** Use this command in User Exec or Privileged Exec modes to display which OSPFv3 debugging options are currently enabled.

For information on filtering and saving command output, see the [“Getting Started with AlliedWare Plus” Feature Overview and Configuration Guide](#).

**Syntax** `show debugging ipv6 ospf`

**Mode** User Exec and Privileged Exec

**Example** `awplus# show debugging ipv6 ospf`

**Output** Figure 30-1: Example output from the **show debugging ipv6 ospf** command

```
OSPFv3 debugging status:
OSPFv3 all packet detail debugging is on
OSPFv3 all IFSM debugging is on
OSPFv3 all NFSM debugging is on
OSPFv3 all LSA debugging is on
OSPFv3 all NSM debugging is on
OSPFv3 all route calculation debugging is on
OSPFv3 all event debugging is on
```



# show ipv6 ospf

**Overview** Use this command in User Exec or Privileged Exec modes to display general information about all IPv6 OSPF routing processes, including OSPFv3 Authentication configuration and status information.

Include the process ID parameter with this command to display information about specified processes.

For information on filtering and saving command output, see the [“Getting Started with AlliedWare Plus” Feature Overview and Configuration Guide](#).

**Syntax** `show ipv6 ospf`  
`show ipv6 ospf <process-id>`

| Parameter    | Description                                                                                                                                                                            |
|--------------|----------------------------------------------------------------------------------------------------------------------------------------------------------------------------------------|
| <process-id> | <0-65535><br>The ID of the router process for which information will be displayed. If this parameter is included, only the information for the specified routing process is displayed. |

**Mode** User Exec and Privileged Exec

**Examples** To display general information about all IPv6 OSPF routing processes, use the command:

```
awplus# show ipv6 ospf
```

To display general information about IPv6 OSPF (OSPFv3) routing process P10, use the command:

```
awplus# show ipv6 ospf P10
```

**Output** Figure 30-2: Example output from the **show ipv6 ospf** command for process P10, showing OSPFv3 Authentication configuration information highlighted in bold

```
awplus#show ipv6 ospf
 Routing Process "OSPFv3 (10)" with ID 192.168.1.2
 Route Licence: Route : Limit=Unlimited, Allocated=0, Visible=0,
Internal=0
 Route Licence: Breach: Current=0, Watermark=0
 Process uptime is 6 minutes
 Current grace period is 120 secs (default)
 SPF schedule delay min 0.500 secs, SPF schedule delay max 50.0
secs
 Minimum LSA interval 5 secs, Minimum LSA arrival 1 secs
 Number of incoming current DD exchange neighbors 0/5
 Number of outgoing current DD exchange neighbors 0/5
 Number of external LSA 0. Checksum Sum 0x0000
 Number of AS-Scoped Unknown LSA 0
 Number of LSA originated 4
 Number of LSA received 10
 Number of areas in this router is 1
 Area BACKBONE(0)
 Number of interfaces in this area is 1(1)
 MD5 Authentication SPI 1000
 NULL Encryption SHA-1 Auth, SPI 1001
 SPF algorithm executed 9 times
 Number of LSA 3. Checksum Sum 0xF9CC
 Number of Unknown LSA 0
```

**Related Commands**

- [area authentication ipsec spi](#)
- [area encryption ipsec spi esp](#)
- [router ipv6 ospf](#)

# show ipv6 ospf database

**Overview** Use this command in User Exec or Privileged Exec modes to display a database summary for IPv6 OSPF information. Include the process ID parameter with this command to display information about specified processes.

For information on filtering and saving command output, see the [“Getting Started with AlliedWare Plus” Feature Overview and Configuration Guide](#).

**Syntax** `show ipv6 ospf <process-id> database  
[self-originate|max-age|adv router <adv-router-id>]`

| Parameter                           | Description                                                                                                                                                                                               |
|-------------------------------------|-----------------------------------------------------------------------------------------------------------------------------------------------------------------------------------------------------------|
| <code>&lt;process-id&gt;</code>     | <code>&lt;0-65535&gt;</code><br>The ID of the router process for which information will be displayed.                                                                                                     |
| <code>self-originate</code>         | Displays self-originated link states.                                                                                                                                                                     |
| <code>max-age</code>                | Displays LSAs in MaxAge list. It maintains the list of the all LSAs in the database which have reached the max-age which is 3600 seconds.                                                                 |
| <code>adv-router</code>             | Advertising Router LSA.                                                                                                                                                                                   |
| <code>&lt;adv-router- id&gt;</code> | The Advertising Router ID (usually entered in IPv4 address format A.B.C.D). Note that this ID component no longer represents an address; it is simply a character string that has an IPv4 address format. |

**Mode** User Exec and Privileged Exec

**Example** To display the database summary for IPv6 OSPF information on process P10, use the command:

```
awplus# show ipv6 ospf P10 database
```

**Output** Figure 30-3: Example output from the **show ipv6 ospf P10 database** command

```

OSPFv3 Router with ID (0.0.1.1) (Process P10)

 Link-LSA (Interface vlan2)

Link State ID ADV Router Age Seq# CkSum Prefix
0.0.0.202 0.0.1.1 46 0x800000c3 0x5f50 1
0.0.0.202 0.0.1.2 8 0x800000c3 0x4ca0 1

 Link-LSA (Interface vlan3)

Link State ID ADV Router Age Seq# CkSum Prefix
0.0.0.203 0.0.1.1 1071 0x8000000e 0xe082 1
0.0.0.203 0.0.1.3 1057 0x8000000e 0xb8aa 1

 Router-LSA (Area 0.0.0.0)

Link State ID ADV Router Age Seq# CkSum Link
0.0.0.0 0.0.1.1 1016 0x800000cd 0xa426 2
0.0.0.0 0.0.1.2 979 0x800000d8 0xad2b 1
0.0.0.0 0.0.1.3 1005 0x800000cf 0xefed 1

 Network-LSA (Area 0.0.0.0)

Link State ID ADV Router Age Seq# CkSum
0.0.0.202 0.0.1.2 1764 0x800000c2 0x94c3
0.0.0.203 0.0.1.3 1010 0x800000c4 0x8ac8

 Intra-Area-Prefix-LSA (Area 0.0.0.0)

Link State ID ADV Router Age Seq# CkSum Prefix Reference
0.0.0.2 0.0.1.2 978 0x800000a1 0x699a 1 Router-LSA
0.0.0.4 0.0.1.2 1764 0x800000c2 0xca4d 1 Network-LSA
0.0.0.1 0.0.1.3 1004 0x80000012 0xae2 1 Router-LSA
0.0.0.7 0.0.1.3 1005 0x8000000e 0x3c89 1 Network-LSA

 AS-external-LSA

Link State ID ADV Router Age Seq# CkSum
0.0.0.13 0.0.1.1 1071 0x8000000e 0xca9f E2
0.0.0.14 0.0.1.1 1071 0x8000000e 0xcc9b E2
0.0.0.15 0.0.1.1 1071 0x8000000e 0xce97 E2
0.0.0.16 0.0.1.1 1071 0x8000000e 0xd093 E2
0.0.0.17 0.0.1.1 1071 0x8000000e 0xd28f E2
0.0.0.18 0.0.1.1 1071 0x8000000e 0xd48b E2

```

# show ipv6 ospf database external

**Overview** Use this command in User Exec or Privileged Exec modes to display information about the external LSAs.

For information on filtering and saving command output, see the [“Getting Started with AlliedWare Plus” Feature Overview and Configuration Guide](#).

**Syntax** `show ipv6 ospf database external <adv-router-id>  
[self-originate|adv-router <adv-router-id>]`

| Parameter       | Description                                                                                                                                                                                               |
|-----------------|-----------------------------------------------------------------------------------------------------------------------------------------------------------------------------------------------------------|
| <adv-router-id> | The Advertising Router ID (usually entered in IPv4 address format A.B.C.D). Note that this ID component no longer represents an address; it is simply a character string that has an IPv4 address format. |
| self-originate  | Self-originated link states.                                                                                                                                                                              |
| adv-router      | Displays all the LSAs of the specified router.                                                                                                                                                            |

**Mode** User Exec and Privileged Exec

**Examples** To display information about the external LSAs, use the following command:

```
awplus# show ipv6 ospf database external adv-router 10.10.10.1
```

**Output** Figure 30-4: Example output from the **show ipv6 ospf database external** command

```
LS age: 1087
LS Type: AS-External-LSA
Link State ID: 0.0.0.13
Advertising Router: 0.0.1.1
LS Seq Number: 0x8000000C
Checksum: 0xCE9D
Length: 52
 Metric Type: 2 (Larger than any link state path)
 Metric: 20
 Prefix: 2010:2222::/64
 Prefix Options: 0 (-|-|-|-)
 Forwarding Address: 2003:1111::1
...
```

# show ipv6 ospf database grace

**Overview** Use this command in User Exec or Privileged Exec modes to display information about the grace LSAs.

For information on filtering and saving command output, see the [“Getting Started with AlliedWare Plus” Feature Overview and Configuration Guide](#).

**Syntax** `show ipv6 ospf database grace <adv-router-id>`  
`[self-originate|adv-router <adv-router-id>]`

| Parameter                          | Description                                                                                                                                                                                               |
|------------------------------------|-----------------------------------------------------------------------------------------------------------------------------------------------------------------------------------------------------------|
| <code>&lt;adv-router-id&gt;</code> | The Advertising Router ID (usually entered in IPv4 address format A.B.C.D). Note that this ID component no longer represents an address; it is simply a character string that has an IPv4 address format. |
| <code>adv-router</code>            | Displays all the LSAs of the specified router.                                                                                                                                                            |
| <code>self-originate</code>        | Self-originated link states.                                                                                                                                                                              |

**Mode** User Exec and Privileged Exec

**Examples** To display information about the grace LSAs, use the following command:

```
awplus# show ipv6 ospf database grace adv-router 10.10.10.1
```

**Output** Figure 30-5: Example output from the **show ipv6 ospf database grace** command

```
LS age: 1087
LS Type: AS-External-LSA
Link State ID: 0.0.0.13
Advertising Router: 0.0.1.1
LS Seq Number: 0x8000000C
Checksum: 0xCE9D
Length: 52
 Metric Type: 2 (Larger than any link state path)
 Metric: 20
 Prefix: 2010:2222::/64
 Prefix Options: 0 (-|-|-|-)
 Forwarding Address: 2003:1111::1
```

# show ipv6 ospf database inter-prefix

**Overview** Use this command in User Exec or Privileged Exec modes to display information about the inter-prefix LSAs.

For information on filtering and saving command output, see the [“Getting Started with AlliedWare Plus” Feature Overview and Configuration Guide](#).

**Syntax** `show ipv6 ospf database inter-prefix <adv-router-id>`  
`[self-originate|adv-router <adv-router-id>]`

| Parameter                          | Description                                                                                                                                                                                               |
|------------------------------------|-----------------------------------------------------------------------------------------------------------------------------------------------------------------------------------------------------------|
| <code>&lt;adv-router-id&gt;</code> | The Advertising Router ID (usually entered in IPv4 address format A.B.C.D). Note that this ID component no longer represents an address; it is simply a character string that has an IPv4 address format. |
| <code>adv-router</code>            | Displays all the LSAs of the specified router.                                                                                                                                                            |
| <code>self-originate</code>        | Self-originated link states.                                                                                                                                                                              |

**Mode** User Exec and Privileged Exec

**Examples** To display information about the inter-prefix LSAs, use the following command:

```
awplus# show ipv6 ospf database external adv-router 10.10.10.1
```

**Output** Figure 30-6: Example output from the **show ipv6 ospf database inter-prefix** command

```
LS age: 1087
LS Type: AS-External-LSA
Link State ID: 0.0.0.13
Advertising Router: 0.0.1.1
LS Seq Number: 0x8000000C
Checksum: 0xCE9D
Length: 52
 Metric Type: 2 (Larger than any link state path)
 Metric: 20
 Prefix: 2010:2222::/64
 Prefix Options: 0 (-|-|-)
 Forwarding Address: 2003:1111::1
...
```

# show ipv6 ospf database inter-router

**Overview** Use this command in User Exec or Privileged Exec modes to display information about the inter-router LSAs.

For information on filtering and saving command output, see the [“Getting Started with AlliedWare Plus” Feature Overview and Configuration Guide](#).

**Syntax** `show ipv6 ospf database inter-router <adv-router-id>`  
`[self-originate] adv-router <adv-router-id>]`

| Parameter                          | Description                                                                                                                                                                                               |
|------------------------------------|-----------------------------------------------------------------------------------------------------------------------------------------------------------------------------------------------------------|
| <code>&lt;adv-router-id&gt;</code> | The Advertising Router ID (usually entered in IPv4 address format A.B.C.D). Note that this ID component no longer represents an address; it is simply a character string that has an IPv4 address format. |
| <code>adv-router</code>            | Displays all the LSAs of the specified router.                                                                                                                                                            |
| <code>self-originate</code>        | Self-originated link states.                                                                                                                                                                              |

**Mode** User Exec and Privileged Exec

**Examples** To display information about the inter-router LSAs, use the following command:

```
awplus# show ipv6 ospf database inter-router adv-router
10.10.10.1
```

**Output** Figure 30-7: Example output from the **show ipv6 ospf database inter-router** command

```
LS age: 1087
LS Type: AS-External-LSA
Link State ID: 0.0.0.13
Advertising Router: 0.0.1.1
LS Seq Number: 0x8000000C
Checksum: 0xCE9D
Length: 52
Metric Type: 2 (Larger than any link state path)
Metric: 20
Prefix: 2010:2222::/64
Prefix Options: 0 (-|-|-|-)
Forwarding Address: 2003:1111::1
...
```



# show ipv6 ospf database intra-prefix

**Overview** Use this command in User Exec or Privileged Exec modes to display information about the intra-prefix LSAs.

For information on filtering and saving command output, see the [“Getting Started with AlliedWare Plus” Feature Overview and Configuration Guide](#).

**Syntax** `show ipv6 ospf database intra-prefix <adv-router-id>  
[self-originate|adv-router <adv-router-id>]`

| Parameter       | Description                                                                                                                                                                                               |
|-----------------|-----------------------------------------------------------------------------------------------------------------------------------------------------------------------------------------------------------|
| <adv-router-id> | The Advertising Router ID (usually entered in IPv4 address format A.B.C.D). Note that this ID component no longer represents an address; it is simply a character string that has an IPv4 address format. |
| adv-router      | Displays all the LSAs of the specified router.                                                                                                                                                            |
| self-originate  | Self-originated link states.                                                                                                                                                                              |

**Mode** User Exec and Privileged Exec

**Examples** To display information about the intra-prefix LSAs, use the following command:

```
awplus# show ipv6 ospf database intra-prefix adv-router
10.10.10.1
```

**Output** Figure 30-8: Example output from the **show ipv6 ospf database intra-prefix** command

```
LS age: 1087
LS Type: AS-External-LSA
Link State ID: 0.0.0.13
Advertising Router: 0.0.1.1
LS Seq Number: 0x8000000C
Checksum: 0xCE9D
Length: 52
Metric Type: 2 (Larger than any link state path)
Metric: 20
Prefix: 2010:2222::/64
Prefix Options: 0 (-|-|-|-)
Forwarding Address: 2003:1111::1
...
```

# show ipv6 ospf database link

**Overview** Use this command in User Exec or Privileged Exec modes to display information about the link LSAs.

For information on filtering and saving command output, see the [“Getting Started with AlliedWare Plus” Feature Overview and Configuration Guide](#).

**Syntax** `show ipv6 ospf database link <adv-router-id>`  
`[self-originate|adv-router <adv-router-id>]`

| Parameter       | Description                                                                                                                                                                                               |
|-----------------|-----------------------------------------------------------------------------------------------------------------------------------------------------------------------------------------------------------|
| <adv-router-id> | The Advertising Router ID (usually entered in IPv4 address format A.B.C.D). Note that this ID component no longer represents an address; it is simply a character string that has an IPv4 address format. |
| adv-router      | Displays all the LSAs of the specified router.                                                                                                                                                            |
| self-originate  | Self-originated link states.                                                                                                                                                                              |

**Mode** User Exec and Privileged Exec

**Examples** To display information about the link LSAs, use the following command:

```
awplus# show ipv6 ospf database link adv-router 10.10.10.1
```

**Output** Figure 30-9: Example output from the **show ipv6 ospf database link** command

```
LS age: 1087
LS Type: AS-External-LSA
Link State ID: 0.0.0.13
Advertising Router: 0.0.1.1
LS Seq Number: 0x8000000C
Checksum: 0xCE9D
Length: 52
Metric Type: 2 (Larger than any link state path)
Metric: 20
Prefix: 2010:2222::/64
Prefix Options: 0 (-|-|-|-)
Forwarding Address: 2003:1111::1
...
```

# show ipv6 ospf database network

**Overview** Use this command in User Exec or Privileged Exec modes to display information about the network LSAs.

For information on filtering and saving command output, see the [“Getting Started with AlliedWare Plus” Feature Overview and Configuration Guide](#).

**Syntax** `show ipv6 ospf database network <adv-router-id>`  
`[self-originate|adv-router <adv-router-id>]`

| Parameter                          | Description                                                                                                                    |
|------------------------------------|--------------------------------------------------------------------------------------------------------------------------------|
| <code>&lt;adv-router-id&gt;</code> | The router ID of the advertising router, in IPv4 address format. Note, however, that this no longer represents a real address. |
| <code>self-originate</code>        | Self-originated link states.                                                                                                   |
| <code>adv-router</code>            | The advertising router selected.                                                                                               |

**Mode** User Exec and Privileged Exec

**Examples** To display information about the OSPFv3 network LSAs, use the following command:

```
awplus# show ipv6 ospf database network
```

**Output** Figure 30-10: Example output from the **show ipv6 ospf database network** command

```
OSPFv3 Router with ID (0.0.1.1) (Process P10)

 Network-LSA (Area 0.0.0.0)

LS age: 97
LS Type: Network-LSA
Link State ID: 0.0.0.202
Advertising Router: 0.0.1.2
LS Seq Number: 0x800000C3
Checksum: 0x92C4
Length: 32
Options: 0x000013 (-|R|-|-|E|V6)
 Attached Router: 0.0.1.2
 Attached Router: 0.0.1.1
```

```
LS age: 1144
LS Type: Network-LSA
Link State ID: 0.0.0.203
Advertising Router: 0.0.1.3
LS Seq Number: 0x800000C4
Checksum: 0x8AC8
Length: 32
Options: 0x000013 (-|R|-|-|E|V6)
 Attached Router: 0.0.1.3
 Attached Router: 0.0.1.1
```

# show ipv6 ospf database router

**Overview** Use this command in User Exec or Privileged Exec modes to display information only about the router LSAs.

For information on filtering and saving command output, see the [“Getting Started with AlliedWare Plus” Feature Overview and Configuration Guide](#).

**Syntax** `show ipv6 ospf database router <adv-router-id>`  
`[self-originate|adv-router <adv-router-id>]`

| Parameter                          | Description                                                                                                                    |
|------------------------------------|--------------------------------------------------------------------------------------------------------------------------------|
| <code>&lt;adv-router-id&gt;</code> | The router ID of the advertising router, in IPv4 address format. Note, however, that this no longer represents a real address. |
| <code>self-originate</code>        | Self-originated link states.                                                                                                   |
| <code>adv-router</code>            | The advertising router selected.                                                                                               |

**Mode** User Exec and Privileged Exec

**Examples** To display information about the OSPFv3 router LSAs, use the following command:

```
awplus# show ipv6 ospf database router
```

**Output** Figure 30-11: Example output from the **show ipv6 ospf database router** command

```
OSPFv3 Router with ID (0.0.1.3) (Process P10)

 Router-LSA (Area 0.0.0.0)

LS age: 556
LS Type: Router-LSA
Link State ID: 0.0.0.0
Advertising Router: 0.0.1.1
LS Seq Number: 0x800000CA
Checksum: 0xAA23
Length: 56
Flags: 0x02 (-|-|E|-)
Options: 0x000013 (-|R|-|-|E|V6)
```

```
Link connected to: a Transit Network
 Metric: 1
 Interface ID: 203
 Neighbor Interface ID: 203
 Neighbor Router ID: 0.0.1.3

Link connected to: a Transit Network
 Metric: 1
 Interface ID: 202
 Neighbor Interface ID: 202
 Neighbor Router ID: 0.0.1.2

LS age: 520
LS Type: Router-LSA
Link State ID: 0.0.0.0
Advertising Router: 0.0.1.2
LS Seq Number: 0x800000D5
Checksum: 0xB328
Length: 40
Flags: 0x00 (-|-|-|-)
Options: 0x000013 (-|R|-|-|E|V6)

Link connected to: a Transit Network
 Metric: 1
 Interface ID: 202
 Neighbor Interface ID: 202
 Neighbor Router ID: 0.0.1.2

LS age: 543
LS Type: Router-LSA
Link State ID: 0.0.0.0
Advertising Router: 0.0.1.3
LS Seq Number: 0x800000CC
Checksum: 0xF5EA
Length: 40
Flags: 0x00 (-|-|-|-)
Options: 0x000013 (-|R|-|-|E|V6)

Link connected to: a Transit Network
 Metric: 1
 Interface ID: 203
 Neighbor Interface ID: 203
 Neighbor Router ID: 0.0.1.3
 OSPFv3 Router with ID (0.0.1.3) (Process P10)

AS-external-LSA
```

```
LS age: 1384
LS Type: AS-External-LSA
Link State ID: 0.0.0.13
Advertising Router: 0.0.1.1
LS Seq Number: 0x80000009
Checksum: 0xD49A
Length: 52
 Metric Type: 2 (Larger than any link state path)
 Metric: 20
 Prefix: 2010:2222::/64
 Prefix Options: 0 (-|-|-|-)
 Forwarding Address: 2003:1111::1

LS age: 1384
LS Type: AS-External-LSA
Link State ID: 0.0.0.14
Advertising Router: 0.0.1.1
LS Seq Number: 0x80000009
Checksum: 0xD696
Length: 52
 Metric Type: 2 (Larger than any link state path)
 Metric: 20
 Prefix: 2011:2222::/64
 Prefix Options: 0 (-|-|-|-)
 Forwarding Address: 2003:1111::1

LS age: 1384
LS Type: AS-External-LSA
Link State ID: 0.0.0.15
Advertising Router: 0.0.1.1
LS Seq Number: 0x80000009
Checksum: 0xD892
Length: 52
 Metric Type: 2 (Larger than any link state path)
 Metric: 20
 Prefix: 2012:2222::/64
 Prefix Options: 0 (-|-|-|-)
 Forwarding Address: 2003:1111::1

LS age: 1087
LS Type: AS-External-LSA
Link State ID: 0.0.0.13
Advertising Router: 0.0.1.1
LS Seq Number: 0x8000000C
Checksum: 0xCE9D
Length: 52
 Metric Type: 2 (Larger than any link state path)
 Metric: 20
 Prefix: 2010:2222::/64
 Prefix Options: 0 (-|-|-|-)
 Forwarding Address: 2003:1111::1
```

```
LS age: 1087
LS Type: AS-External-LSA
Link State ID: 0.0.0.14
Advertising Router: 0.0.1.1
LS Seq Number: 0x8000000C
Checksum: 0xD099
Length: 52
 Metric Type: 2 (Larger than any link state path)
 Metric: 20
 Prefix: 2011:2222::/64
 Prefix Options: 0 (-|-|-|-)
 Forwarding Address: 2003:1111::1

LS age: 1087
LS Type: AS-External-LSA
Link State ID: 0.0.0.15
Advertising Router: 0.0.1.1
LS Seq Number: 0x8000000C
Checksum: 0xD295
Length: 52
 Metric Type: 2 (Larger than any link state path)
 Metric: 20
 Prefix: 2012:2222::/64
 Prefix Options: 0 (-|-|-|-)
 Forwarding Address: 2003:1111::1

LS age: 1087
LS Type: AS-External-LSA
Link State ID: 0.0.0.16
Advertising Router: 0.0.1.1
LS Seq Number: 0x8000000C
Checksum: 0xD491
Length: 52
 Metric Type: 2 (Larger than any link state path)
 Metric: 20
 Prefix: 2013:2222::/64
 Prefix Options: 0 (-|-|-|-)
 Forwarding Address: 2003:1111::1

LS age: 1087
LS Type: AS-External-LSA
Link State ID: 0.0.0.17
Advertising Router: 0.0.1.1
LS Seq Number: 0x8000000C
Checksum: 0xD68D
Length: 52
 Metric Type: 2 (Larger than any link state path)
 Metric: 20
 Prefix: 2014:2222::/64
 Prefix Options: 0 (-|-|-|-)
 Forwarding Address: 2003:1111::1
```



```
LS age: 1087
LS Type: AS-External-LSA
Link State ID: 0.0.0.18
Advertising Router: 0.0.1.1
LS Seq Number: 0x8000000C
Checksum: 0xD889
Length: 52
 Metric Type: 2 (Larger than any link state path)
 Metric: 20
 Prefix: 2015:2222::/64
 Prefix Options: 0 (-|-|-|-)
 Forwarding Address: 2003:1111::1
```

# show ipv6 ospf interface

**Overview** Use this command in User Exec or Privileged Exec modes to display interface information for OSPF for all interfaces or a specified interface, including OSPFv3 Authentication status for all interfaces or for a specified interface.

For information on filtering and saving command output, see the [“Getting Started with AlliedWare Plus” Feature Overview and Configuration Guide](#).

**Syntax** `show ipv6 ospf interface [<interface-name>]`

| Parameter        | Description                                                                                    |
|------------------|------------------------------------------------------------------------------------------------|
| <interface-name> | An alphanumeric string that is the interface name. Omit the optional interface to display OSPF |

**Mode** User Exec and Privileged Exec

**Examples** `awplus# show ipv6 ospf interface vlan2`

**Output** Figure 30-12: Example output from the **show ipv6 ospf interface** command showing OSPFv3 Authentication configuration information highlighted in bold

```
awplus#show ipv6 ospf interface
vlan2 is up, line protocol is up
Interface ID 302
IPv6 Prefixes
 fe80::215:77ff:fead:f87e/64 (Link-Local Address)
Security Policy
 MD5 Authentication SPI 1000
 NULL Encryption SHA-1 Auth, SPI 1001

OSPFv3 Process (10), Area 0.0.0.0, Instance ID 0
Router ID 192.168.1.2, Network Type BROADCAST, Cost: 1
Transmit Delay is 1 sec, State Backup, Priority 1
Interface state Backup
Designated Router (ID) 192.168.1.1
 Interface Address fe80::21d:e5ff:fec9:cfbe
Backup Designated Router (ID) 192.168.1.2
 Interface Address fe80::215:77ff:fead:f87e
Timer interval configured, Hello 10, Dead 40, Wait 40,
Retransmit 5
 Hello due in 00:00:07
Neighbor Count is 1, Adjacent neighbor count is 1
```

Figure 30-13: Example output from the **show ipv6 ospf interface** vlan3 command

```
awplus#show ipv6 ospf interface vlan3
vlan3 is up, line protocol is up
 Interface ID 203
 IPv6 Prefixes
 fe80::200:cdff:fe24:daae/64 (Link-Local Address)
 2003:1111::2/64
 OSPFv3 Process (P1), Area 0.0.0.0, Instance ID 0
 Router ID 0.0.1.1, Network Type BROADCAST, Cost: 1
 Transmit Delay is 1 sec, State DR, Priority 1
 Designated Router (ID) 0.0.1.1
 Interface Address fe80::200:cdff:fe24:daae
 No backup designated router on this link
 Timer interval configured, Hello 10, Dead 40, Wait 40,
 Retransmit 5
 Hello due in 00:00:02
 Neighbor Count is 0, Adjacent neighbor count is 0
```

**Related Commands** [ipv6 ospf authentication spi](#)  
[ipv6 ospf encryption spi esp](#)

# show ipv6 ospf neighbor

**Overview** Use this command in User Exec or Privileged Exec modes to display information on OSPF neighbors. Include the process ID parameter with this command to display information about specified processes.

For information on filtering and saving command output, see the [“Getting Started with AlliedWare Plus” Feature Overview and Configuration Guide](#).

**Syntax** `show ipv6 ospf [<process-id>] neighbor <neighbor-id>`  
`show ipv6 ospf [<process-id>] neighbor detail`  
`show ipv6 ospf [<process-id>] neighbor <interface> [detail]`

| Parameter     | Description                                                                               |
|---------------|-------------------------------------------------------------------------------------------|
| <process-id>  | <character string><br>The ID of the OSPF process for which information will be displayed. |
| <neighbor-id> | The Neighbor ID, entered in IP address (A.B.C.D) format.                                  |
| detail        | Detail of all neighbors.                                                                  |
| <interface>   | IP address of the interface.                                                              |

**Mode** User Exec and Privileged Exec

**Examples** `awplus# show ipv6 ospf neighbor`

**Output** Figure 30-14: Example output from **show ipv6 ospf neighbor**

```
awplus#show ipv6 ospf P1 neighbor 2.2.2.2
OSPFv3 Process (P1)
Neighbor ID Pri State Dead Time Interface Instance ID
2.2.2.2 5 2-Way/DROther 00:00:33 vlan3 0
```

Figure 30-15: Example output from **show ipv6 ospf neighbor detail**

```
awplus#show ipv6 ospf neighbor detail
Neighbor 0.0.1.2, interface address fe80::215:77ff:fec9:7472
 In the area 0.0.0.0 via interface vlan2
 Neighbor priority is 1, State is Full, 6 state changes
 DR is 0.0.1.2 BDR is 0.0.1.1
 Options is 0x000013 (-|R|-|-|E|V6)
 Dead timer due in 00:00:33
 Database Summary List 0
 Link State Request List 0
 Link State Retransmission List 0
```

# show ipv6 ospf route

**Overview** Use this command in User Exec or Privileged Exec modes to display the OSPF routing table. Include the process ID parameter with this command to display the OSPF routing table for specified processes.

For information on filtering and saving command output, see the [“Getting Started with AlliedWare Plus” Feature Overview and Configuration Guide](#).

**Syntax** `show ipv6 ospf [<process-id>] route`

| Parameter                       | Description                                                                                                                                                |
|---------------------------------|------------------------------------------------------------------------------------------------------------------------------------------------------------|
| <code>&lt;process-id&gt;</code> | A character string that specifies the router process. If this parameter is included, only the information for this specified routing process is displayed. |

**Mode** User Exec and Privileged Exec

**Examples** To display the OSPF routing table, use the command:

```
awplus# show ipv6 ospf route
```

**Output** Figure 30-16: Example output from the **show ipv6 ospf P10 route** command for a specific process

```
OSPFv3 Process (P1)
Codes: C - connected, D - Discard, O - OSPF, IA - OSPF inter
area
 E1 - OSPF external type 1, E2 - OSPF external type 2

 Destination Metric
 Next-hop
O 2002:1111::/64 2
 via fe80::200:cdff:fe24:daae, vlan3, Area 0.0.0.0
C 2003:1111::/64 1
 directly connected, vlan3, Area 0.0.0.0
O 2004:1111::/64 3
 via fe80::200:cdff:fe24:daae, vlan3, Area 0.0.0.0
C 2005:1111::/64 1
 directly connected, vlan5, Area 0.0.0.0
E2 2010:2222::/64 1/20
 via 2003:1111::1, vlan3
E2 2011:2222::/64 1/20
 via 2003:1111::1, vlan3
E2 2012:2222::/64 1/20
 via 2003:1111::1, vlan3
E2 2013:2222::/64 1/20
 via 2003:1111::1, vlan3
E2 2014:2222::/64 1/20
 via 2003:1111::1, vlan3
E2 2015:2222::/64 1/20
 via 2003:1111::1, vlan3
```

# show ipv6 ospf virtual-links

**Overview** Use this command in User Exec or Privileged Exec modes to display virtual link information, including OSPFv3 Authentication status for virtual links.

For information on filtering and saving command output, see the [“Getting Started with AlliedWare Plus” Feature Overview and Configuration Guide](#).

**Syntax** `show ipv6 ospf virtual-links`

**Mode** User Exec and Privileged Exec

**Usage** See the [OSPFv3 Feature Overview and Configuration Guide](#) for more information and examples.

**Examples** To display virtual link information, use the command:

```
awplus# show ipv6 ospf virtual-links
```

**Output** Figure 30-17: Example output from the **show ipv6 ospf virtual-links** command showing OSPFv3 Authentication configuration information highlighted in bold

```
awplus#show ipv6 ospf virtual-links
Virtual Link VLINK1 to router 192.168.1.10 is down
 Transit area 0.0.0.1 via interface *, instance ID 0
 Local address
 Remote address
MD5 Authentication SPI 1000
NULL encryption SHA-1 auth SPI 1001
 Transmit Delay is 1 sec, State Down,
 Timer intervals configured, Hello 10, Dead 40, Wait 40,
 Retransmit 5
 Hello due in inactive
 Adjacency state Down
```

**Related Commands** [area virtual-link authentication ipsec spi](#)  
[area virtual-link encryption ipsec spi](#)



# summary-address (IPv6 OSPF)

**Overview** Use this command in Router Configuration mode to summarize, or possibly suppress, external redistributed OSPFv3 routes within the specified address range.

Use the **no** variant of this command in Router Configuration mode to stop summarizing, or suppressing, external redistributed OSPFv3 routes within the specified address range.

**Syntax** `summary-address <ipv6-addr/prefix-length> [not-advertise] [tag <0-4294967295>]`

`no summary-address <ipv6-addr/prefix-length> [not-advertise] [tag <0-4294967295>]`

| Parameter                                    | Description                                                                                                                                                                                     |
|----------------------------------------------|-------------------------------------------------------------------------------------------------------------------------------------------------------------------------------------------------|
| <code>&lt;ipv6-addr/prefix-length&gt;</code> | Specifies the base IPv6 address of the IPv6 summary address. The range of addresses given as IPv6 starting address and an IPv6 prefix length.                                                   |
| <code>not-advertise</code>                   | Set the <b>not-advertise</b> option if you do not want OSPFv3 to advertise either the summary address or the individual networks within the range of the summary address.                       |
| <code>tag &lt;0-4294967295&gt;</code>        | The tag parameter specifies the tag value that OSPFv3 places in the AS external LSAs created as a result of redistributing the summary route. The tag overrides tags set by the original route. |

**Default** The default tag value for a summary address is 0.

**Mode** Router Configuration

**Usage** An address range is a pairing of an address and a prefix length. Redistributing routes from other protocols into OSPFv3 requires the router to advertise each route individually in an external LSA. Use this command to advertise one summary route for all redistributed routes covered by a specified prefix to decrease the size of the OSPFv3 link state database.

For example, if the specified address range is 2001:0db8:44::/48, then summary-address functionality will match 2001:0db8:4400:0000::1/128 through 2001:0db8:44ff:ffff::1/128.

Ensure OSPFv3 routes exist in the summary address range for advertisement before using this command.

**Example** The following example uses the `summary-address` command to aggregate external LSAs that match the IPv6 prefix `2001:0db8::/32` and assigns a tag value of 3.

```
awplus# configure terminal
awplus(config)# router ipv6 ospf
awplus(config-router)# summary-address 2001:0db8::/32 tag 3
```

The following example uses the `no summary-address` command to stop summarizing IPv6 addresses in the address range covered within the IPv6 prefix `2001:0db8::/32`.

```
awplus# configure terminal
awplus(config)# router ipv6 ospf
awplus(config-router)# no summary-address 2001:0db8::/32
```

## timers spf (IPv6 OSPF) (deprecated)

**Overview** This command has been deprecated because SPF timers have been replaced by exponential SPF timers. To configure the exponential timers, please use the [timers spf exp \(IPv6 OSPF\)](#) command instead.

# timers spf exp (IPv6 OSPF)

**Overview** Use this command to adjust route calculation timers using exponential back-off delays.

Use **no** form of this command to return to the default exponential back-off timer values.

**Syntax** `timers spf exp <min-holdtime> <max-holdtime>`  
`no timers spf exp <min-holdtime> <max-holdtime>`

| Parameter                         | Description                                                                                                                                                                      |
|-----------------------------------|----------------------------------------------------------------------------------------------------------------------------------------------------------------------------------|
| <code>&lt;min-holdtime&gt;</code> | Specifies the minimum delay between receiving a change to the SPF calculation in milliseconds. The range is 0-2147483647. The default SPF min-holdtime value is 50 milliseconds. |
| <code>&lt;max-holdtime&gt;</code> | Specifies the maximum delay between receiving a change to the SPF calculation in milliseconds. The range is 0-2147483647. The default SPF max-holdtime value is 50 seconds.      |

**Mode** Router Configuration

**Usage** This command configures the minimum and maximum delay time between the receipt of a topology change and the calculation of the Shortest Path First (SPF). The time between SPF runs increases if a topology change occurs (and triggers a new SPF run) before the last SPF holdtimer has finished. The time between runs may increase up to the max-holdtime value. This increase in holdtime prevents too many SPF runs from occurring if multiple OSPF topology change events occur.

**Examples** To set the minimum delay time to 5 milliseconds and maximum delay time to 2 seconds, use the commands:

```
awplus# configure terminal
awplus(config)# router ipv6 ospf 100
awplus(config-router)# timers spf exp 5 2000
```

**Related Commands** [timers spf \(IPv6 OSPF\) \(deprecated\)](#)

# undebbug ipv6 ospf events

**Overview** This command applies the functionality of the no `debug ipv6 ospf events` command.

# undebbug ipv6 ospf ifsm

**Overview** This command applies the functionality of the no `debug ipv6 ospf ifsm` command.

# undebbug ipv6 ospf lsa

**Overview** This command applies the functionality of the no `debug ipv6 ospf lsa` command.

# undebbug ipv6 ospf nfsm

**Overview** This command applies the functionality of the no `debug ipv6 ospf nfsm` command.



# undebbug ipv6 ospf packet

**Overview** This command applies the functionality of the no `debug ipv6 ospf packet` command.

# undebbug ipv6 ospf route

**Overview** This command applies the functionality of the no `debug ipv6 ospf route` command.

# 31

# BGP and BGP4+ Commands

## Introduction

**Overview** This chapter provides an alphabetical reference of commands used to configure the Border Gateway Protocol for IPv4 (BGP) and for IPv6 (BGP4+).

For basic BGP and BGP4+ introduction information and configuration examples, see the [Routing\\_Protocol Guide](#).

- Command List**
- “[address-family](#)” on page 1137
  - “[aggregate-address](#)” on page 1139
  - “[auto-summary \(BGP only\)](#)” on page 1142
  - “[bgp aggregate-nexthop-check](#)” on page 1143
  - “[bgp always-compare-med](#)” on page 1144
  - “[bgp bestpath as-path ignore](#)” on page 1145
  - “[bgp bestpath compare-confed-aspath](#)” on page 1146
  - “[bgp bestpath compare-routerid](#)” on page 1147
  - “[bgp bestpath med](#)” on page 1148
  - “[bgp bestpath med remove-recv-med](#)” on page 1150
  - “[bgp bestpath med remove-send-med](#)” on page 1151
  - “[bgp client-to-client reflection](#)” on page 1152
  - “[bgp cluster-id](#)” on page 1153
  - “[bgp confederation identifier](#)” on page 1155
  - “[bgp confederation peers](#)” on page 1156
  - “[bgp config-type](#)” on page 1158
  - “[bgp dampening](#)” on page 1160
  - “[bgp damp-peer-oscillation \(BGP only\)](#)” on page 1162

- “[bgp default ipv4-unicast](#)” on page 1163
- “[bgp default local-preference \(BGP only\)](#)” on page 1164
- “[bgp deterministic-med](#)” on page 1165
- “[bgp enforce-first-as](#)” on page 1167
- “[bgp fast-external-failover](#)” on page 1168
- “[bgp graceful-restart](#)” on page 1169
- “[bgp graceful-restart graceful-reset](#)” on page 1171
- “[bgp log-neighbor-changes](#)” on page 1172
- “[bgp memory maxallocation](#)” on page 1174
- “[bgp nexthop-trigger-count](#)” on page 1175
- “[bgp nexthop-trigger delay](#)” on page 1176
- “[bgp nexthop-trigger enable](#)” on page 1177
- “[bgp rfc1771-path-select \(BGP only\)](#)” on page 1178
- “[bgp rfc1771-strict \(BGP only\)](#)” on page 1179
- “[bgp router-id](#)” on page 1180
- “[bgp scan-time \(BGP only\)](#)” on page 1181
- “[bgp update-delay](#)” on page 1182
- “[clear bgp \\*](#)” on page 1183
- “[clear bgp \(IPv4 or IPv6 address\)](#)” on page 1184
- “[clear bgp \(ASN\)](#)” on page 1186
- “[clear bgp external](#)” on page 1187
- “[clear bgp peer-group](#)” on page 1188
- “[clear ip bgp \\* \(BGP only\)](#)” on page 1189
- “[clear ip bgp \(IPv4\) \(BGP only\)](#)” on page 1191
- “[clear ip bgp dampening \(BGP only\)](#)” on page 1192
- “[clear ip bgp flap-statistics \(BGP only\)](#)” on page 1193
- “[clear ip bgp \(ASN\) \(BGP only\)](#)” on page 1194
- “[clear ip bgp external \(BGP only\)](#)” on page 1195
- “[clear ip bgp peer-group \(BGP only\)](#)” on page 1196
- “[clear bgp ipv6 \(ipv6 address\) \(BGP4+ only\)](#)” on page 1197
- “[clear bgp ipv6 dampening \(BGP4+ only\)](#)” on page 1198
- “[clear bgp ipv6 flap-statistics \(BGP4+ only\)](#)” on page 1199
- “[clear bgp ipv6 \(ASN\) \(BGP4+ only\)](#)” on page 1200
- “[clear bgp ipv6 external \(BGP4+ only\)](#)” on page 1201
- “[clear bgp ipv6 peer-group \(BGP4+ only\)](#)” on page 1202

- “debug bgp (BGP only)” on page 1203
- “distance (BGP and BGP4+)” on page 1204
- “exit-address-family” on page 1206
- “ip community-list” on page 1207
- “ip community-list expanded” on page 1209
- “ip community-list standard” on page 1211
- “ip extcommunity-list expanded” on page 1213
- “ip extcommunity-list standard” on page 1215
- “ip prefix-list (IPv4 Prefix List)” on page 1217
- “ipv6 prefix-list (IPv6 Prefix List)” on page 1219
- “match as-path” on page 1221
- “match community” on page 1222
- “max-paths” on page 1224
- “neighbor activate” on page 1225
- “neighbor advertisement-interval” on page 1228
- “neighbor allowas-in” on page 1231
- “neighbor as-origination-interval” on page 1234
- “neighbor attribute-unchanged” on page 1236
- “neighbor capability graceful-restart” on page 1239
- “neighbor capability orf prefix-list” on page 1242
- “neighbor capability route-refresh” on page 1245
- “neighbor collide-established” on page 1248
- “neighbor default-originate” on page 1250
- “neighbor description” on page 1253
- “neighbor disallow-infinite-holdtime” on page 1256
- “neighbor dont-capability-negotiate” on page 1258
- “neighbor ebgp-multihop” on page 1261
- “neighbor enforce-multihop” on page 1264
- “neighbor filter-list” on page 1267
- “neighbor interface” on page 1270
- “neighbor local-as” on page 1271
- “neighbor maximum-prefix” on page 1273
- “neighbor next-hop-self” on page 1276
- “neighbor override-capability” on page 1279
- “neighbor passive” on page 1281

- “neighbor password” on page 1283
- “neighbor peer-group (add a neighbor)” on page 1287
- “neighbor peer-group (create a peer-group)” on page 1289
- “neighbor port” on page 1290
- “neighbor prefix-list” on page 1292
- “neighbor remote-as” on page 1295
- “neighbor remove-private-AS (BGP only)” on page 1298
- “neighbor restart-time” on page 1300
- “neighbor route-map” on page 1302
- “neighbor route-reflector-client (BGP only)” on page 1306
- “neighbor route-server-client (BGP only)” on page 1308
- “neighbor send-community” on page 1309
- “neighbor shutdown” on page 1312
- “neighbor soft-reconfiguration inbound” on page 1314
- “neighbor timers” on page 1317
- “neighbor transparent-as” on page 1320
- “neighbor transparent-nexthop” on page 1322
- “neighbor unsuppress-map” on page 1324
- “neighbor update-source” on page 1327
- “neighbor version (BGP only)” on page 1330
- “neighbor weight” on page 1332
- “network (BGP and BGP4+)” on page 1335
- “network synchronization” on page 1338
- “redistribute (into BGP or BGP4+)” on page 1339
- “restart bgp graceful (BGP only)” on page 1341
- “router bgp” on page 1342
- “route-map” on page 1343
- “set as-path” on page 1346
- “set community” on page 1347
- “show bgp ipv6 (BGP4+ only)” on page 1349
- “show bgp ipv6 community (BGP4+ only)” on page 1350
- “show bgp ipv6 community-list (BGP4+ only)” on page 1352
- “show bgp ipv6 dampening (BGP4+ only)” on page 1353
- “show bgp ipv6 filter-list (BGP4+ only)” on page 1354
- “show bgp ipv6 inconsistent-as (BGP4+ only)” on page 1355

- “show bgp ipv6 longer-prefixes (BGP4+ only)” on page 1356
- “show bgp ipv6 neighbors (BGP4+ only)” on page 1357
- “show bgp ipv6 paths (BGP4+ only)” on page 1360
- “show bgp ipv6 prefix-list (BGP4+ only)” on page 1361
- “show bgp ipv6 quote-regexp (BGP4+ only)” on page 1362
- “show bgp ipv6 regexp (BGP4+ only)” on page 1363
- “show bgp ipv6 route-map (BGP4+ only)” on page 1364
- “show bgp ipv6 summary (BGP4+ only)” on page 1365
- “show bgp memory maxallocation (BGP only)” on page 1366
- “show bgp nexthop-tracking (BGP only)” on page 1367
- “show bgp nexthop-tree-details (BGP only)” on page 1368
- “show debugging bgp (BGP only)” on page 1369
- “show ip bgp (BGP only)” on page 1370
- “show ip bgp attribute-info (BGP only)” on page 1371
- “show ip bgp cidr-only (BGP only)” on page 1372
- “show ip bgp community (BGP only)” on page 1373
- “show ip bgp community-info (BGP only)” on page 1375
- “show ip bgp community-list (BGP only)” on page 1376
- “show ip bgp dampening (BGP only)” on page 1377
- “show ip bgp filter-list (BGP only)” on page 1379
- “show ip bgp inconsistent-as (BGP only)” on page 1380
- “show ip bgp longer-prefixes (BGP only)” on page 1381
- “show ip bgp neighbors (BGP only)” on page 1382
- “show ip bgp neighbors connection-retrytime (BGP only)” on page 1385
- “show ip bgp neighbors hold-time (BGP only)” on page 1386
- “show ip bgp neighbors keepalive (BGP only)” on page 1387
- “show ip bgp neighbors keepalive-interval (BGP only)” on page 1388
- “show ip bgp neighbors notification (BGP only)” on page 1389
- “show ip bgp neighbors open (BGP only)” on page 1390
- “show ip bgp neighbors rcvd-msgs (BGP only)” on page 1391
- “show ip bgp neighbors sent-msgs (BGP only)” on page 1392
- “show ip bgp neighbors update (BGP only)” on page 1393
- “show ip bgp paths (BGP only)” on page 1394
- “show ip bgp prefix-list (BGP only)” on page 1395
- “show ip bgp quote-regexp (BGP only)” on page 1396

- [“show ip bgp regexp \(BGP only\)”](#) on page 1398
- [“show ip bgp route-map \(BGP only\)”](#) on page 1400
- [“show ip bgp scan \(BGP only\)”](#) on page 1401
- [“show ip bgp summary \(BGP only\)”](#) on page 1402
- [“show ip community-list”](#) on page 1404
- [“show ip extcommunity-list”](#) on page 1405
- [“show ip prefix-list \(IPv4 Prefix List\)”](#) on page 1406
- [“show ip protocols bgp \(BGP only\)”](#) on page 1407
- [“show ipv6 prefix-list \(IPv6 Prefix List\)”](#) on page 1408
- [“show route-map”](#) on page 1409
- [“synchronization”](#) on page 1410
- [“timers \(BGP\)”](#) on page 1411
- [“undebg bgp \(BGP only\)”](#) on page 1412



# address-family

**Overview** This command enters the IPv4 or IPv6 Address-Family Configuration command mode. In this mode you can configure address-family specific parameters.

When using VRF-lite, you can enter IPv4 Address Family Configuration mode for a specified VRF instance before configuring that instance.

**Syntax [BGP]** address-family ipv4 [unicast]  
no address-family ipv4 [unicast]

**Syntax (VRF-lite)** address-family ipv4 [unicast|vrf <vrf-name>]  
no address-family ipv4 [unicast|vrf <vrf-name>]

**Syntax [BGP4+]** address-family ipv6 [unicast]  
no address-family ipv6 [unicast]

| Parameter  | Description                                                                      |
|------------|----------------------------------------------------------------------------------|
| ipv4       | Configure parameters relating to the exchange of IPv4 prefixes.                  |
| ipv6       | Configure parameters relating to the exchange of IPv6 prefixes.                  |
| unicast    | Configure parameters relating to the exchange of routes to unicast destinations. |
| vrf        | Applies the command to the specified VRF instance.                               |
| <vrf-name> | The name of the VRF instance to enter IPv4 Address-Family mode for.              |

**Mode [BGP]** Router Configuration

**Mode [BGP4+]** Router Configuration

**Usage** To leave the IPv4 or IPv6 Address Family Configuration mode, and return to the Router Configuration mode, use the [exit-address-family](#) command.

**Example [BGP]**

```
awplus# configure terminal
awplus(config)# router bgp 100
awplus(config-router)# neighbor 192.168.0.1 remote-as 100
awplus(config-router)# address-family ipv4 vrf green
awplus(config-router-af)# neighbor 192.168.0.1 activate
awplus(config-router-af)# exit-address-family
awplus(config-router)#
```

**Example [BGP4+]** awplus# configure terminal  
awplus(config)# router bgp 100  
awplus(config-router)# neighbor 2001:0db8:010d::1 remote-as 100  
awplus(config-router)# address-family ipv6  
awplus(config-router-af)# neighbor 2001:0db8:010d::1 activate  
awplus(config-router-af)# exit-address-family  
awplus(config-router)#

**Related  
Commands** [exit-address-family](#)

**Command  
changes** Version 5.4.6-2.1: VRF-lite support added.

# aggregate-address

**Overview** This command adds an aggregate route that can be advertised to BGP or BGP4+ neighbors. This command creates an aggregate entry in the BGP or BGP4+ routing table if the device learns, by any means, any routes that are within the range configured by the aggregate address/mask.

When this command is used with the **summary-only** option, the more-specific routes of the aggregate are suppressed to all neighbors. Use the [neighbor unsuppress-map](#) command instead to selectively leak more-specific routes to a particular neighbor.

The **no** variant of this command removes the aggregate configured by the **aggregate-address** command.

**Syntax [BGP]** `aggregate-address <ip-addr/m> {summary-only|as-set}`  
`no aggregate-address <ip-addr/m> {summary-only|as-set}`

**Syntax [BGP4+]** `aggregate-address <ipv6-addr/prefix-length>`  
`{summary-only|as-set}`  
`no aggregate-address <ipv6-addr/prefix-length>`  
`{summary-only|as-set}`

| Parameter                                    | Description                                                                                                                                                                                                                              |
|----------------------------------------------|------------------------------------------------------------------------------------------------------------------------------------------------------------------------------------------------------------------------------------------|
| <code>&lt;ip-addr/m&gt;</code>               | Specifies the aggregate IPv4 address and mask.                                                                                                                                                                                           |
| <code>&lt;ipv6-addr/prefix-length&gt;</code> | Specifies the aggregate IPv6 address. The IPv6 address uses the format X:X::X/X/Prefix-Length. The prefix-length is usually set between 0 and 64.                                                                                        |
| <code>summary-only</code>                    | Filters more specific routes from updates. Only the aggregate address/mask will be advertised, and none of the component addresses that fall within the range of the aggregate address/mask.                                             |
| <code>as-set</code>                          | Generates AS set path information. The AS-path advertised with the aggregate is an unordered list of all the AS-numbers that appear in any of the AS-paths of the component routes, with each AS-number appearing just once in the list. |

**Mode [BGP]** Router Configuration or IPv4 Address Family Configuration

**Mode [BGP4+]** IPv6 Address Family Configuration

**Usage [BGP]** If the `summary-only` parameter is specified, then only the aggregate address/mask will be advertised, and none of the component addresses that fall within the range of the aggregate address/mask. For example, if you configure:

```
awplus# configure terminal
awplus(config)# router bgp 100
awplus(config-router)# aggregate-address 172.0.0.0/8 summary-
only
```

then the device will advertise the prefix 172.0.0.0/8, but no component routes like 172.10.0.0/16

The `as-set` parameter controls the AS-path attribute that is advertised with the aggregate route. If the device has learned multiple routes that are within the range of the aggregate address/mask, and the AS-paths associated with those routes contain different sets of AS-numbers, then it is not possible to create a single AS-path that accurately represents the AS-paths of all those component routes. In this case, the device will, by default, advertise a NULL AS-path with the aggregate.

**Usage [BGP4+]** If the `summary-only` parameter is specified, then only the aggregate address/mask will be advertised, and none of the component addresses that fall within the range of the aggregate address/mask. For example, if you configure:

```
awplus# configure terminal
awplus(config)# router bgp 100
awplus(config-router)#address-family ipv6
awplus(config-router-af)# aggregate-address 2001:0db8::/64
summary-only
```

then the device will advertise the prefix 2001:0db8::/64, but no component routes like 2001:0db8:010d::/128

**Examples [BGP]**

```
awplus# configure terminal
awplus(config)# router bgp 100
awplus(config-router)# aggregate-address 192.0.0.0/8 as-set
summary-only

awplus# configure terminal
awplus(config)# router bgp 100
awplus(config-router)# no aggregate-address 192.0.0.0/8 as-set
summary-only
```

**Examples**  
**[BGP4+]**

```
awplus# configure terminal
awplus(config)# router bgp 100
awplus(config-router)# address family ipv6
awplus(config-router-af)# aggregate-address 2001:0db8::/64
as-set summary-only

awplus# configure terminal
awplus(config)# router bgp 100
awplus(config-router)# address family ipv6
awplus(config-router-af)# no aggregate-address 2001:0db8::/64
as-set summary-only
```

**Related**  
**Commands**

- [aggregate-address](#)
- [match as-path](#)

# auto-summary (BGP only)

**Overview** Use this command to enable sending summarized routes by a BGP speaker to its peers in the Router Configuration mode or in the Address-Family Configuration mode. BGP uses auto-summary to advertise summarized routes.

Use the **no** variant of this command to disable BGP auto-summary.

**Syntax** auto-summary  
no auto-summary

**Default** The auto-summary function is disabled by default.

**Mode** Router Configuration and Address Family IPv4 mode

**Usage** If certain routes have already been advertised, enabling auto-summary results in non- summarized routes being withdrawn and only summarized routes are advertised. Summarized routes are advertised before non-summarized routes are withdrawn from all connected peers.

If certain routes have already been advertised, disabling auto-summary results in summarized routes being withdrawn and only non-summarized routes are advertised. Non-summarized routes are advertised before summarized routes are withdrawn from all connected peers.

**Examples** The following example enables auto-summary in Router Configuration mode:

```
awplus# configure
awplus(config)# router bgp 100
awplus(config-router)# auto-summary
```

The following example disables auto-summary in Router Configuration mode:

```
awplus# configure terminal
awplus(config)# router bgp 100
awplus(config-router)# no auto-summary
```

The following example enables auto-summary in Address Family IPv4 mode:

```
awplus# configure terminal
awplus(config)# router bgp 100
awplus(config-router)# address-family ipv4
awplus(config-router-af)# auto-summary
```

The following example disables auto-summary in Address Family IPv4 mode:

```
awplus# configure terminal
awplus(config)# router bgp 100
awplus(config-router)# address-family ipv4
awplus(config-router-af)# no auto-summary
```

# bgp aggregate-nexthop-check

**Overview** This command affects the operation of the summary-only option on the aggregate-address command.

This command enables a mode whereby the summary-only option will only suppress the component routes if those component routes all have the same next hop. If the routes have different next hops, then they will continue to be advertised to peers even if the summary-only option is configured. By default this is disabled.

The **no** variant of this command disables this function.

**Syntax** `bgp aggregate-nexthop-check`  
`no bgp aggregate-nexthop-check`

**Default** Disabled by default.

**Mode** Global Configuration

**Example** `awplus# configure terminal`  
`awplus(config)# bgp aggregate-nexthop-check`

# bgp always-compare-med

**Overview** This command enables BGP to compare the Multi Exit Discriminator (MED) for paths from neighbors in different autonomous systems.

Multi Exit Discriminator (MED) is used in best path selection by BGP. MED is compared after BGP attributes weight, local preference, AS-path and origin have been compared and are equal.

By default, MED comparison is done only among routes from the same autonomous system (AS). Use the **bgp always-compare-mode** command to allow comparison of MEDs from different ASs.

A path with a lower MED value is preferred. For example, if the bgp table contains the following entries, and the **bgp always-compare-med** command has been issued to enable this feature:

- Route1: as-path 400, med 300
- Route2: as-path 200, med 200
- Route3: as-path 400, med 250

Route1 is compared to Route2. Route2 is best of the two (lower MED). Next, Route2 is compared to Route3 and Route2 is chosen best path again (lower MED). If **always-compare-med** was disabled, MED is not taken into account when Route1 and Route2 are compared, because of different ASs and MED is compared for only Route1 and Route3. In this case, Route3 would be the best path. The selected route is also affected by the **bgp deterministic-med** command. See the [bgp deterministic-med](#) command for details.

If this command is used to compare MEDs for all paths, it should be configured on every BGP router in the AS.

The **no** variant of this command disallows the comparison.

**Syntax** `bgp always-compare-med`  
`no bgp always-compare-med`

**Default** By default this feature is disabled.

**Mode** Router Configuration

**Example**

```
awplus# configure terminal
awplus(config)# router bgp 100
awplus(config-router)# bgp always-compare-med
```

**Related Commands** [bgp bestpath med](#)  
[bgp bestpath as-path ignore](#)  
[bgp bestpath compare-routerid](#)  
[bgp deterministic-med](#)



# bgp bestpath as-path ignore

**Overview** This command prevents the router from considering as-path as a factor in the algorithm for choosing a route.

The **no** variant of this command allows the router to consider as-path in choosing a route.

**Syntax** `bgp bestpath as-path ignore`  
`no bgp bestpath as-path ignore`

**Mode** Router Configuration

**Example** `awplus# configure terminal`  
`awplus(config)# router bgp 100`  
`awplus(config-router)# bgp bestpath as-path ignore`

**Related Commands** [bgp always-compare-med](#)  
[bgp bestpath med](#)  
[bgp bestpath compare-routerid](#)

# bgp bestpath compare-confed-aspath

**Overview** This command specifies that the AS confederation path length must be used, when available, in the BGP best path decision process. It is effective only when [bgp bestpath as-path ignore](#) command has not been specified.

By default, if BGP receives routes with identical eBGP paths from eBGP peers, BGP does not continue to consider any AS confederation path length attributes that may be associated with the routes.

The **no** variant of this command returns the device to the default state, where the device ignores AS confederation path length in the BGP best path selection process.

**Syntax** `bgp bestpath compare-confed-aspath`  
`no bgp bestpath compare-confed-aspath`

**Mode** Router Configuration

**Example**

```
awplus# configure terminal
awplus(config)# router bgp 100
awplus(config-router)# bgp bestpath compare-confed-aspath
```

**Related Commands** [bgp bestpath as-path ignore](#)

# bgp bestpath compare-routerid

**Overview** By default, when comparing similar routes from peers, BGP does not consider the router ID of neighbors advertising the routes - BGP simply selects the first received route. Use this command to include router ID in the selection process; similar routes are compared and the route with the lowest router ID is selected.

The **no** variant of this command disables this feature, and returns the device to the default state, where the device ignores the router ID in the BGP best path selection process.

**Syntax** `bgp bestpath compare-routerid`  
`no bgp bestpath compare-routerid`

**Mode** Router Configuration

**Example** `awplus# configure terminal`  
`awplus(config)# router bgp 100`  
`awplus(config-router)# bgp bestpath compare-routerid`

**Related Commands** [show ip bgp \(BGP only\)](#)  
[show bgp ipv6 neighbors \(BGP4+ only\)](#)

# bgp bestpath med

**Overview** This command controls how the Multi Exit Discriminator (MED) attribute comparison is performed.

Use the **no** variant of this command to prevent BGP from considering the MED attribute when comparing paths.

**Syntax** `bgp bestpath med {[confed] [missing-as-worst]}`

| Parameter                     | Description                                    |
|-------------------------------|------------------------------------------------|
| <code>confed</code>           | Compares MED among confederation paths.        |
| <code>missing-as-worst</code> | Treats missing MED as the least preferred one. |

**Mode** Router Configuration

**Usage** The **confed** parameter enables MED comparison among paths learned from confederation peers. The MED attributes are compared only if there is no external AS (Autonomous System), where an external AS is one that is not within the confederation. If there is an external AS in the path, then the MED comparison is not made.

For example, in the following paths the MED value is not compared with `Path3` since it is not in the confederation. MED is compared for `Path1` and `Path2` only.

- `Path1 = 32000 32004, med=4`
- `Path2 = 32001 32004, med=2`
- `Path3 = 32003 1, med=1`

The effect of the **missing-as-worst** parameter is to treat a missing MED attribute in a path as having a value of infinity, making the path without a MED value the least desirable path. If the **missing-as-worst** parameter is not configured, the missing MED attribute is assigned the value of 0, making the path with the missing MED attribute the best path.

**Examples**

```
awplus# configure terminal
awplus(config)# router bgp 100
awplus(config-router)# bgp bestpath med missing-as-worst
awplus# configure terminal
awplus(config)# router bgp 100
awplus(config-router)# bgp bestpath med confed
awplus# configure terminal
awplus(config)# router bgp 100
awplus(config-router)# bgp bestpath med confed missing-as-worst
```

**Related  
Commands**    `bgp always-compare-med`  
                  `bgp bestpath as-path ignore`  
                  `bgp deterministic-med`

# bgp bestpath med remove-recv-med

**Overview** This command removes the Multi Exit Discriminator (MED) attribute from the update messages received by the BGP speaker from its peers. However, the local BGP speaker will send MED attributes in the update messages to its peers, unless specified not to by the **bgp bestpath med remove-send-med** command.

Use the **no** variant of this command to disable this feature.

**Syntax** `bgp bestpath med remove-recv-med`  
`no bgp bestpath med remove-recv-med`

**Mode** Router Configuration

**Example** To enable the **remove-recv-med** feature on the BGP speaker belonging to the Autonomous System (AS) 100, enter the command:

```
awplus# configure terminal
awplus(config)# router bgp 100
awplus(config-router)# bgp bestpath med remove-recv-med
```

**Related Commands** [bgp bestpath med remove-send-med](#)

# bgp bestpath med remove-send-med

**Overview** This command removes the Multi Exit Discriminator (MED) attribute from the update messages sent by the BGP speaker to its peers. However, the local BGP speaker will consider the MED attribute received from other peers during the decision and route selection process, unless specified not to by the **bgp bestpath med remove-recv-med** command.

Use the **no** variant of this command to disable this feature.

**Syntax** `bgp bestpath med remove-send-med`  
`no bgp bestpath med remove-send-med`

**Mode** Router Configuration

**Example** To enable the **remove-send-med** feature on the BGP speaker belonging to the Autonomous System (AS) 100, enter the command:

```
awplus# configure terminal
awplus(config)# router bgp 100
awplus(config-router)# bgp bestpath med remove-send-med
```

**Related Commands** [bgp bestpath med remove-recv-med](#)

# bgp client-to-client reflection

**Overview** This command restores route reflection from a BGP route reflector to clients, and is used to configure routers as route reflectors. Route reflectors are used when all Interior Border Gateway Protocol (iBGP) speakers are not fully meshed.

If the clients are fully meshed the route reflector is not required, use the **no** variant of this command to disable the client-to-client route reflection.

When a router is configured as a route reflector, client-to-client reflection is enabled by default.

The **no** variant of this command turns off client-to-client reflection.

**Syntax** `bgp client-to-client reflection`  
`no bgp client-to-client reflection`

**Default** This command is enabled by default.

**Mode** Router Configuration

**Example**

```
awplus# configure terminal
awplus(config)# router bgp 100
awplus(config-router)# no bgp client-to-client reflection
```

**Related Commands** [bgp cluster-id](#)  
[neighbor route-reflector-client \(BGP only\)](#)  
[show bgp ipv6 \(BGP4+ only\)](#)  
[show ip bgp \(BGP only\)](#)



# bgp cluster-id

**Overview** This command configures the cluster-id if the BGP cluster has more than one route reflector. A cluster includes one or more route reflectors and their clients. Usually, each cluster is identified by the router-id of its single route reflector. However, to increase redundancy, a cluster may sometimes have more than one route reflector. All router reflectors in such a cluster are then identified by a cluster-id.

The **bgp cluster-id** command is used to configure the 4 byte cluster ID for clusters with more than one route reflector.

The **no** variant of this command removes the cluster ID.

**Syntax** `bgp cluster-id {<ip-address>|<cluster-id>}`  
`no bgp cluster-id`

| Parameter                       | Description                                                                        |
|---------------------------------|------------------------------------------------------------------------------------|
| <code>&lt;cluster-id&gt;</code> | <code>&lt;1-4294967295&gt;</code> Route Reflector cluster-id as a 32 bit quantity. |
| <code>&lt;ip-address&gt;</code> | <code>A.B.C.D</code> Route Reflector Cluster-id in IP address format.              |

**Mode** Router Configuration

**Usage** The following configuration creates `cluster-id 5` including two `route-reflector-clients`.

```
awplus(config)# router bgp 200
awplus(config-router)# neighbor 2.2.2.2 remote-as 200
awplus(config-router)# neighbor 3.3.3.3 remote-as 200
awplus(config-router)# neighbor 3.3.3.3 route-reflector-client
awplus(config-router)# neighbor 5.5.5.5 remote-as 200
awplus(config-router)# neighbor 5.5.5.5 route-reflector-client
awplus(config-router)# neighbor 6.6.6.6 remote-as 200
awplus(config-router)# bgp cluster-id 5
```

**Examples** To add a **bgp cluster-id**, apply the example commands as shown below:

```
awplus# configure terminal
awplus(config)# router bgp 100
awplus(config-router)# bgp cluster-id 10.10.1.1
```

To remove a bgp cluster-id apply the example commands as shown below:

```
awplus# configure terminal
awplus(config)# router bgp 100
awplus(config-router)# no bgp cluster-id 10.10.1.1
```

**Related  
Commands**

bgp client-to-client reflection  
neighbor route-reflector-client (BGP only)  
show bgp ipv6 (BGP4+ only)  
show ip bgp (BGP only)

# bgp confederation identifier

**Overview** This command specifies a BGP confederation identifier.  
The **no** variant of this command removes all BGP confederation identifiers.

**Syntax** `bgp confederation identifier <1-4294967295>`  
`no bgp confederation identifier`

| Parameter                         | Description                                 |
|-----------------------------------|---------------------------------------------|
| <code>&lt;1-4294967295&gt;</code> | Set routing domain confederation AS number. |

**Mode** Router Configuration

**Examples**

```
awplus# configure terminal
awplus(config)# router bgp 100
awplus(config-router)# bgp confederation identifier 1
awplus# configure terminal
awplus(config)# router bgp 100
awplus(config-router)# no bgp confederation identifier
```

**Related Commands** [bgp confederation peers](#)

# bgp confederation peers

**Overview** This command configures the Autonomous Systems (AS) that belong to the same confederation as the current device.

A confederation allows an AS to be divided into several sub-ASs. The overall AS is given a confederation identifier. External routers view only the whole confederation as one AS, whose AS number is the confederation identifier. Each sub-AS is fully meshed within itself and is visible internally to the confederation.

Use the **bgp confederation peer** command to define the list of AS numbers of the sub-ASs in the confederation containing the current device.

The **no** variant of this command removes an autonomous system from the confederation.

**Syntax** `bgp confederation peers <1-4294967295>`  
`no bgp confederation peers <1-4294967295>`

| Parameter                         | Description                                                                           |
|-----------------------------------|---------------------------------------------------------------------------------------|
| <code>&lt;1-4294967295&gt;</code> | AS numbers of eBGP peers that are under same confederation but in a different sub-AS. |

**Mode** Router Configuration

**Usage** In the following configuration of **Router 1** the neighbor 172.210.30.2 and 172.210.20.1 have iBGP connection within AS 100. The neighbor 173.213.30.1 has an BGP connection, but it is within AS 200, which is part of the same confederation. The neighbor 6.6.6.6 has an eBGP connection to external AS 500.

In the configuration of **Router 2**, neighbor 5.5.5.4 has an eBGP connection to confederation 300. Router2 does not know about the ASs 100 and 200, it only knows about confederation 300.

## Router 1

```
awplus(config)# router bgp 100
awplus(config-router)# bgp confederation identifier 300
awplus(config-router)# bgp confederation peers 200
awplus(config-router)# neighbor 172.210.30.2 remote-as 100
awplus(config-router)# neighbor 172.210.20.1 remote-as 100
awplus(config-router)# neighbor 173.213.30.1 remote-as 200
awplus(config-router)# neighbor 6.6.6.6 remote-as 300
```

## Router 2

```
awplus(config)# router bgp 500
awplus(config-router)# neighbor 5.5.5.4 remote-as 300
```

**Example** awplus# configure terminal  
awplus(config)# router bgp 100  
awplus(config-router)# bgp confederation peers 1234

**Related  
Commands** [bgp confederation identifier](#)

# bgp config-type

**Overview** Use this command to set the BGP configuration type to either **standard** or **enhanced** types. When you configure the **enhanced** type, then BGP and BGP4+ communities are allowed to be sent and received by default. The **enhanced** type is configured by default.

Use the **no** variant of this command to restore the default BGP configuration type (**enhanced**).

**Syntax** `bgp config-type {standard|enhanced}`  
`no bgp config-type`

| Parameter | Description                                                                                                                                                                                                                                                                                                                             |
|-----------|-----------------------------------------------------------------------------------------------------------------------------------------------------------------------------------------------------------------------------------------------------------------------------------------------------------------------------------------|
| standard  | Specifies the industry standard style configuration. After setting the configuration to standard, make sure to use the <a href="#">neighbor send-community</a> command to send out BGP community attributes. The <a href="#">synchronization</a> command is enabled in the Global Configuration mode and is shown in the configuration. |
| enhanced  | Specifies the enhanced style configuration. The enhanced configuration type requires no specific configuration for sending out BGP standard community and extended community attributes. The <a href="#">synchronization</a> command is enabled by default in the Global Configuration mode and is not shown in configuration output.   |

**Default** By default, the BGP configuration type is **enhanced**.

**Mode** Global Configuration

**Usage** Note that the **enhanced** type default configuration may cause issues in some networks if unauthorized BGP peers are advertising BGP communities to adjust routing decisions.

Changing modes requires you to **reload** your device for the change to take effect:

```
awplus(config)#bgp config-type standard
awplus(config)#exit
awplus#reload
reboot system? (y/n): y
```

When your device reloads, it will load with the standard BGP settings commonly used by most vendors. Apply the **standard** type configuration if you have interoperability issues.

**Examples** To specify the standard BGP configuration type, enter the following commands:

```
awplus# configure terminal
awplus(config)# bgp config-type standard
```

To specify the enhanced BGP configuration type, enter the following commands:

```
awplus# configure terminal
awplus(config)# bgp config-type enhanced
```

To restore the default BGP configuration type (enhanced), enter the following commands:

```
awplus# configure terminal
awplus(config)# no bgp config-type
```

**Related  
Commands** [neighbor send-community](#)  
[synchronization](#)

# bgp dampening

**Overview** This command enables BGP and BGP4+ dampening and sets BGP and BGP4+ dampening parameters. BGP4+ dampening is available from the IPv6 Address Family Configuration mode. BGP dampening is available from the Router Configuration mode.

The **no** variant of this command disables BGP dampening or unsets the BGP dampening parameters.

**Syntax**

```
bgp dampening
no bgp dampening
bgp dampening <reachtime>
no bgp dampening <reachtime>
bgp dampening <reachtime> <reuse> <suppress> <maxsuppress>
<unreachtime>
no bgp dampening <reachtime> <reuse> <suppress> <maxsuppress>
<unreachtime>
bgp dampening route-map <routemap-name>
no bgp dampening route-map <routemap-name>
```

| Parameter       | Description                                                                                                                                                                     |
|-----------------|---------------------------------------------------------------------------------------------------------------------------------------------------------------------------------|
| <reachtime>     | <1-45><br>Specifies the reachability half-life time in minutes. The time for the penalty to decrease to one-half of its current value. The default is 15 minutes.               |
| <reuse>         | <1-20000> Specifies the reuse limit value. When the penalty for a suppressed route decays below the reuse value, the routes become unsuppressed. The default reuse limit is 750 |
| <suppress>      | <1-20000><br>Specifies the suppress limit value. When the penalty for a route exceeds the suppress value, the route is suppressed. The default suppress limit is 2000.          |
| <maxsuppress>   | <1-255><br>Specifies the max-suppress-time. Maximum time that a dampened route is suppressed. The default max-suppress value is 4 times the half-life time (60 minutes).        |
| <unreachtime>   | <1-45><br>Specifies the un-reachability half-life time for penalty, in minutes.                                                                                                 |
| route-map       | Route-map to specify criteria for dampening.                                                                                                                                    |
| <routemap-name> | Specify the name of the route-map.                                                                                                                                              |

**Mode [BGP]** Router Configuration



**Mode [BGP4+]** IPv6 Address Family Configuration

**Usage** Route dampening minimizes the instability caused by route flapping. A penalty is added for every flap in a flapping route. As soon as the total penalty reaches the **suppress** limit the advertisement of the route is suppressed. This penalty is decayed according to the configured **half time** value. Once the penalty is lower than the **reuse** limit, the route advertisement is un-suppressed.

The dampening information is purged from the router once the penalty becomes less than half of the **reuse** limit.

**Example [BGP]**

```
awplus# configure terminal
awplus(config)# router bgp 11
awplus(config-router)# bgp dampening 20 800 2500 80 25
```

**Example [BGP4+]**

```
awplus# configure terminal
awplus(config)# router bgp 11
awplus(config-router)# address-family ipv6
awplus(config-router-af)# bgp dampening 20 800 2500 80 25
```

# bgp damp-peer-oscillation (BGP only)

**Overview** Use this command to enable BGP peer oscillating connection damping.  
Use the **no** variant of this command to disable BGP peer oscillating connection damping.

**Syntax** `bgp damp-peer-oscillations`  
`no bgp damp-peer-oscillations`

**Default** By default, this functionality is enabled and will not appear in the **show running-config** command output.

**Mode** Router Configuration

**Usage** BGP peers in AlliedWare Plus will automatically attempt to form connections with configured neighbors. Due to misconfiguration these connections may fail and continue to fail until such time as the misconfiguration is detected and fixed. During this time, BGP can quickly cycle through the state machine from Idle through the various Connect states, which can result in large numbers of TCP sessions being opened in a short period of time.

This command instead adds a delay after a peer enters the Idle state before it can progress to the later states. The default delay is 0 second, increasing by 1 second for each unsuccessful connection attempt, to a maximum of 5 seconds. After a successful BGP route update has been received over a connection, the delay will be reset to 0. This command implements the DampPeerOscillations FSM behavior described in section 8.1 of RFC 4271.

The command is enabled by default. When disabled, peers will transition out of the Idle state immediately. The command applies globally to all currently configured BGP peers and all future peers to be created.

**Example** To disable peer connection damping, use the commands:

```
awplus# configure terminal
awplus(config)# router bgp 1
awplus(config-router)# no bgp damp-peer-oscillations
```

# bgp default ipv4-unicast

**Overview** This command configures BGP defaults and activates IPv4-unicast for a peer by default. This affects BGP global configuration. By default, BGP exchanges IPv4 prefixes with a peer.

The **no** variant of this command disables this function. The BGP routing process will no longer exchange IPv4 addressing information with BGP neighbor routers. Note that disabling the exchange of IPv4 prefixes will also enable an IPv6 only BGP4+ network.

**Syntax** `bgp default ipv4-unicast`  
`no bgp default ipv4-unicast`

**Default** This is enabled by default.

**Mode** Router Configuration

**Usage** Use the negated form of this command to enable an IPv6 only BGP4+ network.

**Examples**

```
awplus# configure terminal
awplus(config)# router bgp 100
awplus(config-router)# bgp default ipv4-unicast
awplus# configure terminal
awplus(config)# router bgp 100
awplus(config-router)# no bgp default ipv4-unicast
```

# bgp default local-preference (BGP only)

**Overview** This command changes the default local preference value.

The local preference indicates the preferred path when there are multiple paths to the same destination. The path with the higher preference is preferred.

Use this command to define the default local preference value that the device will advertise for the routes it sends. The preference is sent to all routers and access servers in the local autonomous system.

The **no** variant of this command reverts to the default local preference value of 100.

**Syntax** `bgp default local-preference <pref-value>`  
`no bgp default local-preference [<pref-value>]`

| Parameter                       | Description                                                                                                            |
|---------------------------------|------------------------------------------------------------------------------------------------------------------------|
| <code>&lt;pref-value&gt;</code> | <code>&lt;0-4294967295&gt;</code> Configure default local preference value. The default local preference value is 100. |

**Default** By default the local-preference value is 100.

**Mode** Router Configuration

**Examples**

```
awplus# configure terminal
awplus(config)# router bgp 100
awplus(config-router)# bgp default local-preference 2345555
awplus# configure terminal
awplus(config)# router bgp 100
awplus(config-router)# no bgp default local-preference
```

# bgp deterministic-med

**Overview** Use this command to allow or disallow the device to compare the Multi Exit Discriminator (MED) variable when choosing among routes advertised by different peers in the same autonomous system (AS).

Use the **bgp deterministic-med** command to enable this feature to allow the comparison of MED variables when choosing among routes advertised by different peers in the same AS.

Use the **no** variant of this command to disable this feature to disallow the comparison of the MED variable when choosing among routes advertised by different peers in the same AS.

**Syntax** `bgp deterministic-med`  
`no bgp deterministic-med`

**Default** Disabled

**Mode** Router Configuration

**Usage** When the **bgp deterministic-med** command is enabled, routes from the same AS are grouped together and ordered according to their MED values, and the best routes of each group are compared.

The main benefit of this is that the choice of best route then does not depend on the order in which the routes happened to be received, which is rather random and arbitrary.

To see how this works, consider the following set of bgp table entries, all for the same route:

```
1: ASPATH 234, MED 120, internal, IGP metric to NEXT_HOP 40
2: ASPATH 389, MED 190, internal, IGP metric to NEXT_HOP 35
3: ASPATH 234, MED 245, external
```

If **bgp deterministic-med** is not enabled, then entry 3 will be chosen, because it is an external route.

But if BGP deterministic-MED is enabled, the entries will be grouped as follows:

```
Group 1: 1: ASPATH 234, MED 120, internal, IGP metric to NEXT_HOP 40
 3: ASPATH 234, MED 245, external
Group 2: 2: ASPATH 389, MED 190, internal, IGP metric to NEXT_HOP 35
```

**NOTE:** Routes from the same AS are grouped together and ordered by MED.

Entry 1 is chosen as the best route from Group 1, since this route has the lowest MED value. Entry 2 has to be the best route in Group 2, since this is the only route in that group. These two group winners are compared against each other, and

Entry 2 is chosen as the best route because Entry 2 has the lower metric to next-hop.

All routers in an AS should have the same setting for BGP deterministic-MED. All routers in an AS should have BGP deterministic-MED enabled with **bgp deterministic-med**, or all routers in an AS should have BGP deterministic-MED disabled with **no bgp-deterministic-med**.

In the example above, the MED values were not considered when comparing the winners of the two groups (the best routes from the different ASs). To use MED in the comparison of routes from different ASs, use the [bgp always-compare-med](#) command.

**Examples**

```
awplus# configure terminal
awplus(config)# router bgp 100
awplus(config-router)# bgp deterministic-med
awplus# configure terminal
awplus(config)# router bgp 100
awplus(config-router)# no bgp deterministic-med
```

**Related Commands**

- [show ip bgp \(BGP only\)](#)
- [show bgp ipv6 neighbors \(BGP4+ only\)](#)
- [show ip bgp neighbors \(BGP only\)](#)

## bgp enforce-first-as

**Overview** Use this command to enforce the denying of eBGP updates in which the neighbor's AS number is not the first AS in the AS-path attribute.

Use the **no** variant of this command to disable this feature.

**Syntax** `bgp enforce-first-as`  
`no bgp enforce-first-as`

**Mode** Router Configuration

**Usage** This command specifies that any updates received from an external neighbor that do not have the neighbor's configured Autonomous System (AS) at the beginning of the AS\_PATH in the received update must be denied. Enabling this feature adds to the security of the BGP network by not allowing traffic from unauthorized systems.

**Example** `awplus# configure terminal`  
`awplus(config)# router bgp 100`  
`awplus(config-router)# bgp enforce-first-as`

# bgp fast-external-failover

**Overview** Use this command to reset a BGP session immediately if the interface used for BGP connection goes down.

Use the **no** variant of this command to disable this feature.

**Syntax** `bgp fast-external-failover`  
`no bgp fast-external-failover`

**Default** Enabled

**Mode** Router Configuration

**Example** `awplus# configure terminal`  
`awplus(config)# router bgp 100`  
`awplus(config-router)# bgp fast-external-failover`



# bgp graceful-restart

**Overview** Use this command to enable BGP and BGP4+ graceful-restart capabilities for restart and stalepath times.

Use the **no** variant of this command to restore restart timers to their default settings.

**Syntax** `bgp graceful-restart [restart-time <delay-value>|  
stalepath-time <delay-value>]`  
`no bgp graceful-restart [restart-time|stalepath-time]`

| Parameter                        | Description                                                                                                              |
|----------------------------------|--------------------------------------------------------------------------------------------------------------------------|
| <code>restart-time</code>        | The maximum time needed for neighbors to restart, in seconds.<br>The default restart-time is 120 seconds.                |
| <code>stalepath-time</code>      | The maximum time to retain stale paths from restarting neighbors, in seconds. The default stalepath-time is 120 seconds. |
| <code>&lt;delay-value&gt;</code> | <1-3600> Maximum time in seconds.                                                                                        |

**Default** Graceful restart is disabled by default. If you enable it and do not specify the restart-time and stalepath-time, they default to 120 seconds.

**Mode** Router Configuration

**Usage** The **restart-time** parameter is used for setting the maximum time that a graceful-restart neighbor waits to come back up after a restart. This **restart-time** value is applied to neighbors unless you explicitly override it by configuring the corresponding value on the neighbor.

The **stalepath-time** parameter is used to set the maximum time to preserve stale paths from a gracefully restarted neighbor. All stalepaths, unless reinstated by the neighbor after a re-establishment, will be deleted when time, as specified by the **stalepath-time** parameter, expires.

**Examples** To enable graceful restart, use the commands:

```
awplus# configure terminal
awplus(config)# router bgp 10
awplus(config-router)# bgp graceful-restart
```

To disable graceful restart, use the commands:

```
awplus# configure terminal
awplus(config)# router bgp 10
awplus(config-router)# no bgp graceful-restart
```

To enable graceful restart and set the restart time to 150 seconds, use the commands:

```
awplus# configure terminal
awplus(config)# router bgp 10
awplus(config-router)# bgp graceful-restart restart-time 150
```

To return the restart-time to its default of 120 seconds, use the commands:

```
awplus# configure terminal
awplus(config)# router bgp 10
awplus(config-router)# no bgp graceful-restart restart-time
```

**Related Commands** [bgp graceful-restart graceful-reset restart bgp graceful \(BGP only\)](#)

# bgp graceful-restart graceful-reset

**Overview** This command enables BGP and BGP4+ graceful-restart when a configuration change forces a peer restart.

Use the **no** variant of this command to restore the device to its default state.

**Syntax** `bgp graceful-restart graceful-reset`  
`no bgp graceful-restart graceful-reset`

**Default** Disabled

**Mode** Router Configuration

**Usage** The `bgp graceful-restart` command must be enabled before this command is enabled. All events that cause BGP peer reset, including all session reset commands, can trigger graceful-restart.

**Example** To enable the graceful-restart graceful-reset feature on the BGP or BGP4+ peer belonging to Autonomous System (AS) 10, use the commands:

```
awplus# configure terminal
awplus(config)# router bgp 10
awplus(config-router)# bgp graceful-restart graceful-reset
```

To disable the graceful-restart graceful-reset feature on the BGP or BGP4+ peer belonging to Autonomous System (AS) 10, use the commands:

```
awplus# configure terminal
awplus(config)# router bgp 10
awplus(config-router)# no bgp graceful-restart graceful-reset
```

**Related Commands** [bgp graceful-restart](#)

# bgp log-neighbor-changes

**Overview** Use this command to enable logging of status change messages without turning on **debug bgp** commands.

Use the **no** variant of this command to disable this feature.

**Syntax** `bgp log-neighbor-changes`  
`no bgp log-neighbor-changes`

**Default** Disabled

**Mode** Router Configuration

**Usage** AlliedWare Plus™ provides other kinds of logging services for neighbor status, for example, **debug bgp fsm** and **debug bgp events**.

However, these commands create a significant hit in the logging performance. If you need to log neighbor status changes only, we recommend turning off all the debug commands, and then use this command.

To see BGP neighbor changes in the log you must also set the log level to informational using the **log buffered** command.

A sample output of this log is:

```
%Protocol-Severity-Events: Message-text
```

A sample output of the log for an interface down event is:

```
%BGP-5-ADJCHANGE: neighbor 10.10.0.24 Down Interface flap
```

The **bgp log-neighbor-changes** command logs the following events:

- BGP Notification Received
- Erroneous BGP Update Received
- User reset request
- Peer time-out
- Peer Closing down the session
- Interface flap
- Router ID changed
- Neighbor deleted
- Member added to peer group
- Administrative shutdown

- Remote AS changed
- RR client configuration modification
- Soft reconfiguration modification

**Example** To enable the logging of BGP status changes without using the debug bgp command:

```
awplus# configure terminal
awplus(config)# router bgp 100
awplus(config-router)# bgp log-neighbor-changes
```

# bgp memory maxallocation

**Overview** This command allocates a maximum percentage of the RAM (Random Access Memory) available on the device for BGP processes.

When this percentage is exceeded, BGP peering terminates and an **out of resources** error displays. The default setting for **bgp memory maxallocation** is 100% memory allocation.

Use the **no** variant of this command to reset memory allocation to the default.

**Syntax** `bgp memory maxallocation <1-100>`  
`no bgp memory maxallocation`

| Parameter                  | Description                                                                                                               |
|----------------------------|---------------------------------------------------------------------------------------------------------------------------|
| <code>&lt;1-100&gt;</code> | Percentage of device memory allocated to BGP processes. Note this is RAM (Random Access Memory), not device flash memory. |

**Default** BGP processes are allocated the maximum percentage of 100% of the device's available RAM memory by default. Note only non-default BGP memory allocation values are shown in the running or startup configuration files:

```
awplus#show running-config
!
bgp memory maxallocation 50
!
```

**Mode** Global Configuration

**Examples** To limit the maximum amount of memory used by BGP processes to 65% of the total RAM memory available on the device, use the commands:

```
awplus# configure terminal
awplus(config)# bgp memory maxallocation 65
```

To return to the default 100% maximum RAM memory allocation available on the device for BGP processes, use the commands:

```
awplus# configure terminal
awplus(config)# no bgp memory maxallocation
```

# bgp nexthop-trigger-count

**Overview** Use this command to configure the display of BGP next hop tracking status.  
Use the **no** variant of this command to disable this function.

**Syntax** `bgp nexthop-trigger-count <0-127>`  
`no bgp nexthop-trigger-count`

| Parameter | Description                   |
|-----------|-------------------------------|
| <0-127>   | BGP next hop tracking status. |

**Mode** Router Configuration

**Example** To enable next-hop-tracking status on the BGP peer belonging to the Autonomous System (AS) 100, enter the following commands:

```
awplus# configure terminal
awplus(config)# router bgp 100
awplus(config-router)# bgp nexthop-trigger-count 10
```

To disable next-hop-tracking status, enter the following commands:

```
awplus# configure terminal
awplus(config)# router bgp 100
awplus(config-router)# no bgp nexthop-trigger-count
```

**Related Commands** [bgp nexthop-trigger delay](#)  
[bgp nexthop-trigger enable](#)  
[show bgp nexthop-tracking \(BGP only\)](#)

# bgp nexthop-trigger delay

**Overview** Use this command to set the delay interval for next hop address tracking.  
Use the **no** variant of this command to reset the timer value to the default.

**Syntax** `bgp nexthop-trigger delay <1-100>`  
`no bgp nexthop-trigger delay`

| Parameter | Description                                 |
|-----------|---------------------------------------------|
| <1-100>   | Next hop trigger delay interval in seconds. |

**Default** The default next hop delay interval is 5 seconds.

**Mode** Global Configuration

**Usage** This command configures the delay interval between routing table waits for next hop delay tracking. The delay interval determines how long BGP waits after it receives the trigger from the system about one or more next hop changes before it walks the full BGP table to determine which prefixes are affected by the next hop changes.

**Example** To set the next hop delay interval to 6 seconds, enter the command:

```
awplus# configure terminal
awplus(config)# bgp nexthop-trigger delay 6
```

**Related Commands** [bgp nexthop-trigger-count](#)  
[bgp nexthop-trigger enable](#)



# bgp nexthop-trigger enable

**Overview** Use this command to enable next hop address tracking. If next hop address tracking is enabled and a next hop trigger delay interval has not been explicitly set with the [bgp nexthop-trigger delay](#) command, the default delay interval of 5 seconds is used.

Use the **no** variant of this command to disable this feature.

**Syntax** `bgp nexthop-trigger enable`  
`no bgp nexthop-trigger enable`

**Default** Disabled.

**Mode** Global Configuration

**Usage** Next hop address tracking is an event driven notification system that monitors the status of routes installed in the Routing Information Base (RIB) and reports next hop changes that affect internal BGP (iBGP) or external BGP (eBGP) prefixes directly to the BGP process. This improves the overall BGP convergence time, by allowing BGP to respond rapidly to next hop changes for routes installed in the RIB.

If next hop tracking is enabled after certain routes are learned, the registration of all the next hops of selected BGP routes are done immediately after the next hop tracking feature is enabled.

If next hop tracking is disabled, and if there are still some selected BGP routes, BGP deregisters the next hops of all of the selected BGP routes from the system.

If next hop tracking is disabled when next hop tracking is in the process of execution, an error appears, and next hop tracking is not disabled. However, if the next hop tracking timer is running at the time of negation, the next hop tracking timer is stopped, and next hop tracking is disabled.

**Example** To enable next hop address tracking, enter the command:

```
awplus# configure terminal
awplus(config)# bgp nexthop-trigger enable
```

**Related Commands** [bgp nexthop-trigger-count](#)  
[bgp nexthop-trigger delay](#)  
[show bgp nexthop-tracking \(BGP only\)](#)

## bgp rfc1771-path-select (BGP only)

**Overview** Use this command to set the RFC1771 compatible path selection mechanism.

Use the **no** variant of this command to revert this setting.

**Syntax** `bgp rfc1771-path-select`  
`no bgp rfc1771-path-select`

**Default** Industry standard compatible path selection mechanism.

**Mode** Global Configuration

**Example** `awplus# configure terminal`  
`awplus(config)# bgp rfc1771-path-select`

## bgp rfc1771-strict (BGP only)

**Overview** Use this command to set the Strict RFC1771 setting.  
Use the **no** variant of this command to revert this setting.

**Syntax** `bgp rfc1771-strict`  
`no bgp rfc1771-strict`

**Default** Disabled

**Mode** Global Configuration

**Example** `awplus# configure terminal`  
`awplus(config)# bgp rfc1771-strict`

# bgp router-id

**Overview** Use this command to configure the router identifier. The IPv4 address specified in this command does not have to be an IPv4 address that is configured on any of the interfaces on the device. Note that you must specify an IPv4 address with this when used for BGP4+.

Use the **no** variant of this command to return the router-id to its default value (as described in Default below).

**Syntax** `bgp router-id <routerid>`  
`no bgp router-id [<routerid>]`

| Parameter                     | Description                                                                                             |
|-------------------------------|---------------------------------------------------------------------------------------------------------|
| <code>&lt;routerid&gt;</code> | Specify the IPv4 address without mask for a manually configured router ID, in the format A . B . C . D. |

**Default** If the BGP router ID is not specified, the IPv4 address of the loopback interface is used. When there is no address on the loopback interface, the highest IP address among the VLAN interfaces is used. Note that devices that have an Ethernet management interface will not use that eth interface's IP address as a router ID.

**Mode [BGP]** Router Configuration or IPv4 Address Family Configuration

**Mode [BGP4+]** Router Configuration

**Usage** Use the **bgp router-id** command to manually configure a fixed router ID as a BGP or BGP4+ router identifier. This router ID takes precedence over all other possible router ID sources. The order of precedence is:

- 1) router ID configured with this command
- 2) IP address of the loopback interface
- 3) highest IP address from the VLAN interfaces

**Examples** To configure a router ID with an IPv4 address for a BGP or BGP4+ router identifier, enter the commands listed below:

```
awplus# configure terminal
awplus(config)# router bgp 100
awplus(config-router)# bgp router-id 1.1.2.3
```

To disable the router ID for a BGP or BGP4+ router identifier enter the commands listed below:

```
awplus# configure terminal
awplus(config)# router bgp 100
awplus(config-router)# no bgp router-id
```

## bgp scan-time (BGP only)

**Overview** Use this command to set the interval for BGP route next-hop scanning.  
Use the **no** variant of this command to disable this function.

**Syntax** `bgp scan-time <time>`  
`no bgp scan-time [<time>]`

| Parameter                 | Description                                             |
|---------------------------|---------------------------------------------------------|
| <code>&lt;time&gt;</code> | <code>&lt;0-60&gt;</code> Scanning interval in seconds. |

**Default** The default scanning interval is 60 seconds.

**Mode** Router Configuration

**Usage** Use this command to configure scanning intervals of BGP routers. This interval is the period after which router checks the validity of the routes in its database.

To disable BGP scanning, set the scan time interval to 0 seconds.

**Example** `awplus# configure terminal`  
`awplus(config)# router bgp 100`  
`awplus(config-router)# bgp scan-time 10`

# bgp update-delay

**Overview** Use this command to specify the update-delay value for a graceful-restart capable router.

Use the **no** variant of this command to revert to the default update-delay value.

**Syntax** `bgp update-delay <1-3600>`  
`no bgp update-delay [<1-3600>]`

| Parameter | Description             |
|-----------|-------------------------|
| <1-3600>  | Delay value in seconds. |

**Default** The default update-delay value is 120 seconds.

**Mode** Router Configuration

**Usage** The update-delay value is the maximum time a graceful-restart capable router which is restarting will defer route-selection and advertisements to all its graceful-restart capable neighbors. This maximum time starts from the instance the first neighbor attains established state after restart. The restarting router prematurely terminates this timer when end-of-rib markers are received from all its graceful-restart capable neighbors.

**Example** `awplus# configure terminal`  
`awplus(config)# router bgp 10`  
`awplus(config-router)# bgp update-delay 345`

# clear bgp \*

**Overview** Use this command to reset the BGP and BGP4+ connections for all peers.

**Syntax** clear bgp \*  
clear bgp \* in [prefix-filter]  
clear bgp \* out  
clear bgp \* soft [in|out]

| Parameter     | Description                                                                                                                                                                                                                                                                                                                           |
|---------------|---------------------------------------------------------------------------------------------------------------------------------------------------------------------------------------------------------------------------------------------------------------------------------------------------------------------------------------|
| *             | Clears all BGP and BGP4+ peers.                                                                                                                                                                                                                                                                                                       |
| in            | Indicates that incoming advertised routes will be cleared.                                                                                                                                                                                                                                                                            |
| prefix-filter | Specifies that a prefix-list will be sent, by the ORF mechanism, to those neighbors with which the ORF capability has been negotiated. The neighbors will be triggered to resend updates, which match the prefix-list filter, to the local router. The local router will then perform a soft reconfiguration.                         |
| out           | Indicates that outgoing advertised routes will be cleared.                                                                                                                                                                                                                                                                            |
| soft in       | Soft inbound reset causes the neighbors to resend all their updates to the local device, without resetting the connection or clearing the entries in the local device. So, the local device stores new updates, and uses them to systematically replace existing table entries. This process can use a considerable amount of memory. |
| soft out      | Soft outbound reset causes the device to simply resend all its updates to the specified neighbor(s), without resetting the connection, or clearing table entries.                                                                                                                                                                     |

**Mode** Privileged Exec

**Examples** awplus# clear bgp \* soft in  
awplus# clear bgp \* in prefix-filter

## clear bgp (IPv4 or IPv6 address)

**Overview** Use this command to reset the BGP and BGP4+ connections for specified peers.

When VRF-lite is configured, you can apply this command to a specific VRF instance. This command resets all BGP connections from any address family (from either IPv4 or IPv6 Address Families).

**Syntax [BGP]**

```
clear bgp <ip-addr>
clear bgp <ip-addr> in [prefix-filter]
clear bgp <ip-addr> out
clear bgp <ip-addr> soft [in|out]
```

**Syntax (VRF-lite)** `clear ip bgp <ip-addr> [vrf <vrf-name>] [in|out|soft [in|out]]`

**Syntax [BGP4+]**

```
clear bgp <ipv6-addr>
clear bgp <ipv6-addr> in [prefix-filter]
clear bgp <ipv6-addr> out
clear bgp <ipv6-addr> soft [in|out]
```

| Parameter     | Description                                                                                                                                                                                                                                                                                                                           |
|---------------|---------------------------------------------------------------------------------------------------------------------------------------------------------------------------------------------------------------------------------------------------------------------------------------------------------------------------------------|
| <ip-addr>     | Specifies the IPv4 address of the neighbor whose connection is to be reset, entered in the form A.B.C.D.                                                                                                                                                                                                                              |
| <ipv6-addr>   | Specifies the IPv6 address of the neighbor whose connection is to be reset, entered in hexadecimal in the format X:X::X:X.                                                                                                                                                                                                            |
| in            | Indicates that incoming advertised routes will be cleared.                                                                                                                                                                                                                                                                            |
| prefix-filter | Specifies that a prefix-list will be sent, by the ORF mechanism, to those neighbors with which the ORF capability has been negotiated. The neighbors will be triggered to resend updates, which match the prefix-list filter, to the local router. The local router will then perform a soft reconfiguration.                         |
| out           | Indicates that outgoing advertised routes will be cleared.                                                                                                                                                                                                                                                                            |
| soft in       | Soft inbound reset causes the neighbors to resend all their updates to the local device, without resetting the connection or clearing the entries in the local device. So, the local device stores new updates, and uses them to systematically replace existing table entries. This process can use a considerable amount of memory. |
| soft out      | Soft outbound reset causes the device to simply resend all its updates to the specified neighbor(s), without resetting the connection, or clearing table entries.                                                                                                                                                                     |
| vrf           | Applies the command to the specified VRF instance.                                                                                                                                                                                                                                                                                    |
| <vrf-name>    | The name of the VRF instance.                                                                                                                                                                                                                                                                                                         |



**Mode** Privileged Exec

**Examples [BGP]**  
awplus# clear bgp 3.3.3.3 soft in prefix-filter  
awplus# clear bgp 2.2.2.2 out

**Example (VRF-lite)** To apply the above example to clear the BGP connection to peer at IP address 192.0.2.11 for the VRF instance blue, use the following commands:

```
awplus# clear bgp 192.0.2.11 vrf blue in
```

**Examples [BGP4+]**  
awplus# clear bgp 2001:0db8:010d::1 soft in prefix-filter  
awplus# clear bgp 2001:0db8:010d::1 out

**Related Commands** [clear bgp \(IPv4 or IPv6 address\)](#)

**Command changes** Version 5.4.6-2.1: VRF-lite support added.

# clear bgp (ASN)

**Overview** Use this command to reset the BGP and BGP4+ connections for peers in the specified Autonomous System Number (ASN).

**Syntax** `clear bgp <asn> [in [prefix-filter]|out|soft [in|out]]`

| Parameter     | Description                                                                                                                                                                                                                                                                                                                           |
|---------------|---------------------------------------------------------------------------------------------------------------------------------------------------------------------------------------------------------------------------------------------------------------------------------------------------------------------------------------|
| <asn>         | <1-4294967295><br>The AS Number for which all routes will be cleared.                                                                                                                                                                                                                                                                 |
| in            | Indicates that incoming advertised routes will be cleared.                                                                                                                                                                                                                                                                            |
| prefix-filter | Specifies that a prefix-list will be sent, by the ORF mechanism, to those neighbors with which the ORF capability has been negotiated. The neighbors will be triggered to resend updates, which match the prefix-list filter, to the local router. The local router will then perform a soft reconfiguration.                         |
| out           | Indicates that outgoing advertised routes will be cleared.                                                                                                                                                                                                                                                                            |
| soft in       | Soft inbound reset causes the neighbors to resend all their updates to the local device, without resetting the connection or clearing the entries in the local device. So, the local device stores new updates, and uses them to systematically replace existing table entries. This process can use a considerable amount of memory. |
| soft out      | Soft outbound reset causes the device to simply resend all its updates to the specified neighbor(s), without resetting the connection, or clearing table entries.                                                                                                                                                                     |

**Mode** Privileged Exec

**Examples**

```
awplus# clear bgp 300 soft in prefix-filter
awplus# clear bgp 500 soft out
awplus# clear bgp 300 soft in
awplus# clear bgp 1 in prefix-filter
```

# clear bgp external

**Overview** Use this command to reset the BGP and BGP4+ connections for all external peers.

**Syntax** `clear bgp external [in [prefix-filter]|out|soft [in|out]]`

| Parameter     | Description                                                                                                                                                                                                                                                                                                                           |
|---------------|---------------------------------------------------------------------------------------------------------------------------------------------------------------------------------------------------------------------------------------------------------------------------------------------------------------------------------------|
| external      | Clears all external peers.                                                                                                                                                                                                                                                                                                            |
| in            | Indicates that incoming advertised routes will be cleared.                                                                                                                                                                                                                                                                            |
| prefix-filter | Specifies that a prefix-list will be sent, by the ORF mechanism, to those neighbors with which the ORF capability has been negotiated. The neighbors will be triggered to resend updates, which match the prefix-list filter, to the local router. The local router will then perform a soft reconfiguration.                         |
| out           | Indicates that outgoing advertised routes will be cleared.                                                                                                                                                                                                                                                                            |
| soft in       | Soft inbound reset causes the neighbors to resend all their updates to the local device, without resetting the connection or clearing the entries in the local device. So, the local device stores new updates, and uses them to systematically replace existing table entries. This process can use a considerable amount of memory. |
| soft out      | Soft outbound reset causes the device to simply resend all its updates to the specified neighbor(s), without resetting the connection, or clearing table entries.                                                                                                                                                                     |

**Mode** Privileged Exec

**Examples**  
`awplus# clear bgp external soft in`  
`awplus# clear bgp external in prefix-filter`

# clear bgp peer-group

**Overview** Use this command to reset the BGP and BGP4+ connections for all members of a peer group.

**Syntax** `clear bgp peer-group <peer-group> [in [prefix-filter]|out|soft [in|out]]`

| Parameter     | Description                                                                                                                                                                                                                                                                                                                           |
|---------------|---------------------------------------------------------------------------------------------------------------------------------------------------------------------------------------------------------------------------------------------------------------------------------------------------------------------------------------|
| peer-group    | Clears all members of a peer group.                                                                                                                                                                                                                                                                                                   |
| <peer-group>  | Name of the BGP peer group                                                                                                                                                                                                                                                                                                            |
| in            | Indicates that incoming advertised routes will be cleared.                                                                                                                                                                                                                                                                            |
| prefix-filter | Specifies that a prefix-list will be sent, by the ORF mechanism, to those neighbors with which the ORF capability has been negotiated. The neighbors will be triggered to resend updates, which match the prefix-list filter, to the local router. The local router will then perform a soft reconfiguration.                         |
| out           | Indicates that outgoing advertised routes will be cleared.                                                                                                                                                                                                                                                                            |
| soft in       | Soft inbound reset causes the neighbors to resend all their updates to the local device, without resetting the connection or clearing the entries in the local device. So, the local device stores new updates, and uses them to systematically replace existing table entries. This process can use a considerable amount of memory. |
| soft out      | Soft outbound reset causes the device to simply resend all its updates to the specified neighbor(s), without resetting the connection, or clearing table entries.                                                                                                                                                                     |

**Mode** Privileged Exec

**Examples**  
awplus# clear bgp peer-group P1 soft in  
awplus# clear bgp peer-group P2 in

# clear ip bgp \* (BGP only)

**Overview** Use this command to reset all BGP connections, either by fully resetting sessions or by performing soft resets.

If VRF-lite is configured, you can reset BGP connections for all VRF instances or for a specified VRF instance.

**Syntax**

```
clear ip bgp *
clear ip bgp * in
clear ip bgp * out
clear ip bgp * soft [in|out]
clear ip bgp * in [prefix-filter]
```

**Syntax (VRF-lite)**

```
clear ip bgp * [vrf <vrf-name>]
clear ip bgp * [vrf <vrf-name>] in
clear ip bgp * [vrf <vrf-name>] out
clear ip bgp * [vrf <vrf-name>] soft [in|out]
clear ip bgp * in [prefix-filter]
```

| Parameter     | Description                                                                                                                                                                                                                                                                                                                           |
|---------------|---------------------------------------------------------------------------------------------------------------------------------------------------------------------------------------------------------------------------------------------------------------------------------------------------------------------------------------|
| *             | Clears all BGP peers.                                                                                                                                                                                                                                                                                                                 |
| in            | Indicates that incoming advertised routes will be cleared.                                                                                                                                                                                                                                                                            |
| prefix-filter | Specifies that a prefix-list will be sent, by the ORF mechanism, to those neighbors with which the ORF capability has been negotiated. The neighbors will be triggered to resend updates, which match the prefix-list filter, to the local router. The local router will then perform a soft reconfiguration.                         |
| out           | Indicates that outgoing advertised routes will be cleared.                                                                                                                                                                                                                                                                            |
| soft in       | Soft inbound reset causes the neighbors to resend all their updates to the local device, without resetting the connection or clearing the entries in the local device. So, the local device stores new updates, and uses them to systematically replace existing table entries. This process can use a considerable amount of memory. |
| soft out      | Soft outbound reset causes the device to simply resend all its updates to the specified neighbor(s), without resetting the connection, or clearing table entries.                                                                                                                                                                     |
| vrf           | Applies the command to the specified VRF instance.                                                                                                                                                                                                                                                                                    |
| <vrf-name>    | The name of the VRF instance.                                                                                                                                                                                                                                                                                                         |

**Mode** Privileged Exec

**Examples** To clear all BGP peers, use the command:

```
awplus# clear ip bgp *
```

**Example (VRF-lite)** To clear all BGP peers in VRF instance red, use the command:

```
awplus# clear ip bgp * vrf red
```

To clear all outbound BGP peers in VRF instance red, use the command:

```
awplus# clear ip bgp * out vrf red
```

**Command changes** Version 5.4.6-2.1: VRF-lite support added.

# clear ip bgp (IPv4) (BGP only)

**Overview** Use this command to reset the IPv4 BGP connection to the peer specified by the IP address. When VRF-lite is configured, you can apply this command to a specific VRF instance.

**Syntax [BGP]** `clear ip bgp <ipv4-addr> [in [prefix-filter]|out|soft [in|out]]`

**Syntax (VRF-lite)** `clear ip bgp <ipv4-address> [vrf <vrf-name>] [in|out|soft [in|out]]`

| Parameter     | Description                                                                                                                                                                                                                                                                                                                           |
|---------------|---------------------------------------------------------------------------------------------------------------------------------------------------------------------------------------------------------------------------------------------------------------------------------------------------------------------------------------|
| <ipv4-addr>   | Specifies the IPv4 address of the neighbor whose connection is to be reset, entered in the form A.B.C.D.                                                                                                                                                                                                                              |
| in            | Indicates that incoming advertised routes will be cleared.                                                                                                                                                                                                                                                                            |
| prefix-filter | Specifies that a prefix-list will be sent, by the ORF mechanism, to those neighbors with which the ORF capability has been negotiated. The neighbors will be triggered to resend updates, which match the prefix-list filter, to the local router. The local router will then perform a soft reconfiguration.                         |
| out           | Indicates that outgoing advertised routes will be cleared.                                                                                                                                                                                                                                                                            |
| soft in       | Soft inbound reset causes the neighbors to resend all their updates to the local switch, without resetting the connection or clearing the entries in the local switch. So, the local switch stores new updates, and uses them to systematically replace existing table entries. This process can use a considerable amount of memory. |
| soft out      | Soft outbound reset causes the switch to simply resend all its updates to the specified neighbor(s), without resetting the connection, or clearing table entries.                                                                                                                                                                     |
| vrf           | Applies the command to the specified VRF instance.                                                                                                                                                                                                                                                                                    |
| <vrf-name>    | The name of the VRF instance.                                                                                                                                                                                                                                                                                                         |

**Mode [BGP]** Privileged Exec

**Examples [BGP]** To clear the BGP connection to peer at IPv4 address 192.168.1.1 and clear all incoming routes, use the following command:

```
awplus# clear ip bgp 192.168.1.1 in
```

To apply the above example to clear the BGP connection to the peer at IP address 192.0.2.11 for the VRF instance blue, use the following commands:

```
awplus# clear ip bgp 192.0.2.11 vrf blue in
```

**Command changes** Version 5.4.6-2.1: VRF-lite support added.

# clear ip bgp dampening (BGP only)

**Overview** Use this command to clear route dampening information and unsuppress routes that have been suppressed.

**Syntax** `clear ip bgp dampening [<ip-address>|<ip-address/m>]`

| Parameter                         | Description                                                                                                                              |
|-----------------------------------|------------------------------------------------------------------------------------------------------------------------------------------|
| <code>&lt;ip-address&gt;</code>   | Specifies the IPv4 address for which BGP dampening is to be cleared, in dotted decimal format.                                           |
| <code>&lt;ip-address/m&gt;</code> | Specifies the IPv4 address with mask for which BGP dampening is to be cleared, entered in the form A.B.C.D/M. Where M is the subnet mask |
| <code>ipv4</code>                 | Clears all IPv4 address family peers. Configure parameters relating to the BGP exchange of IPv4 prefixes.                                |

**Mode** Privileged Exec

**Examples** `awplus# clear ip bgp dampening 10.10.0.121`



# clear ip bgp flap-statistics (BGP only)

**Overview** Use this command to clear the flap count and history duration for the specified prefixes.

**Syntax** `clear ip bgp flap-statistics [<ip-address>|<ip-address/m>]`

| Parameter                         | Description                                                                                               |
|-----------------------------------|-----------------------------------------------------------------------------------------------------------|
| <code>&lt;ip-address&gt;</code>   | Specifies the IPv4 address for which BGP flap count and history duration are to be cleared.               |
| <code>&lt;ip-address/m&gt;</code> | Specifies the IPv4 address with mask for which BGP flap count and history duration are to be cleared.     |
| <code>ipv4</code>                 | Clears all IPv4 address family peers. Configure parameters relating to the BGP exchange of IPv4 prefixes. |

**Mode** Privileged Exec

**Examples** `awplus# clear ip bgp flap-statistics 10.10.0.121`

# clear ip bgp (ASN) (BGP only)

**Overview** Use this command to reset the BGP connections to all peers in a specified Autonomous System Number (ASN).

**Syntax**

```
clear ip bgp <asn> [in [prefix-filter]|out|soft [in|out]]
clear ip bgp <asn> ipv4
clear ip bgp <asn> ipv4 in [prefix-filter]
clear ip bgp <asn> ipv4 out
clear ip bgp <asn> ipv4 soft [in|out]
```

| Parameter     | Description                                                                                                                                                                                                                                                                                                                           |
|---------------|---------------------------------------------------------------------------------------------------------------------------------------------------------------------------------------------------------------------------------------------------------------------------------------------------------------------------------------|
| <asn>         | <1-4294967295><br>Specifies the ASN for which all routes will be cleared.                                                                                                                                                                                                                                                             |
| ipv4          | Clears all IPv4 address family peers. Configure parameters relating to the BGP exchange of IPv4 prefixes.                                                                                                                                                                                                                             |
| in            | Indicates that incoming advertised routes will be cleared.                                                                                                                                                                                                                                                                            |
| prefix-filter | Specifies that a prefix-list will be sent, by the ORF mechanism, to those neighbors with which the ORF capability has been negotiated. The neighbors will be triggered to resend updates, which match the prefix-list filter, to the local router. The local router will then perform a soft reconfiguration.                         |
| out           | Indicates that outgoing advertised routes will be cleared.                                                                                                                                                                                                                                                                            |
| soft in       | Soft inbound reset causes the neighbors to resend all their updates to the local device, without resetting the connection or clearing the entries in the local device. So, the local device stores new updates, and uses them to systematically replace existing table entries. This process can use a considerable amount of memory. |
| soft out      | Soft outbound reset causes the device to simply resend all its updates to the specified neighbor(s), without resetting the connection, or clearing table entries.                                                                                                                                                                     |

**Mode** Privileged Exec

**Examples** awplus# clear ip bgp 100

# clear ip bgp external (BGP only)

**Overview** Use this command to reset the BGP connections to all external peers.

**Syntax**

```
clear ip bgp external [in [prefix-filter]|out|soft [in|out]]
clear ip bgp external
clear ip bgp external in [prefix-filter]
clear ip bgp external out
clear ip bgp external soft [in|out]
```

| Parameter     | Description                                                                                                                                                                                                                                                                                                                           |
|---------------|---------------------------------------------------------------------------------------------------------------------------------------------------------------------------------------------------------------------------------------------------------------------------------------------------------------------------------------|
| external      | Clears all external peers.                                                                                                                                                                                                                                                                                                            |
| ipv4          | Clears all IPv4 address family peers. Configure parameters relating to the BGP exchange of IPv4 prefixes.                                                                                                                                                                                                                             |
| in            | Indicates that incoming advertised routes will be cleared.                                                                                                                                                                                                                                                                            |
| prefix-filter | Specifies that a prefix-list will be sent, by the ORF mechanism, to those neighbors with which the ORF capability has been negotiated. The neighbors will be triggered to resend updates, which match the prefix-list filter, to the local router. The local router will then perform a soft reconfiguration.                         |
| out           | Indicates that outgoing advertised routes will be cleared.                                                                                                                                                                                                                                                                            |
| soft in       | Soft inbound reset causes the neighbors to resend all their updates to the local device, without resetting the connection or clearing the entries in the local device. So, the local device stores new updates, and uses them to systematically replace existing table entries. This process can use a considerable amount of memory. |
| soft out      | Soft outbound reset causes the device to simply resend all its updates to the specified neighbor(s), without resetting the connection, or clearing table entries.                                                                                                                                                                     |

**Mode** Privileged Exec

**Examples** awplus# clear ip bgp external out

# clear ip bgp peer-group (BGP only)

**Overview** Use this command to reset the BGP connections to all members of a peer group.

**Syntax**

```
clear ip bgp peer-group <peer-name>
clear ip bgp peer-group <peer-name> in [prefix-filter]
clear ip bgp peer-group <peer-name> out
clear ip bgp peer-group <peer-name> soft [in|out]
clear ip bgp peer-group <peer-name> out
clear ip bgp peer-group <peer-name> soft [in|out]
```

| Parameter     | Description                                                                                                                                                                                                                                                                                                                           |
|---------------|---------------------------------------------------------------------------------------------------------------------------------------------------------------------------------------------------------------------------------------------------------------------------------------------------------------------------------------|
| peer-group    | Clears all members of a peer group.                                                                                                                                                                                                                                                                                                   |
| <peer-name>   | Specifies the name of the peer group for which all members will be cleared.                                                                                                                                                                                                                                                           |
| ipv4          | Clears all IPv4 address family peers. Configure parameters relating to the BGP exchange of IPv4 prefixes.                                                                                                                                                                                                                             |
| in            | Indicates that incoming advertised routes will be cleared.                                                                                                                                                                                                                                                                            |
| prefix-filter | Specifies that a prefix-list will be sent, by the ORF mechanism, to those neighbors with which the ORF capability has been negotiated. The neighbors will be triggered to resend updates, which match the prefix-list filter, to the local router. The local router will then perform a soft reconfiguration.                         |
| out           | Indicates that outgoing advertised routes will be cleared.                                                                                                                                                                                                                                                                            |
| soft in       | Soft inbound reset causes the neighbors to resend all their updates to the local device, without resetting the connection or clearing the entries in the local device. So, the local device stores new updates, and uses them to systematically replace existing table entries. This process can use a considerable amount of memory. |
| soft out      | Soft outbound reset causes the device to simply resend all its updates to the specified neighbor(s), without resetting the connection, or clearing table entries.                                                                                                                                                                     |

**Mode** Privileged Exec

**Examples** awplus# clear ip bgp peer-group Peer1 out

# clear bgp ipv6 (ipv6 address) (BGP4+ only)

**Overview** Use this command to reset the IPv6 BGP4+ connection to the peer specified by the IP address.

**Syntax** `clear bgp ipv6 <ipv6-addr> [in [prefix-filter]|out|soft [in|out]]`

| Parameter     | Description                                                                                                                                                                                                                                                                                                                           |
|---------------|---------------------------------------------------------------------------------------------------------------------------------------------------------------------------------------------------------------------------------------------------------------------------------------------------------------------------------------|
| <ipv6-addr>   | Specifies the IPv6 address of the neighbor whose connection is to be reset, entered in hexadecimal in the format X:X::X:X.                                                                                                                                                                                                            |
| ipv6          | Clears all IPv6 address family peers. Configure parameters relating to the BGP4+ exchange of IPv6 prefixes.                                                                                                                                                                                                                           |
| in            | Indicates that incoming advertised routes will be cleared.                                                                                                                                                                                                                                                                            |
| prefix-filter | Specifies that a prefix-list will be sent, by the ORF mechanism, to those neighbors with which the ORF capability has been negotiated. The neighbors will be triggered to resend updates, which match the prefix-list filter, to the local router. The local router will then perform a soft reconfiguration.                         |
| out           | Indicates that outgoing advertised routes will be cleared.                                                                                                                                                                                                                                                                            |
| soft in       | Soft inbound reset causes the neighbors to resend all their updates to the local device, without resetting the connection or clearing the entries in the local device. So, the local device stores new updates, and uses them to systematically replace existing table entries. This process can use a considerable amount of memory. |
| soft out      | Soft outbound reset causes the device to simply resend all its updates to the specified neighbor(s), without resetting the connection, or clearing table entries.                                                                                                                                                                     |

**Mode** Privileged Exec

**Examples** Use the following command to clear the BGP4+ connection to peer at IPv6 address 2001:0db8:010d::1, and clearing all incoming routes.

```
awplus# clear ip bgp 2001:0db8:010d::1 in
```

# clear bgp ipv6 dampening (BGP4+ only)

**Overview** Use this command to clear route dampening information and unsuppress routes that have been suppressed routes.

**Syntax** clear bgp ipv6 dampening  
[<ipv6-addr>|<ipv6-addr/prefix-length>]

| Parameter                     | Description                                                                                                                                                                                          |
|-------------------------------|------------------------------------------------------------------------------------------------------------------------------------------------------------------------------------------------------|
| <ipv6-addr>                   | Specifies the IPv6 address for which BGP4+ dampening is to be cleared, entered in hexadecimal in the format X:X::X:X.                                                                                |
| <ipv6-addr/<br>prefix-length> | Specifies the IPv6 address and prefix-length for which BGP4+ dampening is to be cleared. The IPv6 address uses the format X:X::X:X/Prefix-Length. The prefix-length is usually set between 0 and 64. |

**Mode** Privileged Exec

**Examples** awplus# clear bgp ipv6 dampening 2001:0db8:010d::1  
awplus# clear bgp ipv6 dampening 2001:0db8::/64

## clear bgp ipv6 flap-statistics (BGP4+ only)

**Overview** Use this command to clear the flap count and history duration for the specified prefixes.

**Syntax** `clear bgp ipv6 flap-statistics`  
`[<ipv6-addr>|<ipv6-addr/prefix-length>]`

| Parameter                                         | Description                                                                                                                                                                                                                  |
|---------------------------------------------------|------------------------------------------------------------------------------------------------------------------------------------------------------------------------------------------------------------------------------|
| <code>&lt;ipv6-addr&gt;</code>                    | Specifies the IPv6 address for which BGP4+ flap count and history duration are to be cleared, entered in hexadecimal in the format X:X::X:X.                                                                                 |
| <code>&lt;ipv6-addr/<br/>prefix-length&gt;</code> | Specifies the IPv6 address with prefix length for which BGP4+ flap count and history duration are to be cleared. The IPv6 address uses the format X:X::X:X/Prefix-Length. The prefix-length is usually set between 0 and 64. |

**Mode** Privileged Exec

**Examples** `awplus# clear bgp ipv6 flap-statistics 2001:0db8:010d::1`  
`awplus# clear bgp ipv6 flap-statistics 2001:0db8::/64`

# clear bgp ipv6 (ASN) (BGP4+ only)

**Overview** Use this command to reset the BGP4+ connections to all peers in a specified Autonomous System Number (ASN).

**Syntax**

```
clear bgp ipv6 <asn> [in [prefix-filter]|out|soft [in|out]]
clear bgp ipv6 <asn>
clear bgp ipv6 <asn> in [prefix-filter]
clear bgp ipv6 <asn> out
clear bgp ipv6 <asn> soft [in|out]
```

| Parameter     | Description                                                                                                                                                                                                                                                                                                                           |
|---------------|---------------------------------------------------------------------------------------------------------------------------------------------------------------------------------------------------------------------------------------------------------------------------------------------------------------------------------------|
| <asn>         | <1-4294967295><br>Specifies the ASN for which all routes will be cleared.                                                                                                                                                                                                                                                             |
| in            | Indicates that incoming advertised routes will be cleared.                                                                                                                                                                                                                                                                            |
| prefix-filter | Specifies that a prefix-list will be sent, by the ORF mechanism, to those neighbors with which the ORF capability has been negotiated. The neighbors will be triggered to resend updates, which match the prefix-list filter, to the local router. The local router will then perform a soft reconfiguration.                         |
| out           | Indicates that outgoing advertised routes will be cleared.                                                                                                                                                                                                                                                                            |
| soft in       | Soft inbound reset causes the neighbors to resend all their updates to the local device, without resetting the connection or clearing the entries in the local device. So, the local device stores new updates, and uses them to systematically replace existing table entries. This process can use a considerable amount of memory. |
| soft out      | Soft outbound reset causes the device to simply resend all its updates to the specified neighbor(s), without resetting the connection, or clearing table entries.                                                                                                                                                                     |

**Mode** Privileged Exec

**Examples**

```
awplus# clear bgp ipv6 100
awplus# clear bgp ipv6 100 in
awplus# clear bgp ipv6 100 in prefix-filter
awplus# clear bgp ipv6 100 out
awplus# clear bgp ipv6 100 soft out
awplus# clear bgp ipv6 100 soft in
```



# clear bgp ipv6 external (BGP4+ only)

**Overview** Use this command to reset the BGP4+ connections to all external peers.

**Syntax**

```
clear bgp ipv6 external [in [prefix-filter]|out|soft [in|out]]
clear bgp ipv6 external
clear bgp ipv6 external in [prefix-filter]
clear bgp ipv6 external out
clear bgp ipv6 external soft [in|out]
```

| Parameter     | Description                                                                                                                                                                                                                                                                                                                           |
|---------------|---------------------------------------------------------------------------------------------------------------------------------------------------------------------------------------------------------------------------------------------------------------------------------------------------------------------------------------|
| external      | Clears all external peers.                                                                                                                                                                                                                                                                                                            |
| in            | Indicates that incoming advertised routes will be cleared.                                                                                                                                                                                                                                                                            |
| prefix-filter | Specifies that a prefix-list will be sent, by the ORF mechanism, to those neighbors with which the ORF capability has been negotiated. The neighbors will be triggered to resend updates, which match the prefix-list filter, to the local router. The local router will then perform a soft reconfiguration.                         |
| out           | Indicates that outgoing advertised routes will be cleared.                                                                                                                                                                                                                                                                            |
| soft in       | Soft inbound reset causes the neighbors to resend all their updates to the local device, without resetting the connection or clearing the entries in the local device. So, the local device stores new updates, and uses them to systematically replace existing table entries. This process can use a considerable amount of memory. |
| soft out      | Soft outbound reset causes the device to simply resend all its updates to the specified neighbor(s), without resetting the connection, or clearing table entries.                                                                                                                                                                     |

**Mode** Privileged Exec

**Examples**

```
awplus# clear bgp ipv6 external in
awplus# clear bgp ipv6 external in prefix
awplus# clear bgp ipv6 external out
awplus# clear bgp ipv6 external soft out
awplus# clear bgp ipv6 external soft in
```

# clear bgp ipv6 peer-group (BGP4+ only)

**Overview** Use this command to reset the BGP4+ connections to all members of a peer group.

**Syntax**

```
clear bgp ipv6 peer-group <peer-name>
clear bgp ipv6 peer-group <peer-name> in [prefix-filter]
clear bgp ipv6 peer-group <peer-name> out
clear bgp ipv6 peer-group <peer-name> soft [in|out]
```

| Parameter     | Description                                                                                                                                                                                                                                                                                                                           |
|---------------|---------------------------------------------------------------------------------------------------------------------------------------------------------------------------------------------------------------------------------------------------------------------------------------------------------------------------------------|
| peer-group    | Clears all members of a peer group.                                                                                                                                                                                                                                                                                                   |
| <peer-name>   | Specifies the name of the peer group for which all members will be cleared.                                                                                                                                                                                                                                                           |
| ipv6          | Clears all IPv6 address family peers. Configure parameters relating to the BGP4+ exchange of IPv6 prefixes.                                                                                                                                                                                                                           |
| in            | Indicates that incoming advertised routes will be cleared.                                                                                                                                                                                                                                                                            |
| prefix-filter | Specifies that a prefix-list will be sent, by the ORF mechanism, to those neighbors with which the ORF capability has been negotiated. The neighbors will be triggered to resend updates, which match the prefix-list filter, to the local router. The local router will then perform a soft reconfiguration.                         |
| out           | Indicates that outgoing advertised routes will be cleared.                                                                                                                                                                                                                                                                            |
| soft in       | Soft inbound reset causes the neighbors to resend all their updates to the local device, without resetting the connection or clearing the entries in the local device. So, the local device stores new updates, and uses them to systematically replace existing table entries. This process can use a considerable amount of memory. |
| soft out      | Soft outbound reset causes the device to simply resend all its updates to the specified neighbor(s), without resetting the connection, or clearing table entries.                                                                                                                                                                     |

**Mode** Privileged Exec

**Example** awplus# clear bgp ipv6 peer-group Peer1 out

# debug bgp (BGP only)

**Overview** Use this command to turn on one or more BGP debug options.

Use the **no** variant of this command to disable one or more BGP debug options.

**Syntax**

```
debug bgp
[all|dampening|events|filters|fsm|keepalives|nht|nsm|updates
[in|out]]

no debug all bgp

no debug bgp
[all|dampening|events|filters|fsm|keepalives|nht|nsm|updates
[in|out]]
```

| Parameter  | Description                                                   |
|------------|---------------------------------------------------------------|
| all        | Turns on all debugging for BGP.                               |
| dampening  | Specifies debugging for BGP dampening.                        |
| events     | Specifies debugging for BGP events.                           |
| filters    | Specifies debugging for BGP filters.                          |
| fsm        | Specifies debugging for BGP Finite State Machine (FSM).       |
| keepalives | Specifies debugging for BGP keepalives.                       |
| nht        | Specifies debugging for BGP NHT (Next Hop Tracking) messages. |
| nsm        | Specifies debugging for NSM messages.                         |
| updates    | [in out]<br>Specifies debugging for BGP updates.              |
| in         | Inbound updates.                                              |
| out        | Outbound updates.                                             |

**Mode** Privileged Exec and Global Configuration

**Usage** If the command is entered with no parameters, then all debug options are enabled.

**Examples**

```
awplus# debug bgp
awplus# debug bgp events
awplus# debug bgp nht
awplus# debug bgp updates in
```

**Related Commands** [show debugging bgp \(BGP only\)](#)  
[undebug bgp \(BGP only\)](#)

# distance (BGP and BGP4+)

**Overview** This command sets the administrative distance for BGP and BGP4+ routes. The device uses this value to select between two or more routes to the same destination from two different routing protocols. Set the administrative distance for BGP routes in the Router Configuration mode, and for BGP4+ routes in IPv6 Address Family Configuration mode.

The route with the smallest administrative distance value is added to the Forwarding Information Base (FIB). For more information, see the [Route Selection Feature Overview and Configuration Guide](#), which is available from the above link at [alliedtelesis.com](#).

The **no** variant of this command sets the administrative distance for the route to the default for the route type.

**Syntax**

```
distance <1-255> <ip-address/m>
distance bgp <ebgp> <ibgp> <local>
no distance <1-255> <ip-address/m>
no distance bgp <ebgp> <ibgp> <local>
```

| Parameter      | Description                                                                                                                                                                                                                    |
|----------------|--------------------------------------------------------------------------------------------------------------------------------------------------------------------------------------------------------------------------------|
| <1-255>        | The administrative distance value you are setting for the route.                                                                                                                                                               |
| <ip-address/m> | The IP source prefix that you are changing the administrative distance for, entered in the form A . B . C . D / M. This is an IPv4 address in dotted decimal notation followed by a forward slash, and then the prefix length. |
| <ebgp>         | Specifies the administrative distance of external BGP (eBGP) routes. These are routes learned from a neighbor out of the AS. Specify the distance as a number between 1 and 255.<br>Default: <b>20</b>                         |
| <ibgp>         | Specifies the administrative distance of internal BGP (iBGP) routes. These are routes learned from a neighbor within the same AS. Specify the distance as a number between 1 and 255.<br>Default: <b>200</b>                   |
| <local>        | Specifies the administrative distance of local BGP routes. These are routes redistributed from another protocol within your device. Specify the distance as a number between 1 and 255.<br>Default: <b>200</b>                 |

**Mode [BGP]** Router Configuration

**Mode [BGP4+]** IPv6 Address Family Configuration

**Usage** You can use this command to set the administrative distance:

- for each BGP route type by specifying:

```
awplus(config-router)# distance <ebgp> <igbp> <local>
```

- for a specific route by specifying:

```
awplus(config-router)# distance <1-255> <ip-address/m>
[<listname>]
```

If the administrative distance is changed, it could create inconsistency in the routing table and obstruct routing.

**Example [BGP4+]** For BGP4+ IPv6, to set BGP 100's administrative distances for eBGP routes to 34, iBGP routes to 23, and local BGP routes to 15, use the commands:

```
awplus# configure terminal
awplus(config)# router bgp 100
awplus(config-router)# address-family ipv6
awplus(config-router-af)# distance bgp 34 23 15
```

# exit-address-family

**Overview** Use this command to exit either the IPv4 or the IPv6 Address Family Configuration mode.

**Syntax** `exit-address-family`

**Mode [BGP]** IPv4 Address Family Configuration

**Mode [BGP4+]** IPv6 Address Family Configuration

**Examples [BGP]** To enter and then exit IPv4 Address Family Configuration mode, use the commands:

```
awplus# configure terminal
awplus(config)# router bgp 100
awplus(config-router)# address-family ipv4
awplus(config-router-af)# exit-address-family
awplus(config-router)#
```

**Example (VRF-lite)** To enter and then exit IPv4 Address Family Configuration mode for VRF instance red, use the commands:

```
awplus# configure terminal
awplus(config)# router bgp 100
awplus(config-router)# address-family ipv4 vrf red
awplus(config-router-af)# exit-address-family
awplus(config-router)#
```

**Example [BGP4+]** To enter and then exit IPv6 Address Family Configuration mode, use the commands:

```
awplus# configure terminal
awplus(config)# router bgp 100
awplus(config-router)# address-family ipv6
awplus(config-router-af)# exit-address-family
awplus(config-router)#
```

**Related Commands** [address-family](#)

**Command changes** Version 5.4.6-2.1: VRF-lite support added.

# ip community-list

**Overview** Use this command to add an entry to a standard or extended BGP community-list filter.

Use the **no** variant of this command to delete a standard or extended community list entry.

**Syntax** `ip community-list <listname> {deny|permit} .<community>`  
`no ip community-list <listname> {deny|permit} .<community>`

| Parameter    | Description                                                                                                                                                                                   |
|--------------|-----------------------------------------------------------------------------------------------------------------------------------------------------------------------------------------------|
| <listname>   | Specifies the community listname.                                                                                                                                                             |
| deny         | Specifies the community to reject.                                                                                                                                                            |
| permit       | Specifies the community to accept.                                                                                                                                                            |
| .<community> | {<AS:VAL> local-AS no-advertise no-export}                                                                                                                                                    |
| <AS:VAL>     | Specifies the valid value for the community number. This format represents the 32 bit communities value, where AS is the high order 16 bits and VAL is the low order 16 bits in digit format. |
| local-AS     | Specifies routes not to be advertised to external BGP peers.                                                                                                                                  |
| no-advertise | Specifies routes not to be advertised to other BGP peers.                                                                                                                                     |
| no-export    | Specifies routes not to be advertised outside of Autonomous System boundary.                                                                                                                  |

**Mode** Global Configuration

**Usage** A community-list can be used as a filter to BGP updates. Use this command to define the community access list globally, then use neighbor configuration commands to apply the list to a particular neighbor.

There are two kinds of community-lists: expanded and standard. A standard community-list defines the community attributes explicitly and not via a regular expression. An expanded community-list defines the communities attributes with regular expressions.

The standard community-list is compiled into binary format and is directly compared with the BGP communities attribute in the BGP updates. The comparison is faster than the expanded community-list. Any community value that does not match the standard community value is automatically treated as expanded.

**Example** `awplus# configure terminal`  
`awplus(config)# ip community-list mylist permit 7675:80 7675:90`

**Related  
Commands** [ip community-list standard](#)  
[ip community-list expanded](#)  
[show ip community-list](#)



# ip community-list expanded

**Overview** Use this command to add an entry to an expanded BGP community-list filter.

Use the **no** variant of this command to delete the community list entry.

**Syntax**

```
ip community-list <100-199> {deny|permit} .<line>
no ip community-list <100-199> {deny|permit} .<line>
ip community-list expanded <expanded-listname> {deny|permit}
.<line>
no ip community-list expanded <expanded-listname> {deny|permit}
.<line>
```

| Parameter           | Description                                              |
|---------------------|----------------------------------------------------------|
| <100-199>           | Expanded community list number.                          |
| expanded            | Specifies an expanded community list.                    |
| <expanded-listname> | Expanded community list entry.                           |
| deny                | Specifies community to reject.                           |
| permit              | Specifies community to accept.                           |
| .<line>             | Specifies community attributes with regular expressions. |

Regular expressions listed below can be used with the **ip community-list expanded** command:

| Symbol | Character     | Meaning                                                                                                                            |
|--------|---------------|------------------------------------------------------------------------------------------------------------------------------------|
| ^      | Caret         | Used to match the beginning of the input string. When used at the beginning of a string of characters, it negates a pattern match. |
| \$     | Dollar sign   | Used to match the end of the input string.                                                                                         |
| .      | Period        | Used to match a single character (white spaces included).                                                                          |
| *      | Asterisk      | Used to match none or more sequences of a pattern.                                                                                 |
| +      | Plus sign     | Used to match one or more sequences of a pattern.                                                                                  |
| ?      | Question mark | Used to match none or one occurrence of a pattern.                                                                                 |
| _      | Underscore    | Used to match spaces, commas, braces, parenthesis, or the beginning and end of an input string.                                    |
| [ ]    | Brackets      | Specifies a range of single-characters.                                                                                            |
| -      | Hyphen        | Separates the end points of a range.                                                                                               |

**Mode** Global Configuration

**Usage** A `community-list` can be used as a filter to BGP updates. Use this command to define the community access list globally, then use **neighbor** configuration commands to apply the list to a particular neighbor.

There are two kinds of community-lists: expanded and standard. A standard community-list defines the community attributes explicitly and not via a regular expression. An expanded community-list defines the communities attributes with regular expressions.

The standard community-list is compiled into binary format and is directly compared with the BGP communities attribute in the BGP updates. The comparison is faster than the expanded community-list. Any community value that does not match the standard community value is automatically treated as expanded.

**Examples**

```
awplus# configure terminal
awplus(config)# ip community-list 125 permit 6789906
awplus(config)# ip community-list expanded CLIST permit .*
```

**Related Commands**

- [ip community-list](#)
- [ip community-list standard](#)
- [show ip community-list](#)

# ip community-list standard

**Overview** Use this command to add an entry to a standard BGP community-list filter.  
Use the **no** variant of this command to delete the standard community-list entry.

**Syntax**

```
ip community-list <1-99> {deny|permit} [.<community>]
no ip community-list <1-99> {deny|permit} [.<community>]
ip community-list standard <standard-listname> {deny|permit}
[.<community>]
no ip community-list standard <standard-listname> {deny|permit}
[.<community>]
```

| Parameter           | Description                                                                                                                                                                                   |
|---------------------|-----------------------------------------------------------------------------------------------------------------------------------------------------------------------------------------------|
| <1-99>              | Standard community list number.                                                                                                                                                               |
| standard            | Specifies a standard community list.                                                                                                                                                          |
| <standard-listname> | Standard community list entry.                                                                                                                                                                |
| deny                | Specifies community to reject.                                                                                                                                                                |
| permit              | Specifies community to accept.                                                                                                                                                                |
| <community>         | {<AS:VAL>   local-AS   no-advertise   no-export}                                                                                                                                              |
| <AS:VAL>            | Specifies the valid value for the community number. This format represents the 32 bit communities value, where AS is the high order 16 bits and VAL is the low order 16 bits in digit format. |
| local-AS            | Specifies routes not to be advertised to external BGP peers.                                                                                                                                  |
| no-advertise        | Specifies routes not to be advertised to other BGP peers.                                                                                                                                     |
| no-export           | Specifies routes not to be advertised outside of the Autonomous System boundary.                                                                                                              |

**Mode** Global Configuration

**Usage** A community-list can be used as a filter to BGP updates. Use this command to define the community access list globally, then use neighbor configuration commands to apply the list to a particular neighbor.

There are two kinds of community-lists: expanded and standard. The standard community-list defines the community attributes as explicit values, without regular expressions. The expanded community-list defines the communities attributes with regular expressions.

The standard community-list is compiled into binary format and is directly compared with the BGP communities attribute in the BGP updates. The comparison is faster than the expanded community-list. Any community value

that does not match the standard community value is automatically treated as expanded.

**Examples**

```
awplus# configure terminal
awplus(config)# ip community-list standard CLIST permit 7675:80
7675:90 no-export
awplus(config)# ip community-list 34 permit 5675:50
no-advertise
```

**Related  
Commands**

- [ip community-list](#)
- [ip community-list expanded](#)
- [show ip community-list](#)

# ip extcommunity-list expanded

**Overview** Use this command to create or delete an expanded extended community list.

Use the **no** variant of this command to delete the expanded extended community-list entry.

**Syntax**

```
ip extcommunity-list <100-199> {deny|permit}
{.<line>|.<AS:NN>|.<ip-address>}

no ip extcommunity-list <100-199> {deny|permit}
{.<line>|.<AS:NN>|.<ip-address>}

ip extcommunity-list expanded <expanded-listname> {deny|permit}
{.<line>|.<AS:NN>|.<ip-address>}

no ip extcommunity-list expanded <expanded-listname>
{deny|permit} {.<line>|.<AS:NN>|.<ip-address>}

no ip extcommunity-list <100-199>

no ip extcommunity-list expanded <expanded-listname>
```

| Parameter           | Description                                                                                                                                                                                       |
|---------------------|---------------------------------------------------------------------------------------------------------------------------------------------------------------------------------------------------|
| <100-199>           | Expanded extcommunity list number.                                                                                                                                                                |
| expanded            | Specifies an expanded extcommunity list.                                                                                                                                                          |
| <expanded-listname> | Expanded extcommunity list entry.                                                                                                                                                                 |
| deny                | Specifies the extcommunity to reject.                                                                                                                                                             |
| permit              | Specifies the extcommunity to accept.                                                                                                                                                             |
| .<line>             | Specifies extcommunity attributes with regular expression.                                                                                                                                        |
| <AS:NN>             | Specifies the valid value for an extcommunity number. This format represents the 32 bit extcommunities value, where AA is the high order 16 bits and NN is the low order 16 bits in digit format. |
| <ip-address>        | Specifies the IP address to deny or permit.                                                                                                                                                       |

Regular expressions listed below are used with the **ip extcommunity-list expanded** command:

| Symbol | Character   | Meaning                                                                                                                            |
|--------|-------------|------------------------------------------------------------------------------------------------------------------------------------|
| ^      | Caret       | Used to match the beginning of the input string. When used at the beginning of a string of characters, it negates a pattern match. |
| \$     | Dollar sign | Used to match the end of the input string.                                                                                         |

| Symbol | Character     | Meaning                                                                                         |
|--------|---------------|-------------------------------------------------------------------------------------------------|
| .      | Period        | Used to match a single character (white spaces included).                                       |
| *      | Asterisk      | Used to match none or more sequences of a pattern.                                              |
| +      | Plus sign     | Used to match one or more sequences of a pattern.                                               |
| ?      | Question mark | Used to match none or one occurrence of a pattern.                                              |
| _      | Underscore    | Used to match spaces, commas, braces, parenthesis, or the beginning and end of an input string. |
| [ ]    | Brackets      | Specifies a range of single-characters.                                                         |
| -      | Hyphen        | Separates the end points of a range.                                                            |

**Mode** Global Configuration

**Examples**

```
awplus# configure terminal
awplus(config)# ip extcommunity-list 125 permit 4567335
awplus(config)# ip extcommunity-list expanded CLIST permit .*
```

**Related Commands** [ip extcommunity-list standard](#)  
[show ip extcommunity-list](#)

# ip extcommunity-list standard

**Overview** Use this command to create and delete a standard extended community list.

Use the **no** variant of this command to delete a standard extended community-list entry.

**Syntax**

```
ip extcommunity-list <1-99> {deny|permit} {rt|soo}
<community-number>

ip extcommunity-list standard <standard-listname> {deny|permit}
{rt|soo} <community-number>

no ip extcommunity-list <1-99> [{deny|permit} {rt|soo}
<community-number>]

no ip extcommunity-list standard <standard-listname>
[{{deny|permit} {rt|soo} <community-number>}]
```

| Parameter           | Description                                                                                                                                                                                                                                                                                                                                                                                                                                                                                                                                                                                          |
|---------------------|------------------------------------------------------------------------------------------------------------------------------------------------------------------------------------------------------------------------------------------------------------------------------------------------------------------------------------------------------------------------------------------------------------------------------------------------------------------------------------------------------------------------------------------------------------------------------------------------------|
| <1-99>              | Standard extcommunity list number.                                                                                                                                                                                                                                                                                                                                                                                                                                                                                                                                                                   |
| standard            | Specifies a standard extended community list.                                                                                                                                                                                                                                                                                                                                                                                                                                                                                                                                                        |
| <standard-listname> | Standard extended community list entry.                                                                                                                                                                                                                                                                                                                                                                                                                                                                                                                                                              |
| deny                | Specifies the extended community to reject.                                                                                                                                                                                                                                                                                                                                                                                                                                                                                                                                                          |
| permit              | Specifies the extended community to accept.                                                                                                                                                                                                                                                                                                                                                                                                                                                                                                                                                          |
| rt                  | Specifies the route target of the extended community.                                                                                                                                                                                                                                                                                                                                                                                                                                                                                                                                                |
| soo                 | Specifies the site of origin of the extended community.                                                                                                                                                                                                                                                                                                                                                                                                                                                                                                                                              |
| <community-number>  | Specifies the valid value for an extended community number.<br>This can be one of two formats: <ul style="list-style-type: none"><li>• &lt;ASN:NN&gt; where ASN is an AS (Autonomous System) number and NN is a value chosen by the ASN administrator</li><li>• &lt;A.B.C.D:NN&gt; where A.B.C.D is an IPv4 address, and NN is a value chosen by the ASN administrator.</li></ul> Note that ASN and NN are both integers from 1 to 4294967295.<br>AS numbers are assigned to the regional registries by IANA ( <a href="http://www.iana.org">www.iana.org</a> ) and must be obtained in your region. |

**Mode** Global Configuration

**Examples**

```
awplus# configure terminal
awplus(config)# ip extcommunity-list 36 permit rt 5675:50
awplus(config)# ip extcommunity-list standard CLIST permit soo
7645:70
awplus# configure terminal
awplus(config)# ip extcommunity-list 36 deny rt 192.168.1.1:70
awplus(config)# ip extcommunity-list standard CLIST deny soo
10.10.1.1:50
```

**Related  
Commands**

- [ip extcommunity-list expanded](#)
- [show ip extcommunity-list](#)



# ip prefix-list (IPv4 Prefix List)

**Overview** Use this command to create an entry for an IPv4 prefix list.

Use the **no** variant of this command to delete the IPv4 prefix-list entry.

**Syntax**

```
ip prefix-list <list-name> [seq <1-429496725>] {deny|permit}
{any|<ip-prefix>} [ge <0-32>] [le <0-32>]

ip prefix-list <list-name> description <text>

ip prefix-list sequence-number

no ip prefix-list <list-name> [seq <1-429496725>]

no ip prefix-list <list-name> [description <text>]

no ip prefix-list sequence-number
```

| Parameter          | Description                                                                                          |
|--------------------|------------------------------------------------------------------------------------------------------|
| <list-name>        | Specifies the name of a prefix list.                                                                 |
| seq <1-429496725>  | Sequence number of the prefix list entry.                                                            |
| deny               | Specifies that the prefixes are excluded from the list.                                              |
| permit             | Specifies that the prefixes are included in the list.                                                |
| <ip-prefix>        | Specifies the IPv4 address and length of the network mask in dotted decimal in the format A.B.C.D/M. |
| any                | Any prefix match. Same as <b>0.0.0.0 le 32</b> .                                                     |
| ge <0-32>          | Specifies the minimum prefix length to be matched.                                                   |
| le <0-32>          | Specifies the maximum prefix length to be matched.                                                   |
| description <text> | Text description of the prefix list.                                                                 |
| sequence-number    | Specify sequence numbers included or excluded in prefix list.                                        |

**Mode** Global Configuration

**Usage** When the device processes a prefix list, it starts to match prefixes from the top of the prefix list, and stops whenever a permit or deny occurs. To promote efficiency, use the **seq** parameter and place common permits or denials towards the top of the list. If you do not use the **seq** parameter, the sequence values are generated in a sequence of 5.

The parameters **ge** and **le** specify the range of the prefix lengths to be matched. When setting these parameters, set the **le** value to be less than 32, and the **ge** value to be less than or equal to the **le** value and greater than the ip-prefix mask length.

Prefix lists implicitly exclude prefixes that are not explicitly permitted in the prefix list. This means if a prefix that is being checked against the prefix list reaches the end of the prefix list without matching a permit or deny, this prefix will be denied.

**Example** In the below sample configuration, the last `ip prefix-list` command in the below list matches all, and the first `ip prefix-list` command denies the IP network 76.2.2.0:

```
awplus(config)# router bgp 100
awplus(config-router)# network 172.1.1.0
awplus(config-router)# network 172.1.2.0
awplus(config-router)# neighbor 10.6.5.3 remote-as 300
awplus(config-router)# neighbor 10.6.5.3 prefix-list mylist out
awplus(config-router)# exit
awplus(config)# ip prefix-list mylist seq 5 deny 76.2.2.0/24
awplus(config)# ip prefix-list mylist seq 100 permit any
```

**Related Commands** [ipv6 prefix-list \(IPv6 Prefix List\)](#)  
[show ip prefix-list \(IPv4 Prefix List\)](#)

# ipv6 prefix-list (IPv6 Prefix List)

**Overview** Use this command to create an IPv6 prefix list or an entry in an existing prefix list. Use the **no** variant of this command to delete a whole prefix list or a prefix list entry.

**Syntax**

```
ipv6 prefix-list <list-name> [seq <1-429496725>] {deny|permit}
{any|<ipv6-prefix>} [ge <0-128>] [le <0-128>]

ipv6 prefix-list <list-name> description <text>

no ipv6 prefix-list <list-name> [seq <1-429496725>]

no ipv6 prefix-list <list-name> [description <text>]
```

| Parameter         | Description                                                                          |
|-------------------|--------------------------------------------------------------------------------------|
| <list-name>       | Specifies the name of a prefix list.                                                 |
| seq <1-429496725> | Sequence number of the prefix list entry.                                            |
| deny              | Specifies that the prefixes are excluded from the list.                              |
| permit            | Specifies that the prefixes are included in the list.                                |
| <ipv6-prefix>     | Specifies the IPv6 prefix and prefix length in hexadecimal in the format X:X::X:X/M. |
| any               | Any prefix match. Same as ::0/0 le 128.                                              |
| ge <0-128>        | Specifies the minimum prefix length to be matched.                                   |
| le <0-128>        | Specifies the maximum prefix length to be matched.                                   |
| description       | Prefix list specific description.                                                    |
| <text>            | Up to 80 characters of text description of the prefix list.                          |

**Mode** Global Configuration

**Usage** When the device processes a prefix list, it starts to match prefixes from the top of the prefix list, and stops whenever a permit or deny occurs. To promote efficiency, use the **seq** parameter and place common permits or denials towards the top of the list. If you do not use the **seq** parameter, the sequence values are generated in a sequence of 5.

The parameters **ge** and **le** specify the range of the prefix lengths to be matched. The parameters **ge** and **le** are only used if an **ip-prefix** is stated. When setting these parameters, set:

- the **le** value to be less than 128, and
- the **ge** value to be less than or equal to the **le** value, and greater than the **ip-prefix** mask length.

Prefix lists implicitly exclude prefixes that are not explicitly permitted in the prefix list. This means if a prefix that is being checked against the prefix list reaches the end of the prefix list without matching a permit or deny, this prefix will be denied.

**Example** To check the first 32 bits of the prefix 2001:db8:: and the subnet mask must be greater than or equal to 34 and less than or equal to 40, enter the following commands:

```
awplus# configure terminal
awplus(config)# ipv6 prefix-list mylist seq 12345 permit
2001:db8::/32 ge 34 le 40
```

**Related Commands** [ip prefix-list \(IPv4 Prefix List\)](#)  
[show ipv6 prefix-list \(IPv6 Prefix List\)](#)

# match as-path

**Overview** Use this command to add an autonomous system (AS) path match clause to a route map entry. Specify the AS path attribute value or values to match by specifying the name of an AS path access list.

A BGP update message matches the route map if its attributes include AS path values that match the AS path access list.

Each entry of a route map can only match against one AS path access list in one AS path match clause. If the route map entry already has an AS path match clause, entering this command replaces that match clause with the new clause.

Note that AS path access lists and route map entries both specify an action of deny or permit. The action in the AS path access list determines whether the route map checks update messages for a given AS path value. The route map action and its **set** clauses determine what the route map does with update messages that contain that AS path value.

Use the **no** variant of this command to remove the AS path match clause from a route map entry.

**Syntax** `match as-path <as-path-listname>`  
`no match as-path [<as-path-listname>]`

| Parameter                             | Description                            |
|---------------------------------------|----------------------------------------|
| <code>&lt;as-path-listname&gt;</code> | Specifies an AS path access list name. |

**Mode** Route-map Configuration

**Usage** This command is valid for BGP update messages only.

**Example** To add entry 34 to the route map called `myroute`, which will discard update messages if they contain the AS path values that are included in `myaccesslist`, use the commands:

```
awplus# configure terminal
awplus(config)# route-map myroute deny 34
awplus(config-route-map)# match as-path myaccesslist
```

**Related Commands**

- [route-map](#)
- [set as-path](#)
- [show route-map](#)

# match community

**Overview** Use this command to add a community match clause to a route map entry. Specify the community value or values to match by specifying a community list. To create the community list, enter Global Configuration mode and use the [ip community-list](#) command.

A BGP update message matches the route map if its attributes include community values that match the community list.

Each entry of a route map can only match against one community list in one community match clause. If the route map entry already has a community match clause, entering this command replaces that match clause with the new clause.

Note that community lists and route map entries both specify an action of deny or permit. The action in the community list determines whether the route map checks update messages for a given community value. The route map action and its **set** clauses determine what the route map does with update messages that contain that community value.

Use the **no** variant of this command to remove the community match clause from a route map.

**Syntax**

```
match community
{<community-listname>|<1-99>|<100-199>} [exact-match]

no match community
[<community-listname>|<1-99>|<100-199>|exact-match]
```

| Parameter            | Description                             |
|----------------------|-----------------------------------------|
| <community-listname> | The community list name or number.      |
| <1-99>               | Community list number (standard range). |
| <100-199>            | Community list number (expanded range). |
| exact-match          | Exact matching of communities.          |

**Mode** Route-map Configuration

**Usage** This command is valid for BGP update messages only.

Communities are used to group and filter routes. They are designed to provide the ability to apply policies to large numbers of routes by using match and set commands. Community lists are used to identify and filter routes by their common attributes.

**Example** To add entry 3 to the route map called `myroute`, which will process update messages if they contain the community values that are included in `mylist`, use the commands:

```
awplus# configure terminal
awplus(config)# route-map myroute permit 3
awplus(config-route-map)# match community mylist
```

**Related  
Commands**

- `ip community-list`
- `route-map`
- `set comm-list delete`
- `set community`
- `show route-map`

# max-paths

**Overview** Use this command to set the number of equal-cost multi-path (ECMP) routes for eBGP or iBGP. You can install multiple BGP paths to the same destination to balance the load on the forwarding path.

Use the **no** variant of this command to disable this feature.

**Syntax** max-paths {ebgp|ibgp} <2-64>  
no max-paths ebgp [<2-64>]  
no max-paths ibgp [<2-64>]

| Parameter | Description                     |
|-----------|---------------------------------|
| ebgp      | eBGP ECMP session.              |
| ibgp      | iBGP ECMP session.              |
| <2-64>    | Specifies the number of routes. |

**Mode** Global Configuration

**Usage** This command is available for the default BGP instance and for IPV4 and IPv6 unicast addresses.

**Example** awplus# configure terminal  
awplus(config)# router bgp 64501  
awplus(config-router)# max-paths ebgp 2

**Related commands** [show ip route summary](#)



# neighbor activate

**Overview** Use this command to enable the exchange of BGP IPv4 and BGP4+ IPv6 routes with a neighboring router, and also within either an IPv4 or an IPv6 specific address-family.

Use the **no** variant of this command to disable the exchange of information with a BGP or BGP4+ neighbor, in the Router Configuration or the Address Family Configuration mode.

**Syntax** neighbor <neighborid> activate  
no neighbor <neighborid> activate

| Parameter    | Description                                                                                                                                                                                                                                                                                                                |
|--------------|----------------------------------------------------------------------------------------------------------------------------------------------------------------------------------------------------------------------------------------------------------------------------------------------------------------------------|
| <neighborid> | { <ip-address>   <ipv6-addr>   <peer-group> }                                                                                                                                                                                                                                                                              |
| <ip-address> | Specify the address of an IPv4 BGP neighbor, in dotted decimal notation A.B.C.D.                                                                                                                                                                                                                                           |
| <ipv6-addr>  | Specify the address of an IPv6 BGP4+ neighbor, entered in hexadecimal in the format X:X::X:X.                                                                                                                                                                                                                              |
| <peer-group> | Enter the name of an existing peer-group. For information on how to create peer groups, refer to the <a href="#">neighbor peer-group (add a neighbor)</a> command, and <a href="#">neighbor route-map</a> command. When this parameter is used with this command, the command applies on all peers in the specified group. |

**Mode [BGP]** Router Configuration or IPv4 Address Family Configuration

**Mode [BGP4+]** IPv6 Address Family Configuration

**Usage [BGP]** Use this command to enable the exchange of information to a neighbor. To exchange IPv4 or IPv6 prefixes with a BGP or a BGP4+ peer, you must configure this command for the peer or the peer group. This command only enables the exchange of information. You can establish peering without this command, but no prefixes and other information is sent until you apply this command to the neighbor.

This command triggers the device to start a BGP or BGP4+ peering relationship with the specified BGP or BGP4+ neighbor and start exchanging routes with that neighbor.

The command is required for neighbors configured in Address-Family Configuration mode, but it is not required in Router Configuration mode (that is, it does not affect the device's behavior).

**Examples [BGP]** To enable an exchange of routes with a neighboring router with the IPv4 address 10.10.10.1, enter the commands as shown below:

```
awplus# configure terminal
awplus(config)# router bgp 10
awplus(config-router)# neighbor 10.10.10.1 activate
```

To disable an exchange of routes with a neighboring router with the IPv4 address 10.10.10.1, enter the commands as shown below:

```
awplus# configure terminal
awplus(config)# router bgp 10
awplus(config-router)# no neighbor 10.10.10.1 activate
```

To enable an exchange of routes in Address Family Configuration mode with a neighboring router with the IPv4 address 10.10.10.1, enter the commands as shown below:

```
awplus# configure terminal
awplus(config)# router bgp 10
awplus(config-router)# address-family ipv4
awplus(config-router-af)# neighbor 10.10.10.1 activate
```

To disable an exchange of routes in Address Family Configuration mode with a neighboring router with the IPv4 address 10.10.10.1, enter the commands as shown below:

```
awplus# configure terminal
awplus(config)# router bgp 10
awplus(config-router)# address-family ipv4
awplus(config-router-af)# no neighbor 10.10.10.1 activate
```

To enable an exchange of routes with a neighboring router with the peer-group named group1, enter the commands as shown below:

```
awplus# configure terminal
awplus(config)# router bgp 10
awplus(config-router)# neighbor group1 peer-group
awplus(config-router)# neighbor 10.10.0.63 remote-as 10
awplus(config-router)# neighbor 10.10.0.63 peer-group group1
awplus(config-router)# neighbor group1 activate
```

To disable an exchange of routes with a neighboring router with the peer-group named group1, enter the commands as shown below:

```
awplus# configure terminal
awplus(config)# router bgp 10
awplus(config-router)# no neighbor group1 activate
```

**Examples** To enable an exchange of routes in IPv6 Address Family Configuration mode with a neighboring router with the IPv6 address 2001:0db8:010d::1, enter the commands as shown below:

**[BGP4+]**

```
awplus# configure terminal
awplus(config)# router bgp 10
awplus(config-router)# address-family ipv6
awplus(config-router-af)# neighbor 2001:0db8:010d::1 activate
```

To disable an exchange of routes in IPv6 Address Family Configuration mode with a neighboring router with the IPv6 address 2001:0db8:010d::1, enter the commands as shown below:

```
awplus# configure terminal
awplus(config)# router bgp 10
awplus(config-router)# address-family ipv6
awplus(config-router-af)# no neighbor 2001:0db8:010d::1
activate
```

To enable an exchange of routes with a neighboring router with the peer-group named group1, enter the commands as shown below:

```
awplus# configure terminal
awplus(config)# router bgp 10
awplus(config-router)# neighbor group1 peer-group
awplus(config-router)# neighbor 2001:0db8:010d::1 remote-as 10
awplus(config-router)# address-family ipv6
awplus(config-router-af)# neighbor 2001:0db8:010d::1
peer-group group1
awplus(config-router-af)# neighbor group1 activate
```

To disable an exchange of routes with a neighboring router with the peer-group named group1, enter the commands as shown below:

```
awplus# configure terminal
awplus(config)# router bgp 10
awplus(config-router)# address-family ipv6
awplus(config-router-af)# no neighbor group1 activate
```

**Related Commands** [neighbor peer-group \(add a neighbor\)](#)  
[neighbor route-map](#)

**Command changes** Version 5.4.6-2.1: VRF-lite support added.

# neighbor advertisement-interval

**Overview** Use this command to set the minimum interval between sending iBGP or eBGP routing updates for a given route. This command reduces the flapping of individual routes.

Use the **no** variant of this command to set the interval time to the default values (30 seconds for eBGP peers and 5 seconds for iBGP peers) for a given route.

**Syntax** `neighbor <neighborid> advertisement-interval <time>`  
`no neighbor <neighborid> advertisement-interval [<time>]`

| Parameter                       | Description                                                                                                                                                                                                                                                                                                                                                                                                                                       |
|---------------------------------|---------------------------------------------------------------------------------------------------------------------------------------------------------------------------------------------------------------------------------------------------------------------------------------------------------------------------------------------------------------------------------------------------------------------------------------------------|
| <code>&lt;neighborid&gt;</code> | { <code>&lt;ip-address&gt;</code>   <code>&lt;ipv6-addr&gt;</code>   <code>&lt;peer-group&gt;</code> }                                                                                                                                                                                                                                                                                                                                            |
| <code>&lt;ip-address&gt;</code> | Specify the address of an IPv4 BGP neighbor, in dotted decimal notation A.B.C.D.                                                                                                                                                                                                                                                                                                                                                                  |
| <code>&lt;ipv6-addr&gt;</code>  | Specify the address of an IPv6 BGP4+ neighbor, entered in hexadecimal in the format X:X::X:X.                                                                                                                                                                                                                                                                                                                                                     |
| <code>&lt;peer-group&gt;</code> | Enter the name of an existing peer-group. For information on how to create peer groups, refer to the <a href="#">neighbor peer-group (add a neighbor)</a> command, and <a href="#">neighbor route-map</a> command. When this parameter is used with this command, the command applies on all peers in the specified group. Note that if you apply an advertisement-interval value to a peer group it will apply to all members in the peer group. |
| <code>&lt;time&gt;</code>       | <code>&lt;0-600&gt;</code> Advertisement -interval value in seconds.                                                                                                                                                                                                                                                                                                                                                                              |

**Default** The default interval between sending routing updates for a given route to eBGP peers is 30 seconds, and the default interval for a given route to iBGP peers is 5 seconds.

**Mode** Router Configuration

**Usage** Use this command to set the minimum interval between sending iBGP or eBGP routing updates for a given route. To reduce the flapping of routes to the internet, set a minimum advertisement interval, so iBGP or eBGP routing updates are sent per interval seconds.

BGP dampening can also be used to control the effects of flapping routes. See the [bgp dampening](#) command in this chapter, and the [Routing\\_Protocol Guide](#) for more information.

The advertisement-interval time value is the minimum time between the advertisement of Update messages sent from a BGP speaker to report changes to

eBGP or iBGP peers. This is the minimum time between two Update messages sent to iBGP or eBGP peers.

See the [neighbor as-origination-interval](#) command to set the interval time between messages to iBGP peers, which have prefixes within the local AS. Use this command instead of the [neighbor as-origination-interval](#) command for eBGP peers with prefixes not in the same AS and updates not in a local AS.

### Examples [BGP]

```
awplus# configure terminal
awplus(config)# router bgp 10
awplus(config-router)# neighbor 10.10.0.3
advertisement-interval 45
awplus# configure terminal
awplus(config)# router bgp 10
awplus(config-router)# no neighbor 10.10.0.3
advertisement-interval
awplus# configure terminal
awplus(config)# router bgp 10
awplus(config-router)# neighbor group1 peer-group
awplus(config-router)# neighbor 10.10.0.3 remote-as 10
awplus(config-router)# neighbor 10.10.0.3 peer-group group1
awplus(config-router)# neighbor group1 advertisement-interval
45
awplus# configure terminal
awplus(config)# router bgp 10
awplus(config-router)# no neighbor group1
advertisement-interval
```

**Examples**  
**[BGP4+]**

```
awplus# configure terminal
awplus(config)# router bgp 10
awplus(config-router)# neighbor 2001:0db8:010d::1
advertisement-interval 45
awplus# configure terminal
awplus(config)# router bgp 10
awplus(config-router)# no neighbor 2001:0db8:010d::1
advertisement-interval
awplus# configure terminal
awplus(config)# router bgp 10
awplus(config-router)# neighbor group1 peer-group
awplus(config-router)# neighbor 2001:0db8:010d::1 remote-as 10
awplus(config-router)# address-family ipv6
awplus(config-router-af)# neighbor 2001:0db8:010d::1
peer-group group1
awplus(config-router-af)# neighbor group1
advertisement-interval 45
awplus# configure terminal
awplus(config)# router bgp 10
awplus(config-router)# address-family ipv6
awplus(config-router-af)# no neighbor group1
advertisement-interval
```

**Related**  
**Commands**

- [neighbor as-origination-interval](#)
- [neighbor peer-group \(add a neighbor\)](#)
- [neighbor route-map](#)
- [show bgp ipv6 neighbors \(BGP4+ only\)](#)
- [show ip bgp neighbors \(BGP only\)](#)

# neighbor allowas-in

**Overview** Use this command to accept an AS\_PATH with the specified Autonomous System (AS) number from inbound updates for both BGP and BGP4+ routes.

This command allows BGP and BGP4+ to accept prefixes with the same ASN in the AS\_PATH attribute. This command allows BGP and BGP4+ to accept up to 10 instances, configured by the *<occurrences>* placeholder, of its own AN in the AS\_PATH for a prefix.

Use the **no** variant of this command to revert to default functionality (disabled by default).

**Syntax** `neighbor <neighborid> allowas-in <occurrences>`  
`no neighbor <neighborid> allowas-in`

| Parameter                  | Description                                                                                                                                                                                                                                                                                                                |
|----------------------------|----------------------------------------------------------------------------------------------------------------------------------------------------------------------------------------------------------------------------------------------------------------------------------------------------------------------------|
| <i>&lt;neighborid&gt;</i>  | { <i>&lt;ip-address&gt;</i>   <i>&lt;ipv6-addr&gt;</i>   <i>&lt;peer-group&gt;</i> }                                                                                                                                                                                                                                       |
| <i>&lt;ip-address&gt;</i>  | Specify the address of an IPv4 BGP neighbor, in dotted decimal notation A.B.C.D.                                                                                                                                                                                                                                           |
| <i>&lt;ipv6-addr&gt;</i>   | Specify the address of an IPv6 BGP4+ neighbor, entered in hexadecimal in the format X:X::X:X.                                                                                                                                                                                                                              |
| <i>&lt;peer-group&gt;</i>  | Enter the name of an existing peer-group. For information on how to create peer groups, refer to the <a href="#">neighbor peer-group (add a neighbor)</a> command, and <a href="#">neighbor route-map</a> command. When this parameter is used with this command, the command applies on all peers in the specified group. |
| <i>&lt;occurrences&gt;</i> | <i>&lt;1-10&gt;</i> Specifies the number of occurrences of the AS number.                                                                                                                                                                                                                                                  |

**Default** Disabled

**Mode [BGP]** Router Configuration or IPv4 Address Family Configuration

**Mode [BGP4+]** IPv6 Address Family Configuration

**Usage** Use this command to configure PE (Provider Edge) routers to allow re-advertisement of all prefixes containing duplicate Autonomous System Numbers (ASNs). In a hub and spoke configuration, a PE router re-advertises all prefixes containing duplicate ASNs. Specify the remote-as or peer-group first using the related commands. The command allows a receiving peer to accept prefixes with its own AN in the AS\_PATH, up to the maximum number of instances, as configured by the *<occurrences>* placeholder.

**Examples [BGP]**

```
awplus# configure terminal
awplus(config)# router bgp 10
awplus(config-router)# neighbor 10.10.0.1 allowas-in 3
awplus# configure terminal
awplus(config)# router bgp 10
awplus(config-router)# address-family ipv4
awplus(config-router-af)# neighbor 10.10.0.1 allowas-in 3
awplus# configure terminal
awplus(config)# router bgp 10
awplus(config-router)# no neighbor 10.10.0.1 allowas-in
awplus# configure terminal
awplus(config)# router bgp 10
awplus(config-router)# address-family ipv4
awplus(config-router-af)# no neighbor 10.10.0.1 allowas-in
awplus# configure terminal
awplus(config)# router bgp 10
awplus(config-router)# neighbor group1 peer-group
awplus(config-router)# neighbor 10.10.0.1 remote-as 10
awplus(config-router)# neighbor 10.10.0.1 peer-group group1
awplus(config-router)# neighbor group1 allowas-in 3
awplus# configure terminal
awplus(config)# router bgp 10
awplus(config-router)# address-family ipv4
awplus(config-router-af)# neighbor group1 allowas-in 3
```



**Examples**  
**[BGP4+]**

```
awplus# configure terminal
awplus(config)# router bgp 10
awplus(config-router)# address-family ipv6
awplus(config-router-af)# neighbor 2001:0db8:010d::1
allowas-in 3
awplus# configure terminal
awplus(config)# router bgp 10
awplus(config-router)# address-family ipv6
awplus(config-router-af)# no neighbor 2001:0db8:010d::1
allowas-in
awplus# configure terminal
awplus(config)# router bgp 10
awplus(config-router)# neighbor group1 peer-group
awplus(config-router)# neighbor 2001:0db8:010d::1 remote-as 10
awplus(config-router)# address-family ipv6
awplus(config-router-af)# neighbor 2001:0db8:010d::1
peer-group group1
awplus(config-router-af)# neighbor group1 allowas-in 3
awplus# configure terminal
awplus(config)# router bgp 10
awplus(config-router)# address-family ipv6
awplus(config-router-af)# neighbor group1 allowas-in 3
```

**Related**  
**Commands**

- [neighbor peer-group \(add a neighbor\)](#)
- [neighbor route-map](#)

# neighbor as-origination-interval

**Overview** Use this command to adjust the sending of AS (Autonomous System) origination routing updates to a specified iBGP peer. This command adjusts the rate at which updates are sent to a specified iBGP peer (15 seconds by default). You must set a rate when you enable it.

The as-origination-interval is the minimum time set between the advertisement of Update messages sent from a BGP speaker to an iBGP peer to report changes within the local AS.

Use the **no** variant of this command to reset the timer to the default value of 15 seconds.

**Syntax [BGP]** neighbor <neighbor\_address> as-origination-interval <time>  
no neighbor <neighbor\_address> as-origination-interval [<time>]

**Syntax [BGP4+]** neighbor <ipv6-addr> as-origination-interval <time>  
no neighbor <ipv6-addr> as-origination-interval [<time>]

| Parameter          | Description                                                                                 |
|--------------------|---------------------------------------------------------------------------------------------|
| <neighbor_address> | Specify a neighbor IPv4 address, in dotted decimal in the format A.B.C.D.                   |
| <ipv6-addr>        | Specify an address of an IPv6 BGP4+ neighbor, entered in hexadecimal in the format X::X::X. |
| <time>             | <1-600> Time in seconds.                                                                    |

**Default** The default interval between sending routing updates to iBGP peers, which include a prefix that originates from the local AS, is 15 seconds by default.

**Mode** Router Configuration

**Usage** This command is used to change the minimum interval between sending AS-origination routing updates. The update interval for iBGP peers can be set from 1 to 600 seconds.

For interoperability with other vendors' devices, we recommend using the default value. The AS origination interval timer may not be available to adjust on other vendors' devices. Applying the default of 15 seconds across the AS maintains a common timer policy.

AlliedWare Plus devices use the default 15 second AS Origination Interval timer as per RFC 4271, a 30 second keepalive timer, a 90 second hold timer, a 120 second connect timer, a 5 second iBGP peer route advertisement interval, and a 30 second eBGP peer route advertisement interval.

Cisco devices use a 60 second keepalive timer, a 180 second hold timer, and no iBGP peer route interval timer (0). Juniper devices use a 10 second AS Origination Interval timer.

The as-origination-interval time value is the minimum amount of time between the advertisement of Update messages sent from a BGP speaker to report changes within the local AS. This is the minimum time between two Update messages to iBGP peers, which contain a prefix that originates from the same AS. See the [neighbor advertisement-interval](#) command to set time between messages to eBGP peers.

Use this command instead of the [neighbor advertisement-interval](#) command for iBGP peers with prefixes in the same AS for updates only within a local AS.

**Examples [BGP]**

```
awplus# configure terminal
awplus(config)# router bgp 100
awplus(config-router)# neighbor 10.10.0.1
as-origination-interval 10
awplus# configure terminal
awplus(config)# router bgp 100
awplus(config-router)# no neighbor 10.10.0.1
as-origination-interval
```

**Examples [BGP4+]**

```
awplus# configure terminal
awplus(config)# router bgp 100
awplus(config-router)# neighbor 2001:0db8:010d::1
as-origination-interval 10
awplus# configure terminal
awplus(config)# router bgp 100
awplus(config-router)# no neighbor 2001:0db8:010d::1
as-origination-interval
```

**Validation Commands**

- [show bgp ipv6 neighbors \(BGP4+ only\)](#)
- [show ip bgp neighbors \(BGP only\)](#)

**Related Commands**

- [neighbor advertisement-interval](#)
- [address-family](#)

# neighbor attribute-unchanged

**Overview** Use this command to advertise unchanged BGP or BGP4+ attributes to the specified BGP or BGP4+ neighbor.

Use the **no** variant of this command to disable this function.

**Syntax** `neighbor <neighborid> attribute-unchanged  
{as-path|next-hop|med}`  
`no neighbor <neighborid> attribute-unchanged  
{as-path|next-hop|med}`

| Parameter    | Description                                                                                                                                                                                                                                                                                                                |
|--------------|----------------------------------------------------------------------------------------------------------------------------------------------------------------------------------------------------------------------------------------------------------------------------------------------------------------------------|
| <neighborid> | {<ip-address>   ipv6-addr>   <peer-group>}                                                                                                                                                                                                                                                                                 |
| <ip-address> | Specify the address of an IPv4 BGP neighbor, in dotted decimal notation A.B.C.D.                                                                                                                                                                                                                                           |
| <ipv6-addr>  | Specify the address of an IPv6 BGP4+ neighbor, entered in hexadecimal in the format X:X::X:X.                                                                                                                                                                                                                              |
| <peer-group> | Enter the name of an existing peer-group. For information on how to create peer groups, refer to the <a href="#">neighbor peer-group (add a neighbor)</a> command, and <a href="#">neighbor route-map</a> command. When this parameter is used with this command, the command applies on all peers in the specified group. |
| as-path      | AS path attribute.                                                                                                                                                                                                                                                                                                         |
| next-hop     | Next hop attribute.                                                                                                                                                                                                                                                                                                        |
| med          | Multi Exit Discriminator.                                                                                                                                                                                                                                                                                                  |

**Mode [BGP]** Router Configuration or IPv4 Address Family Configuration

**Mode [BGP4+]** IPv6 Address Family Configuration

**Usage** Note that specifying this command with the optional **as-path** parameter has the same effect as invoking the [neighbor transparent-as](#) command.

Note this specifying this command with the optional **next-hop** parameter has the same effect as invoking the [neighbor transparent-next-hop](#) command.

**Examples [BGP]**

```
awplus# configure terminal
awplus(config)# router bgp 10
awplus(config-router)# neighbor 10.10.0.75 attribute-unchanged
as-path med
awplus# configure terminal
awplus(config)# router bgp 10
awplus(config-router)# no neighbor 10.10.0.75
attribute-unchanged as-path med
awplus# configure terminal
awplus(config)# router bgp 10
awplus(config-router)# address-family ipv4
awplus(config-router-af)# neighbor 10.10.0.75
attribute-unchanged as-path med
awplus# configure terminal
awplus(config)# router bgp 10
awplus(config-router)# address-family ipv4
awplus(config-router-af)# no neighbor 10.10.0.75
attribute-unchanged as-path med
awplus# configure terminal
awplus(config)# router bgp 10
awplus(config-router)# neighbor group1 peer-group
awplus(config-router)# neighbor 10.10.0.75 remote-as 10
awplus(config-router)# neighbor 10.10.0.75 peer-group group1
awplus(config-router)# neighbor group1 attribute-unchanged
as-path med
awplus# configure terminal
awplus(config)# router bgp 10
awplus(config-router)# no neighbor group1 attribute-unchanged
as-path med
```

**Examples**  
**[BGP4+]**

```
awplus# configure terminal
awplus(config)# router bgp 10
awplus(config-router)# address-family ipv6
awplus(config-router-af)# neighbor 2001:0db8:010d::1
attribute-unchanged as-path med
awplus# configure terminal
awplus(config)# router bgp 10
awplus(config-router)# address-family ipv6
awplus(config-router-af)# no neighbor 2001:0db8:010d::1
attribute-unchanged as-path med
awplus# configure terminal
awplus(config)# router bgp 10
awplus(config-router)# neighbor group1 peer-group
awplus(config-router)# neighbor 2001:0db8:010d::1 remote-as 10
awplus(config-router)# address-family ipv6
awplus(config-router-af)# neighbor 2001:0db8:010d::1
peer-group group1
awplus(config-router-af)# neighbor group1 attribute-unchanged
as-path med
awplus# configure terminal
awplus(config)# router bgp 10
awplus(config-router)# address-family ipv6
awplus(config-router-af)# no neighbor group1
attribute-unchanged as-path med
```

**Related**  
**Commands**

- [neighbor peer-group \(add a neighbor\)](#)
- [neighbor route-map](#)
- [neighbor transparent-as](#)
- [neighbor transparent-nexthop](#)

# neighbor capability graceful-restart

**Overview** Use this command to configure the device to advertise the Graceful Restart Capability to BGP and BGP4+ neighbors.

Use the **no** variant of this command to configure the device so it does not advertise the Graceful Restart Capability to its neighbor.

**Syntax** `neighbor <neighborid> capability graceful-restart`  
`no neighbor <neighborid> capability graceful-restart`

| Parameter    | Description                                                                                                                                                                                                                                                                                                                |
|--------------|----------------------------------------------------------------------------------------------------------------------------------------------------------------------------------------------------------------------------------------------------------------------------------------------------------------------------|
| <neighborid> | { <ip-address>   <ipv6-addr>   <peer-group> }                                                                                                                                                                                                                                                                              |
| <ip-address> | Specify the address of an IPv4 BGP neighbor, in dotted decimal notation A.B.C.D.                                                                                                                                                                                                                                           |
| <ipv6-addr>  | Specify the address of an IPv6 BGP4+ neighbor, entered in hexadecimal in the format X:X::X:X.                                                                                                                                                                                                                              |
| <peer-group> | Enter the name of an existing peer-group. For information on how to create peer groups, refer to the <a href="#">neighbor peer-group (add a neighbor)</a> command, and <a href="#">neighbor route-map</a> command. When this parameter is used with this command, the command applies on all peers in the specified group. |

**Default** Disabled

**Mode [BGP]** Router Configuration or IPv4 Address Family Configuration

**Mode [BGP4+]** IPv6 Address Family Configuration

**Usage** Use the **neighbor capability graceful-restart** command to advertise to the BGP or BGP4+ neighbor routers the capability of graceful restart. First specify the BGP or BGP4+ neighbor's **remote-as** identification number as assigned by the neighbor router.

The graceful restart capability is advertised only when the graceful restart capability has been enabled using the [bgp graceful-restart](#) command.

**Examples [BGP]**

```
awplus# configure terminal
awplus(config)# router bgp 10
awplus(config-router)# neighbor 10.10.10.50 capability
graceful-restart
awplus# configure terminal
awplus(config)# router bgp 10
awplus(config-router)# no neighbor 10.10.10.50 capability
graceful-restart
awplus# configure terminal
awplus(config)# router bgp 10
awplus(config-router)# address-family ipv4
awplus(config-router-af)# neighbor 10.10.10.50 capability
graceful-restart
awplus# configure terminal
awplus(config)# router bgp 10
awplus(config-router)# address-family ipv4
awplus(config-router-af)# no neighbor 10.10.10.50 capability
graceful-restart
awplus# configure terminal
awplus(config)# router bgp 10
awplus(config-router)# neighbor group1 peer-group
awplus(config-router)# neighbor 10.10.10.50 remote-as 10
awplus(config-router)# neighbor 10.10.10.50 peer-group group1
awplus(config-router)# neighbor group1 capability
graceful-restart
awplus# configure terminal
awplus(config)# router bgp 10
awplus(config-router)# no neighbor group1 capability
graceful-restart
```



**Examples**  
**[BGP4+]**

```
awplus# configure terminal
awplus(config)# router bgp 10
awplus(config-router)# address-family ipv6
awplus(config-router-af)# neighbor 2001:0db8:010d::1
capability graceful-restart
awplus# configure terminal
awplus(config)# router bgp 10
awplus(config-router)# address-family ipv6
awplus(config-router-af)# no neighbor 2001:0db8:010d::1
capability graceful-restart
awplus# configure terminal
awplus(config)# router bgp 10
awplus(config-router)# neighbor group1 peer-group
awplus(config-router)# neighbor 2001:0db8:010d::1 remote-as 10
awplus(config-router)# address-family ipv6
awplus(config-router-af)# neighbor 2001:0db8:010d::1
peer-group group1
awplus(config-router-af)# neighbor group1 capability
graceful-restart
awplus# configure terminal
awplus(config)# router bgp 10
awplus(config-router)# address-family ipv6
awplus(config-router-af)# no neighbor group1 capability
graceful-restart
```

**Related**  
**Commands**

- [bgp graceful-restart](#)
- [neighbor peer-group \(add a neighbor\)](#)
- [neighbor route-map](#)
- [restart bgp graceful \(BGP only\)](#)

# neighbor capability orf prefix-list

**Overview** Use this command to advertise ORF (Outbound Route Filters) capability to neighbors. Use this command to dynamically filter updates. The BGP speaker can advertise a prefix list with prefixes it wishes the peer to prune or filter from outgoing updates.

Use the **no** variant of this command to disable this function.

**Syntax** `neighbor <neighborid> capability orf prefix-list  
{both|receive|send}`  
`no neighbor <neighborid> capability orf prefix-list  
{both|receive|send}`

| Parameter    | Description                                                                                                                                                                                                                                                                                                                |
|--------------|----------------------------------------------------------------------------------------------------------------------------------------------------------------------------------------------------------------------------------------------------------------------------------------------------------------------------|
| <neighborid> | {<ip-address>   <ipv6-addr>   <peer-group> }                                                                                                                                                                                                                                                                               |
| <ip-address> | Specify the address of an IPv4 BGP neighbor, in dotted decimal notation A.B.C.D.                                                                                                                                                                                                                                           |
| <ipv6-addr>  | Specify the address of an IPv6 BGP4+ neighbor, entered in hexadecimal in the format X:X::X:X.                                                                                                                                                                                                                              |
| <peer-group> | Enter the name of an existing peer-group. For information on how to create peer groups, refer to the <a href="#">neighbor peer-group (add a neighbor)</a> command, and <a href="#">neighbor route-map</a> command. When this parameter is used with this command, the command applies on all peers in the specified group. |
| orf          | Advertises ORF capability to its neighbors.                                                                                                                                                                                                                                                                                |
| both         | Indicates that the local router can send ORF entries to its peer as well as receive ORF entries from its peer.                                                                                                                                                                                                             |
| receive      | Indicates that the local router is willing to receive ORF entries from its peer.                                                                                                                                                                                                                                           |
| send         | Indicates that the local router is willing to send ORF entries to its peer.                                                                                                                                                                                                                                                |

**Mode [BGP]** Router Configuration or IPv4 Address Family Configuration

**Mode [BGP4+]** IPv6 Address Family Configuration

**Default** Disabled

**Usage** Outbound Route Filters (ORFs) send and receive capabilities to lessen the number of updates exchanged between neighbors. By filtering updates, this option minimizes generating and processing of updates. The local router advertises the ORF capability in `send` mode and the remote router receives the ORF capability in

**receive** mode applying the filter as outbound policy. The two routers exchange updates to maintain the ORF for each router. Only an individual router or a peer-group can be configured to be in **receive** or **send** mode. A peer-group member cannot be configured in **receive** or **send** mode.

**Examples [BGP]**

```
awplus# configure terminal
awplus(config)# router bgp 10
awplus(config-router)# neighbor 10.10.0.5 capability orf
prefix-list both
awplus# configure terminal
awplus(config)# router bgp 10
awplus(config-router)# no neighbor 10.10.0.5 capability orf
prefix-list both
awplus# configure terminal
awplus(config)# router bgp 10
awplus(config-router)# address-family ipv4
awplus(config-router)# neighbor 10.10.0.5 capability orf
prefix-list both
awplus# configure terminal
awplus(config)# router bgp 10
awplus(config-router)# address-family ipv4
awplus(config-router)# no neighbor 10.10.0.5 capability orf
prefix-list both
awplus# configure terminal
awplus(config)# router bgp 10
awplus(config-router)# neighbor group1 peer-group
awplus(config-router)# neighbor 10.10.0.5 remote-as 10
awplus(config-router)# neighbor 10.10.0.5 peer-group group1
awplus(config-router)# neighbor group1 capability orf
prefix-list both
awplus# configure terminal
awplus(config)# router bgp 10
awplus(config-router)# no neighbor group1 capability orf
prefix-list both
```

**Examples**  
**[BGP4+]**

```
awplus# configure terminal
awplus(config)# router bgp 10
awplus(config-router)# address-family ipv6
awplus(config-router)# neighbor 2001:0db8:010d::1 capability
orf prefix-list both

awplus# configure terminal
awplus(config)# router bgp 10
awplus(config-router)# address-family ipv6
awplus(config-router)# no neighbor 2001:0db8:010d::1 capability
orf prefix-list both

awplus# configure terminal
awplus(config)# router bgp 10
awplus(config-router)# neighbor group1 peer-group
awplus(config-router)# neighbor 2001:0db8:010d::1 remote-as 10
awplus(config-router)# address-family ipv6
awplus(config-router-af)# neighbor 2001:0db8:010d::1
peer-group group1
awplus(config-router-af)# neighbor group1 capability orf
prefix-list both

awplus# configure terminal
awplus(config)# router bgp 10
awplus(config-router)# address-family ipv6
awplus(config-router-af)# no neighbor group1 capability orf
prefix-list both
```

**Related**  
**Commands**

- [neighbor capability orf prefix-list](#)
- [neighbor peer-group \(add a neighbor\)](#)
- [neighbor route-map](#)

# neighbor capability route-refresh

**Overview** Use this command to advertise route-refresh capability to the specified BGP and BGP4+ neighbors.

Use the **no** variant of this command to disable this function

**Syntax** `neighbor <neighborid> capability route-refresh`  
`no neighbor <neighborid> capability route-refresh`

| Parameter    | Description                                                                                                                                                                                                                                                                                                                |
|--------------|----------------------------------------------------------------------------------------------------------------------------------------------------------------------------------------------------------------------------------------------------------------------------------------------------------------------------|
| <neighborid> | {<ip-address>   ipv6-addr>   <peer-group>}                                                                                                                                                                                                                                                                                 |
| <ip-address> | Specify the address of an IPv4 BGP neighbor, in dotted decimal notation A.B.C.D.                                                                                                                                                                                                                                           |
| <ipv6-addr>  | Specify the address of an IPv6 BGP4+ neighbor, entered in hexadecimal in the format X:X::X:X.                                                                                                                                                                                                                              |
| <peer-group> | Enter the name of an existing peer-group. For information on how to create peer groups, refer to the <a href="#">neighbor peer-group (add a neighbor)</a> command, and <a href="#">neighbor route-map</a> command. When this parameter is used with this command, the command applies on all peers in the specified group. |

**Mode** Router Configuration

**Default** Enabled

**Usage** Use this command to advertise to peer about route refresh capability support. If route refresh capability is supported, then router can dynamically request that the peer readvertises its Adj-RIB-Out.

**Examples [BGP]**

```
awplus# configure terminal
awplus(config)# router bgp 10
awplus(config-router)# neighbor 10.10.10.1 capability
route-refresh
awplus# configure terminal
awplus(config)# router bgp 10
awplus(config-router)# no neighbor 10.10.10.1 capability
route-refresh
awplus# configure terminal
awplus(config)# router bgp 10
awplus(config-router)# neighbor group1 peer-group
awplus(config-router)# neighbor 10.10.1.1 remote-as 10
awplus(config-router)# neighbor 10.10.1.1 peer-group group1
awplus(config-router)# neighbor group1 capability route-refresh
awplus# configure terminal
awplus(config)# router bgp 10
awplus(config-router)# no neighbor group1 capability
route-refresh
```

**Examples [BGP4+]**

```
awplus# configure terminal
awplus(config)# router bgp 10
awplus(config-router)# neighbor 2001:0db8:010d::1 capability
route-refresh
awplus# configure terminal
awplus(config)# router bgp 10
awplus(config-router)# no neighbor 2001:0db8:010d::1 capability
route-refresh
awplus# configure terminal
awplus(config)# router bgp 10
awplus(config-router)# neighbor group1 peer-group
awplus(config-router)# neighbor 2001:0db8:010d::1 remote-as 10
awplus(config-router)# address-family ipv6
awplus(config-router-af)# neighbor 2001:0db8:010d::1
peer-group group1
awplus(config-router-af)# exit
awplus(config-router)# neighbor group1 capability route-refresh
awplus# configure terminal
awplus(config)# router bgp 10
awplus(config-router)# no neighbor group1 capability
route-refresh
```

**Related  
Commands**    neighbor peer-group (add a neighbor)  
                  neighbor route-map

# neighbor collide-established

**Overview** Use this command to specify including a BGP or BGP4+ neighbor, already in an 'established' state, for conflict resolution when a TCP connection collision is detected.

Use the **no** variant of this command to remove a BGP or BGP4+ neighbor, already in an 'established' state, for conflict resolution when a TCP connection collision is detected.

**Syntax** `neighbor <neighborid> collide-established`  
`no neighbor <neighborid> collide-established`

| Parameter    | Description                                                                                                                                                                                                                                                                                                                |
|--------------|----------------------------------------------------------------------------------------------------------------------------------------------------------------------------------------------------------------------------------------------------------------------------------------------------------------------------|
| <neighborid> | {<ip-address> <ipv6-addr> <peer-group>}                                                                                                                                                                                                                                                                                    |
| <ip-address> | Specify the address of an IPv4 BGP neighbor, in dotted decimal notation A.B.C.D.                                                                                                                                                                                                                                           |
| <ipv6-addr>  | Specify the address of an IPv6 BGP4+ neighbor, entered in hexadecimal in the format X:X::X:X.                                                                                                                                                                                                                              |
| <peer-group> | Enter the name of an existing peer-group. For information on how to create peer groups, refer to the <a href="#">neighbor peer-group (add a neighbor)</a> command, and <a href="#">neighbor route-map</a> command. When this parameter is used with this command, the command applies on all peers in the specified group. |

**Mode** Router Configuration

**Usage** This command must be used only when specially required. It is not required in most network deployments.

The associated functionality of including an 'established' neighbor into TCP connection collision conflict resolution is automatically enabled when neighbor is configured for BGP graceful-restart.



**Examples [BGP]**

```
awplus# configure terminal
awplus(config)# router bgp 10
awplus(config-router)# neighbor 10.10.10.1 collide-established
awplus# configure terminal
awplus(config)# router bgp 10
awplus(config-router)# no neighbor 10.10.10.1
collide-established
awplus# configure terminal
awplus(config)# router bgp 10
awplus(config-router)# neighbor group1 peer-group
awplus(config-router)# neighbor 10.10.10.1 remote-as 10
awplus(config-router)# neighbor 10.10.10.1 peer-group group1
awplus(config-router)# neighbor group1 collide-established
awplus# configure terminal
awplus(config)# router bgp 10
awplus(config-router)# no neighbor group1 collide-established
```

**Examples [BGP4+]**

```
awplus# configure terminal
awplus(config)# router bgp 10
awplus(config-router)# neighbor 2001:0db8:010d::1
collide-established
awplus# configure terminal
awplus(config)# router bgp 10
awplus(config-router)# no neighbor 2001:0db8:010d::1
collide-established
awplus# configure terminal
awplus(config)# router bgp 10
awplus(config-router)# neighbor group1 peer-group
awplus(config-router)# neighbor 2001:0db8:010d::1 remote-as 10
awplus(config-router)# address-family ipv6
awplus(config-router-af)# neighbor 2001:0db8:010d::1
peer-group group1
awplus(config-router-af)# exit
awplus(config-router)# neighbor group1 collide-established
awplus# configure terminal
awplus(config)# router bgp 10
awplus(config-router)# no neighbor group1 collide-established
```

**Related Commands** [neighbor peer-group \(add a neighbor\)](#)  
[neighbor route-map](#)

# neighbor default-originate

**Overview** Use this command to allow a BGP or BGP4+ local router to send the default route to a neighbor.

Use the **no** variant of this command to send no route as a default route.

**Syntax** `neighbor {<neighborid>} default-originate [route-map <routemap-name>]`  
`no neighbor {<neighborid>} default-originate [route-map <routemap-name>]`

| Parameter       | Description                                                                                                                                                                                                                                                                                                                |
|-----------------|----------------------------------------------------------------------------------------------------------------------------------------------------------------------------------------------------------------------------------------------------------------------------------------------------------------------------|
| <neighborid>    | {<ip-address>   <ipv6-addr>   <peer-group>}                                                                                                                                                                                                                                                                                |
| <ip-address>    | Specify the address of an IPv4 BGP neighbor, in dotted decimal notation A.B.C.D.                                                                                                                                                                                                                                           |
| <ipv6-addr>     | Specify the address of an IPv6 BGP4+ neighbor, entered in hexadecimal in the format X:X::X:X.                                                                                                                                                                                                                              |
| <peer-group>    | Enter the name of an existing peer-group. For information on how to create peer groups, refer to the <a href="#">neighbor peer-group (add a neighbor)</a> command, and <a href="#">neighbor route-map</a> command. When this parameter is used with this command, the command applies on all peers in the specified group. |
| route-map       | If a route-map is specified, then the route table must contain at least one route that matches the permit criteria of the route map before the default route will be advertised to the specified neighbor.                                                                                                                 |
| <routemap-name> | Enter the route-map name.                                                                                                                                                                                                                                                                                                  |

**Mode [BGP]** Router Configuration or IPv4 Address Family Configuration

**Mode [BGP4+]** IPv6 Address Family Configuration

**Examples [BGP]**

```
awplus# configure terminal
awplus(config)# router bgp 10
awplus(config-router)# neighbor 10.10.10.1 default-originate
route-map myroute

awplus# configure terminal
awplus(config)# router bgp 10
awplus(config-router)# no neighbor 10.10.10.1 default-originate
route-map myroute

awplus# configure terminal
awplus(config)# router bgp 10
awplus(config)# address-family ipv4
awplus(config-router-af)# neighbor 10.10.10.1
default-originate route-map myroute

awplus# configure terminal
awplus(config)# router bgp 10
awplus(config)# address-family ipv4
awplus(config-router-af)# no neighbor 10.10.10.1
default-originate route-map myroute

awplus# configure terminal
awplus(config)# router bgp 10
awplus(config-router)# neighbor group1 peer-group
awplus(config-router)# neighbor 10.10.10.1 remote-as 10
awplus(config-router)# neighbor 10.10.10.1 peer-group group1
awplus(config-router)# neighbor group1 default-originate
route-map myroute

awplus# configure terminal
awplus(config)# router bgp 10
awplus(config-router)# no neighbor group1 default-originate
route-map myroute
```

**Examples**  
**[BGP4+]**

```
awplus# configure terminal
awplus(config)# router bgp 10
awplus(config-router)# address-family ipv6
awplus(config-router-af)# neighbor 2001:0db8:010d::1
default-originate route-map myroute
awplus# configure terminal
awplus(config)# router bgp 10
awplus(config-router)# address-family ipv6
awplus(config-router-af)# no neighbor 2001:0db8:010d::1
default-originate route-map myroute
awplus# configure terminal
awplus(config)# router bgp 10
awplus(config-router)# neighbor group1 peer-group
awplus(config-router)# neighbor 2001:0db8:010d::1 remote-as 10
awplus(config-router)# address-family ipv6
awplus(config-router-af)# neighbor 2001:0db8:010d::1
peer-group group1
awplus(config-router-af)# neighbor group1 default-originate
route-map myroute
awplus# configure terminal
awplus(config)# router bgp 10
awplus(config-router)# address-family ipv6
awplus(config-router-af)# no neighbor group1 default-originate
route-map myroute
```

**Related**  
**Commands**

- [neighbor peer-group \(add a neighbor\)](#)
- [neighbor route-map](#)

# neighbor description

**Overview** Use this command to associate a description with a BGP or a BGP4+ neighbor. We recommend adding descriptions to defined neighbors, so any network administrators or network engineers can see a description of connected BGP or BGP4+ peers on the device.

Use the **no** variant of this command to remove the description from a BGP or a BGP4+ neighbor.

**Syntax** `neighbor <neighborid> description <description>`  
`no neighbor <neighborid> description [<description>]`

| Parameter                            | Description                                                                                                                                                                                                                                                                                                                |
|--------------------------------------|----------------------------------------------------------------------------------------------------------------------------------------------------------------------------------------------------------------------------------------------------------------------------------------------------------------------------|
| <code>&lt;neighborid&gt;</code>      | { <code>&lt;ip-address&gt;</code>   <code>&lt;ipv6-addr&gt;</code>   <code>&lt;peer-group&gt;</code> }                                                                                                                                                                                                                     |
| <code>&lt;ip-address&gt;</code><br>> | Specify the address of an IPv4 BGP neighbor, in dotted decimal notation A.B.C.D.                                                                                                                                                                                                                                           |
| <code>&lt;ipv6-addr&gt;</code>       | Specify the address of an IPv6 BGP4+ neighbor, entered in hexadecimal in the format X:X::X:X.                                                                                                                                                                                                                              |
| <code>&lt;peer-group&gt;</code><br>> | Enter the name of an existing peer-group. For information on how to create peer groups, refer to the <a href="#">neighbor peer-group (add a neighbor)</a> command, and <a href="#">neighbor route-map</a> command. When this parameter is used with this command, the command applies on all peers in the specified group. |
| <code>&lt;description&gt;</code>     | Enter up to 80 characters of text describing the neighbor.                                                                                                                                                                                                                                                                 |

**Mode [BGP]** Router Configuration or IPv4 Address Family Configuration

**Mode [BGP4+]** Router Configuration

**Examples [BGP]**

```
awplus# configure terminal
awplus(config)# router bgp 10
awplus(config-router)# neighbor 10.10.10.1 description Backup
router for sales

awplus# configure terminal
awplus(config)# router bgp 10
awplus(config-router)# no neighbor 10.10.10.1 description

awplus# configure terminal
awplus(config)# router bgp 10
awplus(config-router)# neighbor group1 peer-group
awplus(config-router)# neighbor 10.10.10.1 remote-as 10
awplus(config-router)# neighbor 10.10.10.1 peer-group group1
awplus(config-router)# neighbor group1 description Backup
router for sales

awplus# configure terminal
awplus(config)# router bgp 10
awplus(config-router)# neighbor group1 description Backup
router for sales.
```

**Examples [BGP4+]**

```
awplus# configure terminal
awplus(config)# router bgp 10
awplus(config-router)# neighbor 2001:0db8:010d::1 description
Backup router for sales

awplus# configure terminal
awplus(config)# router bgp 10
awplus(config-router)# no neighbor 2001:0db8:010d::1
description

awplus# configure terminal
awplus(config)# router bgp 10
awplus(config-router)# neighbor group1 peer-group
awplus(config-router)# neighbor 2001:0db8:010d::1 remote-as 10
awplus(config-router)# address-family ipv6
awplus(config-router-af)# neighbor 2001:0db8:010d::1
peer-group group1
awplus(config-router-af)# exit
awplus(config-router)# neighbor group1 description Backup
router for sales

awplus# configure terminal
awplus(config)# router bgp 10
awplus(config-router)# no neighbor group1 description Backup
router for sales
```

**Related  
Commands** neighbor peer-group (add a neighbor)  
neighbor route-map

# neighbor disallow-infinite-holdtime

**Overview** Use this command to disallow the configuration of infinite holdtime for BGP and BGP4+.

Use the **no** variant of this command to allow the configuration of infinite holdtime for BGP or BGP4+.

**Syntax [BGP]** neighbor {<ip-address>} disallow-infinite-holdtime  
no neighbor {<ip-address>} disallow-infinite-holdtime

**Syntax [BGP4+]** neighbor {<ipv6-addr>} disallow-infinite-holdtime  
no neighbor {<ipv6-addr>} disallow-infinite-holdtime

| Parameter    | Description                                                                                   |
|--------------|-----------------------------------------------------------------------------------------------|
| <ip-address> | Specify the address of an IPv4 BGP neighbor, in dotted decimal notation A.B.C.D.              |
| <ipv6-addr>  | Specify the address of an IPv6 BGP4+ neighbor, entered in hexadecimal in the format X:X::X:X. |

**Mode** Router Configuration

**Usage** This command enables the local BGP or BGP4+ speaker to reject holdtime "0" seconds from the peer during exchange of open messages or the user during configuration.

The **no** variant of this command allows the BGP speaker to accept "0" holdtime from the peer or during configuration.

**Examples [BGP]** To enable the **disallow-infinite-holdtime** feature on the BGP speaker with the IP address of 10.10.10.1, enter the command:

```
awplus# configure terminal
awplus(config)# router bgp 10
awplus(config-router)# neighbor 10.10.10.1
disallow-infinite-holdtime
```

To disable the **disallow-infinite-holdtime** feature on the BGP speaker with the IP address of 10.10.10.10, enter the command:

```
awplus# configure terminal
awplus(config)# router bgp 10
awplus(config-router)# no neighbor 10.10.10.1
disallow-infinite-holdtime
```



**Examples** To enable the **disallow-infinite-holdtime** feature on the BGP4+ speaker with the **[BGP4+]** IPv6 address of 2001:0db8:010d::1, enter the commands:

```
awplus# configure terminal
awplus(config)# router bgp 10
awplus(config-router)# neighbor
disallow-infinite-holdtime2001:0db8:010d::1
```

To disable the **disallow-infinite-holdtime** feature on the BGP4+ speaker with the IPv6 address of 2001:0db8:010d::1, enter the commands:

```
awplus# configure terminal
awplus(config)# router bgp 10
awplus(config-router)# no neighbor
disallow-infinite-holdtime2001:0db8:010d::1
```

**Related Commands** [neighbor timers](#)

# neighbor dont-capability-negotiate

**Overview** Use this command to disable capability negotiation for BGP and BGP4+.

The capability negotiation is performed by default. This command is used to allow compatibility with older BGP versions that have no capability parameters used in open messages between peers.

Use the **no** variant of this command to enable capability negotiation.

**Syntax** `neighbor <neighborid> dont-capability-negotiate`  
`no neighbor <neighborid> dont-capability-negotiate`

| Parameter                       | Description                                                                                                                                                                                                                                                                                                        |
|---------------------------------|--------------------------------------------------------------------------------------------------------------------------------------------------------------------------------------------------------------------------------------------------------------------------------------------------------------------|
| <code>&lt;neighborid&gt;</code> | <code>{&lt;ip-address&gt;   &lt;ipv6-addr&gt;   &lt;peer-group&gt;}</code>                                                                                                                                                                                                                                         |
| <code>&lt;ip-address&gt;</code> | Specify the IPv4 address of the BGP neighbor in dotted decimal, in the format A.B.C.D.                                                                                                                                                                                                                             |
| <code>&lt;ipv6-addr&gt;</code>  | Specify the IPv6 address of the BGP4+ neighbor, entered in hexadecimal in the format X:X::X:X.                                                                                                                                                                                                                     |
| <code>&lt;peer-group&gt;</code> | Enter the name of an existing peer-group. For information on how to create peer groups, refer to the <a href="#">neighbor peer-group (add a neighbor)</a> and <a href="#">neighbor route-map</a> commands. When this parameter is used with this command, the command applies on all peers in the specified group. |

**Mode** Router Configuration

**Examples [BGP]**

```
awplus# configure terminal
awplus(config)# router bgp 10
awplus(config-router)# neighbor 10.10.0.34
dont-capability-negotiate
awplus# configure terminal
awplus(config)# router bgp 10
awplus(config-router)# no neighbor 10.10.0.34
dont-capability-negotiate
awplus# configure terminal
awplus(config)# router bgp 10
awplus(config-router)# neighbor group1 peer-group
awplus(config-router)# neighbor 10.10.10.34 remote-as 100
awplus(config-router)# neighbor 10.10.10.34 peer-group group1
awplus(config-router)# neighbor group1
dont-capability-negotiate
awplus# configure terminal
awplus(config)# router bgp 10
awplus(config-router)# no neighbor group1
dont-capability-negotiate
```

**Examples [BGP4+]**

```
awplus# configure terminal
awplus(config)# router bgp 10
awplus(config-router)# neighbor 2001:0db8:010d::1
dont-capability-negotiate
awplus# configure terminal
awplus(config)# router bgp 10
awplus(config-router)# no neighbor 2001:0db8:010d::1
dont-capability-negotiate
awplus# configure terminal
awplus(config)# router bgp 10
awplus(config-router)# neighbor group1 peer-group
awplus(config-router)# neighbor 2001:0db8:010d::1 remote-as 100
awplus(config-router)# address-family ipv6
awplus(config-router-af)# neighbor 2001:0db8:010d::1
peer-group group1
awplus(config-router-af)# exit
awplus(config-router)# neighbor group1
dont-capability-negotiate
awplus# configure terminal
awplus(config)# router bgp 10
awplus(config-router)# no neighbor group1
dont-capability-negotiate
```

**Related  
Commands** neighbor peer-group (add a neighbor)  
neighbor route-map

# neighbor ebgp-multihop

**Overview** Use this command to accept and attempt BGP or BGP4+ connections to external peers on indirectly connected networks.

Effectively, this command sets the TTL value in the BGP or BGP4+ packets that the router sends to the neighbor, so that the packets may traverse the network route to the neighbor.

The device will not establish a connection to a multihop neighbor, if the only route to the multihop peer is a default route.

Use the **no** variant of this command to return to the default.

**Syntax** `neighbor <neighborid> ebgp-multihop [<count>]`  
`no neighbor <neighborid> ebgp-multihop [<count>]`

| Parameter                       | Description                                                                                                                                                                                                                                                                                                                |
|---------------------------------|----------------------------------------------------------------------------------------------------------------------------------------------------------------------------------------------------------------------------------------------------------------------------------------------------------------------------|
| <code>&lt;neighborid&gt;</code> | { <code>&lt;ip-address   ipv6-addr   &lt;peer-group&gt;</code> }                                                                                                                                                                                                                                                           |
| <code>&lt;ip-addr&gt;</code>    | Specify the address of an IPv4 BGP neighbor, entered in dotted decimal notation A.B.C.D.                                                                                                                                                                                                                                   |
| <code>&lt;ipv6-addr&gt;</code>  | Specify the address of an IPv6 BGP4+ neighbor, entered in hexadecimal in the format X:X::X:X.                                                                                                                                                                                                                              |
| <code>&lt;peer-group&gt;</code> | Enter the name of an existing peer-group. For information on how to create peer groups, refer to the <a href="#">neighbor peer-group (add a neighbor)</a> command, and <a href="#">neighbor route-map</a> command. When this parameter is used with this command, the command applies on all peers in the specified group. |
| <code>&lt;count&gt;</code>      | <code>&lt;1-255&gt;</code> The Maximum hop count, that is set in the TTL field of the BGP packets. If this optional parameter is not specified with the command, then the Maximum hop count is set to 255.                                                                                                                 |

**Mode [BGP]** Router Configuration or IPv4 Address Family Configuration

**Mode [BGP4+]** Router Configuration

**Examples [BGP]**

```
awplus# configure terminal
awplus(config)# router bgp 10
awplus(config-router)# neighbor 10.10.10.34 remote-as 10
awplus(config-router)# neighbor 10.10.10.34 ebgp-multihop 5
awplus# configure terminal
awplus(config)# router bgp 10
awplus(config-router)# no neighbor 10.10.10.34 ebgp-multihop 5
awplus# configure terminal
awplus(config)# router bgp 10
awplus(config-router)# neighbor group1 peer-group
awplus(config-router)# neighbor 10.10.10.34 remote-as 10
awplus(config-router)# neighbor 10.10.10.34 peer-group group1
awplus(config-router)# neighbor group1 ebgp-multihop 5
awplus# configure terminal
awplus(config)# router bgp 10
awplus(config-router)# no neighbor group1 ebgp-multihop 5
```

**Examples [BGP4+]**

```
awplus# configure terminal
awplus(config)# router bgp 10
awplus(config-router)# neighbor 2001:0db8:010d::1 remote-as 10
awplus(config-router)# neighbor 2001:0db8:010d::1
ebgp-multihop 5
awplus# configure terminal
awplus(config)# router bgp 10
awplus(config-router)# no neighbor 2001:0db8:010d::1
ebgp-multihop 5
awplus# configure terminal
awplus(config)# router bgp 10
awplus(config-router)# neighbor group1 peer-group
awplus(config-router)# neighbor 2001:0db8:010d::1 remote-as 10
awplus(config-router)# address-family ipv6
awplus(config-router-af)# neighbor 2001:0db8:010d::1
peer-group group1
awplus(config-router-af)# exit
awplus(config-router)# neighbor group1 ebgp-multihop 5
awplus# configure terminal
awplus(config)# router bgp 10
awplus(config-router)# no neighbor group1 ebgp-multihop 5
```

**Related  
Commands**    neighbor ebgp-multihop  
                 neighbor peer-group (add a neighbor)  
                 neighbor route-map

# neighbor enforce-multihop

**Overview** Use this command to enforce the requirement that BGP and BGP4+ neighbors form multihop connections.

Use the **no** variant of this command to turn off this feature.

**Syntax** `neighbor <neighborid> enforce-multihop`  
`no neighbor <neighborid> enforce-multihop`

| Parameter    | Description                                                                                                                                                                                                                                                                                                      |
|--------------|------------------------------------------------------------------------------------------------------------------------------------------------------------------------------------------------------------------------------------------------------------------------------------------------------------------|
| <neighborid> | {<ip-address> <ipv6-addr> <peer-group>}                                                                                                                                                                                                                                                                          |
| <ip-address> | The address of an IPv4 BGP neighbor, in dotted decimal notation A.B.C.D.                                                                                                                                                                                                                                         |
| <ipv6-addr>  | The address of an IPv6 BGP4+ neighbor, entered in hexadecimal in the format X:X::X:X.                                                                                                                                                                                                                            |
| <peer-group> | Name of an existing peer-group. For information on how to create peer groups, refer to the <a href="#">neighbor peer-group (add a neighbor)</a> command, and <a href="#">neighbor route-map</a> command. When this parameter is used with this command, the command applies on all peers in the specified group. |

**Mode [BGP]** Router Configuration or IPv4 Address Family Configuration

**Mode [BGP4+]** Router Configuration



**Examples [BGP]**

```
awplus# configure terminal
awplus(config)# router bgp 10
awplus(config-router)# neighbor 10.10.0.34 remote-as 10
awplus(config-router)# neighbor 10.10.0.34 enforce-multihop
awplus# configure terminal
awplus(config)# router bgp 10
awplus(config-router)# no neighbor 10.10.0.34 enforce-multihop
awplus# configure terminal
awplus(config)# router bgp 10
awplus(config-router)# neighbor group1 peer-group
awplus(config-router)# neighbor 10.10.10.34 remote-as 10
awplus(config-router)# neighbor 10.10.10.34 peer-group group1
awplus(config-router)# neighbor group1 enforce-multihop
awplus# configure terminal
awplus(config)# router bgp 10
awplus(config-router)# no neighbor group1 enforce-multihop
```

**Examples [BGP4+]**

```
awplus# configure terminal
awplus(config)# router bgp 10
awplus(config-router)# neighbor 2001:0db8:010d::1 remote-as 10
awplus(config-router)# neighbor 2001:0db8:010d::1
enforce-multihop
awplus# configure terminal
awplus(config)# router bgp 10
awplus(config-router)# no neighbor 2001:0db8:010d::1
enforce-multihop
awplus# configure terminal
awplus(config)# router bgp 10
awplus(config-router)# neighbor group1 peer-group
awplus(config-router)# neighbor 2001:0db8:010d::1 remote-as 10
awplus(config-router)# address-family ipv6
awplus(config-router-af)# neighbor 2001:0db8:010d::1
peer-group group1
awplus(config-router-af)# exit
awplus(config-router)# neighbor group1 enforce-multihop
awplus# configure terminal
awplus(config)# router bgp 10
awplus(config-router)# no neighbor group1 enforce-multihop
```

**Related  
Commands**    neighbor peer-group (add a neighbor)  
                  neighbor route-map

# neighbor filter-list

**Overview** This command creates a BGP or BGP4+ filter using an AS (Autonomous System) path list. This command specifies an AS path list, which it then applies to filter updates to and from a BGP or a BGP4+ neighbor

The **no** variant of this command removes the previously specified BGP or BGP4+ filter using access control lists.

**Syntax** `neighbor <neighborid> filter-list <listname> {in|out}`  
`no neighbor <neighborid> filter-list <listname> {in|out}`

| Parameter                       | Description                                                                                                                                                                                                                                                                                                                                                                                                                                                                                                                                                                                                                                                                                                                                                             |
|---------------------------------|-------------------------------------------------------------------------------------------------------------------------------------------------------------------------------------------------------------------------------------------------------------------------------------------------------------------------------------------------------------------------------------------------------------------------------------------------------------------------------------------------------------------------------------------------------------------------------------------------------------------------------------------------------------------------------------------------------------------------------------------------------------------------|
| <code>&lt;neighborid&gt;</code> | Specify the identification method for the BGP or BGP4+ peer. Use one of the following formats: <ul style="list-style-type: none"><li><code>&lt;ip-address&gt;</code> Specify the address of an IPv4 BGP neighbor, in dotted decimal notation A.B.C.D.</li><li><code>&lt;ipv6-addr&gt;</code> Specify the address of an IPv6 BGP4+ neighbor, entered in hexadecimal in the format X:X::X:X.</li><li><code>&lt;peer-group&gt;</code> Enter the name of an existing peer-group. For information on how to create peer groups, refer to the <a href="#">neighbor peer-group (add a neighbor)</a> command, and <a href="#">neighbor route-map</a> command. When this parameter is used with this command, the command applies on all peers in the specified group.</li></ul> |
| <code>&lt;listname&gt;</code>   | Specify the name of an AS (Autonomous System) path list.                                                                                                                                                                                                                                                                                                                                                                                                                                                                                                                                                                                                                                                                                                                |
| <code>in</code>                 | Indicates that incoming advertised routes will be filtered.                                                                                                                                                                                                                                                                                                                                                                                                                                                                                                                                                                                                                                                                                                             |
| <code>out</code>                | Indicates that outgoing advertised routes will be filtered.                                                                                                                                                                                                                                                                                                                                                                                                                                                                                                                                                                                                                                                                                                             |

**Mode [BGP]** Router Configuration or IPv4 Address Family Configuration

**Mode [BGP4+]** IPv6 Address Family Configuration

**Usage** This command specifies a filter for updates based on a BGP AS (Autonomous System) path list.

**Examples [BGP]**

```
awplus# configure terminal
awplus(config)# router bgp 10
awplus(config-router)# neighbor 10.10.0.34 filter-list list1
out

awplus# configure terminal
awplus(config)# router bgp 10
awplus(config-router)# no neighbor 10.10.0.34 filter-list list1
out

awplus# configure terminal
awplus(config)# router bgp 10
awplus(config-router)# address-family ipv4
awplus(config-router-af)# neighbor 10.10.0.34 filter-list list1
out

awplus# configure terminal
awplus(config)# router bgp 10
awplus(config-router)# address-family ipv4
awplus(config-router-af)# no neighbor 10.10.0.34 filter-list
list1 out

awplus# configure terminal
awplus(config)# router bgp 10
awplus(config-router)# neighbor group1 peer-group
awplus(config-router)# neighbor 10.10.10.34 remote-as 10
awplus(config-router)# neighbor 10.10.10.34 peer-group group1
awplus(config-router)# neighbor group1 filter-list list1 out
awplus# configure terminal
awplus(config)# router bgp 10
awplus(config-router)# no neighbor group1 filter-list list1 out
```

**Examples**  
**[BGP4+]**

```
awplus# configure terminal
awplus(config)# router bgp 10
awplus(config-router)# address-family ipv6
awplus(config-router-af)# neighbor 2001:0db8:010d::1
filter-list list1 out
awplus# configure terminal
awplus(config)# router bgp 10
awplus(config-router)# address-family ipv6
awplus(config-router-af)# no neighbor 2001:0db8:010d::1
filter-list list1 out
awplus# configure terminal
awplus(config)# router bgp 10
awplus(config-router)# neighbor group1 peer-group
awplus(config-router)# neighbor 2001:0db8:010d::1 remote-as 10
awplus(config-router)# address-family ipv6
awplus(config-router-af)# neighbor 2001:0db8:010d::1
peer-group group1
awplus(config-router-af)# neighbor group1 filter-list list1 out
awplus# configure terminal
awplus(config)# router bgp 10
awplus(config-router)# address-family ipv6
awplus(config-router-af)# no neighbor group1 filter-list list1
out
```

**Related**  
**Commands**

- [neighbor peer-group \(add a neighbor\)](#)
- [neighbor route-map](#)

# neighbor interface

**Overview** Use this command to configure the interface name of a BGP4+ speaking neighbor. Use the **no** variant of this command to disable this function.

**Syntax [BGP4+]** `neighbor {<ipv6-addr>|<ipaddress>} interface <interface>`  
`no neighbor {<ipv6-addr>|<ipaddress>} interface <interface>`

| Parameter   | Description                                                                                                |
|-------------|------------------------------------------------------------------------------------------------------------|
| <ipaddress> | Specifies the IPv4 address of the BGP neighbor - entered in dotted decimal notation in the format A.B.C.D. |
| <ipv6-addr> | Specifies the IPv6 address of the BGP4+ neighbor, entered in hexadecimal in the format X:X::X:X.           |
| <interface> | Specifies the interface name of BGP neighbor, e.g. vlan2.                                                  |

**Mode [BGP4+]** Router Configuration

**Usage [BGP4+]** This command is for use with BGP4+ peering. Use this command for BGP peering with IPv6 link local addresses.

**Examples [BGP4+]**

```
awplus# configure terminal
awplus(config)# router bgp 10
awplus(config-router)# neighbor 10.10.0.72 interface vlan2
awplus# configure terminal
awplus(config)# router bgp 10
awplus(config-router)# no neighbor 10.10.0.72 interface vlan2
awplus# configure terminal
awplus(config)# router bgp 10
awplus(config-router)# neighbor 2001:0db8:010d::1 interface
vlan2
awplus# configure terminal
awplus(config)# router bgp 10
awplus(config-router)# no neighbor 2001:0db8:010d::1 interface
vlan2
```

# neighbor local-as

**Overview** Use this command to configure a local AS number for the specified BGP or BGP4+ neighbor. This overrides the local AS number specified by the [router bgp](#) command.

Use the **no** variant of this command to remove the local AS number for the specified BGP or BGP4+ neighbor.

**Syntax** `neighbor <neighborid> local-as <as-number>`  
`no neighbor <neighborid> local-as <as-number>`

| Parameter                       | Description                                                                                                                                                                                                                                                                                                        |
|---------------------------------|--------------------------------------------------------------------------------------------------------------------------------------------------------------------------------------------------------------------------------------------------------------------------------------------------------------------|
| <code>&lt;neighborid&gt;</code> | { <code>&lt;ip-address&gt;</code>   <code>&lt;ipv6-addr&gt;</code>   <code>&lt;peer-group&gt;</code> }                                                                                                                                                                                                             |
| <code>&lt;ip-address&gt;</code> | The address of an IPv4 BGP neighbor, in dotted decimal notation A.B.C.D.                                                                                                                                                                                                                                           |
| <code>&lt;ipv6-addr&gt;</code>  | The address of an IPv6 BGP4+ neighbor, entered in hexadecimal in the format X:X::X:X.                                                                                                                                                                                                                              |
| <code>&lt;peer-group&gt;</code> | Enter the name of an existing peer-group. For information on how to create peer groups, refer to the <a href="#">neighbor peer-group (add a neighbor)</a> and <a href="#">neighbor route-map</a> commands. When this parameter is used with this command, the command applies on all peers in the specified group. |
| <code>&lt;as-number&gt;</code>  | <code>&lt;1-4294967295&gt;</code> Neighbor's Autonomous System (AS) number.                                                                                                                                                                                                                                        |

**Mode [BGP]** Router Configuration or IPv4 Address Family Configuration

**Mode [BGP4+]** Router Configuration

When VRF-lite is configured, this command allows internal BGP loopback connections between named VRFs and the default global routing instance to be configured to act as eBGP connections, instead of only iBGP.

**Usage [BGP4+]** When BGP4+ is configured, this command prepends the ASN as defined by the [router bgp](#) command, and adds the ASN as defined by the [neighbor local-as](#) command in front of the actual ASN as defined by the [router bgp](#) command. This makes the peer believe it is peering with the ASN as defined by the [neighbor local-as](#) command.

**Examples [BGP]**

```
awplus# configure terminal
awplus(config)# router bgp 10
awplus(config-router)# neighbor 10.10.0.34 local-as 1
awplus# configure terminal
awplus(config)# router bgp 10
awplus(config-router)# no neighbor 10.10.0.34 local-as 1
awplus# configure terminal
awplus(config)# router bgp 10
awplus(config-router)# neighbor group1 peer-group
awplus(config-router)# neighbor 10.10.10.34 remote-as 10
awplus(config-router)# neighbor 10.10.10.34 peer-group group1
awplus(config-router)# neighbor group1 local-as 1
awplus# configure terminal
awplus(config)# router bgp 10
awplus(config-router)# no neighbor group1 local-as 1
```

**Examples [BGP4+]**

```
awplus# configure terminal
awplus(config)# router bgp 10
awplus(config-router)# neighbor 2001:0db8:010d::1 local-as 1
awplus# configure terminal
awplus(config)# router bgp 10
awplus(config-router)# no neighbor 2001:0db8:010d::1 local-as 1
awplus# configure terminal
awplus(config)# router bgp 10
awplus(config-router)# neighbor group1 peer-group
awplus(config-router)# address-family ipv6
awplus(config-router-af)# neighbor 2001:0db8:010d::1
peer-group group1
awplus(config-router-af)# exit
awplus(config-router)# neighbor group1 local-as 1
awplus# configure terminal
awplus(config)# router bgp 10
awplus(config-router)# no neighbor group1 local-as 1
```

**Related Commands**

- [neighbor peer-group \(add a neighbor\)](#)
- [neighbor route-map](#)
- [router bgp](#)

**Command changes** Version 5.4.6-2.1: VRF-lite support added.



# neighbor maximum-prefix

**Overview** Use this command to control the number of prefixes that can be received from a BGP or a BGP4+ neighbor.

Use the **no** variant of this command to disable this function. Do not specify threshold to apply the default threshold of 75% for the maximum number of prefixes before this is applied.

**Syntax** `neighbor <neighborid> maximum-prefix <maximum>`  
`no neighbor <neighborid> maximum-prefix [<maximum>]`

| Parameter                       | Description                                                                                                                                                                                                                                                                                                      |
|---------------------------------|------------------------------------------------------------------------------------------------------------------------------------------------------------------------------------------------------------------------------------------------------------------------------------------------------------------|
| <code>&lt;neighborid&gt;</code> | { <code>&lt;ip-address&gt;</code>   <code>&lt;ipv6-addr&gt;</code>   <code>&lt;peer-group&gt;</code> }                                                                                                                                                                                                           |
| <code>&lt;ip-address&gt;</code> | Specify the address of an IPv4 BGP neighbor, in dotted decimal notation A.B.C.D.                                                                                                                                                                                                                                 |
| <code>&lt;ipv6-addr&gt;</code>  | Specify the address of an IPv6 BGP4+ neighbor, entered in hexadecimal in the format X:X::X:X.                                                                                                                                                                                                                    |
| <code>&lt;peer-group&gt;</code> | Name of an existing peer-group. For information on how to create peer groups, refer to the <a href="#">neighbor peer-group (add a neighbor)</a> command, and <a href="#">neighbor route-map</a> command. When this parameter is used with this command, the command applies on all peers in the specified group. |
| <code>&lt;maximum&gt;</code>    | <code>&lt;maxprefix&gt;</code> [ <code>&lt;threshold&gt;</code> ] [ <code>warning-only</code> ]                                                                                                                                                                                                                  |
| <code>&lt;maxprefix&gt;</code>  | <code>&lt;1-4294967295&gt;</code><br>Specifies the maximum number of prefixes permitted.                                                                                                                                                                                                                         |
| <code>&lt;threshold&gt;</code>  | <code>&lt;1-100&gt;</code> Specifies the threshold value, 1 to 100 percent. 75% by default.                                                                                                                                                                                                                      |
| <code>warning-only</code>       | Only gives a warning message when the limit is exceeded.                                                                                                                                                                                                                                                         |

**Default** The default threshold value is 75%. If the threshold value is not specified this default is applied.

**Mode [BGP]** Router Configuration or IPv4 Address Family Configuration

**Mode [BGP4+]** IPv6 Address Family Configuration

**Usage** The **neighbor maximum-prefix** command allows the configuration of a specified number of prefixes that a BGP or a BGP4+ router is allowed to receive from a neighbor. When the `warning-only` option is not used, if any extra prefixes are received, the router ends the peering. A terminated peer, stays down until the **clear ip bgp** command is used.

**Examples [BGP]**

```
awplus# configure terminal
awplus(config)# router bgp 10
awplus(config-router)# neighbor 10.10.0.72 maximum-prefix 1244
warning-only

awplus# configure terminal
awplus(config)# router bgp 10
awplus(config-router)# no neighbor 10.10.0.72 maximum-prefix
1244 warning-only

awplus# configure terminal
awplus(config)# router bgp 10
awplus(config-router)# neighbor group1 peer-group
awplus(config-router)# neighbor 10.10.10.72 remote-as 10
awplus(config-router)# neighbor 10.10.10.72 peer-group group1
awplus(config-router)# neighbor group1 maximum-prefix 1244
warning-only

awplus# configure terminal
awplus(config)# router bgp 10
awplus(config-router)# no neighbor group1 maximum-prefix 1244
warning-only
```

**Examples**  
**[BGP4+]**

```
awplus# configure terminal
awplus(config)# router bgp 10
awplus(config-router)# address-family ipv6
awplus(config-router-af)# neighbor 2001:0db8:010d::1
maximum-prefix 1244 warning-only
awplus# configure terminal
awplus(config)# router bgp 10
awplus(config-router)# address-family ipv6
awplus(config-router-af)# no neighbor 2001:0db8:010d::1
maximum-prefix 1244 warning-only
awplus# configure terminal
awplus(config)# router bgp 10
awplus(config-router)# neighbor group1 peer-group
awplus(config-router)# address-family ipv6
awplus(config-router-af)# neighbor 2001:0db8:010d::1
peer-group group1
awplus(config-router-af)# neighbor group1 maximum-prefix 1244
warning-only
awplus# configure terminal
awplus(config)# router bgp 10
awplus(config-router)# address-family ipv6
awplus(config-router-af)# no neighbor group1 maximum-prefix
1244 warning-only
```

**Related** [neighbor peer-group \(add a neighbor\)](#)  
**Commands** [neighbor route-map](#)

# neighbor next-hop-self

**Overview** Use this command to configure the BGP or BGP4+ router as the next hop for a BGP or BGP4+ speaking neighbor or peer group.

Use the **no** variant of this command to disable this feature.

**Syntax** `neighbor <neighborid> next-hop-self`  
`no neighbor <neighborid> next-hop-self`

| Parameter    | Description                                                                                                                                                                                                                                                                                                                |
|--------------|----------------------------------------------------------------------------------------------------------------------------------------------------------------------------------------------------------------------------------------------------------------------------------------------------------------------------|
| <neighborid> | { <ip-address>   <ipv6-addr>   <peer-group> }                                                                                                                                                                                                                                                                              |
| <ip-address> | Specify the address of an IPv4 BGP neighbor, in dotted decimal notation A.B.C.D.                                                                                                                                                                                                                                           |
| <ipv6-addr>  | Specify the address of an IPv6 BGP4+ neighbor, entered in hexadecimal in the format X:X::X:X.                                                                                                                                                                                                                              |
| <peer-group> | Enter the name of an existing peer-group. For information on how to create peer groups, refer to the <a href="#">neighbor peer-group (add a neighbor)</a> command, and <a href="#">neighbor route-map</a> command. When this parameter is used with this command, the command applies on all peers in the specified group. |

**Mode [BGP]** Router Configuration or IPv4 Address Family Configuration

**Mode [BGP4+]** IPv6 Address Family Configuration

**Usage** This command allows a BGP or BGP4+ router to change the next hop information that is sent to the iBGP peer. The next hop information is set to the IP address of the interface used to communicate with the neighbor.

This command can be run for a specific VRF instance.

**Examples [BGP]**

```
awplus# configure terminal
awplus(config)# router bgp 10
awplus(config-router)# neighbor 10.10.0.72 next-hop-self
awplus# configure terminal
awplus(config)# router bgp 10
awplus(config-router)# no neighbor 10.10.0.72 next-hop-self
awplus# configure terminal
awplus(config)# router bgp 10
awplus(config-router)# address-family ipv4
awplus(config-router)# neighbor 10.10.0.72 next-hop-self
awplus# configure terminal
awplus(config)# router bgp 10
awplus(config-router)# address-family ipv4
awplus(config-router)# no neighbor 10.10.0.72 next-hop-self
awplus# configure terminal
awplus(config)# router bgp 10
awplus(config-router)# neighbor group1 peer-group
awplus(config-router)# neighbor 10.10.10.72 remote-as 10
awplus(config-router)# neighbor 10.10.10.72 peer-group group1
awplus(config-router)# neighbor group1 next-hop-self
awplus# configure terminal
awplus(config)# router bgp 10
awplus(config-router)# no neighbor group1 next-hop-self
```

**Examples**  
**[BGP4+]**

```
awplus# configure terminal
awplus(config)# router bgp 10
awplus(config-router)# address-family ipv6
awplus(config-router-af)# neighbor 2001:0db8:010d::1
next-hop-self
awplus# configure terminal
awplus(config)# router bgp 10
awplus(config-router)# address-family ipv6
awplus(config-router-af)# no neighbor 2001:0db8:010d::1
next-hop-self
awplus# configure terminal
awplus(config)# router bgp 10
awplus(config-router)# neighbor group1 peer-group
awplus(config-router)# neighbor 2001:0db8:010d::1 remote-as 10
awplus(config-router)# address-family ipv6
awplus(config-router-af)# neighbor 2001:0db8:010d::1
peer-group group1
awplus(config-router-af)# neighbor group1 next-hop-self
awplus# configure terminal
awplus(config)# router bgp 10
awplus(config-router)# address-family ipv6
awplus(config-router-af)# no neighbor group1 next-hop-self
```

**Related**  
**Commands**

- [neighbor peer-group \(add a neighbor\)](#)
- [neighbor route-map](#)

# neighbor override-capability

**Overview** Use this command to override a capability negotiation result for BGP and BGP4+. Use the **no** variant of with this command to disable this function.

**Syntax** `neighbor <neighborid> override-capability`  
`no neighbor <neighborid> override-capability`

| Parameter    | Description                                                                                                                                                                                                                                                                                                                |
|--------------|----------------------------------------------------------------------------------------------------------------------------------------------------------------------------------------------------------------------------------------------------------------------------------------------------------------------------|
| <neighborid> | {<ip-address>   <ipv6-addr>   <peer-group>}                                                                                                                                                                                                                                                                                |
| <ip-address> | Specify the address of an IPv4 BGP neighbor, in dotted decimal notation A.B.C.D.                                                                                                                                                                                                                                           |
| <ipv6-addr>  | Specify the address of an IPv6 BGP4+ neighbor, entered in hexadecimal in the format X:X::X:X.                                                                                                                                                                                                                              |
| <peer-group> | Enter the name of an existing peer-group. For information on how to create peer groups, refer to the <a href="#">neighbor peer-group (add a neighbor)</a> command, and <a href="#">neighbor route-map</a> command. When this parameter is used with this command, the command applies on all peers in the specified group. |

**Mode** Router Configuration

**Examples [BGP]**

```
awplus# configure terminal
awplus(config)# router bgp 10
awplus(config-router)# neighbor 10.10.0.72 override-capability
awplus# configure terminal
awplus(config)# router bgp 10
awplus(config-router)# no neighbor 10.10.0.72
override-capability
awplus# configure terminal
awplus(config)# router bgp 10
awplus(config-router)# neighbor group1 peer-group
awplus(config-router)# neighbor 10.10.10.72 remote-as 10
awplus(config-router)# neighbor 10.10.10.72 peer-group group1
awplus(config-router)# neighbor group1 override-capability
awplus# configure terminal
awplus(config)# router bgp 10
awplus(config-router)# no neighbor group1 override-capability
```

**Examples**  
**[BGP4+]**

```
awplus# configure terminal
awplus(config)# router bgp 12
awplus(config-router)# neighbor 2001:0db8:010d::1
override-capability
awplus# configure terminal
awplus(config)# router bgp 12
awplus(config-router)# no neighbor 2001:0db8:010d::1
override-capability
awplus# configure terminal
awplus(config)# router bgp 12
awplus(config-router)# neighbor group1 peer-group
awplus(config-router)# neighbor 2001:0db8:010d::1 remote-as 10
awplus(config-router)# address-family ipv6
awplus(config-router-af)# neighbor 2001:0db8:010d::1
peer-group group1
awplus(config-router-af)# exit
awplus(config-router)# neighbor group1 override-capability
awplus# configure terminal
awplus(config)# router bgp 12
awplus(config-router)# no neighbor group1 override-capability
```

**Related**  
**Commands**

- [neighbor peer-group \(add a neighbor\)](#)
- [neighbor route-map](#)



# neighbor passive

**Overview** Use this command to configure the local BGP or BGP4+ router to be passive with regard to the specified BGP or BGP4+ neighbor. This has the effect that the BGP or BGP4+ router will not attempt to initiate connections to this BGP or BGP4+ neighbor, but will accept incoming connection attempts from the BGP or BGP4+ neighbor.

Use the **no** variant of this command to disable this function.

**Syntax** `neighbor <neighborid> passive`  
`no neighbor <neighborid> passive`

| Parameter    | Description                                                                                                                                                                                                                                                                                                                |
|--------------|----------------------------------------------------------------------------------------------------------------------------------------------------------------------------------------------------------------------------------------------------------------------------------------------------------------------------|
| <neighborid> | {<ip-address>   <ipv6-addr>   <peer-group>}                                                                                                                                                                                                                                                                                |
| <ip-address> | Specify the address of an IPv4 BGP neighbor, in dotted decimal notation A.B.C.D.                                                                                                                                                                                                                                           |
| <ipv6-addr>  | Specify the address of an IPv6 BGP4+ neighbor, entered in hexadecimal in the format X:X::X:X.                                                                                                                                                                                                                              |
| <peer-group> | Enter the name of an existing peer-group. For information on how to create peer groups, refer to the <a href="#">neighbor peer-group (add a neighbor)</a> command, and <a href="#">neighbor route-map</a> command. When this parameter is used with this command, the command applies on all peers in the specified group. |

**Mode [BGP]** Router Configuration or IPv4 Address Family Configuration

**Mode [BGP4+]** Router Configuration

**Examples [BGP]**

```
awplus# configure terminal
awplus(config)# router bgp 10
awplus(config-router)# neighbor 10.10.0.72 passive
awplus# configure terminal
awplus(config)# router bgp 10
awplus(config-router)# no neighbor 10.10.0.72 passive
awplus# configure terminal
awplus(config)# router bgp 10
awplus(config-router)# neighbor group1 peer-group
awplus(config-router)# neighbor 10.10.10.72 remote-as 10
awplus(config-router)# neighbor 10.10.10.72 peer-group group1
awplus(config-router)# neighbor group1 passive
awplus# configure terminal
awplus(config)# router bgp 10
awplus(config-router)# no neighbor group1 passive
```

**Examples [BGP4+]**

```
awplus# configure terminal
awplus(config)# router bgp 10
awplus(config-router)# neighbor 2001:0db8:010d::1 passive
awplus# configure terminal
awplus(config)# router bgp 10
awplus(config-router)# no neighbor 2001:0db8:010d::1 passive
awplus# configure terminal
awplus(config)# router bgp 10
awplus(config-router)# neighbor group1 peer-group
awplus(config-router)# neighbor 2001:0db8:010d::1 remote-as 10
awplus(config-router)# address-family ipv6
awplus(config-router-af)# neighbor 2001:0db8:010d::1
peer-group group1
awplus(config-router-af)# exit
awplus(config-router)# neighbor group1 passive
awplus# configure terminal
awplus(config)# router bgp 10
awplus(config-router)# no neighbor group1 passive
```

**Related Commands** [neighbor peer-group \(add a neighbor\)](#)  
[neighbor route-map](#)

# neighbor password

**Overview** Use this command to enable MD5 authentication on a TCP connection between BGP and BGP4+ neighbors. No authentication is applied by default. To setup authentication for the session, you must first apply authentication on each connected peer for the session.

Use the **no** variant of this command to disable this function.

**Syntax [BGP]** `neighbor {<ip-address>|<peer-group-name>} password <password>`  
`no neighbor {<ip-address>|<peer-group-name>} password`  
`[<password>]`

**Syntax [BGP4+]** `neighbor {<ipv6-addr>|<peer-group-name>} password <password>`  
`no neighbor {<ipv6-addr>|<peer-group-name>} password`  
`[<password>]`

| Parameter                            | Description                                                                                                                             |
|--------------------------------------|-----------------------------------------------------------------------------------------------------------------------------------------|
| <code>&lt;ip-address&gt;</code>      | Specifies the IP address of the BGP neighbor, in A.B.C.D format.                                                                        |
| <code>&lt;ipv6-addr&gt;</code>       | Specifies the IPv6 address of the BGP4+ neighbor, entered in hexadecimal in the format X:X::X:X.                                        |
| <code>&lt;peer-group-name&gt;</code> | Name of an existing peer-group. When this parameter is used with this command, the command applies on all peers in the specified group. |
| <code>&lt;password&gt;</code>        | An alphanumeric string of characters to be used as password.                                                                            |

**Default** No authentication is applied by default.

**Mode [BGP]** Router Configuration or IPv4 Address Family Configuration

**Mode [BGP4+]** Router Configuration

**Usage** When using the `<peer-group-name>` parameter with this command (to apply this command to all peers in the group), see the related commands [neighbor peer-group \(add a neighbor\)](#) and [neighbor route-map](#) for information about how to create peer groups first.

**Examples [BGP]** This example specifies the encryption type and the password 'manager' for the neighbor 10.10.10.1:

```
awplus# configure terminal
awplus(config)# router bgp 10
awplus(config-router)# neighbor 10.10.10.1 password manager
```

This example removes the password set for the neighbor 10.10.10.1:

```
awplus# configure terminal
awplus(config)# router bgp 10
awplus(config-router)# no neighbor 10.10.10.1 password
```

This example specifies the encryption type and the password 'manager' for the neighbor peer group named 'group1':

```
awplus# configure terminal
awplus(config)# router bgp 10
awplus(config-router)# neighbor group1 peer-group
awplus(config-router)# neighbor 10.10.10.1 remote-as 10
awplus(config-router)# neighbor 10.10.10.1 peer-group group1
awplus(config-router)# neighbor group1 password manager
```

This example removes the password set for the neighbor peer group named group1:

```
awplus# configure terminal
awplus(config)# router bgp 10
awplus(config-router)# no neighbor group1 password
```

**Examples  
(VRF-lite)**

This example specifies the password ('manager') for the neighbor peer group named 'group1' for an IPv4 address-family VRF instance name 'red', and router bgp 10:

```
awplus# configure terminal
awplus(config)# router bgp 10
awplus(config-router)# address-family ipv4 vrf red
awplus(config-router-af)# neighbor 10.10.10.1 password manager
```

This example removes the password ('manager') for the neighbor peer group named 'group1' for an IPv4 address-family, VRF instance name 'red', and router bgp 10:

```
awplus# configure terminal
awplus(config)# router bgp 10
awplus(config-router)# address-family ipv4 vrf red
awplus(config-router-af)# no neighbor 10.10.10.1 password
manager
```

This example specifies the password ('manager') for the neighbor peer group named 'group1' for an IPv4 address-family, VRF instance name 'red', and router bgp 10:

```
awplus# configure terminal
awplus(config)# router bgp 10
awplus(config-router)# neighbor group1 peer-group
awplus(config-router)# neighbor 10.10.10.1 remote-as 10
awplus(config-router)# neighbor 10.10.10.1 peer-group group1
awplus(config-router)# address-family ipv4 vrf red
awplus(config-router-af)# neighbor group1 password manager
```

**Examples [BGP4+]** This example specifies the encryption type and the password 'manager' for the neighbor 2001:0db8:010d::1:

```
awplus# configure terminal
awplus(config)# router bgp 10
awplus(config-router)# neighbor password manager
2001:0db8:010d::1
```

This example removes the password set for the neighbor 2001:0db8:010d::1:

```
awplus# configure terminal
awplus(config)# router bgp 10
awplus(config-router)# no neighbor password 2001:0db8:010d::1
```

This example specifies the encryption type and the password 'manager' for the neighbor peer group named group1:

```
awplus# configure terminal
awplus(config)# router bgp 10
awplus(config-router)# neighbor group1 peer-group
awplus(config-router)# neighbor remote-as 102001:0db8:010d::1
awplus(config-router)# address-family ipv6
awplus(config-router-af)# neighbor peer-group group1
2001:0db8:010d::1
awplus(config-router-af)# exit
awplus(config-router)# neighbor group1 password manager
```

This example removes the password set for the neighbor peer group named 'group1':

```
awplus# configure terminal
awplus(config)# router bgp 10
awplus(config-router)# no neighbor group1 password
```

**Related Commands** [neighbor peer-group \(add a neighbor\)](#)  
[neighbor route-map](#)

**Command changes** Version 5.4.6-2.1: VRF-lite support added.

# neighbor peer-group (add a neighbor)

**Overview** Use this command to add a BGP or a BGP4+ neighbor to an existing peer-group. Use the **no** variant of this command to disable this function.

**Syntax [BGP]** `neighbor <ip-address> peer-group <peer-group>`  
`no neighbor <ip-address> peer-group <peer-group>`

**Syntax [BGP4+]** `neighbor <ipv6-addr> peer-group <peer-group>`  
`no neighbor <ipv6-addr> peer-group <peer-group>`

| Parameter                       | Description                                                                                                                               |
|---------------------------------|-------------------------------------------------------------------------------------------------------------------------------------------|
| <code>&lt;ip-address&gt;</code> | Specify the IPv4 address of the BGP neighbor, entered in the format A.B.C.D.                                                              |
| <code>&lt;ipv6-addr&gt;</code>  | Specify the IPv6 address of the BGP4+ neighbor, entered in hexadecimal in the format X:X::X:X.                                            |
| <code>&lt;peer-group&gt;</code> | Enter the name of the peer-group. When this parameter is used with this command, the command applies on all peers in the specified group. |

**Mode [BGP]** Router Configuration or IPv4 Address Family Configuration

**Mode [BGP4+]** IPv6 Address Family Configuration

**Usage** Use this command to add neighbors with the same update policies to a peer group. This facilitates the updates of various policies, such as, distribute and filter lists. The peer-group is then configured easily with many of the neighbor commands. Any changes made to the peer group affect all members.

To create a peer-group use the [neighbor port](#) command and then use this command to add neighbors to the group.

**Examples [BGP]** This example shows a new peer-group `group1` and the addition of a neighbor `10.10.0.63` to the group.

```
awplus# configure terminal
awplus(config)# router bgp 10
awplus(config-router)# neighbor group1 peer-group
awplus(config-router)# neighbor 10.10.0.63 peer-group group1
```

This example shows a new peer-group `group1` and the removal of a neighbor `10.10.0.63` to the group.

```
awplus# configure terminal
awplus(config)# router bgp 10
awplus(config-router)# neighbor group1 peer-group
awplus(config-router)# no neighbor 10.10.0.63 peer-group group1
```

**Examples [BGP4+]** This example shows a new peer-group `group1` and the addition of a neighbor `2001:0db8:010d::1` to the group.

```
awplus# configure terminal
awplus(config)# router bgp 10
awplus(config-router)# neighbor group1 peer-group
awplus(config-router)# address-family ipv6
awplus(config-router-af)# neighbor peer-group
group1 2001:0db8:010d::1
```

This example shows a new peer-group `group1` and the removal of a neighbor `2001:0db8:010d::1` to the group.

```
awplus# configure terminal
awplus(config)# router bgp 10
awplus(config-router)# neighbor group1 peer-group
awplus(config-router)# address-family ipv6
awplus(config-router-af)# no neighbor peer-group
group1 2001:0db8:010d::1
```

**Related Commands** [neighbor peer-group \(create a peer-group\)](#)  
[neighbor port](#)



# neighbor peer-group (create a peer-group)

**Overview** Use this command to create a peer-group for BGP and BGP4+. Use the **no** variant of this command to disable this function.

**Syntax** `neighbor <peer-group> peer-group`  
`no neighbor <peer-group> peer-group`

| Parameter                       | Description                       |
|---------------------------------|-----------------------------------|
| <code>&lt;peer-group&gt;</code> | Enter the name of the peer-group. |

**Mode [BGP]** Router Configuration or IPv4 Address Family Configuration

**Mode [BGP4+]** Router Configuration

**Usage** Neighbors with the same update policies are grouped into peer groups. This facilitates the updates of various policies, such as, distribute and filter lists.

The peer-group is then configured easily with many of the neighbor commands. Any changes made to the peer group affect all members.

Use this command to create a peer-group, then use the [neighbor peer-group \(add a neighbor\)](#) command to add neighbors to the group.

**Examples**

```
awplus# configure terminal
awplus(config)# router bgp 10
awplus(config-router)# neighbor group1 peer-group
awplus# configure terminal
awplus(config)# router bgp 10
awplus(config-router)# no neighbor group1 peer-group
```

**Related Commands** [neighbor peer-group \(add a neighbor\)](#)

# neighbor port

**Overview** Use this command to specify the TCP port to which packets are sent to on a BGP or a BGP4+ neighbor. TCP port 179 is the default port used to connect BGP and BGP4+ peers. You can specify a different destination port for the TCP session with this command.

Use the **no** variant of this command to reset the port number back to the default value (TCP port 179).

**Syntax [BGP]** `neighbor <neighborid> port <portnum>`  
`no neighbor <neighborid> port [<portnum>]`

| Parameter                       | Description                                                                                                                                                                                                                                                                                                                |
|---------------------------------|----------------------------------------------------------------------------------------------------------------------------------------------------------------------------------------------------------------------------------------------------------------------------------------------------------------------------|
| <code>&lt;neighborid&gt;</code> | { <code>&lt;ip-address&gt;</code>   <code>ipv6-addr</code> }   <code>&lt;peer-group&gt;</code>                                                                                                                                                                                                                             |
| <code>&lt;ip-address&gt;</code> | Specify the address of an IPv4 BGP neighbor, in dotted decimal notation A.B.C.D.                                                                                                                                                                                                                                           |
| <code>&lt;ipv6-addr&gt;</code>  | Specify the address of an IPv6 BGP4+ neighbor, entered in hexadecimal in the format X:X::X:X.                                                                                                                                                                                                                              |
| <code>&lt;peer-group&gt;</code> | Enter the name of an existing peer-group. For information on how to create peer groups, refer to the <a href="#">neighbor peer-group (add a neighbor)</a> command, and <a href="#">neighbor route-map</a> command. When this parameter is used with this command, the command applies on all peers in the specified group. |
| <code>&lt;portnum&gt;</code>    | <code>&lt;0-65535&gt;</code> Specifies the TCP port number.                                                                                                                                                                                                                                                                |

**Default** TCP port 179 is the default port used to connect BGP and BGP4+ peers.

**Mode [BGP]** Router Configuration or IPv4 Address Family Configuration

**Mode [BGP4+]** Router Configuration

**Examples [BGP]**

```
awplus# configure terminal
awplus(config)# router bgp 12
awplus(config-router)# neighbor 10.10.10.10 port 643
awplus# configure terminal
awplus(config)# router bgp 12
awplus(config-router)# no neighbor 10.10.10.10 port 643
awplus# configure terminal
awplus(config)# router bgp 12
awplus(config-router)# neighbor group1 peer-group
awplus(config-router)# neighbor 10.10.10.1 remote-as 10
awplus(config-router)# neighbor 10.10.10.1 peer-group group1
awplus(config-router)# neighbor group1 port 643
awplus# configure terminal
awplus(config)# router bgp 12
awplus(config-router)# no neighbor group1 port 643
```

**Examples [BGP4+]**

```
awplus# configure terminal
awplus(config)# router bgp 12
awplus(config-router)# neighbor port 6432001:0db8:010d::1
awplus# configure terminal
awplus(config)# router bgp 12
awplus(config-router)# no neighbor port 6432001:0db8:010d::1
awplus# configure terminal
awplus(config)# router bgp 12
awplus(config-router)# neighbor group1 peer-group
awplus(config-router)# neighbor 2001:0db8:010d::1 remote-as 10
awplus(awplus-router)# address-family ipv6
awplus(config-router-af)# neighbor 2001:0db8:010d::1
peer-group group1
awplus(config-router-af)# exit
awplus(config-router)# neighbor group1 port 643
awplus# configure terminal
awplus(config)# router bgp 12
awplus(config-router)# no neighbor group1 port 643
```

**Related Commands** [neighbor peer-group \(add a neighbor\)](#)  
[neighbor route-map](#)

# neighbor prefix-list

**Overview** Use this command to distribute BGP and BGP4+ neighbor information as specified in a prefix list.

Use the **no** variant of this command to remove an entry.

**Syntax** `neighbor <neighborid> prefix-list <listname> {in|out}`  
`no neighbor <neighborid> prefix-list <listname> {in|out}`

| Parameter                       | Description                                                                                                                                                                                                                                                                                                                                                                                                                                                                                                                                                                                                                                                                                                            |
|---------------------------------|------------------------------------------------------------------------------------------------------------------------------------------------------------------------------------------------------------------------------------------------------------------------------------------------------------------------------------------------------------------------------------------------------------------------------------------------------------------------------------------------------------------------------------------------------------------------------------------------------------------------------------------------------------------------------------------------------------------------|
| <code>&lt;neighborid&gt;</code> | <code>&lt;ip-address&gt;</code>   <code>&lt;ipv6-addr&gt;</code>   <code>{&lt;peer-group&gt;}</code><br><code>&lt;ip-address&gt;</code> Specify the address of an IPv4 BGP neighbor, in dotted decimal notation A.B.C.D.<br><code>&lt;ipv6-addr&gt;</code> Specify the address of an IPv6 BGP4+ neighbor, entered in hexadecimal in the format X:X::X:X.<br><code>&lt;peer-group&gt;</code> Enter the name of an existing peer-group. For information on how to create peer groups, refer to the <a href="#">neighbor peer-group (add a neighbor)</a> command, and <a href="#">neighbor route-map</a> command. When this parameter is used with this command, the command applies on all peers in the specified group. |
| <code>&lt;listname&gt;</code>   | The name of an IP prefix list.                                                                                                                                                                                                                                                                                                                                                                                                                                                                                                                                                                                                                                                                                         |
| <code>in</code>                 | Specifies that the IP prefix list applies to incoming advertisements.                                                                                                                                                                                                                                                                                                                                                                                                                                                                                                                                                                                                                                                  |
| <code>out</code>                | Specifies that the IP prefix list applies to outgoing advertisements.                                                                                                                                                                                                                                                                                                                                                                                                                                                                                                                                                                                                                                                  |

**Mode [BGP]** Router Configuration or IPv4 Address Family Configuration

**Mode [BGP4+]** IPv6 Address Family Configuration

**Usage** Use this command to specify a prefix list for filtering BGP or BGP4+ advertisements. Filtering by prefix list matches the prefixes of routes with those listed in the prefix list. If there is a match, the route is used. An empty prefix list permits all prefixes. If a given prefix does not match any entries of a prefix list, the route is denied access.

The router begins the search at the top of the prefix list, with the sequence number 1. Once a match or deny occurs, the router does not need to go through the rest of the prefix list. For efficiency the most common matches or denies are listed at the top.

The **neighbor distribute-list** command is an alternative to the **neighbor prefix-list** command and only one of them can be used for filtering to the same neighbor in any direction.

**Examples [BGP]**

```
awplus# configure terminal
awplus(config)# ip prefix-list list1 deny 30.0.0.0/24
awplus(config)# router bgp 10
awplus(config-router)# neighbor 10.10.10.1 prefix-list list1 in
awplus# configure terminal
awplus(config)# router bgp 10
awplus(config-router)# no neighbor 10.10.10.1 prefix-list list1
in
awplus# configure terminal
awplus(config)# ip prefix-list list1 deny 30.0.0.0/24
awplus(config)# router bgp 10
awplus(config-router)# address-family ipv4
awplus(config-router-af)# neighbor 10.10.10.1 prefix-list list1
in
awplus# configure terminal
awplus(config)# router bgp 10
awplus(config-router)# address-family ipv4
awplus(config-router-af)# no neighbor 10.10.10.1 prefix-list
list1 in
awplus# configure terminal
awplus(config)# ip prefix-list list1 deny 30.0.0.0/24
awplus(config)# router bgp 10
awplus(config-router)# neighbor group1 peer-group
awplus(config-router)# neighbor 10.10.10.1 remote-as 10
awplus(config-router)# neighbor 10.10.10.1 peer-group group1
awplus(config-router)# neighbor group1 prefix-list list1 in
awplus# configure terminal
awplus(config)# router bgp 10
awplus(config-router)# no neighbor group1 prefix-list list1 in
```

**Examples**  
**[BGP4+]**

```
awplus# configure terminal
awplus(config)# ipv6 prefix-list list1 deny
2001:0db8:010d::1/128

awplus(config)# router bgp 10
awplus(config-router)# address-family ipv6
awplus(config-router-af)# neighbor 2001:0db8:: prefix-list
list1 in

awplus# configure terminal
awplus(config)# router bgp 10
awplus(config-router)# address-family ipv6
awplus(config-router-af)# no neighbor 2001:0db8:: prefix-list
list1 in

awplus# configure terminal
awplus(config)# ip prefix-list list1 deny 2001:0db8:010d::1/128
awplus(config)# router bgp 10
awplus(config-router)# neighbor group1 peer-group
awplus(config-router)# neighbor 2001:0db8:010d::1 remote-as 10
awplus(config-router)# address-family ipv6
awplus(config-router-af)# neighbor 2001:0db8:010d::1
peer-group group1
awplus(config-router-af)# neighbor group1 prefix-list list1 in
awplus# configure terminal
awplus(config)# router bgp 10
awplus(config-router)# address-family ipv6
awplus(config-router-af)# no neighbor group1 prefix-list list1
in
```

**Related**  
**Commands**

- [ip prefix-list \(IPv4 Prefix List\)](#)
- [neighbor peer-group \(add a neighbor\)](#)
- [neighbor route-map](#)

# neighbor remote-as

**Overview** Use this command to configure an internal or external BGP or BGP4+ (iBGP or eBGP) peering relationship with another router.

Use the **no** variant of this command to remove a previously configured BGP or BGP4+ peering relationship.

**Syntax** `neighbor <neighborid> remote-as <as-number>`  
`no neighbor <neighborid> remote-as <as-number>`

**Syntax (VRF- lite)** `neighbor <neighborid> remote-as <as-number> [global|vrf <vrf-name>]`  
`no neighbor <neighborid> remote-as <as-number>`

| Parameter    | Description                                                                                                                                                                                                                                                                                                                |
|--------------|----------------------------------------------------------------------------------------------------------------------------------------------------------------------------------------------------------------------------------------------------------------------------------------------------------------------------|
| <neighborid> | {<ip-address>   ipv6-addr   <peer-group>}                                                                                                                                                                                                                                                                                  |
| <ip-address> | Specify the address of an IPv4 BGP neighbor, in dotted decimal notation A.B.C.D.                                                                                                                                                                                                                                           |
| <ipv6-addr>  | Specify the address of an IPv6 BGP4+ neighbor, entered in hexadecimal in the format X:X::X:X.                                                                                                                                                                                                                              |
| <peer-group> | Enter the name of an existing peer-group. For information on how to create peer groups, refer to the <a href="#">neighbor peer-group (add a neighbor)</a> command, and <a href="#">neighbor route-map</a> command. When this parameter is used with this command, the command applies on all peers in the specified group. |
| <as-number>  | <1-4294967295> Neighbor's Autonomous System (AS) number.                                                                                                                                                                                                                                                                   |
| global       | Specify that the remote neighbor exists locally within the device, in the global routing domain                                                                                                                                                                                                                            |
| vrf          | Specify that the remote neighbor exists locally within the device, in the specified VRF instance.                                                                                                                                                                                                                          |
| <vrf-name>   | The name of the VRF instance.                                                                                                                                                                                                                                                                                              |

**Mode [BGP]** Router Configuration or IPv4 Address Family Configuration

**Mode [BGP4+]** Router Configuration

**Usage** This command is used to configure iBGP and eBGP peering relationships with other BGP or BGP4+ neighbors. A peer-group support of this command is configured only after creating a specific peer-group. Use the **no** variant of this command to remove a previously configured BGP peering relationship.

The **vrf** and **global** parameters are used to create internal 'loopback' BGP connections within the device between two VRF instances. This is used to leak BGP routes between a named VRF instance and the global routing instance. This requires BGP neighbors to be configured in both the global routing instance and in the named VRF instance.

**Examples [BGP]** To configure a BGP peering relationship from the neighbor with the IPv4 address 10.10.0.73 with another router:

```
awplus# configure terminal
awplus(config)# router bgp 10
awplus(config-router)# neighbor 10.10.0.73 remote-as 10
```

To remove a configured BGP peering relationship from the neighbor with the IPv4 address 10.10.0.73 from another router:

```
awplus# configure terminal
awplus(config)# router bgp 10
awplus(config-router)# no neighbor 10.10.0.73 remote-as 10
```

To configure a BGP peering relationship from the neighbor with the peer group named group1 with another router:

```
awplus# configure terminal
awplus(config)# router bgp 10
awplus(config-router)# neighbor group1 peer-group
awplus(config-router)# neighbor 10.10.10.1 remote-as 10
awplus(config-router)# neighbor 10.10.10.1 peer-group group1
awplus(config-router)# neighbor group1 remote-as 10
```

To remove a configured BGP peering relationship from the neighbor with the peer group named group1 with another router:

```
awplus# configure terminal
awplus(config)# router bgp 10
awplus(config-router)# no neighbor group1 remote-as 10
```

**Examples [BGP4+]** To configure a BGP4+ peering relationship with another router:

```
awplus# configure terminal
awplus(config)# router bgp 11
awplus(config-router)# neighbor 2001:0db8:010d::1 remote-as 345
```

To remove a configured BGP4+ peering relationship from another router:

```
awplus# configure terminal
awplus(config)# router bgp 11
awplus(config-router)# no neighbor 2001:0db8:010d::1 remote-as 345
```



To configure a BGP4+ peering relationship from the neighbor with the peer group named group1 with another router:

```
awplus# configure terminal
awplus(config)# router bgp 10
awplus(config-router)# neighbor group1 peer-group
awplus(config-router)# neighbor 2001:0db8:010d::1 remote-as 10
awplus(config-router)# address-family ipv6
awplus(config-router-af)# neighbor 2001:0db8:010d::1
peer-group group1
awplus(config-router-af)# exit
awplus(config-router)# neighbor group1 remote-as 10
```

To remove a configured BGP4+ peering relationship from the neighbor with the peer group named group1 with another router:

```
awplus# configure terminal
awplus(config)# router bgp 10
awplus(config-router)# no neighbor group1 remote-as 10
```

**Command  
changes**

Version 5.4.6-2.1: VRF-lite support added.

# neighbor remove-private-AS (BGP only)

**Overview** Use this command to remove the private Autonomous System (AS) number from external outbound updates. Use the **no** variant of this command to revert to the default (disabled).

**Syntax** `neighbor <neighborid> remove-private-AS`  
`no neighbor <neighborid> remove-private-AS`

| Parameter    | Description                                                                                                                                                                                                                                                                                                   |
|--------------|---------------------------------------------------------------------------------------------------------------------------------------------------------------------------------------------------------------------------------------------------------------------------------------------------------------|
| <neighborid> | { <ip-address>   <tag> }                                                                                                                                                                                                                                                                                      |
| <ip-address> | The address of an IPv4 BGP neighbor, in dotted decimal notation A.B.C.D.                                                                                                                                                                                                                                      |
| <tag>        | Name of an existing peer-group. For information on how to create peer groups, refer to the <a href="#">neighbor peer-group (add a neighbor)</a> command, and <a href="#">neighbor remote-as</a> command. When this parameter is used with a command, the command applies on all peers in the specified group. |

**Default** This command is disabled by default.

**Mode** Router Configuration or IPv4 Address Family Configuration

**Usage** The private AS numbers range from <64512-65535>. Private AS numbers are not advertised to the Internet. This command is used with external BGP peers only. The router removes the AS numbers only if the update includes private AS numbers. If the update includes both private and public AS numbers, the system treats it as an error.

This command removes private AS numbers for BGP in Router Configuration mode. This command is not supported for BGP4+ in IPv6 Address Family Configuration mode. This command removes a private AS number and makes an update packet with a public AS number as the AS path attribute. So only public AS numbers are entered in Internet BGP routing tables, and private AS numbers are not entered in Internet BGP tables.

For the filtering to apply, both peering devices must be set to use either 2-byte or extended 4- byte ASN (with the same ASN type set on both peers). For example, if a device (which defaults to use a 4-byte ASN), is peered with a device that defaults to a 2-byte ASN, then the device using a 2-byte ASN device also needs to be configured with the command **bgp extended-asn-cap** for the filtering to apply.

**Examples** awplus# configure terminal  
awplus(config)# router bgp 10  
awplus(config-router)# neighbor 10.10.0.63 remove-private-AS  
awplus# configure terminal  
awplus(config)# router bgp 10  
awplus(config-router)# no neighbor 10.10.0.63 remove-private-AS

**Related  
Commands** [show ip bgp \(BGP only\)](#)

# neighbor restart-time

**Overview** Use this command to set a different restart-time other than the global restart-time configured using the **bgp graceful-restart** command for BGP and BGP4+.

Use the **no** variant of this command to restore the device to its default state (see the default value of the **bgp graceful-restart** command).

**Syntax** `neighbor <neighborid> restart-time <delay-value>`  
`no neighbor <neighborid> restart-time <delay-value>`

| Parameter                        | Description                                                                                                                                                                                                                                                                                                                |
|----------------------------------|----------------------------------------------------------------------------------------------------------------------------------------------------------------------------------------------------------------------------------------------------------------------------------------------------------------------------|
| <code>&lt;neighborid&gt;</code>  | { <code>&lt;ip-address&gt;</code>   <code>&lt;ipv6-addr&gt;</code>   <code>&lt;peer-group&gt;</code> }                                                                                                                                                                                                                     |
| <code>&lt;ip-address&gt;</code>  | Specify the address of an IPv4 BGP neighbor, in dotted decimal notation A.B.C.D.                                                                                                                                                                                                                                           |
| <code>&lt;ipv6-addr&gt;</code>   | Specify the address of an IPv6 BGP4+ neighbor, entered in hexadecimal in the format X:X::X:X.                                                                                                                                                                                                                              |
| <code>&lt;peer-group&gt;</code>  | Enter the name of an existing peer-group. For information on how to create peer groups, refer to the <a href="#">neighbor peer-group (add a neighbor)</a> command, and <a href="#">neighbor route-map</a> command. When this parameter is used with this command, the command applies on all peers in the specified group. |
| <code>&lt;delay-value&gt;</code> | <code>&lt;1-3600&gt;</code> Delay value in seconds.                                                                                                                                                                                                                                                                        |

**Mode [BGP]** Router Configuration or IPv4 Address Family Configuration

**Mode [BGP4+]** Router Configuration

**Usage** This command takes precedence over the restart-time value specified using the **bgp graceful-restart** command.

The restart-time value is the maximum time that a graceful-restart neighbor waits to come back up after a restart. The default is 120 seconds.

Make sure that the restart time specified using this command does not exceed the stalepath-time specified in the Router Configuration mode.

**Examples [BGP]**

```
awplus# configure terminal
awplus(config)# router bgp 10
awplus(config-router)# neighbor 10.10.10.1 restart-time 45
awplus# configure terminal
awplus(config)# router bgp 10
awplus(config-router)# no neighbor 10.10.10.1 restart-time 45
awplus# configure terminal
awplus(config)# router bgp 10
awplus(config-router)# neighbor group1 peer-group
awplus(config-router)# neighbor 10.10.10.1 remote-as 10
awplus(config-router)# neighbor 10.10.10.1 peer-group group1
awplus(config-router)# neighbor group1 restart-time 45
awplus# configure terminal
awplus(config)# router bgp 10
awplus(config-router)# no neighbor group1 restart-time 45
```

**Examples [BGP4+]**

```
awplus# configure terminal
awplus(config)# router bgp 10
awplus(config-router)# neighbor 2001:0db8:010d::1 restart-time 45
awplus# configure terminal
awplus(config)# router bgp 10
awplus(config-router)# no neighbor 2001:0db8:010d::1 restart-time 45
awplus# configure terminal
awplus(config)# router bgp 10
awplus(config-router)# neighbor group1 peer-group
awplus(config-router)# neighbor 2001:0db8:010d::1 remote-as 10
awplus(config-router)# address-family ipv6
awplus(config-router-af)# neighbor 2001:0db8:010d::1 peer-group group1
awplus(config-router-af)# exit
awplus(config-router)# neighbor group1 restart-time 45
awplus# configure terminal
awplus(config)# router bgp 10
awplus(config-router)# no neighbor group1 restart-time 45
```

**Related Commands**

- [bgp graceful-restart](#)
- [neighbor peer-group \(add a neighbor\)](#)
- [neighbor route-map](#)

# neighbor route-map

**Overview** Use this command to apply a route map to incoming or outgoing routes for BGP or BGP4+.

Use the **no** variant of this command to remove a route map from a BGP or BGP4+ route.

**Syntax** `neighbor <neighborid> route-map <mapname> {in|out}`  
`no neighbor <neighborid> route-map <mapname> {in|out}`

| Parameter    | Description                                                                                                                                                                                                                                                                                                                |
|--------------|----------------------------------------------------------------------------------------------------------------------------------------------------------------------------------------------------------------------------------------------------------------------------------------------------------------------------|
| <neighborid> | {<ip-address>   ipv6-addr>   <peer-group>}                                                                                                                                                                                                                                                                                 |
| <ip-address> | Specify the address of an IPv4 BGP neighbor, in dotted decimal notation A.B.C.D.                                                                                                                                                                                                                                           |
| <ipv6-addr>  | Specify the address of an IPv6 BGP4+ neighbor, entered in hexadecimal in the format X:X::X:X.                                                                                                                                                                                                                              |
| <peer-group> | Enter the name of an existing peer-group. For information on how to create peer groups, refer to the <a href="#">neighbor peer-group (add a neighbor)</a> command, and <a href="#">neighbor route-map</a> command. When this parameter is used with this command, the command applies on all peers in the specified group. |
| <mapname>    | Specifies name of the route-map.                                                                                                                                                                                                                                                                                           |
| in           | Specifies that the access list applies to incoming advertisements.                                                                                                                                                                                                                                                         |
| out          | Specifies that the access list applies to outgoing advertisements.                                                                                                                                                                                                                                                         |

**Mode [BGP]** Router Configuration or IPv4 Address Family Configuration

**Mode [BGP4+]** IPv6 Address Family Configuration

**Usage** Use the **neighbor route-map** command to filter updates and modify attributes. A route map is applied to inbound or outbound updates. Only the routes that pass the route map are sent or accepted in updates.

**Examples [BGP]** The following example shows the configuration of the route-map name **rmap2** and then the use of this map name in the **neighbor route-map** command for the neighbor with the IPv4 address 10.10.10.1 in the Router Configuration mode.

```
awplus# configure terminal
awplus(config)# route-map rmap2 permit 6
awplus(config-route-map)# match origin incomplete
awplus(config-route-map)# set metric 100
awplus(config-route-map)# exit
awplus(config)# router bgp 10
awplus(config-router)# neighbor 10.10.10.1 route-map rmap2 in
```

The following example shows the removal of the route-map name **rmap2** in the **neighbor route-map** command for the neighbor with the IPv4 address 10.10.10.1 in the Router Configuration mode.

```
awplus# configure terminal
awplus(config)# router bgp 10
awplus(config-router)# no neighbor 10.10.10.1 route-map rmap2
in
```

The following example shows the configuration of the route-map name **rmap2** and then the use of this map name in the **neighbor route-map** command for the neighbor with the IPv4 address 10.10.10.1 in the IPv4 Address Family Configuration mode.

```
awplus# configure terminal
awplus(config)# route-map rmap2 permit 6
awplus(config-route-map)# match origin incomplete
awplus(config-route-map)# set metric 100
awplus(config-route-map)# exit
awplus(config)# router bgp 10
awplus(config-router)# address-family ipv4
awplus(config-router-af)# neighbor 10.10.10.1 route-map rmap2
in
```

The following example shows the removal of the route-map name **rmap2** in the **neighbor route-map** command for the neighbor with the IPv4 address 10.10.10.1 in the IPv4 Address Family Configuration mode.

```
awplus# configure terminal
awplus(config)# router bgp 10
awplus(config-router)# address-family ipv4
awplus(config-router-af)# no neighbor 10.10.10.1 route-map
rmap2 in
```

The following example shows the configuration of the route-map name **rmap2** and then the use of this map name in the **neighbor route-map** command for the neighbor with the peer group named group1 in the Router Configuration mode.

```
awplus# configure terminal
awplus(config)# route-map rmap2 permit 6
awplus(config-route-map)# match origin incomplete
awplus(config-route-map)# set metric 100
awplus(config-route-map)# exit
awplus(config)# router bgp 10
awplus(config-router)# neighbor group1 peer-group
awplus(config-router)# neighbor 10.10.10.1 remote-as 10
awplus(config-router)# neighbor 10.10.10.1 peer-group group1
awplus(config-router)# neighbor group1 route-map rmap2 in
```

The following example shows the removal the route-map name **rmap2** in the **neighbor route-map** command for the neighbor with the peer group named group1 in the Router Configuration mode.

```
awplus# configure terminal
awplus(config)# router bgp 10
awplus(config-router)# no neighbor group1 route-map rmap2 in
```

**Examples**  
**[BGP4+]**

The following example shows the configuration of the route-map name **rmap2** and then the use of this map name in the **neighbor route-map** command for the neighbor with the IPv6 address 2001:0db8:010d::1 in the IPv6 Address Family Configuration mode.

```
awplus# configure terminal
awplus(config)# route-map rmap2 permit 6
awplus(config-route-map)# match origin incomplete
awplus(config-route-map)# set metric 100
awplus(config-route-map)# exit
awplus(config)# router bgp 10
awplus(config-router)# address-family ipv6
awplus(config-router-af)# neighbor 2001:0db8:010d::1 route-map
rmap2 in
```

The following example shows the removal of the route-map name **rmap2** in the **neighbor route-map** command for the neighbor with the IPv6 address 2001:0db8:010d::1 in the IPv6 Address Family Configuration mode.

```
awplus# configure terminal
awplus(config)# router bgp 10
awplus(config-router)# address-family ipv6
awplus(config-router-af)# no neighbor 2001:0db8:010d::1
route-map rmap2 in
```



The following example shows the configuration of the route-map name **rmap2** and then the use of this map name in the **neighbor route-map** command for the neighbor with the peer group named group1 in the Router Configuration mode.

```
awplus# configure terminal
awplus(config)# route-map rmap2 permit 6
awplus(config-route-map)# match origin incomplete
awplus(config-route-map)# set metric 100
awplus(config-route-map)# exit
awplus(config)# router bgp 10
awplus(config-router)# neighbor group1 peer-group
awplus(config-router)# neighbor 2001:0db8:010d::1 remote-as 10
awplus(config-router)# address-family ipv6
awplus(config-router-af)# neighbor 2001:0db8:010d::1
peer-group group1
awplus(config-router-af)# neighbor group1 route-map rmap2 in
```

The following example shows the removal the route-map name **rmap2** in the **neighbor route-map** command for the neighbor with the peer group named group1 in the Router Configuration mode.

```
awplus# configure terminal
awplus(config)# router bgp 10
awplus(config-router)# address-family ipv6
awplus(config-router-af)# no neighbor group1 route-map rmap2 in
```

**Related  
Commands**

[address-family](#)  
[neighbor peer-group \(add a neighbor\)](#)  
[route-map](#)

# neighbor route-reflector-client (BGP only)

**Overview** Use this command to configure the router as a BGP route reflector and configure the specified neighbor as its client.

Use the **no** variant of this command to indicate that the neighbor is not a client.

**Syntax** `neighbor <neighborid> route-reflector-client`  
`no neighbor <neighborid> route-reflector-client`

| Parameter    | Description                                                                                                                                                                                                                                                                                                                |
|--------------|----------------------------------------------------------------------------------------------------------------------------------------------------------------------------------------------------------------------------------------------------------------------------------------------------------------------------|
| <neighborid> | {<ip-address> <peer-group>}                                                                                                                                                                                                                                                                                                |
| <ip-address> | The address of an IPv4 BGP neighbor, in dotted decimal notation A.B.C.D.                                                                                                                                                                                                                                                   |
| <peer-group> | Enter the name of an existing peer-group. For information on how to create peer groups, refer to the <a href="#">neighbor peer-group (add a neighbor)</a> command, and <a href="#">neighbor route-map</a> command. When this parameter is used with this command, the command applies on all peers in the specified group. |

**Mode** Router Configuration or IPv4 Address Family Configuration

**Usage** Route reflectors are a solution for the explosion of iBGP peering within an autonomous system. By route reflection the number of iBGP peers within an AS is reduced. Use the **neighbor route-reflector-client** command to configure the local router as the route reflector and specify neighbors as its client.

An AS can have more than one route reflector. One route reflector treats the other route reflector as another iBGP speaker.

In the following configuration, Router1 is the route reflector for clients 3.3.3.3 and 2.2.2.2; it also has a non-client peer 6.6.6.6:

```
Router1#
router bgp 200
neighbor 3.3.3.3 remote-as 200
neighbor 3.3.3.3 route-reflector-client
neighbor 2.2.2.2 remote-as 200
neighbor 2.2.2.2 route-reflector-client
neighbor 6.6.6.6 remote-as 200
```

**Examples** awplus# configure terminal  
awplus(config)# router bgp 10  
awplus(config-router)# neighbor 10.10.0.72  
route-reflector-client  
awplus# configure terminal  
awplus(config)# router bgp 10  
awplus(config-router)# no neighbor 10.10.0.72  
route-reflector-client

# neighbor route-server-client (BGP only)

**Overview** Use this command to specify the peer as route server client.  
Use the **no** variant of this command to disable this function.

**Syntax** neighbor <neighborid> route-server-client  
no neighbor <neighborid> route-server-client

| Parameter    | Description                                                                                                                                                                                                                                                                                                                |
|--------------|----------------------------------------------------------------------------------------------------------------------------------------------------------------------------------------------------------------------------------------------------------------------------------------------------------------------------|
| <neighborid> | {<ip-address> <peer-group>}                                                                                                                                                                                                                                                                                                |
| <ip-address> | The address of an IPv4 BGP neighbor, in dotted decimal notation A.B.C.D.                                                                                                                                                                                                                                                   |
| <peer-group> | Enter the name of an existing peer-group. For information on how to create peer groups, refer to the <a href="#">neighbor peer-group (add a neighbor)</a> command, and <a href="#">neighbor route-map</a> command. When this parameter is used with this command, the command applies on all peers in the specified group. |

**Mode** Router Configuration

**Examples**

```
awplus# configure terminal
awplus(config)# router bgp 10
awplus(config-router)# neighbor 10.10.0.72 route-server-client
awplus# configure terminal
awplus(config)# router bgp 10
awplus(config-router)# no neighbor 10.10.0.72
route-server-client
```

# neighbor send-community

**Overview** Use this command to specify that a community attribute should be sent to a BGP or BGP4+ neighbor.

Use the **no** variant of this command to remove the entry for the community attribute.

**Syntax** `neighbor <neighborid> send-community {both|extended|standard}`  
`no neighbor <neighborid> send-community {both|extended|standard}`

| Parameter                       | Description                                                                                                                                                                                                                                                                                                                                                                                                                                                                                                                                                                                                                                                                                              |
|---------------------------------|----------------------------------------------------------------------------------------------------------------------------------------------------------------------------------------------------------------------------------------------------------------------------------------------------------------------------------------------------------------------------------------------------------------------------------------------------------------------------------------------------------------------------------------------------------------------------------------------------------------------------------------------------------------------------------------------------------|
| <code>&lt;neighborid&gt;</code> | <code>{&lt;ip-address&gt;   &lt;ipv6-addr&gt;   &lt;peer-group&gt;}</code><br><br><code>&lt;ip-address&gt;</code> Specify the address of an IPv4 BGP neighbor, in dotted decimal notation A.B.C.D.<br><br><code>&lt;ipv6-addr&gt;</code> Specify the address of an IPv6 BGP4+ neighbor, entered in hexadecimal in the format X:X::X:X.<br><br><code>&lt;peer-group&gt;</code> Enter the name of an existing peer-group. For information on how to create peer groups, refer to the <a href="#">neighbor peer-group (add a neighbor)</a> command, and <a href="#">neighbor route-map</a> command. When this parameter is used with this command, the command applies on all peers in the specified group. |
| <code>both</code>               | Sends Standard and Extended Community attributes. Specifying this parameter with the <b>no</b> variant of this command results in no <code>standard</code> or <code>extended</code> community attributes being sent.                                                                                                                                                                                                                                                                                                                                                                                                                                                                                     |
| <code>extended</code>           | Sends Extended Community attributes. Specifying this parameter with the <b>no</b> variant of this command results in no <code>extended</code> community attributes being sent.                                                                                                                                                                                                                                                                                                                                                                                                                                                                                                                           |
| <code>standard</code>           | Sends Standard Community attributes. Specifying this parameter with the <b>no</b> variant of this command results in no <code>standard</code> community attributes being sent.                                                                                                                                                                                                                                                                                                                                                                                                                                                                                                                           |

**Default** Both **standard** and **extended** community attributes are sent to a neighbor.

**Mode [BGP]** Router Configuration or IPv4 Address Family Configuration

**Mode [BGP4+]** Router Configuration and IPv6 Address Family Configuration

**Usage** This command is used to specify a community attribute to be sent to a neighbor. The community attribute groups destinations in a certain community and applies routing decisions according to those communities. On receiving community attributes the router reannounces them to the neighbor. Only when the **no**

parameter is used with this command the community attributes are not reannounced to the neighbor.

By default, both **standard** and **extended** community attributes are sent to a neighbor.

**Examples [BGP]**

```
awplus# configure terminal
awplus(config)# bgp config-type standard
awplus(config)# router bgp 10
awplus(config-router)# neighbor 10.10.0.72 send-community
extended

awplus# configure terminal
awplus(config)# bgp config-type standard
awplus(config)# router bgp 10
awplus(config-router)# no neighbor 10.10.0.72 send-community
extended

awplus# configure terminal
awplus(config)# bgp config-type standard
awplus(config)# router bgp 10
awplus(config-router)# address-family ipv4
awplus(config-router-af)# neighbor 10.10.0.72 send-community
extended

awplus# configure terminal
awplus(config)# bgp config-type standard
awplus(config)# router bgp 10
awplus(config-router)# address-family ipv4
awplus(config-router-af)# no neighbor 10.10.0.72 send-community
extended

awplus# configure terminal
awplus(config)# bgp config-type standard
awplus(config)# router bgp 10
awplus(config-router)# neighbor group1 peer-group
awplus(config-router)# neighbor 10.10.10.1 remote-as 10
awplus(config-router)# neighbor 10.10.10.1 peer-group group1
awplus(config-router)# neighbor group1 send-community extended
```

**Examples**  
**[BGP4+]**

```
awplus# configure terminal
awplus(config)# bgp config-type standard
awplus(config)# router bgp 10
awplus(config-router)# neighbor 2001:0db8:010d::1
send-community extended
awplus# configure terminal
awplus(config)# bgp config-type standard
awplus(config)# router bgp 10
awplus(config-router)# no neighbor 2001:0db8:010d::1
send-community extended
awplus# configure terminal
awplus(config)# bgp config-type standard
awplus(config)# router bgp 10
awplus(config-router)# address-family ipv6
awplus(config-router-af)# neighbor 2001:0db8:010d::1
send-community extended
awplus# configure terminal
awplus(config)# bgp config-type standard
awplus(config)# router bgp 10
awplus(config-router)# address-family ipv6
awplus(config-router-af)# no neighbor 2001:0db8:010d::1
send-community extended
awplus# configure terminal
awplus(config)# bgp config-type standard
awplus(config)# router bgp 10
awplus(config-router)# neighbor group1 peer-group
awplus(config-router)# neighbor 2001:0db8:010d::1 remote-as 10
awplus(config-router)# address-family ipv6
awplus(config-router-af)# neighbor 2001:0db8:010d::1
peer-group group1
awplus(config-router-af)# exit
awplus(config-router)# neighbor group1 send-community extended
awplus# configure terminal
awplus(config)# bgp config-type standard
awplus(config)# router bgp 10
awplus(config-router)# no neighbor group1 send-community
extended
```

**Related**  
**Commands**

- [bgp config-type](#)
- [neighbor peer-group \(add a neighbor\)](#)
- [neighbor route-map](#)

# neighbor shutdown

**Overview** Use this command to disable a peering relationship with a BGP or BGP4+ neighbor. Use the **no** variant of this command to re-enable the BGP or BGP4+ neighbor.

**Syntax** neighbor <neighborid> shutdown  
no neighbor <neighborid> shutdown

| Parameter    | Description                                                                                                                                                                                                                                                                                                                |
|--------------|----------------------------------------------------------------------------------------------------------------------------------------------------------------------------------------------------------------------------------------------------------------------------------------------------------------------------|
| <neighborid> | { <ip-address>   <peer-group> }                                                                                                                                                                                                                                                                                            |
| <ip-address> | Specify the address of an IPv4 BGP neighbor, in dotted decimal notation A.B.C.D.                                                                                                                                                                                                                                           |
| <ipv6-addr>  | Specify the address of an IPv6 BGP4+ neighbor, entered in hexadecimal in the format X:X::X:X.                                                                                                                                                                                                                              |
| <peer-group> | Enter the name of an existing peer-group. For information on how to create peer groups, refer to the <a href="#">neighbor peer-group (add a neighbor)</a> command, and <a href="#">neighbor route-map</a> command. When this parameter is used with this command, the command applies on all peers in the specified group. |

**Mode [BGP]** Router Configuration or IPv4 Address Family Configuration

**Mode [BGP4+]** Router Configuration

**Usage** This command shuts down any active session for the specified BGP or BGP4+ neighbor and clears all related routing data.

**Examples [BGP]**

```
awplus# configure terminal
awplus(config)# router bgp 10
awplus(config-router)# neighbor 10.10.0.72 shutdown
awplus# configure terminal
awplus(config)# router bgp 10
awplus(config-router)# no neighbor 10.10.0.72 shutdown
awplus# configure terminal
awplus(config)# router bgp 10
awplus(config-router)# neighbor group1 shutdown
awplus# configure terminal
awplus(config)# router bgp 10
awplus(config-router)# no neighbor group1 shutdown
```



**Examples**  
**[BGP4+]**

```
awplus# configure terminal
awplus(config)# router bgp 10
awplus(config-router)# neighbor 2001:0db8:010d::1 shutdown
awplus# configure terminal
awplus(config)# router bgp 10
awplus(config-router)# no neighbor 2001:0db8:010d::1 shutdown
awplus# configure terminal
awplus(config)# router bgp 10
awplus(config-router)# neighbor group1 shutdown
awplus# configure terminal
awplus(config)# router bgp 10
awplus(config-router)# no neighbor group1 shutdown
```

**Related** [neighbor peer-group \(add a neighbor\)](#)  
**Commands** [neighbor route-map](#)

# neighbor soft-reconfiguration inbound

**Overview** Use this command to configure the device to start storing all updates from the BGP or BGP4+ neighbor, without any consideration of any inward route filtering policy that might be applied to the connection with this BGP or BGP4+ neighbor. This is so that the full set of the neighbor's updates are available locally to be used in a soft-reconfiguration event.

You may need to apply this older method of clearing routes if the peer does not support route refresh.

Use the **no** variant of this command to disable this function for a BGP or BGP4+ neighbor.

**Syntax** `neighbor <neighborid> soft-reconfiguration inbound`  
`no neighbor <neighborid> soft-reconfiguration inbound`

| Parameter    | Description                                                                                                                                                                                                                                                                                                                |
|--------------|----------------------------------------------------------------------------------------------------------------------------------------------------------------------------------------------------------------------------------------------------------------------------------------------------------------------------|
| <neighborid> | {<ip-address>   <ipv6-addr>   <peer-group>}                                                                                                                                                                                                                                                                                |
| <ip-address> | Specify the address of an IPv4 BGP neighbor, in dotted decimal notation A.B.C.D.                                                                                                                                                                                                                                           |
| <ipv6-addr>  | Specify the address of an IPv6 BGP4+ neighbor, entered in hexadecimal in the format X:X::X:X.                                                                                                                                                                                                                              |
| <peer-group> | Enter the name of an existing peer-group. For information on how to create peer groups, refer to the <a href="#">neighbor peer-group (add a neighbor)</a> command, and <a href="#">neighbor route-map</a> command. When this parameter is used with this command, the command applies on all peers in the specified group. |

**Mode [BGP]** Router Configuration or IPv4 Address Family Configuration

**Mode [BGP4+]** IPv6 Address Family Configuration

**Usage** Use this command to store updates for inbound soft reconfiguration. Soft-reconfiguration may be used in lieu of BGP route refresh capability. Using this command enables local storage of all the received routes and their attributes. This requires additional memory. When a soft reset (inbound) is done on this neighbor, the locally stored routes are re-processed according to the inbound policy. The BGP neighbor connection is not affected.

**Examples [BGP]**

```
awplus# configure terminal
awplus(config)# router bgp 12
awplus(config-router)# neighbor 10.10.10.10
soft-reconfiguration inbound
awplus# configure terminal
awplus(config)# router bgp 12
awplus(config-router)# no neighbor 10.10.10.10
soft-reconfiguration inbound
awplus# configure terminal
awplus(config)# router bgp 12
awplus(config-router)# address-family ipv4
awplus(config-router-
af)# neighbor 10.10.10.10 soft-reconfiguration inbound
awplus# configure terminal
awplus(config)# router bgp 12
awplus(config-router)# address-family ipv4
awplus(config-router-
af)# no neighbor 10.10.10.10 soft-reconfiguration inbound
awplus# configure terminal
awplus(config)# router bgp 10
awplus(config-router)# neighbor group1 peer-group
awplus(config-router)# neighbor 10.10.10.1 remote-as 10
awplus(config-router)# neighbor 10.10.10.1 peer-group group1
awplus(config-router)# neighbor group1 soft-reconfiguration
inbound
awplus# configure terminal
awplus(config)# router bgp 12
awplus(config-router)# no neighbor group1 soft-reconfiguration
inbound
```

**Examples**  
**[BGP4+]**

```
awplus# configure terminal
awplus(config)# router bgp 12
awplus(config-router)# address-family ipv6
awplus(config-router-af)# neighbor 2001:0db8:010d::1
soft-reconfiguration inbound
awplus# configure terminal
awplus(config)# router bgp 12
awplus(config-router)# address-family ipv6
awplus(config-router-af)# no neighbor 2001:0db8:010d::1
soft-reconfiguration inbound
awplus# configure terminal
awplus(config)# router bgp 10
awplus(config-router)# neighbor group1 peer-group
awplus(config-router)# neighbor 2001:0db8:010d::1 remote-as 10
awplus(config-router)# address-family ipv6
awplus(config-router-af)# neighbor 2001:0db8:010d::1
peer-group group1
awplus(config-router-af)# neighbor group1 soft-reconfiguration
inbound
awplus# configure terminal
awplus(config)# router bgp 12
awplus(config-router)# address-family ipv6
awplus(config-router-
af)# no neighbor group1 soft-reconfiguration inbound
```

**Related**  
**Commands**

- [neighbor peer-group \(add a neighbor\)](#)
- [neighbor route-map](#)

# neighbor timers

**Overview** Use this command to set the keepalive, holdtime, and connect timers for a specific BGP or BGP4+ neighbor.

Use the **no** variant of this command to clear the timers for a specific BGP or BGP4+ neighbor.

**Syntax** `neighbor <neighborid> timers {<keepalive> <holdtime>|connect <connect>}`

`no neighbor <neighborid> timers [connect]`

| Parameter                       | Description                                                                                                                                                                                                                                                                                                                |
|---------------------------------|----------------------------------------------------------------------------------------------------------------------------------------------------------------------------------------------------------------------------------------------------------------------------------------------------------------------------|
| <code>&lt;neighborid&gt;</code> | <code>{&lt;ip-address&gt;   &lt;ipv6-addr&gt;   &lt;peer-group&gt;}</code>                                                                                                                                                                                                                                                 |
| <code>&lt;ip-address&gt;</code> | Specify the address of an IPv4 BGP neighbor, in dotted decimal notation A.B.C.D.                                                                                                                                                                                                                                           |
| <code>&lt;ipv6-addr&gt;</code>  | Specify the address of an IPv6 BGP4+ neighbor, entered in hexadecimal in the format X:X::X:X.                                                                                                                                                                                                                              |
| <code>&lt;peer-group&gt;</code> | Enter the name of an existing peer-group. For information on how to create peer groups, refer to the <a href="#">neighbor peer-group (add a neighbor)</a> command, and <a href="#">neighbor route-map</a> command. When this parameter is used with this command, the command applies on all peers in the specified group. |
| <code>&lt;keepalive&gt;</code>  | <code>&lt;0-65535&gt;</code> Frequency (in seconds) at which a router sends keepalive messages to its neighbor.                                                                                                                                                                                                            |
| <code>&lt;holdtime&gt;</code>   | <code>&lt;0-65535&gt;</code> Interval (in seconds) after which, on not receiving a keepalive message, the router declares a neighbor dead.                                                                                                                                                                                 |
| <code>&lt;connect&gt;</code>    | <code>connect &lt;1-65535&gt;</code> Specifies the connect timer in seconds. The default connect timer value is 120 seconds as per RFC 4271. Modify this value as needed for interoperability.                                                                                                                             |

**Default** The keepalive timer default is 60 seconds, the holdtime timer default is 90 seconds, and the connect timer default is 120 seconds as per RFC 4271. Holdtime is `keepalive * 3`.

**Mode [BGP]** Router Configuration or IPv4 Address Family Configuration

**Mode [BGP4+]** Router Configuration

**Usage** Keepalive messages are sent by a router to inform another router that the BGP connection between the two is still active. The keepalive interval is the period of time between each keepalive message sent by the router. The holdtime interval is the time the router waits to receive a keepalive message and if it does not receive

a message for this period it declares the neighbor dead. The holdtime value must be 3 times the value of the keepalive value.

**Examples [BGP]**

```
awplus# configure terminal
awplus(config)# router bgp 10
awplus(config-router)# neighbor 10.10.10.1 timers 60 120
awplus# configure terminal
awplus(config)# router bgp 10
awplus(config-router)# no neighbor 10.10.10.1 timers
awplus# configure terminal
awplus(config)# router bgp 10
awplus(config-router)# neighbor group1 peer-group
awplus(config-router)# neighbor 10.10.10.1 remote-as 10
awplus(config-router)# neighbor 10.10.10.1 peer-group group1
awplus(config-router)# neighbor group1 timers 60 120
awplus# configure terminal
awplus(config)# router bgp 10
awplus(config-router)# no neighbor group1 timers
```

**Examples [BGP4+]**

```
awplus# configure terminal
awplus(config)# router bgp 10
awplus(config-router)# neighbor 2001:0db8:010d::1 timers 60 120
awplus# configure terminal
awplus(config)# router bgp 10
awplus(config-router)# no neighbor 2001:0db8:010d::1 timers
awplus# configure terminal
awplus(config)# router bgp 10
awplus(config-router)# neighbor group1 peer-group
awplus(config-router)# neighbor 2001:0db8:010d::1 remote-as 10
awplus(config-router)# address-family ipv6
awplus(config-router-af)# neighbor 2001:0db8:010d::1
peer-group group1
awplus(config-router-af)# exit
awplus(config-router)# neighbor group1 timers 60 120
awplus# configure terminal
awplus(config)# router bgp 10
awplus(config-router)# no neighbor group1 timers
```

**Related  
Commands** neighbor peer-group (add a neighbor)  
neighbor route-map  
show ip bgp neighbors hold-time (BGP only)  
show ip bgp neighbors keepalive-interval (BGP only)  
timers (BGP)

# neighbor transparent-as

**Overview** Use this command to specify not to append your AS path number even if the BGP or BGP4+ peer is an eBGP peer.

Note this command has the same effect as invoking [neighbor attribute-unchanged](#) and specifying the optional **as-path** parameter.

**Syntax** neighbor <neighborid> transparent-as

| Parameter    | Description                                                                                                                                                                                                                                                                                                                |
|--------------|----------------------------------------------------------------------------------------------------------------------------------------------------------------------------------------------------------------------------------------------------------------------------------------------------------------------------|
| <neighborid> | {<ip-address>   <ipv6-addr>   <peer-group>}                                                                                                                                                                                                                                                                                |
| <ip-address> | Specify the address of an IPv4 BGP neighbor, in dotted decimal notation A.B.C.D.                                                                                                                                                                                                                                           |
| <ipv6-addr>  | Specify the address of an IPv6 BGP4+ neighbor, entered in hexadecimal in the format X:X::X:X.                                                                                                                                                                                                                              |
| <peer-group> | Enter the name of an existing peer-group. For information on how to create peer groups, refer to the <a href="#">neighbor peer-group (add a neighbor)</a> command, and <a href="#">neighbor route-map</a> command. When this parameter is used with this command, the command applies on all peers in the specified group. |

**Mode** Router Configuration

**Examples [BGP]**

```
awplus# configure terminal
awplus(config)# router bgp 10
awplus(config-router)# neighbor 10.10.10.1 transparent-as
awplus# configure terminal
awplus(config)# router bgp 10
awplus(config-router)# neighbor group1 peer-group
awplus(config-router)# neighbor 10.10.10.1 remote-as 10
awplus(config-router)# neighbor 10.10.10.1 peer-group group1
awplus(config-router)# neighbor group1 transparent-as
```



**Examples**  
**[BGP4+]**

```
awplus# configure terminal
awplus(config)# router bgp 10
awplus(config-router)# neighbor 2001:0db8:010d::1
transparent-as
awplus# configure terminal
awplus(config)# router bgp 10
awplus(config-router)# neighbor group1 peer-group
awplus(config-router)# neighbor 2001:0db8:010d::1 remote-as 10
awplus(config-router)# address-family ipv6
awplus(config-router-af)# neighbor 2001:0db8:010d::1
peer-group group1
awplus(config-router-af)# exit
awplus(config-router)# neighbor group1 transparent-as
```

**Related**  
**Commands**

- [neighbor attribute-unchanged](#)
- [neighbor peer-group \(add a neighbor\)](#)
- [neighbor route-map](#)
- [neighbor transparent-nexthop](#)

# neighbor transparent-nextthop

**Overview** Use this command to keep the next hop value of the route even if the BGP or BGP4+ peer is an eBGP peer.

Note this command has the same effect as invoking [neighbor attribute-unchanged](#) and specifying the optional **next-hop** parameter.

**Syntax** `neighbor <neighborid> transparent-nextthop`

| Parameter    | Description                                                                                                                                                                                                                                                                                                                |
|--------------|----------------------------------------------------------------------------------------------------------------------------------------------------------------------------------------------------------------------------------------------------------------------------------------------------------------------------|
| <neighborid> | {<ip-address>   <ipv6-addr>   <peer-group>}                                                                                                                                                                                                                                                                                |
| <ip-address> | Specify the address of an IPv4 BGP neighbor, in dotted decimal notation A.B.C.D.                                                                                                                                                                                                                                           |
| <ipv6-addr>  | Specify the address of an IPv6 BGP4+ neighbor, entered in hexadecimal in the format X:X::X:X.                                                                                                                                                                                                                              |
| <peer-group> | Enter the name of an existing peer-group. For information on how to create peer groups, refer to the <a href="#">neighbor peer-group (add a neighbor)</a> command, and <a href="#">neighbor route-map</a> command. When this parameter is used with this command, the command applies on all peers in the specified group. |

**Mode** Router Configuration

**Examples [BGP]**

```
awplus# configure terminal
awplus(config)# router bgp 10
awplus(config-router)# neighbor 10.10.10.1 transparent-nextthop
awplus# configure terminal
awplus(config)# router bgp 10
awplus(config-router)# neighbor group1 peer-group
awplus(config-router)# neighbor 10.10.10.1 remote-as 10
awplus(config-router)# neighbor 10.10.10.1 peer-group group1
awplus(config-router)# neighbor group1 transparent-nextthop
```

**Examples**  
**[BGP4+]**

```
awplus# configure terminal
awplus(config)# router bgp 10
awplus(config-router)# neighbor 2001:0db8:010d::1
transparent-nexthop
awplus# configure terminal
awplus(config)# router bgp 10
awplus(config-router)# neighbor group1 peer-group
awplus(config-router)# neighbor 2001:0db8:010d::1 remote-as 10
awplus(config-router)# address-family ipv6
awplus(config-router-af)# neighbor 2001:0db8:010d::1
peer-group group1
awplus(config-router-af)# exit
awplus(config-router)# neighbor group1 transparent-nexthop
```

**Related**  
**Commands**

- [neighbor attribute-unchanged](#)
- [neighbor peer-group \(add a neighbor\)](#)
- [neighbor route-map](#)
- [neighbor transparent-as](#)

# neighbor unsuppress-map

**Overview** Use this command to selectively leak more specific routes to a particular BGP or BGP4+ neighbor.

Use the **no** variant of this command to remove selectively leaked specific routes to a particular BGP or BGP4+ neighbor.

**Syntax** `neighbor <neighborid> unsuppress-map <route-map-name>`  
`no neighbor <neighborid> unsuppress-map <route-map-name>`

| Parameter        | Description                                                                                                                                                                                                                                                                                                                |
|------------------|----------------------------------------------------------------------------------------------------------------------------------------------------------------------------------------------------------------------------------------------------------------------------------------------------------------------------|
| <neighborid>     | { <ip-address>   <ipv6-addr>   <peer-group> }                                                                                                                                                                                                                                                                              |
| <ip-address>     | Specify the address of an IPv4 BGP neighbor, in dotted decimal notation A.B.C.D.                                                                                                                                                                                                                                           |
| <ipv6-addr>      | Specify the address of an IPv6 BGP4+ neighbor, entered in hexadecimal in the format X:X::X:X.                                                                                                                                                                                                                              |
| <peer-group>     | Enter the name of an existing peer-group. For information on how to create peer groups, refer to the <a href="#">neighbor peer-group (add a neighbor)</a> command, and <a href="#">neighbor route-map</a> command. When this parameter is used with this command, the command applies on all peers in the specified group. |
| <route-map-name> | The name of the route-map used to select routes to be unsuppressed.                                                                                                                                                                                                                                                        |

**Mode [BGP]** Router Configuration or IPv4 Address Family Configuration

**Mode [BGP4+]** IPv6 Address Family Configuration

**Usage** When the [aggregate-address](#) command is used with the **summary-only** option, the more-specific routes of the aggregate are suppressed to all neighbors. Use this command instead to selectively leak more-specific routes to a particular neighbor.

**Examples [BGP]**

```
awplus# configure terminal
awplus(config)# router bgp 10
awplus(config-router)# neighbor 10.10.0.73 unsuppress-map mymap
awplus# configure terminal
awplus(config)# router bgp 10
awplus(config-router)# address-family ipv4 unicast
awplus(config-router-af)# neighbor 10.10.0.70 unsuppress-map
mymap
awplus# configure terminal
awplus(config)# router bgp 10
awplus(config-router)# no neighbor 10.10.0.73 unsuppress-map
mymap
awplus# configure terminal
awplus(config)# router bgp 10
awplus(config-router)# address-family ipv4 unicast
awplus(config-router-af)# no neighbor 10.10.0.70 unsuppress-map
mymap
awplus# configure terminal
awplus(config)# router bgp 10
awplus(config-router)# neighbor group1 peer-group
awplus(config-router)# neighbor 10.10.10.1 remote-as 10
awplus(config-router)# neighbor 10.10.10.1 peer-group group1
awplus(config-router)# neighbor group1 unsuppress-map mymap
awplus# configure terminal
awplus(config)# router bgp 10
awplus(config-router)# no neighbor group1 unsuppress-map mymap
```

**Examples**  
**[BGP4+]**

```
awplus# configure terminal
awplus(config)# router bgp 10
awplus(config-router)# address-family ipv6 unicast
awplus(config-router-af)# neighbor 2001:0db8:010d::1
unsuppress-map mymap

awplus# configure terminal
awplus(config)# router bgp 10
awplus(config-router)# address-family ipv6 unicast
awplus(config-router-af)# no neighbor 2001:0db8:010d::1
unsuppress-map mymap

awplus# configure terminal
awplus(config)# router bgp 10
awplus(config-router)# neighbor group1 peer-group
awplus(config-router)# neighbor 2001:0db8:010d::1 remote-as 10
awplus(config-router)# address-family ipv6
awplus(config-router-af)# neighbor 2001:0db8:010d::1
peer-group group1
awplus(config-router-af)# neighbor group1 unsuppress-map mymap

awplus# configure terminal
awplus(config)# router bgp 10
awplus(config-router)# address-family ipv6
awplus(config-router-af)# no neighbor group1 unsuppress-map
mymap
```

**Related**  
**Commands**

- [aggregate-address](#)
- [neighbor peer-group \(add a neighbor\)](#)
- [neighbor route-map](#)

# neighbor update-source

**Overview** Use this command to specify the source IPv4 or IPv6 address of BGP or BGP4+ packets, which are sent to the neighbor for routing updates, as the IPv4 or IPv6 address configured on the specified interface. The specified interface is usually the local loopback (lo) interface to allow internal BGP or BGP4+ connections to stay up regardless of which interface is used to reach a neighbor.

Use the **no** variant of this command to remove the IPv4 or IPv6 address from the interface as the source IPv4 or IPv6 address of BGP or BGP4+ packets sent to the neighbor, and restores the interface assignment to the closest interface, which is also called the best local address.

**Syntax** `neighbor <neighborid> update-source <interface>`  
`no neighbor <neighborid> update-source`

| Parameter                       | Description                                                                                                                                                                                                                                                                                                                |
|---------------------------------|----------------------------------------------------------------------------------------------------------------------------------------------------------------------------------------------------------------------------------------------------------------------------------------------------------------------------|
| <code>&lt;neighborid&gt;</code> | { <code>&lt;ip-address&gt;</code>   <code>&lt;ipv6-addr&gt;</code>   <code>&lt;peer-group&gt;</code> }                                                                                                                                                                                                                     |
| <code>&lt;ip-address&gt;</code> | Specify the address of an IPv4 BGP neighbor, in dotted decimal notation A.B.C.D.                                                                                                                                                                                                                                           |
| <code>&lt;ipv6-addr&gt;</code>  | Specify the address of an IPv6 BGP4+ neighbor, entered in hexadecimal in the format X:X::X:X.                                                                                                                                                                                                                              |
| <code>&lt;peer-group&gt;</code> | Enter the name of an existing peer-group. For information on how to create peer groups, refer to the <a href="#">neighbor peer-group (add a neighbor)</a> command, and <a href="#">neighbor route-map</a> command. When this parameter is used with this command, the command applies on all peers in the specified group. |
| <code>&lt;interface&gt;</code>  | Specifies the local loopback interface (lo).                                                                                                                                                                                                                                                                               |

**Default** Use of this command sets a default value of 2 for the maximum hop count.

**Mode [BGP]** Router Configuration or IPv4 Address Family Configuration

**Mode [BGP4+]** Router Configuration

**Usage** Use this command in conjunction with any specified interface on the router. The local loopback interface is the interface that is most commonly used with this command. The use of local loopback interface eliminates a dependency and BGP or BGP4+ does not have to rely on the availability of a particular interface for making BGP or BGP4+ peer relationships.

**Examples [BGP]** To source BGP connections for neighbor 10.10.0.72 with the IP address of the local loopback address instead of the best local address, enter the commands listed below:

```
awplus(config)# interface lo
awplus(config-if)# ip address 10.10.0.73/24
awplus(config-if)# exit
awplus(config)# router bgp 100
awplus(config-router)# network 10.10.0.0
awplus(config-router)# neighbor 10.10.0.72 remote-as 110
awplus(config-router)# neighbor 10.10.0.72 update-source lo
```

To remove BGP connections for neighbor 10.10.0.72 with the IP address of the local loopback address instead of the best local address, enter the commands listed below:

```
awplus(config)# router bgp 100
awplus(config-router)# no neighbor 10.10.0.72 update-source
```

To source BGP connections for neighbor group1 with the IP address of the local loopback address instead of the best local address, enter the commands listed below:

```
awplus(config)# interface lo
awplus(config-if)# ip address 10.10.0.73/24
awplus(config-if)# exit
awplus(config)# router bgp 100
awplus(config-router)# network 10.10.0.0
awplus(config-router)# neighbor group1 peer-group
awplus(config-router)# neighbor 10.10.0.72 remote-as 100
awplus(config-router)# neighbor 10.10.0.72 peer-group group1
awplus(config-router)# neighbor group1 update-source lo
```

To remove BGP connections for neighbor group1 with the IP address of the local loopback address instead of the best local address, enter the commands listed below:

```
awplus(config)# router bgp 100
awplus(config-router)# neighbor group1 update-source lo
```



**Examples** To source BGP connections for neighbor 2001:0db8:010d::1 with the IPv6 address of the local loopback address instead of the best local address, enter the commands listed below:  
**[BGP4+]**

```
awplus(config)# interface lo
awplus(config-if)# ipv6 address 2001:0db8:010d::1/128
awplus(config-if)# exit
awplus(config)# router bgp 100
awplus(config-router)# neighbor 2001:0db8:010d::1 remote-as 110
awplus(config-router)# neighbor 2001:0db8:010d::1
update-source lo
```

To remove BGP connections for neighbor 2001:0db8:010d::1 with the IPv6 address of the local loopback address instead of the best local address, enter the commands listed below:

```
awplus(config)# router bgp 100
awplus(config-router)# no neighbor 2001:0db8:010d::1
update-source
```

To source BGP connections for neighbor group1 with the IPv6 address of the local loopback address instead of the best local address, enter the commands listed below:

```
awplus(config)# interface lo
awplus(config-if)# ipv6 address 2001:0db8:010d::1/128
awplus(config-if)# exit
awplus(config)# router bgp 100
awplus(config-router)# neighbor group1 peer-group
awplus(config-router)# neighbor 2001:0db8:010d::1 remote-as 100
awplus(config-router)# address-family ipv6
awplus(config-router-
af)# neighbor 2001:0db8:010d::1 peer-group group1
awplus(config-router-
af)# exit
awplus(config-router)# neighbor group1 update-source lo
```

To remove BGP connections for neighbor group1 with the IPv6 address of the local loopback address instead of the best local address, enter the commands listed below:

```
awplus(config)# router bgp 100
awplus(config-router)# neighbor group1 update-source lo
```

**Related Commands** [neighbor peer-group \(add a neighbor\)](#)  
[neighbor route-map](#)

# neighbor version (BGP only)

**Overview** Use this command to configure the device to accept only a particular BGP version. Use the **no** variant of this command to use the default BGP version (version 4).

**Syntax** `neighbor <neighborid> version <version>`  
`no neighbor <neighborid> version`

| Parameter    | Description                                                                                                                                                                                                                                                                                                                             |
|--------------|-----------------------------------------------------------------------------------------------------------------------------------------------------------------------------------------------------------------------------------------------------------------------------------------------------------------------------------------|
| <neighborid> | { <ip-address>   <peer-group> }                                                                                                                                                                                                                                                                                                         |
|              | <ip-address> The address of an IPv4 BGP neighbor, in dotted decimal notation A.B.C.D.                                                                                                                                                                                                                                                   |
|              | <peer-group> Enter the name of an existing peer-group. For information on how to create peer groups, refer to the <a href="#">neighbor peer-group (add a neighbor)</a> command, and <a href="#">neighbor route-map</a> command. When this parameter is used with this command, the command applies on all peers in the specified group. |
| <version>    | {4} Specifies the BGP version number.                                                                                                                                                                                                                                                                                                   |

**Mode** Router Configuration or IPv4 Address Family Configuration

**Usage** By default, the system uses BGP version 4 and on request dynamically negotiates down to version 2. Using this command disables the router's version-negotiation capability and forces the router to use only a specified version with the neighbor.

**Examples**

```
awplus# configure terminal
awplus(config)# router bgp 10
awplus(config-router)# neighbor 10.10.10.1 version 4
awplus# configure terminal
awplus(config)# router bgp 10
awplus(config-router)# neighbor group1 peer-group
awplus(config-router)# neighbor 10.10.10.1 remote-as 10
awplus(config-router)# neighbor 10.10.10.1 peer-group group1
awplus(config-router)# neighbor group1 version 4
awplus# configure terminal
awplus(config)# router bgp 10
awplus(config-router)# no neighbor 10.10.10.1 version
awplus# configure terminal
awplus(config)# router bgp 10
awplus(config-router)# no neighbor group1 version
```

**Related Commands**

- [neighbor peer-group \(add a neighbor\)](#)
- [neighbor route-map](#)

# neighbor weight

**Overview** Use this command to set default weights for routes from this BGP or BGP4+ neighbor.

Use the **no** variant of this command to remove a weight assignment.

**Syntax** `neighbor <neighborid> weight <weight>`  
`no neighbor <neighborid> weight [<weight>]`

| Parameter                                                                                                                                                                                                                                                                                                                                                  | Description                                                                                                                  |
|------------------------------------------------------------------------------------------------------------------------------------------------------------------------------------------------------------------------------------------------------------------------------------------------------------------------------------------------------------|------------------------------------------------------------------------------------------------------------------------------|
| <code>&lt;neighborid&gt;</code>                                                                                                                                                                                                                                                                                                                            | <code>{&lt;ip-address&gt; &lt;ipv6-addr&gt; &lt;peer-group&gt;}</code>                                                       |
|                                                                                                                                                                                                                                                                                                                                                            | <code>&lt;ip-address&gt;</code> Specify the address of an IPv4 BGP neighbor, in dotted decimal notation A.B.C.D.             |
|                                                                                                                                                                                                                                                                                                                                                            | <code>&lt;ipv6-addr&gt;</code> Specify the address of an IPv6 BGP4+ neighbor, entered in hexadecimal in the format X:X::X:X. |
| <code>&lt;peer-group&gt;</code> Enter the name of an existing peer-group. For information on how to create peer groups, refer to the <a href="#">neighbor peer-group (add a neighbor)</a> command, and <a href="#">neighbor route-map</a> command. When this parameter is used with this command, the command applies on all peers in the specified group. |                                                                                                                              |
| <code>&lt;weight&gt;</code>                                                                                                                                                                                                                                                                                                                                | <code>&lt;0-65535&gt;</code> Specifies the weight this command assigns to the route.                                         |

**Mode [BGP]** Router Configuration or IPv4 Address Family Configuration

**Mode [BGP4+]** IPv6 Address Family Configuration

**Usage** Use this command to specify a weight value to all routes learned from a BGP or BGP4+ neighbor. The route with the highest weight gets preference when there are other routes on the network.

Unlike the local-preference attribute, the weight attribute is relevant only to the local router.

The weights assigned using the **set weight** command overrides the weights assigned using this command.

**Examples [BGP]**

```
awplus# configure terminal
awplus(config)# router bgp 10
awplus(config-router)# neighbor 10.10.10.1 weight 60
awplus# configure terminal
awplus(config)# router bgp 10
awplus(config-router)# no neighbor 10.10.10.1 weight
awplus# configure terminal
awplus(config)# router bgp 10
awplus(config-router)# address-family ipv4
awplus(config-router-af)# neighbor 10.10.10.1 weight 60
awplus# configure terminal
awplus(config)# router bgp 10
awplus(config-router)# address-family ipv4
awplus(config-router-af)# no neighbor 10.10.10.1 weight
awplus# configure terminal
awplus(config)# router bgp 10
awplus(config-router)# neighbor group1 peer-group
awplus(config-router)# neighbor 10.10.10.1 remote-as 10
awplus(config-router)# neighbor 10.10.10.1 peer-group group1
awplus(config-router)# neighbor group1 weight 60
awplus# configure terminal
awplus(config)# router bgp 10
awplus(config-router)# no neighbor group1 weight
```

**Examples**  
**[BGP4+]**

```
awplus# configure terminal
awplus(config)# router bgp 10
awplus(config-router)# address-family ipv6
awplus(config-router-af)# neighbor 2001:0db8:010d::1 weight 60
awplus# configure terminal
awplus(config)# router bgp 10
awplus(config-router)# address-family ipv6
awplus(config-router-af)# no neighbor 2001:0db8:010d::1 weight
awplus# configure terminal
awplus(config)# router bgp 10
awplus(config-router)# neighbor group1 peer-group
awplus(config-router)# neighbor 2001:0db8:010d::1 remote-as 10
awplus(config-router)# address-family ipv6
awplus(config-router-af)# neighbor 2001:0db8:010d::1
peer-group group1
awplus(config-router-af)# neighbor group1 weight 60
awplus# configure terminal
awplus(config)# router bgp 10
awplus(config-router)# address-family ipv6
awplus(config-router-af)# no neighbor group1 weight
```

**Related**  
**Commands**

- [neighbor peer-group \(add a neighbor\)](#)
- [neighbor route-map](#)

# network (BGP and BGP4+)

**Overview** Use this command to specify particular routes to be advertised into the BGP or BGP4+ routing process. A unicast network address without a mask is accepted if it falls into the natural boundary of its class. A class-boundary mask is derived if the address matches its natural class-boundary.

Note that you can specify a prefix length for the prefix being added, and you can also specify a classful network without a prefix length and an appropriate prefix length is added. Note that specifying a non-classful prefix without a prefix length results in a /32 prefix length on an IPv4 route.

Use the **no** variant of this command to remove a network route entry.

**Syntax [BGP]** `network {<ip-prefix/length>|<ip-network-addr>} [mask <network-mask>] [route-map <route-map-name>] [backdoor]`  
`no network {<ip-prefix/length>|<ip-network-addr>} [mask <network-mask>] [route-map <route-map-name>] [backdoor]`

**Syntax [BGP4+]** `network {<ipv6-prefix/length>|<ipv6-network-addr>} [route-map <route-map-name>]`  
`no network {<ipv6-prefix/length>|<ipv6-network-addr>} [route-map <route-map-name>]`

| Parameter                               | Description                                                                                                                                                                                     |
|-----------------------------------------|-------------------------------------------------------------------------------------------------------------------------------------------------------------------------------------------------|
| <code>&lt;ip-prefix/length&gt;</code>   | IP network prefix and prefix length entered in dotted decimal format for the IP network prefix, then slash notation for the prefix length in the format A.B.C.D/M, e.g. 192.168.1.224/27        |
| <code>&lt;ip-network-addr&gt;</code>    | IP network prefix entered in dotted decimal format A.B.C.D, e.g. 192.168.1.224                                                                                                                  |
| <code>&lt;network-mask&gt;</code>       | Specify a network mask in the format A.B.C.D, e.g. 255.255.255.224.                                                                                                                             |
| <code>&lt;ipv6-prefix/length&gt;</code> | IPv6 network prefix and prefix length entered in dotted decimal format for the IPv6 network prefix, then slash notation for the IPv6 prefix length in the format X:X::X/X/M, e.g. 2001:db8::/64 |
| <code>&lt;ipv6-network-addr&gt;</code>  | IP network prefix entered in dotted decimal format A.B.C.D, e.g. 192.168.1.224                                                                                                                  |
| <code>&lt;route-map-name&gt;</code>     | Specify the name of the route map.                                                                                                                                                              |
| <code>backdoor</code>                   | Specify a BGP backdoor route that is not advertised.                                                                                                                                            |

**Mode [BGP]** Router Configuration and IPv4 Address Family [ipv4 unicast] mode

**Mode [BGP4+]** IPv6 Address Family Configuration

**Usage** It does not matter how the route is arranged in the IP or IPv6 routing table. The route can arrive in the IP routing table by a static route, or the route can be learned from OSPF or OSPFv3 or RIP or RIPng routing.

If you configure a route-map, then that route-map will be used in filtering the network, or the route-map will be used to modify the attributes that are advertised with the route.

**Example [BGP]** The following example illustrates a Class-A address configured as a network route. The natural Class-A network prefix mask length of 8 will be internally derived, that is, 2.0.0.0/8.

```
awplus(config)# router bgp 100
awplus(config-router)# network 2.0.0.0
```

**Output [BGP]** Figure 31-1: Example output from the **show running-config** command after entering **network 2.0.0.0**

```
awplus#show running-config
router bgp 100
network 2.0.0.0/8
```

**Example [BGP]** The following example illustrates a network address which does not fall into its natural class boundary, and hence, is perceived as a host route, that is, 192.0.2.224/27.

```
awplus(config)# router bgp 100
awplus(config-router)# network 192.0.2.224 mask 255.255.255.224
```

**Output [BGP]** Figure 31-2: Example output from the **show running-config** command after entering **network 192.0.2.224 mask 255.255.255.224**

```
awplus#show running-config
router bgp 100
network 192.0.2.224/27
```

**Example [BGP]** The following example is the same as the previous example for host route 192.0.2.224/27, but is entered in prefix/length format using slash notation (instead of prefix plus mask in dotted decimal format using the **mask** keyword before the network mask in dotted decimal format):

```
awplus(config)# router bgp 100
awplus(config-router)# network 192.0.2.224/27
```

**Example [BGP4+]** The following example is the same as the previous example for host route 2001:db8::/32:

```
awplus(config)# router bgp 100
awplus(config-router)# address-family ipv6
awplus(config-router-af)# network 2001:db8::/32
```



**Output [BGP4+]** Figure 31-3: Example output from the **show running-config** command after entering **network 2001:db8::/32**

```
awplus#show running-config

router bgp 100
 network 2001:db8::/32
```

# network synchronization

**Overview** Use this command to ensure the exact same static network prefix, specified through any of the **network** commands, is local or has IGP reachability before introduction to BGP or BGP4+.

Use the **no** variant of this command to disable this function.

**Syntax** `network synchronization`  
`no network synchronization`

**Default** Network synchronization is disabled by default.

**Mode [BGP]** Router Configuration and IPv4 Address Family [ipv4 unicast] Configuration

**Mode [BGP4+]** IPv6 Address Family [ipv6 unicast] Configuration

**Examples [BGP]** The following example enables IGP synchronization of BGP static network routes in the Router Configuration mode.

```
awplus# configure terminal
awplus(config)# router bgp 11
awplus(config-router)# network synchronization
```

The following example enables IGP synchronization of BGP static network routes in the IPv4-Unicast address family.

```
awplus# configure terminal
awplus(config)# router bgp 11
awplus(config-router)# address-family ipv4 unicast
awplus(config-router-af)# network synchronization
```

**Example [BGP4+]** The following example enables IGP synchronization of BGP4+ static network routes in the IPv6-Unicast address family.

```
awplus# configure terminal
awplus(config)# router bgp 11
awplus(config-router)# address-family ipv6 unicast
awplus(config-router-af)# network synchronization
```

# redistribute (into BGP or BGP4+)

**Overview** Use this command to inject routes from one routing process into a BGP or BGP4+ routing table.

Use the **no** variant of this command to disable this function.

**Syntax** redistribute {ospf|rip|connected|static} [route-map  
<route-map-entry-pointer>]  
  
no redistribute {ospf|rip|connected|static} [route-map  
<route-map-entry-pointer>]

| Parameter                 | Description                                                                               |
|---------------------------|-------------------------------------------------------------------------------------------|
| connected                 | Specifies the redistribution of connected routes for both BGP and BGP4+.                  |
| ospf                      | Specifies the redistribution of OSPF information for BGP or OSPFv3 information for BGP4+. |
| rip                       | Specifies the redistribution of RIP information for BGP or RIPng information for BGP4+.   |
| static                    | Specifies the redistribution of Static routes for both BGP and BGP4+.                     |
| route-map                 | Route map reference for both BGP and BGP4+.                                               |
| <route-map-entry-pointer> | Pointer to route-map entries.                                                             |

**Mode [BGP]** Router Configuration or IPv4 Address Family Configuration

**Mode [BGP4+]** Router Configuration or IPv6 Address Family Configuration

**Usage** Redistribution is used by routing protocols to advertise routes that are learned by some other means, such as by another routing protocol or by static routes. Since all internal routes are dumped into BGP, careful filtering is applied to make sure that only routes to be advertised reach the internet, not everything. This command allows redistribution by injecting prefixes from one routing protocol into another routing protocol.

**Examples [BGP/ BGP+]** The following example shows the configuration of a route-map named `rmap1`, which is then applied using the **redistribute route-map** command.

```
awplus# configure terminal
awplus(config)# route-map rmap1 permit 1
awplus(config-route-map)# match origin incomplete
awplus(config-route-map)# set metric 100
awplus(config-route-map)# exit
awplus(config)# router bgp 12
awplus(config-router)# redistribute ospf route-map rmap1
```

To apply the above example to a specific VRF instance named `blue`, use the following commands:

```
awplus(config)# router bgp 12
awplus(config-router)# address-family ipv4 vrf blue
awplus(config-router-af)# redistribute ospf route-map rmap1
```

The following example shows the configuration of a route-map named `rmap2`, which is then applied using the **redistribute route-map** command.

```
awplus# configure terminal
awplus(config)# route-map rmap2 permit 3
awplus(config-route-map)# match interface vlan1
awplus(config-route-map)# set metric-type 1
awplus(config-route-map)# exit
awplus(config)# router ospf 100
awplus(config-router)# redistribute bgp route-map rmap2
```

Note that configuring a route-map and applying it with the `redistribute route-map` command allows you to filter which routes are distributed from another routing protocol (such as OSPF with BGP). A route-map can also set the metric, tag, and metric-type of the redistributed routes.

**Command changes** Version 5.4.6-2.1: VRF-lite support added.

# restart bgp graceful (BGP only)

**Overview** Use this command to force the device to perform a graceful BGP restart.

**Syntax** `restart bgp graceful`

**Mode** Privileged Exec

**Usage** Before using this command, BGP graceful-restart capabilities must be enabled within the router BGP ([bgp graceful-restart](#) command), and each neighbor configured on the device should be set to advertise its graceful-restart capability ([bgp graceful-restart graceful-reset](#) command). The neighbor devices also need to have BGP graceful-restart capabilities enabled ([bgp graceful-restart](#) command).

This command stops the whole BGP process and makes the device retain the BGP routes and mark them as stale. Receiving BGP speakers, retain and mark as stale all BGP routes received from the restarting speaker for all the address families received in the Graceful Restart Capability exchange.

When a **restart bgp graceful** command is issued, the BGP configuration is reloaded from the last saved configuration. Ensure you first issue a **copy running-config startup-config**.

**Example** `awplus# restart bgp graceful`

**Related Commands** [bgp graceful-restart](#)  
[bgp graceful-restart graceful-reset](#)

# router bgp

**Overview** Use this command to configure a BGP routing process, specifying the 32-bit Autonomous System (AS) number.

Use the **no** variant of this command to disable a BGP routing process, specifying the 32-bit AS number.

**Syntax** router bgp <asn>  
no router bgp <asn>

| Parameter | Description                                                        |
|-----------|--------------------------------------------------------------------|
| <asn>     | <1-4294967295> Specifies the 32-bit Autonomous System (AS) number. |

**Mode** Global Configuration

**Usage** The **router bgp** command enables a BGP routing process:

```
router bgp 1
 neighbor 10.0.0.1 remote-as 1
 neighbor 10.0.0.2 remote-as 1
 !
router bgp 2
 neighbor 10.0.0.3 remote-as 2
 neighbor 10.0.0.4 remote-as 2
```

**Examples**

```
awplus# configure terminal
awplus(config)# router bgp 12
awplus(config-router)#
awplus# configure terminal
awplus(config)# no router bgp 12
awplus(config)#
```

# route-map

**Overview** Use this command to configure a route map entry, and to specify whether the device will process or discard matching routes.

The device uses a name to identify the route map, and a sequence number to identify each entry in the route map.

The **route-map** command puts you into route-map configuration mode. In this mode, you can use the following:

- one or more of the **match** commands to create match clauses. These specify what routes match the entry.
- one or more of the **set** commands to create set clauses. These change the attributes of matching routes.

Use the **no** variant of this command to delete a route map or to delete an entry from a route map.

**Syntax**

```
route-map <mapname> {deny|permit} <seq>
no route-map <mapname>
no route-map <mapname> {deny|permit} <seq>
```

| Parameter | Description                                                                                                               |
|-----------|---------------------------------------------------------------------------------------------------------------------------|
| <mapname> | A name to identify the route map.                                                                                         |
| deny      | The route map causes a routing process to discard matching routes.                                                        |
| permit    | The route map causes a routing process to use matching routes.                                                            |
| <seq>     | <1-65535> The sequence number of the entry. You can use this parameter to control the order of entries in this route map. |

**Mode** Global Configuration

**Usage** Route maps allow you to control and modify routing information by filtering routes and setting route attributes. You can apply route maps when the device:

- processes BGP update messages that it has received from a peer
- prepares BGP update messages to send to peers
- redistributes routes from one routing protocol into another
- redistributes static routes into routing protocols
- uses BGP route flap dampening

When a routing protocol passes a route through a route map, it checks the entries in order of their sequence numbers, starting with the lowest numbered entry.

If it finds a match on a route map with an action of permit, then it applies any set clauses and accepts the route. Having found a match, the route is not compared against any further entries of the route map.

If it finds a match on a route map with an action of deny, it will discard the matching route.

If it does not find a match, it discards the route. This means that route maps end with an implicit deny entry. To permit all non-matching routes, end your route map with an entry that has an action of **permit** and no match clause.

**Examples** To enter route-map mode for entry 1 of the route map called "route1", and then add a match and set clause to it, use the commands:

```
awplus# configure terminal
awplus(config)# route-map route1 permit 1
awplus(config-route-map)# match as-path 60
awplus(config-route-map)# set weight 70
```

To enter route-map mode for entry 2 of the route map called "route1", and then add a match and set clause to it, use the commands:

```
awplus# configure terminal
awplus(config)# route-map route1 permit 2
awplus(config-route-map)# match interface vlan2
awplus(config-route-map)# set metric 20
```

Note how the prompt changes when you go into route map configuration mode.

To make the device process non-matching routes instead of discarding them, add a command like the following one:

```
awplus(config)# route-map route1 permit 100
```

**Related  
Commands**

For BGP:

- [show route-map](#)
- [bgp dampening](#)
- [neighbor default-originate](#)
- [neighbor route-map](#)
- [neighbor unsuppress-map](#)
- [network \(BGP and BGP4+\)](#)
- [redistribute \(into BGP or BGP4+\)](#)
- [show ip bgp route-map \(BGP only\)](#)

For OSPF:

- [default-information originate](#)
- [redistribute \(OSPF\)](#)



For RIP:  
`redistribute (RIP)`

# set as-path

**Overview** Use this command to add an AS path set clause to a route map entry.

When a BGP update message matches the route map entry, the device prepends the specified Autonomous System Number (ASN) or ASNs to the update's AS path attribute.

The AS path attribute is a list of the autonomous systems through which the announcement for the prefix has passed. As prefixes pass between autonomous systems, each autonomous system adds its ASN to the beginning of the list. This means that the AS path attribute can be used to make routing decisions.

Use the **no** variant of this command to remove the set clause.

**Syntax** `set as-path prepend <1-65535> [<1-65535>]...`  
`no set as-path prepend [<1-65535> [<1-65535>]...]`

| Parameter                    | Description                                                                                    |
|------------------------------|------------------------------------------------------------------------------------------------|
| <code>prepend</code>         | Prepends the autonomous system path.                                                           |
| <code>&lt;1-65535&gt;</code> | The number to prepend to the AS path. If you specify multiple ASNs, separate them with spaces. |

**Mode** Route-map mode

**Usage** Use the **set as-path** command to specify an autonomous system path. By specifying the length of the AS-Path, the device influences the best path selection by a neighbor. Use the `prepend` parameter with this command to prepend an AS path string to routes increasing the AS path length.

This command is valid for BGP update messages only.

**Example** To use entry 3 of the route map called `myroute` to prepend ASN 8 and 24 to the AS path of matching update messages, use the commands:

```
awplus# configure terminal
awplus(config)# route-map myroute permit 3
awplus(config-route-map)# set as-path prepend 8 24
```

**Related Commands** [match as-path](#)  
[route-map](#)  
[show route-map](#)

# set community

**Overview** Use this command to add a community set clause to a route map entry.

When a BGP update message matches the route map entry, the device takes one of the following actions:

- changes the update's community attribute to the specified value or values, or
- adds the specified community value or values to the update's community attribute, if you specify the **additive** parameter after specifying another parameter. or
- removes the community attribute from the update, if you specify the **none** parameter

Use the **no** variant of this command to remove the set clause.

**Syntax**

```
set community {[<1-65535>][AA:NN] [internet] [local-AS]
[no-advertise] [no-export] [additive]}
no set community {[AA:NN] [internet] [local-AS] [no-advertise]
[no-export] [additive]}
set community none
no set community none
```

| Parameter    | Description                                                                                                                                                                                                                                                                                                                                                   |
|--------------|---------------------------------------------------------------------------------------------------------------------------------------------------------------------------------------------------------------------------------------------------------------------------------------------------------------------------------------------------------------|
| <1-65535>    | The AS number of the community as an integer not in AA:NN format.                                                                                                                                                                                                                                                                                             |
| AA:NN        | The Autonomous System (AS) number of the community, in AA:NN format. AS numbers are assigned to the regional registries by the IANA ( <a href="http://www.iana.org">www.iana.org</a> ) and can be obtained from the registry in your region. AA and NN are both integers from 1 to 65535. AA is the AS number; NN is a value chosen by the ASN administrator. |
| local-AS     | The community of routes that must not be advertised to external BGP peers (this includes peers in other members' Autonomous Systems inside a BGP confederation).                                                                                                                                                                                              |
| internet     | The community of routes that can be advertised to all BGP peers.                                                                                                                                                                                                                                                                                              |
| no-advertise | The community of routes that must not be advertised to other BGP peers.                                                                                                                                                                                                                                                                                       |
| no-export    | The community of routes that must not be advertised outside a BGP confederation boundary (a standalone Autonomous System that is not part of a confederation should be considered a confederation itself).                                                                                                                                                    |

| Parameter | Description                                                                                                                                                                                                                       |
|-----------|-----------------------------------------------------------------------------------------------------------------------------------------------------------------------------------------------------------------------------------|
| none      | The device removes the community attribute from matching update messages.                                                                                                                                                         |
| additive  | The device adds the specified community value to the update message's community attribute, instead of replacing the existing attribute. By default this parameter is not included, so the device replaces the existing attribute. |

**Mode** Route-map Configuration

**Usage** This command is valid for BGP update messages only.

**Examples** To use entry 3 of the route map called `rmap1` to put matching routes into the no-advertise community, use the commands:

```
awplus# configure terminal
awplus(config)# route-map rmap1 permit 3
awplus(config-route-map)# set community no-advertise
```

To use entry 3 of the route map called `rmap1` to put matching routes into several communities, use the commands:

```
awplus# configure terminal
awplus(config)# route-map rmap1 permit 3
awplus(config-route-map)# set community 10:01 23:34 12:14
no-export
```

To use entry 3 of the route map called `rmap1` to put matching routes into a single AS community numbered 16384, use the commands:

```
awplus# configure terminal
awplus(config)# route-map rmap1 permit 3
awplus(config-route-map)# set community 16384 no-export
```

**Related Commands**

- [match community](#)
- [route-map](#)
- [set aggregator](#)
- [set comm-list delete](#)
- [set extcommunity](#)
- [show route-map](#)

# show bgp ipv6 (BGP4+ only)

**Overview** Use this command to display BGP4+ network information for a specified IPv6 address.

For information on filtering and saving command output, see the [“Getting Started with AlliedWare Plus” Feature Overview and Configuration Guide](#).

**Syntax** `show bgp ipv6 <ipv6-addr>`

| Parameter                      | Description                                                                |
|--------------------------------|----------------------------------------------------------------------------|
| <code>&lt;ipv6-addr&gt;</code> | Specifies the IPv6 address, entered in hexadecimal in the format X:X::X:X. |

**Mode** User Exec and Privileged Exec

**Example** `awplus# show bgp ipv6 2001:0db8:010d::1`

**Related Commands** [show bgp ipv6 longer-prefixes \(BGP4+ only\)](#)

# show bgp ipv6 community (BGP4+ only)

**Overview** Use this command to display routes that match specified communities within an IPv6 environment. Use the [show ip bgp community \(BGP only\)](#) command within an IPv4 environment.

For information on filtering and saving command output, see the [“Getting Started with AlliedWare Plus” Feature Overview and Configuration Guide](#).

You may use any combination and repetition of parameters listed in the *<type>* placeholder.

**Syntax** `show bgp ipv6 community [<type>] [exact-match]`

| Parameter           | Description                                                                                                 |
|---------------------|-------------------------------------------------------------------------------------------------------------|
| <i>&lt;type&gt;</i> | {[AA:NN] [local-AS] [no-advertise] [no-export]}                                                             |
| AA:NN               | Specifies the Autonomous System (AS) community number, in AA:NN format.                                     |
| local-AS            | Do not send outside local Autonomous Systems (well-known community).                                        |
| no-advertise        | Do not advertise to any peer (well-known community).                                                        |
| no-export           | Do not export to next AS (well-known community).                                                            |
| exact-match         | Specifies that the exact match of the communities is displayed. This optional parameter cannot be repeated. |

**Mode** User Exec and Privileged Exec

**Examples** Note that the AS numbers shown are examples only.

```
awplus# show bgp ipv6 community 64497:64499 exact-match
awplus# show bgp ipv6 community 64497:64499 64500:64501
exact-match
awplus# show bgp ipv6 community 64497:64499 64500:64501
64510:64511no-advertise
awplus# show bgp ipv6 community no-advertise
no-advertiseno-advertise exact-match
awplus# show bgp ipv6 community no-export 64510:64511
no-advertise local-AS no-export
awplus# show bgp ipv6 community no-export 64510:64511
no-advertise 64497:64499 64500:64501 no-export
awplus# show bgp ipv6 community no-export 64497:64499
no-advertise local-AS no-export
```

**Related  
Commands** `show ip bgp community (BGP only)`

# show bgp ipv6 community-list (BGP4+ only)

**Overview** Use this command to display routes that match the given community-list within an IPv6 environment. Use the [show ip bgp community-list \(BGP only\)](#) command within an IPv4 environment.

For information on filtering and saving command output, see the [“Getting Started with AlliedWare Plus” Feature Overview and Configuration Guide](#).

**Syntax** `show bgp ipv6 community-list <listname> [exact-match]`

| Parameter   | Description                                                            |
|-------------|------------------------------------------------------------------------|
| <listname>  | Specifies the community list name.                                     |
| exact-match | Displays only routes that have exactly the same specified communities. |

**Mode** User Exec and Privileged Exec

**Example** `awplus# show bgp ipv6 community-list mylist exact-match`

**Related Commands** [show ip bgp community-list \(BGP only\)](#)



# show bgp ipv6 dampening (BGP4+ only)

**Overview** Use this command to show dampened routes from a BGP4+ instance within an IPv6 environment. Use the [show ip bgp dampening \(BGP only\)](#) command to show dampened routes from a BGP instance within an IPv4 environment.

For information on filtering and saving command output, see the [“Getting Started with AlliedWare Plus” Feature Overview and Configuration Guide](#).

**Syntax** `show bgp ipv6 dampening  
{dampened-paths|flap-statistics|parameters}`

| Parameter       | Description                                         |
|-----------------|-----------------------------------------------------|
| dampened-paths  | Display paths suppressed due to dampening.          |
| flap-statistics | Display flap statistics of routes.                  |
| parameters      | Display details of configured dampening parameters. |

**Mode** User Exec and Privileged Exec

**Usage** Enable BGP4+ dampening to maintain dampened-path information in memory.

**Examples**

```
awplus# show bgp ipv6 dampening dampened-path
awplus# show bgp ipv6 dampening flap-statistics
awplus# show bgp ipv6 dampening parameter
```

**Related Commands** [show ip bgp dampening \(BGP only\)](#)

# show bgp ipv6 filter-list (BGP4+ only)

**Overview** Use this command to display routes conforming to the filter-list within an IPv6 environment. Use the [show ip bgp filter-list \(BGP only\)](#) command to display routes conforming to the filter-list within an IPv4 environment.

For information on filtering and saving command output, see the [“Getting Started with AlliedWare Plus” Feature Overview and Configuration Guide](#).

**Syntax** `show bgp ipv6 filter-list <listname>`

| Parameter                     | Description                                        |
|-------------------------------|----------------------------------------------------|
| <code>&lt;listname&gt;</code> | Specifies the regular-expression access list name. |

**Mode** User Exec and Privileged Exec

**Example** `awplus# show bgp ipv6 filter-list mylist`

**Related Commands** [show ip bgp filter-list \(BGP only\)](#)

# show bgp ipv6 inconsistent-as (BGP4+ only)

**Overview** Use this command to display routes with inconsistent AS Paths within an IPv6 environment. Use the [show ip bgp inconsistent-as \(BGP only\)](#) command to display routes with inconsistent AS paths within an IPv4 environment.

For information on filtering and saving command output, see the [“Getting Started with AlliedWare Plus” Feature Overview and Configuration Guide](#).

**Syntax** `show bgp ipv6 inconsistent-as`

**Mode** User Exec and Privileged Exec

**Example** `awplus# show bgp ipv6 inconsistent-as`

**Related Commands** [show ip bgp inconsistent-as \(BGP only\)](#)

# show bgp ipv6 longer-prefixes (BGP4+ only)

**Overview** Use this command to display the route of the local BGP4+ routing table for a specific prefix with a specific mask or for any prefix having a longer mask than the one specified.

For information on filtering and saving command output, see the [“Getting Started with AlliedWare Plus” Feature Overview and Configuration Guide](#).

**Syntax** `show bgp ipv6 <ipv6-addr/prefix-length> longer-prefixes`

| Parameter                                    | Description                                                                                                                                                |
|----------------------------------------------|------------------------------------------------------------------------------------------------------------------------------------------------------------|
| <code>&lt;ipv6-addr/prefix-length&gt;</code> | Specifies the IPv6 address with prefix length. The IPv6 address uses the format X:X::X:X/Prefix-Length. The prefix-length is usually set between 0 and 64. |

**Mode** User Exec and Privileged Exec

**Example** `awplus# show bgp ipv6 2001:0db8::/64 longer-prefixes`

**Related Commands** `show bgp ipv6 (BGP4+ only)`

# show bgp ipv6 neighbors (BGP4+ only)

**Overview** Use this command to display detailed information on peering connections to all BGP4+ neighbors within an IPv6 environment.

Use the [show ip bgp neighbors \(BGP only\)](#) command to display detailed information on peering connections to all BGP neighbors within an IPv4 environment.

For information on filtering and saving command output, see the [“Getting Started with AlliedWare Plus” Feature Overview and Configuration Guide](#).

**Syntax** `show bgp ipv6 neighbors [<ipv6-addr> [advertised-routes | received prefix-filter | received-routes | routes]]`

| Parameter              | Description                                                                                                                                       |
|------------------------|---------------------------------------------------------------------------------------------------------------------------------------------------|
| <ipv6-addr>            | Specifies the IPv6 address, entered in hexadecimal in the format X:X::X:X.                                                                        |
| advertised-routes      | Displays the routes advertised to a BGP4+ neighbor.                                                                                               |
| received prefix-filter | Displays received prefix-list filters.                                                                                                            |
| received-routes        | Displays the received routes from the neighbor. To display all the received routes from the neighbor, configure the BGP4+ soft reconfigure first. |
| routes                 | Displays all accepted routes learned from neighbors.                                                                                              |

**Mode** User Exec and Privileged Exec

**Examples [BGP4+]**

```
awplus# show bgp ipv6 neighbors 2001:0db8:010d::1 advertised-routes
awplus# show bgp ipv6 neighbors 2001:0db8:010d::1 received prefix-filter
awplus# show bgp ipv6 neighbors 2001:0db8:010d::1 received-routes
awplus# show bgp ipv6 neighbors 2001:0db8:010d::1 routes
```

**Output** Figure 31-4: Example output from **show bgp ipv6 neighbors 2001:db8:b::1**

```
awplus#show bgp ipv6 neighbors 2001:db8:b::1
BGP neighbor is 2001:db8:b::1, remote AS 200, local AS 100, external link
 BGP version 4, remote router ID 2.2.2.1
 BGP state = Established, up for 01:03:26
 Last read 01:03:26, hold time is 90, keepalive interval is 30 seconds
 Neighbor capabilities:
 Route refresh: advertised and received (old and new)
 4-Octet ASN Capability: advertised and received
 Address family IPv4 Unicast: advertised and received
 Address family IPv6 Unicast: advertised and received
 Received 157 messages, 0 notifications, 0 in queue
 Sent 228 messages, 0 notifications, 0 in queue
 Route refresh request: received 0, sent 0
 Minimum time between advertisement runs is 30 seconds
 Update source is lo
For address family: IPv4 Unicast
 BGP table version 1, neighbor version 1
 Index 2, Offset 0, Mask 0x4
 Community attribute sent to this neighbor (both)
 0 accepted prefixes
 0 announced prefixes

For address family: IPv6 Unicast
 BGP table version 66, neighbor version 66
 Index 2, Offset 0, Mask 0x4
 AF-dependant capabilities:
 Graceful restart: advertised, received

 Community attribute sent to this neighbor (both)
 Default information originate, default sent
 Inbound path policy configured
 Incoming update prefix filter list is *BGP_FILTER_LIST
 Route map for incoming advertisements is *BGP_LOCAL_PREF_MAP
 8 accepted prefixes
 8 announced prefixes

Connections established 1; dropped 0
Graceful-restart Status:
 Remote restart-time is 90 sec

 External BGP neighbor may be up to 2 hops away.
Local host: 2001:db8:a::1, Local port: 179
Foreign host: 2001:db8:b::1, Foreign port: 50672
Nexthop: 1.1.1.1
Nexthop global: 2001:db8:a::1
Nexthop local: ::
BGP connection: non shared network
```

If available the following is shown:

- Session information
  - Neighbor address, ASN information and if the link is external or internal
  - BGP version and status
  - Neighbor capabilities for the BGP session
  - Number of messages transmitted and received
- IPv6 unicast address family information
  - BGP4+ table version
  - IPv6 Address Family dependent capabilities
  - IPv6 Communities
  - IPv6 Route filters for ingress and egress updates
  - Number of announced and accepted IPv6 prefixes
- Connection information
  - Connection counters
  - Graceful restart timer
  - Hop count to the peer
  - Next hop information
  - Local and external port numbers

**Related Commands** [show ip bgp neighbors \(BGP only\)](#)

# show bgp ipv6 paths (BGP4+ only)

**Overview** Use this command to display BGP4+ path information within an IPv6 environment. Use the [show ip bgp paths \(BGP only\)](#) command to display BGP path information within an IPv4 environment.

For information on filtering and saving command output, see the [“Getting Started with AlliedWare Plus” Feature Overview and Configuration Guide](#).

**Syntax** `show bgp ipv6 paths`

**Mode** User Exec and Privileged Exec

**Example** `awplus# show bgp ipv6 paths`

**Related Commands** [show ip bgp paths \(BGP only\)](#)



# show bgp ipv6 prefix-list (BGP4+ only)

**Overview** Use this command to display routes matching the prefix-list within an IPv6 environment. Use the [show ip bgp prefix-list \(BGP only\)](#) command to display routes matching the prefix-list within an IPv4 environment.

For information on filtering and saving command output, see the [“Getting Started with AlliedWare Plus” Feature Overview and Configuration Guide](#).

**Syntax** `show bgp ipv6 prefix-list <list>`

| Parameter                 | Description                                 |
|---------------------------|---------------------------------------------|
| <code>&lt;list&gt;</code> | Specifies the name of the IPv6 prefix list. |

**Mode** User Exec and Privileged Exec

**Example** `awplus# show bgp ipv6 prefix-list mylist`

**Related Commands** [show ip bgp prefix-list \(BGP only\)](#)

# show bgp ipv6 quote-regexp (BGP4+ only)

**Overview** Use this command to display routes matching the AS path regular expression within an IPv6 environment. Use the [show ip bgp quote-regexp \(BGP only\)](#) command to display routes matching the AS path regular expression within an IPv4 environment.

Note that you must use quotes to enclose the regular expression with this command. Use the regular expressions listed below with the *<expression>* parameter:

| Symbol | Character     | Meaning                                                                                                                            |
|--------|---------------|------------------------------------------------------------------------------------------------------------------------------------|
| ^      | Caret         | Used to match the beginning of the input string. When used at the beginning of a string of characters, it negates a pattern match. |
| \$     | Dollar sign   | Used to match the end of the input string.                                                                                         |
| .      | Period        | Used to match a single character (white spaces included).                                                                          |
| *      | Asterisk      | Used to match none or more sequences of a pattern.                                                                                 |
| +      | Plus sign     | Used to match one or more sequences of a pattern.                                                                                  |
| ?      | Question mark | Used to match none or one occurrence of a pattern.                                                                                 |
| _      | Underscore    | Used to match spaces, commas, braces, parenthesis, or the beginning and end of an input string.                                    |
| [ ]    | Brackets      | Specifies a range of single-characters.                                                                                            |
| -      | Hyphen        | Separates the end points of a range.                                                                                               |

For information on filtering and saving command output, see the [“Getting Started with AlliedWare Plus” Feature Overview and Configuration Guide](#).

**Syntax** `show bgp ipv6 quote-regexp <expression>`

**Mode** User Exec and Privileged Exec

**Example** `awplus# show bgp ipv6 quote-regexp myexpression`

**Related Commands** [show ip bgp quote-regexp \(BGP only\)](#)

# show bgp ipv6 regexp (BGP4+ only)

**Overview** Use this command to display routes matching the AS path regular expression within an IPv6 environment. Use the [show ip bgp regexp \(BGP only\)](#) command to display routes matching the AS path regular expression within an IPv4 environment.

Use the regular expressions listed below with the *<expression>* parameter:

| Symbol | Character     | Meaning                                                                                                                            |
|--------|---------------|------------------------------------------------------------------------------------------------------------------------------------|
| ^      | Caret         | Used to match the beginning of the input string. When used at the beginning of a string of characters, it negates a pattern match. |
| \$     | Dollar sign   | Used to match the end of the input string.                                                                                         |
| .      | Period        | Used to match a single character (white spaces included).                                                                          |
| *      | Asterisk      | Used to match none or more sequences of a pattern.                                                                                 |
| +      | Plus sign     | Used to match one or more sequences of a pattern.                                                                                  |
| ?      | Question mark | Used to match none or one occurrence of a pattern.                                                                                 |
| _      | Underscore    | Used to match spaces, commas, braces, parenthesis, or the beginning and end of an input string.                                    |
| [ ]    | Brackets      | Specifies a range of single-characters.                                                                                            |
| -      | Hyphen        | Separates the end points of a range.                                                                                               |

For information on filtering and saving command output, see the [“Getting Started with AlliedWare Plus” Feature Overview and Configuration Guide](#).

**Syntax** `show bgp ipv6 regexp <expression>`

| Parameter                 | Description                                                 |
|---------------------------|-------------------------------------------------------------|
| <i>&lt;expression&gt;</i> | Specifies a regular-expression to match the BGP4+ AS paths. |

**Mode** User Exec and Privileged Exec

**Example** `awplus# show bgp ipv6 regexp myexpression`

**Related Commands** [show ip bgp regexp \(BGP only\)](#)

# show bgp ipv6 route-map (BGP4+ only)

**Overview** Use this command to display BGP4+ routes that match the specified route-map within an IPv6 environment. Use the [show ip bgp route-map \(BGP only\)](#) command to display BGP routes that match the specified route-map within an IPv4 environment.

For information on filtering and saving command output, see the [“Getting Started with AlliedWare Plus” Feature Overview and Configuration Guide](#).

**Syntax** `show bgp ipv6 route-map <route-map>`

| Parameter                      | Description                            |
|--------------------------------|----------------------------------------|
| <code>&lt;route-map&gt;</code> | Specifies a route-map that is matched. |

**Mode** User Exec and Privileged Exec

**Example** To show routes that match the route-map `myRouteMap`, use the command:

```
awplus# show bgp ipv6 route-map myRouteMap
```

**Related Commands** [show ip bgp route-map \(BGP only\)](#)

# show bgp ipv6 summary (BGP4+ only)

**Overview** Use this command to display a summary of a BGP4+ neighbor status within an IPv6 environment. Use the [show ip bgp summary \(BGP only\)](#) command to display a summary of a BGP neighbor status within an IPv4 environment.

For information on filtering and saving command output, see the [“Getting Started with AlliedWare Plus” Feature Overview and Configuration Guide](#).

**Syntax** `show bgp ipv6 summary`

**Mode** User Exec and Privileged Exec

**Example** `awplus# show bgp ipv6 summary`

**Output** Figure 31-5: Example output from the **show ip bgp summary** command

```
awplus>show ip bgp summary

BGP router identifier 1.0.0.1, local AS number 65541
BGP table version is 12
4 BGP AS-PATH entries
0 BGP community entries

Neighbor V AS MsgRc MsgSnt TblVer InOutQ Up/Down State/PfxRcd
2001:0db8:cccc::1 4 65544 20 24 11 0/0 00:07:19 1
2001:0db8:dddd::1 4 65545 0 0 0 0/0 never Active
2001:0db8:eeee::1 4 65542 34 40 0 0/0 00:00:04 Active
2001:0db8:ffff::1 4 65543 29 32 11 0/0 00:07:03 13

Number of neighbors 4
```

The Up/Down column in this output is a timer that shows:

- "never" if the peer session has never been established
- The up time, if the peer session is currently up
- The down time, if the peer session is currently down.

In the example above, the session with 2001:0db8:eeee::1 has been down for 4 seconds, and the session with 2001:0db8:dddd::1 has never been established.

**Related Commands** [show ip bgp summary \(BGP only\)](#)

# show bgp memory maxallocation (BGP only)

**Overview** This command displays the maximum percentage of total memory that is allocated to BGP processes.

For information on filtering and saving command output, see the [“Getting Started with AlliedWare Plus” Feature Overview and Configuration Guide](#).

**Syntax** `show bgp memory maxallocation`

**Mode** User Exec and Privileged Exec

**Example** To display the maximum amount of memory allocated for BGP processes, use the command:

```
awplus# show bgp memory maxallocation
```

**Output** Figure 31-6: Example output from the **show bgp memory maxallocation** command

```
BGP maximum RAM allocation is 100%
```

# show bgp nexthop-tracking (BGP only)

**Overview** Use this command to display BGP next hop tracking status.

**Syntax** `show bgp nexthop-tracking`

**Mode** User Exec and Privileged Exec

**Example** To display BGP next hop tracking status, use the command:

```
awplus# show bgp nexthop-tracking
```

**Related Commands** [bgp nexthop-trigger-count](#)  
[show bgp nexthop-tree-details \(BGP only\)](#)

# show bgp nexthop-tree-details (BGP only)

**Overview** Use this command to display BGP next hop tree details.

**Syntax** `show bgp nexthop-tree-details`

**Mode** User Exec and Privileged Exec

**Example** To display BGP next hop tree details, use the command:

```
awplus# show bgp nexthop-tree-details
```

**Related Commands** [show bgp nexthop-tracking \(BGP only\)](#)



# show debugging bgp (BGP only)

**Overview** Use this command to display the BGP debugging option set.

For information on filtering and saving command output, see the [“Getting Started with AlliedWare Plus” Feature Overview and Configuration Guide](#).

**Syntax** `show debugging bgp`

**Mode** User Exec and Privileged Exec

**Example** `awplus# show debugging bgp`

**Output** Figure 31-7: Example output from the **show debugging bgp** command

```
BGP debugging status:
 BGP debugging is on
 BGP events debugging is on
 BGP updates debugging is on
 BGP fsm debugging is on
```

**Related Commands** [debug bgp \(BGP only\)](#)

# show ip bgp (BGP only)

**Overview** Use this command to display BGP network information.

For information on filtering and saving command output, see the [“Getting Started with AlliedWare Plus” Feature Overview and Configuration Guide](#).

**Syntax** `show ip bgp [<ip-addr>|<ip-addr/m>]`

| Parameter   | Description                                                     |
|-------------|-----------------------------------------------------------------|
| <ip-addr>   | Specifies the IPv4 address and the optional prefix mask length. |
| <ip-addr/m> |                                                                 |

**Mode** User Exec and Privileged Exec

**Example** `awplus# show ip bgp 10.10.1.34/24`

**Output** Figure 31-8: Example output from the **show ip bgp** command

```
BGP table version is 7, local router ID is 80.80.80.80
Status codes: s suppressed, d damped, h history, * valid, >
best, i - internal, S Stale
Origin codes: i - IGP, e - EGP, ? - incomplete

 Network Next Hop Metric LocPrf Weight
Path
S>i10.70.0.0/24 192.10.23.67 0 100 0 ?
S>i30.30.30.30/32 192.10.23.67 0 100 0 ?
S>i63.63.63.1/32 192.10.23.67 0 100 0 ?
S>i67.67.67.67/32 192.10.23.67 0 100 0 ?
S>i172.22.10.0/24 192.10.23.67 0 100 0 ?
S>i192.10.21.0 192.10.23.67 0 100 0 ?
S>i192.10.23.0 192.10.23.67 0 100 0 ?

Total number of prefixes 7
```

**Related Commands** [neighbor remove-private-AS \(BGP only\)](#)

# show ip bgp attribute-info (BGP only)

**Overview** Use this command to show internal attribute hash information.  
For information on filtering and saving command output, see the [“Getting Started with AlliedWare Plus” Feature Overview and Configuration Guide](#).

**Syntax** `show ip bgp attribute-info`

**Mode** User Exec and Privileged Exec

**Example** `awplus# show ip bgp attribute-info`

**Output** Figure 31-9: Example output from the **show ip bgp attribute-info** command

```
attr[1] nexthop 0.0.0.0
attr[1] nexthop 10.10.10.10
attr[1] nexthop 10.10.10.50
```

# show ip bgp cidr-only (BGP only)

**Overview** Use this command to display routes with non-natural network masks.

For information on filtering and saving command output, see the [“Getting Started with AlliedWare Plus” Feature Overview and Configuration Guide](#).

**Syntax** `show ip bgp cidr-only`

**Syntax [VRF]** `show ip bgp [global|vrf <vrf-name>] cidr-only`

| Parameter  | Description                                                                                |
|------------|--------------------------------------------------------------------------------------------|
| global     | When VRF-lite is configured, apply the command to the global routing and forwarding table. |
| vrf        | Apply the command to the specified VRF instance.                                           |
| <vrf-name> | The name of the VRF instance.                                                              |

**Mode** User Exec and Privileged Exec

**Example**  
`awplus# show ip bgp cidr-only`  
`awplus# show ip bgp vrf red cidr-only`

**Output** Figure 31-10: Example output from the **show ip bgp cidr-only** command

```
BGP table version is 0, local router ID is 10.10.10.50

Status codes: s suppressed, d damped, h history, p stale, *
valid, > best, i - internal

Origin codes: i - IGP, e - EGP, ? - incomplete

 Network Next Hop Metric LocPrf Weight Path
*> 3.3.3.0/24 10.10.10.10 0 11 i
*> 6.6.6.0/24 0.0.0.0 32768 i

Total number of prefixes 2
```

**Command changes** Version 5.4.6-2.1: VRF-lite support added.

# show ip bgp community (BGP only)

**Overview** Use this command to display routes that match specified communities from a BGP instance within an IPv4 environment. Use the [show bgp ipv6 community \(BGP4+ only\)](#) command within an IPv6 environment.

For information on filtering and saving command output, see the [“Getting Started with AlliedWare Plus” Feature Overview and Configuration Guide](#).

You may use any combination and repetition of parameters listed in the `<type>` placeholder.

**Syntax** `show ip bgp community [<type>] [exact-match]`

**Syntax [VRF]** `show ip bgp [global|vrf <vrf-name>] community [<type>] [exact-match]`

| Parameter    | Description                                                                                                 |
|--------------|-------------------------------------------------------------------------------------------------------------|
| global       | When VRF-lite is configured, apply the command to the global routing and forwarding table.                  |
| vrf          | Apply the command to the specified VRF instance.                                                            |
| <vrf-name>   | The name of the VRF instance.                                                                               |
| <type>       | {[AA:NN] [local-AS] [no-advertise] [no-export] }                                                            |
| AA:NN        | Specifies the Autonomous System (AS) community number, in AA:NN format.                                     |
| local-AS     | Do not send outside local Autonomous Systems (well-known community).                                        |
| no-advertise | Do not advertise to any peer (well-known community).                                                        |
| no-export    | Do not export to next AS (well-known community).                                                            |
| exact-match  | Specifies that the exact match of the communities is displayed. This optional parameter cannot be repeated. |

**Mode** User Exec and Privileged Exec

**Examples** Note that the AS numbers shown are examples only.

```
awplus# show ip bgp community 64497:64499 exact-match
awplus# show ip bgp community 64497:64499 64500:64501
exact-match
awplus# show ip bgp community 64497:64499 64500:64501
64510:64511no-advertise
awplus# show ip bgp community no-advertise
no-advertiseno-advertise exact-match
awplus# show ip bgp community no-export 64510:64511
no-advertise local-AS no-export
awplus# show ip bgp community no-export 64510:64511
no-advertise 64497:64499 64500:64501 no-export
awplus# show ip bgp community no-export 64497:64499
no-advertise local-AS no-export
awplus# show ip bgp vrf red no-export
awplus# show ip bgp global 65500:2 65500:3 exact-match
```

**Related  
Commands** [set community](#)  
[show bgp ipv6 community \(BGP4+ only\)](#)

**Command  
changes** Version 5.4.6-2.1: VRF-lite support added.

# show ip bgp community-info (BGP only)

**Overview** Use this command to list all BGP community information.

For information on filtering and saving command output, see the [“Getting Started with AlliedWare Plus” Feature Overview and Configuration Guide](#).

**Syntax** `show ip bgp community-info`

**Mode** User Exec and Privileged Exec

**Example** `awplus# show ip bgp community-info`

# show ip bgp community-list (BGP only)

**Overview** Use this command to display routes that match the given community-list from a BGP instance within an IPv4 environment. Use the [show bgp ipv6 community-list \(BGP4+ only\)](#) command within an IPv6 environment.

For information on filtering and saving command output, see the [“Getting Started with AlliedWare Plus” Feature Overview and Configuration Guide](#).

**Syntax** `show ip bgp community-list <listname> [exact-match]`

**Syntax [VRF]** `show ip bgp [global|vrf <vrf-name>] community-list <listname> [exact-match]`

| Parameter   | Description                                                                                |
|-------------|--------------------------------------------------------------------------------------------|
| global      | When VRF-lite is configured, apply the command to the global routing and forwarding table. |
| vrf         | Apply the command to the specified VRF instance.                                           |
| <vrf-name>  | The name of the VRF instance.                                                              |
| <listname>  | Specifies the community list name.                                                         |
| exact-match | Displays only routes that have exactly the same specified communities.                     |

**Mode** User Exec and Privileged Exec

**Example**

```
awplus# show ip bgp community-list mylist exact-match
awplus# show ip bgp vrf red community-list myCommunity
awplus# show ip bgp global community-list myExactCommunity
exact-match
```

**Related Commands** [show bgp ipv6 community-list \(BGP4+ only\)](#)

**Command changes** Version 5.4.6-2.1: VRF-lite support added.



# show ip bgp dampening (BGP only)

**Overview** Use this command to show dampened routes from a BGP instance within an IPv4 environment. Use the [show bgp ipv6 dampening \(BGP4+ only\)](#) command within an IPv6 environment.

For information on filtering and saving command output, see the [“Getting Started with AlliedWare Plus” Feature Overview and Configuration Guide](#).

**Syntax** `show ip bgp dampening  
{dampened-paths|flap-statistics|parameters}`

**Syntax [VRF]** `show ip bgp [global|vrf <vrf-name>] dampening  
{dampened-paths|flap-statistics|parameters}`

| Parameter       | Description                                                                                |
|-----------------|--------------------------------------------------------------------------------------------|
| global          | When VRF-lite is configured, apply the command to the global routing and forwarding table. |
| vrf             | Apply the command to the specified VRF instance.                                           |
| <vrf-name>      | The name of the VRF instance.                                                              |
| dampened-paths  | Display paths suppressed due to dampening.                                                 |
| flap-statistics | Display flap statistics of routes.                                                         |
| parameters      | Display details of configured dampening parameters.                                        |

**Mode** User Exec and Privileged Exec

**Usage** Enable BGP dampening to maintain dampened-path information in memory.

**Examples** `awplus# show ip bgp dampening dampened-paths  
awplus# show ip bgp vrf red dampening dampened-paths  
awplus# show ip bgp global dampening flap-statistics`

**Output** Figure 31-11: Example output from the **show ip bgp dampening** command

```
dampening 15 750 2000 60 15
 Reachability Half-Life time : 15 min
 Reuse penalty : 750
 Suppress penalty : 2000
 Max suppress time : 60 min
 Un-reachability Half-Life time : 15 min
 Max penalty (ceil) : 11999
 Min penalty (floor) : 375
```

The following example output shows that the internal route (i), has flapped 3 times and is now categorized as history (h).

Figure 31-12: Example output from the **show ip bgp dampening flap-statistics** command

```
awplus# show ip bgp dampening flap-statistics
BGP table version is 1, local router ID is 30.30.30.77
Status codes: s suppressed, d damped, h history, * valid, > best, i - internal, S
Stale
Origin codes: i - IGP, e - EGP, ? - incomplete
 Network From Flaps Duration Reuse Path
 ---- -
 hi1.1.1.0/24 10.100.0.62 3 00:01:20 i
```

The following example output shows a damped route in the 1.1.1.0/24 network.

Figure 31-13: Example output from the **show ip bgp dampening dampened-path** command

```
awplus# show ip bgp dampening dampened-paths
BGP table version is 1, local router ID is 30.30.30.77
Status codes: s suppressed, d damped, h history, * valid, > best, i - internal, S
Stale
Origin codes: i - IGP, e - EGP, ? - incomplete
 Network From Reuse Path
 ---- -
 di 1.1.1.0/24 10.100.0.62 00:35:10 i

Total number of prefixes 1
```

**Related Commands** [show bgp ipv6 dampening \(BGP4+ only\)](#)

**Command changes** Version 5.4.6-2.1: VRF-lite support added.

# show ip bgp filter-list (BGP only)

**Overview** Use this command to display routes conforming to the filter-list within an IPv4 environment. Use the [show bgp ipv6 filter-list \(BGP4+ only\)](#) command to display routes conforming to the filter-list within an IPv6 environment

For information on filtering and saving command output, see the [“Getting Started with AlliedWare Plus” Feature Overview and Configuration Guide](#).

**Syntax** `show ip bgp filter-list <listname>`

**Syntax [VRF]** `show ip bgp [global|vrf <vrf-name>] filter-list <listname>`

| Parameter  | Description                                                                                |
|------------|--------------------------------------------------------------------------------------------|
| global     | When VRF-lite is configured, apply the command to the global routing and forwarding table. |
| vrf        | Apply the command to the specified VRF instance.                                           |
| <vrf-name> | The name of the VRF instance.                                                              |
| <listname> | Specifies the regular-expression access list name.                                         |

**Mode** User Exec and Privileged Exec

**Example**  
`awplus# show ip bgp filter-list mylist`  
`awplus# show ip bgp vrf red filter-list mylist`

**Related Commands** [show bgp ipv6 filter-list \(BGP4+ only\)](#)

**Command changes** Version 5.4.6-2.1: VRF-lite support added.

# show ip bgp inconsistent-as (BGP only)

**Overview** Use this command to display routes with inconsistent AS Paths within an IPv4 environment. Use the [show bgp ipv6 inconsistent-as \(BGP4+ only\)](#) command to display routes with inconsistent AS paths within an IPv6 environment.

For information on filtering and saving command output, see the [“Getting Started with AlliedWare Plus” Feature Overview and Configuration Guide](#).

**Syntax** `show ip bgp inconsistent-as`

**Syntax [VRF]** `show ip bgp [global|vrf <vrf-name>] inconsistent-as`

| Parameter  | Description                                                                                |
|------------|--------------------------------------------------------------------------------------------|
| global     | When VRF-lite is configured, apply the command to the global routing and forwarding table. |
| vrf        | Apply the command to the specified VRF instance.                                           |
| <vrf-name> | The name of the VRF instance.                                                              |

**Mode** User Exec and Privileged Exec

**Example**  
`awplus# show ip bgp inconsistent-as`  
`awplus# show ip bgp global inconsistent-as`

**Related Commands** [show bgp ipv6 inconsistent-as \(BGP4+ only\)](#)

**Command changes** Version 5.4.6-2.1: VRF-lite support added.

# show ip bgp longer-prefixes (BGP only)

**Overview** Use this command to display the route of the local BGP routing table for a specific prefix with a specific mask, or for any prefix having a longer mask than the one specified.

For information on filtering and saving command output, see the [“Getting Started with AlliedWare Plus” Feature Overview and Configuration Guide](#).

**Syntax** `show ip bgp <ip-address/m> longer-prefixes`

**Syntax [VRF]** `show ip bgp [global|vrf <vrf-name>] <ip-address/m> longer-prefixes`

| Parameter      | Description                                                                                              |
|----------------|----------------------------------------------------------------------------------------------------------|
| global         | When VRF-lite is configured, apply the command to the global routing and forwarding table.               |
| vrf            | Apply the command to the specified VRF instance.                                                         |
| <vrf-name>     | The name of the VRF instance.                                                                            |
| <ip-address/m> | Neighbor's IP address and subnet mask, entered in the form A.B.C.D/M, where M is the subnet mask length. |

**Mode** User Exec and Privileged Exec

**Example**

```
awplus# show ip bgp 10.10.0.10/24 longer-prefixes
awplus# show ip bgp vrf red 172.16.4.0/24
awplus# show ip bgp global 172.16.0.0/16 longer-prefixes
```

**Command changes** Version 5.4.6-2.1: VRF-lite support added.

# show ip bgp neighbors (BGP only)

**Overview** Use this command to display detailed information on peering connections to all BGP neighbors within an IPv4 environment.

Use the [show bgp ipv6 neighbors \(BGP4+ only\)](#) command to display detailed information on peering connections to all BGP4+ neighbors within an IPv6 environment.

For information on filtering and saving command output, see the [“Getting Started with AlliedWare Plus” Feature Overview and Configuration Guide](#).

**Syntax [BGP]** `show ip bgp neighbors [<ipv4-addr> [advertised-routes|received prefix-filter|received-routes|routes]]`

**Syntax [VRF]** `show ip bgp [global|vrf <vrf-name>] neighbors [<ipv4-addr> routes]`

| Parameter              | Description                                                                                                                                     |
|------------------------|-------------------------------------------------------------------------------------------------------------------------------------------------|
| <ipv4-addr>            | The IPv4 address of an IPv4 BGP neighbor, in dotted decimal notation A.B.C.D.                                                                   |
| advertised-routes      | Displays the routes advertised to a BGP neighbor.                                                                                               |
| received prefix-filter | Displays the received prefix-list filters.                                                                                                      |
| received-routes        | Displays the received routes from the neighbor. To display all the received routes from the neighbor, configure the BGP soft reconfigure first. |
| routes                 | Displays all accepted routes learned from neighbors.                                                                                            |
| global                 | When VRF-lite is configured, apply the command to the global routing and forwarding table.                                                      |
| vrf                    | Apply the command to the specified VRF instance.                                                                                                |
| <vrf-name>             | The name of the VRF instance.                                                                                                                   |

**Mode [BGP]** User Exec and Privileged Exec

**Examples [BGP]**

```
awplus# show ip bgp neighbors 10.10.10.72 advertised-routes
awplus# show ip bgp neighbors 10.10.10.72 received
prefix-filter
awplus# show ip bgp neighbors 10.10.10.72 received-routes
awplus# show ip bgp neighbors 10.10.10.72 routes
```

**Output** Figure 31-14: Example output from **show ip bgp neighbors 10.10.10.72**

```
awplus#show ip bgp neighbors 10.10.10.72
BGP neighbor is 10.10.10.72, remote AS 100, local AS 100, internal
link
Member of peer-group group1 for session parameters
 BGP version 4, remote router ID 0.0.0.0
 BGP state = Active
 Last read , hold time is 90, keepalive interval is 30 seconds
 Received 0 messages, 0 notifications, 0 in queue
 Sent 0 messages, 0 notifications, 0 in queue
 Route refresh request: received 0, sent 0
 Minimum time between advertisement runs is 5 seconds
For address family: IPv4 Unicast
 BGP table version 1, neighbor version 0
 Index 1, Offset 0, Mask 0x2
 group1 peer-group member
 NEXT_HOP is always this router
 0 accepted prefixes
 0 announced prefixes

Connections established 0; dropped 0
Next connect timer due in 33 seconds
```

If available the following is shown:

- Session information
  - Neighbor address, ASN information and if the link is external or internal
  - BGP version and status
  - Neighbor capabilities for the BGP session
  - Number of messages transmitted and received
- IPv4 unicast address family information
  - BGP table version
  - IPv4 Address Family dependent capabilities
  - IPv4 Communities
  - IPv4 Route filters for ingress and egress updates
  - Number of announced and accepted IPv4 prefixes
- Connection information
  - Connection counters
  - Graceful restart timer
  - Hop count to the peer
  - Next hop information
  - Local and external port numbers

**Related  
Commands** [show bgp ipv6 neighbors \(BGP4+ only\)](#)

**Command  
changes** Version 5.4.6-2.1: VRF-lite support added.



# show ip bgp neighbors connection-retrytime (BGP only)

**Overview** Use this command to display the configured connection-retrytime value of the peer at the session establishment time with the neighbor.

For information on filtering and saving command output, see the [“Getting Started with AlliedWare Plus” Feature Overview and Configuration Guide](#).

**Syntax** `show ip bgp neighbors <ipv4-addr> connection-retrytime`

| Parameter                      | Description                                                                   |
|--------------------------------|-------------------------------------------------------------------------------|
| <code>&lt;ipv4-addr&gt;</code> | The IPv4 address of an IPv4 BGP neighbor, in dotted decimal notation A.B.C.D. |

**Mode** User Exec and Privileged Exec

**Example** `awplus# show ip bgp neighbors 10.11.4.26 connection-retrytime`

# show ip bgp neighbors hold-time (BGP only)

**Overview** Use this command to display the configured holdtime value of the peer at the session establishment time with the neighbor.

For information on filtering and saving command output, see the [“Getting Started with AlliedWare Plus” Feature Overview and Configuration Guide](#).

**Syntax** `show ip bgp neighbors <ipv4-addr> hold-time`

| Parameter                      | Description                                                                   |
|--------------------------------|-------------------------------------------------------------------------------|
| <code>&lt;ipv4-addr&gt;</code> | The IPv4 address of an IPv4 BGP neighbor, in dotted decimal notation A.B.C.D. |

**Default** The holdtime timer default is 90 seconds as per RFC 4271. Holdtime is `keepalive * 3`.

**Mode** User Exec and Privileged Exec

**Examples** `awplus# show ip bgp neighbors 10.11.4.26 hold-time`

**Related Commands** [neighbor timers](#)  
[show ip bgp neighbors keepalive-interval \(BGP only\)](#)  
[timers \(BGP\)](#)

# show ip bgp neighbors keepalive (BGP only)

**Overview** Use this command to display the number of keepalive messages sent to the neighbor from the peer throughout the session.

For information on filtering and saving command output, see the [“Getting Started with AlliedWare Plus” Feature Overview and Configuration Guide](#).

**Syntax** `show ip bgp neighbors <ipv4-addr> keepalive`

| Parameter                      | Description                                                                   |
|--------------------------------|-------------------------------------------------------------------------------|
| <code>&lt;ipv4-addr&gt;</code> | The IPv4 address of an IPv4 BGP neighbor, in dotted decimal notation A.B.C.D. |

**Mode** User Exec and Privileged Exec

**Examples** `awplus# show ip bgp neighbors 10.11.4.26 keepalive`

**Related Commands** [show ip bgp neighbors keepalive-interval \(BGP only\)](#)

# show ip bgp neighbors keepalive-interval (BGP only)

**Overview** Use this command to display the configured keepalive-interval value of the peer at the session establishment time with the neighbor.

For information on filtering and saving command output, see the [“Getting Started with AlliedWare Plus” Feature Overview and Configuration Guide](#).

**Syntax** `show ip bgp neighbors <ipv4-addr> keepalive-interval`

| Parameter                      | Description                                                                   |
|--------------------------------|-------------------------------------------------------------------------------|
| <code>&lt;ipv4-addr&gt;</code> | The IPv4 address of an IPv4 BGP neighbor, in dotted decimal notation A.B.C.D. |

**Default** The keepalive timer default is 60 seconds as per RFC 4271. Keepalive is holdtime / 3.

**Mode** User Exec and Privileged Exec

**Examples** `awplus# show ip bgp neighbors 10.11.4.26 keepalive-interval`

**Related Commands** [neighbor timers](#)  
`show ip bgp neighbors hold-time (BGP only)`  
`timers (BGP)`

# show ip bgp neighbors notification (BGP only)

**Overview** Use this command to display the number of notification messages sent to the neighbor from the peer throughout the session.

For information on filtering and saving command output, see the [“Getting Started with AlliedWare Plus” Feature Overview and Configuration Guide](#).

**Syntax** `show ip bgp neighbors <ipv4-addr> notification`

| Parameter                      | Description                                                                   |
|--------------------------------|-------------------------------------------------------------------------------|
| <code>&lt;ipv4-addr&gt;</code> | The IPv4 address of an IPv4 BGP neighbor, in dotted decimal notation A.B.C.D. |

**Mode** User Exec and Privileged Exec

**Example** `awplus# show ip bgp neighbors 10.11.4.26 notification`

# show ip bgp neighbors open (BGP only)

**Overview** Use this command to display the number of open messages sent to the neighbor from the peer throughout the session.

For information on filtering and saving command output, see the [“Getting Started with AlliedWare Plus” Feature Overview and Configuration Guide](#).

**Syntax** `show ip bgp neighbors <ipv4-addr> open`

| Parameter                      | Description                                                                   |
|--------------------------------|-------------------------------------------------------------------------------|
| <code>&lt;ipv4-addr&gt;</code> | The IPv4 address of an IPv4 BGP neighbor, in dotted decimal notation A.B.C.D. |

**Mode** User Exec and Privileged Exec

**Example** `awplus# show ip bgp neighbors 10.11.4.26 open`

# show ip bgp neighbors rcvd-msgs (BGP only)

**Overview** Use this command to display the number of messages received by the neighbor from the peer throughout the session.

For information on filtering and saving command output, see the [“Getting Started with AlliedWare Plus” Feature Overview and Configuration Guide](#).

**Syntax** `show ip bgp neighbors <ipv4-addr> rcvd-msgs`

| Parameter                      | Description                                                                   |
|--------------------------------|-------------------------------------------------------------------------------|
| <code>&lt;ipv4-addr&gt;</code> | The IPv4 address of an IPv4 BGP neighbor, in dotted decimal notation A.B.C.D. |

**Mode** User Exec and Privileged Exec

**Example** `awplus# show ip bgp neighbors 10.11.4.26 rcvd-msgs`

# show ip bgp neighbors sent-msgs (BGP only)

**Overview** Use this command to display the number of messages sent to the neighbor from the peer throughout the session.

For information on filtering and saving command output, see the [“Getting Started with AlliedWare Plus” Feature Overview and Configuration Guide](#).

**Syntax** `show ip bgp neighbors <ipv4-addr> sent-msgs`

| Parameter                      | Description                                                                   |
|--------------------------------|-------------------------------------------------------------------------------|
| <code>&lt;ipv4-addr&gt;</code> | The IPv4 address of an IPv4 BGP neighbor, in dotted decimal notation A.B.C.D. |

**Mode** User Exec and Privileged Exec

**Example** `awplus# show ip bgp neighbors 10.11.4.26 sent-msgs`



# show ip bgp neighbors update (BGP only)

**Overview** Use this command to display the number of update messages sent to the neighbor from the peer throughout the session.

For information on filtering and saving command output, see the [“Getting Started with AlliedWare Plus” Feature Overview and Configuration Guide](#).

**Syntax** `show ip bgp neighbors <ipv4-addr> update`

| Parameter                      | Description                                                                   |
|--------------------------------|-------------------------------------------------------------------------------|
| <code>&lt;ipv4-addr&gt;</code> | The IPv4 address of an IPv4 BGP neighbor, in dotted decimal notation A.B.C.D. |

**Mode** User Exec and Privileged Exec

**Example** `awplus# show ip bgp neighbors 10.11.4.26 update`

# show ip bgp paths (BGP only)

**Overview** Use this command to display BGP4 path information within an IPv4 environment. Use the [show bgp ipv6 paths \(BGP4+ only\)](#) command to display BGP4+ path information within an IPv4 environment.

For information on filtering and saving command output, see the [“Getting Started with AlliedWare Plus” Feature Overview and Configuration Guide](#).

**Syntax** `show ip bgp paths`

**Mode** User Exec and Privileged Exec

**Example** `awplus# show ip bgp paths`

**Related Commands** [show bgp ipv6 paths \(BGP4+ only\)](#)

# show ip bgp prefix-list (BGP only)

**Overview** Use this command to display routes matching the prefix-list within an IPv4 environment. Use the [show bgp ipv6 prefix-list \(BGP4+ only\)](#) command to display routes matching the prefix-list within an IPv6 environment.

For information on filtering and saving command output, see the [“Getting Started with AlliedWare Plus” Feature Overview and Configuration Guide](#).

**Syntax** `show ip bgp prefix-list <list>`

**Syntax [VRF]** `show ip bgp [global|vrf <vrf-name>] prefix-list <list>`

| Parameter  | Description                                                                                |
|------------|--------------------------------------------------------------------------------------------|
| global     | When VRF-lite is configured, apply the command to the global routing and forwarding table. |
| vrf        | Apply the command to the specified VRF instance.                                           |
| <vrf-name> | The name of the VRF instance.                                                              |
| <list>     | Specifies the name of the IP prefix list.                                                  |

**Mode** User Exec and Privileged Exec

**Examples**  
`awplus# show ip bgp prefix-list mylist`  
`awplus# show ip bgp vrf red prefix-list myPrefixes`

**Related Commands** [show bgp ipv6 prefix-list \(BGP4+ only\)](#)

**Command changes** Version 5.4.6-2.1: VRF-lite support added.

# show ip bgp quote-regexp (BGP only)

**Overview** Use this command to display routes matching the AS path regular expression within an IPv4 environment. Use the [show bgp ipv6 quote-regexp \(BGP4+ only\)](#) command to display routes matching the AS path regular expression within an IPv6 environment.

Note that you must use quotes to enclose the regular expression with this command. Use the regular expressions listed below with the *<expression>* parameter:

| Symbol | Character     | Meaning                                                                                                                            |
|--------|---------------|------------------------------------------------------------------------------------------------------------------------------------|
| ^      | Caret         | Used to match the beginning of the input string. When used at the beginning of a string of characters, it negates a pattern match. |
| \$     | Dollar sign   | Used to match the end of the input string.                                                                                         |
| .      | Period        | Used to match a single character (white spaces included).                                                                          |
| *      | Asterisk      | Used to match none or more sequences of a pattern.                                                                                 |
| +      | Plus sign     | Used to match one or more sequences of a pattern.                                                                                  |
| ?      | Question mark | Used to match none or one occurrence of a pattern.                                                                                 |
| _      | Underscore    | Used to match spaces, commas, braces, parenthesis, or the beginning and end of an input string.                                    |
| [ ]    | Brackets      | Specifies a range of single-characters.                                                                                            |
| -      | Hyphen        | Separates the end points of a range.                                                                                               |

For information on filtering and saving command output, see the [“Getting Started with AlliedWare Plus” Feature Overview and Configuration Guide](#).

**Syntax** `show ip bgp quote-regexp <expression>`

**Syntax [VRF]** `show ip bgp [global|vrf <vrf-name>] quote-regexp <expression>`

| Parameter    | Description                                                                                |
|--------------|--------------------------------------------------------------------------------------------|
| global       | When VRF-lite is configured, apply the command to the global routing and forwarding table. |
| vrf          | Apply the command to the specified VRF instance.                                           |
| <vrf-name>   | The name of the VRF instance.                                                              |
| <expression> | Specifies a regular-expression to match the BGP AS paths.                                  |

**Mode** User Exec and Privileged Exec

**Examples** awplus# show ip bgp quote-regexp myexpression  
awplus# show ip bgp global quote-regexp 65550 65555

**Related Commands** [show bgp ipv6 quote-regexp \(BGP4+ only\)](#)

**Command changes** Version 5.4.6-2.1: VRF-lite support added.

# show ip bgp regexp (BGP only)

**Overview** Use this command to display routes matching the AS path regular expression within an IPv4 environment. Use the [show bgp ipv6 regexp \(BGP4+ only\)](#) command to display routes matching the AS path regular expression within an IPv6 environment.

Use the regular expressions listed below with the *<expression>* parameter:

| Symbol | Character     | Meaning                                                                                                                            |
|--------|---------------|------------------------------------------------------------------------------------------------------------------------------------|
| ^      | Caret         | Used to match the beginning of the input string. When used at the beginning of a string of characters, it negates a pattern match. |
| \$     | Dollar sign   | Used to match the end of the input string.                                                                                         |
| .      | Period        | Used to match a single character (white spaces included).                                                                          |
| *      | Asterisk      | Used to match none or more sequences of a pattern.                                                                                 |
| +      | Plus sign     | Used to match one or more sequences of a pattern.                                                                                  |
| ?      | Question mark | Used to match none or one occurrence of a pattern.                                                                                 |
| _      | Underscore    | Used to match spaces, commas, braces, parenthesis, or the beginning and end of an input string.                                    |
| [ ]    | Brackets      | Specifies a range of single-characters.                                                                                            |
| -      | Hyphen        | Separates the end points of a range.                                                                                               |

For information on filtering and saving command output, see the [“Getting Started with AlliedWare Plus” Feature Overview and Configuration Guide](#).

**Syntax** `show ip bgp regexp <expression>`

**Syntax [VRF]** `show ip bgp [global|vrf <vrf-name>] regexp <expression>`

| Parameter    | Description                                                                                |
|--------------|--------------------------------------------------------------------------------------------|
| global       | When VRF-lite is configured, apply the command to the global routing and forwarding table. |
| vrf          | Apply the command to the specified VRF instance.                                           |
| <vrf-name>   | The name of the VRF instance.                                                              |
| <expression> | Specifies a regular-expression to match the BGP AS paths.                                  |

**Mode** User Exec and Privileged Exec

**Examples** awplus# show ip bgp regexp myexpression  
awplus# show ip bgp vrf red regexp 65550 65555

**Related Commands** [show bgp ipv6 regexp \(BGP4+ only\)](#)

**Command changes** Version 5.4.6-2.1: VRF-lite support added.

# show ip bgp route-map (BGP only)

**Overview** Use this command to display BGP routes that match the specified route-map within an IPv4 environment. Use the [show bgp ipv6 route-map \(BGP4+ only\)](#) command to display BGP4+ routes that match the specified route-map within an IPv6 environment.

For information on filtering and saving command output, see the [“Getting Started with AlliedWare Plus” Feature Overview and Configuration Guide](#).

**Syntax** `show ip bgp route-map <route-map>`

**Syntax [VRF]** `show ip bgp [global|vrf <vrf-name>] route-map <route-map>`

| Parameter   | Description                                                                                |
|-------------|--------------------------------------------------------------------------------------------|
| global      | When VRF-lite is configured, apply the command to the global routing and forwarding table. |
| vrf         | Apply the command to the specified VRF instance.                                           |
| <vrf-name>  | The name of the VRF instance.                                                              |
| <route-map> | Specifies a route-map that is matched.                                                     |

**Mode** User Exec and Privileged Exec

**Examples** To show routes that match the route-map `myRouteMap` for the global routing instance, use the command:

```
awplus# show ip bgp global route-map myRouteMap
```

To show routes that match the route-map `myRouteMap`, use the command:

```
awplus# show ip bgp route-map myRouteMap
```

**Related Commands** [show bgp ipv6 route-map \(BGP4+ only\)](#)

**Command changes** Version 5.4.6-2.1: VRF-lite support added.



# show ip bgp scan (BGP only)

**Overview** Use this command to display BGP scan status.

For information on filtering and saving command output, see the [“Getting Started with AlliedWare Plus” Feature Overview and Configuration Guide](#).

**Syntax** `show ip bgp scan`

**Mode** User Exec and Privileged Exec

**Example** `awplus# show ip bgp scan`

**Output** Figure 31-15: Example output from the **show ip bgp scan** command

```
BGP scan is running
BGP scan interval is 60
BGP instance : AS is 11,DEFAULT
Current BGP nexthop cache:
BGP connected route:
 10.10.10.0/24
 10.10.11.0/24
```

# show ip bgp summary (BGP only)

**Overview** Use this command to display a summary of a BGP neighbor status within an IPv4 environment. Use the [show bgp ipv6 summary \(BGP4+ only\)](#) command to display a summary of BGP4+ neighbors.

For information on filtering and saving command output, see the [“Getting Started with AlliedWare Plus” Feature Overview and Configuration Guide](#).

**Syntax** `show ip bgp summary`

**Syntax [VRF]** `show ip bgp [global|vrf <vrf-name>] summary`

| Parameter  | Description                                                                                |
|------------|--------------------------------------------------------------------------------------------|
| global     | When VRF-lite is configured, apply the command to the global routing and forwarding table. |
| vrf        | Apply the command to the specified VRF instance.                                           |
| <vrf-name> | The name of the VRF instance.                                                              |

**Mode** User Exec and Privileged Exec

**Examples**  
`awplus# show ip bgp summary`  
`awplus# show ip bgp vrf red summary`

**Output** Figure 31-16: Example output from the **show ip bgp summary** command

```
awplus>show ip bgp summary

BGP router identifier 1.0.0.1, local AS number 65541
BGP table version is 12
4 BGP AS-PATH entries
0 BGP community entries

Neighbor V AS MsgRc MsgSnt TblVer InOutQ Up/Down State/PfxRcd
192.168.3.2 4 65544 20 24 11 0/0 00:07:19 1
192.168.4.2 4 65545 0 0 0 0/0 never Active
192.168.11.2 4 65542 34 40 0 0/0 00:00:04 Active
192.168.21.2 4 65543 29 32 11 0/0 00:07:03 13

Number of neighbors 4
```

The Up/Down column in this output is a timer that shows:

- "never" if the peer session has never been established
- The up time, if the peer session is currently up
- The down time, if the peer session is currently down.

In the example above, the session with 192.168.11.2 has been down for 4 seconds, and the session with 192.168.4.2 has never been established.

**Related Commands** [show bgp ipv6 summary \(BGP4+ only\)](#)

**Command changes** Version 5.4.6-2.1: VRF-lite support added.

# show ip community-list

**Overview** Use this command to display routes that match a specified community-list name or number.

For information on filtering and saving command output, see the [“Getting Started with AlliedWare Plus” Feature Overview and Configuration Guide](#).

**Syntax** `show ip community-list [<listnumber>|<listname>]`

| Parameter                       | Description                                                                                                                    |
|---------------------------------|--------------------------------------------------------------------------------------------------------------------------------|
| <code>&lt;listnumber&gt;</code> | Specifies the community list number in the range <1-199> as specified by a previously issued <b>ip community-list</b> command. |
| <code>&lt;listname&gt;</code>   | Specifies the community list name as specified by a previously issued <b>ip community-list</b> command.                        |

**Mode** User Exec and Privileged Exec

**Examples**  
`awplus# show ip community-list mylist`  
`awplus# show ip community-list 99`

**Related Commands**  
[ip community-list](#)  
[ip community-list expanded](#)  
[ip community-list standard](#)

# show ip extcommunity-list

**Overview** Use this command to display a configured extcommunity-list.

For information on filtering and saving command output, see the [“Getting Started with AlliedWare Plus” Feature Overview and Configuration Guide](#).

**Syntax** `show ip extcommunity-list [<1-199>|<extcommunity-listname>]`

| Parameter               | Description              |
|-------------------------|--------------------------|
| <1-199>                 | Extcommunity-list number |
| <extcommunity-listname> | Extcommunity-list name   |

**Mode** User Exec and Privileged Exec

**Example** `awplus# show ip extcommunity-list 33`

**Related Commands** [ip extcommunity-list expanded](#)  
[ip extcommunity-list standard](#)

# show ip prefix-list (IPv4 Prefix List)

**Overview** Use this command to display the IPv4 prefix-list entries. Note that this command is valid for RIP and BGP routing protocols only.

**Syntax** `show ip prefix-list [<name>|detail|summary]`

| Parameter | Description                                                               |
|-----------|---------------------------------------------------------------------------|
| <name>    | Specify the name of a prefix list in this placeholder.                    |
| detail    | Specify this parameter to show detailed output for all IPv4 prefix lists. |
| summary   | Specify this parameter to show summary output for all IPv4 prefix lists.  |

**Mode** User Exec and Privileged Exec

**Example**

```
awplus# show ip prefix-list
awplus# show ip prefix-list 10.10.0.98/8
awplus# show ip prefix-list detail
```

**Related Commands** [ip prefix-list \(IPv4 Prefix List\)](#)

## show ip protocols bgp (BGP only)

**Overview** Use this command to display BGP process parameters and statistics.  
For information on filtering and saving command output, see the [“Getting Started with AlliedWare Plus” Feature Overview and Configuration Guide](#).

**Syntax** `show ip protocols bgp`

**Mode** User Exec and Privileged Exec

**Example** To display BGP process parameters and statistics, use the command:

```
awplus# show ip protocols bgp
```

**Output** Figure 31-17: Example output from the **show ip protocols bgp** command

```
Routing Protocol is "bgp 100"
 IGP synchronization is disabled
 Automatic route summarization is disabled
 Default local-preference applied to incoming route is 100
 Redistributing:
 Neighbor(s):
 Address AddressFamily FiltIn FiltOut DistIn DistOut RouteMapIn RouteMapOut
 Weight
 10.10.10.1 unicast
```

# show ipv6 prefix-list (IPv6 Prefix List)

**Overview** Use this command to display the prefix-list entries. Note that this command is valid for RIPng and BGP4+ routing protocols only.

**Syntax** `show ipv6 prefix-list [<name>|detail|summary]`

| Parameter | Description                                                               |
|-----------|---------------------------------------------------------------------------|
| <name>    | Specify the name of an individual IPv6 prefix list.                       |
| detail    | Specify this parameter to show detailed output for all IPv6 prefix lists. |
| summary   | Specify this parameter to show summary output for all IPv6 prefix lists.  |

**Mode** User Exec and Privileged Exec

**Example**

```
awplus# show ipv6 prefix-list
awplus# show ipv6 prefix-list 10.10.0.98/8
awplus# show ipv6 prefix-list detail
```

**Related Commands** [ipv6 prefix-list \(IPv6 Prefix List\)](#)



# show route-map

**Overview** Use this command to display information about one or all route maps.

**Syntax** `show route-map <map-name>`

| Parameter                     | Description                       |
|-------------------------------|-----------------------------------|
| <code>&lt;map-name&gt;</code> | A name to identify the route map. |

**Mode** User Exec and Privileged Exec

**Example** To display information about the route-map named `example-map`, use the command:

```
awplus# show route-map example-map
```

**Output** Figure 31-18: Example output from the **show route-map** command

```
route-map example-map, permit, sequence 1
 Match clauses:
 ip address prefix-list example-pref
 Set clauses:
 metric 100
route-map example-map, permit, sequence 200
 Match clauses:
 Set clauses:
```

**Related Commands** [route-map](#)

# synchronization

**Overview** Use this command in Router Configuration mode or in Address Family Configuration mode to ensure BGP does not advertise router learned from iBGP peers until they are learned locally, or are propagated throughout the AS via an IGP.

Use the **no** variant of this command to disable this function.

**Syntax** `synchronization`  
`no synchronization`

**Default** Disabled.

**Mode** Router Configuration and Address Family Configuration mode

**Usage** Synchronization is used when a BGP router should not advertise routes learned from iBGP neighbors, unless those routes are also present in an IGP (for example, OSPF). These routes must be in the RIB (Routing Information Base) learned locally or via an IGP.

Synchronization may be enabled when all the routers in an autonomous system do not speak BGP, and the autonomous system is a transit for other autonomous systems.

Use the **no synchronization** command when BGP router can advertise routes learned from iBGP neighbors, without waiting for IGP reachability, when routes are in the RIB.

**Example** The following example enables IGP synchronization of iBGP routes in Router Configuration mode:

```
awplus# configure terminal
awplus(config)# router bgp 11
awplus(config-router)# synchronization
```

The following example enables IGP synchronization of iBGP routes in IPv4 unicast Address Family Configuration mode:

```
awplus# configure terminal
awplus(config)# router bgp 11
awplus(config)# address-family ipv4 unicast
awplus(config-af)# synchronization
```

The following example enables IGP synchronization of iBGP routes in the IPv6 unicast Address Family Configuration mode:

```
awplus# configure terminal
awplus(config)# router bgp 11
awplus(config)# address-family ipv6 unicast
awplus(config-af)# synchronization
```

# timers (BGP)

**Overview** Use this command sets the BGP keepalive timer and holdtime timer values.  
Use the **no** variant of this command to reset timers to the default.

**Syntax** `timers bgp <keepalive> <holdtime>`  
`no timers bgp [<keepalive> <holdtime>]`

| Parameter                      | Description                                                                                                                                                                                                                                                                                                                                                        |
|--------------------------------|--------------------------------------------------------------------------------------------------------------------------------------------------------------------------------------------------------------------------------------------------------------------------------------------------------------------------------------------------------------------|
| <code>&lt;keepalive&gt;</code> | <code>&lt;0-65535&gt;</code> The frequency with which the keepalive messages are sent to the neighbors. The default is 30 seconds as per RFC 4271. Cisco IOS uses a 60 second keepalive timer default value. Adjust keepalive timers for interoperability as required. Maintain the keepalive value at the holdtime value / 3.                                     |
| <code>&lt;holdtime&gt;</code>  | <code>&lt;0-65535&gt;</code> The interval after which the neighbor is considered dead if keepalive messages are not received. The default holdtime value is 90 seconds as per RFC 4271. Cisco IOS uses a 180 second holdtime timer default value. Adjust holdtime timers for interoperability as required. Maintain the holdtime value at the keepalive value * 3. |

**Default** The keepalive timer default is 60 seconds, the holdtime timer default is 90 seconds, and the connect timer default is 120 seconds as per RFC 4271. Holdtime is keepalive \* 3.

**Mode** Router Configuration

**Usage** This command is used globally to set or unset the keepalive and holdtime values for all the neighbors.

**Examples**

```
awplus# configure terminal
awplus(config)# router bgp 10
awplus(config-router)# timers bgp 40 120
awplus# configure terminal
awplus(config)# router bgp 10
awplus(config-router)# no timers bgp 30 90
awplus# configure terminal
awplus(config)# router bgp 10
awplus(config-router)# no timers bgp
```

**Related Commands**

- [neighbor timers](#)
- [show ip bgp neighbors hold-time \(BGP only\)](#)
- [show ip bgp neighbors keepalive-interval \(BGP only\)](#)

# undebug bgp (BGP only)

**Overview** Use this command to disable BGP debugging functions.

**Syntax** undebug bgp  
[all|dampening|events|filters|fsm|keepalives|nht|nsm|updates]  
undebug all bgp

| Parameter  | Description                                                 |
|------------|-------------------------------------------------------------|
| all        | Disable all debugging for BGP.                              |
| dampening  | Disable debugging for BGP dampening.                        |
| events     | Disable debugging for BGP events.                           |
| filters    | Disable debugging for BGP filters.                          |
| fsm        | Disable debugging for BGP Finite State Machine (FSM).       |
| keepalives | Disable debugging for BGP keepalives.                       |
| nht        | Disable debugging for BGP NHT (Next Hop Tracking) messages. |
| nsm        | Disable debugging for NSM messages.                         |
| updates    | Disable debugging for BGP updates.                          |

**Mode** Privileged Exec and Global Configuration

**Example** awplus# undebug bgp events  
awplus# undebug bgp nht  
awplus# undebug bgp updates

**Related Commands** [debug bgp \(BGP only\)](#)

# 32

# Route Map Commands

## Introduction

**Overview** This chapter provides an alphabetical reference for route map commands. For more information, see the [Routemaps Feature Overview and Configuration Guide](#). These commands can be divided into the following categories:

- **route-map** command, is used to create a route map and/or route map entry, and to put you into route map mode
- **match** commands, used to determine which routes the route map applies to
- **set** commands, used to modify matching routes

- Command List**
- ["match as-path"](#) on page 1415
  - ["match community"](#) on page 1416
  - ["match interface"](#) on page 1418
  - ["match ip address"](#) on page 1419
  - ["match ip next-hop"](#) on page 1421
  - ["match ipv6 address"](#) on page 1422
  - ["match ipv6 next-hop"](#) on page 1423
  - ["match metric"](#) on page 1424
  - ["match origin"](#) on page 1425
  - ["match route-type"](#) on page 1427
  - ["match tag"](#) on page 1428
  - ["route-map"](#) on page 1429
  - ["set aggregator"](#) on page 1432
  - ["set as-path"](#) on page 1433
  - ["set atomic-aggregate"](#) on page 1434
  - ["set comm-list delete"](#) on page 1435

- [“set community”](#) on page 1436
- [“set dampening”](#) on page 1438
- [“set extcommunity”](#) on page 1440
- [“set ip next-hop \(route map\)”](#) on page 1442
- [“set ipv6 next-hop”](#) on page 1443
- [“set local-preference”](#) on page 1444
- [“set metric”](#) on page 1445
- [“set metric-type”](#) on page 1447
- [“set origin”](#) on page 1448
- [“set originator-id”](#) on page 1449
- [“set tag”](#) on page 1450
- [“set weight”](#) on page 1451
- [“show route-map”](#) on page 1452

# match as-path

**Overview** Use this command to add an autonomous system (AS) path match clause to a route map entry. Specify the AS path attribute value or values to match by specifying the name of an AS path access list.

A BGP update message matches the route map if its attributes include AS path values that match the AS path access list.

Each entry of a route map can only match against one AS path access list in one AS path match clause. If the route map entry already has an AS path match clause, entering this command replaces that match clause with the new clause.

Note that AS path access lists and route map entries both specify an action of deny or permit. The action in the AS path access list determines whether the route map checks update messages for a given AS path value. The route map action and its **set** clauses determine what the route map does with update messages that contain that AS path value.

Use the **no** variant of this command to remove the AS path match clause from a route map entry.

**Syntax** `match as-path <as-path-listname>`  
`no match as-path [<as-path-listname>]`

| Parameter                             | Description                            |
|---------------------------------------|----------------------------------------|
| <code>&lt;as-path-listname&gt;</code> | Specifies an AS path access list name. |

**Mode** Route-map Configuration

**Usage** This command is valid for BGP update messages only.

**Example** To add entry 34 to the route map called `myroute`, which will discard update messages if they contain the AS path values that are included in `myaccesslist`, use the commands:

```
awplus# configure terminal
awplus(config)# route-map myroute deny 34
awplus(config-route-map)# match as-path myaccesslist
```

**Related Commands**

- [route-map](#)
- [set as-path](#)
- [show route-map](#)

# match community

**Overview** Use this command to add a community match clause to a route map entry. Specify the community value or values to match by specifying a community list. To create the community list, enter Global Configuration mode and use the [ip community-list](#) command.

A BGP update message matches the route map if its attributes include community values that match the community list.

Each entry of a route map can only match against one community list in one community match clause. If the route map entry already has a community match clause, entering this command replaces that match clause with the new clause.

Note that community lists and route map entries both specify an action of deny or permit. The action in the community list determines whether the route map checks update messages for a given community value. The route map action and its **set** clauses determine what the route map does with update messages that contain that community value.

Use the **no** variant of this command to remove the community match clause from a route map.

**Syntax**

```
match community
{<community-listname>|<1-99>|<100-199>} [exact-match]

no match community
[<community-listname>|<1-99>|<100-199>|exact-match]
```

| Parameter            | Description                             |
|----------------------|-----------------------------------------|
| <community-listname> | The community list name or number.      |
| <1-99>               | Community list number (standard range). |
| <100-199>            | Community list number (expanded range). |
| exact-match          | Exact matching of communities.          |

**Mode** Route-map Configuration

**Usage** This command is valid for BGP update messages only.

Communities are used to group and filter routes. They are designed to provide the ability to apply policies to large numbers of routes by using match and set commands. Community lists are used to identify and filter routes by their common attributes.



**Example** To add entry 3 to the route map called `myroute`, which will process update messages if they contain the community values that are included in `mylist`, use the commands:

```
awplus# configure terminal
awplus(config)# route-map myroute permit 3
awplus(config-route-map)# match community mylist
```

**Related  
Commands**

- [ip community-list](#)
- [route-map](#)
- [set comm-list delete](#)
- [set community](#)
- [show route-map](#)

# match interface

**Overview** Use this command to add an interface match clause to a route map entry. Specify the interface name to match.

A route matches the route map if its interface matches the interface name.

Each entry of a route map can only match against one interface in one interface match clause. If the route map entry already has an interface match clause, entering this command replaces that match clause with the new clause.

Use the **no** variant of this command to remove the interface match clause from the route map entry. Use the **no** variant of this command without a specified interface to remove all interfaces.

**Syntax** `match interface <interface>`  
`no match interface [<interface>]`

| Parameter                      | Description                                  |
|--------------------------------|----------------------------------------------|
| <code>&lt;interface&gt;</code> | The VLAN to match, e.g. <code>vlan2</code> . |

**Mode** Route-map Configuration

**Usage** This command is valid for RIP and OSPF routes only.

**Example** To add entry 10 to the route map called `mymap1`, which will process routes if they use the interface `vlan1`, use the commands:

```
awplus# configure terminal
awplus(config)# route-map mymap1 permit 10
awplus(config-route-map)# match interface vlan1
```

To remove all interfaces from the route map called `mymap1`, use the commands:

```
awplus# configure terminal
awplus(config)# route-map mymap1 permit 10
awplus(config-route-map)# no match interface
```

**Related Commands**

- [match ip address](#)
- [match ip next-hop](#)
- [match route-type](#)
- [match tag](#)
- [route-map](#)
- [show route-map](#)

# match ip address

**Overview** Use this command to add an IP address prefix match clause to a route map entry. You can specify the prefix or prefixes to match by specifying the name of the prefix list. To create the prefix list, enter Global Configuration mode and use the **ip prefix-list** command.

A route matches the route map entry if the route's prefix matches the prefix list.

Each entry of a route map can have at most one one prefix list-based IP address match clause. If the route map entry already has one match clause, entering this command replaces that match clause with the new clause.

Note that prefix lists and route map entries all specify an action of deny or permit. The action in the prefix list determines whether the route map checks update messages and routes for a given prefix. The route map action and its **set** clauses determine what the route map does with routes that contain that prefix.

A route matches the route map entry if the route's prefix matches the prefix list.

Each entry of a route map can have at most one prefix list-based IP address match clause. If the route map entry already has one match clause, entering this command replaces that match clause with the new clause.

Note that prefix lists and route map entries all specify an action of deny or permit. The action in the prefix list determines whether the route map checks update messages and routes for a given prefix. The route map action and its **set** clauses determine what the route map does with routes that contain that prefix.

Use the **no** variant of this command to remove the IP address match clause from a route map entry. To remove a prefix list-based match clause you must also specify the **prefix-list** parameter.

**Syntax** `match ip address prefix-list <prefix-listname>`  
`no match ip address prefix-list <prefix-listname>`

| Parameter                            | Description                                               |
|--------------------------------------|-----------------------------------------------------------|
| <code>prefix-list</code>             | Use an IP prefix list to specify which prefixes to match. |
| <code>&lt;prefix-listname&gt;</code> | The prefix list name.                                     |

**Mode** Route-map Configuration

**Usage** The **match ip address** command specifies the IP address to be matched. The outcome of matching against the IP address is:

- If there is a match for the specified IP address, and **permit** is specified, then the route is redistributed or controlled, as specified by the set action.
- If there is a match for the specified IP address, and **deny** is specified, then the route is not redistributed or controlled.

- If the match criteria are not met, the route is neither accepted nor forwarded, irrespective of **permit** or **deny** specifications.

This command is valid for:

- OSPF routes
- routes in BGP update messages
- RIP routes.

**Examples** To add entry 3 to the route map called `rmap1`, which will process routes that match the prefix list called `mylist`, use the commands:

```
awplus# configure terminal
awplus(config)# route-map rmap1 permit 3
awplus(config-route-map)# match ip address prefix-list mylist
```

**Related  
Commands** [route-map](#)  
[show route-map](#)

# match ip next-hop

**Overview** Use this command to add a next-hop match clause to a route map entry. You can specify the next hop to match by specifying the name of a prefix list. To create the prefix list, enter Global Configuration mode and use the **ip prefix-list** command.

A route matches the route map if the route's next hop matches the prefix list.

Each entry of a route map can have at most one prefix list-based next-hop match clause. If the route map entry already has one match clause, entering this command replaces that match clause with the new clause.

Note that prefix lists and route map entries all specify an action of deny or permit. The action in the access list or prefix list determines whether the route map checks update messages and routes for a given next-hop value. The route map action and its **set** clauses determine what the route map does with update messages and routes that contain that next hop.

Use the **no** variant of this command to remove the next-hop match clause from a route map entry. To remove a prefix list-based match clause you must also specify the prefix-list parameter.

**Syntax** `match ip next-hop prefix-list <prefix-listname>`  
`no match ip next-hop prefix-list [<prefix-listname>]`

| Parameter                            | Description                                               |
|--------------------------------------|-----------------------------------------------------------|
| <code>prefix-list</code>             | Use an IP prefix list to specify which next hop to match. |
| <code>&lt;prefix-listname&gt;</code> | The prefix list name.                                     |

**Mode** Route-map Configuration

**Usage** This command is valid for:

- OSPF routes
- routes in BGP update messages
- RIP routes.

**Examples** To add entry 3 to the route map called `mymap`, which will process routes whose next hop matches the prefix list called `list1`, use the commands:

```
awplus# configure terminal
awplus(config)# route-map mymap permit 3
awplus(config-route-map)# match ip next-hop prefix-list list1
```

**Related Commands** [route-map](#)  
[show route-map](#)

# match ipv6 address

**Overview** Use this command to specify the match address of route.

Use the **no** variant of this command to remove the `match ipv6 address` entry.

**Syntax** `match ipv6 address prefix-list <prefix-listname>`  
`no match ipv6 address [prefix-list <prefix-listname>]`

| Parameter                            | Description                                                                                                                 |
|--------------------------------------|-----------------------------------------------------------------------------------------------------------------------------|
| <code>&lt;prefix-listname&gt;</code> | The name of the IPv6 prefix list that specifies criteria for the addresses to be matched.<br>Valid only with BGP and RIPng. |

**Mode** Route-map Configuration

**Usage** The **match ipv6 address prefix-list** command specifies the entries of prefix-lists to be matched. If there is a match for the specified prefix-list entries, and `permit` is specified, the route is redistributed or controlled as specified by the set action. If the match criteria are met, and `deny` is specified, the route is not redistributed or controlled. If the match criteria are not met, the route is neither accepted nor forwarded, irrespective of `permit` or `deny` specifications.

**Examples** `awplus# configure terminal`  
`awplus(config)# route-map rmap1 permit 3`  
`awplus(config-route-map)# match ipv6 address prefix-list mylist`

# match ipv6 next-hop

**Overview** Use this command to specify a next-hop address to be matched by the route-map. Use the **no** variant of this command to disable this function.

## Syntax

| Parameter                            | Description                                                                               |
|--------------------------------------|-------------------------------------------------------------------------------------------|
| <code>&lt;prefix-listname&gt;</code> | The name of the IPv6 prefix list that specifies criteria for the addresses to be matched. |

**Mode** Route-map Configuration

**Usage** The **match ipv6 next-hop** command specifies the next-hop address to be matched. If there is a match for the specified next-hop address, and `permit` is specified, the route is redistributed or controlled as specified by the `set` action. If the match criteria are met, and `deny` is specified, the route is not redistributed or controlled. If the match criteria are not met, the route is neither accepted nor forwarded, irrespective of `permit` or `deny` specifications.

**NOTE:** *This command is valid only for BGP.*

# match metric

**Overview** Use this command to add a metric match clause to a route map entry. Specify the metric value to match.

A route matches the route map if its metric matches the route map's metric.

A BGP update message matches the route map if its MED attribute value matches the route map's metric.

Each entry of a route map can only match against one metric value in one metric match clause. If the route map entry already has a metric match clause, entering this command replaces that match clause with the new clause.

Use the **no** variant of this command to remove the metric match clause from the route map entry.

**Syntax** `match metric <metric>`  
`no match metric [<metric>]`

| Parameter | Description                                |
|-----------|--------------------------------------------|
| <metric>  | <0-4294967295> Specifies the metric value. |

**Mode** Route-map Configuration

**Usage** This command is valid for:

- OSPF routes
- routes in BGP update messages
- RIP routes.

**Example** To stop entry 3 of the route map called `myroute` from processing routes with a metric of 888999, use the commands:

```
awplus# configure terminal
awplus(config)# route-map myroute permit 3
awplus(config-route-map)# no match metric 888999
```

**Related Commands** [route-map](#)  
[set metric](#)  
[show route-map](#)



# match origin

**Overview** Use this command to add an origin match clause to a route map entry. Specify the origin attribute value to match.

A BGP update message matches the route map if its origin attribute value matches the route map's origin value.

Each entry of a route map can only match against one origin in one origin match clause. If the route map entry already has an origin match clause, entering this command replaces that match clause with the new clause.

Use the **no** variant of this command to remove the origin match clause from the route map entry.

**Syntax** `match origin {egp|igp|incomplete}`  
`no match origin [egp|igp|incomplete]`

| Parameter  | Description                                      |
|------------|--------------------------------------------------|
| egp        | Learned from an exterior gateway protocol.       |
| igp        | Learned from a local interior gateway protocol.  |
| incomplete | Of unknown heritage, for example a static route. |

**Mode** Route-map Configuration

**Usage** The origin attribute defines the origin of the path information. The **egp** parameter is indicated as an **e** in the routing table, and it indicates that the origin of the information is learned via Exterior Gateway Protocol. The **igp** parameter is indicated as an **i** in the routing table, and it indicates the origin of the path information is interior to the originating AS. The **incomplete** parameter is indicated as a **?** in the routing table, and indicates that the origin of the path information is unknown or learned through other means. If a static route is redistributed into BGP, the origin of the route is incomplete.

The **match origin** command specifies the origin to be matched. If there is a match for the specified origin, and **permit** is specified, the route is redistributed or controlled as specified by the set action. If the match criteria are met, and **deny** is specified, the route is not redistributed or controlled. If the match criteria are not met, the route is neither accepted nor forwarded, irrespective of **permit** or **deny** specifications.

This command is valid for BGP update messages only.

**Example** To add entry 34 to the route map called "rmap1", which will drop externally-originated routes, use the commands:

```
awplus# configure terminal
awplus(config)# route-map myroute deny 34
awplus(config-route-map)# match origin egp
```

**Related  
Commands** route-map  
set origin  
show route-map

# match route-type

**Overview** Use this command to add an external route-type match clause to a route map entry. Specify whether to match OSPF type-1 external routes or OSPF type-2 external routes.

An OSPF route matches the route map if its route type matches the route map's route type.

Each entry of a route map can only match against one route type in one match clause. If the route map entry already has a route type match clause, entering this command replaces that match clause with the new clause.

Use the **no** variant of this command to remove the route type match clause from the route map entry.

**Syntax** `match route-type external {type-1|type-2}`  
`no match route-type external [type-1|type-2]`

| Parameter | Description                  |
|-----------|------------------------------|
| type-1    | OSPF type-1 external routes. |
| type-2    | OSPF type-2 external routes. |

**Mode** Route-map Configuration

**Usage** Use the **match route-type external** command to match specific external route types. AS- external LSA is either Type-1 or Type-2. **external type-1** matches only Type 1 external routes, and **external type-2** matches only Type 2 external routes. This command is valid for OSPF routes only.

**Example** To add entry 10 to the route map called `mymap1`, which will process type-1 external routes, use the commands:

```
awplus# configure terminal
awplus(config)# route-map mymap1 permit 10
awplus(config-route-map)# match route-type external type-1
```

**Related Commands**

- [match interface](#)
- [match ip address](#)
- [match ip next-hop](#)
- [match tag](#)
- [route-map](#)
- [set metric-type](#)
- [show route-map](#)

# match tag

**Overview** Use this command to add a tag match clause to a route map entry. Specify the route tag value to match.

An OSPF route matches the route map if it has been tagged with the route map's tag value. Routes can be tagged through OSPF commands or through another route map's set clause.

Each entry of a route map can only match against one tag in one match clause. If the route map entry already has a tag match clause, entering this command replaces that match clause with the new clause.

Use the **no** variant of this command to remove the tag match clause from the route map entry.

**Syntax** `match tag <0-4294967295>`  
`no match tag [<0-4294967295>]`

**Mode** Route-map Configuration

**Usage** This command is valid for OSPF routes only.

**Example** To add entry 10 to the route map called `mymap1`, which will process routes that are tagged 100, use the following commands:

```
awplus# configure terminal
awplus(config)# route-map mymap1 permit 10
awplus(config-route-map)# match tag 100
```

**Related Commands**

- [match interface](#)
- [match ip address](#)
- [match ip next-hop](#)
- [match route-type](#)
- [route-map](#)
- [set tag](#)
- [show route-map](#)

# route-map

**Overview** Use this command to configure a route map entry, and to specify whether the device will process or discard matching routes.

The device uses a name to identify the route map, and a sequence number to identify each entry in the route map.

The **route-map** command puts you into route-map configuration mode. In this mode, you can use the following:

- one or more of the **match** commands to create match clauses. These specify what routes match the entry.
- one or more of the **set** commands to create set clauses. These change the attributes of matching routes.

Use the **no** variant of this command to delete a route map or to delete an entry from a route map.

**Syntax**

```
route-map <mapname> {deny|permit} <seq>
no route-map <mapname>
no route-map <mapname> {deny|permit} <seq>
```

| Parameter | Description                                                                                                               |
|-----------|---------------------------------------------------------------------------------------------------------------------------|
| <mapname> | A name to identify the route map.                                                                                         |
| deny      | The route map causes a routing process to discard matching routes.                                                        |
| permit    | The route map causes a routing process to use matching routes.                                                            |
| <seq>     | <1-65535> The sequence number of the entry. You can use this parameter to control the order of entries in this route map. |

**Mode** Global Configuration

**Usage** Route maps allow you to control and modify routing information by filtering routes and setting route attributes. You can apply route maps when the device:

- processes BGP update messages that it has received from a peer
- prepares BGP update messages to send to peers
- redistributes routes from one routing protocol into another
- redistributes static routes into routing protocols
- uses BGP route flap dampening

When a routing protocol passes a route through a route map, it checks the entries in order of their sequence numbers, starting with the lowest numbered entry.

If it finds a match on a route map with an action of permit, then it applies any set clauses and accepts the route. Having found a match, the route is not compared against any further entries of the route map.

If it finds a match on a route map with an action of deny, it will discard the matching route.

If it does not find a match, it discards the route. This means that route maps end with an implicit deny entry. To permit all non-matching routes, end your route map with an entry that has an action of **permit** and no match clause.

**Examples** To enter route-map mode for entry 1 of the route map called "route1", and then add a match and set clause to it, use the commands:

```
awplus# configure terminal
awplus(config)# route-map route1 permit 1
awplus(config-route-map)# match as-path 60
awplus(config-route-map)# set weight 70
```

To enter route-map mode for entry 2 of the route map called "route1", and then add a match and set clause to it, use the commands:

```
awplus# configure terminal
awplus(config)# route-map route1 permit 2
awplus(config-route-map)# match interface vlan2
awplus(config-route-map)# set metric 20
```

Note how the prompt changes when you go into route map configuration mode.

To make the device process non-matching routes instead of discarding them, add a command like the following one:

```
awplus(config)# route-map route1 permit 100
```

**Related  
Commands**

For BGP:

- [show route-map](#)
- [bgp dampening](#)
- [neighbor default-originate](#)
- [neighbor route-map](#)
- [neighbor unsuppress-map](#)
- [network \(BGP and BGP4+\)](#)
- [redistribute \(into BGP or BGP4+\)](#)
- [show ip bgp route-map \(BGP only\)](#)

For OSPF:

- [default-information originate](#)
- [redistribute \(OSPF\)](#)

For RIP:  
`redistribute (RIP)`

# set aggregator

**Overview** Use this command to add an aggregator set clause to a route map entry.

When a BGP update message matches the route map entry, the device sets the update's aggregator attribute. The aggregator attribute specifies the AS and IP address of the device that performed the aggregation.

Use the **no** variant of this command to remove the set clause.

**Syntax** `set aggregator as <asnum> <ip-address>`  
`no set aggregator as`

| Parameter    | Description                       |
|--------------|-----------------------------------|
| <asnum>      | The AS number of the aggregator.  |
| <ip-address> | The IP address of the aggregator. |

**Mode** Route-map Configuration

**Usage** An Autonomous System (AS) is a collection of networks under a common administration sharing a common routing strategy. It is subdivided by areas, and is assigned a unique 16-bit number. Use the **set aggregator** command to assign an AS number for the aggregator.

This command is valid for BGP update messages only.

**Example** To use entry 3 of the route map called `myroute` to set the aggregator attribute to `4310.10.0.3` in matching update messages, use the commands:

```
awplus# configure terminal
awplus(config)# route-map myroute permit 3
awplus(config-route-map)# set aggregator as 43 10.10.0.3
```

To remove all aggregator attributes for entry 3 of the route map called `myroute`, use the commands:

```
awplus# configure terminal
awplus(config)# route-map myroute permit 3
awplus(config-route-map)# no set aggregator as
```

**Related Commands** [route-map](#)  
[show route-map](#)



# set as-path

**Overview** Use this command to add an AS path set clause to a route map entry.

When a BGP update message matches the route map entry, the device prepends the specified Autonomous System Number (ASN) or ASNs to the update's AS path attribute.

The AS path attribute is a list of the autonomous systems through which the announcement for the prefix has passed. As prefixes pass between autonomous systems, each autonomous system adds its ASN to the beginning of the list. This means that the AS path attribute can be used to make routing decisions.

Use the **no** variant of this command to remove the set clause.

**Syntax** `set as-path prepend <1-65535> [<1-65535>]...`  
`no set as-path prepend [<1-65535> [<1-65535>]...]`

| Parameter                    | Description                                                                                    |
|------------------------------|------------------------------------------------------------------------------------------------|
| <code>prepend</code>         | Prepends the autonomous system path.                                                           |
| <code>&lt;1-65535&gt;</code> | The number to prepend to the AS path. If you specify multiple ASNs, separate them with spaces. |

**Mode** Route-map mode

**Usage** Use the **set as-path** command to specify an autonomous system path. By specifying the length of the AS-Path, the device influences the best path selection by a neighbor. Use the `prepend` parameter with this command to prepend an AS path string to routes increasing the AS path length.

This command is valid for BGP update messages only.

**Example** To use entry 3 of the route map called `myroute` to prepend ASN 8 and 24 to the AS path of matching update messages, use the commands:

```
awplus# configure terminal
awplus(config)# route-map myroute permit 3
awplus(config-route-map)# set as-path prepend 8 24
```

**Related Commands** [match as-path](#)  
[route-map](#)  
[show route-map](#)

# set atomic-aggregate

**Overview** Use this command to add an atomic aggregate set clause to a route map entry. When a BGP update message matches the route map entry, the device adds the atomic aggregate attribute to the update. Use the **no** variant of this command to remove the set clause.

**Syntax** `set atomic-aggregate`  
`no set atomic-aggregate`

**Mode** Route-map Configuration

**Usage** This command is valid for BGP update messages only.

**Example** To use entry 3 of the route map called `rmap1` to add the atomic aggregator attribute to matching update messages, use the commands:

```
awplus# configure terminal
awplus(config)# route-map rmap1 permit 3
awplus(config-route-map)# set atomic-aggregate
```

**Related Commands** [route-map](#)  
[show route-map](#)

# set comm-list delete

**Overview** Use this command to delete one or more communities from the community attribute of a BGP update message. Specify the communities to delete by specifying a community list. To create the community list, enter Global Configuration mode and use the [ip community-list](#) command.

When a BGP update message matches the route map entry, the device deletes the specified communities from the update's community attribute.

Use the **no** variant of this command to stop deleting the communities.

**Syntax** `set comm-list {<1-199>|<100-199>|<word>} delete`  
`no set comm-list {<1-199>|<100-199>|<word>} delete`

| Parameter | Description                     |
|-----------|---------------------------------|
| <1-99>    | Standard community-list number. |
| <100-199> | Expanded community-list number. |
| <word>    | Name of the Community-list.     |

**Mode** Route-map Configuration

**Usage** This command is valid for BGP update messages only.

**Example** To use entry 3 of the route map called `myroute` to delete the communities in community list 34 from matching update messages, use the commands:

```
awplus# configure terminal
awplus(config)# route-map myroute permit 3
awplus(config-route-map)# set comm-list 34 delete
```

**Related Commands** [ip community-list](#)  
[match community](#)  
[route-map](#)  
[set community](#)  
[show route-map](#)

# set community

**Overview** Use this command to add a community set clause to a route map entry.

When a BGP update message matches the route map entry, the device takes one of the following actions:

- changes the update's community attribute to the specified value or values, or
- adds the specified community value or values to the update's community attribute, if you specify the **additive** parameter after specifying another parameter. or
- removes the community attribute from the update, if you specify the **none** parameter

Use the **no** variant of this command to remove the set clause.

**Syntax**

```
set community {[<1-65535>][AA:NN] [internet] [local-AS]
[no-advertise] [no-export] [additive]}
no set community {[AA:NN] [internet] [local-AS] [no-advertise]
[no-export] [additive]}
set community none
no set community none
```

| Parameter    | Description                                                                                                                                                                                                                                                                                                                                                   |
|--------------|---------------------------------------------------------------------------------------------------------------------------------------------------------------------------------------------------------------------------------------------------------------------------------------------------------------------------------------------------------------|
| <1-65535>    | The AS number of the community as an integer not in AA:NN format.                                                                                                                                                                                                                                                                                             |
| AA:NN        | The Autonomous System (AS) number of the community, in AA:NN format. AS numbers are assigned to the regional registries by the IANA ( <a href="http://www.iana.org">www.iana.org</a> ) and can be obtained from the registry in your region. AA and NN are both integers from 1 to 65535. AA is the AS number; NN is a value chosen by the ASN administrator. |
| local-AS     | The community of routes that must not be advertised to external BGP peers (this includes peers in other members' Autonomous Systems inside a BGP confederation).                                                                                                                                                                                              |
| internet     | The community of routes that can be advertised to all BGP peers.                                                                                                                                                                                                                                                                                              |
| no-advertise | The community of routes that must not be advertised to other BGP peers.                                                                                                                                                                                                                                                                                       |
| no-export    | The community of routes that must not be advertised outside a BGP confederation boundary (a standalone Autonomous System that is not part of a confederation should be considered a confederation itself).                                                                                                                                                    |

| Parameter | Description                                                                                                                                                                                                                       |
|-----------|-----------------------------------------------------------------------------------------------------------------------------------------------------------------------------------------------------------------------------------|
| none      | The device removes the community attribute from matching update messages.                                                                                                                                                         |
| additive  | The device adds the specified community value to the update message's community attribute, instead of replacing the existing attribute. By default this parameter is not included, so the device replaces the existing attribute. |

**Mode** Route-map Configuration

**Usage** This command is valid for BGP update messages only.

**Examples** To use entry 3 of the route map called `rmap1` to put matching routes into the no-advertise community, use the commands:

```
awplus# configure terminal
awplus(config)# route-map rmap1 permit 3
awplus(config-route-map)# set community no-advertise
```

To use entry 3 of the route map called `rmap1` to put matching routes into several communities, use the commands:

```
awplus# configure terminal
awplus(config)# route-map rmap1 permit 3
awplus(config-route-map)# set community 10:01 23:34 12:14
no-export
```

To use entry 3 of the route map called `rmap1` to put matching routes into a single AS community numbered 16384, use the commands:

```
awplus# configure terminal
awplus(config)# route-map rmap1 permit 3
awplus(config-route-map)# set community 16384 no-export
```

**Related Commands** [match community](#)  
[route-map](#)

[set aggregator](#)

[set comm-list delete](#)

[set extcommunity](#)

[show route-map](#)

# set dampening

**Overview** Use this command to add a route flap dampening set clause to a route map entry.

Also use the route map by specifying it in the command [bgp dampening route-map](#).

When a route matches the route map entry, the device enables route flap dampening for that route. If the set clause includes dampening parameter values, the device uses those values when dampening the matching route.

Use the **no** variant of this command to remove the set clause. This disables dampening on matching routes.

**Syntax**

```
set dampening
set dampening [<reachtime>]
set dampening <reachtime> [<reuse> <suppress> <maxsuppress>]
[<unreachtime>]
no set dampening
no set dampening [<reachtime>]
no set dampening <reachtime> [<reuse> <suppress> <maxsuppress>]
[<unreachtime>]
```

| Parameter   | Description                                                                                                                                                                                                                                                                                                                                           |
|-------------|-------------------------------------------------------------------------------------------------------------------------------------------------------------------------------------------------------------------------------------------------------------------------------------------------------------------------------------------------------|
| <reachtime> | <1-45><br>The time it takes, in minutes, for the route's instability penalty to halve if the route remains stable. The instability penalty is called the Figure of Merit (FoM). For example, if reachtime is 15, the FoM of a stable route halves over a 15 minute period, quarters over a 30 minute period, and so on.<br>The default is 15 minutes. |
| <reuse>     | <1-20000><br>The value that the instability penalty (FoM) must reach for the device to use a suppressed route again. Once a route is suppressed, it remains suppressed until its FoM falls below this threshold. Reuse must not exceed suppress. The default is 750.                                                                                  |
| <suppress>  | <1-20000><br>The instability penalty (FoM) at which the route is suppressed. Suppress must be greater than or equal to reuse.<br>If suppress is less than 1000, a route is suppressed when it becomes unreachable for the first time. The default is 2000.                                                                                            |

| Parameter                        | Description                                                                                                                                                                                                                                                                                                                                                                                                                                                                                                                                                           |
|----------------------------------|-----------------------------------------------------------------------------------------------------------------------------------------------------------------------------------------------------------------------------------------------------------------------------------------------------------------------------------------------------------------------------------------------------------------------------------------------------------------------------------------------------------------------------------------------------------------------|
| <code>&lt;maxsuppress&gt;</code> | <p><code>&lt;1-255&gt;</code></p> <p>A number that is multiplied by reachtime to give the maximum time in minutes for which a suppressed route must remain stable in order to become unsuppressed. The lowest maxsuppress value of 1 gives a maximum suppression time of 1 x reachtime, and the highest maxsuppress value of 255 gives a maximum suppression time of 255 x reachtime.</p> <p>For example, if reachtime is 15 and maxsuppress is 4, the route is unsuppressed after 60 minutes of stability even if its FoM still exceeds reuse. The default is 4.</p> |
| <code>&lt;unreachtime&gt;</code> | <p><code>&lt;1-45&gt;</code></p> <p>The time it takes, in minutes, for the route's instability penalty to halve if the route remains unstable. The default is 15 minutes.</p>                                                                                                                                                                                                                                                                                                                                                                                         |

**Mode** Route-map Configuration

**Usage** The **suppress** value must be greater than or equal to the **reuse** value.

Set the unreachability half-life time to be equal to, or greater than, reachability half-life time. The suppress-limit value must be greater than or equal to the reuse limit value.

This command is valid for BGP routes only.

**Example** To use entry 24 of the route map called R1 to enable dampening of matching routes and set the dampening parameters, use the commands:

```
awplus# configure terminal
awplus(config)# route-map R1 permit 24
awplus(config-route-map)# set dampening 20 333 534 30
```

**Related Commands**

- [bgp dampening](#)
- [route-map](#)
- [show route-map](#)

# set extcommunity

**Overview** Use this command to add an extended community set clause to a route map entry. A route map entry can have a route target extended community set clause, a site-of-origin extended community set clause, or both.

When a BGP update message matches the route map entry, the device sets the update's extended community attribute to the specified value or values.

Use the **no** variant of this command to remove the set clause.

**Syntax** `set extcommunity {rt|soo} <extcomm-number>`  
`no set extcommunity {rt|soo} [<extcomm-number>]`

| Parameter        | Description                                                                                                        |
|------------------|--------------------------------------------------------------------------------------------------------------------|
| rt               | Configure a route target extended community. This consists of routers that will receive matching routes.           |
| soo              | Configure a site-of-origin extended community. This consists of routers that will inject matching routes into BGP. |
| <extcomm-number> | The extended community number, in the format AA:NN or IPADD:N.                                                     |

**Mode** Route-map Configuration

**Usage** This command is valid for BGP update messages only.

**Examples** To use entry 3 of the route map called `rmap1` to set the route target extended community attribute to `06:01`, use the commands:

```
awplus# configure terminal
awplus(config)# route-map rmap1 permit 3
awplus(config-route-map)# set extcommunity rt 06:01
```

To instead specify the extended community number in dotted decimal notation, use the command:

```
awplus# configure terminal
awplus(config)# route-map rmap1 permit 3
awplus(config-route-map)# set extcommunity rt 0.0.0.6:01
```

To use entry 3 of the route map called `rmap1` to set the site-of-origin extended community attribute to `06:01`, use the commands:

```
awplus# configure terminal
awplus(config)# route-map rmap1 permit 3
awplus(config-route-map)# set extcommunity soo 06:01
```



To instead specify the extended community number in dotted decimal notation, use the command:

```
awplus# configure terminal
awplus(config)# route-map rmap1 permit 3
awplus(config-route-map)# set extcommunity soo 0.0.0.6:01
```

**Related  
Commands**

[match community](#)  
[route-map](#)  
[set comm-list delete](#)  
[set community](#)  
[show route-map](#)

# set ip next-hop (route map)

**Overview** Use this command to add a next-hop set clause to a route map entry.

When a router BGP update message matches the route map entry, the device sets the route's next hop to the specified IP address.

Use the **no** variant of this command to remove the set clause.

**Syntax** `set ip next-hop <ip-address>`  
`no set ip next-hop [<ip-address>]`

| Parameter                       | Description                                                  |
|---------------------------------|--------------------------------------------------------------|
| <code>&lt;ip-address&gt;</code> | The IP address of the next hop, entered in the form A.B.C.D. |

**Mode** Route-map Configuration

**Usage** Use this command to set the next-hop IP address to the routes.

This command is valid for:

- OSPF routes
- routes in BGP update messages
- RIP routes.

**Example** To use entry 3 of the route map called `mymap` to give matching routes a next hop of 10.10.0.67, use the commands:

```
awplus# configure terminal
awplus(config)# route-map mymap permit 3
awplus(config-route-map)# set ip next-hop 10.10.0.67
```

**Related Commands** [match ip next-hop](#)  
[route-map](#)  
[show route-map](#)

# set ipv6 next-hop

**Overview** Use this command to set a next hop-address.

Use the **no** variant of this command to delete an entry.

**Syntax** `set ipv6 next-hop {<ipv6-addr-global>|local <ipv6-addr>}`  
`no set ipv6 next-hop [<ipv6-addr-global>|local [<ipv6-addr>]]`

| Parameter                             | Description                                                                     |
|---------------------------------------|---------------------------------------------------------------------------------|
| <code>&lt;ipv6-addr-global&gt;</code> | The IPv6 global address of next hop. The IPv6 address uses the format X:X::X:X. |
| <code>local</code>                    | Specifies that the address is local.                                            |
| <code>&lt;ipv6-addr&gt;</code>        | The IPv6 local address of next hop. The IPv6 address uses the format X:X::X:X.  |

**Mode** Route-map Configuration

**Usage** Use this command to set the next-hop IPv6 address to the routes.

This command is valid only for BGP.

**Examples**

```
awplus# configure terminal
awplus(config)# route-map rmap1 permit 3
awplus(config-route-map)# set ipv6 next-hop local
fe80::203:47ff:fe97:66dc
awplus(config-route-map)# no set ipv6 next-hop
```

# set local-preference

**Overview** This command changes the default local preference value.

The local preference indicates the BGP local preference path attribute when there are multiple paths to the same destination. The path with the higher preference is chosen.

Use this command to define the preference of a particular path. The preference is sent to all routers and access servers in the local autonomous system.

The **no** variant of this command reverts to the default setting.

**Syntax** `set local-preference <pref-value>`  
`no set local-preference [<pref-value>]`

| Parameter                       | Description                                                                                                    |
|---------------------------------|----------------------------------------------------------------------------------------------------------------|
| <code>&lt;pref-value&gt;</code> | <code>&lt;0-4294967295&gt;</code> Configure local preference value. The default local preference value is 100. |

**Mode** Route-map Configuration

**Examples**

```
awplus# configure terminal
awplus(config)# route-map rmap1 permit 3
awplus(config-route-map)# set local-preference 2345555
awplus# configure terminal
awplus(config)# router bgp 100
awplus(config-route-map)# no set local-preference
```

**Related Commands** For related Route Map commands:

[route-map](#)

[show route-map](#)

For related BGP commands:

[bgp default local-preference \(BGP only\)](#)

[neighbor route-map](#)

# set metric

**Overview** Use this command to add a metric set clause to a route map entry.

When a router BGP update message matches the route map entry, the device takes one of the following actions:

- changes the metric (or for BGP, the MED attribute value) to the specified value, or
- adds or subtracts the specified value from the metric or MED attribute, if you specify **+or-** before the value (for example, to increase the metric by 2, enter **+2**)

Use the **no** variant of this command to remove the set clause.

**Syntax** `set metric {+<metric-value>|-<metric-value>|<metric-value>}`  
`no set metric [+<metric-value>|-<metric-value> |<metric-value>]`

| Parameter      | Description                                                                                                                 |
|----------------|-----------------------------------------------------------------------------------------------------------------------------|
| +              | Increase the metric or MED attribute by the specified amount.                                                               |
| -              | Decrease the metric or MED attribute by the specified amount.                                                               |
| <metric-value> | <0-4294967295><br>The new metric or MED attribute value, or the amount by which to increase or decrease the existing value. |

**Default** The default metric value for routes redistributed into OSPF and OSPFv3 is 20.

**Mode** Route-map Configuration

**Usage** For BGP, if you want the device to compare MED values in update messages from peers in different ASes, also enter the command [bgp always-compare-med](#). The device always compares MED values in update messages from peers in the same AS.

This command is valid for:

- OSPF routes
- routes in BGP update messages
- RIP routes.

Note that defining the OSPF metric in a route map supersedes the metric defined using a [redistribute \(OSPF\)](#) or a [redistribute \(IPv6 OSPF\)](#) command. For more information, see the [OSPFv3 Feature Overview and Configuration Guide](#) and the [OSPF Feature Overview and Configuration Guide](#).

**Examples** To use entry 3 of the route map called `rmap1` to give matching routes a metric of 600, use the commands:

```
awplus# configure terminal
awplus(config)# route-map rmap1 permit 3
awplus(config-route-map)# set metric 600
```

To use entry 3 of the route map called `rmap1` to increase the metric of matching routes by 2, use the commands:

```
awplus# configure terminal
awplus(config)# route-map rmap1 permit 3
awplus(config-route-map)# set metric +2
```

**Related  
Commands** [match metric](#)  
[route-map](#)  
[show route-map](#)

# set metric-type

**Overview** Use this command to add a metric-type set clause to a route map entry. When a route matches the route map entry, the device sets its route type to the specified value. Use the **no** variant of this command to remove the set clause.

**Syntax** `set metric-type {type-1|type-2}`  
`no set metric-type [type-1|type-2]`

| Parameter | Description                                                       |
|-----------|-------------------------------------------------------------------|
| type-1    | Redistribute matching routes into OSPF as type-1 external routes. |
| type-2    | Redistribute matching routes into OSPF as type-2 external routes. |

**Mode** Route-map Configuration

**Usage** This command is valid for OSPF routes only.

**Example** To use entry 3 of the route map called `rmap1` to redistribute matching routes into OSPF as type-1 external routes, use the commands:

```
awplus# configure terminal
awplus(config)# route-map rmap1 permit 3
awplus(config-route-map)# set metric-type 1
```

**Related Commands** [default-information originate](#)  
[redistribute \(OSPF\)](#)  
[match route-type](#)  
[route-map](#)  
[show route-map](#)

# set origin

**Overview** Use this command to add an origin set clause to a route map entry.

When a BGP update message matches the route map entry, the device sets its origin attribute to the specified value.

Use the **no** variant of this command to remove the set clause.

**Syntax** `set origin {egp|igp|incomplete}`  
`no set origin [egp|igp|incomplete]`

| Parameter  | Description                                      |
|------------|--------------------------------------------------|
| egp        | Learned from an exterior gateway protocol.       |
| igp        | Learned from a local interior gateway protocol.  |
| incomplete | Of unknown heritage, for example a static route. |

**Mode** Route-map Configuration

**Usage** This command is valid for BGP update messages only.

**Example** To use entry 3 of the route map called `rmap1` to give matching update messages an origin of `egp`, use the commands:

```
awplus# configure terminal
awplus(config)# route-map rmap1 permit 3
awplus(config-route-map)# set origin egp
```

**Related Commands** [match origin](#)  
[route-map](#)  
[show route-map](#)



# set originator-id

- Overview** Use this command to add an originator ID set clause to a route map entry.
- The originator ID is the router ID of the IBGP peer that first learned this route, either via an EBGP peer or by some other means such as importing it.
- When a BGP update message matches the route map entry, the device sets its originator ID attribute to the specified value.
- Use the **no** variant of this command to remove the set clause.

**Syntax** `set originator-id <ip-address>`  
`no set originator-id [<ip-address>]`

| Parameter                       | Description                                                    |
|---------------------------------|----------------------------------------------------------------|
| <code>&lt;ip-address&gt;</code> | The IP address of the originator, entered in the form A.B.C.D. |

**Mode** Route-map Configuration

**Usage** This command is valid for BGP update messages only.

**Example** To use entry 3 of the route map called `rmap1` to give matching update messages an originator ID of `1.1.1.1`, use the commands:

```
awplus# configure terminal
awplus(config)# route-map rmap1 permit 3
awplus(config-route-map)# set originator-id 1.1.1.1
```

**Related Commands** [route-map](#)  
[show route-map](#)

# set tag

**Overview** Use this command to add a tag set clause to a route map entry.

When a route matches the route map entry, the device sets its tag to the specified value when it redistributes the route into OSPF.

Use the **no** variant of this command to remove the set clause.

**Syntax** `set tag <tag-value>`  
`no set tag [<tag-value>]`

| Parameter                      | Description                                                             |
|--------------------------------|-------------------------------------------------------------------------|
| <code>&lt;tag-value&gt;</code> | <code>&lt;0-4294967295&gt;</code><br>Value to tag matching routes with. |

**Mode** Route-map Configuration

**Usage** This command is valid only when redistributing routes into OSPF.

**Example** To use entry 3 of the route map called `rmap1` to tag matching routes with the number 6, use the commands:

```
awplus# configure terminal
awplus(config)# route-map rmap1 permit 3
awplus(config-route-map)# set tag 6
```

**Related Commands**

- [default-information originate](#)
- [redistribute \(OSPF\)](#)
- [match tag](#)
- [route-map](#)
- [show route-map](#)

# set weight

**Overview** Use this command to add a weight set clause to a route map entry.

The weight value assists in best path selection of BGP routes. It is stored with the route in the BGP routing table, but is not advertised to peers. When there are multiple routes with a common destination, the device uses the route with the highest weight value.

When a route matches the route map entry, the device sets its weight to the specified value.

Use the **no** variant of this command to remove the set clause.

**Syntax** `set weight <weight>`  
`no set weight [<weight>]`

| Parameter                   | Description                                            |
|-----------------------------|--------------------------------------------------------|
| <code>&lt;weight&gt;</code> | <code>&lt;0-4294967295&gt;</code><br>The weight value. |

**Mode** Route-map Configuration

**Usage** This command is valid for BGP routes only.

**Example** To use entry 3 of the route map called `rmap1` to give matching routes a weight of 60, use the commands:

```
awplus# configure terminal
awplus(config)# route-map rmap1 permit 3
awplus(config-route-map)# set weight 60
```

**Related Commands** [route-map](#)  
[show route-map](#)

# show route-map

**Overview** Use this command to display information about one or all route maps.

**Syntax** `show route-map <map-name>`

| Parameter                     | Description                       |
|-------------------------------|-----------------------------------|
| <code>&lt;map-name&gt;</code> | A name to identify the route map. |

**Mode** User Exec and Privileged Exec

**Example** To display information about the route-map named `example-map`, use the command:

```
awplus# show route-map example-map
```

**Output** Figure 32-1: Example output from the **show route-map** command

```
route-map example-map, permit, sequence 1
 Match clauses:
 ip address prefix-list example-pref
 Set clauses:
 metric 100
route-map example-map, permit, sequence 200
 Match clauses:
 Set clauses:
```

**Related Commands** [route-map](#)

# 33

# Policy-based Routing Commands

## Introduction

**Overview** This chapter provides an alphabetical reference of commands used to configure policy-based routing.

For more information, see the [Policy-based Routing \(PBR\) Feature Overview and Configuration Guide](#).

- Command List**
- [“debug policy-based-routing”](#) on page 1454
  - [“ip policy-route”](#) on page 1455
  - [“ipv6 policy-route”](#) on page 1457
  - [“policy-based-routing”](#) on page 1459
  - [“policy-based-routing enable”](#) on page 1460
  - [“show ip pbr route”](#) on page 1461
  - [“show ipv6 pbr route”](#) on page 1463
  - [“show pbr rules”](#) on page 1465

# debug policy-based-routing

**Overview** Use this command to enable policy-based routing debugging. This will cause messages containing detailed debugging information to be displayed and logged at the "debugging" level.

Use the **no** variant of this command to disable policy-based routing debugging.

**Syntax** debug policy-based-routing  
no debug policy-based-routing

**Default** Policy-based routing debugging is disabled by default.

**Mode** Privileged Exec

**Examples** To enable policy-based routing debugging, use the command:

```
awplus# debug policy-based-routing
```

To disable policy-based routing debugging, use the command:

```
awplus# no debug policy-based-routing
```

**Related  
Commands** ip policy-route  
ipv6 policy-route  
policy-based-routing  
show ip pbr route  
show ipv6 pbr route

# ip policy-route

**Overview** Use this command to configure IP policy routes. These routes specify how the device will route traffic from specified applications and entities. You can specify the route's next-hop by specifying the egress interface, or by specifying the next-hop device's IP address (except on dynamic interfaces such as PPPoE). You can also list alternative next-hops to use if your first choice is down.

Use the **no** variant of this command to remove a policy route.

**Syntax** `ip policy-route [<1-128>] [match <application-name>] [from <source-entity>] [to <destination-entity>] nexthop {<interface-list>|<ip-add-list>}`  
`no ip policy-route <1-128>`

| Parameter            | Description                                                                                                                                                                                                                                                                                                                                                                                                                                                                           |
|----------------------|---------------------------------------------------------------------------------------------------------------------------------------------------------------------------------------------------------------------------------------------------------------------------------------------------------------------------------------------------------------------------------------------------------------------------------------------------------------------------------------|
| <1-128>              | The policy route ID number.<br>If you do not specify an ID number, the device assigns the new policy route the next available number, in multiples of 10. For example, if the highest numbered policy route is 81, the next policy route would be given an ID of 90.<br>Policy routes are checked in order of ID number, starting with the lowest ID number. The device applies the policy route as soon as it finds a matching route; it does not check the remaining policy routes. |
| <application-name>   | An application name.                                                                                                                                                                                                                                                                                                                                                                                                                                                                  |
| <source-entity>      | A source entity name.                                                                                                                                                                                                                                                                                                                                                                                                                                                                 |
| <destination-entity> | A destination entity name.                                                                                                                                                                                                                                                                                                                                                                                                                                                            |
| <interface-list>     | The name of the egress interface or interfaces. You can list up to 8 interfaces per policy route; the device sends the traffic out the first interface in the list that is up.                                                                                                                                                                                                                                                                                                        |
| <ip-add-list>        | The IP address of the next-hop. You can list up to 8 next-hop addresses per policy route; the device sends the traffic to the first address in the list that is reachable. Do not use this when the next-hop is on a dynamic interface (e.g. PPPoE); specify the interface name instead.                                                                                                                                                                                              |

**Default** No policy routes

**Mode** Policy-based-routing

**Usage** You must specify at least one of the **match**, **from** or **to** parameters. Packets will be routed to the specified next-hop if they match the application, come from the source entity, and are destined for the destination entity.

Before creating a policy route, you need to create the application and entities that specify the traffic you want to route. To create an application, use the [application](#) command. To create entities, use the [zone](#), [network \(Entity\)](#), and [host \(Entity\)](#) commands. To see existing applications and entities, use the [show application](#) and [show entity](#) commands.

**Examples** To create a policy route to route traffic that matches an application called “voice”, comes from the entity called “inside”, and is destined for the entity called “outside”, use the following commands:

```
awplus# configure terminal
awplus(config)# policy-based-routing
awplus(config-pbr)# policy-based-routing enable
awplus(config-pbr)# ip policy-route 10 match voice from inside
to outside nexthop 10.37.236.65
```

To delete the policy route created above, use the following commands:

```
awplus# configure terminal
awplus(config)# policy-based-routing
awplus(config-pbr)# no ip policy-route 10
```

To route the above traffic via ppp0 if ppp0 is up, or ppp1 if ppp0 is down, use the following commands:

```
awplus# configure terminal
awplus(config)# policy-based-routing
awplus(config-pbr)# policy-based-routing enable
awplus(config-pbr)# ip policy-route 20 match voice from inside
to outside nexthop ppp0 ppp1
```

To delete the policy route created above, use the following commands:

```
awplus# configure terminal
awplus(config)# policy-based-routing
awplus(config-pbr)# no ip policy-route 20
```

**Related Commands**

- [policy-based-routing](#)
- [policy-based-routing enable](#)
- [show application](#)
- [show entity](#)
- [show ip pbr route](#)



# ipv6 policy-route

**Overview** Use this command to configure IPv6 policy routes. These routes specify how the device will route traffic from specified applications and entities. You can specify the route's next-hop by specifying the egress interface, or by specifying the next-hop device's IPv6 address (except on dynamic interfaces such as PPPoE). You can also list alternative next-hops to use if your first choice is down.

Use the **no** variant of this command to remove a policy route.

**Syntax** `ipv6 policy-route [<1-128>] [match <application-name>] [from <source-entity>] [to <destination-entity>] nexthop {<interface-list>|<ipv6-add-list>}`  
`no ipv6 policy-route <1-128>`

| Parameter            | Description                                                                                                                                                                                                                                                                                                                                                                                                                                                                           |
|----------------------|---------------------------------------------------------------------------------------------------------------------------------------------------------------------------------------------------------------------------------------------------------------------------------------------------------------------------------------------------------------------------------------------------------------------------------------------------------------------------------------|
| <1-128>              | The policy route ID number.<br>If you do not specify an ID number, the device assigns the new policy route the next available number, in multiples of 10. For example, if the highest numbered policy route is 81, the next policy route would be given an ID of 90.<br>Policy routes are checked in order of ID number, starting with the lowest ID number. The device applies the policy route as soon as it finds a matching route; it does not check the remaining policy routes. |
| <application-name>   | An application name.                                                                                                                                                                                                                                                                                                                                                                                                                                                                  |
| <source-entity>      | A source entity name.                                                                                                                                                                                                                                                                                                                                                                                                                                                                 |
| <destination-entity> | A destination entity name.                                                                                                                                                                                                                                                                                                                                                                                                                                                            |
| <interface-list>     | The name of the egress interface or interfaces. You can list up to 8 interfaces per policy route; the device sends the traffic out the first interface in the list that is up.                                                                                                                                                                                                                                                                                                        |
| <ipv6-add-list>      | The IPv6 address of the next-hop, specified in the form X:X::X:X. You can list up to 8 next-hop addresses per policy route; the device sends the traffic to the first address in the list that is reachable.<br>Do not use this when the next-hop is on a dynamic interface (e.g. PPPoE); specify the interface name instead.                                                                                                                                                         |

**Default** No policy routes

**Mode** Policy-based-routing

**Usage** You must specify at least one of the **match**, **from** or **to** parameters. Packets will be routed to the specified next-hop if they match the application, come from the source entity, and are destined for the destination entity.

Before creating a policy route, you need to create the application and entities that specify the traffic you want to route. To create an application, use the [application](#) command. To create entities, use the [zone](#), [network \(Entity\)](#), and [host \(Entity\)](#) commands. To see existing applications and entities, use the [show application](#) and [show entity](#) commands.

**Examples** To create a policy route to route traffic that matches an application called "voice", comes from the entity called "inside", and is destined for the entity called "outside", use the following commands:

```
awplus# configure terminal
awplus(config)# policy-based-routing
awplus(config-pbr)# policy-based-routing enable
awplus(config-pbr)# ipv6 policy-route 10 match voice from
inside to outside nexthop 2001:100::1
```

To delete the policy route created above, use the following commands:

```
awplus# configure terminal
awplus(config)# policy-based-routing
awplus(config-pbr)# no ipv6 policy-route 10
```

To route the above traffic via ppp0 if ppp0 is up, or ppp1 if ppp0 is down, use the following commands:

```
awplus# configure terminal
awplus(config)# policy-based-routing
awplus(config-pbr)# policy-based-routing enable
awplus(config-pbr)# ipv6 policy-route 20 match voice from
inside to outside nexthop ppp0 ppp1
```

To delete the policy route created above, use the following commands:

```
awplus# configure terminal
awplus(config)# policy-based-routing
awplus(config-pbr)# no ipv6 policy-route 20
```

**Related Commands**

- [policy-based-routing](#)
- [policy-based-routing enable](#)
- [show application](#)
- [show entity](#)
- [show ipv6 pbr route](#)

# policy-based-routing

**Overview** Use this command to enter Policy-based-routing mode. Policy-based routing lets you determine how the device will route traffic from specified applications and entities.

Use the **no** variant of this command to remove the whole policy-based routing configuration.

**Syntax** `policy-based-routing`  
`no policy-based-routing`

**Mode** Global configuration

**Usage** Once you have entered policy-based-routing mode, use the [policy-based-routing enable](#) command to turn on policy-based routing, and the [ip policy-route](#) or [ipv6 policy-route](#) commands to create policy routes.

**Example** To enter policy-based-routing mode, use the commands:

```
awplus# configure terminal
awplus(config)# policy-based-routing
awplus(config-pbr)#
```

**Related Commands** [ip policy-route](#)  
[ipv6 policy-route](#)  
[policy-based-routing enable](#)

# policy-based-routing enable

**Overview** Use this command to enable policy-based routing (PBR). Policy-based routing lets you determine how the device will route traffic from specified applications and entities.

Use the **no** variant of this command to disable policy-based routing.

**Syntax** `policy-based-routing enable`  
`no policy-based-routing enable`

**Default** Policy-based routing is disabled by default

**Mode** Policy-based-routing

**Examples** To enable policy-based routing use the following commands.

```
awplus# configure terminal
awplus(config)# policy-based-routing
awplus(config-pbr)# policy-based-routing enable
```

To disable policy-based routing use the following commands.

```
awplus# configure terminal
awplus(config)# policy-based-routing
awplus(config-pbr)# no policy-based-routing enable
```

**Related  
Commands** [ip policy-route](#)  
[ipv6 policy-route](#)

# show ip pbr route

**Overview** Use this command to display the installed IPv4 routes for policy-based routing.

**Syntax** show ip pbr route [<1-128>]

| Parameter | Description                                                                                                                                                                                                                 |
|-----------|-----------------------------------------------------------------------------------------------------------------------------------------------------------------------------------------------------------------------------|
| <1-128>   | The policy route ID. If you specify a policy route ID, the output only lists routes for that ID. If you do not specify an ID, the output also lists the conventional static and dynamic routes, in the table called "main". |

**Mode** User Exec/Privileged Exec

**Usage** If you do not specify a policy routeID, the output starts by listing the ordinary static and dynamic routes, in a table called "main".

**Example** To show all the IPv4 routes, use the following command:

```
awplus# show ip pbr route
```

**Output** Figure 33-1: Example output from **show ip pbr route**

```
awplus#show ip pbr route
Route table: main
 10.33.11.0/24 via 10.37.236.65, eth1
 10.37.236.64/27 is directly connected, eth1
 172.31.0.0/17 is directly connected, vlan4092
 192.168.1.0/24 is directly connected, vlan2

Route table: policy-route 10

Route table: policy-route 20
 default via 10.37.236.65, ppp0
```

If you do not specify a policy routeID, the output starts by listing the ordinary static and dynamic routes, in the route table called "main".

Then it lists the routes for each policy route.

For each route, the output lists the route's next-hop IP address and/or the next-hop interface.

**Example** To show only the routes for policy route 20, use the following command:

```
awplus# show ip pbr route 20
```

**Output** Figure 33-2: Example output from **show ip pbr route** for a specified policy route

```
awplus#show ip pbr route 20

Route table: policy-route 20
 default via 10.37.236.65, ppp0
```

For each route, the output lists the route's next-hop IP address and/or the next-hop interface.

**Related  
Commands** [ip policy-route](#)  
[policy-based-routing](#)

# show ipv6 pbr route

**Overview** Use this command to display the installed IPv6 routes for policy-based routing.

**Syntax** `show ipv6 pbr route [<1-128>]`

| Parameter | Description                                                                                                                                                                                                             |
|-----------|-------------------------------------------------------------------------------------------------------------------------------------------------------------------------------------------------------------------------|
| <1-128>   | The policy route ID. If you specify a policy route ID, the output only lists routes for that ID. If you do not specify an ID, the output also lists the ordinary static and dynamic routes, in the table called "main". |

**Mode** User Exec/Privileged Exec

**Usage** If you do not specify a policy routeID, the output starts by listing the ordinary static and dynamic routes, in a table called "main".

**Example** To show all the IPv6 routes, use the following command:

```
awplus# show ipv6 pbr route
```

**Output** Figure 33-3: Example output from **show ipv6 pbr route**

```
awplus#show ipv6 pbr route
Route table: main
 2001:100::/64 dev eth1
 fe80::/64 dev eth1

Route table: policy-route 10

Route table: policy-route 20
 default via 2001:100::2, eth1
```

If you do not specify a policy routeID, the output starts by listing the ordinary static and dynamic routes, in the route table called "main".

Then it lists the routes for each policy route.

For each route, the output lists the route's next-hop IPv6 address and/or the next-hop interface.

**Example** To show only the routes for policy-route 20, use the following command:

```
awplus# show ip pbr route 20
```

**Output** Figure 33-4: Example output from **show ipv6 pbr route** for a specified policy route

```
awplus#show ipv6 pbr route 20

Route table: policy-route 20
 default via 2001:100::2, eth1
```

For each route, the output lists the route's next-hop IPv6 address and/or the next-hop interface.

**Related  
Commands** [ipv6 policy-route](#)  
[policy-based-routing](#)



# show pbr rules

**Overview** Use this command to display the configured IPv4 and IPv6 policy routes. It also shows the validity of the policy routes.

**Syntax** `show pbr rules`

**Mode** User Exec/Privileged Exec

**Example** To show information about the policy routes, use the command:

```
awplus# show pbr rules
```

**Output** Figure 33-5: Example output from **show pbr rules**

```
awplus#show pbr rules
Policy based routing is enabled
Rule Match From To Valid Nexthop

10 any entities.any entities.outside Yes 10.10.20.2
20 udp any any Yes 2001:100::2
```

Table 33-1: Parameters in the output from **show pbr rules**

| Parameter | Description                                                                                                                                                                                                                               |
|-----------|-------------------------------------------------------------------------------------------------------------------------------------------------------------------------------------------------------------------------------------------|
| Rule      | The policy route ID number. Policy routes are checked in order of ID number, starting with the lowest ID number. The device applies the policy route as soon as it finds a matching route; it does not check the remaining policy routes. |
| Match     | The name of an application. Packets will be routed to the specified next hop if they match this application, come from the source entity, and are destined for the destination entity.                                                    |
| From      | The name of the source entity. Packets will be routed to the specified next hop if they match the application, come from this source entity, and are destined for the destination entity.                                                 |
| To        | The name of the destination entity. Packets will be routed to the specified next hop if they match the application, come from the source entity, and are destined for this destination entity.                                            |

Table 33-1: Parameters in the output from **show pbr rules** (cont.)

| Parameter | Description                                                                                                                                                                                                                                                                            |
|-----------|----------------------------------------------------------------------------------------------------------------------------------------------------------------------------------------------------------------------------------------------------------------------------------------|
| Valid     | Whether the application and entities are valid.                                                                                                                                                                                                                                        |
| Nexthop   | The IPv4 or IPv6 address of the next-hop, or the egress interface. You can list up to 8 next-hop addresses or up to 8 interface names per policy route; the device sends the traffic to the first address in the list that is reachable or the first interface that is up and running. |

**Related  
Commands**

[ip policy-route](#)  
[ipv6 policy-route](#)  
[policy-based-routing](#)  
[show ip pbr route](#)  
[show ipv6 pbr route](#)

# 34

# VRF-lite Commands

## Introduction

**Overview** This chapter provides an alphabetical reference of commands used to configure Virtual Routing and Forwarding Lite (VRF-lite). See the [VRF Lite Feature Overview and Configuration Guide](#) for more information and examples.

- Command List**
- [“address-family”](#) on page 1470
  - [“address-family ipv4 \(RIP\)”](#) on page 1472
  - [“arp \(IP address MAC\)”](#) on page 1473
  - [“arp opportunistic-nd”](#) on page 1475
  - [“clear arp-cache”](#) on page 1477
  - [“clear ip bgp \\* \(BGP only\)”](#) on page 1479
  - [“clear ip bgp \(IPv4\) \(BGP only\)”](#) on page 1481
  - [“clear ip rip route”](#) on page 1482
  - [“crypto key pubkey-chain knownhosts”](#) on page 1484
  - [“default-metric \(RIP\)”](#) on page 1486
  - [“description \(VRF\)”](#) on page 1487
  - [“distance \(RIP\)”](#) on page 1488
  - [“distribute-list \(RIP\)”](#) on page 1489
  - [“export map”](#) on page 1490
  - [“fullupdate \(RIP\)”](#) on page 1491
  - [“import map”](#) on page 1492
  - [“ip route static inter-vrf”](#) on page 1493
  - [“ip route”](#) on page 1494
  - [“ip vrf”](#) on page 1497

- [“ip vrf forwarding”](#) on page 1498
- [“max-fib-routes \(VRF\)”](#) on page 1499
- [“max-static-routes \(VRF\)”](#) on page 1501
- [“neighbor next-hop-self”](#) on page 1502
- [“neighbor remote-as”](#) on page 1505
- [“neighbor password”](#) on page 1508
- [“network \(RIP\)”](#) on page 1512
- [“passive-interface \(RIP\)”](#) on page 1514
- [“ping”](#) on page 1515
- [“rd \(route distinguisher\)”](#) on page 1517
- [“redistribute \(into BGP or BGP4+\)”](#) on page 1518
- [“redistribute \(OSPF\)”](#) on page 1520
- [“redistribute \(RIP\)”](#) on page 1522
- [“route \(RIP\)”](#) on page 1524
- [“route-target”](#) on page 1525
- [“router ospf”](#) on page 1527
- [“router-id \(VRF\)”](#) on page 1529
- [“show arp”](#) on page 1530
- [“show crypto key pubkey-chain knownhosts”](#) on page 1533
- [“show ip bgp cidr-only \(BGP only\)”](#) on page 1535
- [“show ip bgp community \(BGP only\)”](#) on page 1536
- [“show ip bgp community-list \(BGP only\)”](#) on page 1538
- [“show ip bgp dampening \(BGP only\)”](#) on page 1539
- [“show ip bgp filter-list \(BGP only\)”](#) on page 1541
- [“show ip bgp inconsistent-as \(BGP only\)”](#) on page 1542
- [“show ip bgp longer-prefixes \(BGP only\)”](#) on page 1543
- [“show ip bgp prefix-list \(BGP only\)”](#) on page 1544
- [“show ip bgp quote-regexp \(BGP only\)”](#) on page 1545
- [“show ip bgp regexp \(BGP only\)”](#) on page 1547
- [“show ip bgp route-map \(BGP only\)”](#) on page 1549
- [“show ip bgp summary \(BGP only\)”](#) on page 1550
- [“show ip interface vrf”](#) on page 1552
- [“show ip rip vrf database”](#) on page 1554
- [“show ip rip vrf interface”](#) on page 1555
- [“show ip route”](#) on page 1556

- [“show ip route database”](#) on page 1559
- [“show ip route summary”](#) on page 1562
- [“show ip vrf”](#) on page 1564
- [“show ip vrf detail”](#) on page 1565
- [“show ip vrf interface”](#) on page 1566
- [“show running-config vrf”](#) on page 1567
- [“ssh”](#) on page 1568
- [“tcpdump”](#) on page 1570
- [“telnet”](#) on page 1571
- [“timers \(RIP\)”](#) on page 1572
- [“traceroute”](#) on page 1574
- [“version \(RIP\)”](#) on page 1575

# address-family

**Overview** This command enters the IPv4 or IPv6 Address-Family Configuration command mode. In this mode you can configure address-family specific parameters.

When using VRF-lite, you can enter IPv4 Address Family Configuration mode for a specified VRF instance before configuring that instance.

**Syntax [BGP]** address-family ipv4 [unicast]  
no address-family ipv4 [unicast]

**Syntax (VRF-lite)** address-family ipv4 [unicast|vrf <vrf-name>]  
no address-family ipv4 [unicast|vrf <vrf-name>]

**Syntax [BGP4+]** address-family ipv6 [unicast]  
no address-family ipv6 [unicast]

| Parameter  | Description                                                                      |
|------------|----------------------------------------------------------------------------------|
| ipv4       | Configure parameters relating to the exchange of IPv4 prefixes.                  |
| ipv6       | Configure parameters relating to the exchange of IPv6 prefixes.                  |
| unicast    | Configure parameters relating to the exchange of routes to unicast destinations. |
| vrf        | Applies the command to the specified VRF instance.                               |
| <vrf-name> | The name of the VRF instance to enter IPv4 Address-Family mode for.              |

**Mode [BGP]** Router Configuration

**Mode [BGP4+]** Router Configuration

**Usage** To leave the IPv4 or IPv6 Address Family Configuration mode, and return to the Router Configuration mode, use the [exit-address-family](#) command.

**Example [BGP]**

```
awplus# configure terminal
awplus(config)# router bgp 100
awplus(config-router)# neighbor 192.168.0.1 remote-as 100
awplus(config-router)# address-family ipv4 vrf green
awplus(config-router-af)# neighbor 192.168.0.1 activate
awplus(config-router-af)# exit-address-family
awplus(config-router)#
```

**Example [BGP4+]** awplus# configure terminal  
awplus(config)# router bgp 100  
awplus(config-router)# neighbor 2001:0db8:010d::1 remote-as 100  
awplus(config-router)# address-family ipv6  
awplus(config-router-af)# neighbor 2001:0db8:010d::1 activate  
awplus(config-router-af)# exit-address-family  
awplus(config-router)#

**Related  
Commands** [exit-address-family](#)

**Command  
changes** Version 5.4.6-2.1: VRF-lite support added.

# address-family ipv4 (RIP)

**Overview** This command enters the IPv4 address-family command mode. In this mode you can configure address-family specific parameters for a specific VRF (RIP) instance.

**Syntax**

```
address-family ipv4 vrf <vrf-name>
no address-family ipv4 vrf <vrf-name>
```

| Parameter  | Description                                                         |
|------------|---------------------------------------------------------------------|
| ipv4       | Configure parameters relating to the RIP exchange of IPv4 prefixes. |
| vrf        | Apply this command to a VRF instance.                               |
| <vrf-name> | The name of the VRF instance.                                       |

**Mode** Router Configuration

**Usage** To leave Address Family mode and return to Router Configuration mode, use the [exit-address-family](#) command.

**Example** In this example the address family "green" is entered, and then exited by using the [exit-address-family](#) command.

```
awplus# configure terminal
awplus(config)# router rip
awplus(config-router)# address-family ipv4 vrf green
awplus(config-router-af)# exit-address-family
awplus(config-router)#
```

**Related Commands** [exit-address-family](#)

**Command changes** Version 5.4.6-2.1: VRF-lite support added.



# arp (IP address MAC)

**Overview** This command adds a static ARP entry to the ARP cache. This is typically used to add entries for hosts that do not support ARP or to speed up the address resolution function for a host. The ARP entry must not already exist. Use the **alias** parameter to allow your device to respond to ARP requests for this IP address.

If VRF-lite is configured, you can add ARP entries to either the global cache or for a specific VRF instance.

The **no** variant of this command removes the static ARP entry. Use the [clear arp-cache](#) command to remove the dynamic ARP entries in the ARP cache.

**Syntax** `arp <ip-addr> <mac-address> [<port-number>] [alias]`  
`no arp <ip-addr>`

**Syntax (VRF-lite)** `arp [vrf <vrf-name>] <ip-addr> <mac-address> [<port-number>] [alias]`  
`no arp [vrf <vrf-name>] <ip-addr>`

| Parameter                        | Description                                                                                                                               |
|----------------------------------|-------------------------------------------------------------------------------------------------------------------------------------------|
| <code>&lt;ip-addr&gt;</code>     | The IPv4 address of the device you are adding as a static ARP entry.                                                                      |
| <code>&lt;mac-address&gt;</code> | The MAC address of the device you are adding as a static ARP entry, in hexadecimal notation with the format HHHH.HHHH.HHHH.               |
| <code>&lt;port-number&gt;</code> | The port number associated with the IP address. Specify this when the IP address is part of a VLAN.                                       |
| <code>alias</code>               | Allows your device to respond to ARP requests for the IP address. Proxy ARP must be enabled on the interface before using this parameter. |
| <code>vrf</code>                 | Apply this command to a VRF instance.                                                                                                     |
| <code>&lt;vrf-name&gt;</code>    | The name of the VRF instance.                                                                                                             |

**Mode** Global Configuration

**Examples** To add the IP address 10.10.10.9 with the MAC address 0010.2533.4655 into the ARP cache, and have your device respond to ARP requests for this address, use the commands:

```
awplus# configure terminal
awplus(config)# arp 10.10.10.9 0010.2355.4566 alias
```

**Example (VRF-lite)** To apply the above example within a VRF instance called `red` use the following commands:

```
awplus# configure terminal
awplus(config)# arp vrf red 10.10.10.9 0010.2355.4566 alias
```

**Related Commands**

- `clear arp-cache`
- `ip proxy-arp`
- `show arp`

**Command changes** Version 5.4.6-2.1: VRF-lite support added.

# arp opportunistic-nd

**Overview** Use this command to enable opportunistic neighbor discovery for the global ARP cache. This command changes the behavior for unsolicited ARP packet forwarding on the device.

When using VRF-lite, you can use this command to enable opportunistic neighbor discovery for a named VRF instance.

Use the **no** variant of this command to disable opportunistic neighbor discovery for the global ARP cache.

**Syntax** `arp opportunistic-nd`  
`no arp opportunistic-nd`

**Syntax (VRF-lite)** `arp opportunistic-nd [vrf <vrf-name>]`  
`no arp opportunistic-nd [vrf <vrf-name>]`

| Parameter                     | Description                           |
|-------------------------------|---------------------------------------|
| <code>vrf</code>              | Apply this command to a VRF instance. |
| <code>&lt;vrf-name&gt;</code> | The name of the VRF instance.         |

**Default** Opportunistic neighbor discovery is disabled by default.

**Mode** Global Configuration

**Usage** When opportunistic neighbor discovery is enabled, the device will reply to any received unsolicited ARP packets (but not gratuitous ARP packets). The source MAC address for the unsolicited ARP packet is added to the ARP cache, so the device forwards the ARP packet. When opportunistic neighbor discovery is disabled, the source MAC address for the ARP packet is not added to the ARP cache, so the ARP packet is not forwarded by the device.

Note this command enables or disables opportunistic neighbor discovery for a VRF instance if the **vrf** parameter and an instance name are applied. If a VRF instance is not specified, then opportunistic neighbor discovery is enabled or disabled for device ports configured for IPv4.

**Examples** To enable opportunistic neighbor discovery for the global ARP cache, enter:

```
awplus# configure terminal
awplus(config)# arp opportunistic-nd
```

To disable opportunistic neighbor discovery for the global ARP cache, enter:

```
awplus# configure terminal
awplus(config)# no arp opportunistic-nd
```

**Example (VRF-lite)** To enable opportunistic neighbor discovery for the VRF instance 'blue', enter:

```
awplus# configure terminal
awplus(config)# arp opportunistic-nd vrf blue
```

To disable opportunistic neighbor discovery for the VRF instance 'blue', enter:

```
awplus# configure terminal
awplus(config)# no arp opportunistic-nd vrf blue
```

**Related Commands**

- [ipv6 opportunistic-nd](#)
- [show arp](#)
- [show running-config interface](#)

**Command changes** Version 5.4.6-2.1: VRF-lite support added.

# clear arp-cache

**Overview** This command deletes dynamic ARP entries from the ARP cache. You can optionally specify the IPv4 address of an ARP entry to be cleared from the ARP cache.

When running VRF-lite, this command deletes dynamic ARP entries either from the ARP cache of a specific VRF instance, or from the ARP cache of the Global VRF instance. To delete all ARP entries from both the Global VRF instance and all VRF instances, use the command with no parameters. You can optionally specify the IPv4 address for the VRF instance to clear an ARP entry from the ARP cache.

**Syntax** `clear arp-cache [<ip-address>]`

**Syntax (VRF-lite)** `clear arp-cache [vrf <vrf-name>|global] [<ip-address>]`

| Parameter    | Description                                                                                              |
|--------------|----------------------------------------------------------------------------------------------------------|
| <ip-address> | Specifies a specific IPv4 address for a VRF instance whose entries are to be cleared from the ARP cache. |
| global       | When VRF-lite is configured, apply this command to the global routing and forwarding table.              |
| vrf          | Apply this command to the specified VRF instance.                                                        |
| <vrf-name>   | The VRF instance name                                                                                    |

**Mode** Privileged Exec

**Usage** To display the entries in the ARP cache, use the [show arp](#) command. To remove static ARP entries, use the no variant of the [arp \(IP address MAC\)](#) command.

**Example** To clear all dynamic ARP entries, use the command:

```
awplus# clear arp-cache
```

To clear all dynamic ARP entries associated with the IPv4 address 192.168.1.1, use the command:

```
awplus# clear arp-cache 192.168.1.1
```

**Example (VRF-lite)** To clear the dynamic ARP entries from the VRF instance named blue, use the commands:

```
awplus# clear arp-cache vrf blue
```

To clear the dynamic ARP entries from the VRF instance named blue with the IPv4 address 192.168.1.1, use the commands:

```
awplus# clear arp-cache vrf blue 192.168.1.1
```

When running VRF-lite, to clear the dynamic ARP entries from the global VRF-lite and all VRF instances, use the command:

```
awplus# clear arp-cache
```

**Related  
Commands**    [arp \(IP address MAC\)](#)  
              [show arp](#)

## clear ip bgp \* (BGP only)

**Overview** Use this command to reset all BGP connections, either by fully resetting sessions or by performing soft resets.

If VRF-lite is configured, you can reset BGP connections for all VRF instances or for a specified VRF instance.

**Syntax**

```
clear ip bgp *
clear ip bgp * in
clear ip bgp * out
clear ip bgp * soft [in|out]
clear ip bgp * in [prefix-filter]
```

**Syntax (VRF-lite)**

```
clear ip bgp * [vrf <vrf-name>]
clear ip bgp * [vrf <vrf-name>] in
clear ip bgp * [vrf <vrf-name>] out
clear ip bgp * [vrf <vrf-name>] soft [in|out]
clear ip bgp * in [prefix-filter]
```

| Parameter     | Description                                                                                                                                                                                                                                                                                                                           |
|---------------|---------------------------------------------------------------------------------------------------------------------------------------------------------------------------------------------------------------------------------------------------------------------------------------------------------------------------------------|
| *             | Clears all BGP peers.                                                                                                                                                                                                                                                                                                                 |
| in            | Indicates that incoming advertised routes will be cleared.                                                                                                                                                                                                                                                                            |
| prefix-filter | Specifies that a prefix-list will be sent, by the ORF mechanism, to those neighbors with which the ORF capability has been negotiated. The neighbors will be triggered to resend updates, which match the prefix-list filter, to the local router. The local router will then perform a soft reconfiguration.                         |
| out           | Indicates that outgoing advertised routes will be cleared.                                                                                                                                                                                                                                                                            |
| soft in       | Soft inbound reset causes the neighbors to resend all their updates to the local device, without resetting the connection or clearing the entries in the local device. So, the local device stores new updates, and uses them to systematically replace existing table entries. This process can use a considerable amount of memory. |
| soft out      | Soft outbound reset causes the device to simply resend all its updates to the specified neighbor(s), without resetting the connection, or clearing table entries.                                                                                                                                                                     |
| vrf           | Applies the command to the specified VRF instance.                                                                                                                                                                                                                                                                                    |
| <vrf-name>    | The name of the VRF instance.                                                                                                                                                                                                                                                                                                         |

**Mode** Privileged Exec

**Examples** To clear all BGP peers, use the command:

```
awplus# clear ip bgp *
```

**Example (VRF-lite)** To clear all BGP peers in VRF instance red, use the command:

```
awplus# clear ip bgp * vrf red
```

To clear all outbound BGP peers in VRF instance red, use the command:

```
awplus# clear ip bgp * out vrf red
```

**Command changes** Version 5.4.6-2.1: VRF-lite support added.



# clear ip bgp (IPv4) (BGP only)

**Overview** Use this command to reset the IPv4 BGP connection to the peer specified by the IP address. When VRF-lite is configured, you can apply this command to a specific VRF instance.

**Syntax [BGP]** `clear ip bgp <ipv4-addr> [in [prefix-filter]|out|soft [in|out]]`

**Syntax (VRF-lite)** `clear ip bgp <ipv4-address> [vrf <vrf-name>] [in|out|soft [in|out]]`

| Parameter     | Description                                                                                                                                                                                                                                                                                                                           |
|---------------|---------------------------------------------------------------------------------------------------------------------------------------------------------------------------------------------------------------------------------------------------------------------------------------------------------------------------------------|
| <ipv4-addr>   | Specifies the IPv4 address of the neighbor whose connection is to be reset, entered in the form A.B.C.D.                                                                                                                                                                                                                              |
| in            | Indicates that incoming advertised routes will be cleared.                                                                                                                                                                                                                                                                            |
| prefix-filter | Specifies that a prefix-list will be sent, by the ORF mechanism, to those neighbors with which the ORF capability has been negotiated. The neighbors will be triggered to resend updates, which match the prefix-list filter, to the local router. The local router will then perform a soft reconfiguration.                         |
| out           | Indicates that outgoing advertised routes will be cleared.                                                                                                                                                                                                                                                                            |
| soft in       | Soft inbound reset causes the neighbors to resend all their updates to the local switch, without resetting the connection or clearing the entries in the local switch. So, the local switch stores new updates, and uses them to systematically replace existing table entries. This process can use a considerable amount of memory. |
| soft out      | Soft outbound reset causes the switch to simply resend all its updates to the specified neighbor(s), without resetting the connection, or clearing table entries.                                                                                                                                                                     |
| vrf           | Applies the command to the specified VRF instance.                                                                                                                                                                                                                                                                                    |
| <vrf-name>    | The name of the VRF instance.                                                                                                                                                                                                                                                                                                         |

**Mode [BGP]** Privileged Exec

**Examples [BGP]** To clear the BGP connection to peer at IPv4 address 192.168.1.1 and clear all incoming routes, use the following command:

```
awplus# clear ip bgp 192.168.1.1 in
```

To apply the above example to clear the BGP connection to the peer at IP address 192.0.2.11 for the VRF instance blue, use the following commands:

```
awplus# clear ip bgp 192.0.2.11 vrf blue in
```

**Command changes** Version 5.4.6-2.1: VRF-lite support added.

# clear ip rip route

**Overview** Use this command to clear specific data from the RIP routing table.

**Syntax** `clear ip rip route {<ip-dest-network/prefix-length>|static|connected|rip|ospf|bgp|invalid-routes|all}`

**Syntax (VRF-lite)** `clear ip rip [vrf <vrf-name>] route {<ip-dest-network/prefix-length>|static|connected|rip|ospf|bgp|invalid-routes|all}`

| Parameter                       | Description                                                                                                                                             |
|---------------------------------|---------------------------------------------------------------------------------------------------------------------------------------------------------|
| vrf                             | Apply this command to a VRF instance.                                                                                                                   |
| <vrf-name>                      | The name of the VRF instance.                                                                                                                           |
| <ip-dest-network/prefix-length> | Removes entries which exactly match this destination address from RIP routing table. Enter the IP address and prefix length of the destination network. |
| static                          | Removes static entries from the RIP routing table.                                                                                                      |
| connected                       | Removes entries for connected routes from the RIP routing table.                                                                                        |
| rip                             | Removes only RIP routes from the RIP routing table.                                                                                                     |
| ospf                            | Removes only OSPF routes from the RIP routing table.                                                                                                    |
| bgp                             | Removes only BGP routes from the RIP routing table.                                                                                                     |
| invalid-routes                  | Removes routes with metric 16 immediately. Otherwise, these routes are not removed until RIP times out the route after 2 minutes.                       |
| all                             | Clears the entire RIP routing table.                                                                                                                    |

**Mode** Privileged Exec

**Usage** Using this command with the **all** parameter clears the RIP table of all the routes.

**Examples** To clear the route 10.0.0.0/8 from the RIP routing table, use the following command:

```
awplus# clear ip rip route 10.0.0.0/8
```

**Examples (VRF-lite)** To clear RIP routes associated with the VRF instance 'red' for OSPF routes, use the following command:

```
awplus# clear ip rip vrf red route ospf
```

To clear the route 10.0.0.0/8 from the RIP routing table for the VRF instance 'red', use the following command:

```
awplus# clear ip rip vrf red route 10.0.0.0/8
```

**Command changes** Version 5.4.6-2.1: VRF-lite support added.

# crypto key pubkey-chain knownhosts

**Overview** This command adds a public key of the specified SSH server to the known host database on your device. The SSH client on your device uses this public key to verify the remote SSH server.

The key is retrieved from the server. Before adding a key to this database, check that the key sent to you is correct.

If the server's key changes, or if your SSH client does not have the public key of the remote SSH server, then your SSH client will inform you that the public key of the server is unknown or altered.

The **no** variant of this command deletes the public key of the specified SSH server from the known host database on your device.

**Syntax** `crypto key pubkey-chain knownhosts [ip|ipv6] <hostname> [rsa|dsa|rsa1]`  
`no crypto key pubkey-chain knownhosts <1-65535>`

**Syntax (VRF-lite)** `crypto key pubkey-chain knownhosts [vrf <vrf-name>] [ip|ipv6] <hostname> [rsa|dsa|rsa1]`  
`no crypto key pubkey-chain knownhosts [vrf <vrf-name>] <1-65535>`

| Parameter  | Description                                                                                                                                |
|------------|--------------------------------------------------------------------------------------------------------------------------------------------|
| vrf        | Apply this command to the specified VRF instance.                                                                                          |
| <vrf-name> | The VRF instance name                                                                                                                      |
| ip         | Keyword used prior to specifying an IPv4 address                                                                                           |
| ipv6       | Keyword used prior to specifying an IPv6 address                                                                                           |
| <hostname> | IPv4/IPv6 address or hostname of a remote server in the format a.b.c.d for an IPv4 address, or in the format x:x::x:x for an IPv6 address. |
| rsa        | Specify the RSA public key of the server to be added to the known host database.                                                           |
| dsa        | Specify the DSA public key of the server to be added to the known host database.                                                           |
| rsa1       | Specify the SSHv1 public key of the server to be added to the know host database.                                                          |
| <1-65535>  | Specify a key identifier when removing a key using the <b>no</b> parameter.                                                                |

**Default** If no cryptography algorithm is specified, then **rsa** is used as the default cryptography algorithm.

**Mode** Privilege Exec

**Usage** This command adds a public key of the specified SSH server to the known host database on the device. The key is retrieved from the server. The remote SSH server is verified by using this public key. The user is requested to check the key is correct before adding it to the database.

If the remote server's host key is changed, or if the device does not have the public key of the remote server, then SSH clients will inform the user that the public key of the server is altered or unknown.

**Examples** To add the RSA host key of the remote SSH host IPv4 address 192.0.2.11 to the known host database, use the command:

```
awplus# crypto key pubkey-chain knownhosts 192.0.2.11
```

To delete the second entry in the known host database, use the command:

```
awplus# no crypto key pubkey-chain knownhosts 2
```

**Examples (VRF-lite)** To add the RSA host key of the remote SSH host IPv4 address 192.0.2.11 in VRF red to the known host database, use the command:

```
awplus# crypto key pubkey-chain knownhosts vrf red 192.0.2.11
```

To delete the second entry in the known host database in VRF red, use the command:

```
awplus# no crypto key pubkey-chain knownhosts vrf red 2
```

**Validation Commands** [show crypto key pubkey-chain knownhosts](#)

**Command changes** Version 5.4.6-2.1: VRF-lite support added.

# default-metric (RIP)

**Overview** Use this command to specify the metrics to be assigned to redistributed RIP routes. Use the **no** variant of this command to reset the RIP metric back to its default (1).

**Syntax** `default-metric <metric>`  
`no default-metric [<metric>]`

| Parameter | Description                                       |
|-----------|---------------------------------------------------|
| <metric>  | <1-16> Specifies the value of the default metric. |

**Default** By default, the RIP metric value is set to 1.

**Mode** RIP Router Configuration or RIP Router Address Family Configuration for a VRF instance.

**Usage** This command is used with the [redistribute \(RIP\)](#) command to make the routing protocol use the specified metric value for all redistributed routes, regardless of the original protocol that the route has been redistributed from.

**Examples** This example assigns the cost of 10 to the routes that are redistributed into RIP.

```
awplus# configure terminal
awplus(config)# router rip
awplus(config-router)# default-metric 10
awplus(config-router)# redistribute ospf
awplus(config-router)# redistribute connected
```

**Example (VRF-lite)** This example assigns the cost of 10 to the routes which are redistributed into RIP for the VRF instance blue.

```
awplus# configure terminal
awplus(config)# router rip
awplus(config-router)# address family ipv4 vrf blue
awplus(config-router-af)# default-metric 10
awplus(config-router-af)# redistribute ospf
awplus(config-router-af)# redistribute connected
```

**Related Commands** [redistribute \(RIP\)](#)

**Command changes** Version 5.4.6-2.1: VRF-lite support added.

# description (VRF)

**Overview** Use this command to add text that describes a specific VRF instance. Descriptions can be up to 80 characters long.

The **no** variant of this command removes the description of the selected VRF instance.

**Syntax** `description <descriptive-text>`  
`no description`

| Parameter                             | Description                                                      |
|---------------------------------------|------------------------------------------------------------------|
| <code>&lt;descriptive-text&gt;</code> | A string of up to 80 characters that describes the VRF instance. |

**Mode** VRF Configuration

**Example** To add the description for a VRF instance named blue, use the following commands:

```
awplus# config terminal
awplus(config)# ip vrf blue
awplus(config-vrf)# description the text description of vrf
blue
```

**Related Commands** [show ip vrf](#)

**Command changes** Version 5.4.6-2.1: VRF-lite support added.

# distance (RIP)

**Overview** This command sets the administrative distance for RIP routes. Your device uses this value to select between two or more routes to the same destination obtained from two different routing protocols. The route with the smallest administrative distance value is added to the Forwarding Information Base (FIB). For more information, see the [Route Selection Feature Overview and Configuration Guide](#).

The **no** variant of this command sets the administrative distance for the RIP route to the default of 120.

**Syntax** `distance <1-255> [<ip-addr/prefix-length>]`  
`no distance [<1-255>] [<ip-addr/prefix-length>]`

| Parameter               | Description                                                                                     |
|-------------------------|-------------------------------------------------------------------------------------------------|
| <1-255>                 | The administrative distance value you are setting for this RIP route.                           |
| <ip-addr/prefix-length> | The network IP address and prefix-length that you are changing the administrative distance for. |

**Mode** RIP Router Configuration or RIP Router Address Family Configuration for a VRF instance.

**Examples** To set the administrative distance to 8 for the RIP routes within the 10.0.0.0/8 network, use the commands:

```
awplus# configure terminal
awplus(config)# router rip
awplus(config-router)# distance 8 10.0.0.0/8
```

To set the administrative distance to the default of 120 for the RIP routes within the 10.0.0.0/8 network, use the commands:

```
awplus# configure terminal
awplus(config)# router rip
awplus(config-router)# no distance 8 10.0.0.0/8
```

**Example (VRF-lite)** This example assigns a cost of 10 to the routes for the VRF instance blue, when redistributed into RIP.

```
awplus# configure terminal
awplus(config)# router rip
awplus(config-router)# address family ipv4 blue
awplus(config-router-af)# distance 10
```

**Command changes** Version 5.4.6-2.1: VRF-lite support added.



# distribute-list (RIP)

**Overview** Use this command to filter incoming or outgoing route updates using the prefix-list.

When running VRF-lite, this command can be applied to a specific VRF instance.

Use the **no** variant of this command to disable this feature.

**Syntax** `distribute-list prefix <prefix-list> {in|out} [<interface>]`  
`no distribute-list prefix <prefix-list> {in|out} [<interface>]`

| Parameter     | Description                                                                      |
|---------------|----------------------------------------------------------------------------------|
| prefix        | Filter prefixes in routing updates.                                              |
| <prefix-list> | Specifies the name of the IPv4 prefix-list to use.                               |
| in            | Filter incoming routing updates.                                                 |
| out           | Filter outgoing routing updates.                                                 |
| <interface>   | The interface on which distribute-list applies. For instance: <code>vlan2</code> |

**Default** Disabled

**Mode** RIP Router Configuration or RIP Router Address Family Configuration for a VRF instance.

**Usage** Filter out incoming or outgoing route updates using prefix-list. If you do not specify the name of the interface, the filter will be applied to all interfaces.

**Examples** In this example the following commands are used to apply a prefix list called myfilter to filter incoming routing updates in `vlan2`

```
awplus# configure terminal
awplus(config)# router rip
awplus(config-router)# distribute-list prefix myfilter in vlan2
```

**Example (VRF-lite)** This example applies the commands of the previous example, but to a specific VRF named blue:

```
awplus# configure terminal
awplus(config)# router rip
awplus(config-router)# address-family ipv4 vrf blue
awplus(config-router-af)# distribute-list prefix myfilter in
vlan2
```

**Command changes** Version 5.4.6-2.1: VRF-lite support added.

# export map

**Overview** This command associates a route map with a specific VRF instance. It provides a finer control over the routes that are exported out of a VRF instance by the **route-target** command. Note, however, that this command does not replace the need for a route-target export in the VRF configuration.

The **no** variant of this command disables the capability to export route map entries for a specified VRF instance.

**Syntax** `export map <route-map>`  
`no export map`

| Parameter                      | Description         |
|--------------------------------|---------------------|
| <code>&lt;route-map&gt;</code> | The route-map name. |

**Mode** VRF Configuration

**Usage** Use this command to export route-map entries in VRF configuration mode.

**Example** To export the route map named routemap2 for the VRF instance named blue, use the following commands:

```
awplus# config terminal
awplus(config)# ip vrf blue
awplus(config-vrf)# export map routemap2
```

**Related Commands** [import map](#)

**Command changes** Version 5.4.6-2.1: VRF-lite support added.

# fullupdate (RIP)

**Overview** Use this command to specify which routes RIP should advertise when performing a triggered update. By default, when a triggered update is sent, RIP will only advertise those routes that have changed since the last update. When **fullupdate** is configured, the device advertises the full RIP route table in outgoing triggered updates, including routes that have not changed. This enables faster convergence times, or allows inter-operation with legacy network equipment, but at the expense of larger update messages.

Use the **no** variant of this command to disable this feature.

**Syntax** fullupdate  
no fullupdate

**Default** By default this feature is disabled.

**Mode** RIP Router Configuration or RIP Router Address Family Configuration for a VRF instance.

**Usage (VRF-lite)** If VRF-lite is configured, you can apply this command for either the global routing environment, or to a specific VRF instance.

**Example** To enable the fullupdate (RIP) function, use the commands:

```
awplus# configure terminal
awplus(config)# router rip
awplus(config-router)# fullupdate
```

**Example (VRF-lite)** To enable the full update (RIP) function on the VRF instance named 'blue', use the commands:

```
awplus# configure terminal
awplus(config)# router rip
awplus(config-router)# address-family ipv4 vrf blue
awplus(config-router-af)# fullupdate
```

**Command changes** Version 5.4.6-2.1: VRF-lite support added.

# import map

**Overview** The import map command associates a route map with a specific VRF instance. The import map command does not replace the need for a route-target import in the VRF configuration. It provides a finer control over the routes imported into a VRF instance by the **route-target** command.

The **no** variant of this command disables the capability to import route map entries for a specified VRF instance.

**Syntax** `import map <route-map>`  
`no import map`

| Parameter                      | Description         |
|--------------------------------|---------------------|
| <code>&lt;route-map&gt;</code> | The route-map name. |

**Mode** VRF Configuration

**Usage** Use this command to import route-map entries into the specified VRF instance.

**Example** To import the route map named `routemap2` for the VRF instance named `blue`, use the following commands:

```
awplus# config terminal
awplus(config)# ip vrf blue
awplus(config-vrf)# import map routemap2
```

**Related Commands** [export map](#)

**Command changes** Version 5.4.6-2.1: VRF-lite support added.

# ip route static inter-vrf

**Overview** Applying this command enables static inter-VRF routing. Note that static inter-VRF routing must be enabled before you can use the **ip route** command to create a static inter-VRF route.

The **no** variant of this command disables static inter-VRF routing.

**Syntax** `ip route static inter-vrf`  
`no ip route static inter-vrf`

**Mode** VRF Configuration

**Default** Static inter-VRF routing is enabled.

**Example** To enable static inter-VRF routing, use the following commands:

```
awplus# config terminal
awplus(config)# ip route static inter-vrf
```

**Related Commands** [ip route](#)  
[show ip route](#)

**Command changes** Version 5.4.6-2.1: VRF-lite support added.

# ip route

**Overview** This command adds a static route to the Routing Information Base (RIB). If this route is the best route for the destination, then your device adds it to the Forwarding Information Base (FIB). Your device uses the FIB to advertise routes to neighbors and forward packets.

When using VRF (Virtual Routing and Forwarding), you can use this command to configure a static inter-VRF route to a destination network that is reachable by a remote gateway located in a different VRF instance. Note that to apply the command in this way, the `ip route static inter-vrf` command must be enabled (its default condition). For more information about VRF, see the [VRF Feature Overview and Configuration Guide](#) and the [VRF-lite Commands](#) chapter.

The **no** variant of this command removes the static route from the RIB and FIB.

**Syntax** `ip route <subnet&mask> {<gateway-ip>|<interface>} [<distance>]`  
`no ip route <subnet&mask> {<gateway-ip>|<interface>} [<distance>]`

**Syntax (VRF-lite)** `ip route [vrf <vrf-name>] <subnet&mask> [<gateway-ip>] [<interface>] [<distance>]`  
`no ip route [vrf <vrf-name>] <subnet&mask> [<gateway-ip>] [<interface>] [<distance>]`

| Parameter                            | Description                                                                                                                                                                                                                                                                                                                                                                                                                                                                                                                                           |
|--------------------------------------|-------------------------------------------------------------------------------------------------------------------------------------------------------------------------------------------------------------------------------------------------------------------------------------------------------------------------------------------------------------------------------------------------------------------------------------------------------------------------------------------------------------------------------------------------------|
| <code>&lt;subnet&amp;mask&gt;</code> | The IPv4 address of the destination subnet defined using either a prefix length or a separate mask specified in one of the following formats: <ul style="list-style-type: none"> <li>The IPv4 subnet address in dotted decimal notation followed by the subnet mask, also in dotted decimal notation.</li> <li>The IPv4 subnet address in dotted decimal notation, followed by a forward slash, then the prefix length</li> </ul>                                                                                                                     |
| <code>&lt;gateway-ip&gt;</code>      | The IPv4 address of the gateway device.                                                                                                                                                                                                                                                                                                                                                                                                                                                                                                               |
| <code>&lt;interface&gt;</code>       | The interface that connects your device to the network. Enter the name of the VLAN or its VID. You can also enter 'null' as an interface. Specify a 'null' interface to add a null or blackhole route to the switch.<br>The gateway IP address or the interface is required if VRF-lite is not configured.<br>If VRF-lite is configured: When adding a static intra-VRF route, you must specify either the gateway IP address or the interface. When adding a static inter-VRF route, you must specify both the gateway IP address and the interface. |
| <code>&lt;distance&gt;</code>        | The administrative distance for the static route in the range <1-255>. Static routes by default have an administrative distance of 1.                                                                                                                                                                                                                                                                                                                                                                                                                 |

| Parameter  | Description                                                         |
|------------|---------------------------------------------------------------------|
| vrf        | Applies the command to the specified VRF instance.                  |
| <vrf-name> | The name of the VRF instance to enter IPv4 Address-Family mode for. |

**Mode** Global Configuration

**Default** The default administrative distance for a static route is 1 for priority over non-static routes.

**Usage** Administrative distance can be modified so that static routes do not take priority over other routes.

Specify a 'Null' interface to add a null or blackhole route to the switch. A null or blackhole route is a routing table entry that does not forward packets, so any packets sent to it are dropped.

**Examples** To add the destination 192.168.3.0 with the mask 255.255.255.0 as a static route available through the device at "10.10.0.2" with the default administrative distance, use the commands:

```
awplus# configure terminal
awplus(config)# ip route 192.168.3.0 255.255.255.0 10.10.0.2
```

To remove the destination 192.168.3.0 with the mask 255.255.255.0 as a static route available through the device at "10.10.0.2" with the default administrative distance, use the commands:

```
awplus# configure terminal
awplus(config)# no ip route 192.168.3.0 255.255.255.0 10.10.0.2
```

To specify a null or blackhole route 192.168.4.0/24, so packets forwarded to this route are dropped, use the commands:

```
awplus# configure terminal
awplus(config)# ip route 192.168.4.0/24 null
```

To add the destination 192.168.3.0 with the mask 255.255.255.0 as a static route available through the device at "10.10.0.2" with an administrative distance of 128, use the commands:

```
awplus# configure terminal
awplus(config)# ip route 192.168.3.0 255.255.255.0 10.10.0.2
128
```

**Examples (VRF-lite)** To create a static route from source VRF instance red, to the subnet 192.168.50.0/24 with a next hop of 192.168.20.6, use the following commands for static intra-VRF routing configuration:

```
awplus# configure terminal
awplus(config)# ip route vrf red 192.168.50.0/24 192.168.20.6
```

To remove a static route from source VRF red, to the subnet 192.168.50.0/24 with a next hop of 192.168.20.6, use the following commands for static intra-VRF routing configuration:

```
awplus# configure terminal
awplus(config)# no ip route vrf red 192.168.50.0/24
192.168.20.6
```

To create a static route from source VRF red, to the subnet 192.168.50.0/24 with a next hop of 192.168.20.6 via vlan10, use the following commands for static inter-VRF routing configuration:

```
awplus# configure terminal
awplus(config)# ip route vrf red 192.168.50.0/24 192.168.20.6
vlan10
```

**Related  
Commands** [show ip route](#)  
[show ip route database](#)

**Command  
changes** Version 5.4.6-2.1: VRF-lite support added.



## ip vrf

**Overview** This command creates a VRF instance and specifies its unique name. You can also optionally specify a VRF ID. If you do not specify the VRF ID, a unique ID will automatically be created and assigned to the VRF instance.

The **no** variant of this command removes a selected VRF instance. All interfaces previously belonging to the removed instance are then returned to the global routing and forwarding environment.

**Syntax** `ip vrf <vrf-name> [<vrf-inst-id>]`  
`no ip vrf <vrf-name> [<vrf-inst-id>]`

| Parameter                        | Description                                               |
|----------------------------------|-----------------------------------------------------------|
| <code>&lt;vrf-name&gt;</code>    | The name of the VRF instance.                             |
| <code>&lt;vrf-inst-id&gt;</code> | The ID of the VRF instance, a number in the range 1 to 8. |

**Mode** Global Configuration

**Default** Static inter-VRF routing is enabled.

**Example** To create a VRF instance named `vrf blue` and assign it the ID number `2`, use the following commands:

```
awplus# config terminal
awplus(config)# ip vrf blue 2
```

**Command changes** Version 5.4.6-2.1: VRF-lite support added.

# ip vrf forwarding

**Overview** This command associates a VRF instance with an interface.  
The **no** variant of this command disassociates the VRF instance from its interface.

**Syntax** `ip vrf forwarding <vrf-name>`  
`no ip vrf <vrf-name>`

| Parameter                     | Description                   |
|-------------------------------|-------------------------------|
| <code>&lt;vrf-name&gt;</code> | The name of the VRF instance. |

**Mode** Interface Configuration

**Default** The default for an interface is the global routing table.

**Examples** For LAN interfaces, to associate the VRF instance named `blue` with the VLAN interface `vlan-admin`, use the following commands:

```
awplus# config terminal
awplus(config)# interface vlan-admin
awplus(config-if)# ip vrf forwarding blue
```

**Related Commands** `show ip vrf`  
`show ip vrf detail`

**Command changes** Version 5.4.6-2.1: VRF-lite support added.

# max-fib-routes (VRF)

**Overview** This command now enables you to control the maximum number of FIB routes configured for a VRF instance. It operates by providing parameters that enable you to configure preset maximums and warning message thresholds.

**NOTE:** This command applies to a user-defined VRF instance; to set the max-fib-routes for the Global VRF instance use the [max-fib-routes](#) command. For static routes use the [max-static-routes](#) command for the Global VRF instance and the [max-static-routes \(VRF\)](#) command for a user-defined VRF instance.

Use the **no** variant of this command to set the maximum number of FIB routes to the default of 4294967294 FIB routes.

**Syntax** `max-fib-routes <1-4294967294> [<1-100>|warning-only]`  
`no max-fib-routes`

| Parameter                         | Description                                                                                                                                                                                                                                                                                                                                  |
|-----------------------------------|----------------------------------------------------------------------------------------------------------------------------------------------------------------------------------------------------------------------------------------------------------------------------------------------------------------------------------------------|
| <code>max-fib-routes</code>       | The maximum number of routes that can be stored in Forwarding Information dataBase for either the Global VRF or a VRF instance.                                                                                                                                                                                                              |
| <code>&lt;1-4294967294&gt;</code> | The allowable configurable range for setting the maximum number of FIB-routes.                                                                                                                                                                                                                                                               |
| <code>&lt;1-100&gt;</code>        | This parameter enables you to optionally apply a percentage value. This percentage will be based on the maximum number of FIB routes you have specified. This will cause a warning message to appear when your routes reach your specified percentage value. Routes can continue to be added until your configured maximum value is reached. |
| <code>warning-only</code>         | This parameter enables you to optionally apply a warning message. If you set this option a warning message will appear if your maximum configured value configured. Routes can continue to be added until your switch reaches either the maximum capacity value of 4294967294, or a practical system limit.                                  |

**Mode** VRF Configuration

**Default** Sets the maximum number of dynamic routes to 4294967294 and no warning threshold.

**Examples** To set the maximum number of dynamic routes to 2000 and warning threshold of 75% on VRF instance blue, use the commands:

```
awplus# config terminal
awplus(config)# ip vrf blue
awplus(config-vrf)# max-fib-routes 2000 75
```

**Related  
Commands** [max-fib-routes](#)  
[show ip route](#)

**Command  
changes** Version 5.4.6-2.1: VRF-lite support added.

# max-static-routes (VRF)

**Overview** Use this command to set the maximum number of static routes (excluding FIB—Forwarding Information Base routes) for VRF instances. A limit of 1000 static routes can be assigned to each individual VRF instance. For example you can assign 800 static routes to the Global VRF, then also assign 600 static routes to VRF instance Blue, and a further 600 routes to VRF instance Green.

**NOTE:** This command applies to a user-defined VRF instance; to set the max-static-routes for the Global VRF instance use the [max-static-routes](#) command. For FIB routes use the [max-fib-routes](#) command for the Global VRF instance and the [max-fib-routes \(VRF\)](#) command for a user-defined VRF instance.

Use the **no** variant of this command to reset the maximum number of static routes to the default value of 1000.

**Syntax** max-static-routes <1-1000>  
no max-static-routes

**Default** The default number of static routes is the maximum number of static routes (1000).

**Mode** VRF Configuration

**Example** To assign 200 static routes to VRF instance Blue, use the following commands:

```
awplus# configure terminal
awplus(config)# ip vrf blue
awplus(config-vrf)# max-static-routes 200
```

**NOTE:** Static routes are applied before adding routes to the RIB (Routing Information Base). Therefore, rejected static routes will not appear in the running config.

**Related Commands** [max-fib-routes \(VRF\)](#)

**Command changes** Version 5.4.6-2.1: VRF-lite support added.

# neighbor next-hop-self

**Overview** Use this command to configure the BGP or BGP4+ router as the next hop for a BGP or BGP4+ speaking neighbor or peer group.

Use the **no** variant of this command to disable this feature.

**Syntax** `neighbor <neighborid> next-hop-self`  
`no neighbor <neighborid> next-hop-self`

| Parameter    | Description                                                                                                                                                                                                                                                                                                                |
|--------------|----------------------------------------------------------------------------------------------------------------------------------------------------------------------------------------------------------------------------------------------------------------------------------------------------------------------------|
| <neighborid> | { <ip-address>   <ipv6-addr>   <peer-group> }                                                                                                                                                                                                                                                                              |
| <ip-address> | Specify the address of an IPv4 BGP neighbor, in dotted decimal notation A.B.C.D.                                                                                                                                                                                                                                           |
| <ipv6-addr>  | Specify the address of an IPv6 BGP4+ neighbor, entered in hexadecimal in the format X:X::X:X.                                                                                                                                                                                                                              |
| <peer-group> | Enter the name of an existing peer-group. For information on how to create peer groups, refer to the <a href="#">neighbor peer-group (add a neighbor)</a> command, and <a href="#">neighbor route-map</a> command. When this parameter is used with this command, the command applies on all peers in the specified group. |

**Mode [BGP]** Router Configuration or IPv4 Address Family Configuration

**Mode [BGP4+]** IPv6 Address Family Configuration

**Usage** This command allows a BGP or BGP4+ router to change the next hop information that is sent to the iBGP peer. The next hop information is set to the IP address of the interface used to communicate with the neighbor.

This command can be run for a specific VRF instance.

**Examples [BGP]**

```
awplus# configure terminal
awplus(config)# router bgp 10
awplus(config-router)# neighbor 10.10.0.72 next-hop-self
awplus# configure terminal
awplus(config)# router bgp 10
awplus(config-router)# no neighbor 10.10.0.72 next-hop-self
awplus# configure terminal
awplus(config)# router bgp 10
awplus(config-router)# address-family ipv4
awplus(config-router)# neighbor 10.10.0.72 next-hop-self
awplus# configure terminal
awplus(config)# router bgp 10
awplus(config-router)# address-family ipv4
awplus(config-router)# no neighbor 10.10.0.72 next-hop-self
awplus# configure terminal
awplus(config)# router bgp 10
awplus(config-router)# neighbor group1 peer-group
awplus(config-router)# neighbor 10.10.10.72 remote-as 10
awplus(config-router)# neighbor 10.10.10.72 peer-group group1
awplus(config-router)# neighbor group1 next-hop-self
awplus# configure terminal
awplus(config)# router bgp 10
awplus(config-router)# no neighbor group1 next-hop-self
```

**Examples**  
**[BGP4+]**

```
awplus# configure terminal
awplus(config)# router bgp 10
awplus(config-router)# address-family ipv6
awplus(config-router-af)# neighbor 2001:0db8:010d::1
next-hop-self

awplus# configure terminal
awplus(config)# router bgp 10
awplus(config-router)# address-family ipv6
awplus(config-router-af)# no neighbor 2001:0db8:010d::1
next-hop-self

awplus# configure terminal
awplus(config)# router bgp 10
awplus(config-router)# neighbor group1 peer-group
awplus(config-router)# neighbor 2001:0db8:010d::1 remote-as 10
awplus(config-router)# address-family ipv6
awplus(config-router-af)# neighbor 2001:0db8:010d::1
peer-group group1
awplus(config-router-af)# neighbor group1 next-hop-self

awplus# configure terminal
awplus(config)# router bgp 10
awplus(config-router)# address-family ipv6
awplus(config-router-af)# no neighbor group1 next-hop-self
```

**Related**  
**Commands**

[neighbor peer-group \(add a neighbor\)](#)  
[neighbor route-map](#)



# neighbor remote-as

**Overview** Use this command to configure an internal or external BGP or BGP4+ (iBGP or eBGP) peering relationship with another router.

Use the **no** variant of this command to remove a previously configured BGP or BGP4+ peering relationship.

**Syntax** `neighbor <neighborid> remote-as <as-number>`  
`no neighbor <neighborid> remote-as <as-number>`

**Syntax (VRF- lite)** `neighbor <neighborid> remote-as <as-number> [global|vrf <vrf-name>]`  
`no neighbor <neighborid> remote-as <as-number>`

| Parameter    | Description                                                                                                                                                                                                                                                                                                                |
|--------------|----------------------------------------------------------------------------------------------------------------------------------------------------------------------------------------------------------------------------------------------------------------------------------------------------------------------------|
| <neighborid> | {<ip-address>   ipv6-addr   <peer-group>}                                                                                                                                                                                                                                                                                  |
| <ip-address> | Specify the address of an IPv4 BGP neighbor, in dotted decimal notation A.B.C.D.                                                                                                                                                                                                                                           |
| <ipv6-addr>  | Specify the address of an IPv6 BGP4+ neighbor, entered in hexadecimal in the format X:X::X:X.                                                                                                                                                                                                                              |
| <peer-group> | Enter the name of an existing peer-group. For information on how to create peer groups, refer to the <a href="#">neighbor peer-group (add a neighbor)</a> command, and <a href="#">neighbor route-map</a> command. When this parameter is used with this command, the command applies on all peers in the specified group. |
| <as-number>  | <1-4294967295> Neighbor's Autonomous System (AS) number.                                                                                                                                                                                                                                                                   |
| global       | Specify that the remote neighbor exists locally within the device, in the global routing domain                                                                                                                                                                                                                            |
| vrf          | Specify that the remote neighbor exists locally within the device, in the specified VRF instance.                                                                                                                                                                                                                          |
| <vrf-name>   | The name of the VRF instance.                                                                                                                                                                                                                                                                                              |

**Mode [BGP]** Router Configuration or IPv4 Address Family Configuration

**Mode [BGP4+]** Router Configuration

**Usage** This command is used to configure iBGP and eBGP peering relationships with other BGP or BGP4+ neighbors. A peer-group support of this command is configured only after creating a specific peer-group. Use the **no** variant of this command to remove a previously configured BGP peering relationship.

The **vrf** and **global** parameters are used to create internal 'loopback' BGP connections within the device between two VRF instances. This is used to leak BGP routes between a named VRF instance and the global routing instance. This requires BGP neighbors to be configured in both the global routing instance and in the named VRF instance.

**Examples [BGP]** To configure a BGP peering relationship from the neighbor with the IPv4 address 10.10.0.73 with another router:

```
awplus# configure terminal
awplus(config)# router bgp 10
awplus(config-router)# neighbor 10.10.0.73 remote-as 10
```

To remove a configured BGP peering relationship from the neighbor with the IPv4 address 10.10.0.73 from another router:

```
awplus# configure terminal
awplus(config)# router bgp 10
awplus(config-router)# no neighbor 10.10.0.73 remote-as 10
```

To configure a BGP peering relationship from the neighbor with the peer group named group1 with another router:

```
awplus# configure terminal
awplus(config)# router bgp 10
awplus(config-router)# neighbor group1 peer-group
awplus(config-router)# neighbor 10.10.10.1 remote-as 10
awplus(config-router)# neighbor 10.10.10.1 peer-group group1
awplus(config-router)# neighbor group1 remote-as 10
```

To remove a configured BGP peering relationship from the neighbor with the peer group named group1 with another router:

```
awplus# configure terminal
awplus(config)# router bgp 10
awplus(config-router)# no neighbor group1 remote-as 10
```

**Examples [BGP4+]** To configure a BGP4+ peering relationship with another router:

```
awplus# configure terminal
awplus(config)# router bgp 11
awplus(config-router)# neighbor 2001:0db8:010d::1 remote-as 345
```

To remove a configured BGP4+ peering relationship from another router:

```
awplus# configure terminal
awplus(config)# router bgp 11
awplus(config-router)# no neighbor 2001:0db8:010d::1 remote-as 345
```

To configure a BGP4+ peering relationship from the neighbor with the peer group named group1 with another router:

```
awplus# configure terminal
awplus(config)# router bgp 10
awplus(config-router)# neighbor group1 peer-group
awplus(config-router)# neighbor 2001:0db8:010d::1 remote-as 10
awplus(config-router)# address-family ipv6
awplus(config-router-af)# neighbor 2001:0db8:010d::1
peer-group group1
awplus(config-router-af)# exit
awplus(config-router)# neighbor group1 remote-as 10
```

To remove a configured BGP4+ peering relationship from the neighbor with the peer group named group1 with another router:

```
awplus# configure terminal
awplus(config)# router bgp 10
awplus(config-router)# no neighbor group1 remote-as 10
```

**Command  
changes**

Version 5.4.6-2.1: VRF-lite support added.

# neighbor password

**Overview** Use this command to enable MD5 authentication on a TCP connection between BGP and BGP4+ neighbors. No authentication is applied by default. To setup authentication for the session, you must first apply authentication on each connected peer for the session.

Use the **no** variant of this command to disable this function.

**Syntax [BGP]** `neighbor {<ip-address>|<peer-group-name>} password <password>`  
`no neighbor {<ip-address>|<peer-group-name>} password`  
`[<password>]`

**Syntax [BGP4+]** `neighbor {<ipv6-addr>|<peer-group-name>} password <password>`  
`no neighbor {<ipv6-addr>|<peer-group-name>} password`  
`[<password>]`

| Parameter                            | Description                                                                                                                             |
|--------------------------------------|-----------------------------------------------------------------------------------------------------------------------------------------|
| <code>&lt;ip-address&gt;</code>      | Specifies the IP address of the BGP neighbor, in A.B.C.D format.                                                                        |
| <code>&lt;ipv6-addr&gt;</code>       | Specifies the IPv6 address of the BGP4+ neighbor, entered in hexadecimal in the format X:X::X:X.                                        |
| <code>&lt;peer-group-name&gt;</code> | Name of an existing peer-group. When this parameter is used with this command, the command applies on all peers in the specified group. |
| <code>&lt;password&gt;</code>        | An alphanumeric string of characters to be used as password.                                                                            |

**Default** No authentication is applied by default.

**Mode [BGP]** Router Configuration or IPv4 Address Family Configuration

**Mode [BGP4+]** Router Configuration

**Usage** When using the `<peer-group-name>` parameter with this command (to apply this command to all peers in the group), see the related commands [neighbor peer-group \(add a neighbor\)](#) and [neighbor route-map](#) for information about how to create peer groups first.

**Examples [BGP]** This example specifies the encryption type and the password 'manager' for the neighbor 10.10.10.1:

```
awplus# configure terminal
awplus(config)# router bgp 10
awplus(config-router)# neighbor 10.10.10.1 password manager
```

This example removes the password set for the neighbor 10.10.10.1:

```
awplus# configure terminal
awplus(config)# router bgp 10
awplus(config-router)# no neighbor 10.10.10.1 password
```

This example specifies the encryption type and the password 'manager' for the neighbor peer group named 'group1':

```
awplus# configure terminal
awplus(config)# router bgp 10
awplus(config-router)# neighbor group1 peer-group
awplus(config-router)# neighbor 10.10.10.1 remote-as 10
awplus(config-router)# neighbor 10.10.10.1 peer-group group1
awplus(config-router)# neighbor group1 password manager
```

This example removes the password set for the neighbor peer group named group1:

```
awplus# configure terminal
awplus(config)# router bgp 10
awplus(config-router)# no neighbor group1 password
```

**Examples  
(VRF-lite)**

This example specifies the password ('manager') for the neighbor peer group named 'group1' for an IPv4 address-family VRF instance name 'red', and router bgp 10:

```
awplus# configure terminal
awplus(config)# router bgp 10
awplus(config-router)# address-family ipv4 vrf red
awplus(config-router-af)# neighbor 10.10.10.1 password manager
```

This example removes the password ('manager') for the neighbor peer group named 'group1' for an IPv4 address-family, VRF instance name 'red', and router bgp 10:

```
awplus# configure terminal
awplus(config)# router bgp 10
awplus(config-router)# address-family ipv4 vrf red
awplus(config-router-af)# no neighbor 10.10.10.1 password
manager
```

This example specifies the password ('manager') for the neighbor peer group named 'group1' for an IPv4 address-family, VRF instance name 'red', and router bgp 10:

```
awplus# configure terminal
awplus(config)# router bgp 10
awplus(config-router)# neighbor group1 peer-group
awplus(config-router)# neighbor 10.10.10.1 remote-as 10
awplus(config-router)# neighbor 10.10.10.1 peer-group group1
awplus(config-router)# address-family ipv4 vrf red
awplus(config-router-af)# neighbor group1 password manager
```

**Examples [BGP4+]** This example specifies the encryption type and the password 'manager' for the neighbor 2001:0db8:010d::1:

```
awplus# configure terminal
awplus(config)# router bgp 10
awplus(config-router)# neighbor password manager
2001:0db8:010d::1
```

This example removes the password set for the neighbor 2001:0db8:010d::1:

```
awplus# configure terminal
awplus(config)# router bgp 10
awplus(config-router)# no neighbor password 2001:0db8:010d::1
```

This example specifies the encryption type and the password 'manager' for the neighbor peer group named group1:

```
awplus# configure terminal
awplus(config)# router bgp 10
awplus(config-router)# neighbor group1 peer-group
awplus(config-router)# neighbor remote-as 102001:0db8:010d::1
awplus(config-router)# address-family ipv6
awplus(config-router-af)# neighbor peer-group group1
2001:0db8:010d::1
awplus(config-router-af)# exit
awplus(config-router)# neighbor group1 password manager
```

This example removes the password set for the neighbor peer group named 'group1':

```
awplus# configure terminal
awplus(config)# router bgp 10
awplus(config-router)# no neighbor group1 password
```

**Related Commands** [neighbor peer-group \(add a neighbor\)](#)  
[neighbor route-map](#)

**Command changes** Version 5.4.6-2.1: VRF-lite support added.

# network (RIP)

**Overview** Use this command to activate the transmission of RIP routing information on the defined network.

Use the **no** variant of this command to remove the specified network or VLAN as one that runs RIP.

**Syntax** `network {<network-address>[/<subnet-mask>] | <vlan-name>}`  
`no network {<network-address>[/<subnet-mask>] | <vlan-name>}`

| Parameter                                                                   | Description                                                                                                                                                                                                                                                                                                                                   |
|-----------------------------------------------------------------------------|-----------------------------------------------------------------------------------------------------------------------------------------------------------------------------------------------------------------------------------------------------------------------------------------------------------------------------------------------|
| <code>&lt;network-address&gt;</code><br><code>[/&lt;subnet-mask&gt;]</code> | Specifies the network address to run RIP. Entering a subnet mask (or prefix length) for the network address is optional. Where no mask is entered, the device will attempt to apply a mask that is appropriate to the class (A, B, or C) of the address entered, e.g. an IP address of 10.0.0.0 will have a prefix length of 8 applied to it. |
| <code>&lt;vlan-name&gt;</code>                                              | Specify a VLAN name with up to 32 alphanumeric characters to run RIP.                                                                                                                                                                                                                                                                         |

**Default** Disabled

**Mode** RIP Router Configuration or RIP Router Address Family Configuration for a VRF instance.

**Usage** Use this command to specify networks, or VLANs, to which routing updates will be sent and received. The connected routes corresponding to the specified network, or VLANs, will be automatically advertised in RIP updates. RIP updates will be sent and received within the specified network or VLAN.

When running VRF-lite, this command can be applied to a VRF instance.

**Example** Use the following commands to activate RIP routing updates on network 172.16.20.0/24:

```
awplus# configure terminal
awplus(config)# router rip
awplus(config-router)# network 172.16.20.0/24
```

**Example (VRF-lite)** To activate RIP routing updates on vlan3 for VRF instance 'blue'.

```
awplus# configure terminal
awplus(config)# router rip
awplus(config-router)# address-family ipv4 vrf blue
awplus(config-router-af)# network vlan3
```



**Related  
Commands** show ip rip  
show running-config  
clear ip rip route

**Command  
changes** Version 5.4.6-2.1: VRF-lite support added.

# passive-interface (RIP)

**Overview** Use this command to block RIP broadcasts on the interface.  
Use the **no** variant of this command to disable this function.

**Syntax** `passive-interface <interface>`  
`no passive-interface <interface>`

| Parameter                      | Description                   |
|--------------------------------|-------------------------------|
| <code>&lt;interface&gt;</code> | Specifies the interface name. |

**Default** Disabled

**Mode** RIP Router Configuration or RIP Router Address Family Configuration for a VRF instance.

**Example** Use the following commands to block RIP broadcasts on vlan20:

```
awplus# configure terminal
awplus(config)# router rip
awplus(config-router)# passive-interface vlan20
```

**Example (VRF-lite)** To apply this above example to a specific VRF instance named 'green', use the following commands:

```
awplus# configure terminal
awplus(config)# router rip
awplus(config-router)# address-family ipv4 vrf green
awplus(config-router-af)# passive-interface vlan20
```

**Related Commands** [show ip rip](#)

**Command changes** Version 5.4.6-2.1: VRF-lite support added.

# ping

**Overview** This command sends a query to another IPv4 host (send Echo Request messages).

**Syntax** ping [ip] <host> [broadcast] [df-bit {yes|no}] [interval <0-128>] [pattern <hex-data-pattern>] [repeat {<1-2147483647>|continuous}] [size <36-18024>] [source <ip-addr>] [timeout <1-65535>] [tos <0-255>]

**Syntax (VRF-lite)** ping [vrf <vrf-name>] [ip] <host> [broadcast] [df-bit {yes|no}] [interval <0-128>] [pattern <hex-data-pattern>] [repeat {<1-2147483647>|continuous}] [size <36-18024>] [source <ip-addr>] [timeout <1-65535>] [tos <0-255>]

| Parameter                  | Description                                                                                                                                                                                                          |
|----------------------------|----------------------------------------------------------------------------------------------------------------------------------------------------------------------------------------------------------------------|
| <host>                     | The destination IP address or hostname.                                                                                                                                                                              |
| broadcast                  | Allow pinging of a broadcast address.                                                                                                                                                                                |
| df-bit                     | Enable or disable the do-not-fragment bit in the IP header.                                                                                                                                                          |
| interval <0-128>           | Specify the time interval in seconds between sending ping packets. The default is 1. You can use decimal places to specify fractions of a second. For example, to ping every millisecond, set the interval to 0.001. |
| pattern <hex-data-pattern> | Specify the hex data pattern.                                                                                                                                                                                        |
| repeat                     | Specify the number of ping packets to send.                                                                                                                                                                          |
| <1-2147483647>             | Specify repeat count. The default is 5.                                                                                                                                                                              |
| continuous                 | Continuous ping                                                                                                                                                                                                      |
| size <36-18024>            | The number of data bytes to send, excluding the 8 byte ICMP header. The default is 56 (64 ICMP data bytes).                                                                                                          |
| source <ip-addr>           | The IP address of a configured IP interface to use as the source in the IP header of the ping packet.                                                                                                                |
| timeout <1-65535>          | The time in seconds to wait for echo replies if the ARP entry is present, before reporting that no reply was received. If no ARP entry is present, it does not wait.                                                 |
| tos <0-255>                | The value of the type of service in the IP header.                                                                                                                                                                   |
| vrf                        | Apply the command to the specified VRF instance.                                                                                                                                                                     |
| <vrf-name>                 | The name of the VRF instance.                                                                                                                                                                                        |

**Mode** User Exec and Privileged Exec

**Example** To ping the IP address 10.10.0.5 use the following command:

```
awplus# ping 10.10.0.5
```

**Example (VRF-lite)** To ping the IP address 10.10.0.5 from VRF instance 'red', use the following command:

```
awplus# ping vrf red 10.10.0.5
```

**NOTE:** *Unless a cross-domain static or leaked route exists to the destination IP address, you must run this command from within the same routing domain as the address being pinged.*

**Command changes** Version 5.4.6-2.1: VRF-lite support added.

# rd (route distinguisher)

**Overview** This command creates a Route Distinguisher (RD). The RD forms part of the route table creation process for a VRF instance and is implemented only when using BGP routing.

**Syntax** `rd {<ASN:n>|<ip-address:n>}`

**CAUTION:** This command does not have a “no” variant. To remove the RD requires deleting the VRF instance to which it is assigned. Therefore, it is important that you carefully enter the correct value for the RD.

| Parameter      | Description                                                                                                                                                                                                            |
|----------------|------------------------------------------------------------------------------------------------------------------------------------------------------------------------------------------------------------------------|
| <ASN:n>        | The RD reference number. This is based on the formal RD format structure of ASN number:Ref number.<br>The ASN value can be any number between 1 and 4294967295, and the value n can be any number between 1 and 65535. |
| <ip-address:n> | The RD reference number. This is based on the formal RD format structure of IP-address:Ref number.<br>The IP-address must be in IPv4 format. The value n can be any number between 1 and 65535.                        |

**NOTE:** The above table refers to an ASN or Autonomous System Number. If you have a formal ASN number assigned to your BGP network, you should enter this value. Alternatively; because the Route Distinguisher has limited functionality in VRF-lite, you can use an unofficial value for your ASN when configuring this particular command.

**Mode** VRF Configuration

**Usage** For the implementation of VRF-lite installed on your switch, this command has little practical functionality. However, the switch does check certain components of the RD that you enter. For this reason, the RD syntax must comply with the structural formats defined above, and each value that you assign to a VRF instance must be unique on the switch. Good networking practice is to use common values for the RD and RT within a VRF instance.

**Default** No default RD is configured.

**Example** To create an RD 100:2 that is associated with VRF “red” use the following commands:

```
awplus# config terminal
awplus(config)# ip vrf red
awplus(config-vrf)# rd 100:2
```

**Related Commands** [show ip vrf](#)

# redistribute (into BGP or BGP4+)

**Overview** Use this command to inject routes from one routing process into a BGP or BGP4+ routing table.

Use the **no** variant of this command to disable this function.

**Syntax** `redistribute {ospf|rip|connected|static} [route-map <route-map-entry-pointer>]`  
`no redistribute {ospf|rip|connected|static} [route-map <route-map-entry-pointer>]`

| Parameter                 | Description                                                                               |
|---------------------------|-------------------------------------------------------------------------------------------|
| connected                 | Specifies the redistribution of connected routes for both BGP and BGP4+.                  |
| ospf                      | Specifies the redistribution of OSPF information for BGP or OSPFv3 information for BGP4+. |
| rip                       | Specifies the redistribution of RIP information for BGP or RIPng information for BGP4+.   |
| static                    | Specifies the redistribution of Static routes for both BGP and BGP4+.                     |
| route-map                 | Route map reference for both BGP and BGP4+.                                               |
| <route-map-entry-pointer> | Pointer to route-map entries.                                                             |

**Mode [BGP]** Router Configuration or IPv4 Address Family Configuration

**Mode [BGP4+]** Router Configuration or IPv6 Address Family Configuration

**Usage** Redistribution is used by routing protocols to advertise routes that are learned by some other means, such as by another routing protocol or by static routes. Since all internal routes are dumped into BGP, careful filtering is applied to make sure that only routes to be advertised reach the internet, not everything. This command allows redistribution by injecting prefixes from one routing protocol into another routing protocol.

**Examples [BGP/ BGP+]** The following example shows the configuration of a route-map named `rmap1`, which is then applied using the **redistribute route-map** command.

```
awplus# configure terminal
awplus(config)# route-map rmap1 permit 1
awplus(config-route-map)# match origin incomplete
awplus(config-route-map)# set metric 100
awplus(config-route-map)# exit
awplus(config)# router bgp 12
awplus(config-router)# redistribute ospf route-map rmap1
```

To apply the above example to a specific VRF instance named `blue`, use the following commands:

```
awplus(config)# router bgp 12
awplus(config-router)# address-family ipv4 vrf blue
awplus(config-router-af)# redistribute ospf route-map rmap1
```

The following example shows the configuration of a route-map named `rmap2`, which is then applied using the **redistribute route-map** command.

```
awplus# configure terminal
awplus(config)# route-map rmap2 permit 3
awplus(config-route-map)# match interface vlan1
awplus(config-route-map)# set metric-type 1
awplus(config-route-map)# exit
awplus(config)# router ospf 100
awplus(config-router)# redistribute bgp route-map rmap2
```

Note that configuring a route-map and applying it with the `redistribute route-map` command allows you to filter which routes are distributed from another routing protocol (such as OSPF with BGP). A route-map can also set the metric, tag, and metric-type of the redistributed routes.

**Command changes** Version 5.4.6-2.1: VRF-lite support added.

# redistribute (OSPF)

**Overview** Use this command to redistribute routes from other routing protocols, static routes and connected routes into an OSPF routing table.

Use the **no** variant of this command to disable this function.

**Syntax**

```
redistribute {bgp|connected|rip|static} {metric
<0-16777214>|metric-type {1|2}|route-map <name>|tag
<0-4294967295>}

no redistribute {bgp|connected|rip|static} {metric
<0-16777214>|metric-type {1|2}|route-map <name>|tag
<0-4294967295>}
```

| Parameter   | Description                                                            |
|-------------|------------------------------------------------------------------------|
| bgp         | Specifies that this applies to the redistribution of BGP routes.       |
| connected   | Specifies that this applies to the redistribution of connected routes. |
| rip         | Specifies that this applies to the redistribution of RIP routes.       |
| static      | Specifies that this applies to the redistribution of static routes.    |
| metric      | Specifies the external metric.                                         |
| metric-type | Specifies the external metric-type.                                    |
| route-map   | Specifies name of the route-map.                                       |
| tag         | Specifies the external route tag.                                      |

**Default** The default metric value for routes redistributed into OSPF is 20. The metric can also be defined using the [set metric](#) command for a route map. Note that a metric defined using the [set metric](#) command for a route map overrides a metric defined with this command.

**Mode** Router Configuration

**Usage** You use this command to inject routes, learned from other routing protocols, into the OSPF domain to generate AS-external-LSAs. If a route-map is configured by this command, then that route-map is used to control which routes are redistributed and can set metric and tag values on particular routes.

The metric, metric-type, and tag values specified on this command are applied to any redistributed routes that are not explicitly given a different metric, metric-type, or tag value by the route map.

See the [OSPF Feature Overview and Configuration Guide](#) for more information about metrics, and about behavior when configured in route maps.

Note that this command does not redistribute the default route. To redistribute the default route, use the [default-information originate](#) command.



**Example** The following example shows the configuration of a route-map named `rmap2`, which is then applied using the **redistribute route-map** command, so routes learned via interface `vlan1` can be redistributed as type-1 external LSAs:

```
awplus# configure terminal
awplus(config)# route-map rmap2 permit 3
awplus(config-route-map)# match interface vlan1
awplus(config-route-map)# set metric-type 1
awplus(config-route-map)# exit
awplus(config)# router ospf 100
awplus(config-router)# redistributebgp rip route-map rmap2
```

Note that configuring a route-map and applying it with the **redistribute route-map** command allows you to filter which routes are distributed from another routing protocol (such as RIP). A route-map can also set the metric, tag, and metric-type of the redistributed routes.

**Related Commands**

- [match interface](#)
- [route-map](#)
- [show ip ospf database external](#)

# redistribute (RIP)

**Overview** Use this command to redistribute information from other routing protocols into RIP.

When using VRF-lite, you can apply this command to a specific VRF instance.

Use the **no** variant of this command to disable the specified redistribution. The parameters **metric** and **route-map** may be used on this command, but have no effect.

**Syntax** `redistribute {connected|static|ospf|bgp} [metric <0-16>]  
[route-map <route-map>]`  
`no redistribute {connected|static|ospf|bgp} [metric] [route-map]`

| Parameter     | Description                                                                                                                                                                                                                                           |
|---------------|-------------------------------------------------------------------------------------------------------------------------------------------------------------------------------------------------------------------------------------------------------|
| route-map     | Optional. Specifies route-map that controls how routes are redistributed.                                                                                                                                                                             |
| <route-map>   | Optional. The name of the route map.                                                                                                                                                                                                                  |
| connected     | Redistribute from connected routes.                                                                                                                                                                                                                   |
| static        | Redistribute from static routes.                                                                                                                                                                                                                      |
| ospf          | Redistribute from Open Shortest Path First (OSPF).                                                                                                                                                                                                    |
| bgp           | Redistribute from Border Gateway Protocol (BGP).                                                                                                                                                                                                      |
| metric <0-16> | Optional. Sets the value of the metric that will be applied to routes redistributed into RIP from other protocols. If a value is not specified, and no value is specified using the <a href="#">default-metric (RIP)</a> command, the default is one. |

**Default** By default, the RIP metric value is set to 1.

**Mode** RIP Router Configuration or RIP Router Address Family Configuration for a VRF instance.

**Example** To apply the metric value 15 to static routes being redistributed into RIP, use the commands:

```
awplus# configure terminal
awplus(config)# router rip
awplus(config-router)# redistribute static metric 15
```

**Example (VRF-lite)** To apply the metric value 15 to static routes in address-family ipv4 VRF instance blue being redistributed into RIP, use the following commands:

```
awplus# configure terminal
awplus(config)# router rip
awplus(config-router)# address-family ipv4 vrf blue
awplus(config-router-af)# redistribute static metric 15
```

**Related Commands** [default-metric \(RIP\)](#)

**Command changes** Version 5.4.6-2.1: VRF-lite support added.

# route (RIP)

**Overview** Use this command to add a static RIP route.  
Use the **no** variant of this command to remove a static RIP route.

**Syntax** `route <ip-addr/prefix-length>`  
`no route <ip-addr/prefix-length>`

| Parameter                                  | Description                         |
|--------------------------------------------|-------------------------------------|
| <code>&lt;ip-addr/prefix-length&gt;</code> | The IPv4 address and prefix length. |

**Default** No static RIP route is added by default.

**Mode** RIP Router Configuration or RIP Router Address Family Configuration for a VRF instance.

**Usage** Use this command to add a static RIP route. After adding the RIP route, the route can be checked in the RIP routing table.

**Example** To create a static RIP route to IP subnet 192.168.1.0/24, use the following commands:

```
awplus# configure terminal
awplus(config)# router rip
awplus(config-router)# route 192.168.1.0/24
```

**Example (VRF-lite)** To create a static RIP route to IP subnet 192.168.1.0/24, for the VRF instance red, use the following commands

```
awplus# configure terminal
awplus(config)# router rip
awplus(config-router)# address-family ipv4 vrf red
awplus(config-router-af)# route 192.168.1.0/24
```

**Related Commands** [show ip rip](#)  
[clear ip rip route](#)

**Command changes** Version 5.4.6-2.1: VRF-lite support added.

# route-target

**Overview** Use this command within a specific VRF instance, to create a route-target within the BGP extended communities path attribute field. This value can then be included in a list of import and export route target extended communities for the specified VRF instance. Learned routes that carry a specific route-target extended community are then imported into all VRFs configured with that extended community as an imported route-target.

The **no** variant of this command removes a route-target extended community for the VRF instance specified.

**Syntax** `route-target {import|export|both} {ASN:n|ip-address:n}`  
`no route-target {import|export|both} {ASN:n|ip-address:n}`

| Parameter                         | Description                                                                                                                                                                                                                                                                                                       |
|-----------------------------------|-------------------------------------------------------------------------------------------------------------------------------------------------------------------------------------------------------------------------------------------------------------------------------------------------------------------|
| <code>route-target</code>         | Specifies a BGP extended community as a route-target.                                                                                                                                                                                                                                                             |
| <code>import</code>               | Adds the route target to its import list.                                                                                                                                                                                                                                                                         |
| <code>export</code>               | Adds the route target to its export list.                                                                                                                                                                                                                                                                         |
| <code>both</code>                 | Adds the route target to both the import and export lists.                                                                                                                                                                                                                                                        |
| <code>&lt;ASN:n&gt;</code>        | The route target reference number. This uses the same structure that is defined for the RD. This being, ASN number:Ref number. The ASN value can be any number between 1 and 65535, and the value n can be any number between 1 and 4294967295.                                                                   |
| <code>&lt;ip-address:n&gt;</code> | The route target reference number. This uses the same structure that is defined for the RD (Route Distinguisher). This being IP-address:Ref number. In practice, the IP-address can be an entry in IPv4 format, or an integer number between 1 and 4294967295. The value n can be any number between 1 and 65535. |

**Mode** VRF Configuration

**Default** No route-target community attributes are associated with a VRF instance.

**Usage** In VRF systems that use MPLS, there is an close relationship between the Route Target (RT) and the Route Distinguisher (RD) values. For VRF-lite however, this relationship is only implicit in that they share the same format structure.

**Example** Use the following commands to create a route-target extended community for ASN value 200, and a Reference number of 3, within the VRF instance blue:

```
awplus# config terminal
awplus(config)# ip vrf blue
awplus(config-vrf)# route-target import 200:1
```

**Related  
Commands** [ip vrf](#)  
[show ip vrf](#)

# router ospf

**Overview** Use this command to enter Router Configuration mode to configure an OSPF routing process. You must specify the process ID with this command for multiple OSPF routing processes on the device.

Use the **no** variant of this command to terminate an OSPF routing process.

Use the **no** parameter with the **process-id** parameter, to terminate and delete a specific OSPF routing process. If no **process-id** is specified on the **no** variant of this command, then all OSPF routing processes are terminated, and all OSPF configuration is removed.

**Syntax** `router ospf [<process-id>]`  
`no router ospf [<process-id>]`

**Syntax (VRF-lite)** `router ospf [<process-id>] [<vrf-instance>]`  
`no router ospf [<process-id>]`

| Parameter      | Description                                                                  |
|----------------|------------------------------------------------------------------------------|
| <process-id>   | A positive number from 1 to 65535, that is used to define a routing process. |
| <vrf-instance> | The VRF instance to be associated with the OSPF routing process.             |

**Default** No routing process is defined by default.

**Mode** Global Configuration

**Usage** The process ID of OSPF is an optional parameter for the **no** variant of this command only. When removing all instances of OSPF, you do not need to specify each Process ID, but when removing particular instances of OSPF you must specify each Process ID to be removed.

When using VRF-lite, this command can be used to associate a process-id with a VRF instance that has been created using the [ip vrf](#) command.

**Example** To enter Router Configuration mode to configure an existing OSPF routing process 100, use the commands:

```
awplus# configure terminal
awplus(config)# router ospf 100
awplus(config-router)#
```

**Example (VRF-lite)** To enter Router Configuration mode to configure an existing OSPF routing process 100 for VRF instance `red`, use the commands:

```
awplus# configure terminal
awplus(config)# router ospf 100 red
awplus(config-router)#
```

**Command changes** Version 5.4.6-2.1: VRF-lite support added.



## router-id (VRF)

**Overview** Use this command to specify a router identifier (in IP address format). When using VRF-Lite, the router-id is configured for the specified VRF instance.

Use the **no** variant of this command to force OSPF to use the previous OSPF router-id behavior.

**Syntax** `router-id <ip-address>`  
`no router-id`

| Parameter                       | Description                                     |
|---------------------------------|-------------------------------------------------|
| <code>&lt;ip-address&gt;</code> | Specifies the router ID in IPv4 address format. |

**Mode** Router Configuration

**Usage** Configure each router with a unique router-id. In an OSPF router process that has active neighbors, a new router-id is used at the next reload or when you restart OSPF manually.

**Example** The following example shows a fixed router ID 10.10.10.60 for the VRF instance red:

```
awplus# configure terminal
awplus(config)# ip vrf red
awplus(config-router)# router-id 10.10.10.60
```

**Related  
Commands** [show ip ospf](#)  
[show ip vrf](#)

# show arp

**Overview** Use this command to display entries in the ARP routing and forwarding table—the ARP cache contains mappings of IP addresses to physical addresses for hosts. To have a dynamic entry in the ARP cache, a host must have used the ARP protocol to access another host.

For information on filtering and saving command output, see the [“Getting Started with AlliedWare Plus” Feature Overview and Configuration Guide](#).

**Syntax** `show arp [security [interface [<interface-list>]]`  
`show arp [statistics [detail][interface [<interface-list>]]]`

**Syntax (VRF-lite)** `show arp [global|security|vrf <vrf-name>]`

| Parameter                           | Description                                                                                |
|-------------------------------------|--------------------------------------------------------------------------------------------|
| <code>security</code>               | Specify the DHCP Snooping ARP security output option.                                      |
| <code>interface</code>              | Specify an interface list for DHCP Snooping ARP security output.                           |
| <code>&lt;interface-list&gt;</code> | Specify a single Layer 3 interface name, or a range of interfaces.                         |
| <code>statistics</code>             | Specify brief DHCP Snooping ARP security statistics.                                       |
| <code>detail</code>                 | Specify detailed DHCP Snooping ARP security statistics.                                    |
| <code>global</code>                 | When VRF-lite is configured, apply this command to the global routing and forwarding table |
| <code>vrf</code>                    | Apply this command to the specified VRF instance.                                          |
| <code>&lt;vrf-name&gt;</code>       | The VRF instance name                                                                      |

**Mode** User Exec and Privileged Exec

**Usage** Running this command with no additional parameters will display all entries in the ARP routing and forwarding table.

With VRF-lite configured, and no additional parameters entered, the command output displays all entries, listed by their VRF instance. By adding either a specific VRF instance or global parameter entry, you can selectively list ARP entries by their membership of a specific VRF instance.

**Example** To display all ARP entries in the ARP cache, use the following command:

```
awplus# show arp
```

**Output** Figure 34-1: Example output from the **show arp** command

```
awplus#show arp
IP Address MAC Address Interface Port Type
192.168.10.2 0015.77ad.fad8 vlan1 port1.0.1 dynamic
192.168.20.2 0015.77ad.fa48 vlan2 port1.0.2 dynamic
192.168.1.100 00d0.6b04.2a42 vlan2 port1.0.6 static
```

**Example (VRF-lite)** To display the dynamic ARP entries in the global routing instance, use the command:

```
awplus# show arp global
```

**Output** Figure 34-2: Example output from the **show arp global** command

```
awplus#show arp global
IP Address MAC Address Interface Port Type
192.168.10.2 0015.77ad.fad8 vlan1 port1.0.1 dynamic
192.168.20.2 0015.77ad.fa48 vlan2 port1.0.2 dynamic
192.168.1.100 00d0.6b04.2a42 vlan2 port1.0.8 static
```

**Example (VRF-lite)** To display the dynamic ARP entries for a VRF instance 'red', use the command:

```
awplus# show arp vrf red
```

**Output** Figure 34-3: Example output from the **show arp vrf red** command

```
awplus# show arp vrf red
[VRF: red]
IP Address MAC Address Interface Port Type
192.168.10.2 0015.77ad.fad8 vlan1 port1.0.1 dynamic
```

**Table 1:** Parameters in the output of the **show arp** command

| Parameter   | Meaning                                                                                                                                                                                                |
|-------------|--------------------------------------------------------------------------------------------------------------------------------------------------------------------------------------------------------|
| IP Address  | IP address of the network device this entry maps to.                                                                                                                                                   |
| MAC Address | Hardware address of the network device.                                                                                                                                                                |
| Interface   | Interface over which the network device is accessed.                                                                                                                                                   |
| Port        | Physical port that the network device is attached to.                                                                                                                                                  |
| Type        | Whether the entry is a static or dynamic entry. Static entries are added using the <a href="#">arp (IP address MAC)</a> command. Dynamic entries are learned from ARP request/reply message exchanges. |
| VRF         | The name of the VRF instance. The VRF-lite components only display when VRF-lite is configured.                                                                                                        |

**Related  
Commands** arp (IP address MAC)  
clear arp-cache

**Command  
changes** Version 5.4.6-2.1: VRF-lite support added.

# show crypto key pubkey-chain knownhosts

**Overview** This command displays the list of public keys maintained in the known host database on the device.

**Syntax** `show crypto key pubkey-chain knownhosts [<1-65535>]`

**Syntax (VRF-lite)** `show crypto key pubkey-chain knownhosts [vrf <vrf-name>|global] [<1-65535>]`

| Parameter               | Description                                                                                |
|-------------------------|--------------------------------------------------------------------------------------------|
| global                  | When VRF-lite is configured, apply the command to the global routing and forwarding table. |
| vrf                     | Apply the command to the specified VRF instance.                                           |
| <i>&lt;vrf-name&gt;</i> | The name of the VRF instance.                                                              |
| <i>&lt;1-65535&gt;</i>  | Key identifier for a specific key. Displays the public key of the entry if specified.      |

**Default** Display all keys.

**Mode** User Exec, Privileged Exec and Global Configuration

When VRF-lite is configured:

- If **vrf** is specified, this command displays the known host database from the specified VRF instance.
- If **global** is specified, this command displays the known host database from the global routing environment.
- If neither **vrf** nor **global** is specified, this command displays the known host database from the global routing environment and each configured VRF.

For more information about VRF, see the [VRF Lite Feature Overview and Configuration Guide](#).

**Examples** To display public keys of known SSH servers, use the command:

```
awplus# show crypto key pubkey-chain knownhosts
```

To display the key data of the first entry in the known host data, use the command:

```
awplus# show crypto key pubkey-chain knownhosts 1
```

**Output** Figure 34-4: Example output from the **show crypto key public-chain knownhosts** command

| No | Hostname                                | Type | Fingerprint                                     |
|----|-----------------------------------------|------|-------------------------------------------------|
| 1  | 172.16.23.1                             | rsa  | c8:33:b1:fe:6f:d3:8c:81:4e:f7:2a:aa:a5:be:df:18 |
| 2  | 172.16.23.10                            | rsa  | c4:79:86:65:ee:a0:1d:a5:6a:e8:fd:1d:d3:4e:37:bd |
| 3  | 5ffe:1053:ac21:ff00:0101:bcdf:ffff:0001 | rsa1 | af:4e:b4:a2:26:24:6d:65:20:32:d9:6f:32:06:ba:57 |

**Table 2:** Parameters in the output of the **show crypto key public-chain knownhosts** command

| Parameter   | Description                             |
|-------------|-----------------------------------------|
| No          | Number ID of the key.                   |
| Hostname    | Host name of the known SSH server.      |
| Type        | The algorithm used to generate the key. |
| Fingerprint | Checksum value for the public key.      |

**Related Commands** [crypto key pubkey-chain knownhosts](#)

**Command changes** Version 5.4.6-2.1: VRF-lite support added.

# show ip bgp cidr-only (BGP only)

**Overview** Use this command to display routes with non-natural network masks.

For information on filtering and saving command output, see the [“Getting Started with AlliedWare Plus” Feature Overview and Configuration Guide](#).

**Syntax** `show ip bgp cidr-only`

**Syntax [VRF]** `show ip bgp [global|vrf <vrf-name>] cidr-only`

| Parameter  | Description                                                                                |
|------------|--------------------------------------------------------------------------------------------|
| global     | When VRF-lite is configured, apply the command to the global routing and forwarding table. |
| vrf        | Apply the command to the specified VRF instance.                                           |
| <vrf-name> | The name of the VRF instance.                                                              |

**Mode** User Exec and Privileged Exec

**Example** `awplus# show ip bgp cidr-only`  
`awplus# show ip bgp vrf red cidr-only`

**Output** Figure 34-5: Example output from the **show ip bgp cidr-only** command

```
BGP table version is 0, local router ID is 10.10.10.50

Status codes: s suppressed, d damped, h history, p stale, *
valid, > best, i - internal

Origin codes: i - IGP, e - EGP, ? - incomplete

 Network Next Hop Metric LocPrf Weight Path
*> 3.3.3.0/24 10.10.10.10 0 11 i
*> 6.6.6.0/24 0.0.0.0 32768 i

Total number of prefixes 2
```

**Command changes** Version 5.4.6-2.1: VRF-lite support added.

# show ip bgp community (BGP only)

**Overview** Use this command to display routes that match specified communities from a BGP instance within an IPv4 environment. Use the [show bgp ipv6 community \(BGP4+ only\)](#) command within an IPv6 environment.

For information on filtering and saving command output, see the [“Getting Started with AlliedWare Plus” Feature Overview and Configuration Guide](#).

You may use any combination and repetition of parameters listed in the *<type>* placeholder.

**Syntax** `show ip bgp community [<type>] [exact-match]`

**Syntax [VRF]** `show ip bgp [global|vrf <vrf-name>] community [<type>] [exact-match]`

| Parameter               | Description                                                                                                 |
|-------------------------|-------------------------------------------------------------------------------------------------------------|
| global                  | When VRF-lite is configured, apply the command to the global routing and forwarding table.                  |
| vrf                     | Apply the command to the specified VRF instance.                                                            |
| <i>&lt;vrf-name&gt;</i> | The name of the VRF instance.                                                                               |
| <i>&lt;type&gt;</i>     | {[ <i>AA:NN</i> ] [ <i>local-AS</i> ] [ <i>no-advertise</i> ] [ <i>no-export</i> ] }                        |
| <i>AA:NN</i>            | Specifies the Autonomous System (AS) community number, in AA:NN format.                                     |
| <i>local-AS</i>         | Do not send outside local Autonomous Systems (well-known community).                                        |
| <i>no-advertise</i>     | Do not advertise to any peer (well-known community).                                                        |
| <i>no-export</i>        | Do not export to next AS (well-known community).                                                            |
| <i>exact-match</i>      | Specifies that the exact match of the communities is displayed. This optional parameter cannot be repeated. |

**Mode** User Exec and Privileged Exec



**Examples** Note that the AS numbers shown are examples only.

```
awplus# show ip bgp community 64497:64499 exact-match
awplus# show ip bgp community 64497:64499 64500:64501
exact-match
awplus# show ip bgp community 64497:64499 64500:64501
64510:64511no-advertise
awplus# show ip bgp community no-advertise
no-advertiseno-advertise exact-match
awplus# show ip bgp community no-export 64510:64511
no-advertise local-AS no-export
awplus# show ip bgp community no-export 64510:64511
no-advertise 64497:64499 64500:64501 no-export
awplus# show ip bgp community no-export 64497:64499
no-advertise local-AS no-export
awplus# show ip bgp vrf red no-export
awplus# show ip bgp global 65500:2 65500:3 exact-match
```

**Related  
Commands** [set community](#)  
[show bgp ipv6 community \(BGP4+ only\)](#)

**Command  
changes** Version 5.4.6-2.1: VRF-lite support added.

# show ip bgp community-list (BGP only)

**Overview** Use this command to display routes that match the given community-list from a BGP instance within an IPv4 environment. Use the [show bgp ipv6 community-list \(BGP4+ only\)](#) command within an IPv6 environment.

For information on filtering and saving command output, see the [“Getting Started with AlliedWare Plus” Feature Overview and Configuration Guide](#).

**Syntax** `show ip bgp community-list <listname> [exact-match]`

**Syntax [VRF]** `show ip bgp [global|vrf <vrf-name>] community-list <listname> [exact-match]`

| Parameter   | Description                                                                                |
|-------------|--------------------------------------------------------------------------------------------|
| global      | When VRF-lite is configured, apply the command to the global routing and forwarding table. |
| vrf         | Apply the command to the specified VRF instance.                                           |
| <vrf-name>  | The name of the VRF instance.                                                              |
| <listname>  | Specifies the community list name.                                                         |
| exact-match | Displays only routes that have exactly the same specified communities.                     |

**Mode** User Exec and Privileged Exec

**Example**

```
awplus# show ip bgp community-list mylist exact-match
awplus# show ip bgp vrf red community-list myCommunity
awplus# show ip bgp global community-list myExactCommunity
exact-match
```

**Related Commands** [show bgp ipv6 community-list \(BGP4+ only\)](#)

**Command changes** Version 5.4.6-2.1: VRF-lite support added.

# show ip bgp dampening (BGP only)

**Overview** Use this command to show dampened routes from a BGP instance within an IPv4 environment. Use the [show bgp ipv6 dampening \(BGP4+ only\)](#) command within an IPv6 environment.

For information on filtering and saving command output, see the [“Getting Started with AlliedWare Plus” Feature Overview and Configuration Guide](#).

**Syntax** `show ip bgp dampening  
{dampened-paths|flap-statistics|parameters}`

**Syntax [VRF]** `show ip bgp [global|vrf <vrf-name>] dampening  
{dampened-paths|flap-statistics|parameters}`

| Parameter       | Description                                                                                |
|-----------------|--------------------------------------------------------------------------------------------|
| global          | When VRF-lite is configured, apply the command to the global routing and forwarding table. |
| vrf             | Apply the command to the specified VRF instance.                                           |
| <vrf-name>      | The name of the VRF instance.                                                              |
| dampened-paths  | Display paths suppressed due to dampening.                                                 |
| flap-statistics | Display flap statistics of routes.                                                         |
| parameters      | Display details of configured dampening parameters.                                        |

**Mode** User Exec and Privileged Exec

**Usage** Enable BGP dampening to maintain dampened-path information in memory.

**Examples** `awplus# show ip bgp dampening dampened-paths  
awplus# show ip bgp vrf red dampening dampened-paths  
awplus# show ip bgp global dampening flap-statistics`

**Output** Figure 34-6: Example output from the **show ip bgp dampening** command

```
dampening 15 750 2000 60 15
 Reachability Half-Life time : 15 min
 Reuse penalty : 750
 Suppress penalty : 2000
 Max suppress time : 60 min
 Un-reachability Half-Life time : 15 min
 Max penalty (ceil) : 11999
 Min penalty (floor) : 375
```

The following example output shows that the internal route (i), has flapped 3 times and is now categorized as history (h).

Figure 34-7: Example output from the **show ip bgp dampening flap-statistics** command

```
awplus# show ip bgp dampening flap-statistics
BGP table version is 1, local router ID is 30.30.30.77
Status codes: s suppressed, d damped, h history, * valid, > best, i - internal, S
Stale
Origin codes: i - IGP, e - EGP, ? - incomplete
 Network From Flaps Duration Reuse Path
 ---- -
hi1.1.1.0/24 10.100.0.62 3 00:01:20 i
```

The following example output shows a dampened route in the 1.1.1.0/24 network.

Figure 34-8: Example output from the **show ip bgp dampening dampened-path** command

```
awplus# show ip bgp dampening dampened-paths
BGP table version is 1, local router ID is 30.30.30.77
Status codes: s suppressed, d damped, h history, * valid, > best, i - internal, S
Stale
Origin codes: i - IGP, e - EGP, ? - incomplete
 Network From Reuse Path
 ---- -
di 1.1.1.0/24 10.100.0.62 00:35:10 i

Total number of prefixes 1
```

**Related Commands** [show bgp ipv6 dampening \(BGP4+ only\)](#)

**Command changes** Version 5.4.6-2.1: VRF-lite support added.

# show ip bgp filter-list (BGP only)

**Overview** Use this command to display routes conforming to the filter-list within an IPv4 environment. Use the [show bgp ipv6 filter-list \(BGP4+ only\)](#) command to display routes conforming to the filter-list within an IPv6 environment

For information on filtering and saving command output, see the [“Getting Started with AlliedWare Plus” Feature Overview and Configuration Guide](#).

**Syntax** `show ip bgp filter-list <listname>`

**Syntax [VRF]** `show ip bgp [global|vrf <vrf-name>] filter-list <listname>`

| Parameter  | Description                                                                                |
|------------|--------------------------------------------------------------------------------------------|
| global     | When VRF-lite is configured, apply the command to the global routing and forwarding table. |
| vrf        | Apply the command to the specified VRF instance.                                           |
| <vrf-name> | The name of the VRF instance.                                                              |
| <listname> | Specifies the regular-expression access list name.                                         |

**Mode** User Exec and Privileged Exec

**Example**  
`awplus# show ip bgp filter-list mylist`  
`awplus# show ip bgp vrf red filter-list mylist`

**Related Commands** [show bgp ipv6 filter-list \(BGP4+ only\)](#)

**Command changes** Version 5.4.6-2.1: VRF-lite support added.

# show ip bgp inconsistent-as (BGP only)

**Overview** Use this command to display routes with inconsistent AS Paths within an IPv4 environment. Use the [show bgp ipv6 inconsistent-as \(BGP4+ only\)](#) command to display routes with inconsistent AS paths within an IPv6 environment.

For information on filtering and saving command output, see the [“Getting Started with AlliedWare Plus” Feature Overview and Configuration Guide](#).

**Syntax** `show ip bgp inconsistent-as`

**Syntax [VRF]** `show ip bgp [global|vrf <vrf-name>] inconsistent-as`

| Parameter  | Description                                                                                |
|------------|--------------------------------------------------------------------------------------------|
| global     | When VRF-lite is configured, apply the command to the global routing and forwarding table. |
| vrf        | Apply the command to the specified VRF instance.                                           |
| <vrf-name> | The name of the VRF instance.                                                              |

**Mode** User Exec and Privileged Exec

**Example**  
`awplus# show ip bgp inconsistent-as`  
`awplus# show ip bgp global inconsistent-as`

**Related Commands** [show bgp ipv6 inconsistent-as \(BGP4+ only\)](#)

**Command changes** Version 5.4.6-2.1: VRF-lite support added.

# show ip bgp longer-prefixes (BGP only)

**Overview** Use this command to display the route of the local BGP routing table for a specific prefix with a specific mask, or for any prefix having a longer mask than the one specified.

For information on filtering and saving command output, see the [“Getting Started with AlliedWare Plus” Feature Overview and Configuration Guide](#).

**Syntax** `show ip bgp <ip-address/m> longer-prefixes`

**Syntax [VRF]** `show ip bgp [global|vrf <vrf-name>] <ip-address/m> longer-prefixes`

| Parameter      | Description                                                                                              |
|----------------|----------------------------------------------------------------------------------------------------------|
| global         | When VRF-lite is configured, apply the command to the global routing and forwarding table.               |
| vrf            | Apply the command to the specified VRF instance.                                                         |
| <vrf-name>     | The name of the VRF instance.                                                                            |
| <ip-address/m> | Neighbor's IP address and subnet mask, entered in the form A.B.C.D/M, where M is the subnet mask length. |

**Mode** User Exec and Privileged Exec

**Example**

```
awplus# show ip bgp 10.10.0.10/24 longer-prefixes
awplus# show ip bgp vrf red 172.16.4.0/24
awplus# show ip bgp global 172.16.0.0/16 longer-prefixes
```

**Command changes** Version 5.4.6-2.1: VRF-lite support added.

# show ip bgp prefix-list (BGP only)

**Overview** Use this command to display routes matching the prefix-list within an IPv4 environment. Use the [show bgp ipv6 prefix-list \(BGP4+ only\)](#) command to display routes matching the prefix-list within an IPv6 environment.

For information on filtering and saving command output, see the [“Getting Started with AlliedWare Plus” Feature Overview and Configuration Guide](#).

**Syntax** `show ip bgp prefix-list <list>`

**Syntax [VRF]** `show ip bgp [global|vrf <vrf-name>] prefix-list <list>`

| Parameter  | Description                                                                                |
|------------|--------------------------------------------------------------------------------------------|
| global     | When VRF-lite is configured, apply the command to the global routing and forwarding table. |
| vrf        | Apply the command to the specified VRF instance.                                           |
| <vrf-name> | The name of the VRF instance.                                                              |
| <list>     | Specifies the name of the IP prefix list.                                                  |

**Mode** User Exec and Privileged Exec

**Examples**  
`awplus# show ip bgp prefix-list mylist`  
`awplus# show ip bgp vrf red prefix-list myPrefixes`

**Related Commands** [show bgp ipv6 prefix-list \(BGP4+ only\)](#)

**Command changes** Version 5.4.6-2.1: VRF-lite support added.



# show ip bgp quote-regexp (BGP only)

**Overview** Use this command to display routes matching the AS path regular expression within an IPv4 environment. Use the [show bgp ipv6 quote-regexp \(BGP4+ only\)](#) command to display routes matching the AS path regular expression within an IPv6 environment.

Note that you must use quotes to enclose the regular expression with this command. Use the regular expressions listed below with the *<expression>* parameter:

| Symbol | Character     | Meaning                                                                                                                            |
|--------|---------------|------------------------------------------------------------------------------------------------------------------------------------|
| ^      | Caret         | Used to match the beginning of the input string. When used at the beginning of a string of characters, it negates a pattern match. |
| \$     | Dollar sign   | Used to match the end of the input string.                                                                                         |
| .      | Period        | Used to match a single character (white spaces included).                                                                          |
| *      | Asterisk      | Used to match none or more sequences of a pattern.                                                                                 |
| +      | Plus sign     | Used to match one or more sequences of a pattern.                                                                                  |
| ?      | Question mark | Used to match none or one occurrence of a pattern.                                                                                 |
| _      | Underscore    | Used to match spaces, commas, braces, parenthesis, or the beginning and end of an input string.                                    |
| [ ]    | Brackets      | Specifies a range of single-characters.                                                                                            |
| -      | Hyphen        | Separates the end points of a range.                                                                                               |

For information on filtering and saving command output, see the [“Getting Started with AlliedWare Plus” Feature Overview and Configuration Guide](#).

**Syntax** `show ip bgp quote-regexp <expression>`

**Syntax [VRF]** `show ip bgp [global|vrf <vrf-name>] quote-regexp <expression>`

| Parameter    | Description                                                                                |
|--------------|--------------------------------------------------------------------------------------------|
| global       | When VRF-lite is configured, apply the command to the global routing and forwarding table. |
| vrf          | Apply the command to the specified VRF instance.                                           |
| <vrf-name>   | The name of the VRF instance.                                                              |
| <expression> | Specifies a regular-expression to match the BGP AS paths.                                  |

**Mode** User Exec and Privileged Exec

**Examples** awplus# show ip bgp quote-regexp myexpression  
awplus# show ip bgp global quote-regexp 65550 65555

**Related Commands** [show bgp ipv6 quote-regexp \(BGP4+ only\)](#)

**Command changes** Version 5.4.6-2.1: VRF-lite support added.

# show ip bgp regexp (BGP only)

**Overview** Use this command to display routes matching the AS path regular expression within an IPv4 environment. Use the [show bgp ipv6 regexp \(BGP4+ only\)](#) command to display routes matching the AS path regular expression within an IPv6 environment.

Use the regular expressions listed below with the *<expression>* parameter:

| Symbol | Character     | Meaning                                                                                                                            |
|--------|---------------|------------------------------------------------------------------------------------------------------------------------------------|
| ^      | Caret         | Used to match the beginning of the input string. When used at the beginning of a string of characters, it negates a pattern match. |
| \$     | Dollar sign   | Used to match the end of the input string.                                                                                         |
| .      | Period        | Used to match a single character (white spaces included).                                                                          |
| *      | Asterisk      | Used to match none or more sequences of a pattern.                                                                                 |
| +      | Plus sign     | Used to match one or more sequences of a pattern.                                                                                  |
| ?      | Question mark | Used to match none or one occurrence of a pattern.                                                                                 |
| _      | Underscore    | Used to match spaces, commas, braces, parenthesis, or the beginning and end of an input string.                                    |
| [ ]    | Brackets      | Specifies a range of single-characters.                                                                                            |
| -      | Hyphen        | Separates the end points of a range.                                                                                               |

For information on filtering and saving command output, see the [“Getting Started with AlliedWare Plus” Feature Overview and Configuration Guide](#).

**Syntax** `show ip bgp regexp <expression>`

**Syntax [VRF]** `show ip bgp [global|vrf <vrf-name>] regexp <expression>`

| Parameter    | Description                                                                                |
|--------------|--------------------------------------------------------------------------------------------|
| global       | When VRF-lite is configured, apply the command to the global routing and forwarding table. |
| vrf          | Apply the command to the specified VRF instance.                                           |
| <vrf-name>   | The name of the VRF instance.                                                              |
| <expression> | Specifies a regular-expression to match the BGP AS paths.                                  |

**Mode** User Exec and Privileged Exec

**Examples** awplus# show ip bgp regexp myexpression  
awplus# show ip bgp vrf red regexp 65550 65555

**Related Commands** [show bgp ipv6 regexp \(BGP4+ only\)](#)

**Command changes** Version 5.4.6-2.1: VRF-lite support added.

# show ip bgp route-map (BGP only)

**Overview** Use this command to display BGP routes that match the specified route-map within an IPv4 environment. Use the [show bgp ipv6 route-map \(BGP4+ only\)](#) command to display BGP4+ routes that match the specified route-map within an IPv6 environment.

For information on filtering and saving command output, see the [“Getting Started with AlliedWare Plus” Feature Overview and Configuration Guide](#).

**Syntax** `show ip bgp route-map <route-map>`

**Syntax [VRF]** `show ip bgp [global|vrf <vrf-name>] route-map <route-map>`

| Parameter   | Description                                                                                |
|-------------|--------------------------------------------------------------------------------------------|
| global      | When VRF-lite is configured, apply the command to the global routing and forwarding table. |
| vrf         | Apply the command to the specified VRF instance.                                           |
| <vrf-name>  | The name of the VRF instance.                                                              |
| <route-map> | Specifies a route-map that is matched.                                                     |

**Mode** User Exec and Privileged Exec

**Examples** To show routes that match the route-map `myRouteMap` for the global routing instance, use the command:

```
awplus# show ip bgp global route-map myRouteMap
```

To show routes that match the route-map `myRouteMap`, use the command:

```
awplus# show ip bgp route-map myRouteMap
```

**Related Commands** [show bgp ipv6 route-map \(BGP4+ only\)](#)

**Command changes** Version 5.4.6-2.1: VRF-lite support added.

# show ip bgp summary (BGP only)

**Overview** Use this command to display a summary of a BGP neighbor status within an IPv4 environment. Use the [show bgp ipv6 summary \(BGP4+ only\)](#) command to display a summary of BGP4+ neighbors.

For information on filtering and saving command output, see the [“Getting Started with AlliedWare Plus” Feature Overview and Configuration Guide](#).

**Syntax** `show ip bgp summary`

**Syntax [VRF]** `show ip bgp [global|vrf <vrf-name>] summary`

| Parameter  | Description                                                                                |
|------------|--------------------------------------------------------------------------------------------|
| global     | When VRF-lite is configured, apply the command to the global routing and forwarding table. |
| vrf        | Apply the command to the specified VRF instance.                                           |
| <vrf-name> | The name of the VRF instance.                                                              |

**Mode** User Exec and Privileged Exec

**Examples**  
`awplus# show ip bgp summary`  
`awplus# show ip bgp vrf red summary`

**Output** Figure 34-9: Example output from the **show ip bgp summary** command

```
awplus>show ip bgp summary

BGP router identifier 1.0.0.1, local AS number 65541
BGP table version is 12
4 BGP AS-PATH entries
0 BGP community entries

Neighbor V AS MsgRc MsgSnt TblVer InOutQ Up/Down State/PfxRcd
192.168.3.2 4 65544 20 24 11 0/0 00:07:19 1
192.168.4.2 4 65545 0 0 0 0/0 never Active
192.168.11.2 4 65542 34 40 0 0/0 00:00:04 Active
192.168.21.2 4 65543 29 32 11 0/0 00:07:03 13

Number of neighbors 4
```

The Up/Down column in this output is a timer that shows:

- "never" if the peer session has never been established
- The up time, if the peer session is currently up
- The down time, if the peer session is currently down.

In the example above, the session with 192.168.11.2 has been down for 4 seconds, and the session with 192.168.4.2 has never been established.

**Related Commands** [show bgp ipv6 summary \(BGP4+ only\)](#)

**Command changes** Version 5.4.6-2.1: VRF-lite support added.

# show ip interface vrf

**Overview** Use this command to display protocol and status information about configured interfaces and their assigned IP addresses in VRF instances.

For information on filtering and saving command output, see the [“Getting Started with AlliedWare Plus” Feature Overview and Configuration Guide](#).

**Syntax** `show ip interface [vrf <vrf-name>|global]`

| Parameter  | Description                              |
|------------|------------------------------------------|
| vrf        | A VRF instance.                          |
| <vrf-name> | The name of a specific VRF instance.     |
| global     | The global routing and forwarding table. |

**Mode** User Exec and Privileged Exec

**Examples** To display all interfaces and IP addresses associated with a VRF instance ‘red’, use the command:

```
awplus# show ip interface vrf red
```

**Output** Figure 34-10: Example output from **show ip interface vrf red**

| Interface | IP-Address      | Status   | Protocol |
|-----------|-----------------|----------|----------|
| lol       | unassigned      | admin up | running  |
| vlan1     | 192.168.10.1/24 | admin up | running  |

**Example** To display all interfaces and IP addresses associated with all VRF instances, use the command:

```
awplus# show ip interface
```



**Output** Figure 34-11: Example output from the **show ip interface** with VRF-lite configured

|             |                |          |          |
|-------------|----------------|----------|----------|
| Interface   | IP-Address     | Status   | Protocol |
| eth0        | unassigned     | admin up | down     |
| lo          | unassigned     | admin up | running  |
| vlan1       | 192.168.1.1/24 | admin up | running  |
| vlan4       | 172.30.4.43/24 | admin up | down     |
| [VRF: red]  |                |          |          |
| Interface   | IP-Address     | Status   | Protocol |
| lo1         | unassigned     | admin up | running  |
| [VRF: blue] |                |          |          |
| Interface   | IP-Address     | Status   | Protocol |
| lo2         | unassigned     | admin up | running  |

**Command changes** Version 5.4.6-2.1: VRF-lite support added.

# show ip rip vrf database

**Overview** Use this command to display information about the RIP database that is associated with a specific VRF instance.

Entering this command with the **full** option included, will display information about the full RIP database (including sub-optimal routes) associated with a specific VRF instance.

For information on filtering and saving command output, see the [“Getting Started with AlliedWare Plus” Feature Overview and Configuration Guide](#).

**Syntax** `show ip rip {vrf <vrf-name>|global} database [full]`

| Parameter  | Description                                                     |
|------------|-----------------------------------------------------------------|
| vrf        | Specific VRF instance.                                          |
| <vrf-name> | The name of the VRF instance.                                   |
| global     | The global routing and forwarding table.                        |
| full       | Specify the full RIP database including sub-optimal RIP routes. |

**Mode** User Exec and Privileged Exec

**Example** To display information about the RIP database associated with a VRF instance 'blue', use the command:

```
awplus# show ip rip vrf blue database
```

**Output** Figure 34-12: Example output from the **show ip rip vrf blue database** command

```
Codes: R - RIP, Rc - RIP connected, Rs - RIP static
 C - Connected, S - Static, O - OSPF, B - BGP
```

| Network            | Next Hop     | Metric | From         | If    | Time  |
|--------------------|--------------|--------|--------------|-------|-------|
| Rc 192.168.30.0/24 |              | 1      |              | vlan3 |       |
| R 192.168.45.0/24  | 192.168.30.1 | 2      | 192.168.30.1 | vlan3 | 02:46 |

**Related Commands** [show ip rip](#)

**Command changes** Version 5.4.6-2.1: VRF-lite support added.

# show ip rip vrf interface

**Overview** Use this command to display information about the RIP interfaces that are associated with a specific VRF instance.

For information on filtering and saving command output, see the [“Getting Started with AlliedWare Plus” Feature Overview and Configuration Guide](#).

**Syntax** `show ip rip {vrf <vrf-name>|global} interface [<interface-name>]`

| Parameter        | Description                              |
|------------------|------------------------------------------|
| vrf              | Specific VRF instance.                   |
| <vrf-name>       | The name of the VRF instance.            |
| global           | The global routing and forwarding table. |
| <interface-name> | The IP RIP interface (VLAN).             |

**Mode** User Exec and Privileged Exec

**Example** To display information about the RIP database associated with a VRF instance 'blue', use the command:

```
awplus# show ip rip vrf blue interface
```

**Output** Figure 34-13: Example output from **show ip rip vrf blue interface vlan3**

|                                                     |                 |                |              |       |       |
|-----------------------------------------------------|-----------------|----------------|--------------|-------|-------|
| Codes: R - RIP, Rc - RIP connected, Rs - RIP static |                 |                |              |       |       |
| C - Connected, S - Static, O - OSPF, B - BGP        |                 |                |              |       |       |
|                                                     | Network         | Next Hop       | Metric From  | If    | Time  |
| Rc                                                  | 192.168.30.0/24 |                | 1            | vlan3 |       |
| R                                                   | 192.168.45.0/24 | 192.168.30.1 2 | 192.168.30.1 | vlan3 | 02:46 |

**NOTE:** The Time parameter operates as follows:

- RIP updates occur approximately every 30 seconds.
- Each update resets a count-down timer to 180 seconds (3 minutes).
- The Time parameter displays the count-down from the last reset.

**Related Commands** [show ip rip](#)

**Command changes** Version 5.4.6-2.1: VRF-lite support added.

# show ip route

**Overview** Use this command to display routing entries in the FIB (Forwarding Information Base). The FIB contains the best routes to a destination, and your device uses these routes when forwarding traffic. You can display a subset of the entries in the FIB based on protocol.

To modify the lines displayed, use the | (output modifier token); to save the output to a file, use the > output redirection token.

**VRF-lite** If VRF-lite is configured, you can display routing entries in the FIB associated with either the global routing domain or a named VRF.

**Syntax** `show ip route [bgp|connected|ospf|rip|static|<ip-addr>|<ip-addr/prefix-length>]`

**Syntax (VRF-lite)** `show ip route {vrf <vrf-name>|global}  
[bgp|connected|ospf|rip|static]`

| Parameter               | Description                                                                              |
|-------------------------|------------------------------------------------------------------------------------------|
| global                  | If VRF-lite is configured, apply the command to the global routing and forwarding table. |
| vrf                     | Apply the command to the specified VRF instance.                                         |
| <vrf-name>              | The name of the VRF instance.                                                            |
| bgp                     | Displays only the routes learned from BGP.                                               |
| connected               | Displays only the routes learned from connected interfaces.                              |
| ospf                    | Displays only the routes learned from OSPF.                                              |
| rip                     | Displays only the routes learned from RIP.                                               |
| static                  | Displays only the static routes you have configured.                                     |
| <ip-addr>               | Displays the routes for the specified address. Enter an IPv4 address.                    |
| <ip-addr/prefix-length> | Displays the routes for the specified network. Enter an IPv4 address and prefix length.  |

**Mode** User Exec and Privileged Exec

**Example** To display the static routes in the FIB, use the command:

```
awplus# show ip route static
```

To display the OSPF routes in the FIB, use the command:

```
awplus# show ip route ospf
```

**Example (VRF-lite)** To display all routing entries in the FIB associated with a VRF instance `red`, use the command:

```
awplus# show ip route vrf red
```

**Output** Each entry in the output from this command has a code preceding it, indicating the source of the routing entry. For example, O indicates OSPF as the origin of the route. The first few lines of the output list the possible codes that may be seen with the route entries.

Typically, route entries are composed of the following elements:

- code
- a second label indicating the sub-type of the route
- network or host IP address
- administrative distance and metric
- next hop IP address
- outgoing interface name
- time since route entry was added

Figure 34-14: Example output from the **show ip route** command

```
Codes: C - connected, S - static, R - RIP, B - BGP
O - OSPF, IA - OSPF inter area
N1 - OSPF NSSA external type 1, N2 - OSPF NSSA external type 2
E1 - OSPF external type 1, E2 - OSPF external type 2
* - candidate default

O 10.10.37.0/24 [110/11] via 10.10.31.16, vlan2, 00:20:54
C 3.3.3.0/24 is directly connected, vlan1
C 10.10.31.0/24 is directly connected, vlan2
C 10.70.0.0/24 is directly connected, vlan4
O E2 14.5.1.0/24 [110/20] via 10.10.31.16, vlan2, 00:18:56
C 33.33.33.33/32 is directly connected, lo
```

**Connected Route** The connected route entry consists of:

```
C 10.10.31.0/24 is directly connected, vlan2
```

This route entry denotes:

- Route entries for network `10.10.31.0/24` are derived from the IP address of local interface `vlan2`.
- These routes are marked as Connected routes (C) and always preferred over routes for the same network learned from other routing protocols.

**OSPF Route** The OSPF route entry consists of:

```
O 10.10.37.0/24 [110/11] via 10.10.31.16, vlan2, 00:20:54
```

This route entry denotes:

- This route in the network 10.10.37.0/24 was added by OSPF.
- This route has an administrative distance of 110 and metric/cost of 11.
- This route is reachable via next hop 10.10.31.16.
- The outgoing local interface for this route is `vlan2`.
- This route was added 20 minutes and 54 seconds ago.

### OSPF External Route

The OSPF external route entry consists of:

```
O E2 14.5.1.0/24 [110/20] via 10.10.31.16, vlan2, 00:18:56
```

This route entry denotes that this route is the same as the other OSPF route explained above; the main difference is that it is a Type 2 External OSPF route.

### Related Commands

[ip route](#)  
[maximum-paths](#)  
[show ip route database](#)

### Command changes

Version 5.4.6-2.1: VRF-lite support added.

# show ip route database

**Overview** This command displays the routing entries in the RIB (Routing Information Base).

When multiple entries are available for the same prefix, RIB uses the routes' administrative distances to choose the best route. All best routes are entered into the FIB (Forwarding Information Base). To view the routes in the FIB, use the [show ip route](#) command.

To modify the lines displayed, use the | (output modifier token); to save the output to a file, use the > output redirection token.

**Syntax** `show ip route database [bgp|connected|ospf|rip|static]`

**Syntax (VRF-lite)** `show ip route [vrf <vrf-name>|global] database [bgp|connected|ospf|rip|static]`

| Parameter  | Description                                                                              |
|------------|------------------------------------------------------------------------------------------|
| global     | If VRF-lite is configured, apply the command to the global routing and forwarding table. |
| vrf        | Apply the command to the specified VRF instance.                                         |
| <vrf-name> | The name of the VRF instance.                                                            |
| bgp        | Displays only the routes learned from BGP.                                               |
| connected  | Displays only the routes learned from connected interfaces.                              |
| ospf       | Displays only the routes learned from OSPF.                                              |
| rip        | Displays only the routes learned from RIP.                                               |
| static     | Displays only the static routes you have configured.                                     |

**Mode** User Exec and Privileged Exec

**Example** To display the static routes in the RIB, use the command:

```
awplus# show ip route database static
```

**Output** Figure 34-15: Example output from the **show ip route database** command

```
Codes: C - connected, S - static, R - RIP, B - BGP
 O - OSPF, IA - OSPF inter area
 N1 - OSPF NSSA external type 1, N2 - OSPF NSSA external type 2
 E1 - OSPF external type 1, E2 - OSPF external type 2
 > - selected route, * - FIB route, p - stale info

O *> 9.9.9.9/32 [110/31] via 10.10.31.16, vlan2, 00:19:21
O 10.10.31.0/24 [110/1] is directly connected, vlan2, 00:28:20
C *> 10.10.31.0/24 is directly connected, vlan2
S *> 10.10.34.0/24 [1/0] via 10.10.31.16, vlan2
O 10.10.34.0/24 [110/31] via 10.10.31.16, vlan2, 00:21:19
O *> 10.10.37.0/24 [110/11] via 10.10.31.16, vlan2, 00:21:19
C *> 10.30.0.0/24 is directly connected, vlan6
S *> 11.22.11.0/24 [1/0] via 10.10.31.16, vlan2
O E2 *> 14.5.1.0/24 [110/20] via 10.10.31.16,vlan2, 00:19:21
O 16.16.16.16/32 [110/11] via 10.10.31.16, vlan2, 00:21:19
S *> 16.16.16.16/32 [1/0] via 10.10.31.16, vlan2
O *> 17.17.17.17/32 [110/31] via 10.10.31.16, vlan2, 00:21:19
C *> 45.45.45.45/32 is directly connected, lo
O *> 55.55.55.55/32 [110/21] via 10.10.31.16, vlan2, 00:21:19
C *> 127.0.0.0/8 is directly connected, lo
```

**Example (VRF-lite)** To display all routing entries in the RIB associated with a VRF instance `red`, use the command:

```
awplus# show ip route vrf red database
```

**Output** Figure 34-16: Example output from the **show ip route vrf red database** command

```
[VRF: red]
Codes: C - connected, S - static, R - RIP, B - BGP
 O - OSPF, IA - OSPF inter area
 N1 - OSPF NSSA external type 1, N2 - OSPF NSSA external type 2
 E1 - OSPF external type 1, E2 - OSPF external type 2
 > - selected route, * - FIB route, p - stale info

O 192.168.10.0/24 [110/1] is directly connected, vlan1, 06:45:51
C *> 192.168.10.0/24 is directly connected, vlan1
B > 192.168.33.0/24 [20/0] via 192.168.30.3, 06:45:52
O E2 *> 192.168.110.0/24 [110/20] via 192.168.10.2, vlan1, 06:45:00
O E2 *> 192.168.111.0/24 [110/20] via 192.168.10.2, vlan1, 06:45:00
```

The routes added to the FIB are marked with a \*. When multiple routes are available for the same prefix, the best route is indicated with the > symbol. All unselected routes have neither the \* nor the > symbol.

```
S *> 10.10.34.0/24 [1/0] via 10.10.31.16, vlan2
O 10.10.34.0/24 [110/31] via 10.10.31.16, vlan2, 00:21:19
```

These route entries denote:

- The same prefix was learned from OSPF and from static route configuration.



- Since this static route has a lower administrative distance than the OSPF route (110), the static route (1) is selected and installed in the FIB.

If the static route becomes unavailable, then the device automatically selects the OSPF route and installs it in the FIB.

**Related  
Commands** [maximum-paths](#)  
[show ip route](#)

**Command  
changes** Version 5.4.6-2.1: VRF-lite support added.

# show ip route summary

**Overview** This command displays a summary of the current RIB (Routing Information Base) entries.

To modify the lines displayed, use the | (output modifier token); to save the output to a file, use the > output redirection token.

**Syntax** `show ip route summary`

**Syntax (VRF-lite)** `show ip route summary [vrf <vrf-name>|global]`

| Parameter  | Description                              |
|------------|------------------------------------------|
| vrf        | Specific VRF instance.                   |
| <vrf-name> | The name of the VRF instance.            |
| global     | The global routing and forwarding table. |

**Mode** User Exec and Privileged Exec

**Example** To display a summary of the current RIB entries, use the command:

```
awplus# show ip route summary
```

**Output** Figure 34-17: Example output from the **show ip route summary** command

```
IP routing table name is Default-IP-Routing-Table(0)
IP routing table maximum-paths is 4
Route Source Networks
connected 5
ospf 2
Total 8
```

**Example (VRF-lite)** To display a summary of the current RIB entries associated with a VRF instance red, use the command:

```
awplus# show ip route summary vrf red
```

**Output** Figure 34-18: Example output from the **show ip route summary vrf red** command

```
IP routing table name is Default-IP-Routing-Table(0)
IP routing table maximum-paths is 4
Route Source Networks
connected 1
Total 1
FIB 0

[VRF: red]
Route Source Networks
connected 1
ospf 2
Total 3
```

**Related Commands** [show ip route](#)  
[show ip route database](#)

**Command changes** Version 5.4.6-2.1: VRF-lite support added.

# show ip vrf

**Overview** This command displays brief configurations for a specific VRF instance.

**Syntax** `show ip vrf <vrf-name>`

| Parameter                     | Description                   |
|-------------------------------|-------------------------------|
| <code>&lt;vrf-name&gt;</code> | The name of the VRF instance. |

**Mode** User Exec and Privileged Exec

**Example** To display brief information for the VRF instance red, use the command:

```
awplus# show ip vrf red
```

**Output** Figure 34-19: Example output from the show ip vrf red command

| Name | Default RD | Interfaces |
|------|------------|------------|
| red  | 500:1      | lo1, vlan1 |

**Related Commands** [show ip vrf interface](#)

**Command changes** Version 5.4.6-2.1: VRF-lite support added.

# show ip vrf detail

**Overview** This command displays the detailed configuration for a specific VRF instance.

**Syntax** `show ip vrf detail <vrf-name>`

| Parameter                     | Description                   |
|-------------------------------|-------------------------------|
| <code>&lt;vrf-name&gt;</code> | The name of the VRF instance. |

**Mode** User Exec and Privileged Exec

**Example** To display the detailed information for all VRF instances, use the command:

```
awplus# show ip vrf detail
```

**Output** Figure 34-20: Example output from the **show ip detail** command, for all VRF instances

```
VRF blue; Description: VRF for customer blue
FIB ID 3; Router ID: 192.168.30.1 (automatic)
Default RD 500:3
 Interfaces:
 lo3, vlan3
 Export route-target communities
 RT: 500:3
 Import route-target communities
 RT: 500:4
 Import route-map: blue45
 No export route-map

VRF red
FIB ID 1; Router ID: 192.168.10.1 (automatic)
Default RD 500:1
 Interfaces:
 lo1, vlan1
 Export route-target communities
 RT: 500:1
 Import route-target communities
 RT: 500:1
 Import route-map: red43
 No export route-map
```

**Related Commands** [show ip vrf](#)

**Command changes** Version 5.4.6-2.1: VRF-lite support added.

# show ip vrf interface

**Overview** This command displays protocol, operational status, and address information, for interfaces existing within either a specified VRF instance, or all VRF instances.

**Syntax** `show ip vrf interface <vrf-name>`

| Parameter  | Description                   |
|------------|-------------------------------|
| <vrf-name> | The name of the VRF instance. |

**Mode** User Exec and Privileged Exec

**Example** To display all interfaces and IP addresses associated with all VRF instances, use the command:

```
awplus# show ip vrf interface
```

**Output** Figure 34-21: Example output from the **show ip vrf interface** command

| Interface | IP-Address      | Status   | Protocol | Vrf   |
|-----------|-----------------|----------|----------|-------|
| lo1       | unassigned      | admin up | running  | red   |
| lo2       | unassigned      | admin up | running  | green |
| vlan1     | 192.168.10.1/24 | admin up | running  | red   |
| vlan2     | 192.168.20.1/24 | admin up | running  | green |

**Example** To display all interfaces and IP addresses associated with the VRF instance `red`, use the command:

```
awplus# show ip vrf interface red
```

**Output** Figure 34-22: Example output from the **show ip vrf interface red** command

| Interface | IP-Address      | Status   | Protocol | Vrf |
|-----------|-----------------|----------|----------|-----|
| lo1       | unassigned      | admin up | running  | red |
| vlan1     | 192.168.10.1/24 | admin up | running  | red |

**Related Commands** [show ip vrf](#)

**Command changes** Version 5.4.6-2.1: VRF-lite support added.

# show running-config vrf

**Overview** This command displays the running system VRF-related configurations for all VRF instances.

**Syntax** `show running-config vrf`

**Mode** Privileged Exec

**Example** To display the running system VRF-related configurations, use the command:

```
awplus# show running-config vrf
```

**Output** Figure 34-23: Example output from the **show running config vrf** command

```
ip vrf red
rd 500:1
route-target export 500:1
route-target export 500:4
import map red 43
!
```

**Related  
Commands** [show ip vrf](#)

# ssh

**Overview** This command initiates a Secure Shell connection to a remote SSH server.

If the server requests a password for the user login, the user needs to type in the correct password on "Password:" prompt.

SSH client identifies the remote SSH server by its public key registered on the client device. If the server identification is changed, server verification fails. If the public key of the server has been changed, the public key of the server must be explicitly added to the known host database.

**NOTE:** Note that a hostname specified with SSH cannot begin with a hyphen (-) character.

**Syntax** `ssh [ip|ipv6][[user <username>]|[port <1-65535>]|[version {1|2}]] <hostname> [<line>]`

**Syntax (VRF-lite)** `ssh [vrf <vrf-name>] [ip|ipv6][[user <username>]|[port <1-65535>]|[version {1|2}]] <hostname> [<line>]`

| Parameter  | Description                                                                                                                                                                                                                                                                                                               |
|------------|---------------------------------------------------------------------------------------------------------------------------------------------------------------------------------------------------------------------------------------------------------------------------------------------------------------------------|
| vrf        | Apply the command to the specified VRF instance.                                                                                                                                                                                                                                                                          |
| <vrf-name> | The name of the VRF instance.                                                                                                                                                                                                                                                                                             |
| ip         | Specify IPv4 SSH.                                                                                                                                                                                                                                                                                                         |
| ipv6       | Specify IPv6 SSH.                                                                                                                                                                                                                                                                                                         |
| user       | Login user. If user is specified, the username is used for login to the remote SSH server when user authentication is required. Otherwise the current user name is used.<br><br><username> User name to login on the remote server.                                                                                       |
| port       | SSH server port. If port is specified, the SSH client connects to the remote SSH server with the specified TCP port. Other- wise, the client port configured by "ssh client" command or the default TCP port (22) is used.<br><br><1-65535> TCP port.                                                                     |
| version    | SSH client version. If version is specified, the SSH client supports only the specified SSH version. By default, SSH client uses SSHv2 first. If the server does not support SSHv2, it will try SSHv1. The default version can be configured by "ssh client" command.<br><br>1 Use SSH version 1.<br>2 Use SSH version 2. |



| Parameter                     | Description                                                                                                                                                                                                                                  |
|-------------------------------|----------------------------------------------------------------------------------------------------------------------------------------------------------------------------------------------------------------------------------------------|
| <code>&lt;hostname&gt;</code> | IPv4/IPv6 address or hostname of a remote server. The address is in the format A.B.C.D for an IPv4 address, or in the format X:X::X:X for an IPv6 address. Note that a hostname specified with SSH cannot begin with a hyphen (-) character. |
| <code>&lt;line&gt;</code>     | A command to execute on the remote server. If a command is specified, the command is executed on the remote SSH server and the session is disconnected when the remote command finishes.                                                     |

**Mode** User Exec and Privileged Exec

**Examples** To login to the remote SSH server at 192.0.2.5, use the command:

```
awplus# ssh ip 192.0.2.5
```

To login to the remote SSH server at 192.0.2.5 as user "manager", use the command:

```
awplus# ssh ip user manager 192.0.2.5
```

To login to the remote SSH server at 192.0.2.5 that is listening TCP port 2000, use the command:

```
awplus# ssh port 2000 192.0.2.5
```

To login to the remote SSH server with example\_host using IPv6 session, use the command:

```
awplus# ssh ipv6 example_host
```

To run the **cmd** command on the remote SSH server at 192.0.2.5, use the command:

```
awplus# ssh ip 192.0.2.5 cmd
```

**Example (VRF-lite)** To login to the remote SSH server at 192.168.1.1 on VRF "red", use the command:

```
awplus# ssh vrf red 192.168.1.1
```

**Related Commands**

- [crypto key generate userkey](#)
- [crypto key pubkey-chain knownhosts](#)
- [debug ssh client](#)
- [ssh client](#)

**Command changes** Version 5.4.6-2.1: VRF-lite support added.

# tcpdump

**Overview** Use this command to start a tcpdump, which gives the same output as the Unix-like **tcpdump** command to display TCP/IP traffic. Press <ctrl> + c to stop a running tcpdump.

**Syntax** `tcpdump <line>`

**Syntax (VRF-lite)** `tcpdump [vrf <vrf-name>] <line>`

| Parameter  | Description                                                                                                                                                                          |
|------------|--------------------------------------------------------------------------------------------------------------------------------------------------------------------------------------|
| <line>     | Specify the dump options. For more information on the options for this placeholder see <a href="http://www.tcpdump.org/tcpdump_man.html">http://www.tcpdump.org/tcpdump_man.html</a> |
| vrf        | Apply the command to the specified VRF instance.                                                                                                                                     |
| <vrf-name> | The name of the VRF instance.                                                                                                                                                        |

**Mode** Privileged Exec

**Example** To start a tcpdump running to capture IP packets, enter the command:

```
awplus# tcpdump ip
```

**Example (VRF-lite)** To start a tcpdump on interface vlan2 associated with a VRF instance red, enter the command:

```
awplus# tcpdump vrf red vlan2
```

**Output** Figure 34-24: Example output from the **tcpdump** command

```
03:40:33.221337 IP 192.168.1.1 > 224.0.0.13: PIMv2, Hello,
length: 34
1 packets captured
2 packets received by filter
0 packets dropped by kernel
```

**Related Commands** [debug ip packet interface](#)

**Command changes** Version 5.4.6-2.1: VRF-lite support added.

# telnet

**Overview** Use this command to open a telnet session to a remote device.

**Syntax** `telnet {<hostname>|[ip] <ipv4-addr>|[ipv6] <ipv6-addr>} [  
<port>]`

**Syntax (VRF-lite)** `telnet [vrf <vrf-name>] {<hostname>|[ip] <ipv4-addr>|[ipv6] <ipv6-addr>} [  
<port>]`

| Parameter   | Description                                                                                                                               |
|-------------|-------------------------------------------------------------------------------------------------------------------------------------------|
| vrf         | Apply this command to a VRF instance.                                                                                                     |
| <vrf-name>  | The name of the VRF instance.                                                                                                             |
| <hostname>  | The host name of the remote system.                                                                                                       |
| ip          | Keyword used to specify the IPv4 address or host name of a remote system.                                                                 |
| <ipv4-addr> | An IPv4 address of the remote system.                                                                                                     |
| ipv6        | Keyword used to specify the IPv6 address of a remote system                                                                               |
| <ipv6-addr> | Placeholder for an IPv6 address in the format x:x::x:x, for example, 2001:db8::8a2e:7334                                                  |
| <port>      | Specify a TCP port number (well known ports are in the range 1-1023, registered ports are 1024-49151, and private ports are 49152-65535). |

**Mode** User Exec and Privileged Exec

**Examples** To connect to TCP port 2602 on the device at 10.2.2.2, use the command:

```
awplus# telnet 10.2.2.2 2602
```

To connect to the telnet server `host.example`, use the command:

```
awplus# telnet host.example
```

To connect to the telnet server `host.example` on TCP port 100, use the command:

```
awplus# telnet host.example 100
```

**Example (VRF-lite)** To open a telnet session to a remote host 192.168.0.1 associated with VRF instance `red`, use the command:

```
awplus# telnet vrf red ip 192.168.0.1
```

**Command changes** Version 5.4.6-2.1: VRF-lite support added.

# timers (RIP)

**Overview** Use this command to adjust routing network timers.  
Use the **no** variant of this command to restore the defaults.

**Syntax** `timers basic <update> <timeout> <garbage>`  
`no timers basic`

| Parameter                    | Description                                                                                                                                                                                                                          |
|------------------------------|--------------------------------------------------------------------------------------------------------------------------------------------------------------------------------------------------------------------------------------|
| <code>&lt;update&gt;</code>  | <code>&lt;5-2147483647&gt;</code><br>Specifies the period at which RIP route update packets are transmitted. The default is 30 seconds.                                                                                              |
| <code>&lt;timeout&gt;</code> | <code>&lt;5-2147483647&gt;</code><br>Specifies the routing information timeout timer in seconds. The default is 180 seconds. After this interval has elapsed and no updates for a route are received, the route is declared invalid. |
| <code>&lt;garbage&gt;</code> | <code>&lt;5-2147483647&gt;</code><br>Specifies the routing garbage collection timer in seconds. The default is 120 seconds.                                                                                                          |

**Default** Enabled

**Mode** RIP Router Configuration or RIP Router Address Family Configuration for a VRF instance.

**Usage** This command adjusts the RIP timing parameters.

The update timer is the time between sending out updates, that contain the complete routing table, to every neighboring router.

If an update for a given route has not been seen for the time specified by the timeout parameter, that route is no longer valid. However, it is retained in the routing table for a short time, with metric 16, so that neighbors are notified that the route has been dropped.

When the time specified by the garbage parameter expires the metric 16 route is finally removed from the routing table. Until the garbage time expires, the route is included in all updates sent by the router.

All the routers in the network must have the same timers to ensure the smooth operation of RIP throughout the network.

**Examples** To set the update timer to 30, the routing information timeout timer to 180, and the routing garbage collection timer to 120, use the following command:

```
awplus# configure terminal
awplus(config)# router rip
awplus(config-router)# timers basic 30 180 120
```

To set the update timer to 30, the routing information timeout timer to 180, and the routing garbage collection timer to 120 with VRF, use the following command:

```
awplus# configure terminal
awplus(config)# router rip
awplus(config-router)# address-family ipv4 vrf blue
awplus(config-router-af)# timers basic 30 180 120
```

**Command changes** Version 5.4.6-2.1: VRF-lite support added.

# traceroute

**Overview** Use this command to trace the route to the specified IPv4 host.

**Syntax** `traceroute {<ip-addr>|<hostname>}`

**Syntax (VRF-lite)** `traceroute [vrf <vrf-name>] {<ip-addr>|<hostname>}`

| Parameter                     | Description                                                             |
|-------------------------------|-------------------------------------------------------------------------|
| <code>&lt;ip-addr&gt;</code>  | The destination IPv4 address. The IPv4 address uses the format A.B.C.D. |
| <code>&lt;hostname&gt;</code> | The destination hostname.                                               |
| <code>vrf</code>              | Apply the command to the specified VRF instance.                        |
| <code>&lt;vrf-name&gt;</code> | The name of the VRF instance.                                           |

**Mode** User Exec and Privileged Exec

**Example** `awplus# traceroute 10.10.0.5`

**Example (VRF-lite)** `awplus# traceroute vrf red 192.168.0.1`

**Command changes** Version 5.4.6-2.1: VRF-lite support added.

# version (RIP)

**Overview** Use this command to specify a RIP version used globally by the router.

If VRF-lite is configured, you can specify a RIP version either globally, or for a particular VRF instance.

Use the **no** variant of this command to restore the default version.

**Syntax** `version {1|2}`  
`no version`

| Parameter | Description                              |
|-----------|------------------------------------------|
| 1 2       | Specifies the version of RIP processing. |

**Default** Version 2

**Mode** RIP Router Configuration or RIP Router Address Family Configuration for a VRF instance.

**Usage** RIP can be run in version 1 or version 2 mode. Version 2 has more features than version 1; in particular RIP version 2 supports authentication and classless routing. Once the RIP version is set, RIP packets of that version will be received and sent on all the RIP-enabled interfaces.

Setting the version command has no impact on receiving updates, only on sending them. The `ip rip send version` command overrides the value set by the `version (RIP)` command on an interface-specific basis. The `ip rip receive version` command allows you to configure a specific interface to accept only packets of the specified RIP version. The `ip rip receive version` command and the `ip rip send version` command override the value set by this command.

**Examples** To specify a RIP version, use the following commands:

```
awplus# configure terminal
awplus(config)# router rip
awplus(config-router)# version 1
```

To specify a RIP version with VRF, use the following commands:

```
awplus# configure terminal
awplus(config)# router rip
awplus(config-router)# address-family ipv4 vrf blue
awplus(config-router-af)# version 1
```

**Related Commands** [ip rip receive version](#)  
[ip rip send version](#)  
[show running-config](#)

**Command changes** Version 5.4.6-2.1: VRF-lite support added.



# Part 4: Multicast Applications

# 35

# IGMP and IGMP Snooping Commands

## Introduction

**Overview** Devices running AlliedWare Plus use IGMP (Internet Group Management Protocol) and MLD (Multicast Listener Discovery) to track which multicast groups their clients belong to. This enables them to send the correct multimedia streams to the correct destinations. IGMP is used for IPv4 multicasting, and MLD is used for IPv6 multicasting.

This chapter describes the commands to configure IGMP Querier behaviour and selection, IGMP Snooping and IGMP Proxy.

- Command List**
- [“clear ip igmp”](#) on page 1580
  - [“clear ip igmp group”](#) on page 1581
  - [“clear ip igmp interface”](#) on page 1582
  - [“debug igmp”](#) on page 1583
  - [“ip igmp”](#) on page 1584
  - [“ip igmp flood specific-query”](#) on page 1585
  - [“ip igmp last-member-query-count”](#) on page 1586
  - [“ip igmp last-member-query-interval”](#) on page 1587
  - [“ip igmp maximum-groups”](#) on page 1588
  - [“ip igmp mroute-proxy”](#) on page 1590
  - [“ip igmp proxy-service”](#) on page 1591
  - [“ip igmp querier-timeout”](#) on page 1592
  - [“ip igmp query-holdtime”](#) on page 1593
  - [“ip igmp query-interval”](#) on page 1595
  - [“ip igmp query-max-response-time”](#) on page 1597
  - [“ip igmp ra-option”](#) on page 1599

- [“ip igmp robustness-variable”](#) on page 1600
- [“ip igmp snooping”](#) on page 1601
- [“ip igmp snooping fast-leave”](#) on page 1602
- [“ip igmp snooping mrouter”](#) on page 1603
- [“ip igmp snooping querier”](#) on page 1604
- [“ip igmp snooping report-suppression”](#) on page 1605
- [“ip igmp snooping routermode”](#) on page 1606
- [“ip igmp snooping source-timeout”](#) on page 1608
- [“ip igmp snooping tcn query solicit”](#) on page 1609
- [“ip igmp source-address-check”](#) on page 1611
- [“ip igmp startup-query-count”](#) on page 1612
- [“ip igmp startup-query-interval”](#) on page 1613
- [“ip igmp trusted”](#) on page 1614
- [“ip igmp version”](#) on page 1615
- [“show debugging igmp”](#) on page 1616
- [“show ip igmp groups”](#) on page 1617
- [“show ip igmp interface”](#) on page 1619
- [“show ip igmp proxy”](#) on page 1621
- [“show ip igmp snooping mrouter”](#) on page 1622
- [“show ip igmp snooping routermode”](#) on page 1623
- [“show ip igmp snooping source-timeout”](#) on page 1624
- [“show ip igmp snooping statistics”](#) on page 1625
- [“undebug igmp”](#) on page 1627

# clear ip igmp

**Overview** Use this command to clear all IGMP group membership records on all VLAN interfaces.

**Syntax** `clear ip igmp`

**Mode** Privileged Exec

**Example** `awplus# clear ip igmp`

**Related  
Commands**

- `clear ip igmp group`
- `clear ip igmp interface`
- `show ip igmp interface`
- `show running-config`

# clear ip igmp group

**Overview** Use this command to clear IGMP group membership records for a specific group on either all interfaces, a single interface, or for a range of interfaces.

**Syntax** `clear ip igmp group *`  
`clear ip igmp group <ip-address> <interface>`

| Parameter    | Description                                                                                                    |
|--------------|----------------------------------------------------------------------------------------------------------------|
| *            | Clears all groups on all interfaces. This has the same effect as the <b>clear ip igmp</b> command.             |
| <ip-address> | Specifies the group whose membership records will be cleared from all interfaces, entered in the form A.B.C.D. |
| <interface>  | Specifies the name of the interface; all groups learned on this interface are deleted.                         |

**Mode** Privileged Exec

**Usage** This command applies to groups learned by IGMP or IGMP Snooping. In addition to the group, an interface can be specified. Specifying this will mean that only entries with the group learned on the interface will be deleted.

**Examples** To delete all group records, use the command:

```
awplus# clear ip igmp group *
```

To delete records for 224.1.1.1 on vlan1, use the command:

```
awplus# clear ip igmp group 224.1.1.1 vlan1
```

**Related Commands**

- [clear ip igmp](#)
- [clear ip igmp interface](#)
- [show ip igmp interface](#)
- [show running-config](#)

# clear ip igmp interface

**Overview** Use this command to clear IGMP group membership records on a particular interface.

**Syntax** `clear ip igmp interface <interface>`

| Parameter                      | Description                                                                            |
|--------------------------------|----------------------------------------------------------------------------------------|
| <code>&lt;interface&gt;</code> | Specifies the name of the interface. All groups learned on this interface are deleted. |

**Mode** Privileged Exec

**Usage** This command applies to interfaces configured for IGMP or IGMP Snooping.

**Example** To delete records for vlan1, use the command:

```
awplus# clear ip igmp interface vlan1
```

**Related Commands**

- [clear ip igmp](#)
- [clear ip igmp group](#)
- [show ip igmp interface](#)
- [show running-config](#)

# debug igmp

**Overview** Use this command to enable debugging of either all IGMP or a specific component of IGMP.

Use the **no** variant of this command to disable all IGMP debugging, or debugging of a specific component of IGMP.

**Syntax** `debug igmp {all|decode|encode|events|fsm|tib}`  
`no debug igmp {all|decode|encode|events|fsm|tib}`

| Parameter | Description                                   |
|-----------|-----------------------------------------------|
| all       | Enable or disable all debug options for IGMP  |
| decode    | Debug of IGMP packets that have been received |
| encode    | Debug of IGMP packets that have been sent     |
| events    | Debug IGMP events                             |
| fsm       | Debug IGMP Finite State Machine (FSM)         |
| tib       | Debug IGMP Tree Information Base (TIB)        |

**Modes** Privileged Exec and Global Configuration

**Example** `awplus# configure terminal`  
`awplus(config)# debug igmp all`

**Related Commands** [show debugging igmp](#)  
[undebug igmp](#)

# ip igmp

**Overview** Use this command to enable IGMP on an interface. The command configures the device as an IGMP querier.

Use the **no** variant of this command to return all IGMP related configuration to the default on this interface.

**Syntax** ip igmp  
no ip igmp

**Default** Disabled

**Mode** Interface Configuration for a VLAN or Eth interface.

**Usage** An IP address must be assigned to the interface first, before this command will work.

**Example** To specify an interface as an IGMP querier, use the commands:

```
awplus# configure terminal
awplus(config)# interface vlan2
awplus(config-if)# ip igmp
```

**Validation  
Commands** show ip igmp interface  
show running-config



# ip igmp flood specific-query

**Overview** Use this command if you want IGMP to flood specific queries to all VLAN member ports, instead of only sending the queries to multicast group member ports.

Use the **no** variant of this command if you want IGMP to only send the queries to multicast group member ports.

**Syntax** `ip igmp flood specific-query`  
`no ip igmp flood specific-query`

**Default** By default, specific queries are flooded to all VLAN member ports.

**Mode** Global Configuration

**Usage** In an L2 switched network running IGMP, it is considered more robust to flood all specific queries. In most cases, the benefit of flooding specific queries to all VLAN member ports outweighs the disadvantages.

However, sometimes this is not the case. For example, if hosts with very low CPU capability receive specific queries for multicast groups they are not members of, their performance may degrade unacceptably. In this situation, it is desirable for IGMP to send specific queries to known member ports only. This minimizes the performance degradation of such hosts. In those circumstances, use this command to turn off flooding of specific queries.

**Example** To cause IGMP to flood specific queries only to multicast group member ports, use the commands:

```
awplus# configure terminal
awplus(config)# no ip igmp flood specific-query
```

**Related Commands** [show ip igmp interface](#)

# ip igmp last-member-query-count

**Overview** Use this command to set the last-member query-count value for an interface.  
Use the **no** variant of this command to return to the default on an interface.

**Syntax** `ip igmp last-member-query-count <2-7>`  
`no ip igmp last-member-query-count`

| Parameter | Description                    |
|-----------|--------------------------------|
| <2-7>     | Last member query count value. |

**Default** The default last member query count value is 2.

**Mode** Interface Configuration for a VLAN or Eth interface.

**Usage** This command applies to Eth interfaces configured for IGMP and VLAN interfaces configured for IGMP or IGMP Snooping.

**Example** To set the last-member query-count to 3 on vlan2, use the commands:

```
awplus# configure terminal
awplus(config)# interface vlan2
awplus(config-if)# ip igmp last-member-query-count 3
```

**Related Commands** [ip igmp last-member-query-interval](#)  
[ip igmp startup-query-count](#)  
[show ip igmp interface](#)  
[show running-config](#)

# ip igmp last-member-query-interval

**Overview** Use this command to configure the frequency at which the router sends IGMP group specific host query messages.

Use the **no** variant of this command to set this frequency to the default.

**Syntax** `ip igmp last-member-query-interval <interval>`  
`no ip igmp last-member-query-interval`

| Parameter                     | Description                                                                                                       |
|-------------------------------|-------------------------------------------------------------------------------------------------------------------|
| <code>&lt;interval&gt;</code> | The frequency in milliseconds at which IGMP group-specific host query messages are sent, in the range 1000-25500. |

**Default** 1000 milliseconds

**Mode** Interface Configuration for a VLAN or Eth interface.

**Usage** This command applies to Eth interfaces configured for IGMP and VLAN interfaces configured for IGMP or IGMP Snooping.

**Example** To change the IGMP group-specific host query message interval to 2 seconds (2000 milliseconds) on vlan2, use the commands:

```
awplus# configure terminal
awplus(config)# interface vlan2
awplus(config-if)# ip igmp last-member-query-interval 2000
```

**Related Commands** [ip igmp last-member-query-count](#)  
[show ip igmp interface](#)  
[show running-config](#)

# ip igmp maximum-groups

**Overview** Use this command to set a limit, per switch port, on the number of IGMP groups clients can join. This stops a single client from using all the switch's available group-entry resources, and ensures that clients on all ports have a chance to join IGMP groups.

Use the **no** variant of this command to remove the limit.

**Syntax** `ip igmp maximum-groups <0-65535>`  
`no ip igmp maximum-groups`

| Parameter                    | Description                                                                               |
|------------------------------|-------------------------------------------------------------------------------------------|
| <code>&lt;0-65535&gt;</code> | The maximum number of IGMP groups clients can join on this switch port. 0 means no limit. |

**Default** The default is 0, which means no limit

**Mode** Interface mode for a switch port

**Usage** We recommend using this command with IGMP snooping fast leave on the relevant VLANs. To enable fast leave, use the command:

```
awplus(config-if)# ip igmp snooping fast-leave
```

The device keeps count of the number of groups learned by each port. This counter is incremented when group joins are received via IGMP reports. It is decremented when:

- Group memberships time out
- Group leaves are received via leave messages or reports

Also, the port's group counter is cleared when:

- The port goes down
- You run the command **clear ip igmp group \***
- The port is removed from a VLAN

You can see the current value of the group counter by using either of the commands:

```
awplus# show ip igmp snooping statistics interface <port-list>
```

```
awplus# show ip igmp interface <port>
```

**Example** To limit clients to 10 groups on port 1.0.1, which is in vlan1, use the commands:

```
awplus# configure terminal
awplus(config)# interface port1.0.1
awplus(config-if)# ip igmp maximum-groups 10
awplus(config-if)# exit
awplus(config)# interface vlan1
awplus(config-if)# ip igmp snooping fast-leave
```

**Related  
Commands**

- clear ip igmp group
- ip igmp snooping fast-leave
- show ip igmp interface
- show ip igmp snooping statistics

# ip igmp mroute-proxy

**Overview** Use this command to enable IGMP mroute proxy on this downstream interface and associate it with the upstream proxy service interface.

Use the **no** variant of this command to remove the association with the proxy-service interface.

**Syntax** `ip igmp mroute-proxy <interface>`  
`no ip igmp mroute-proxy`

| Parameter                      | Description                |
|--------------------------------|----------------------------|
| <code>&lt;interface&gt;</code> | The name of the interface. |

**Mode** Interface Configuration for a VLAN or Eth interface.

**Usage** This command applies to Eth interfaces and VLAN interfaces configured for IGMP Proxy.

You must also enable the IGMP proxy service on the upstream interface, using the [ip igmp proxy-service](#) command. You can associate one or more downstream mroute proxy interfaces on the device with a single upstream proxy service interface. This downstream mroute proxy interface listens for IGMP reports, and forwards them to the upstream IGMP proxy service interface.

IGMP Proxy does not work with other multicast routing protocols, such as PIM-SM or PIM-DM.

**Example** To configure vlan2 as the upstream proxy-service interface for the downstream vlan3 interface, use the commands:

```
awplus# configure terminal
awplus(config)# interface vlan3
awplus(config-if)# ip igmp mroute-proxy vlan2
```

**Related Commands** [ip igmp proxy-service](#)

# ip igmp proxy-service

**Overview** Use this command to enable the VLAN interface to be the upstream IGMP proxy-service interface for the device. All associated downstream IGMP mroute proxy interfaces on this device will have their memberships consolidated on this proxy service interface, according to IGMP host-side functionality.

Use the **no** variant of this command to remove the designation of the VLAN interface as an upstream proxy-service interface.

**Syntax** `ip igmp proxy-service`  
`no ip igmp proxy-service`

**Mode** Interface Configuration for a VLAN or Eth interface.

**Usage** This command applies to Eth interfaces and VLAN interfaces configured for IGMP Proxy.

This command is used with the [ip igmp mroute-proxy](#) command to enable forwarding of IGMP reports to a proxy service interface for all forwarding entries for this interface. You must also enable the downstream IGMP mroute proxy interfaces on this device using the command [ip igmp mroute-proxy](#).

IGMP Proxy does not work with other multicast routing protocols, such as PIM-SM or PIM-DM.

From version 5.4.7-1.1 onwards, IGMP mroute proxy interfaces do not have to be configured with an IP address before they can operate. Instead, it is possible to have an address-less interface operate as an IGMP mroute proxy interface.

This feature is useful when IGMP Proxy needs to run on many downstream interfaces. For example, you may want to use it if your device has one subscriber (multicast receiver) per VLAN, and many receivers (many VLANs) connected to the device. In such a situation, assigning IP addresses to each VLAN may not be practicable.

Note that for such interface to be able to send queries to hosts directly attached to the interface, it is necessary to enable IGMP snooping querier on the interface, using the command [ip igmp snooping querier](#).

**Example** To designate VLAN1 as the upstream proxy-service interface, use the commands:

```
awplus# configure terminal
awplus(config)# interface vlan1
awplus(config-if)# ip igmp proxy-service
```

**Related Commands** [ip igmp mroute-proxy](#)  
[ip igmp snooping querier](#)

**Command changes** Version 5.4.7-1.1: Address-less interface support added.

# ip igmp querier-timeout

**Overview** Use this command to configure the timeout period before the device takes over as the querier for the interface after the previous querier has stopped querying.

Use the **no** variant of this command to restore the default.

**Syntax** `ip igmp querier-timeout <timeout>`  
`no ip igmp querier-timeout`

| Parameter                    | Description                                                           |
|------------------------------|-----------------------------------------------------------------------|
| <code>&lt;timeout&gt;</code> | IGMP querier timeout interval value in seconds, in the range 1-65535. |

**Default** The default timeout interval is 255 seconds.

**Mode** Interface Configuration for a VLAN or Eth interface.

**Usage** This command applies to Eth and VLAN interfaces configured for IGMP.

The timeout value should not be less than the current active querier's general query interval.

**Example** To configure the device to wait 130 seconds from the time it received the last query before it takes over as the querier for vlan2, use the commands:

```
awplus# configure terminal
awplus(config)# interface vlan2
awplus(config-if)# ip igmp querier-timeout 130
```

**Related Commands** `ip igmp query-interval`  
`show ip igmp interface`  
`show running-config`



# ip igmp query-holdtime

**Overview** This command sets the time that an IGMP Querier waits after receiving a query solicitation before it sends an IGMP Query. IGMP General Query messages will not be sent during the hold time interval.

Use the **no** variant of this command to return to the default query hold time period.

**Syntax** `ip igmp query-holdtime <interval>`  
`no ip igmp query-holdtime`

| Parameter  | Description                                                    |
|------------|----------------------------------------------------------------|
| <interval> | Query interval value in milliseconds, in the range <100-5000>. |

**Default** By default the delay before sending IGMP General Query messages is 500 milliseconds.

**Mode** Interface Configuration for a VLAN or Eth interface.

**Usage** Use this command to configure a value for the IGMP query hold time in the current network. IGMP Queries can be generated after receiving Query Solicitation (QS) packets and there is a possibility of a DoS (Denial of Service) attack if a stream of Query Solicitation (QS) packets are sent to the IGMP Querier, eliciting a rapid stream of IGMP Queries. This command applies to interfaces on which the device is acting as an IGMP Querier.

Use the `ip igmp query-interval` command when a delay for IGMP general query messages is required and IGMP general query messages are required. The **ip igmp query-holdtime** command stops IGMP query messages during the configured holdtime interval, so the rate of IGMP Queries that can be sent out of an interface can be restricted.

See the [IGMP Feature Overview and Configuration Guide](#) for introductory information about the Query Solicitation feature.

**Examples** To set the IGMP query holdtime to 900 ms for vlan20, use the following commands:

```
awplus# configure terminal
awplus(config)# interface vlan20
awplus(config-if)# ip igmp query-holdtime 900
```

To reset the IGMP query holdtime to the default (500 ms) for vlan10, use the following commands:

```
awplus# configure terminal
awplus(config)# interface vlan10
awplus(config-if)# no ip igmp query-holdtime
```

**Related  
Commands**

- ip igmp query-interval
- ip igmp snooping tcn query solicit
- show ip igmp interface
- show running-config

# ip igmp query-interval

**Overview** Use this command to configure the period for sending IGMP General Query messages.

The IGMP query interval specifies the time between IGMP General Query messages being sent.

Use the **no** variant of this command to return to the default query interval period.

**NOTE:** The IGMP query interval must be greater than IGMP query maximum response time.

**Syntax** `ip igmp query-interval <interval>`  
`no ip igmp query-interval`

| Parameter  | Description                                              |
|------------|----------------------------------------------------------|
| <interval> | Query interval value in seconds, in the range <2-18000>. |

**Default** The default IGMP query interval is 125 seconds.

**Mode** Interface Configuration for a VLAN or Eth interface.

**Usage** This command applies to interfaces configured for IGMP. Note that the IGMP query interval is automatically set to a greater value than the IGMP query max response time.

For example, if you set the IGMP query max response time to 2 seconds using the [ip igmp query-max-response-time](#) command, and the IGMP query interval is currently less than 3 seconds, then the IGMP query interval period will be automatically reconfigured to be 3 seconds, so it is greater than the IGMP query maximum response time.

Use the **ip igmp query-interval** command when a non-default interval for IGMP General Query messages is required.

The [ip igmp query-holdtime](#) command can occasionally delay the sending of IGMP Queries.

**Examples** To set the period between IGMP host-query messages to 3 minutes (180 seconds) for vlan20, use the following commands:

```
awplus# configure terminal
awplus(config)# interface vlan20
awplus(config-if)# ip igmp query-interval 180
```

To reset the period between sending IGMP host-query messages to the default (125 seconds) for vlan10, use the following commands:

```
awplus# configure terminal
awplus(config)# interface vlan10
awplus(config-if)# no ip igmp query-interval
```

**Related  
Commands**

[ip igmp query-holdtime](#)  
[ip igmp query-max-response-time](#)  
[ip igmp startup-query-interval](#)  
[show ip igmp interface](#)  
[show running-config](#)

# ip igmp query-max-response-time

**Overview** Use this command to configure the maximum response time advertised in IGMP Queries.

Use the **no** variant of this command to restore the default.

**NOTE:** The IGMP query maximum response time must be less than the IGMP query interval.

**Syntax** `ip igmp query-max-response-time <response-time>`  
`no ip igmp query-max-response-time`

| Parameter                          | Description                                          |
|------------------------------------|------------------------------------------------------|
| <code>&lt;response-time&gt;</code> | Response time value in seconds, in the range 1-3180. |

**Default** The default IGMP query maximum response time is 10 seconds.

**Mode** Interface Configuration for a VLAN or Eth interface.

**Usage** This command applies to interfaces configured for IGMP.

Note that the IGMP query interval is automatically set to a greater value than the IGMP query maximum response time.

For example, if you set the IGMP query interval to 3 seconds using the `ip igmp query-interval` command, and the current IGMP query interval is less than 3 seconds, then the IGMP query maximum response time will be automatically reconfigured to be 2 seconds, so it is less than the IGMP query interval time.

To get the network to converge faster, use the **ip igmp query-max-response-time** command and set a low response time value, such as one or two seconds, so that the clients will respond immediately with a report as a response to the IGMP Queries.

**Examples** To set a maximum response time of 8 seconds for vlan20, use the following commands:

```
awplus# configure terminal
awplus(config)# interface vlan20
awplus(config-if)# ip igmp query-max-response-time 8
```

To reset the default maximum response time to the default (10 seconds) for vlan10, use the following commands:

```
awplus# configure terminal
awplus(config)# interface vlan10
awplus(config-if)# no ip igmp query-max-response-time
```

**Related  
Commands** ip igmp query-interval  
show ip igmp interface  
show running-config

## ip igmp ra-option

**Overview** Use this command to enable strict Router Alert (RA) option validation. With strict RA option enabled, IGMP packets without RA options are ignored.

Use the **no** variant of this command to disable strict RA option validation.

**Syntax** `ip igmp ra-option`  
`no ip igmp ra-option`

**Default** The default state of RA validation is unset.

**Mode** Interface Configuration for a VLAN or Eth interface.

**Usage** This command applies to interfaces configured for IGMP and IGMP Snooping.

**Examples** To enable strict Router Alert (RA) option validation on vlan20, use the following commands:

```
awplus# configure terminal
awplus(config)# interface vlan20
awplus(config-if)# ip igmp ra-option
```

# ip igmp robustness-variable

**Overview** Use this command to change the robustness variable value on an interface.  
Use the **no** variant of this command to return to the default on an interface.

**Syntax** `ip igmp robustness-variable <1-7>`  
`no ip igmp robustness-variable`

| Parameter | Description                    |
|-----------|--------------------------------|
| <1-7>     | The robustness variable value. |

**Default** The default robustness variable value is 2.

**Mode** Interface Configuration for a VLAN or Eth interface.

**Usage** This command applies to interfaces configured for IGMP and IGMP Snooping.

**Examples** To set the robustness variable to 3 on vlan20, use the following commands:

```
awplus# configure terminal
awplus(config)# interface vlan20
awplus(config-if)# ip igmp robustness-variable 3
```

**Related  
Commands** [show ip igmp interface](#)  
[show running-config](#)



# ip igmp snooping

**Overview** Use this command to enable IGMP Snooping. When this command is used in the Global Configuration mode, IGMP Snooping is enabled at the device level. When this command is used in Interface Configuration mode, IGMP Snooping is enabled for the specified VLANs.

Use the **no** variant of this command to either globally disable IGMP Snooping, or disable IGMP Snooping on a specified interface.

**NOTE:** *IGMP snooping cannot be disabled on an interface if IGMP snooping has already been disabled globally. IGMP snooping can be disabled on both an interface and globally if disabled on the interface first and then disabled globally.*

**Syntax** `ip igmp snooping`  
`no ip igmp snooping`

**Default** By default, IGMP Snooping is enabled both globally and on all VLANs.

**Mode** Global Configuration and Interface Configuration for a VLAN interface.

**Usage** For IGMP snooping to operate on particular VLAN interfaces, it must be enabled both globally by using this command in Global Configuration mode, and on individual VLAN interfaces by using this command in Interface Configuration mode (both are enabled by default.)

Both IGMP snooping and MLD snooping must be enabled globally on the device for IGMP snooping to operate. MLD snooping is also enabled by default. To enable it if it has been disabled, use the [ipv6 mld snooping](#) command in Global Configuration mode.

**Examples** To enable IGMP Snooping on vlan2, use the commands:

```
awplus# configure terminal
awplus(config)# ip igmp snooping
awplus(config)# interface vlan2
awplus(config-if)# ip igmp snooping
```

**Related Commands** [ipv6 mld snooping](#)  
[show ip igmp interface](#)  
[show running-config](#)

# ip igmp snooping fast-leave

**Overview** Use this command to enable IGMP Snooping fast-leave processing. Fast-leave processing is analogous to immediate-leave processing. The IGMP group-membership entry is removed as soon as an IGMP leave group message is received, without sending out a group-specific query.

Use the **no** variant of this command to disable fast-leave processing.

**Syntax** `ip igmp snooping fast-leave`  
`no ip igmp snooping fast-leave`

**Default** IGMP Snooping fast-leave processing is disabled.

**Mode** Interface Configuration for a VLAN interface.

**Usage** This IGMP Snooping command can only be configured on VLAN interfaces.

**Example** To enable fast-leave processing on vlan2, use the commands:

```
awplus# configure terminal
awplus(config)# interface vlan2
awplus(config-if)# ip igmp snooping fast-leave
```

**Related Commands** [show ip igmp interface](#)  
[show running-config](#)

# ip igmp snooping mrouter

**Overview** Use this command to statically configure the specified port as a multicast router port for IGMP Snooping for an interface. This command applies to interfaces configured for IGMP Snooping.

Use the **no** variant of this command to remove the static configuration of the port as a multicast router port.

**Syntax** `ip igmp snooping mrouter interface <port>`  
`no ip igmp snooping mrouter interface <port>`

| Parameter                 | Description                                                                                                                                                                |
|---------------------------|----------------------------------------------------------------------------------------------------------------------------------------------------------------------------|
| <code>&lt;port&gt;</code> | The port may be a device port (e.g. <code>port1.0.4</code> ), a static channel group (e.g. <code>sa3</code> ), or a dynamic (LACP) channel group (e.g. <code>po4</code> ). |

**Mode** Interface Configuration for a VLAN interface.

**Example** To configure `port1.0.2` statically as a multicast router interface for `vlan2`, use the commands:

```
awplus# configure terminal
awplus(config)# interface vlan2
awplus(config-if)# ip igmp snooping mrouter interface port1.0.2
```

**Related Commands** [show ip igmp snooping mrouter](#)

# ip igmp snooping querier

**Overview** Use this command to enable IGMP querier operation when no multicast routing protocol is configured. When enabled, the IGMP Snooping querier sends out periodic IGMP queries for all interfaces. This command applies to interfaces configured for IGMP Snooping.

Use the **no** variant of this command to disable IGMP querier configuration.

**Syntax** `ip igmp snooping querier`  
`no ip igmp snooping querier`

**Mode** Interface Configuration for a VLAN interface.

**Usage** The IGMP Snooping querier uses the 0.0.0.0 Source IP address because it only masquerades as a proxy IGMP querier for faster network convergence.

It does not start, or automatically cease, the IGMP Querier operation if it detects query message(s) from a multicast router.

If an IP address is assigned to a VLAN, which has IGMP querier enabled on it, then the IGMP Snooping querier uses the VLAN's IP address as the Source IP Address in IGMP queries.

The IGMP Snooping Querier will not stop sending IGMP Queries if there is another IGMP Snooping Querier in the network with a lower Source IP Address.

**NOTE:** Do not enable the IGMP Snooping Querier feature on a Layer 2 device when there is an operational IGMP Querier in the network.

**Example** To configure vlan2 as a Snooping querier, use the commands:

```
awplus# configure terminal
awplus(config)# interface vlan2
awplus(config-if)# ip igmp snooping querier
```

**Related Commands** [show ip igmp interface](#)  
[show running-config](#)

# ip igmp snooping report-suppression

**Overview** Use this command to enable report suppression for IGMP versions 1 and 2. This command applies to interfaces configured for IGMP Snooping.

Report suppression stops reports being sent to an upstream multicast router port when there are already downstream ports for this group on this interface.

Use the **no** variant of this command to disable report suppression.

**Syntax** `ip igmp snooping report-suppression`  
`no ip igmp snooping report-suppression`

**Default** Report suppression does not apply to IGMPv3, and is turned on by default for IGMPv1 and IGMPv2 reports.

**Mode** Interface Configuration for a VLAN interface.

**Example** To enable report suppression for IGMPv2 reports for vlan2, use the commands:

```
awplus# configure terminal
awplus(config)# interface vlan2
awplus(config-if)# ip igmp version 2
awplus(config-if)# ip igmp snooping report-suppression
```

**Related Commands** [show ip igmp interface](#)  
[show running-config](#)

# ip igmp snooping routermode

**Overview** Use this command to set the destination IP addresses as router multicast addresses.

Use the **no** variant of this command to set it to the default. You can also remove a specified IP address from a custom list of multicast addresses.

**Syntax** ip igmp snooping routermode  
{all|default|ip|multicastrouter|address <ip-address>}  
no ip igmp snooping routermode [address <ip-address>]

| Parameter            | Description                                                                                                                                                                                           |
|----------------------|-------------------------------------------------------------------------------------------------------------------------------------------------------------------------------------------------------|
| all                  | All reserved multicast addresses (224.0.0.x). Packets from all possible addresses in range 224.0.0.x are treated as coming from routers.                                                              |
| default              | Default set of reserved multicast addresses. Packets from 224.0.0.1, 224.0.0.2, 224.0.0.4, 224.0.0.5, 224.0.0.6, 224.0.0.9, 224.0.0.13, 224.0.0.15 and 224.0.0.24 are treated as coming from routers. |
| ip                   | Custom reserved multicast addresses. Packets from custom IP address in the 224.0.0.x range are treated as coming from routers.                                                                        |
| multicastrouter      | Packets from DVMRP (224.0.0.4) and PIM (224.0.0.13) multicast addresses are treated as coming from routers.                                                                                           |
| address <ip-address> | Packets from the specified multicast address are treated as coming from routers. The address must be in the 224.0.0.x range.                                                                          |

**Default** The default routermode is **default** (not **all**) and shows the following reserved multicast addresses:

```
Router mode.....Def
Reserved multicast address
224.0.0.1
224.0.0.2
224.0.0.4
224.0.0.5
224.0.0.6
224.0.0.9
224.0.0.13
224.0.0.15
224.0.0.24
```

**Mode** Global Configuration

**Examples** To set **ip igmp snooping routermode** for all default reserved addresses enter:

```
awplus(config)# ip igmp snooping routermode default
```

To remove the multicast address 224.0.0.5 from the custom list of multicast addresses enter:

```
awplus(config)# no ip igmp snooping routermode address
224.0.0.5
```

**Related commands** [ip igmp trusted](#)  
[show ip igmp snooping routermode](#)

# ip igmp snooping source-timeout

**Overview** Use this command to set the global IGMP Snooping source time-out value (in seconds) on the switch.

Use the **no** variant of this command to set the source time-out value to be the same as the group membership timeout.

**Syntax** `ip igmp snooping source-timeout <timeout>`  
`no ip igmp snooping source-timeout <timeout>`

| Parameter                    | Description                                            |
|------------------------------|--------------------------------------------------------|
| <code>&lt;timeout&gt;</code> | Time-out value in seconds <code>&lt;0-86400&gt;</code> |

**Default** Global IGMP Snooping source-timeout is disabled by default, and unregistered multicast will be timed-out like normal entries.

Interface IGMP Snooping source timeout is disabled by default, and unregistered multicast will be timed-out like normal entries.

**Mode** Interface/Global Configuration

**Usage** The timeout determines how long unregistered multicast entries will be kept for. If the value '0' is specified, then effectively all unregistered multicast entries will never be timed out, and can only be cleared by using the command **clear ip igmp group**. The interface settings will always take precedence over the global setting.

**Example** To configure IGMP Snooping source timeout globally on a switch, use the commands:

```
awplus# configure terminal
awplus(config)# interface vlan1
awplus(config-if)# ip igmp snooping source-timeout 200
```

**Related Commands** [show ip igmp snooping source-timeout](#)



# ip igmp snooping tcn query solicit

**Overview** Use this command to enable IGMP (Internet Group Management Protocol) Snooping TCN (Topology Change Notification) Query Solicitation feature. When this command is used in the Global Configuration mode, Query Solicitation is enabled.

Use the **no** variant of this command to disable IGMP Snooping TCN Query Solicitation. When the **no** variant of this command is used in Interface Configuration mode, this overrides the Global Configuration mode setting and Query Solicitation is disabled.

**Syntax** `ip igmp snooping tcn query solicit`  
`no ip igmp snooping tcn query solicit`

**Default** IGMP Snooping TCN Query Solicitation is disabled by default on the device, unless the device is the Master Node in an EPSR ring, or is the Root Bridge in a Spanning Tree.

When the device is the Master Node in an EPSR ring, or the device is the Root Bridge in a Spanning Tree, then IGMP Snooping TCN Query Solicitation is enabled by default and cannot be disabled using the Global Configuration mode command. However, Query Solicitation can be disabled for specified interfaces using the **no** variant of this command from the Interface Configuration mode.

**Mode** Global Configuration, and Interface Configuration for a VLAN interface.

**Usage** Once enabled, if the device is not an IGMP Querier, on detecting a topology change, the device generates IGMP Query Solicit messages that are sent to all the ports of the vlan configured for IGMP Snooping on the device.

On a device that is not the Master Node in an EPSR ring or the Root Bridge in a Spanning Tree, Query Solicitation can be disabled using the **no** variant of this command after being enabled.

If the device that detects a topology change is an IGMP Querier then the device will generate an IGMP Query message.

Note that the **no** variant of this command when issued in Global Configuration mode has no effect on a device that is the Master Node in an EPSR ring or on a device that is a Root Bridge in a Spanning Tree. Query Solicitation is not disabled for the device these instances. However, Query Solicitation can be disabled on a per-vlan basis from the Interface Configuration mode.

See the following state table that shows when Query Solicit messages are sent in these instances:

| Command issued from Global Configuration | Command issued from Interface Configuration | Device is STP Root Bridge or the ERSR Master Node | IGMP Query Solicit message sent on VLAN |
|------------------------------------------|---------------------------------------------|---------------------------------------------------|-----------------------------------------|
| No                                       | Yes                                         | Yes                                               | Yes                                     |
| Yes                                      | No                                          | Yes                                               | No                                      |
| Yes                                      | Yes                                         | Yes                                               | Yes                                     |

See the [IGMP Feature Overview and Configuration Guide](#) for introductory information about the Query Solicitation feature.

**Examples** To enable Query Solicitation on a device, use the commands:

```
awplus# configure terminal
awplus(config)# ip igmp snooping tcn query solicit
```

To disable Query Solicitation on a device, use the commands:

```
awplus# configure terminal
awplus(config)# no ip igmp snooping tcn query solicit
```

To enable Query Solicitation for vlan2, use the commands:

```
awplus# configure terminal
awplus(config)# interface vlan2
awplus(config-if)# ip igmp snooping tcn query solicit
```

To disable Query Solicitation for vlan2, use the commands:

```
awplus# configure terminal
awplus(config)# interface vlan2
awplus(config-if)# no ip igmp snooping tcn query solicit
```

**Related Commands**

- [ip igmp query-holdtime](#)
- [show ip igmp interface](#)
- [show running-config](#)

# ip igmp source-address-check

**Overview** This command enables the checking of the Source Address for an IGMP Report, rejecting any IGMP Reports originating on devices outside of the local subnet.

Use the **no** variant of this command to disable the checking of the Source Address for an IGMP Report, which allows IGMP Reports from devices outside of the local subnet.

**Syntax** `ip igmp source-address-check`  
`no ip igmp source-address-check`

**Default** Source address checking for IGMP Reports is enabled by default.

**Mode** Interface Configuration for a VLAN or Eth interface.

**Usage** This is a security feature, and should be enabled unless IGMP Reports from outside the local subnet are expected, for example, if Multicast VLAN Registration is active in the network.

The no variant of this command is required to disable the IGMP Report source address checking feature in networks that use Multicast VLAN Registration to allow IGMP Reports from devices outside of the local subnet.

**Examples** To deny IGMP Reports from outside the current subnet for vlan20, use the following commands:

```
awplus# configure terminal
awplus(config)# interface vlan20
awplus(config-if)# ip igmp source-address-check
```

To allow IGMP Reports from outside the current subnet for vlan10, use the following commands:

```
awplus# configure terminal
awplus(config)# interface vlan10
awplus(config-if)# no ip igmp source-address-check
```

**Validation  
Commands** `show ip igmp interface`  
`show running-config`

# ip igmp startup-query-count

**Overview** Use this command to configure the IGMP startup query count for an interface. The IGMP startup query count is the number of IGMP General Query messages sent by a querier at startup. The default IGMP startup query count is 2.

Use the **no** variant of this command to return an interface's configured IGMP startup query count to the default.

**Syntax** `ip igmp startup-query-count <startup-query-count>`  
`no ip igmp startup-query-count`

| Parameter                                | Description                                              |
|------------------------------------------|----------------------------------------------------------|
| <code>&lt;startup-query-count&gt;</code> | Specify the IGMP startup query count, in the range 2-10. |

**Default** The default IGMP startup query count is 2.

**Mode** Interface Configuration for a VLAN or Eth interface.

**Example** To set the IGMP startup query count to 4 on vlan2, use the commands:

```
awplus# configure terminal
awplus(config)# interface vlan2
awplus(config-if)# ip igmp startup-query-count 4
```

**Related Commands** [ip igmp last-member-query-count](#)  
[ip igmp startup-query-interval](#)

# ip igmp startup-query-interval

**Overview** Use this command to configure the IGMP startup query interval for an interface. The IGMP startup query interval is the amount of time in seconds between successive IGMP General Query messages sent by a querier during startup. The default IGMP startup query interval is one quarter of the IGMP query interval value.

Use the **no** variant of this command to return an interface's configured IGMP startup query interval to the default.

**Syntax** `ip igmp startup-query-interval <startup-query-interval>`  
`no ip igmp startup-query-interval`

| Parameter                                   | Description                                                                                                                              |
|---------------------------------------------|------------------------------------------------------------------------------------------------------------------------------------------|
| <code>&lt;startup-query-interval&gt;</code> | Specify the IGMP startup query interval, in the range of 2-1800 seconds. The value must be one quarter of the IGMP query interval value. |

**Default** The default IGMP startup query interval is one quarter of the IGMP query interval value.

**NOTE:** *The IGMP startup query interval must be one quarter of the IGMP query interval.*

**Mode** Interface Configuration for a VLAN or Eth interface.

**Example** To set the IGMP startup query interval to 15 seconds for vlan2, which is one quarter of the IGMP query interval of 60 seconds, use the commands:

```
awplus# configure terminal
awplus(config)# interface vlan2
awplus(config-if)# ip igmp query-interval 60
awplus(config-if)# ip igmp startup-query-interval 15
```

**Related Commands** [ip igmp last-member-query-interval](#)  
[ip igmp query-interval](#)  
[ip igmp startup-query-count](#)

# ip igmp trusted

**Overview** Use this command to allow IGMP to process packets received on certain trusted ports only.

Use the **no** variant of this command to stop IGMP from processing specified packets if the packets are received on the specified ports or aggregator.

**Syntax** `ip igmp trusted {all|query|report|routermode}`  
`no ip igmp trusted {all|query|report|routermode}`

| Parameter  | Description                                                                                        |
|------------|----------------------------------------------------------------------------------------------------|
| all        | Specifies whether or not the interface is allowed to receive all IGMP and other routermode packets |
| query      | Specifies whether or not the interface is allowed to receive IGMP queries                          |
| report     | Specifies whether or not the interface is allowed to receive IGMP membership reports               |
| routermode | Specifies whether or not the interface is allowed to receive routermode packets                    |

**Default** By default, all ports and aggregators are trusted interfaces, so IGMP is allowed to process all IGMP query, report, and router mode packets arriving on all interfaces.

**Mode** Interface mode for one or more switch ports or aggregators

**Usage** Because all ports are trusted by default, use this command in its **no** variant to stop IGMP processing packets on ports you do not trust.

For example, you can use this command to make sure that only ports attached to approved IGMP routers are treated as router ports.

**Example** To stop ports port1.0.3-port1.0.6 from being treated as router ports by IGMP, use the commands:

```
awplus(config)# interface port1.0.3-port1.0.6
awplus(config-if)# no ip igmp trusted routermode
```

**Related Commands** [ip igmp snooping routermode](#)

# ip igmp version

**Overview** Use this command to set the current IGMP version (IGMP version 1, 2 or 3) on an interface.

Use the **no** variant of this command to return to the default version.

**Syntax** ip igmp version <1-3>  
no ip igmp version

| Parameter     | Description                  |
|---------------|------------------------------|
| version <1-3> | IGMP protocol version number |

**Default** The default IGMP version is 3.

**Mode** Interface Configuration for a VLAN or Eth interface.

**Example** To set the IGMP version to 2 for vlan2, use the commands:

```
awplus# configure terminal
awplus(config)# interface vlan2
awplus(config-if)# ip igmp version 2
```

**Related Commands** [show ip igmp interface](#)

# show debugging igmp

**Overview** Use this command to display the IGMP debugging options set.

For information on filtering and saving command output, see the [“Getting Started with AlliedWare Plus” Feature Overview and Configuration Guide](#).

**Syntax** `show debugging igmp`

**Mode** User Exec and Privileged Exec

**Example** To display the IGMP debugging options set, enter the command:

```
awplus# show debugging igmp
```

**Output** Figure 35-1: Example output from the **show debugging igmp** command

```
IGMP Debugging status:
IGMP Decoder debugging is on
IGMP Encoder debugging is on
IGMP Events debugging is on
IGMP FSM debugging is on
IGMP Tree-Info-Base (TIB) debugging is on
```

**Related Commands** [debug igmp](#)



# show ip igmp groups

**Overview** Use this command to display the multicast groups with receivers directly connected to the router, and learned through IGMP.

For information on filtering and saving command output, see the [“Getting Started with AlliedWare Plus” Feature Overview and Configuration Guide](#).

**Syntax** `show ip igmp groups [<ip-address>|<interface> detail]`

| Parameter    | Description                                                  |
|--------------|--------------------------------------------------------------|
| <ip-address> | Address of the multicast group, entered in the form A.B.C.D. |
| <interface>  | Interface name for which to display local information.       |

**Mode** User Exec and Privileged Exec

**Example** The following command displays local-membership information for all ports in all interfaces:

```
awplus# show ip igmp groups
```

**Output** Figure 35-2: Example output from **show ip igmp groups**

| IGMP Connected Group Membership |            |          |          |               |  |
|---------------------------------|------------|----------|----------|---------------|--|
| Group Address                   | Interface  | Uptime   | Expires  | Last Reporter |  |
| 224.0.1.1                       | port1.0.1  | 00:00:09 | 00:04:17 | 10.10.0.82    |  |
| 224.0.1.24                      | port1.0.2  | 00:00:06 | 00:04:14 | 10.10.0.84    |  |
| 224.0.1.40                      | port1.0.3  | 00:00:09 | 00:04:15 | 10.10.0.91    |  |
| 224.0.1.60                      | port1.0.3  | 00:00:05 | 00:04:15 | 10.10.0.7     |  |
| 224.100.100.100                 | port1.0.1  | 00:00:11 | 00:04:13 | 10.10.0.91    |  |
| 228.5.16.8                      | port1.0.3  | 00:00:11 | 00:04:16 | 10.10.0.91    |  |
| 228.81.16.8                     | port1.0.7  | 00:00:05 | 00:04:15 | 10.10.0.91    |  |
| 228.249.13.8                    | port1.0.3  | 00:00:08 | 00:04:17 | 10.10.0.91    |  |
| 235.80.68.83                    | port1.0.11 | 00:00:12 | 00:04:15 | 10.10.0.40    |  |
| 239.255.255.250                 | port1.0.3  | 00:00:12 | 00:04:15 | 10.10.0.228   |  |
| 239.255.255.254                 | port1.0.12 | 00:00:08 | 00:04:13 | 10.10.0.84    |  |

Table 35-1: Parameters in the output of **show ip igmp groups**

| Parameter     | Description                                                                                                  |
|---------------|--------------------------------------------------------------------------------------------------------------|
| Group Address | Address of the multicast group.                                                                              |
| Interface     | Port through which the group is reachable.                                                                   |
| Uptime        | The time in weeks, days, hours, minutes, and seconds that this multicast group has been known to the device. |

Table 35-1: Parameters in the output of **show ip igmp groups** (cont.)

| Parameter     | Description                                                    |
|---------------|----------------------------------------------------------------|
| Expires       | Time (in hours, minutes, and seconds) until the entry expires. |
| Last Reporter | Last host to report being a member of the multicast group.     |

# show ip igmp interface

**Overview** Use this command to display the state of IGMP, IGMP Proxy service, and IGMP Snooping for a specified VLAN, or all VLANs. IGMP is shown as Active or Disabled in the show output. You can also display the number of groups a switch port belongs to.

For information on filtering and saving command output, see the [“Getting Started with AlliedWare Plus” Feature Overview and Configuration Guide](#).

**Syntax** show ip igmp interface [<interface>]

| Parameter   | Description                                                                                                                                                                                                                                              |
|-------------|----------------------------------------------------------------------------------------------------------------------------------------------------------------------------------------------------------------------------------------------------------|
| <interface> | The name of the interface.<br>If you specify a switch port number, the output displays the number of groups the port belongs to, and the port’s group membership limit, if a limit has been set (with the command <code>ip igmp maximum-groups</code> ). |

**Mode** User Exec and Privileged Exec

**Output** The following output shows IGMP interface status for vlan2 with IGMP Snooping enabled:

```
awplus#show ip igmp interface vlan2
Interface vlan2 (Index 202)
 IGMP Disabled, Inactive, Version 3 (default)
 IGMP interface has 0 group-record states
 IGMP activity: 0 joins, 0 leaves
 IGMP robustness variable is 2
 IGMP last member query count is 2
 IGMP query interval is 125 seconds
 IGMP query holdtime is 500 milliseconds
 IGMP querier timeout is 255 seconds
 IGMP max query response time is 10 seconds
 Last member query response interval is 1000 milliseconds
 Group Membership interval is 260 seconds
 Strict IGMPv3 ToS checking is disabled on this interface
 Source Address checking is enabled
 IGMP Snooping is globally enabled
 IGMP Snooping query solicitation is globally disabled
 Num. query-solicit packets: 57 sent, 0 recvd
 IGMP Snooping is enabled on this interface
 IGMP Snooping fast-leave is not enabled
 IGMP Snooping querier is not enabled
 IGMP Snooping report suppression is enabled
```

The following output shows IGMP interface status for vlan2 with IGMP Snooping disabled:

```
awplus#show ip igmp interface vlan2
Interface vlan2 (Index 202)
 IGMP Disabled, Inactive, Version 3 (default)
 IGMP interface has 0 group-record states
 IGMP activity: 0 joins, 0 leaves
 IGMP robustness variable is 2
 IGMP last member query count is 2
 IGMP query interval is 125 seconds
 IGMP query holdtime is 500 milliseconds
 IGMP querier timeout is 255 seconds
 IGMP max query response time is 10 seconds
 Last member query response interval is 1000 milliseconds
 Group Membership interval is 260 seconds
 Strict IGMPv3 ToS checking is disabled on this interface
 Source Address checking is enabled
 IGMP Snooping is globally enabled
 IGMP Snooping query solicitation is globally disabled
 Num. query-solicit packets: 57 sent, 0 recvd
 IGMP Snooping is not enabled on this interface
 IGMP Snooping fast-leave is not enabled
 IGMP Snooping querier is not enabled
 IGMP Snooping report suppression is enabled
```

The following output displays membership information for port1.0.1:

```
awplus#show ip igmp interface port1.0.1
IGMP information for port1.0.1
 Maximum groups limit set: 10
 Number of groups port belongs to: 0
```

# show ip igmp proxy

**Overview** Use this command to display the state of IGMP Proxy services for a specified interface or for all interfaces.

For information on filtering and saving command output, see the [“Getting Started with AlliedWare Plus” Feature Overview and Configuration Guide](#).

**Syntax**

```
show ip igmp proxy
show ip igmp proxy groups [detail]
show ip igmp proxy groups <multicast-group> [detail]
show ip igmp proxy groups <vlan> [detail]
show ip igmp proxy groups <vlan> <multicast-group> [detail]
```

| Parameter         | Description                                                                |
|-------------------|----------------------------------------------------------------------------|
| groups            | Specify IGMP proxy group membership information.                           |
| detail            | Specify detailed IGMPv3 source information.                                |
| <vlan>            | Specify the name of a single VLAN interface, for example <b>vlan1</b> .    |
| <multicast-group> | Specify the IPv4 address in of the multicast group, in the format A.B.C.D. |

**Mode** User Exec and Privileged Exec

**Example** To display the state of IGMP Proxy services for all interfaces, enter the command:

```
awplus# show ip igmp proxy
```

To display the state of IGMP Proxy services for VLAN interface **vlan1**, enter the command:

```
awplus# show ip igmp proxy groups vlan1
```

To display the detailed state of IGMP Proxy services for VLAN interface **vlan1**, enter the command:

```
awplus# show ip igmp proxy groups vlan1 detail
```

**Related Commands** [ip igmp proxy-service](#)

# show ip igmp snooping mrouter

**Overview** Use this command to display the multicast router ports, both static and dynamic, in a VLAN.

For information on filtering and saving command output, see the [“Getting Started with AlliedWare Plus” Feature Overview and Configuration Guide](#).

**Syntax** `show ip igmp snooping mrouter [interface <interface>]`

| Parameter   | Description                     |
|-------------|---------------------------------|
| interface   | A specific interface.           |
| <interface> | The name of the VLAN interface. |

**Mode** User Exec and Privileged Exec

**Example** To show all multicast router interfaces, use the command:

```
awplus# show ip igmp snooping mrouter
```

To show the multicast router interfaces in `vlan1`, use the command:

```
awplus# show ip igmp snooping mrouter interface vlan1
```

**Output** Figure 35-3: Example output from **show ip igmp snooping mrouter**

| VLAN | Interface | Static/Dynamic        |
|------|-----------|-----------------------|
| 1    | port1.0.5 | Statically configured |
| 200  | port1.0.2 | Statically configured |

Figure 35-4: Example output from **show ip igmp snooping mrouter interface vlan1**

| VLAN | Interface | Static/Dynamic        |
|------|-----------|-----------------------|
| 1    | port1.0.5 | Statically configured |

**Related Commands** [ip igmp snooping mrouter](#)

# show ip igmp snooping routermode

**Overview** Use this command to display the current router mode and the list of IP addresses set as router multicast addresses from the [ip igmp snooping routermode](#) command.

For information on filtering and saving command output, see the [“Getting Started with AlliedWare Plus” Feature Overview and Configuration Guide](#).

**Syntax** `show ip igmp snooping routermode`

**Mode** User Exec and Privileged Exec

**Example** To show the router mode and the list of router multicast addresses, use the command:

```
awplus# show ip igmp snooping routermode
```

**Output** Figure 35-5: Example output from **show ip igmp snooping routermode**

```
awplus#show ip igmp snooping routermode
Router mode.....Def
Reserved multicast address

 224.0.0.1
 224.0.0.2
 224.0.0.4
 224.0.0.5
 224.0.0.6
 224.0.0.9
 224.0.0.13
 224.0.0.15
 224.0.0.24
```

**Related Commands** [ip igmp snooping routermode](#)

# show ip igmp snooping source-timeout

**Overview** Use this command to display the configured IGMP snooping source timeouts for a specified VLAN or VLAN range.

**Syntax** `show ip igmp snooping source-timeout [interface|<interface-range>]`

| Parameter                            | Description                                  |
|--------------------------------------|----------------------------------------------|
| <code>&lt;interface-range&gt;</code> | The name of the VLAN interface or VLAN range |

**Mode** Privileged Exec

**Example** To display the configured IGMP snooping source timeouts for all VLANs, use the command:

```
awplus# show ip igmp snooping source-timeout
```

**Output** Figure 35-6: Example output from **show ip igmp snooping source-timeout**

```
awplus#show ip igmp snooping source-timeout
Global IGMP snooping source-timeout is enabled (60 secs)

vlan1 enabled (300 secs)
vlan2 inherits global setting
vlan1000 inherits global settingawplus#show ip igmp
snooping source-timeout int vlan1
Global IGMP snooping source-timeout is enabled (60 secs)vlan1
enabled (300 secs)
```

**Related Commands** [ip igmp snooping source-timeout](#)



# show ip igmp snooping statistics

**Overview** Use this command to display IGMP Snooping statistics data.

For information on filtering and saving command output, see the [“Getting Started with AlliedWare Plus” Feature Overview and Configuration Guide](#).

**Syntax** `show ip igmp snooping statistics interface <interface-range>  
[group [<ip-address>]]`

| Parameter    | Description                                                                                                                                                                                                                                                              |
|--------------|--------------------------------------------------------------------------------------------------------------------------------------------------------------------------------------------------------------------------------------------------------------------------|
| <ip-address> | Optionally specify the address of the multicast group, entered in the form A.B.C.D.                                                                                                                                                                                      |
| <interface>  | Specify the name of the interface or interface range. If you specify a port number, the output displays the number of groups the port belongs to, and the port’s group membership limit, if a limit has been set (with the command <code>ip igmp maximum-groups</code> ) |

**Mode** Privileged Exec

**Example** To display IGMP statistical information for **vlan1** and **vlan2**, use the command:

```
awplus# show ip igmp snooping statistics interface vlan1-vlan2
```

**Output** Figure 35-7: Example output from the **show ip igmp snooping statistics** command for VLANs

```
awplus#show ip igmp interface vlan1-vlan2
IGMP Snooping statistics for vlan1
Interface: port1.0.3
Group: 224.1.1.1
Uptime: 00:00:09
Group mode: Exclude (Expires: 00:04:10)
Last reporter: 10.4.4.5
Source list is empty
IGMP Snooping statistics for vlan2
Interface: port1.0.4
Group: 224.1.1.2
Uptime: 00:00:19
Group mode: Exclude (Expires: 00:05:10)
Last reporter: 10.4.4.6
Source list is empty
```

Figure 35-8: Example output from the **show ip igmp snooping statistics** command for a switch port

```
awplus#show ip igmp interface port1.0.1
IGMP information for port1.0.1
 Maximum groups limit set: 10
 Number of groups port belongs to: 0
```

# undebug igmp

**Overview** This command applies the functionality of the no `debug igmp` command.

# 36

# MLD and MLD Snooping Commands

## Introduction

**Overview** This chapter provides an alphabetical reference of configuration, clear, and show commands related to MLD and MLD Snooping.

The Multicast Listener Discovery (MLD) module includes the MLD Proxy service and MLD Snooping functionality. Some of the following commands may have commonalities and restrictions; these are described under the Usage section for each command.

MLD and MLD Snooping commands only apply to switch ports, not ETH interfaces.

Before using PIM-SMv6:

- IPv6 must be enabled on an interface ([ipv6 enable](#)),
- IPv6 forwarding must be enabled globally for routing IPv6 ([ipv6 forwarding](#)), and
- IPv6 multicasting must be enabled globally ([ipv6 multicast-routing](#)).

The IPv6 Multicast addresses shown can be derived from IPv6 unicast prefixes as per RFC 3306. The IPv6 unicast prefix reserved for documentation is 2001:0db8::/32 as per RFC 3849. Using the base /32 prefix the IPv6 multicast prefix for 2001:0db8::/32 is ff3x:20:2001:0db8::/64. Where an RP address is 2001:0db8::1 the embedded RP multicast prefix is ff7x:120:2001:0db8::/96. For ASM (Any-Source Multicast) the IPV6 multicast addresses allocated for documentation purposes are ff0x::0db8:0:0/96 as per RFC 6676. This is a /96 prefix so that it can be used with group IDs as per RFC 3307. These addresses should not be used for practical networks (other than for testing purposes), nor should they appear in any public network.

The IPv6 addresses shown use the address space 2001:0db8::/32, defined in RFC 3849 for documentation purposes. These addresses should not be used for practical networks (other than for testing purposes) nor should they appear on any public network.

**Command List** • [“clear ipv6 mld”](#) on page 1630

- [“clear ipv6 mld group”](#) on page 1631
- [“clear ipv6 mld interface”](#) on page 1632
- [“debug mld”](#) on page 1633
- [“ipv6 mld”](#) on page 1634
- [“ipv6 mld last-member-query-count”](#) on page 1635
- [“ipv6 mld last-member-query-interval”](#) on page 1636
- [“ipv6 mld querier-timeout”](#) on page 1637
- [“ipv6 mld query-interval”](#) on page 1638
- [“ipv6 mld query-max-response-time”](#) on page 1639
- [“ipv6 mld robustness-variable”](#) on page 1640
- [“ipv6 mld snooping”](#) on page 1641
- [“ipv6 mld snooping fast-leave”](#) on page 1643
- [“ipv6 mld snooping mrouter”](#) on page 1644
- [“ipv6 mld snooping querier”](#) on page 1646
- [“ipv6 mld snooping report-suppression”](#) on page 1647
- [“ipv6 mld ssm-map enable”](#) on page 1649
- [“ipv6 mld static-group”](#) on page 1650
- [“ipv6 mld version”](#) on page 1652
- [“show debugging mld”](#) on page 1653
- [“show ipv6 mld groups”](#) on page 1654
- [“show ipv6 mld interface”](#) on page 1655
- [“show ipv6 mld snooping mrouter”](#) on page 1656
- [“show ipv6 mld snooping statistics”](#) on page 1657

# clear ipv6 mld

**Overview** Use this command to clear all MLD local memberships on all interfaces.

**Syntax** `clear ipv6 mld`

**Mode** Privileged Exec

**Usage** This command applies to interfaces configured for MLD Layer-3 multicast protocols and learned by MLD Snooping.

**Example** `awplus# clear ipv6 mld`

**Related  
Commands** `clear ipv6 mld group`  
`clear ipv6 mld interface`

# clear ipv6 mld group

**Overview** Use this command to clear MLD specific local-membership(s) on all interfaces, for a particular group.

**Syntax** `clear ipv6 mld group {*|<ipv6-address>}`

| Parameter      | Description                                                                                                                                                                     |
|----------------|---------------------------------------------------------------------------------------------------------------------------------------------------------------------------------|
| *              | Clears all groups on all interfaces. This is an alias to the <a href="#">clear ipv6 mld</a> command.                                                                            |
| <ipv6-address> | Specify the group address for which MLD local-memberships are to be cleared from all interfaces. Specify the IPv6 multicast group address in the format in the format X:X::X:X. |

**Mode** Privileged Exec

**Usage** This command applies to interfaces configured for MLD Layer-3 multicast protocols and learned by MLD Snooping.

**Example** `awplus# clear ipv6 mld group *`

**Related Commands** [clear ipv6 mld](#)  
[clear ipv6 mld interface](#)

# clear ipv6 mld interface

**Overview** Use this command to clear MLD interface entries.

**Syntax** `clear ipv6 mld interface <interface>`

| Parameter                      | Description                                                                          |
|--------------------------------|--------------------------------------------------------------------------------------|
| <code>&lt;interface&gt;</code> | Specifies name of the interface; all groups learned from this interface are deleted. |

**Mode** Privileged Exec

**Usage** This command applies to interfaces configured for MLD Layer-3 multicast protocols and learned by MLD Snooping.

**Example** `awplus# clear ipv6 mld interface vlan2`

**Related Commands** [clear ipv6 mld](#)  
[clear ipv6 mld group](#)



# debug mld

**Overview** Use this command to enable all MLD debugging modes, or a specific MLD debugging mode.

Use the **no** variant of this command to disable all MLD debugging modes, or a specific MLD debugging mode.

**Syntax** `debug mld {all|decode|encode|events|fsm|tib}`  
`no debug mld {all|decode|encode|events|fsm|tib}`

| Parameter | Description                            |
|-----------|----------------------------------------|
| all       | Debug all MLD.                         |
| decode    | Debug MLD decoding.                    |
| encode    | Debug MLD encoding.                    |
| events    | Debug MLD events.                      |
| fsm       | Debug MLD Finite State Machine (FSM).  |
| tib       | Debug MLD Tree Information Base (TIB). |

**Mode** Privileged Exec and Global Configuration

**Usage** This command applies to interfaces configured for MLD Layer 3 multicast protocols and learned by MLD Snooping.

**Examples**

```
awplus# configure terminal
awplus(config)# debug mld all
awplus# configure terminal
awplus(config)# debug mld decode
awplus# configure terminal
awplus(config)# debug mld encode
awplus# configure terminal
awplus(config)# debug mld events
```

**Related Commands** [show debugging mld](#)

# ipv6 mld

**Overview** Use this command to enable the MLD protocol operation on an interface. This command enables MLD protocol operation in stand-alone mode, and can be used to learn local-membership information prior to enabling a multicast routing protocol on the interface.

Use the **no** variant of this command to return all MLD related configuration to the default (including MLD Snooping).

**Syntax** `ipv6 mld`  
`no ipv6 mld`

**Default** MLD is disabled by default.

**Mode** Interface Configuration for a specified VLAN interface or a range of VLAN interfaces.

**Usage** MLD requires memory for storing data structures, as well as the hardware tables to implement hardware routing. As the number of ports, VLANs, static and dynamic groups increases then more memory is consumed. You can track the memory used for MLD with the command:

```
awplus# show memory pools nsm | grep MLD
```

Static and dynamic groups (LACP), ports and VLANs are not limited for MLD. For VLANs, this allows you to configure MLD across more VLANs with fewer ports per VLAN, or fewer VLANs with more ports per VLAN. For LACPs, you can configure MLD across more LACP groups with fewer ports per LACP, or fewer LACP groups with more ports per LACP.

**Example**

```
awplus# configure terminal
awplus(config)# ipv6 forwarding
awplus(config)# ipv6 multicast-routing
awplus(config)# interface vlan1
awplus(config-if)# ipv6 enable
awplus(config-if)# ipv6 mld
```

# ipv6 mld last-member-query-count

**Overview** Use this command to set the last-member query-count value.  
Use the **no** variant of this command to return to the default on an interface.

**Syntax** `ipv6 mld last-member-query-count <value>`  
`no ipv6 mld last-member-query-count`

| Parameter | Description                                |
|-----------|--------------------------------------------|
| <value>   | Count value. Valid values are from 2 to 7. |

**Default** The default last-member query-count value is 2.

**Mode** Interface Configuration for a specified VLAN interface or a range of VLAN interfaces.

**Example**

```
awplus# configure terminal
awplus(config)# ipv6 forwarding
awplus(config)# ipv6 multicast-routing
awplus(config)# interface vlan2
awplus(config-if)# ipv6 enable
awplus(config-if)# ipv6 mld last-member-query-count 3
```

# ipv6 mld last-member-query-interval

**Overview** Use this command to configure the interval at which the router sends MLD group-specific host query messages.

Use the **no** variant of this command to set this frequency to the default.

**Syntax** `ipv6 mld last-member-query-interval <milliseconds>`  
`no ipv6 mld last-member-query-interval`

| Parameter                         | Description                                                                                                           |
|-----------------------------------|-----------------------------------------------------------------------------------------------------------------------|
| <code>&lt;milliseconds&gt;</code> | The time delay between successive query messages (in milliseconds). Valid values are from 1000 to 25500 milliseconds. |

**Default** 1000 milliseconds

**Mode** Interface Configuration for a specified VLAN interface or a range of VLAN interfaces.

**Example**

```
awplus# configure terminal
awplus(config)# ipv6 forwarding
awplus(config)# ipv6 multicast-routing
awplus(config)# interface vlan2
awplus(config-if)# ipv6 enable
awplus(config-if)# ipv6 mld last-member-query-interval 2000
```

# ipv6 mld querier-timeout

**Overview** Use this command to configure the timeout period before the router takes over as the querier for the interface after the previous querier has stopped querying.

Use the **no** variant of this command to restore the default.

**Syntax** `ipv6 mld querier-timeout <seconds>`  
`no ipv6 mld querier-timeout`

| Parameter                    | Description                                                                                                                                                            |
|------------------------------|------------------------------------------------------------------------------------------------------------------------------------------------------------------------|
| <code>&lt;seconds&gt;</code> | Number of seconds that the router waits after the previous querier has stopped querying before it takes over as the querier. Valid values are from 2 to 65535 seconds. |

**Default** 255 seconds

**Mode** Interface Configuration for a specified VLAN interface or a range of VLAN interfaces.

**Usage** This command applies to interfaces configured for MLD Layer-3 multicast protocols.

**Example** The following example configures the router to wait 120 seconds from the time it received the last query before it takes over as the querier for the interface:

```
awplus# configure terminal
awplus(config)# ipv6 forwarding
awplus(config)# ipv6 multicast-routing
awplus(config)# interface vlan2
awplus(config-if)# ipv6 enable
awplus(config-if)# ipv6 mld querier-timeout 120
```

**Related Commands** [ipv6 mld query-interval](#)

# ipv6 mld query-interval

**Overview** Use this command to configure the frequency of sending MLD host query messages.

Use the **no** variant of this command to return to the default frequency.

**Syntax** `ipv6 mld query-interval <seconds>`  
`no ipv6 mld query-interval`

| Parameter                    | Description                                                                                                                               |
|------------------------------|-------------------------------------------------------------------------------------------------------------------------------------------|
| <code>&lt;seconds&gt;</code> | Variable that specifies the time delay between successive MLD host query messages (in seconds). Valid values are from 1 to 18000 seconds. |

**Default** The default query interval is 125 seconds.

**Mode** Interface Configuration for a specified VLAN interface or a range of VLAN interfaces.

**Usage** This command applies to interfaces configured for MLD Layer-3 multicast protocols.

**Example** The following example changes the frequency of sending MLD host-query messages to 2 minutes:

```
awplus# configure terminal
awplus(config)# ipv6 forwarding
awplus(config)# ipv6 multicast-routing
awplus(config)# interface vlan2
awplus(config-if)# ipv6 enable
awplus(config-if)# ipv6 mld query-interval 120
```

**Related Commands** [ipv6 mld querier-timeout](#)

# ipv6 mld query-max-response-time

**Overview** Use this command to configure the maximum response time advertised in MLD queries.

Use the **no** variant of with this command to restore the default.

**Syntax** `ipv6 mld query-max-response-time <seconds>`  
`no ipv6 mld query-max-response-time`

| Parameter                    | Description                                                                                           |
|------------------------------|-------------------------------------------------------------------------------------------------------|
| <code>&lt;seconds&gt;</code> | Maximum response time (in seconds) advertised in MLD queries. Valid values are from 1 to 240 seconds. |

**Default** 10 seconds

**Mode** Interface Configuration for a specified VLAN interface or a range of VLAN interfaces.

**Usage** This command applies to interfaces configured for MLD Layer-3 multicast protocols.

**Example** The following example configures a maximum response time of 8 seconds:

```
awplus# configure terminal
awplus(config)# ipv6 forwarding
awplus(config)# ipv6 multicast-routing
awplus(config)# interface vlan2
awplus(config-if)# ipv6 enable
awplus(config-if)# ipv6 mld query-max-response-time 8
```

# ipv6 mld robustness-variable

**Overview** Use this command to change the robustness variable value on an interface.  
Use the **no** variant of this command to return to the default on an interface.

**Syntax** `ipv6 mld robustness-variable <value>`  
`no ipv6 mld robustness-variable`

**Default** The default robustness variable value is 2.

**Mode** Interface Configuration for a specified VLAN interface or a range of VLAN interfaces.

**Usage** This command applies to interfaces configured for MLD Layer-3 multicast protocols.

**Example**

```
awplus# configure terminal
awplus(config)# ipv6 forwarding
awplus(config)# ipv6 multicast-routing
awplus(config)# interface vlan2
awplus(config-if)# ipv6 enable
awplus(config-if)# ipv6 mld robustness-variable 3
```



# ipv6 mld snooping

**Overview** Use this command to enable MLD Snooping. When this command is issued in the Global Configuration mode, MLD Snooping is enabled globally for the device. When this command is issued in Interface mode for a VLAN then MLD Snooping is enabled for the specified VLAN. Note that MLD Snooping is enabled on the VLAN only if it is enabled globally and on the VLAN.

Use the **no** variant of this command to globally disable MLD Snooping in Global Configuration mode, or for the specified VLAN interface in Interface mode.

**Syntax** `ipv6 mld snooping`  
`no ipv6 mld snooping`

**Default** By default, MLD Snooping is enabled both globally and on all VLANs.

**Mode** Global Configuration and Interface Configuration for a specified VLAN interface or a range of VLAN interfaces.

**Usage** For MLD Snooping to operate on particular VLAN interfaces, it must be enabled both globally by using this command in Global Configuration mode, and on individual VLAN interfaces by using this command in Interface Configuration mode (both are enabled by default).

MLD requires memory for storing data structures, as well as the hardware tables to implement hardware routing. As the number of ports, VLANs, static and dynamic groups increases then more memory is consumed. You can track the memory used for MLD with the command:

```
awplus# show memory pools nsm | grep MLD
```

Static and dynamic groups (LACP), ports and VLANs are not limited for MLD. For VLANs, this allows you to configure MLD across more VLANs with fewer ports per VLAN, or fewer VLANs with more ports per VLAN. For LACPs, you can configure MLD across more LACP groups with fewer ports per LACP, or fewer LACP groups with more ports per LACP.

**Examples** To configure MLD Snooping on the VLAN interfaces `vlan2-vlan4`, enter the following commands:

```
awplus# configure terminal
awplus(config)# interface vlan2-vlan4
awplus(config-if)# ipv6 mld snooping
```

To disable MLD Snooping for the VLAN interfaces `vlan2-vlan4`, enter the following commands:

```
awplus# configure terminal
awplus(config)# interface vlan2-vlan4
awplus(config)# no ipv6 mld snooping
```

To configure MLD Snooping globally for the device, enter the following commands:

```
awplus# configure terminal
awplus(config)# ipv6 mld snooping
```

To disable MLD Snooping globally for the device, enter the following commands:

```
awplus# configure terminal
awplus(config)# no ipv6 mld snooping
```

# ipv6 mld snooping fast-leave

**Overview** Use this command to enable MLD Snooping fast-leave processing. Fast-leave processing is analogous to immediate-leave processing; the MLD group-membership is removed as soon as an MLD leave group message is received, without sending out a group-specific query.

Use the **no** variant of this command to disable fast-leave processing.

**Syntax** `ipv6 mld snooping fast-leave`  
`no ipv6 mld snooping fast-leave`

**Default** MLD Snooping fast-leave processing is disabled.

**Mode** Interface Configuration for a specified VLAN interface or a range of VLAN interfaces.

**Usage** This MLD Snooping command can only be configured on VLAN interfaces.

**Examples** This example shows how to enable fast-leave processing on the VLAN interface `vlan2`.

```
awplus# configure terminal
awplus(config)# interface vlan2
awplus(config-if)# ipv6 mld snooping fast-leave
```

This example shows how to enable fast-leave processing on the VLAN interface `vlan2- vlan4`.

```
awplus# configure terminal
awplus(config)# interface vlan2-vlan4
awplus(config-if)# ipv6 mld snooping fast-leave
```

# ipv6 mld snooping mrouter

**Overview** Use this command to statically configure the specified port as a Multicast Router interface for MLD Snooping within the specified VLAN.

See detailed usage notes below to configure static multicast router ports when using static IPv6 multicast routes with EPSR, and the destination VLAN is an EPSR data VLAN.

Use the **no** variant of this command to remove the static configuration of the interface as a Multicast Router interface.

**Syntax** `ipv6 mld snooping mrouter interface <port>`  
`no ipv6 mld snooping mrouter interface <port>`

| Parameter | Description                   |
|-----------|-------------------------------|
| <port>    | Specify the name of the port. |

**Mode** Interface Configuration for a specified VLAN interface or a range of VLAN interfaces.

**Usage** This MLD Snooping command statically configures a switch port as a Multicast Router interface.

Note that if static IPv6 multicast routing is being used with EPSR and the destination VLAN is an EPSR data VLAN, then multicast router (mrouter) ports must be statically configured. This minimizes disruption for multicast traffic in the event of ring failure or restoration.

When configuring the EPSR data VLAN, statically configure mrouter ports so that the multicast router can be reached in either direction around the EPSR ring.

For example, if port1.0.1 and port1.0.6 are ports on an EPSR data VLAN vlan101, which is the destination for a static IPv6 multicast route, then configure both ports as multicast router (mrouter) ports as shown in the example commands listed below:

**Output** Figure 36-1: Example **ipv6 mld snooping mrouter** commands when static IPv6 multicast routing is being used and the destination VLAN is an EPSR data VLAN:

```
awplus>enable
awplus#configure terminal
awplus(config)#interface vlan101
awplus(config-if)#ipv6 mld snooping mrouter interface port1.0.1
awplus(config-if)#ipv6 mld snooping mrouter interface port1.0.6
```

**Examples** This example shows how to specify the next-hop interface to the multicast router for VLAN interface `vlan2`:

```
awplus# configure terminal
awplus(config)# interface vlan2
awplus(config-if)# ipv6 mld snooping mrrouter interface
port1.0.5
```

This example shows how to specify the next-hop interface to the multicast router for VLAN interfaces `vlan2-vlan4`:

```
awplus# configure terminal
awplus(config)# interface vlan2-vlan4
awplus(config-if)# ipv6 mld snooping mrrouter interface
port1.0.5
```

**Related  
Commands** [ipv6 multicast route](#)

# ipv6 mld snooping querier

**Overview** Use this command to enable MLD querier operation on a subnet (VLAN) when no multicast routing protocol is configured in the subnet (VLAN). When enabled, the MLD Snooping querier sends out periodic MLD queries for all interfaces on that VLAN.

Use the **no** variant of this command to disable MLD querier configuration.

**Syntax** `ipv6 mld snooping querier`  
`no ipv6 mld snooping querier`

**Mode** Interface Configuration for a specified VLAN interface.

**Usage** This command can only be configured on a single VLAN interface - not on multiple VLANs.

The MLD Snooping querier uses the 0.0.0.0 Source IP address because it only masquerades as an MLD querier for faster network convergence.

The MLD Snooping querier does not start, or automatically cease, the MLD Querier operation if it detects query message(s) from a multicast router. It restarts as an MLD Snooping querier if no queries are seen within the other querier interval.

Do not enable MLD Snooping querier if you have already enabled MLD on your device.

Do not enable MLD Snooping querier on your device and then enable MLD afterwards.

**Example**

```
awplus# configure terminal
awplus(config)# interface vlan2
awplus(config-if)# ipv6 mld snooping querier
```

# ipv6 mld snooping report-suppression

**Overview** Use this command to enable report suppression from hosts for Multicast Listener Discovery version 1 (MLDv1) on a VLAN in Interface Configuration mode.

Use the **no** variant of this command to disable report suppression on a VLAN in Interface Configuration mode.

**Syntax** `ipv6 mld snooping report-suppression`  
`no ipv6 mld snooping report-suppression`

**Default** Report suppression does not apply to MLDv2, and is turned on by default for MLDv1 reports.

**Mode** Interface Configuration for a specified VLAN interface or a range of VLAN interfaces.

**Usage** This MLD Snooping command can only be configured on VLAN interfaces. MLDv1 Snooping maybe configured to suppress reports from hosts. When a querier sends a query, only the first report for particular set of group(s) from a host will be forwarded to the querier by the MLD Snooping device. Similar reports (to the same set of groups) from other hosts, which would not change group memberships in the querier, will be suppressed by the MLD Snooping device to prevent 'flooding' of query responses.

**Examples** This example shows how to enable report suppression for MLD reports on VLAN interface `vlan2`:

```
awplus# configure terminal
awplus(config)# interface vlan2
awplus(config-if)# ipv6 mld snooping report-suppression
```

This example shows how to disable report suppression for MLD reports on VLAN interface `vlan2`:

```
awplus# configure terminal
awplus(config)# interface vlan2
awplus(config-if)# no ipv6 mld snooping report-suppression
```

This example shows how to enable report suppression for MLD reports on VLAN interfaces `vlan2-vlan4`:

```
awplus# configure terminal
awplus(config)# interface vlan2-vlan4
awplus(config-if)# ipv6 mld snooping report-suppression
```

This example shows how to disable report suppression for MLD reports on VLAN interfaces `vlan2-vlan4`:

```
awplus# configure terminal
awplus(config)# interface vlan2-vlan4
awplus(config-if)# no ipv6 mld snooping report-suppression
```



# ipv6 mld ssm-map enable

**Overview** Use this command to enable the Source Specific Multicast (SSM) mapping feature on the device.

Use the **no** variant of this command to disable the SSM mapping feature on the device.

**Syntax** `ipv6 mld ssm-map enable`  
`no ipv6 mld ssm-map enable`

**Mode** Global Configuration

**Usage** This command enables the SSM mapping feature for group members in the defined SSM range.

**Example** This example shows how to enable the MLD SSM mapping feature on the device.

```
awplus# configure terminal
awplus(config)# ipv6 mld ssm-map enable
```

# ipv6 mld static-group

**Overview** Use this command to statically configure IPv6 group membership entries on an interface. To statically add only a group membership, do not specify any parameters.

Use the **no** variant of this command to delete static group membership entries.

**Syntax** `ipv6 mld static-group <ipv6-group-address> [source <ipv6-source-address>] [interface <port>]`  
`no ipv6 mld static-group <ipv6-group-address> [source <ipv6-source-address>] [interface <port>]`

| Parameter                                | Description                                                                                                                                                                                                                                                             |
|------------------------------------------|-------------------------------------------------------------------------------------------------------------------------------------------------------------------------------------------------------------------------------------------------------------------------|
| <code>&lt;ipv6-group-address&gt;</code>  | Specify a standard IPv6 Multicast group address to be configured as a static group member. The IPv6 address uses the format X:X::X:X.                                                                                                                                   |
| <code>&lt;ipv6-source-address&gt;</code> | Optional. Specify a standard IPv6 source address to be configured as a static source from where multicast packets originate. The IPv6 address uses the format X:X::X:X.                                                                                                 |
| <code>&lt;port&gt;</code>                | Optional. Physical interface. This parameter specifies a physical port. If this parameter is used, the static configuration is applied to just to that physical interface. If this parameter is not used, the static configuration is applied on all ports in the VLAN. |

**Mode** Interface Configuration for a VLAN interface.

**Usage** This command applies to MLD Snooping on a VLAN interface to statically add groups and/or source records.

**Examples** To add a static group record, use the following commands:

```
awplus# configure terminal
awplus(config)# interface vlan2
awplus(config-if)# ipv6 mld static-group ff1e::10
```

To add a static group and source record, use the following commands:

```
awplus# configure terminal
awplus(config)# interface vlan2
awplus(config-if)# ipv6 mld static-group ff1e::10 source
fe80::2fd:6cff:fe1c:b
```

To add a static group record on a specific port on vlan2, use the following commands:

```
awplus# configure terminal
awplus(config)# interface vlan2
awplus(config-if)# ipv6 mld static-group ff1e::10 interface
port1.0.4
```

# ipv6 mld version

**Overview** Use this command to set the current MLD protocol version on an interface.  
Use the **no** variant of this command to return to the default version on an interface.

**Syntax** `ipv6 mld version <version>`  
`no ipv6 mld version`

| Parameter                    | Description                                                    |
|------------------------------|----------------------------------------------------------------|
| <code>&lt;version&gt;</code> | MLD protocol version number. Valid version numbers are 1 and 2 |

**Default** The default MLD protocol version number is 2.

**Mode** Interface Configuration for a VLAN interface.

**Usage** This command applies to interfaces configured for MLD Layer-3 multicast protocols and MLD Snooping. Note this command is intended for use where there is another querier (when there is another device with MLD enabled) on the same link that can only operate with MLD version 1. Otherwise, the default MLD version 2 is recommended for performance.

**Example**

```
awplus# configure terminal
awplus(config)# ipv6 forwarding
awplus(config)# ipv6 multicast-routing
awplus(config)# interface vlan2
awplus(config-if)# ipv6 enable
awplus(config-if)# ipv6 mld version 1
```

# show debugging mld

**Overview** Use this command to display the MLD debugging modes enabled with the [debug mld](#) command.

For information on filtering and saving command output, see the [“Getting Started with AlliedWare Plus” Feature Overview and Configuration Guide](#).

**Syntax** `show debugging mld`

**Mode** Privileged Exec

**Example** `awplus# show debugging mld`

## Output

```
show debugging mld
MLD Debugging status:
 MLD Decoder debugging is on
 MLD Encoder debugging is on
 MLD Events debugging is on
 MLD FSM debugging is on
 MLD Tree-Info-Base (TIB) debugging is on
```

**Related Commands** [debug mld](#)

# show ipv6 mld groups

**Overview** Use this command to display the multicast groups that have receivers directly connected to the router and learned through MLD.

For information on filtering and saving command output, see the [“Getting Started with AlliedWare Plus” Feature Overview and Configuration Guide](#).

**Syntax** `show ipv6 mld groups [<ipv6-address>|<interface>] [detail]`

| Parameter                         | Description                                                                  |
|-----------------------------------|------------------------------------------------------------------------------|
| <code>&lt;ipv6-address&gt;</code> | Optional. Specify Address of the multicast group in format X:X::X:X.         |
| <code>&lt;interface&gt;</code>    | Optional. Specify the Interface name for which to display local information. |

**Mode** User Exec and Privileged Exec

**Examples** The following command displays local-membership information for all interfaces:

```
awplus# show ipv6 mld groups
```

**Output** Figure 36-2: Example output for **show ipv6 mld groups**

```
awplus#show ipv6 mld groups
MLD Connected Group Membership
Group Address Interface Uptime Expires
 Last Reporter
ff08::1 vlan10 (port1.0.1) 00:07:27 00:03:10
 fe80::200:1ff:fe20:b5ac
```

The following command displays local-membership information for all interfaces:

```
awplus# show ipv6 mld groups detail
```

# show ipv6 mld interface

**Overview** Use this command to display the state of MLD and MLD Snooping for a specified interface, or all interfaces.

For information on filtering and saving command output, see the [“Getting Started with AlliedWare Plus” Feature Overview and Configuration Guide](#).

**Syntax** `show ipv6 mld interface [<interface>]`

| Parameter   | Description     |
|-------------|-----------------|
| <interface> | Interface name. |

**Mode** User Exec and Privileged Exec

**Example** The following command displays MLD interface status on all interfaces enabled for MLD:

```
awplus# show ipv6 mld interface
```

## Output

```
awplus#show ipv6 mld interface
Interface vlan1 (Index 301)
 MLD Enabled, Active, Querier, Version 2 (default)
 Internet address is fe80::215:77ff:fec9:7468
 MLD interface has 0 group-record states
 MLD activity: 0 joins, 0 leaves
 MLD robustness variable is 2
 MLD last member query count is 2
 MLD query interval is 125 seconds
 MLD querier timeout is 255 seconds
 MLD max query response time is 10 seconds
 Last member query response interval is 1000 milliseconds
 Group Membership interval is 260 seconds
 MLD Snooping is globally enabled
 MLD Snooping is enabled on this interface
 MLD Snooping fast-leave is not enabled
 MLD Snooping querier is enabled
 MLD Snooping report suppression is enabled
```

# show ipv6 mld snooping mrouter

**Overview** Use this command to display the multicast router interfaces, both configured and learned, in a VLAN. If you do not specify a VLAN interface then all the VLAN interfaces are displayed.

For information on filtering and saving command output, see the [“Getting Started with AlliedWare Plus” Feature Overview and Configuration Guide](#).

**Syntax** `show ipv6 mld snooping mrouter [<interface>]`

| Parameter   | Description                                                                                                                                |
|-------------|--------------------------------------------------------------------------------------------------------------------------------------------|
| <interface> | Optional. Specify the name of the VLAN interface. Note: If you do not specify a single VLAN interface, then all VLAN interfaces are shown. |

**Mode** User Exec and Privileged Exec

**Examples** The following command displays the multicast router interfaces in `vlan2`:

```
awplus# show ipv6 mld snooping mrouter vlan2
```

## Output

```
awplus#show ipv6 mld snooping mrouter vlan2
VLAN Interface Static/Dynamic
2 port1.0.2 Dynamically Learned
2 port1.0.3 Dynamically Learned
```

The following command displays the multicast router interfaces for all VLAN interfaces:

```
awplus# show ipv6 mld snooping mrouter
```

## Output

```
awplus#show ipv6 mld snooping mrouter
VLAN Interface Static/Dynamic
2 port1.0.2 Dynamically Learned
2 port1.0.3 Dynamically Learned
3 port1.0.4 Statically Assigned
3 port1.0.5 Statically Assigned
```



# show ipv6 mld snooping statistics

**Overview** Use this command to display MLD Snooping statistics data.

For information on filtering and saving command output, see the [“Getting Started with AlliedWare Plus” Feature Overview and Configuration Guide](#).

**Syntax** `show ipv6 mld snooping statistics interface <interface>`

| Parameter   | Description                     |
|-------------|---------------------------------|
| <interface> | The name of the VLAN interface. |

**Mode** User Exec and Privileged Exec

**Example** The following command displays MLDv2 statistical information for `vlan1`:

```
awplus# show ipv6 mld snooping statistics interface vlan1
```

## Output

```
awplus#show ipv6 mld snooping statistics interface vlan1
MLD Snooping statistics for vlan1
Interface: port1.0.1
Group: ff08::1
Uptime: 00:02:18
Group mode: Include ()
Last reporter: fe80::eecd:6dff:fe6b:4783
Group source list: (R - Remote, M - SSM Mapping, S - Static)
Source Address Uptime v2 Exp Fwd Flags
2001:db8::1 00:02:18 00:02:02 Yes R
2001:db8::3 00:02:18 00:02:02 Yes R
```

# 37

# Multicast Commands

## Introduction

**Overview** This chapter provides an alphabetical reference of multicast commands for configuring:

- IPv4 and IPv6 multicast forwarding
- IPv4 and IPv6 static multicast routes
- mroutes (routes back to a multicast source)

For commands for other multicast protocols, see:

- [IGMP and IGMP Snooping Commands](#)
- [MLD and MLD Snooping Commands](#)
- [PIM-SM Commands](#)
- [PIM-SMv6 Commands](#)

**NOTE:** Before using PIM-SMv6 commands, IPv6 must be enabled on an interface with the *ipv6 enable* command, IPv6 forwarding must be enabled globally for routing IPv6 with the *ipv6 forwarding* command, and IPv6 multicasting must be enabled globally with the *ipv6 multicast-routing* command.

Static IPv6 multicast routes take priority over dynamic IPv6 multicast routes. Use the *clear ipv6 mroute* command to clear static IPv6 multicast routes and ensure dynamic IPv6 multicast routes can take over from previous static IPv6 multicast routes.

The IPv6 Multicast addresses shown can be derived from IPv6 unicast prefixes as per RFC 3306. The IPv6 unicast prefix reserved for documentation is 2001:0db8::/32 as per RFC 3849. Using the base /32 prefix the IPv6 multicast prefix for 2001:0db8::/32 is ff3x:20:2001:0db8::/64. Where an RP address is 2001:0db8::1 the embedded RP multicast prefix is ff7x:120:2001:0db8::/96. For ASM (Any-Source Multicast) the IPv6 multicast addresses allocated for documentation purposes are ff0x::0db8:0:0/96 as per RFC 6676. This is a /96 prefix so that it can be used with group IDs as per RFC 3307. These addresses should not be used for practical networks (other than for testing purposes), nor should they appear in any public network.

*The IPv6 addresses shown use the address space 2001:0db8::/32, defined in RFC 3849 for documentation purposes. These addresses should not be used for practical networks (other than for testing purposes) nor should they appear on any public network.*

- Command List**
- [“clear ip mroute”](#) on page 1660
  - [“clear ip mroute statistics”](#) on page 1661
  - [“clear ipv6 mroute”](#) on page 1662
  - [“clear ipv6 mroute statistics”](#) on page 1663
  - [“debug nsm mcast”](#) on page 1664
  - [“debug nsm mcast6”](#) on page 1665
  - [“ip mroute”](#) on page 1666
  - [“ip multicast route”](#) on page 1668
  - [“ip multicast route-limit”](#) on page 1670
  - [“ip multicast wrong-vif-suppression”](#) on page 1671
  - [“ip multicast-routing”](#) on page 1672
  - [“ipv6 mroute”](#) on page 1673
  - [“ipv6 multicast route”](#) on page 1675
  - [“ipv6 multicast route-limit”](#) on page 1677
  - [“ipv6 multicast-routing”](#) on page 1678
  - [“multicast”](#) on page 1679
  - [“show ip mroute”](#) on page 1680
  - [“show ip mvif”](#) on page 1682
  - [“show ip rpf”](#) on page 1683
  - [“show ipv6 mroute”](#) on page 1684
  - [“show ipv6 multicast forwarding”](#) on page 1686
  - [“show ipv6 mif”](#) on page 1687

# clear ip mroute

**Overview** Use this command to delete entries from the IPv4 multicast routing table.

**NOTE:** If you use this command, you should also use the [clear ip igmp group](#) command to clear IGMP group membership records.

**Syntax** `clear ip mroute {*|<ipv4-group-address>  
<ipv4-source-address>} [pim sparse-mode]`

| Parameter             | Description                                                            |
|-----------------------|------------------------------------------------------------------------|
| *                     | Deletes all multicast routes.                                          |
| <ipv4-group-address>  | Group IPv4 address, in dotted decimal notation in the format A.B.C.D.  |
| <ipv4-source-address> | Source IPv4 address, in dotted decimal notation in the format A.B.C.D. |
| pim sparse-mode       | Clear specified IPv4 multicast route(s) for PIM Sparse Mode only.      |

**Mode** Privileged Exec

**Usage** When this command is used, the Multicast Routing Information Base (MRIB) clears the IPv4 multicast route entries in its IPv4 multicast route table, and removes the entries from the multicast forwarder. The MRIB sends a "clear" message to the multicast protocols. Each multicast protocol has its own "clear" multicast route command. The protocol-specific "clear" command clears multicast routes from PIM Sparse Mode, and also clears the routes from the MRIB.

**Examples** `awplus# clear ip mroute 225.1.1.1 192.168.3.3`  
`awplus# clear ip mroute *`

**Related Commands** [ip multicast route](#)  
[show ip mroute](#)

# clear ip mroute statistics

**Overview** Use this command to delete multicast route statistics entries from the IP multicast routing table.

**Syntax** `clear ip mroute statistics {*|<ipv4-group-addr>  
[<ipv4-source-addr>]}`

| Parameter          | Description                                                            |
|--------------------|------------------------------------------------------------------------|
| *                  | All multicast route entries.                                           |
| <ipv4-group-addr>  | Group IPv4 address, in dotted decimal notation in the format A.B.C.D.  |
| <ipv4-source-addr> | Source IPv4 address, in dotted decimal notation in the format A.B.C.D. |

**Mode** Privileged Exec

**Example** `awplus# clear ip mroute statistics 225.1.1.2 192.168.4.4`  
`awplus# clear ip mroute statistics *`

# clear ipv6 mroute

**Overview** Use this command to delete one or more dynamically-added route entries from the IPv6 multicast routing table.

You need to do this, for example, if you want to create a static route instead of an existing dynamic route.

**Syntax** `clear ipv6 mroute {*|<ipv6-group-address>  
[<ipv6-source-address>]}`

| Parameter             | Description                                                          |
|-----------------------|----------------------------------------------------------------------|
| *                     | Deletes all dynamically-learned IPv6 multicast routes.               |
| <ipv6-group-address>  | Group IPv6 address, in hexadecimal notation in the format X.X::X.X.  |
| <ipv6-source-address> | Source IPv6 address, in hexadecimal notation in the format X.X::X.X. |

**Mode** Privileged Exec

**Usage** When this command is used, the Multicast Routing Information Base (MRIB) clears the relevant IPv6 multicast route entries in its IPv6 multicast route table, and removes the entries from the multicast forwarder. The MRIB sends a "clear" message to the multicast protocols. Each multicast protocol has its own "clear" multicast route command.

This command does not remove static routes from the routing table or the configuration. To remove static routes, use the **no** parameter of the command [ipv6 multicast route](#).

**Example** `awplus# clear ipv6 mroute 2001::2 ff08::1`

**Related Commands** [ipv6 multicast route](#)  
[show ipv6 mroute](#)

# clear ipv6 mroute statistics

**Overview** Use this command to delete multicast route statistics entries from the IPv6 multicast routing table.

**NOTE:** *Static IPv6 multicast routes take priority over dynamic IPv6 multicast routes. Use the `clear ipv6 mroute` command to clear static IPv6 multicast routes and ensure dynamic IPv6 multicast routes can take over from previous static IPv6 multicast routes.*

**Syntax** `clear ipv6 mroute statistics {*|<ipv6-group-address> [<ipv6-source-address>]}`

| Parameter          | Description                                                          |
|--------------------|----------------------------------------------------------------------|
| *                  | All multicast route entries.                                         |
| <ipv6-group-addr>  | Group IPv6 address, in hexadecimal notation in the format X.X::X.X.  |
| <ipv6-source-addr> | Source IPv6 address, in hexadecimal notation in the format X.X::X.X. |

**Mode** Privileged Exec

**Examples**

```
awplus# clear ipv6 mroute statistics 2001::2 ff08::1
awplus# clear ipv6 mroute statistics *
```

# debug nsm mcast

**Overview** Use this command to debug IPv4 events in the Multicast Routing Information Base (MRIB).

This command is intended for use by Allied Telesis authorized service personnel for diagnostic purposes.

**Syntax** `debug nsm mcast`  
{all|fib-msg|mrt|mtrace|mtrace-detail|register|stats|vif}

| Parameter     | Description                                 |
|---------------|---------------------------------------------|
| all           | All IPv4 multicast debugging.               |
| fib-msg       | Forwarding Information Base (FIB) messages. |
| mrt           | Multicast routes.                           |
| mtrace        | Multicast traceroute.                       |
| mtrace-detail | Multicast traceroute detailed debugging.    |
| register      | Multicast PIM register messages.            |
| stats         | Multicast statistics.                       |
| vif           | Multicast interface.                        |

**Mode** Privileged Exec and Global Configuration

**Examples** To enable debugging of all multicast route events, use the commands:

```
awplus# configure terminal
awplus(config)# debug nsm mcast all
```

To enable debugging of PIM register entries, use the commands:

```
awplus# configure terminal
awplus(config)# debug nsm mcast register
```



# debug nsm mcast6

**Overview** Use this command to debug IPv6 events in the Multicast Routing Information Base (MRIB).

This command is intended for use by Allied Telesis authorized service personnel for diagnostic purposes.

**Syntax** debug nsm mcast6 {all|fib-msg|mrt|register|stats|vif}  
no debug nsm mcast6 {all|fib-msg|mrt|register|stats|vif}

| Parameter | Description                                 |
|-----------|---------------------------------------------|
| all       | All IPv6 multicast route debugging.         |
| fib-msg   | Forwarding Information Base (FIB) messages. |
| mrt       | Multicast routes.                           |
| register  | Multicast PIM register messages.            |
| stats     | Multicast statistics.                       |
| vif       | Multicast interfaces.                       |

**Mode** Privileged Exec and Global Configuration

**Examples** To enable debugging of all multicast route events, use the commands:

```
awplus# configure terminal
awplus(config)# debug nsm mcast6 all
```

To enable debugging of PIM register entries, use the commands:

```
awplus# configure terminal
awplus(config)# debug nsm mcast6 register
```

# ip mroute

**Overview** Use this command to inform multicast of the RPF (Reverse Path Forwarding) route to a given IPv4 multicast source.

Use the **no** variant of this command to delete a route to an IPv4 multicast source.

**Syntax**

```
ip mroute <ipv4-source-address/mask-length>
[bgp|ospf|rip|static] <rpf-address> [<admin-distance>]

no ip mroute <ipv4-source-address/mask-length>
[bgp|ospf|rip|static]
```

| Parameter                         | Description                                                                                                                                                                                                                                                                                                                                    |
|-----------------------------------|------------------------------------------------------------------------------------------------------------------------------------------------------------------------------------------------------------------------------------------------------------------------------------------------------------------------------------------------|
| <ipv4-source-address/mask-length> | A multicast source IPv4 address and mask length, in dotted decimal notation in the format A.B.C.D/M.                                                                                                                                                                                                                                           |
| bgp                               | BGP unicast routing protocol.                                                                                                                                                                                                                                                                                                                  |
| ospf                              | OSPF unicast routing protocol.                                                                                                                                                                                                                                                                                                                 |
| rip                               | RIP unicast routing protocol.                                                                                                                                                                                                                                                                                                                  |
| static                            | Specifies a static route.                                                                                                                                                                                                                                                                                                                      |
| <rpf-address>                     | A.B.C.D<br>The closest known address on the multicast route back to the specified source. This host IPv4 address can be within a directly connected subnet or within a remote subnet. In the case that the address is in a remote subnet, a lookup is done from the unicast route table to find the next hop address on the path to this host. |
| <admin-distance>                  | The administrative distance. Use this to determine whether the RPF lookup selects the unicast or multicast route. Lower distances have preference. If the multicast static route has the same distance as the other RPF sources, the multicast static route takes precedence. The default is 0 and the range available is 0-255.               |

**Mode** Global Configuration

**Usage** Typically, when a Layer 3 multicast routing protocol is determining the RPF (Reverse Path Forwarding) interface for the path to an IPv4 multicast source, it uses the unicast route table to find the best path to the source. However, in some networks a deliberate choice is made to send multicast via different paths to those used for unicast. In this case, the interface via which a multicast stream from a given source enters a router may not be the same as the interface that connects to the best unicast route to that source.

This command enables the user to statically configure the device with “multicast routes” back to given sources. When performing the RPF check on a stream from a given IPv4 source, the multicast routing protocol will look at these static entries as well as looking into the unicast routing table. The route with the lowest

administrative distance - whether a static "multicast route" or a route from the unicast route table - will be chosen as the RPF route to the source.

Note that in this context the term "multicast route" does not imply a route via which the current router will forward multicast; instead it refers to the route the multicast will have traversed in order to arrive at the current router.

**Examples** The following example creates a static multicast IPv4 route back to the sources in the 10.10.3.0/24 subnet. The multicast route is via the host 192.168.2.3, and has an administrative distance of 2:

```
awplus# configure terminal
awplus(config)# ip mroute 10.10.3.0/24 static 2 192.168.2.3 2
```

The following example creates a static multicast IPv4 route back to the sources in the 192.168.3.0/24 subnet. The multicast route is via the host 10.10.10.50. The administrative distance on this route has the default value of 0:

```
awplus# configure terminal
awplus(config)# ip mroute 192.168.3.0/24 10.10.10.50
```

**Validation  
Commands** `show ip rpf`

# ip multicast route

**Overview** Use this command to add an IPv4 static multicast route for a specific multicast source and group IPv4 address to the multicast Routing Information Base (RIB). This IPv4 multicast route is used to forward multicast traffic from a specific source and group ingress on an upstream VLAN to a single or range of downstream VLANs.

Use the **no** variant of this command to either remove an IPv4 static multicast route set with this command or to remove a specific downstream VLAN interface from an IPv4 static multicast route for a specific multicast source and group IPv4 address.

**Syntax**

```
ip multicast route <ipv4-source-addr> <ipv4-group-addr>
<upstream-vlan-id> [<downstream-vlan-id>]

no ip multicast route <ipv4-source-addr> <ipv4-group-addr>
[<upstream-vlan-id> <downstream-vlan-id>]
```

| Parameter            | Description                                                                                    |
|----------------------|------------------------------------------------------------------------------------------------|
| <ipv4-source-addr>   | Source IPv4 address, in dotted decimal notation in the format A.B.C.D.                         |
| <ipv4-group-addr>    | Group IPv4 address, in dotted decimal notation in the format A.B.C.D.                          |
| <upstream-vlan-id>   | Upstream VLAN interface on which the multicast packets ingress.                                |
| <downstream-vlan-id> | Downstream VLAN interface or range of VLAN interfaces to which the multicast packets are sent. |

**Default** By default, this feature is disabled.

**Mode** Global Configuration

**Usage** Only one multicast route entry per IPv4 address and multicast group can be specified. Therefore, if one entry for a static multicast route is configured, PIM will not be able to update this multicast route in any way.

If a dynamic multicast route exists you cannot create a static multicast route with same source IPv4 address, group IPv4 address, upstream VLAN and downstream VLANs. An error message is displayed and logged. To add a new static multicast route, either wait for the dynamic multicast route to timeout or clear the dynamic multicast route with the [clear ip mroute](#) command.

To update an existing static multicast route entry with more or a new set of downstream VLANs, you must firstly remove the existing static multicast route and then add the new static multicast route with all downstream VLANs specified. If you attempt to update an existing static multicast route entry with an additional VLAN or VLANs an error message is displayed and logged.

To create a blackhole or null route where packets from a specified source and group address coming from an upstream VLAN are dropped rather than

forwarded, do not specify the optional `<downstream-vlan-id>` parameter when entering this command.

To remove a specific downstream VLAN from an existing static multicast route entry, specify the VLAN you want to remove with the `<downstream-vlan-id>` parameter when entering the **no** variant of this command.

**Examples** To create a static multicast route for the multicast source IPv4 address `2.2.2.2` and group IPv4 address `224.9.10.11`, specifying the upstream VLAN interface as `vlan10` and the downstream VLAN interface as `vlan20`, use the following commands:

```
awplus# configure terminal
awplus(config)# ip multicast route 2.2.2.2 224.9.10.11 vlan10
vlan20
```

To create a blackhole route for the multicast source IPv4 address `2.2.2.2` and group IPv4 address `224.9.10.11`, specifying the upstream VLAN interface as `vlan10`, use the following commands:

To create an IPv4 static multicast route for the multicast source IPv4 address `2.2.2.2` and group IP address `224.9.10.11`, specifying the upstream VLAN interface as `vlan10` and the downstream VLAN range as `vlan20-25`, use the following commands:

```
awplus# configure terminal
awplus(config)# ip multicast route 2.2.2.2 224.9.10.11 vlan10
vlan20-25
```

To remove the downstream VLAN 23 from the IPv4 static multicast route created with the above command, use the following commands:

```
awplus# configure terminal
awplus(config)# no ip multicast route 2.2.2.2 224.9.10.11
vlan10 vlan23
```

To delete an IPv4 static multicast route for the multicast source IP address `2.2.2.2` and group IP address `224.9.10.11`, use the following commands:

```
awplus# configure terminal
awplus(config)# no ip multicast route 2.2.2.2 224.9.10.11
```

**Related  
Commands** [clear ip mroute](#)  
[show ip mroute](#)

# ip multicast route-limit

**Overview** Use this command to limit the number of multicast routes that can be added to an IPv4 multicast routing table.

Use the **no** variant of this command to return the IPv4 route limit to the default.

**Syntax** `ip multicast route-limit <limit> [<threshold>]`  
`no ip multicast route-limit`

| Parameter                      | Description                                                                                                                                           |
|--------------------------------|-------------------------------------------------------------------------------------------------------------------------------------------------------|
| <code>&lt;limit&gt;</code>     | <code>&lt;1-2147483647&gt;</code> Number of routes.                                                                                                   |
| <code>&lt;threshold&gt;</code> | <code>&lt;1-2147483647&gt;</code> Threshold above which to generate a warning message. The mroute warning threshold must not exceed the mroute limit. |

**Default** The default limit and threshold value is 2147483647.

**Mode** Global Configuration

**Usage** This command limits the number of multicast IPv4 routes (mroutes) that can be added to a router, and generates an error message when the limit is exceeded. If the threshold parameter is set, a threshold warning message is generated when this threshold is exceeded, and the message continues to occur until the number of mroutes reaches the limit set by the limit argument.

**Examples**

```
awplus# configure terminal
awplus(config)# ip multicast route-limit 34 24
awplus# configure terminal
awplus(config)# no ip multicast route-limit
```

# ip multicast wrong-vif-suppression

**Overview** Use this command to prevent unwanted multicast packets received on an unexpected VLAN being trapped to the CPU.

Use the no variant of this command to disable wrong VIF suppression.

**Syntax** `ip ip multicast wrong-vif-suppression`  
`no ip multicast wrong-vif-suppression`

**Default** By default, this feature is disabled.

**Mode** Global Configuration

**Usage** Use this command if there is excessive CPU load and multicast traffic is enabled. To confirm that VIF messages are being sent to the CPU use the `debug nsm mcast6` command.

**Examples** To enable the suppression of wrong VIF packets, use the following commands:

```
awplus# configure terminal
awplus(config)# ip multicast wrong-vif-suppression
```

To disable the suppression of wrong VIF packets, use the following commands:

```
awplus# configure terminal
awplus(config)# no ip multicast wrong-vif-suppression
```

# ip multicast-routing

**Overview** Use this command to turn on/off IPv4 multicast routing on the router; when turned off the device does not perform multicast functions.

Use the **no** variant of this command to disable IPv4 multicast routing after enabling it. Note the default stated below.

**Syntax** `ip multicast-routing`  
`no ip multicast-routing`

**Default** By default, IPv4 multicast routing is off.

**Mode** Global Configuration

**Usage** When the **no** variant of this command is used, the Multicast Routing Information Base (MRIB) cleans up Multicast Routing Tables (MRT), stops IGMP operation, and stops relaying multicast forwarder events to multicast protocols.

When multicast routing is enabled, the MRIB starts processing any MRT addition/deletion requests, and any multicast forwarding events.

You must enable multicast routing before issuing other multicast commands.

**Example** `awplus# configure terminal`  
`awplus(config)# ip multicast-routing`

**Validation  
Commands** `show running-config`



# ipv6 mroute

**Overview** Use this command to inform multicast of the RPF (Reverse Path Forwarding) route to a given IPv6 multicast source.

Use the **no** variant of this command to delete a route to an IPv6 multicast source.

JC - 25/6/12 - added missing IPI IPv6 multicast commands that have been in since 5.4.1 as undocumented and unregistered CLI commands but have been available in 5.4.1/5.4.2 sw - this is out for 542-25 but should be added back in for 543 - check in with Team Zeta on it

**Syntax** `ipv6 mroute <ipv6-source-address/mask-length> [rip|static] <rpf-address> [<admin-distance>]`

`no ipv6 mroute <ipv6-source-address/mask-length> [rip|static]`

| Parameter                                            | Description                                                                                                                                                                                                                                                                                                                                         |
|------------------------------------------------------|-----------------------------------------------------------------------------------------------------------------------------------------------------------------------------------------------------------------------------------------------------------------------------------------------------------------------------------------------------|
| <code>&lt;ipv6-source-address/mask-length&gt;</code> | A multicast source IPv6 address and mask length, in hexadecimal notation in the format X.X::X.X/M.                                                                                                                                                                                                                                                  |
| <code>rip</code>                                     | RIPng IPv6 unicast routing protocol.                                                                                                                                                                                                                                                                                                                |
| <code>static</code>                                  | Specifies a static route.                                                                                                                                                                                                                                                                                                                           |
| <code>&lt;rpf-address&gt;</code>                     | X.X::X:X<br>The closest known address on the IPv6 multicast route back to the specified source. This host IPv6 address can be within a directly connected subnet or within a remote subnet. In the case that the address is in a remote subnet, a lookup is done from the unicast route table to find the nexthop address on the path to this host. |
| <code>&lt;admin-distance&gt;</code>                  | The administrative distance. Use this to determine whether the RPF lookup selects the unicast or multicast route. Lower distances have preference. If the multicast static route has the same distance as the other RPF sources, the multicast static route takes precedence. The default is 0 and the range available is 0-255.                    |

**Mode** Global Configuration

**Usage** Typically, when a Layer 3 multicast routing protocol is determining the RPF (Reverse Path Forwarding) interface for the path to a multicast source, it uses the unicast IPv6 route table to find the best path to the source. However, in some networks a deliberate choice is made to send multicast via different paths to those used for unicast. In this case, the interface via which a multicast stream from a given source enters a router may not be the same as the interface that connects to the best unicast route to that source.

This command enables the user to statically configure the switch with "multicast routes" back to given sources. When performing the RPF check on a stream from a

given IPv6 source, the multicast routing protocol will look at these static entries as well as looking into the unicast routing table. The route with the lowest administrative distance - whether a static "multicast route" or a route from the unicast route table - will be chosen as the RPF route to the source.

Note that in this context the term "multicast route" does not imply a route via which the current router will forward multicast; instead it refers to the route the multicast will have traversed in order to arrive at the current router.

**Examples** The following example creates a static multicast route back to the sources in the 2001::1/64 subnet. The multicast route is via the host 2002::2, and has an administrative distance of 2:

```
awplus# configure terminal
awplus(config)# ipv6 mroute 2001::1/64 static 2 2002::2
```

The following example creates a static multicast route back to the sources in the 2002::2/64 subnet. The multicast route is via the host 2001::1. The administrative distance on this route has the default value of 0:

```
awplus# configure terminal
awplus(config)# ipv6 mroute 2002::2/64 2001::1
```

**Validation Commands** `show ipv6 mroute`

# ipv6 multicast route

**Overview** Use this command to add an IPv6 static multicast route for a specific multicast source and group IPv6 address to the multicast Routing Information Base (RIB). This IPv6 multicast route is used to forward IPv6 multicast traffic from a specific source and group ingressing on an upstream VLAN to a single or range of downstream VLANs.

See detailed usage notes below to configure static multicast router ports when using static IPv6 multicast routes with EPSR, and the destination VLAN is an EPSR data VLAN.

Use the **no** variant of this command to either remove an IPv6 static multicast route set with this command or to remove a specific downstream VLAN interface from an IPv6 static multicast route for a specific IPv6 multicast source and group address.

**Syntax** `ipv6 multicast route <ipv6-source-addr> <ipv6-group-addr> <upstream-vlan-id> [<downstream-vlan-id>]`  
`no ipv6 multicast route <ipv6-source-addr> <ipv6-group-addr> [<upstream-vlan-id> <downstream-vlan-id>]`

| Parameter                               | Description                                                                                    |
|-----------------------------------------|------------------------------------------------------------------------------------------------|
| <code>&lt;ipv6-group-addr&gt;</code>    | Source IPv6 address, in dotted decimal notation in the format X.X::X.X.                        |
| <code>&lt;ipv6-group-addr&gt;</code>    | Group IP address, in dotted decimal notation in the format X.X::X.X.                           |
| <code>&lt;upstream-vlan-id&gt;</code>   | Upstream VLAN interface on which the multicast packets ingress.                                |
| <code>&lt;downstream-vlan-id&gt;</code> | Downstream VLAN interface or range of VLAN interfaces to which the multicast packets are sent. |

**Default** By default, no static routes exist.

**Mode** Global Configuration

**Usage** Only one multicast route entry per IPv6 address and multicast group can be specified. Therefore, if one entry for an IPv6 static multicast route is configured, PIM will not be able to update this multicast route in any way.

If a dynamic multicast route exists, you cannot create a static multicast route with the same source IPv6 address and group IPv6 address. An error message is displayed and logged. To add a new static multicast route, either wait for the dynamic multicast route to time out or clear the dynamic multicast route with the [clear ipv6 mroute](#) command.

To update an existing IPv6 static multicast route entry with new or additional downstream VLANs, you must firstly remove the existing static multicast route and then add the new static multicast route with all downstream VLANs specified. If

you attempt to update an existing static multicast route entry with an additional VLAN or VLANs an error message is displayed and logged.

To remove a specific downstream VLAN from an existing static multicast route entry, specify the VLAN you want to remove with the `<downstream-vlan-id>` parameter when entering the **no** variant of this command.

Note that if static IPv6 multicast routing is being used with EPSR and the destination VLAN is an EPSR data VLAN, then multicast router (mrouter) ports must be statically configured. This minimizes disruption for multicast traffic in the event of ring failure or restoration.

When configuring the EPSR data VLAN, statically configure mrouter ports so that the multicast router can be reached in either direction around the EPSR ring.

See [ipv6 mld snooping mrouter](#) for a command description and command examples.

**Examples** To create an IPv6 static multicast route for the multicast source IPv6 address `2001::1` and group IPv6 address `ff08::1`, specifying the upstream VLAN interface as `vlan10` and the downstream VLAN interface as `vlan20`, use the following commands:

```
awplus# configure terminal
awplus(config)# ipv6 multicast route 2001::1 ff08::1 vlan10
vlan20
```

To create a blackhole route for the IPv6 multicast source IP address `2001::1` and group IP address `ff08::1`, specifying the upstream VLAN interface as `vlan10`, use the following commands:

To create an IPv6 static multicast route for the multicast source IPv6 address `2001::1` and group IPv6 address `ff08::1`, specifying the upstream VLAN interface as `vlan10` and the downstream VLAN range as `vlan20-25`, use the following commands:

```
awplus# configure terminal
awplus(config)# ipv6 multicast route 2001::1 ff08::1 vlan10
vlan20-25
```

To remove the downstream VLAN 23 from the IPv6 static multicast route created with the above command, use the following commands:

```
awplus# configure terminal
awplus(config)# no ipv6 multicast route 2001::1 ff08::1 vlan10
vlan23
```

To delete an IPv6 static multicast route for the multicast source IPv6 address `2001::1` and group IPv6 address `ff08::1`, use the following commands:

```
awplus# configure terminal
awplus(config)# no ipv6 multicast route 2001::1 ff08::1
```

**Related Commands**

- [clear ipv6 mroute](#)
- [ipv6 mld snooping mrouter](#)
- [show ipv6 mroute](#)

# ipv6 multicast route-limit

**Overview** Use this command to limit the number of multicast routes that can be added to an IPv6 multicast routing table.

Use the no variant of this command to return the IPv6 route limit to the default.

**Syntax** `ipv6 multicast route-limit <limit> [<threshold>]`  
`no ipv6 multicast route-limit`

| Parameter                      | Description                                                                                                                                           |
|--------------------------------|-------------------------------------------------------------------------------------------------------------------------------------------------------|
| <code>&lt;limit&gt;</code>     | <code>&lt;1-2147483647&gt;</code> Number of routes.                                                                                                   |
| <code>&lt;threshold&gt;</code> | <code>&lt;1-2147483647&gt;</code> Threshold above which to generate a warning message. The mroute warning threshold must not exceed the mroute limit. |

**Default** The default limit and threshold value is 2147483647.

**Mode** Global Configuration

**Usage** This command limits the number of multicast IPv6 routes (mroutes) that can be added to a router, and generates an error message when the limit is exceeded. If the threshold parameter is set, a threshold warning message is generated when this threshold is exceeded, and the message continues to occur until the number of mroutes reaches the limit set by the limit argument.

**Examples**

```
awplus# configure terminal
awplus(config)# ipv6 multicast route-limit 34 24
awplus# configure terminal
awplus(config)# no ipv6 multicast route-limit
```

# ipv6 multicast-routing

**Overview** Use this command to turn on/off IPv6 multicast routing on the router; when turned off the device does not perform multicast functions.

Use the **no** variant of this command to disable IPv6 multicast routing after enabling it. Note the default stated below.

**Syntax** `ipv6 multicast-routing`  
`no ipv6 multicast-routing`

**Default** By default, IPv6 multicast routing is off.

**Mode** Global Configuration

**Usage** When the **no** variant of this command is used, the Multicast Routing Information Base (MRIB) cleans up Multicast Routing Tables (MRT), and stops relaying multicast forwarder events to multicast protocols.

When multicast routing is enabled, the MRIB starts processing any MRT addition/deletion requests, and any multicast forwarding events.

You must enable multicast routing before issuing other multicast commands.

**Examples** `awplus# configure terminal`  
`awplus(config)# ipv6 multicast-routing`  
`awplus# configure terminal`  
`awplus(config)# no ipv6 multicast-routing`

**Validation Commands** `show running-config`

# multicast

**Overview** Use this command to enable a device port to route multicast packets that ingress the port.

Use the **no** variant of this command to stop the device port from routing multicast packets that ingress the port. Note that this does not affect Layer 2 forwarding of multicast packets. If you enter **no multicast** on a port, multicast packets received on that port will not be forwarded to other VLANs, but ports in the same VLANs as the receiving port will still receive the multicast packets.

**CAUTION:** *We do not recommend disabling multicast routing in a live network. Some non-multicast protocols use multicast packets and will not function correctly if you disable it.*

**Syntax** multicast  
no multicast

**Default** By default, all device ports route multicast packets.

**Mode** Interface Configuration

**Examples** To disable routing of multicast packets on a port, use the commands:

```
awplus# configure terminal
awplus(config)# interface port1.0.1
awplus(config-if)# no multicast
```

To re-enable routing of multicast packets on a port, use the commands:

```
awplus# configure terminal
awplus(config)# interface port1.0.1
awplus(config-if)# multicast
```

**Validation Commands** `show running-config`

# show ip mroute

**Overview** Use this command to display the contents of the IPv4 multicast routing (mroute) table.

**Syntax** `show ip mroute [<ipv4-group-addr>] [<ipv4-source-addr>] [{dense|sparse}] [{count|summary}]`

| Parameter          | Description                                                                               |
|--------------------|-------------------------------------------------------------------------------------------|
| <ipv4-group-addr>  | Group IPv4 address, in dotted decimal notation in the format A.B.C.D.                     |
| <ipv4-source-addr> | Source IPv4 address, in dotted decimal notation in the format A.B.C.D.                    |
| dense              | Display dense IPv4 multicast routes.                                                      |
| sparse             | Display sparse IPv4 multicast routes.                                                     |
| count              | Display the route and packet count from the IPv4 multicast routing (mroute) table.        |
| summary            | Display the contents of the IPv4 multicast routing (mroute) table in an abbreviated form. |

**Mode** User Exec and Privileged Exec

**Examples**

```
awplus# show ip mroute 10.10.3.34 224.1.1.4.3
awplus# show ip mroute 10.10.5.24 225.2.2.2 count
awplus# show ip mroute 10.10.1.34 summary
```

**Output** The following is a sample output of this command displaying the IPv4 multicast routing table, with and without specifying the group and source IPv4 address:

Figure 37-1: Example output from the **show ip mroute** command

```
awplus# show ip mroute
IP Multicast Routing Table
Flags: I - Immediate Stat, T - Timed Stat, F - Forwarder
installed
Timers: Uptime/Stat Expiry
Interface State: Interface (TTL)

(10.10.1.52, 224.0.1.3), uptime 00:00:31, stat expires 00:02:59
Owner PIM-SM, Flags: TF
 Incoming interface: vlan2
 Outgoing interface list:
 vlan3 (1)
```



Figure 37-2: Example output from the **show ip mroute** command with the source and group IPv4 address specified

```
awplus# show ip mroute 10.10.1.52 224.0.1.3

IP Multicast Routing Table
Flags: I - Immediate Stat, T - Timed Stat, F - Forwarder
installed
Timers: Uptime/Stat Expiry
Interface State: Interface (TTL)

(10.10.1.52, 224.0.1.3), uptime 00:03:24, stat expires 00:01:28
Owner PIM-SM, Flags: TF
 Incoming interface: vlan2
 Outgoing interface list:
 vlan3 (1)
```

The following is a sample output of this command displaying the packet count from the IPv4 multicast routing table:

Figure 37-3: Example output from the **show ip mroute count** command

```
awplus# show ip mroute count
IP Multicast Statistics
Total 1 routes using 132 bytes memory
Route limit/Route threshold: 2147483647/2147483647
Total NOCACHE/WROGVIF/WHOLEPKT rcv from fwd: 1/0/0
Total NOCACHE/WROGVIF/WHOLEPKT sent to clients: 1/0/0
Immediate/Timed stat updates sent to clients: 0/0
Reg ACK rcv/Reg NACK rcv/Reg pkt sent: 0/0/0
Next stats poll: 00:01:10

Forwarding Counts: Pkt count/Byte count, Other Counts: Wrong If
pkts
Fwd msg counts: WROGVIF/WHOLEPKT rcv
Client msg counts: WROGVIF/WHOLEPKT/Imm Stat/Timed Stat sent
Reg pkt counts: Reg ACK rcv/Reg NACK rcv/Reg pkt sent

(10.10.1.52, 224.0.1.3), Forwarding: 2/19456, Other: 0
 Fwd msg: 0/0, Client msg: 0/0/0/0, Reg: 0/0/0
```

The following is a sample output for this command displaying the IPv4 multicast routing table in an abbreviated form:

Figure 37-4: Example output from the **show ip mroute summary** command

```
awplus# show ip mroute summary

IP Multicast Routing Table
Flags: I - Immediate Stat, T - Timed Stat, F - Forwarder
installed
Timers: Uptime/Stat Expiry
Interface State: Interface (TTL)

(10.10.1.52, 224.0.1.3), 00:01:32/00:03:20, PIM-SM, Flags: TF
```

# show ip mvif

**Overview** Use this command to display the contents of the IPv4 Multicast Routing Information Base (MRIB) VIF table.

**Syntax** `show ip mvif <interface>`

| Parameter   | Description                                 |
|-------------|---------------------------------------------|
| <interface> | The interface to display information about. |

**Mode** User Exec and Privileged Exec

**Example** `awplus# show ip mvif vlan2`

**Output** Figure 37-5: Example output from the **show ip mvif** command

| Interface | Vif Idx | Owner Module | TTL | Local Address | Remote Address | Uptime   |
|-----------|---------|--------------|-----|---------------|----------------|----------|
| vlan2     | 0       | PIM-SM       | 1   | 192.168.1.53  | 0.0.0.0        | 00:04:26 |
| Register  | 1       |              | 1   | 192.168.1.53  | 0.0.0.0        | 00:04:26 |
| vlan3     | 2       | PIM-SM       | 1   | 192.168.10.53 | 0.0.0.0        | 00:04:25 |

Figure 37-6: Example output from the **show ip mvif** command with the interface parameter **vlan2** specified

| Interface | Vif Idx | Owner Module | TTL | Local Address | Remote Address | Uptime   |
|-----------|---------|--------------|-----|---------------|----------------|----------|
| vlan2     | 0       | PIM-SM       | 1   | 192.168.1.53  | 0.0.0.0        | 00:05:17 |

# show ip rpf

**Overview** Use this command to display Reverse Path Forwarding (RPF) information for the specified IPv4 source address.

**Syntax** `show ip rpf <source-addr>`

| Parameter                        | Description                                                            |
|----------------------------------|------------------------------------------------------------------------|
| <code>&lt;source-addr&gt;</code> | Source IPv4 address, in dotted decimal notation in the format A.B.C.D. |

**Mode** User Exec and Privileged Exec

**Example** `awplus# show ip rpf 10.10.10.50`

# show ipv6 mroute

**Overview** Use this command to display the contents of the IPv6 multicast routing (mroute) table.

**Syntax** `show ipv6 mroute [<ipv6-group-addr>] [<ipv6-source-addr>] [{count|summary}]`

| Parameter                             | Description                                                                               |
|---------------------------------------|-------------------------------------------------------------------------------------------|
| <code>&lt;ipv6-group-addr&gt;</code>  | Group IPv6 address, in hexadecimal notation in the format X.X::X.X.                       |
| <code>&lt;ipv6-source-addr&gt;</code> | Source IPv6 address, in hexadecimal notation in the format X.X::X.X.                      |
| <code>count</code>                    | Display the route and packet count from the IPv6 multicast routing (mroute) table.        |
| <code>summary</code>                  | Display the contents of the IPv6 multicast routing (mroute) table in an abbreviated form. |

**Mode** User Exec and Privileged Exec

**Examples**

```
awplus# show ipv6 mroute
awplus# show ipv6 mroute count
awplus# show ipv6 mroute summary
awplus# show ipv6 mroute 2001::2 ff08::1 count
awplus# show ipv6 mroute 2001::2 ff08::1
awplus# show ipv6 mroute 2001::2 summary
```

**Output** The following is a sample output of this command displaying the IPv6 multicast routing table for a single static IPv6 Multicast route:

Figure 37-7: Example output from the **show ipv6 mroute** command

```
awplus#show ipv6 mroute
IPv6 Multicast Routing Table
Flags: I - Immediate Stat, T - Timed Stat, F - Forwarder
installed
Timers: Uptime/Stat Expiry
Interface State: Interface
(2001::2, ff08::1), uptime 03:18:38
Owner IMI, Flags: F
 Incoming interface: vlan2
 Outgoing interface list:
 vlan3
```

The following is a sample output of this command displaying the IPv6 multicast routing count table for a single static IPv6 Multicast route:

Figure 37-8: Example output from the **show ipv6 mroute count** command

```
awplus#show ipv6 mroute count

IPv6 Multicast Statistics
Total 1 routes using 152 bytes memory
Route limit/Route threshold: 1024/1024
Total NOCACHE/WRONGmif/WHOLEPKT rcv from fwd: 6/0/0
Total NOCACHE/WRONGmif/WHOLEPKT sent to clients: 6/0/0
Immediate/Timed stat updates sent to clients: 0/0
Reg ACK rcv/Reg NACK rcv/Reg pkt sent: 0/0/0
Next stats poll: 00:01:14

Forwarding Counts: Pkt count/Byte count, Other Counts: Wrong If
pkts
Fwd msg counts: WRONGmif/WHOLEPKT rcv
Client msg counts: WRONGmif/WHOLEPKT/Imm Stat/Timed Stat sent
Reg pkt counts: Reg ACK rcv/Reg NACK rcv/Reg pkt sent

(2001::2, ff08::1), Forwarding: 0/0, Other: 0
 Fwd msg: 0/0, Client msg: 0/0/0/0, Reg: 0/0/0
```

The following is a sample output of this command displaying the IPv6 multicast routing summary table for a single static IPv6 Multicast route:

Figure 37-9: Example output from the **show ipv6 mroute summary** command

```
awplus#show ipv6 mroute summary

IPv6 Multicast Routing Table
Flags: I - Immediate Stat, T - Timed Stat, F - Forwarder
installed
Timers: Uptime/Stat Expiry
Interface State: Interface

(2001::2, ff08::1), 03:20:28/-, IMI, Flags: F
```

# show ipv6 multicast forwarding

**Overview** Use this command to view the status of multicast forwarding slow-path-packet setting.

**Syntax** `show ipv6 multicast forwarding`

**Mode** User Exec

**Example** To show the status of the multicast forwarding, slow-path-packet setting, use the following command:

```
awplus# show ipv6 multicast forwarding
```

**Output** Figure 37-10: Example output from the **show ipv6 multicast forwarding** command:

```
ipv6 multicast forwarding is disabled
```

**Related Commands** [ipv6 multicast forward-slow-path-packet](#)

# show ipv6 mif

**Overview** Use this command to display the contents of the IPv6 Multicast Routing Information Base (MRIB) MIF table.

**Syntax** `show ipv6 mif [<interface>]`

| Parameter   | Description                                 |
|-------------|---------------------------------------------|
| <interface> | The interface to display information about. |

**Mode** User Exec and Privileged Exec

**Example** `awplus# show ipv6 mif`  
`awplus# show ipv6 mif vlan2`

**Output** Figure 37-11: Example output from the **show ipv6 mif** command

```
awplus#show ipv6 mif
Interface Mif Owner Uptime
 Idx Module
vlan3 0 MLD/MLD Proxy-Service 03:28:48
vlan2 1 MLD/MLD Proxy-Service 03:28:48
vlan1 2 MLD/MLD Proxy-Service 03:28:48
```

Figure 37-12: Example output from the **show ipv6 mif** command with the interface parameter **vlan2** specified

| Interface | Mif Idx | Owner Module | TTL | Remote Address | Uptime   |
|-----------|---------|--------------|-----|----------------|----------|
| vlan2     | 0       | PIM-SMv6     | 1   | 0.0.0.0        | 00:05:17 |

# 38

# PIM-SM Commands

## Introduction

**Overview** This chapter provides an alphabetical reference of PIM-SM commands. For commands common to PIM-SM and PIM-DM, see the [Multicast Commands](#) chapter.

- Command List**
- “clear ip pim sparse-mode bsr rp-set \*” on page 1690
  - “clear ip pim sparse-mode packet statistics” on page 1691
  - “clear ip mroute pim sparse-mode” on page 1692
  - “debug pim sparse-mode” on page 1693
  - “debug pim sparse-mode timer” on page 1694
  - “ip pim anycast-rp” on page 1696
  - “ip pim bsr-border” on page 1697
  - “ip pim bsr-candidate” on page 1698
  - “ip pim cisco-register-checksum” on page 1699
  - “ip pim crp-cisco-prefix” on page 1700
  - “ip pim dr-priority” on page 1701
  - “ip pim exclude-genid” on page 1702
  - “ip pim ext-srcs-directly-connected” on page 1703
  - “ip pim hello-holdtime (PIM-SM)” on page 1704
  - “ip pim hello-interval (PIM-SM)” on page 1705
  - “ip pim ignore-rp-set-priority” on page 1706
  - “ip pim jp-timer” on page 1707
  - “ip pim register-rate-limit” on page 1708
  - “ip pim register-rp-reachability” on page 1709



- [“ip pim register-source”](#) on page 1710
- [“ip pim register-suppression”](#) on page 1711
- [“ip pim rp-address”](#) on page 1712
- [“ip pim rp-candidate”](#) on page 1713
- [“ip pim rp-register-kat”](#) on page 1714
- [“ip pim sparse-mode”](#) on page 1715
- [“ip pim sparse-mode passive”](#) on page 1716
- [“ip pim spt-threshold”](#) on page 1717
- [“ip pim ssm”](#) on page 1718
- [“show debugging pim sparse-mode”](#) on page 1719
- [“show ip pim sparse-mode bsr-router”](#) on page 1720
- [“show ip pim sparse-mode interface”](#) on page 1721
- [“show ip pim sparse-mode interface detail”](#) on page 1723
- [“show ip pim sparse-mode local-members”](#) on page 1724
- [“show ip pim sparse-mode mroute”](#) on page 1725
- [“show ip pim sparse-mode mroute detail”](#) on page 1727
- [“show ip pim sparse-mode neighbor”](#) on page 1729
- [“show ip pim sparse-mode nexthop”](#) on page 1730
- [“show ip pim sparse-mode packet statistics”](#) on page 1731
- [“show ip pim sparse-mode rp-hash”](#) on page 1732
- [“show ip pim sparse-mode rp mapping”](#) on page 1733
- [“undebbug all pim sparse-mode”](#) on page 1734

# clear ip pim sparse-mode bsr rp-set \*

**Overview** Use this command to clear all Rendezvous Point (RP) sets learned through the PIMv2 Bootstrap Router (BSR).

**Syntax** `clear ip pim sparse-mode bsr rp-set *`

| Parameter | Description         |
|-----------|---------------------|
| *         | Clears all RP sets. |

**Mode** Privileged Exec

**Usage** For multicast clients, note that one router will be automatically or statically designated as the RP, and all routers must explicitly join through the RP. A Designated Router (DR) sends periodic Join/Prune messages toward a group-specific RP for each group that it has active members.

For multicast sources, note that the Designated Router (DR) unicasts Register messages to the RP encapsulating the data packets from the multicast source. The RP forwards decapsulated data packets toward group members.

**Example** `awplus# clear ip pim sparse-mode bsr rp-set *`

# clear ip pim sparse-mode packet statistics

**Overview** Use this command to clear the PIM sparse mode packet statistics counter.

**Syntax** `clear ip pim sparse-mode packet statistics`

**Mode** Privileged Exec

**Example** The following command clears the current packet receive counts for PIM sparse-mode:

```
awplus# configure terminal
awplus(config)# clear ip pim sparse-mode statistics
```

**Output** Figure 38-1: Example output from **clear ip pim sparse-mode statistics**

```
awplus(config)#clear ip pim sparse-mode statistics
PIM-SM Receive Packet Statistics :
All PIM-SM : Total : 0 Valid : 0
Hello : Total : 0 Valid : 0
Register : Total : 0 Valid : 0
Register Stop : Total : 0 Valid : 0
Join/Prune : Total : 0 Valid : 0
Bootstrap : Total : 0 Valid : 0
Assert : Total : 0 Valid : 0
Candidate-RP : Total : 0 Valid : 0
```

**Related Commands** [show ip pim sparse-mode packet statistics](#)

# clear ip mroute pim sparse-mode

**Overview** Use this command to clear all multicast route table entries learned through PIM-SM for a specified multicast group address, and optionally a specified multicast source address.

**Syntax** `clear ip mroute <Group-IP-address> pim sparse-mode`  
`clear ip mroute <Group-IP-address> <Source-IP-address> pim sparse-mode`

| Parameter                              | Description                                                          |
|----------------------------------------|----------------------------------------------------------------------|
| <code>&lt;Group-IP-address&gt;</code>  | Specify a multicast group IPv6 address, entered in the form A.B.C.D. |
| <code>&lt;Source-IP-address&gt;</code> | Specify a source group IP address, entered in the form A.B.C.D.      |

**Mode** Privileged Exec

**Example** `awplus# clear ip mroute pim sparse-mode 224.0.0.0`  
`awplus# clear ip mroute 192.168.7.1 pim sparse-mode 224.0.0.0`

# debug pim sparse-mode

**Overview** Use this command to turn on some or all PIM-SM debugging.

Use the **no** variant of this command to turn off some or all PIM-SM debugging.

**Syntax** `debug pim sparse-mode [all] [events] [mfc] [mib] [nexthop] [nsm] [packet] [state] [mtrace]`

`no debug pim sparse-mode [all] [events] [mfc] [mib] [nexthop] [nsm] [packet] [state] [mtrace]`

| Parameter | Description                                                                                |
|-----------|--------------------------------------------------------------------------------------------|
| all       | Activates/deactivates all PIM-SM debugging.                                                |
| events    | Activates debug printing of events.                                                        |
| mfc       | Activates debug printing of MFC (Multicast Forwarding Cache in kernel) add/delete/updates. |
| mib       | Activates debug printing of PIM-SM MIBs.                                                   |
| nexthop   | Activates debug printing of PIM-SM next hop communications.                                |
| nsm       | Activates debugging of PIM-SM Network Services Module communications.                      |
| packet    | Activates debug printing of incoming and/or outgoing packets.                              |
| state     | Activates debug printing of state transition on all PIM-SM FSMs.                           |
| mtrace    | Activates debug printing of multicast traceroute.                                          |

**Mode** Privileged Exec and Global Configuration

**Example** `awplus# configure terminal`  
`awplus(config)# debug pim sparse-mode all`

**Related Commands** [show debugging pim sparse-mode](#)

# debug pim sparse-mode timer

**Overview** Use this command to enable debugging for the specified PIM-SM timers. Use the **no** variants of this command to disable debugging for the specified PIM-SM timers.

**Syntax**

```
debug pim sparse-mode timer assert [at]
no debug pim sparse-mode timer assert [at]
debug pim sparse-mode timer bsr [bst|crp]
no debug pim sparse-mode timer bsr [bst|crp]
debug pim sparse-mode timer hello [ht|nlt|tht]
no debug pim sparse-mode timer hello [ht|nlt|tht]
debug pim sparse-mode timer joinprune [jt|et|ppt|kat|ot]
no debug pim sparse-mode timer joinprune [jt|et|ppt|kat|ot]
debug pim sparse-mode timer register [rst]
no debug pim sparse-mode timer register [rst]
```

| Parameter | Description                                                                                           |
|-----------|-------------------------------------------------------------------------------------------------------|
| assert    | Enable or disable debugging for the Assert timers.                                                    |
| at        | Enable or disable debugging for the Assert Timer.                                                     |
| bsr       | Enable or disable debugging for the specified Bootstrap Router timer, or all Bootstrap Router timers. |
| bst       | Enable or disable debugging for the Bootstrap Router: Bootstrap Timer.                                |
| crp       | Enable or disable debugging for the Bootstrap Router: Candidate-RP Timer.                             |
| hello     | Enable or disable debugging for the specified Hello timer, or all Hello timers.                       |
| ht        | Enable or disable debugging for the Hello timer: Hello Timer.                                         |
| nlt       | Enable or disable debugging for the Hello timer: Neighbor Liveness Timer.                             |
| tht       | Enable or disable debugging for the Hello timer: Triggered Hello Timer.                               |
| joinprune | Enable or disable debugging for the specified JoinPrune timer, or all JoinPrune timers.               |
| jt        | Enable or disable debugging for the JoinPrune timer: upstream Join Timer.                             |
| et        | Enable or disable debugging for the JoinPrune timer: Expiry Timer.                                    |
| ppt       | Enable or disable debugging for the JoinPrune timer: PrunePending Timer.                              |

| Parameter | Description                                                                   |
|-----------|-------------------------------------------------------------------------------|
| kat       | Enable or disable debugging for the JoinPrune timer: KeepAlive Timer.         |
| ot        | Enable or disable debugging for the JoinPrune timer: Upstream Override Timer. |
| register  | Enable or disable debugging for the Register timers.                          |
| rst       | Enable or disable debugging for the Register timer: Register Stop Timer.      |

**Default** By default, all debugging is disabled.

**Mode** Privileged Exec and Global Configuration

**Examples** To enable debugging for the PIM-SM Bootstrap Router bootstrap timer, use the commands:

```
awplus(config)# debug pim sparse-mode timer bsr bst
```

To enable debugging for the PIM-SM Hello: neighbor liveness timer, use the command:

```
awplus(config)# debug pim sparse-mode timer hello ht
```

To enable debugging for the PIM-SM Joinprune expiry timer, use the command:

```
awplus# debug pim sparse-mode timer joinprune et
```

To disable debugging for the PIM-SM Register timer, use the command:

```
awplus# no debug pim sparse-mode timer register
```

**Related Commands** [show debugging pim sparse-mode](#)

# ip pim anycast-rp

**Overview** Use this command to configure Anycast RP (Rendezvous Point) in a RP set.  
Use the **no** variant of this command to remove the configuration.

**Syntax** `ip pim anycast-rp <anycast-rp-address> <member-rp-address>`  
`no ip pim anycast-rp <anycast-rp-address> [<member-rp-address>]`

| Parameter                               | Description                                                                                        |
|-----------------------------------------|----------------------------------------------------------------------------------------------------|
| <code>&lt;anycast-rp-address&gt;</code> | <A.B.C.D> Specify an anycast IP address to configure an Anycast RP (Rendezvous Point) in a RP set. |
| <code>&lt;member-rp-address&gt;</code>  | <A.B.C.D> Specify an Anycast RP (Rendezvous Point) address to configure an Anycast RP in a RP set. |

**Mode** Global Configuration

**Usage** Anycast is a network addressing and routing scheme where data is routed to the nearest or best destination as viewed by the routing topology. Compared to unicast with a one-to-one association between network address and network endpoint, and multicast with a one-to-many association between network address and network endpoint; anycast has a one-to-many association between network address and network endpoint. For anycast, each destination address identifies a set of receiver endpoints, from which only one receiver endpoint is chosen.

Anycast is often implemented using BGP to simultaneously advertise the same destination IP address range from many sources, resulting in packets address to destination addresses in this range being routed to the nearest source announcing the given destination IP address.

Use this command to specify the Anycast RP configuration in the Anycast RP set. Use the **no** variant of this command to remove the Anycast RP configuration. Note that the member RP address is optional when using the **no** parameter to remove the Anycast RP configuration. removing the anycast RP address also removes the member RP address.

**Examples** The following example shows how to configure the Anycast RP address with **ip pim anycast-rp**:

```
awplus# configure terminal
awplus(config)# ip pim anycast-rp 1.1.1.1 10.10.10.10
```

The following example shows how to remove the Anycast RP in the RP set specifying only the anycast RP address with **no ip pim anycast-rp**, but not specifying the member RP address:

```
awplus# configure terminal
awplus(config)# no ip pim anycast-rp 1.1.1.1
```



# ip pim bsr-border

**Overview** Use the **ip pim bsr-border** command to prevent Bootstrap Router (BSR) messages from being sent or received through a VLAN interface. The BSR border is the border of the PIM domain.

Use the **no** variant of this command to disable the configuration set with **ip pim bsr-border**.

**Syntax** `ip pim bsr-border`  
`no ip pim bsr-border`

**Mode** Interface Configuration for a VLAN interface or a PPP interface.

**Usage** When this command is configured on a VLAN interface, no PIM version 2 BSR messages will be sent or received through the interface. Configure an interface bordering another PIM domain with this command to avoid BSR messages from being exchanged between the two PIM domains.

BSR messages should not be exchanged between different domains, because devices in one domain may elect Rendezvous Points (RPs) in the other domain, resulting in loss of isolation between the two PIM domains that would stop the PIM protocol from working as intended.

**Examples** The following example configures the VLAN interface `vlan2` to be the PIM domain border:

```
awplus# configure terminal
awplus(config)# interface vlan2
awplus(config-if)# ip pim bsr-border
```

The following example removes the VLAN interface `vlan2` from the PIM domain border:

```
awplus# configure terminal
awplus(config)# interface vlan2
awplus(config-if)# no ip pim bsr-border
```

The following example configures the PPP interface `ppp0` to be the PIM domain border:

```
awplus# configure terminal
awplus(config)# interface ppp0
awplus(config-if)# ip pim bsr-border
```

The following example removes the PPP interface `ppp0` from the PIM domain border:

```
awplus# configure terminal
awplus(config)# interface ppp0
awplus(config-if)# no ip pim bsr-border
```

# ip pim bsr-candidate

**Overview** Use this command to give the device the candidate BSR (Bootstrap Router) status using the specified IP address mask of the interface.

Use the **no** variant of this command to withdraw the address of the interface from being offered as a BSR candidate.

**Syntax** `ip pim bsr-candidate <interface> [<hash>] [<priority>]`  
`no ip pim bsr-candidate [<interface>]`

| Parameter   | Description                                                                                                                                                                                                 |
|-------------|-------------------------------------------------------------------------------------------------------------------------------------------------------------------------------------------------------------|
| <interface> | The interface. For instance, <code>vlan2</code> .                                                                                                                                                           |
| <hash>      | <0-32> configure hash mask length for RP selection. The default hash value if you do not configure this parameter is 10.                                                                                    |
| <priority>  | <0-255> configure priority for a BSR candidate. Note that you must also specify the <hash> (mask length) when specifying the <priority>. The default priority if you do not configure this parameter is 64. |

**Mode** Global Configuration

**Default** The default hash parameter value is 10 and the default priority parameter value is 64.

**Examples** To set the BSR candidate to the VLAN interface `vlan2`, with the optional mask length and BSR priority parameters, enter the commands shown below:

```
awplus# configure terminal
awplus(config)# ip pim bsr-candidate vlan2 20 30
```

To withdraw the address of `vlan2` from being offered as a BSR candidate, enter:

```
awplus# configure terminal
awplus(config)# no ip pim bsr-candidate vlan2
```

To set the BSR candidate to the PPP interface `ppp0`, with the optional mask length and BSR priority parameters, enter the commands shown below:

```
awplus# configure terminal
awplus(config)# ip pim bsr-candidate ppp0 20 30
```

To withdraw the address of `ppp0` from being offered as a BSR candidate, enter:

```
awplus# configure terminal
awplus(config)# no ip pim bsr-candidate ppp0
```

# ip pim cisco-register-checksum

**Overview** Use this command to configure the option to calculate the Register checksum over the whole packet. This command is used to inter-operate with older Cisco IOS versions.

Use the **no** variant of this command to disable this option.

**Syntax** ip pim cisco-register-checksum  
no ip pim cisco-register-checksum

**Default** This command is disabled by default. By default, Register Checksum is calculated only over the header.

**Mode** Global Configuration

**Example** awplus# configure terminal  
awplus(config)# ip pim cisco-register-checksum

# ip pim crp-cisco-prefix

**Overview** Use this command to interoperate with Cisco devices that conform to an earlier draft standard. Some Cisco devices might not accept candidate RPs with a group prefix number of zero. Note that the latest BSR specification prohibits sending RP advertisements with prefix 0. RP advertisements for the default IPv4 multicast group range 224/4 are sent with a prefix of 1.

Use the **no** variant of this command to revert to the default settings.

**Syntax** `ip pim crp-cisco-prefix`  
`no ip pim crp-cisco-prefix`

**Mode** Global Configuration

**Usage** Cisco's BSR code does not conform to the latest BSR draft. It does not accept candidate RPs with a group prefix number of zero. To make the candidate RP work with a Cisco BSR, use the **ip pim crp-cisco-prefix** command when interoperating with older versions of Cisco IOS.

**Example** `awplus# configure terminal`  
`awplus(config)# ip pim crp-cisco-prefix`  
`awplus# configure terminal`  
`awplus(config)# no ip pim crp-cisco-prefix`

**Related Commands** [ip pim rp-candidate](#)

# ip pim dr-priority

**Overview** Use this command to set the Designated Router priority value.  
Use the **no** variant of this command to disable this function.

**Syntax** `ip pim dr-priority <priority>`  
`no ip pim dr-priority [<priority>]`

| Parameter  | Description                                                                                        |
|------------|----------------------------------------------------------------------------------------------------|
| <priority> | <0-4294967294><br>The Designated Router priority value.<br>A higher value has a higher preference. |

**Default** The default is 1. The negated form of this command restores the value to the default.

**Mode** Interface Configuration for a VLAN interface or a PPP interface.

**Examples** To set the Designated Router priority value to 11234 for the VLAN interface vlan2, apply the commands as shown below:

```
awplus# configure terminal
awplus(config)# interface vlan2
awplus(config-if)# ip pim dr-priority 11234
```

To disable the Designated Router priority value for the VLAN interface vlan2, apply the commands as shown below:

```
awplus# configure terminal
awplus(config)# interface vlan2
awplus(config-if)# no ip pim dr-priority
```

To set the Designated Router priority value to 11234 for the PPP interface ppp0, apply the commands as shown below:

```
awplus# configure terminal
awplus(config)# interface ppp0
awplus(config-if)# ip pim dr-priority 11234
```

To disable the Designated Router priority value for the PPP interface ppp0, apply the commands as shown below:

```
awplus# configure terminal
awplus(config)# interface ppp0
awplus(config-if)# no ip pim dr-priority
```

**Related Commands** [ip pim ignore-rp-set-priority](#)

# ip pim exclude-genid

**Overview** Use this command to exclude the GenID option from Hello packets sent out by the PIM module on a particular interface. This command is used to inter-operate with older Cisco IOS versions.

Use the **no** variant of this command to revert to default settings.

**Syntax** ip pim exclude-genid  
no ip pim exclude-genid

**Default** By default, this command is disabled; the GenID option is included.

**Mode** Interface Configuration for a VLAN interface or a PPP interface.

**Example**

```
awplus# configure terminal
awplus(config)# interface vlan2
awplus(config-if)# ip pim exclude-genid
awplus# configure terminal
awplus(config)# interface ppp0
awplus(config-if)# ip pim exclude-genid
```

# ip pim ext-srcs-directly-connected

**Overview** Use this command to configure PIM to treat all source traffic arriving on the interface as though it was sent from a host directly connected to the interface.

Use the **no** variant of this command to configure PIM to treat only directly connected sources as directly connected.

**Syntax** `ip pim ext-srcs-directly-connected`  
`no ip pim ext-srcs-directly-connected`

**Default** The **no** variant of this command is the default behavior.

**Mode** Interface Configuration for a VLAN interface or a PPP interface.

**Example** To configure PIM to treat all sources as directly connected for VLAN interface `vlan2`, use the following commands:

```
awplus# configure terminal
awplus(config)# interface vlan2
awplus(config-if)# ip pim ext-srcs-directly-connected
```

To configure PIM to treat only directly connected sources as directly connected for VLAN interface `vlan2`, use the following commands:

```
awplus# configure terminal
awplus(config)# interface vlan2
awplus(config-if)# no ip pim ext-srcs-directly-connected
```

To configure PIM to treat all sources as directly connected for PPP interface `ppp0`, use the following commands:

```
awplus# configure terminal
awplus(config)# interface ppp0
awplus(config-if)# ip pim ext-srcs-directly-connected
```

To configure PIM to treat only directly connected sources as directly connected for PPP interface `ppp0`, use the following commands:

```
awplus# configure terminal
awplus(config)# interface ppp0
awplus(config-if)# no ip pim ext-srcs-directly-connected
```

## ip pim hello-holdtime (PIM-SM)

**Overview** This command configures a hello-holdtime value. You cannot configure a hello-holdtime value that is less than the current hello-interval.

Use the **no** variant of this command to return it to its default of 3.5 \* the current hello-interval.

**Syntax** ip pim hello-holdtime <holdtime>  
no ip pim hello-holdtime

| Parameter  | Description                                                                      |
|------------|----------------------------------------------------------------------------------|
| <holdtime> | <1-65535><br>The holdtime value in seconds (no fractional seconds are accepted). |

**Default** The default hello-holdtime value is 3.5 \* the current hello-interval. The default hello-holdtime is restored using the negated form of this command.

**Mode** Interface Configuration for a VLAN interface or a PPP interface.

**Usage** Each time the hello interval is updated, the hello holdtime is also updated, according to the following rules:

If the hello holdtime is not configured; or if the hello holdtime is configured and less than the current hello-interval value, it is modified to the (3.5 \* hello interval). Otherwise, it retains the configured value.

**Example**

```
awplus# configure terminal
awplus(config)# interface vlan2
awplus(config-if)# ip pim hello-holdtime 123
awplus# configure terminal
awplus(config)# interface ppp0
awplus(config-if)# ip pim hello-holdtime 123
```



# ip pim hello-interval (PIM-SM)

**Overview** This command configures a hello-interval value.  
Use the **no** variant of this command to reset the hello-interval to the default.

**Syntax** `ip pim hello-interval <interval>`  
`no ip pim hello-interval`

| Parameter  | Description                                                      |
|------------|------------------------------------------------------------------|
| <interval> | <1-65535> The value in seconds (no fractional seconds accepted). |

**Default** The default hello-interval value is 30 seconds. The default is restored using the negated form of this command.

**Mode** Interface Configuration for a VLAN interface or a PPP interface.

**Usage** When the hello interval is configured, and the hello holdtime is not configured, or when the configured hello-holdtime value is less than the new hello-interval value; the holdtime value is modified to the (3.5 \* hello interval). Otherwise, the hello-holdtime value is the configured value.

**Example**

```
awplus# configure terminal
awplus(config)# interface vlan2
awplus(config-if)# ip pim hello-interval 123
awplus# configure terminal
awplus(config)# interface ppp0
awplus(config-if)# ip pim hello-interval 123
```

# ip pim ignore-rp-set-priority

**Overview** Use this command to ignore the RP-SET priority value, and use only the hashing mechanism for RP selection.

This command is used to inter-operate with older Cisco IOS versions.

Use the **no** variant of this command to disable this setting.

**Syntax** `ip pim ignore-rp-set-priority`  
`no ip pim ignore-rp-set-priority`

**Mode** Global Configuration

**Example** `awplus# configure terminal`  
`awplus(config)# ip pim ignore-rp-set-priority`

# ip pim jp-timer

**Overview** Use this command to set the PIM-SM join/prune timer. Note that the value the device puts into the holdtime field of the join/prune packets it sends to its neighbors is 3.5 times the join/prune timer value set using this command.

Use the **no** variant of this command to return the PIM-SM join/prune timer to its default value of 60 seconds, which corresponds to a join/prune packet holdtime of 210 seconds.

**Syntax** `ip pim jp-timer <1-65535>`  
`no ip pim jp-timer [<1-65535>]`

| Parameter | Description                                                            |
|-----------|------------------------------------------------------------------------|
| <1-65535> | Specifies the join/prune timer value. The default value is 60 seconds. |

**Default** The default join/prune timer value is 60 seconds.

**Mode** Global Configuration

**Example** To set the join/prune timer value to 300 seconds, use the commands:

```
awplus# configure terminal
awplus(config)# ip pim jp-timer 300
```

To return the join/prune timer to its default value of 60 seconds, use the commands:

```
awplus# configure terminal
awplus(config)# no ip pim jp-timer
```

# ip pim register-rate-limit

**Overview** Use this command to configure the rate of register packets sent by this DR, in units of packets per second.

Use the **no** variant of this command to remove the limit.

**Syntax** `ip pim register-rate-limit <1-65535>`  
`no ip pim register-rate-limit`

| Parameter                    | Description                                                          |
|------------------------------|----------------------------------------------------------------------|
| <code>&lt;1-65535&gt;</code> | Specifies the maximum number of packets that can be sent per second. |

**Mode** Global Configuration

**Example** `awplus# configure terminal`  
`awplus(config)# ip pim register-rate-limit 3444`

# ip pim register-rp-reachability

**Overview** Use this command to enable the RP reachability check for PIM Register processing at the DR. The default setting is no checking for RP-reachability.

Use the **no** variant of this command to disable this processing.

**Syntax** `ip pim register-rp-reachability`  
`no ip pim register-rp-reachability`

**Default** This command is disabled; by default, there is no checking for RP-reachability.

**Mode** Global Configuration

**Example** `awplus# configure terminal`  
`awplus(config)# ip pim register-rp-reachability`

# ip pim register-source

**Overview** Use this command to configure the source address of register packets sent by this DR, overriding the default source address, which is the address of the RPF interface toward the source host.

Use the **no** variant of this command to un-configure the source address of Register packets sent by this DR, reverting back to use the default source address that is the address of the RPF interface toward the source host.

**Syntax** `ip pim register-source [<source_address>|<interface>]`  
`no ip pim register-source`

| Parameter                           | Description                                                                                    |
|-------------------------------------|------------------------------------------------------------------------------------------------|
| <code>&lt;source_address&gt;</code> | The IP address, entered in the form A.B.C.D, to be used as the source of the register packets. |
| <code>&lt;interface&gt;</code>      | The name of the interface to be used as the source of the register packets.                    |

**Usage** The configured address must be a reachable address to be used by the RP to send corresponding Register-Stop messages in response. It is normally the local loopback interface address, but can also be a physical address. This address must be advertised by unicast routing protocols on the DR. The configured interface does not have to be PIM enabled.

**Mode** Global Configuration

**Example** `awplus# configure terminal`  
`awplus(config)# ip pim register-source 10.10.1.3`

# ip pim register-suppression

**Overview** Use this command to configure the register-suppression time, in seconds, overriding the default of 60 seconds. Configuring this value modifies register-suppression time at the DR. Configuring this value at the RP modifies the RP-keepalive-period value if the [ip pim rp-register-kat](#) command is not used.

Use the **no** variant of this command to reset the value to its default of 60 seconds.

**Syntax** `ip pim register-suppression <1-65535>`  
`no ip pim register-suppression`

**Mode** Global Configuration

**Example** `awplus# configure terminal`  
`awplus(config)# ip pim register-suppression 192`

# ip pim rp-address

**Overview** Use this command to statically configure RP (Rendezvous Point) address for multicast groups.

Use the **no** variant of this command to remove a statically configured RP (Rendezvous Point) address for multicast groups.

**Syntax** `ip pim rp-address <ip-address> [override]`  
`no ip pim rp-address <ip-address> [override]`

| Parameter    | Description                                                         |
|--------------|---------------------------------------------------------------------|
| <ip-address> | IP address of Rendezvous Point, entered in the form A . B . C . D.  |
| override     | Enables statically defined RPs to override dynamically learned RPs. |

**Mode** Global Configuration

**Usage** The AlliedWare Plus PIM-SM implementation supports multiple static RPs. It also supports usage of static-RP and BSR mechanism simultaneously. The **ip pim rp-address** command is used to statically configure the RP address for multicast groups.

You need to understand the following information before using this command.

If the RP-address that is configured by the BSR, and the RP-address that is configured statically, are both available for a group range, then the RP-address configured through BSR is chosen over the statically configured RP-address.

Group mode and RP address mappings learned through BSR take precedence over mappings statistically defined by the [ip pim rp-address](#) command. Commands with the `override` keyword take precedence over dynamically learned mappings.

**Example**

```
awplus# configure terminal
awplus(config)# ip pim rp-address 192.168.3.4 4
```

**Related Commands** [ip pim rp-candidate](#)  
[ip pim rp-register-kat](#)



# ip pim rp-candidate

**Overview** Use this command to make the router an RP (Rendezvous Point) candidate, using the IP address of the specified interface.

Use the **no** variant of this command to remove the RP status set using the **ip pim rp-candidate** command.

**Syntax** `ip pim rp-candidate <interface> [priority <priority> | interval <interval> ]`

`no ip pim rp-candidate [<interface>]`

| Parameter   | Description                                                           |
|-------------|-----------------------------------------------------------------------|
| <interface> | Interface name                                                        |
| <priority>  | <0-255> configure priority for an RP candidate.                       |
| <interval>  | advertisement interval specified in the range <1-16383> (in seconds). |

**Default** The priority value for a candidate RP is 0 by default until specified using the **priority** parameter.

**Mode** Global Configuration

**Usage** Note that issuing the command **ip pim rp-candidate <interface>** without optional **priority**, **interval**, or **group** parameters will configure the candidate RP with a priority value of 0.

**Examples** To specify a priority of 3, use the following commands:

```
awplus# configure terminal
awplus(config)# ip pim rp-candidate vlan2 priority 3
```

To stop the device from being an RP candidate on vlan2 , use the following commands:

```
awplus# configure terminal
awplus(config)# no ip pim rp-candidate vlan2
```

**Related Commands**

- [ip pim rp-address](#)
- [ip pim rp-register-kat](#)
- [ip pim crp-cisco-prefix](#)

# ip pim rp-register-kat

**Overview** Use this command to configure the Keep Alive Time (KAT) for (S,G) states at the RP (Rendezvous Point) to monitor PIM-SM Register packets.

Use the **no** variant of this command to return the PIM-SM KAT timer to its default value of 210 seconds.

**Syntax** `ip pim rp-register-kat <1-65535>`  
`no ip pim rp-register-kat`

| Parameter | Description                                                         |
|-----------|---------------------------------------------------------------------|
| <1-65535> | Specify the KAT timer in seconds. The default value is 210 seconds. |

**Mode** Global Configuration

**Default** The default PIM-SM KAT timer value is 210 seconds.

**Examples**

```
awplus# configure terminal
awplus(config)# ip pim rp-register-kat 3454
awplus# configure terminal
awplus(config)# no ip pim rp-register-kat
```

**Related Commands** [ip pim rp-address](#)  
[ip pim rp-candidate](#)

# ip pim sparse-mode

**Overview** Use this command to enable PIM-SM on the VLAN interface.  
Use the **no** variant of this command to disable PIM-SM on the VLAN interface.

**Syntax** ip pim sparse-mode  
no ip pim sparse-mode

**Mode** Interface Configuration for a VLAN interface or a PPP interface.

**Examples**

```
awplus# configure terminal
awplus(config)# interface vlan2
awplus(config-if)# ip pim sparse-mode
awplus# configure terminal
awplus(config)# interface vlan2
awplus(config-if)# no ip pim sparse-mode
awplus# configure terminal
awplus(config)# interface ppp0
awplus(config-if)# ip pim sparse-mode
awplus# configure terminal
awplus(config)# interface ppp0
awplus(config-if)# no ip pim sparse-mode
```

# ip pim sparse-mode passive

**Overview** Use this command to enable and disable passive mode operation for local members on the VLAN interface.

Use the **no** variant of this command to disable passive mode operation for local members on the VLAN interface.

**Syntax** ip pim sparse-mode passive  
no ip pim sparse-mode passive

**Mode** Interface Configuration for a VLAN interface or a PPP interface.

**Usage** Passive mode essentially stops PIM transactions on the interface, allowing only IGMP mechanism to be active. To turn off passive mode, use the **no ip pim sparse-mode passive** or the **ip pim sparse-mode** command. To turn off PIM activities on the VLAN interface, use the **no ip pim sparse-mode** command.

**Examples**

```
awplus# configure terminal
awplus(config)# interface vlan2
awplus(config-if)# ip pim sparse-mode passive
awplus# configure terminal
awplus(config)# interface vlan2
awplus(config-if)# no ip pim sparse-mode passive
awplus# configure terminal
awplus(config)# interface ppp0
awplus(config-if)# ip pim sparse-mode passive
awplus# configure terminal
awplus(config)# interface ppp0
awplus(config-if)# no ip pim sparse-mode passive
```

# ip pim spt-threshold

**Overview** This command turns on the ability for the last-hop PIM router to switch to SPT (shortest-path tree).

The **no** variant of this command turns off the ability for the last-hop PIM router to switch to SPT.

**NOTE:** *The switching to SPT happens either at the receiving of the first data packet, or not at all; it is not rate-based.*

**Syntax** ip pim spt-threshold  
no ip pim spt-threshold

**Mode** Global Configuration

**Examples** To enable the last-hop PIM-SM router to switch to SPT, use the following commands:

```
awplus# configure terminal
awplus(config)# ip pim spt-threshold
```

To stop the last-hop PIM-SM router from being able to switch to SPT, use the following commands:

```
awplus# configure terminal
awplus(config)# no ip pim spt-threshold
```

## ip pim ssm

**Overview** Use this command to define the Source Specific Multicast (SSM) range of IP multicast addresses. The default keyword defines the SSM range as 232/8.

Use the **no** variant of this command to disable the SSM range.

**Syntax** `ip pim ssm default`  
`no ip pim ssm`

**Default** By default, the command is disabled.

**Mode** Global Configuration

**Usage** When an SSM range of IP multicast addresses is defined by the `ip pim ssm` command, the `no (*,G)` or `(S,G,rpt)` state will be initiated for groups in the SSM range.

The messages corresponding to these states will not be accepted or originated in the SSM range.

**Examples** The following commands show how to set PIM-SSM as default:

```
awplus# configure terminal
awplus(config)# ip pim ssm default
```

The following commands show how to disable PIM-SSM:

```
awplus# configure terminal
awplus(config)# no ip pim ssm
```

# show debugging pim sparse-mode

**Overview** This command displays the status of the debugging of the system.  
For information on filtering and saving command output, see the [“Getting Started with AlliedWare Plus” Feature Overview and Configuration Guide](#).

**Syntax** `show debugging pim sparse-mode`

**Mode** User Exec and Privileged Exec

**Example** To display PIM-SM debugging settings, use the command:

```
awplus# show debugging pim sparse-mode
```

Figure 38-2: Output from **show debugging pim sparse-mode**

```
Debugging status:
PIM event debugging is on
PIM Hello THT timer debugging is on
PIM event debugging is on
PIM MFC debugging is on
PIM state debugging is on
PIM packet debugging is on
PIM incoming packet debugging is on
PIM outgoing packet debugging is on
```

**Related Commands** [debug pim sparse-mode](#)

# show ip pim sparse-mode bsr-router

**Overview** Use this command to show the Bootstrap Router (BSR) (v2) address.  
For information on filtering and saving command output, see the [“Getting Started with AlliedWare Plus” Feature Overview and Configuration Guide](#).

**Syntax** `show ip pim sparse-mode bsr-router`

**Mode** User Exec and Privileged Exec

**Output** Figure 38-3: Output from the **show ip pim sparse-mode bsr-router** command

```
PIMv2 Bootstrap information
BSR address: 10.10.11.35 (?)
Uptime: 00:00:38, BSR Priority: 0, Hash mask length: 10
Expires: 00:01:32
Role: Non-candidate BSR
State: Accept Preferred
```

**Related Commands** [show ip pim sparse-mode rp mapping](#)  
[show ip pim sparse-mode neighbor](#)



# show ip pim sparse-mode interface

**Overview** Use this command to show PIM-SM interface information.

For information on filtering and saving command output, see the [“Getting Started with AlliedWare Plus” Feature Overview and Configuration Guide](#)

**Syntax** `show ip pim sparse-mode interface`

**Mode** User Exec and Privileged Exec

**Example** To display information about PIM-SM interfaces, use the command:

```
awplus# show ip pim sparse-mode interface
```

**Output** Figure 38-4: Example output from **show ip pim sparse-mode interface**

```
Total configured interfaces: 16 Maximum allowed: 31
Total active interfaces: 12

Address Interface VIFindex Ver/ Nbr DR DR
 Mode Count Prior
192.168.1.53 vlan2 0 v2/S 2 2 192.168.1.53
192.168.10.53 vlan3 2 v2/S 0 2 192.168.10.53

... Note that this screen has been edited to remove any additional interfaces.
```

**Table 1:** Parameters in the output from the **show ip pim sparse-mode interface** command

| Parameters                  | Description                                                              |
|-----------------------------|--------------------------------------------------------------------------|
| Total configured interfaces | The number of configured PIM Sparse Mode interfaces.                     |
| Maximum allowed             | The maximum number of PIM Sparse Mode interfaces that can be configured. |
| Total active interfaces     | The number of active PIM Sparse Mode interfaces.                         |
| Address                     | Primary PIM-SM address.                                                  |
| Interface                   | Name of the PIM-SM interface.                                            |
| VIF Index                   | The Virtual Interface index of the VLAN.                                 |
| Ver/Mode                    | PIM version/Sparse mode.                                                 |
| Nbr Count                   | Neighbor count of the PIM-SM interface.                                  |

**Table 1:** Parameters in the output from the **show ip pim sparse-mode interface** command (cont.)

| Parameters  | Description                              |
|-------------|------------------------------------------|
| DR Priority | Designated Router priority.              |
| DR          | The IP address of the Designated Router. |

**Related Commands**

- [ip pim sparse-mode](#)
- [show ip pim sparse-mode rp mapping](#)
- [show ip pim sparse-mode neighbor](#)

# show ip pim sparse-mode interface detail

**Overview** Use this command to show detailed information on a PIM-SM interface.  
For information on filtering and saving command output, see the [“Getting Started with AlliedWare Plus” Feature Overview and Configuration Guide](#).

**Syntax** `show ip pim sparse-mode interface detail`

**Mode** User Exec and Privileged Exec

**Output** Figure 38-5: Example output from the **show ip pim sparse-mode interface detail** command

```
vlan3 (vif 3):
 Address 192.168.1.149, DR 192.168.1.149
 Hello period 30 seconds, Next Hello in 15 seconds
 Triggered Hello period 5 seconds
 Neighbors:
 192.168.1.22

vlan2 (vif 0):
 Address 10.10.11.149, DR 10.10.11.149
 Hello period 30 seconds, Next Hello in 18 seconds
 Triggered Hello period 5 seconds
 Neighbors:
 10.10.11.4
```

# show ip pim sparse-mode local-members

**Overview** Use this command to show detailed local member information on a VLAN interface configured for PIM-SM. If you do not specify a VLAN interface then detailed local member information is shown for all VLAN interfaces configured for PIM-SM.

For information on filtering and saving command output, see the [“Getting Started with AlliedWare Plus” Feature Overview and Configuration Guide](#).

**Syntax** `show ip pim sparse-mode local-members [<interface>]`

| Parameter   | Description                                                                        |
|-------------|------------------------------------------------------------------------------------|
| <interface> | Optional. Specify the interface. For instance, VLAN interface <code>vlan2</code> . |

**Mode** User Exec and Privileged Exec

**Example** To show detailed PIM-SM information for all PIM-SM configured VLAN interfaces, use the command:

```
awplus# show ip pim sparse-mode local-members
```

**Output** Figure 38-6: Example output from the **show ip pim sparse-mode local-members** command

```
awplus#show ip pim sparse-mode local-members
PIM Local membership information

vlan1:
 (*, 224.0.0.4) : Include

vlan203:
 (*, 223.0.0.3) : Include
```

**Example** To show detailed PIM-SMv6 information for the PIM-SM configured interface `vlan1`, use the command:

```
awplus# show ip pim sparse-mode local-members vlan1
```

**Output** Figure 38-7: Example output from the **show ip pim sparse-mode local-members vlan1** command

```
awplus#show ip pim sparse-mode local-members vlan1
PIM Local membership information

vlan1:
 (*, 224.0.0.4) : Include
```

# show ip pim sparse-mode mroute

**Overview** Use this command to display the IP multicast routing table or the IP multicast routing table based on a specific address or addresses.

**Syntax** `show ip pim sparse-mode mroute [<group-address>]`  
`show ip pim sparse-mode mroute [<source-address>]`  
`show ip pim sparse-mode mroute [<source-address>  
<group-address>]`

| Parameter                           | Description                                                                                               |
|-------------------------------------|-----------------------------------------------------------------------------------------------------------|
| <code>&lt;group-address&gt;</code>  | Group IP address, entered in the form A.B.C.D. Output is all multicast entries belonging to that group.   |
| <code>&lt;source-address&gt;</code> | Source IP address, entered in the form A.B.C.D. Output is all multicast entries belonging to that source. |

**Mode** Privileged Exec

**Usage** Note that when a feature license is enabled, the output for the **show ip pim sparse-mode mroute** command will only show 32 interfaces because of the terminal display width limit. Use the **show ip pim sparse-mode mroute detail** command to display detailed entries of the IP multicast routing table.

**Example** To display the IP multicast routing table for the address 40.40.40.11, enter the command:

```
awplus# show ip pim sparse-mode mroute 40.40.40.11
```

**Output** Figure 38-8: Example output from **show ip pim sparse-mode mroute**

```
awplus#show ip pim sparse-mode mroute
IP Multicast Routing Table
(*,*,RP) Entries: 0
(*,G) Entries: 1
(S,G) Entries: 0
(S,G,rpt) Entries: 0
FCR Entries: 1
(*, 224.0.1.3)
RP: 10.10.5.153
RPF nbr: 192.168.1.152
RPF idx: vlan2
Upstream State: JOINED
Local
Joined ..j.....
Asserted
FCR:
Source: 10.10.1.52
Outgoing ..o.....
KAT timer running, 144 seconds remaining
Packet count 1
```

**Related Commands** [show ip pim sparse-mode mroute detail](#)

# show ip pim sparse-mode mroute detail

**Overview** This command displays detailed entries of the IP multicast routing table, or detailed entries of the IP multicast routing table based on the specified address or addresses.

For information on filtering and saving command output, see the [“Getting Started with AlliedWare Plus” Feature Overview and Configuration Guide](#).

**Syntax**

```
show ip pim sparse-mode mroute [<group-address>] detail
show ip pim sparse-mode mroute [<source-address>] detail
show ip pim sparse-mode mroute [<group-address>
<source-address>] detail
show ip pim sparse-mode mroute [<source-address>
<group-address>] detail
```

| Parameter        | Description                                                                                               |
|------------------|-----------------------------------------------------------------------------------------------------------|
| <group-address>  | Group IP address, entered in the form A.B.C.D. Output is all multicast entries belonging to that group.   |
| <source-address> | Source IP address, entered in the form A.B.C.D. Output is all multicast entries belonging to that source. |
| detail           | Show detailed information.                                                                                |

**Usage** Based on the group and source address, the output is the selected route if present in the multicast route tree.

**Mode** User Exec and Privileged Exec

**Examples**

```
awplus# show ip pim sparse-mode mroute detail
awplus# show ip pim sparse-mode mroute 40.40.40.11 detail
awplus# show ip pim sparse-mode mroute 224.1.1.1 detail
awplus# show ip pim sparse-mode mroute 224.1.1.1 40.40.40.11
detail
```

Figure 38-9: Example output from the **show ip pim sparse-mode mroute detail** command

```
IP Multicast Routing Table

(*,*,RP) Entries: 0
(*,G) Entries: 4
(S,G) Entries: 0
(S,G,rpt) Entries: 0
FCR Entries: 0

(*, 224.0.1.24) Uptime: 00:06:42
RP: 0.0.0.0, RPF nbr: None, RPF idx: None
Upstream:
State: JOINED, SPT Switch: Disabled, JT: off
Macro state: Join Desired,
Downstream:
vlan2:
State: NO INFO, ET: off, PPT: off
Assert State: NO INFO, AT: off
Winner: 0.0.0.0, Metric: 42949672951, Pref: 42949672951,
RPT bit: on
Macro state: Could Assert, Assert Track
Local Olist:
vlan2
```



# show ip pim sparse-mode neighbor

**Overview** Use this command to show the PIM-SM neighbor information.

For information on filtering and saving command output, see the [“Getting Started with AlliedWare Plus” Feature Overview and Configuration Guide](#).

**Syntax** `show ip pim sparse-mode neighbor [<interface>] [<ip-address>]  
[detail]`

| Parameter    | Description                                                                                           |
|--------------|-------------------------------------------------------------------------------------------------------|
| <interface>  | Interface name (e.g. vlan2). Show neighbors on an interface.                                          |
| <ip-address> | Show neighbors with a particular address on an interface. The IP address entered in the form A.B.C.D. |
| detail       | Show detailed information.                                                                            |

**Mode** Privileged Exec

**Examples** `awplus# show ip pim sparse-mode neighbor`  
`awplus# show ip pim sparse-mode neighbor vlan5 detail`

Figure 38-10: Example output from the **show ip pim sparse-mode neighbor** command

| Neighbor Address | Interface | Uptime/Expires    | Ver | DR Priority/ |
|------------------|-----------|-------------------|-----|--------------|
| 10.10.0.9        | vlan2     | 00:55:33/00:01:44 | v2  | 1 /          |
| 10.10.0.136      | vlan2     | 00:55:20/00:01:25 | v2  | 1 /          |
| 10.10.0.172      | vlan2     | 00:55:33/00:01:32 | v2  | 1 / DR       |
| 192.168.0.100    | vlan3     | 00:55:30/00:01:20 | v2  | N / DR       |

Figure 38-11: Example output from the **show ip pim sparse-mode neighbor interface detail** command

```
Nbr 10.10.3.180 (vlan5), DR
Expires in 55 seconds, uptime 00:00:15
Holdtime: 70 secs, T-bit: off, Lan delay: 1, Override interval:
3
DR priority: 100, Gen ID: 625159467,
Secondary addresses:
 192.168.30.1
```

# show ip pim sparse-mode nexthop

**Overview** Use this command to see the next hop information as used by PIM-SM.  
For information on filtering and saving command output, see the [“Getting Started with AlliedWare Plus” Feature Overview and Configuration Guide](#)

**Syntax** `show ip pim sparse-mode nexthop`

**Mode** User Exec and Privileged Exec

**Example** `awplus# show ip pim sparse-mode nexthop`

Figure 38-12: Example output from the **show ip pim sparse-mode nexthop** command

```
Flags: N = New, R = RP, S = Source, U = Unreachable
Destination Type Nexthop Nexthop Nexthop Nexthop Metric Pref Refcnt
 Num Addr Ifindex Name

10.10.0.9 .RS. 1 0.0.0.0 4 0 0 1
```

**Table 2:** Parameters in output of the **show ip pim sparse-mode nexthop** command

| Parameter       | Description                                                                                                  |
|-----------------|--------------------------------------------------------------------------------------------------------------|
| Destination     | The destination address for which PIM-SM requires next hop information.                                      |
| Type            | The type of destination, as indicated by the Flags description. N = New, R= RP, S = Source, U = Unreachable. |
| Nexthop Num     | The number of next hops to the destination. PIM-SM always uses only 1 next hop.                              |
| Nexthop Addr    | The address of the primary next hop gateway.                                                                 |
| Nexthop IfIndex | The interface on which the next hop gateway can be reached.                                                  |
| Nexthop Name    | The name of next hop interface.                                                                              |
| Metric          | The metric of the route towards the destination.                                                             |
| Preference      | The preference of the route towards destination.                                                             |
| Refcnt          | Only used for debugging.                                                                                     |

# show ip pim sparse-mode packet statistics

**Overview** Use this command to display the current packet receive counts for PIM sparse-mode.

**Syntax** `show ip pim sparse-mode packet statistics`

**Mode** Privileged Exec

**Example** The following command displays the current packet receive counts for PIM sparse-mode:

```
awplus# configure terminal
awplus(config)# show ip pim sparse-mode statistics
```

**Output** Figure 38-13: Example output from **show ip pim sparse-mode statistics**

```
awplus(config)#show ip pim sparse-mode statistics
PIM-SM Receive Packet Statistics :
All PIM-SM : Total : 25 Valid : 25
Hello : Total : 14 Valid : 14
Register : Total : 5 Valid : 5
Register Stop : Total : 0 Valid : 0
Join/Prune : Total : 0 Valid : 0
Bootstrap : Total : 6 Valid : 6
Assert : Total : 0 Valid : 0
Candidate-RP : Total : 0 Valid : 0
```

**Related Commands** [clear ip pim sparse-mode packet statistics](#)

# show ip pim sparse-mode rp-hash

**Overview** Use this command to display the Rendezvous Point (RP) to be chosen based on the group selected.

For information on filtering and saving command output, see the [“Getting Started with AlliedWare Plus” Feature Overview and Configuration Guide](#).

**Syntax** `show ip pim sparse-mode rp-hash <group-addr>`

| Parameter                       | Description                                                              |
|---------------------------------|--------------------------------------------------------------------------|
| <code>&lt;group-addr&gt;</code> | The group address for which to find the RP, entered in the form A.B.C.D. |

**Mode** User Exec and Privileged Exec

**Example** `awplus# show ip pim sparse-mode rp-hash 224.0.1.3`

Figure 38-14: Output from the **show ip pim sparse-mode rp-hash** command

```
RP: 10.10.11.35
Info source: 10.10.11.35, via bootstrap
```

**Related Commands** [show ip pim sparse-mode rp mapping](#)

# show ip pim sparse-mode rp mapping

**Overview** Use this command to show group-to-RP (Rendezvous Point) mappings, and the RP set.

For information on filtering and saving command output, see the [“Getting Started with AlliedWare Plus” Feature Overview and Configuration Guide](#).

**Syntax** `show ip pim sparse-mode rp mapping`

**Mode** Privileged Exec

**Example** `awplus# show ip pim sparse-mode rp mapping`

Figure 38-15: Output from the **show ip pim sparse-mode rp mapping** command

```
PIM Group-to-RP Mappings
Group(s): 224.0.0.0/4
RP: 10.10.0.9
 Info source: 10.10.0.9, via bootstrap, priority 192
 Uptime: 16:52:39, expires: 00:02:50
```

**Related Commands** [show ip pim sparse-mode rp-hash](#)

# undebbug all pim sparse-mode

**Overview** Use this command to disable all PIM-SM debugging.

**Syntax** `undebbug all pim sparse-mode`

**Mode** Privileged Exec

**Example** `awplus# undebbug all pim sparse-mode`

**Related  
Commands** [debug pim sparse-mode](#)

## Introduction

**Overview** This chapter provides an alphabetical reference of PIM-SMv6 commands. For IPv6 Multicast commands, see [Multicast Commands](#). For an overview of PIM-SMv6, see the [PIM-SMv6 Feature Overview and Configuration Guide](#).

IPv6 must be enabled on an interface with the `ipv6 enable` command, IPv6 forwarding must be enabled globally for routing IPv6 with the `ipv6 forwarding` command, and IPv6 multicasting must be enabled globally with the `ipv6 multicast-routing` command before using PIM-SMv6 commands.

Static IPv6 multicast routes take priority over dynamic IPv6 multicast routes. Use the `clear ipv6 mroute` command to clear static IPv6 multicast routes and ensure dynamic IPv6 multicast routes can take over from previous IPv6 static multicast routes.

**NOTE:** The IPv6 Multicast addresses shown can be derived from IPv6 unicast prefixes as per RFC 3306. The IPv6 unicast prefix reserved for documentation is 2001:0db8::/32 as per RFC 3849. Using the base /32 prefix the IPv6 multicast prefix for 2001:0db8::/32 is ff3x:20:2001:0db8::/64. Where an RP address is 2001:0db8::1 the embedded RP multicast prefix is ff7x:120:2001:0db8::/96. For ASM (Any-Source Multicast) the IPv6 multicast addresses allocated for documentation purposes are ff0x::0db8:0:0/96 as per RFC 6676. This is a /96 prefix so that it can be used with group IDs as per RFC 3307. These addresses should not be used for practical networks (other than for testing purposes), nor should they appear in any public network.

The IPv6 addresses shown use the address space 2001:0db8::/32, defined in RFC 3849 for documentation purposes. These addresses should not be used for practical networks (other than for testing purposes) nor should they appear on any public network.

- Command List**
- “`clear ipv6 mroute pim`” on page 1738
  - “`clear ipv6 mroute pim sparse-mode`” on page 1739
  - “`clear ipv6 pim sparse-mode bsr rp-set *`” on page 1740
  - “`debug ipv6 pim sparse-mode`” on page 1741

- [“debug ipv6 pim sparse-mode packet”](#) on page 1743
- [“debug ipv6 pim sparse-mode timer”](#) on page 1744
- [“ipv6 pim anycast-rp”](#) on page 1746
- [“ipv6 pim bsr-border”](#) on page 1748
- [“ipv6 pim bsr-candidate”](#) on page 1750
- [“ipv6 pim cisco-register-checksum”](#) on page 1752
- [“ipv6 pim crp-cisco-prefix”](#) on page 1753
- [“ipv6 pim dr-priority”](#) on page 1754
- [“ipv6 pim exclude-genid”](#) on page 1756
- [“ipv6 pim ext-srcs-directly-connected”](#) on page 1757
- [“ipv6 pim hello-holdtime”](#) on page 1758
- [“ipv6 pim hello-interval”](#) on page 1759
- [“ipv6 pim ignore-rp-set-priority”](#) on page 1760
- [“ipv6 pim jp-timer”](#) on page 1761
- [“ipv6 pim neighbor-filter”](#) on page 1762
- [“ipv6 pim register-rate-limit”](#) on page 1763
- [“ipv6 pim register-rp-reachability”](#) on page 1764
- [“ipv6 pim register-source”](#) on page 1765
- [“ipv6 pim register-suppression”](#) on page 1766
- [“ipv6 pim rp-address”](#) on page 1767
- [“ipv6 pim rp-candidate”](#) on page 1769
- [“ipv6 pim rp embedded”](#) on page 1770
- [“ipv6 pim rp-register-kat”](#) on page 1771
- [“ipv6 pim sparse-mode”](#) on page 1772
- [“ipv6 pim sparse-mode passive”](#) on page 1773
- [“ipv6 pim spt-threshold”](#) on page 1774
- [“ipv6 pim ssm”](#) on page 1775
- [“ipv6 pim unicast-bsm”](#) on page 1776
- [“show debugging ipv6 pim sparse-mode”](#) on page 1777
- [“show ipv6 pim sparse-mode bsr-router”](#) on page 1778
- [“show ipv6 pim sparse-mode interface”](#) on page 1779
- [“show ipv6 pim sparse-mode interface detail”](#) on page 1781
- [“show ipv6 pim sparse-mode local-members”](#) on page 1782
- [“show ipv6 pim sparse-mode mroute”](#) on page 1784
- [“show ipv6 pim sparse-mode mroute detail”](#) on page 1786



- [“show ipv6 pim sparse-mode neighbor”](#) on page 1788
- [“show ipv6 pim sparse-mode nexthop”](#) on page 1789
- [“show ipv6 pim sparse-mode rp-hash”](#) on page 1790
- [“show ipv6 pim sparse-mode rp mapping”](#) on page 1791
- [“show ipv6 pim sparse-mode rp nexthop”](#) on page 1792
- [“undebug all ipv6 pim sparse-mode”](#) on page 1794
- [“undebug ipv6 pim sparse-mode”](#) on page 1795

# clear ipv6 mroute pim

**Overview** Use this command to clear all Multicast Forwarding Cache (MFC) entries in PIM-SMv6.

**NOTE:** *Static IPv6 multicast routes take priority over dynamic IPv6 multicast routes. Use the `clear ipv6 mroute` command to clear static IPv6 multicast routes and ensure dynamic IPv6 multicast routes can take over from previous static IPv6 multicast routes.*

**Syntax** `clear ipv6 mroute [*] pim sparse-mode`

| Parameter | Description                                                                                                                              |
|-----------|------------------------------------------------------------------------------------------------------------------------------------------|
| *         | Clears all PIM-SMv6 multicast routes. Using this command without this optional operator only deletes the multicast router table entries. |

**Mode** Privileged Exec

**Example**  
`awplus# clear ipv6 mroute pim sparse-mode`  
`awplus# clear ipv6 mroute * pim sparse-mode`

# clear ipv6 mroute pim sparse-mode

**Overview** Use this command to clear all multicast route table entries learned through PIM-SMv6 for a specified multicast group address, and optionally a specified multicast source address.

**NOTE:** *Static IPv6 multicast routes take priority over dynamic IPv6 multicast routes. Use the `clear ipv6 mroute` command to clear static IPv6 multicast routes and ensure dynamic IPv6 multicast routes can take over from previous static IPv6 multicast routes.*

**Syntax** `clear ipv6 mroute <Group-IPv6-add> pim sparse-mode`  
`clear ipv6 mroute <Group-IPv6-add> <Source-IPv6-add> pim sparse-mode`

| Parameter                            | Description                                                           |
|--------------------------------------|-----------------------------------------------------------------------|
| <code>&lt;Group-IPv6-add&gt;</code>  | Specify a multicast group IPv6 address, entered in the form X:X::X:X. |
| <code>&lt;Source-IPv6-add&gt;</code> | Specify a source group IPv6 address, entered in the form X:X::X:X.    |

**Mode** Privileged Exec

**Example** `awplus# clear ipv6 mroute 2001:db8:: pim sparse-mode`  
`awplus# clear ipv6 mroute 2001:db8:: 2002:db8:: pim sparse-mode`

# clear ipv6 pim sparse-mode bsr rp-set \*

**Overview** Use this command to clear all Rendezvous Point (RP) sets learned through the PIM-SMv6 Bootstrap Router (BSR).

**NOTE:** *Static IPv6 multicast routes take priority over dynamic IPv6 multicast routes. Use the `clear ipv6 mroute` command to clear static IPv6 multicast routes and ensure dynamic IPv6 multicast routes can take over from previous static IPv6 multicast routes.*

**Syntax** `clear ipv6 pim sparse-mode bsr rp-set *`

| Parameter | Description         |
|-----------|---------------------|
| *         | Clears all RP sets. |

**Mode** Privileged Exec

**Usage** For multicast clients, note that one router will be automatically or statically designated as the RP, and all routers must explicitly join through the RP. A Designated Router (DR) sends periodic Join/Prune messages toward a group-specific RP for each group that it has active members.

For multicast sources, note that the Designated Router (DR) unicasts Register messages to the RP encapsulating the data packets from the multicast source. The RP forwards decapsulated data packets toward group members.

**Example** `awplus# clear ipv6 pim sparse-mode bsr rp-set *`

# debug ipv6 pim sparse-mode

**Overview** Use this command to activate PIM-SMv6 debugging.

Use the no variant of this command to deactivate PIMv6 debugging. Note that the [undebug ipv6 pim sparse-mode](#) command is an alias of the no variant of this command.

**Syntax** debug ipv6 pim sparse-mode [all] [events] [mfc] [mib] [nexthop] [nsm] [state] [timer]  
no debug ipv6 pim sparse-mode [all] [events] [mfc] [mib] [nexthop] [nsm] [state] [timer]

| Parameter | Description                                                                   |
|-----------|-------------------------------------------------------------------------------|
| all       | Activates/deactivates all PIM-SMv6 debugging.                                 |
| events    | Activates debug printing of PIM-SMv6 events.                                  |
| mfc       | Activates debug printing of MFC (Multicast Forwarding Cache).                 |
| mib       | Activates debug printing of PIM-SMv6 MIBs.                                    |
| nexthop   | Activates debug printing of PIM-SMv6 next hop communications.                 |
| nsm       | Activates debugging of PIM-SMv6 NSM (Network Services Module) communications. |
| state     | Activates debug printing of state transition on all PIM-SMv6 FSMs.            |
| timer     | Activates debug printing of PIM-SMv6 timers.                                  |

**Mode** Privileged Exec and Global Configuration

**Example** awplus# configure terminal  
awplus(config)# terminal monitor  
awplus(config)# debug ipv6 pim sparse-mode all  
awplus# configure terminal  
awplus(config)# terminal monitor  
awplus(config)# debug ipv6 pim sparse-mode events  
awplus# configure terminal  
awplus(config)# terminal monitor  
awplus(config)# debug ipv6 pim sparse-mode nexthop

**Validation output** Figure 39-1: Example output from the **show debugging ipv6 pim sparse-mode** command after issuing **multiple debug ipv6 pim sparse-mode** commands

```
awplus#debug ipv6 pim sparse-mode state
awplus#debug ipv6 pim sparse-mode events
awplus#debug ipv6 pim sparse-mode packet
awplus#show debugging ipv6 pim sparse-mode
PIM-SMv6 debugging status:
 PIM event debugging is on
 PIM MFC debugging is off
 PIM state debugging is on
 PIM packet debugging is on
 PIM Hello HT timer debugging is off
 PIM Hello NLT timer debugging is off
 PIM Hello THT timer debugging is off
 PIM Join/Prune JT timer debugging is off
 PIM Join/Prune ET timer debugging is off
 PIM Join/Prune PPT timer debugging is off
 PIM Join/Prune KAT timer debugging is off
 PIM Join/Prune OT timer debugging is off
 PIM Assert AT timer debugging is off
 PIM Register RST timer debugging is off
 PIM Bootstrap BST timer debugging is off
 PIM Bootstrap CRP timer debugging is off
 PIM mib debugging is off
 PIM nsm debugging is off
 PIM nexthop debugging is off
```

**Related commands** [show debugging ipv6 pim sparse-mode](#)  
[undebug all ipv6 pim sparse-mode](#)  
[undebug ipv6 pim sparse-mode](#)

# debug ipv6 pim sparse-mode packet

**Overview** Use this command to activate PIM-SMv6 packet debugging.  
Use the no variant of this command to deactivate PIMv6 packet debugging.

**Syntax** debug ipv6 pim sparse-mode packet {in|out}  
no debug ipv6 pim sparse-mode packet {in|out}

| Parameter | Description                                                        |
|-----------|--------------------------------------------------------------------|
| packet    | Activates debug printing of incoming and/or outgoing IPv6 packets. |
| in        | Specify incoming packet debugging.                                 |
| out       | Specify outgoing packet debugging.                                 |

**Mode** Privileged Exec and Global Configuration

**Example**

```
awplus# configure terminal
awplus(config)# terminal monitor
awplus(config)# debug ipv6 pim sparse-mode packet in
awplus# configure terminal
awplus(config)# terminal monitor
awplus(config)# debug ipv6 pim sparse-mode packet out
awplus# configure terminal
awplus(config)# terminal monitor
awplus(config)# no debug ipv6 pim sparse-mode packet in
awplus# configure terminal
awplus(config)# terminal monitor
awplus(config)# no debug ipv6 pim sparse-mode packet out
```

**Related commands** [show debugging ipv6 pim sparse-mode](#)  
[undebug all ipv6 pim sparse-mode](#)

# debug ipv6 pim sparse-mode timer

**Overview** Use this command to enable debugging for the specified PIM-SMv6 timers.

Use the **no** variants of this command to disable debugging for the specified PIM-SMv6 timers.

**Syntax**

```
debug ipv6 pim sparse-mode timer assert [at]
no debug ipv6 pim sparse-mode timer assert [at]
debug pim ipv6 sparse-mode timer bsr [bst|crp]
no debug pim ipv6 sparse-mode timer bsr [bst|crp]
debug pim ipv6 sparse-mode timer hello [ht|nlt|tht]
no debug pim ipv6 sparse-mode timer hello [ht|nlt|tht]
debug pim ipv6 sparse-mode timer joinprune [jt|et|ppt|kat|ot]
no debug pim ipv6 sparse-mode timer joinprune
[jt|et|ppt|kat|ot]
debug pim ipv6 sparse-mode timer register [rst]
no debug pim ipv6 sparse-mode timer register [rst]
```

| Parameter | Description                                                                                           |
|-----------|-------------------------------------------------------------------------------------------------------|
| assert    | Enable or disable debugging for the Assert timers.                                                    |
| at        | Enable or disable debugging for the Assert Timer.                                                     |
| bsr       | Enable or disable debugging for the specified Bootstrap Router timer, or all Bootstrap Router timers. |
| bst       | Enable or disable debugging for the Bootstrap Router: Bootstrap Timer.                                |
| crp       | Enable or disable debugging for the Bootstrap Router: Candidate-RP Timer.                             |
| hello     | Enable or disable debugging for the specified Hello timer, or all Hello timers.                       |
| ht        | Enable or disable debugging for the Hello timer: Hello Timer.                                         |
| nlt       | Enable or disable debugging for the Hello timer: Neighbor Liveness Timer.                             |
| tht       | Enable or disable debugging for the Hello timer: Triggered Hello Timer.                               |
| joinprune | Enable or disable debugging for the specified JoinPrune timer, or all JoinPrune timers.               |
| jt        | Enable or disable debugging for the JoinPrune timer: upstream Join Timer.                             |
| et        | Enable or disable debugging for the JoinPrune timer: Expiry Timer.                                    |
| ppt       | Enable or disable debugging for the JoinPrune timer: PrunePending Timer.                              |



| Parameter | Description                                                                   |
|-----------|-------------------------------------------------------------------------------|
| kat       | Enable or disable debugging for the JoinPrune timer: KeepAlive Timer.         |
| ot        | Enable or disable debugging for the JoinPrune timer: Upstream Override Timer. |
| register  | Enable or disable debugging for the Register timers.                          |
| rst       | Enable or disable debugging for the Register timer: Register Stop Timer.      |

**Default** By default, all debugging is disabled.

**Mode** Privileged Exec and Global Configuration

**Examples** To enable debugging for the PIM-SMv6 Bootstrap Router bootstrap timer, use the commands:

```
awplus(config)# debug ipv6 pim sparse-mode timer bsr bst
```

To enable debugging for the PIM-SMv6 Hello: neighbor liveness timer, use the command:

```
awplus(config)# debug ipv6 pim sparse-mode timer hello ht
```

To enable debugging for the PIM-SMv6 Joinprune expiry timer, use the command:

```
awplus# debug ipv6 pim sparse-mode timer joinprune et
```

To disable debugging for the PIM-SMv6 Register timer, use the command:

```
awplus# no debug ipv6 pim sparse-mode timer register
```

**Related commands** [show debugging ipv6 pim sparse-mode](#)

# ipv6 pim anycast-rp

**Overview** Use this command to configure Anycast RP (Rendezvous Point) in an RP set.

Use the **no** variant of this command to remove the configuration.

**Syntax** `ipv6 pim anycast-rp <anycast-rp-address> <member-rp-address>`  
`no ipv6 pim anycast-rp <anycast-rp-address>`  
`[<member-rp-address>]`

| Parameter                               | Description                                                                                                                |
|-----------------------------------------|----------------------------------------------------------------------------------------------------------------------------|
| <code>&lt;anycast-rp-address&gt;</code> | <code>&lt;X:X::X:X&gt;</code> Specify an Anycast IPv6 address to configure an Anycast RP (Rendezvous Point) in a RP set.   |
| <code>&lt;member-rp-address&gt;</code>  | <code>&lt;A:B::C:D&gt;</code> Specify an Anycast RP (Rendezvous Point)IPv6 address to configure an Anycast RP in a RP set. |

**Mode** Global Configuration

**Usage** Anycast is a network addressing and routing scheme where data is routed to the nearest or best destination as viewed by the routing topology. Compared to unicast with a one-to-one association between network address and network endpoint, and multicast with a one-to-many association between network address and network endpoint; anycast has a one-to-many association between network address and network endpoint. For anycast, each destination address identifies a set of receiver endpoints, from which only one receiver endpoint is chosen.

Anycast is often implemented using BGP to simultaneously advertise the same destination IPv6 address range from many sources, resulting in packets addressed to destination addresses in this range being routed to the nearest source announcing the given destination IPv6 address.

Use this command to specify the Anycast RP configuration in the Anycast RP set. Use the **no** variant of this command to remove the Anycast RP configuration. Note that the member RP address is optional when using the **no** parameter to remove the Anycast RP configuration. removing the anycast RP address also removes the member RP address.

**Examples** The following example shows how to configure the Anycast RP address with **ipv6 pim anycast-rp**:

```
awplus# configure terminal
awplus(config)# ipv6 forwarding
awplus(config)# ipv6 multicast-routing
awplus(config)# ipv6 pim anycast-rp 2:2::2:2 20:20::20:20
```

The following example shows how to remove the Anycast RP in the RP set specifying only the anycast RP address with **no ipv6 pim anycast-rp**, but not specifying the member RP address:

```
awplus# configure terminal
awplus(config)# no ipv6 pim anycast-rp 2:2::2:2 20:20::20:20
```

# ipv6 pim bsr-border

**Overview** Use the **ipv6 pim bsr-border** command to prevent Bootstrap Router (BSR) messages from being sent or received through a VLAN interface. The BSR border is the border of the PIM-SMv6 domain.

Use the **no** variant of this command to disable the configuration set with **ipv6 pim bsr-border**.

**Syntax** `ipv6 pim bsr-border`  
`no ipv6 pim bsr-border`

**Mode** Interface Configuration for a VLAN interface or a PPP interface.

**Usage** When this command is configured on a VLAN interface, no PIM-SMv6 BSR messages will be sent or received through the interface. Configure an interface bordering another PIM-SMv6 domain with this command to avoid BSR messages from being exchanged between the two PIM-SMv6 domains.

BSR messages should not be exchanged between different domains, because devices in one domain may elect Rendezvous Points (RPs) in the other domain, resulting in loss of isolation between the two PIM domains that would stop the PIM-SMv6 protocol from working as intended.

**Examples** The following example configures the VLAN interface vln2 to be the PIM-SMv6 domain border:

```
awplus# configure terminal
awplus(config)# ipv6 forwarding
awplus(config)# ipv6 multicast-routing
awplus(config)# interface vln2
awplus(config-if)# ipv6 enable
awplus(config-if)# ipv6 pim bsr-border
```

The following example removes the VLAN interface vln2 from the PIM-SMv6 domain border:

```
awplus# configure terminal
awplus(config)# interface vln2
awplus(config-if)# no ipv6 pim bsr-border
```

The following example configures the PPP interface ppp0 to be the PIM -SMv6 domain border:

```
awplus# configure terminal
awplus(config)# ipv6 forwarding
awplus(config)# ipv6 multicast-routing
awplus(config)# interface ppp0
awplus(config-if)# ipv6 enable
awplus(config-if)# ipv6 pim bsr-border
```

The following example removes the PPP interface ppp0 from the PIM-SMv6 domain border:

```
awplus# configure terminal
awplus(config)# interface ppp0
awplus(config-if)# no ipv6 pim bsr-border
```

# ipv6 pim bsr-candidate

**Overview** Use this command to give the device the candidate BSR (Bootstrap Router) status using the specified IPv6 address mask of the interface.

Use the **no** variant of this command to withdraw the address of the interface from being offered as a BSR candidate.

**Syntax** `ipv6 pim bsr-candidate <interface> [<hash>] [<priority>]`  
`no ipv6 pim bsr-candidate [<interface>]`

| Parameter   | Description                                                                                                                                                                                                 |
|-------------|-------------------------------------------------------------------------------------------------------------------------------------------------------------------------------------------------------------|
| <interface> | Specify the interface. For instance, VLAN interface <code>vlan2</code> .                                                                                                                                    |
| <hash>      | <0-128> configure the hash mask length used for RP selection. The default hash value if you do not configure this parameter is 126.                                                                         |
| <priority>  | <0-255> configure priority for a BSR candidate. Note that you must also specify the <hash> (mask length) when specifying the <priority>. The default priority if you do not configure this parameter is 64. |

**Mode** Global Configuration

**Default** The default hash parameter value is 126 and the default priority parameter value is 64.

**Examples** To set the BSR candidate to the VLAN interface `vlan2`, with the optional mask length and BSR priority parameters, enter the commands shown below:

```
awplus# configure terminal
awplus(config)# ipv6 forwarding
awplus(config)# ipv6 multicast-routing
awplus(config)# ipv6 pim bsr-candidate vlan2 20 30
```

To withdraw the address of `vlan2` from being offered as a BSR candidate, enter:

```
awplus# configure terminal
awplus(config)# no ipv6 pim bsr-candidate vlan2
```

To set the BSR candidate to the PPP interface `ppp0`, with the optional mask length and BSR priority parameters, enter the commands shown below:

```
awplus# configure terminal
awplus(config)# ipv6 forwarding
awplus(config)# ipv6 multicast-routing
awplus(config)# ipv6 pim bsr-candidate ppp0 20 30
```

To withdraw the address of ppp0 from being offered as a BSR candidate, enter:

```
awplus# configure terminal
```

```
awplus(config)# no ipv6 pim bsr-candidate ppp0
```

# ipv6 pim cisco-register-checksum

**Overview** Use this command to configure the option to calculate the Register Checksum over the whole packet. This command is used to inter-operate with older Cisco IOS versions.

Use the **no** variant of this command to disable this option.

**Syntax** `ipv6 pim cisco-register-checksum`  
`no ipv6 pim cisco-register-checksum`

**Default** This command is disabled by default. By default, Register Checksum is calculated only over the header.

**Mode** Global Configuration

**Example**

```
awplus# configure terminal
awplus(config)# ipv6 forwarding
awplus(config)# ipv6 multicast-routing
awplus(config)# ipv6 pim cisco-register-checksum
awplus# configure terminal
awplus(config)# no ipv6 pim cisco-register-checksum
```



# ipv6 pim crp-cisco-prefix

**Overview** Use this command to interoperate with Cisco devices that conform to an earlier draft standard. Some Cisco devices might not accept candidate RPs with a group prefix number of zero. Note that the latest BSR specification prohibits sending RP advertisements with prefix 0.

Use the **no** variant of this command to revert to the default settings.

**Syntax** `ipv6 pim crp-cisco-prefix`  
`no ipv6 pim crp-cisco-prefix`

**Mode** Global Configuration

**Usage** Cisco's BSR code does not conform to the latest BSR draft, it does not accept candidate RPs with a group prefix number of zero. To make the candidate RP work with a Cisco BSR, use the **ipv6 pim crp-cisco-prefix** command when interoperating with older versions of Cisco IOS.

**Example**

```
awplus# configure terminal
awplus(config)# ipv6 forwarding
awplus(config)# ipv6 multicast-routing
awplus(config)# ipv6 pim crp-cisco-prefix
awplus# configure terminal
awplus(config)# no ipv6 pim crp-cisco-prefix
```

**Related commands** [ipv6 pim rp-candidate](#)

# ipv6 pim dr-priority

**Overview** Use this command to set the Designated Router priority value.  
Use the **no** variant of this command to disable this function.

**Syntax** `ipv6 pim dr-priority <priority>`  
`no ipv6 pim dr-priority [<priority>]`

| Parameter  | Description                                                                                                                       |
|------------|-----------------------------------------------------------------------------------------------------------------------------------|
| <priority> | <0-4294967294> Specify the Designated Router priority value. Note that a higher value has a higher preference or higher priority. |

**Default** The default value is 1. The negated form of this command restores the value to the default.

**Mode** Interface Configuration for a VLAN interface or a PPP interface.

**Examples** To set the Designated Router priority value to 11234 for the VLAN interface vlan2, apply the commands as shown below:

```
awplus# configure terminal
awplus(config)# ipv6 forwarding
awplus(config)# ipv6 multicast-routing
awplus(config)# interface vlan2
awplus(config-if)# ipv6 enable
awplus(config-if)# ipv6 pim dr-priority 11234
```

To disable the Designated Router priority value for the VLAN interface vlan2, apply the commands as shown below:

```
awplus# configure terminal
awplus(config)# interface vlan2
awplus(config-if)# no ipv6 pim dr-priority
```

To set the Designated Router priority value to 11234 for the PPP interface ppp0, apply the commands as shown below:

```
awplus# configure terminal
awplus(config)# ipv6 forwarding
awplus(config)# ipv6 multicast-routing
awplus(config)# interface ppp0
awplus(config-if)# ipv6 enable
awplus(config-if)# ipv6 pim dr-priority 11234
```

To disable the Designated Router priority value for the PPP interface ppp0, apply the commands as shown below:

```
awplus# configure terminal
awplus(config)# interface ppp0
awplus(config-if)# no ipv6 pim dr-priority
```

**Related commands** [ipv6 pim ignore-rp-set-priority](#)

# ipv6 pim exclude-genid

**Overview** Use this command to exclude the GenID option from Hello packets sent out by the PIM-SMv6 module on a particular interface. This command is used to inter-operate with older Cisco IOS versions.

Use the **no** variant of this command to revert to default settings.

**Syntax** `ipv6 pim exclude-genid`  
`no ipv6 pim exclude-genid`

**Default** By default, this command is disabled; the GenID option is included.

**Mode** Interface Configuration for a VLAN interface or a PPP interface.

**Examples**

```
awplus# configure terminal
awplus(config)# ipv6 forwarding
awplus(config)# ipv6 multicast-routing
awplus(config)# interface vlan2
awplus(config-if)# ipv6 enable
awplus(config-if)# ipv6 pim exclude-genid
awplus# configure terminal
awplus(config)# ipv6 forwarding
awplus(config)# ipv6 multicast-routing
awplus(config)# interface ppp0
awplus(config-if)# ipv6 enable
awplus(config-if)# ipv6 pim exclude-genid
awplus# configure terminal
awplus(config)# interface vlan2
awplus(config-if)# no ipv6 pim exclude-genid
```

# ipv6 pim ext-srcs-directly-connected

**Overview** Use this command to configure PIM-SMv6 to treat all source traffic arriving on the interface as though it was sent from a host directly connected to the interface.

Use the **no** variant of this command to configure PIM-SMv6 to treat only directly connected sources as directly connected.

**Syntax** `ipv6 pim ext-srcs-directly-connected`  
`no ipv6 pim ext-srcs-directly-connected`

**Default** The **no** variant of this command is the default behavior.

**Mode** Interface Configuration for a VLAN interface or a PPP interface.

**Example** To configure PIM-SMv6 to treat all sources as directly connected for VLAN interface `vlan2`, use the following commands:

```
awplus# configure terminal
awplus(config)# ipv6 forwarding
awplus(config)# ipv6 multicast-routing
awplus(config)# interface vlan2
awplus(config-if)# ipv6 enable
awplus(config-if)# ipv6 pim ext-srcs-directly-connected
```

To configure PIM-SMv6 to treat only directly connected sources as directly connected for VLAN interface `vlan2`, use the following commands:

```
awplus# configure terminal
awplus(config)# interface vlan2
awplus(config-if)# no ipv6 pim ext-srcs-directly-connected
```

To configure PIM to treat all sources as directly connected for PPP interface `ppp0`, use the following commands:

```
awplus# configure terminal
awplus(config)# ipv6 forwarding
awplus(config)# ipv6 multicast-routing
awplus(config)# interface ppp0
awplus(config-if)# ipv6 enable
awplus(config-if)# ipv6 pim ext-srcs-directly-connected
```

To configure PIM to treat only directly connected sources as directly connected for PPP interface `ppp0`, use the following commands:

```
awplus# configure terminal
awplus(config)# interface ppp0
awplus(config-if)# no ipv6 pim ext-srcs-directly-connected
```

# ipv6 pim hello-holdtime

**Overview** This command configures a hello-holdtime value. You cannot configure a hello-holdtime value that is less than the current hello-interval.

Use the **no** variant of this command to return it to its default of 3.5 \* the current hello-interval.

**Syntax** `ipv6 pim hello-holdtime <holdtime>`  
`no ipv6 pim hello-holdtime`

| Parameter                     | Description                                                                                         |
|-------------------------------|-----------------------------------------------------------------------------------------------------|
| <code>&lt;holdtime&gt;</code> | <code>&lt;1-65535&gt;</code><br>The holdtime value in seconds (no fractional seconds are accepted). |

**Default** The default hello-holdtime value is 3.5 \* the current hello-interval. The default hello- holdtime is restored using the negated form of this command.

**Mode** Interface Configuration for a VLAN interface or a PPP interface.

**Usage** Each time the hello interval is updated, the hello holdtime is also updated, according to the following rules:

If the hello holdtime is not configured; or if the hello holdtime is configured and less than the current hello-interval value, it is modified to the (3.5 \* hello interval). Otherwise, it retains the configured value.

**Examples**

```
awplus# configure terminal
awplus(config)# ipv6 forwarding
awplus(config)# ipv6 multicast-routing
awplus(config)# interface vlan2
awplus(config-if)# ipv6 enable
awplus(config-if)# ipv6 pim hello-holdtime 123
awplus# configure terminal
awplus(config)# ipv6 forwarding
awplus(config)# ipv6 multicast-routing
awplus(config)# interface ppp0
awplus(config-if)# ipv6 enable
awplus(config-if)# ipv6 pim hello-holdtime 123
awplus# configure terminal
awplus(config)# interface vlan2
awplus(config-if)# no ipv6 pim hello-holdtime
```

# ipv6 pim hello-interval

**Overview** This command configures a hello-interval value for PIM-SMv6. Use the **no** variant of this command to reset the hello-interval for PIM-SMv6 to the default.

**Syntax** `ipv6 pim hello-interval <interval>`  
`no ipv6 pim hello-interval`

| Parameter  | Description                                                      |
|------------|------------------------------------------------------------------|
| <interval> | <1-65535> The value in seconds (no fractional seconds accepted). |

**Default** The default hello-interval value is 30 seconds. The default is restored using the negated form of this command.

**Mode** Interface Configuration for a VLAN interface or a PPP interface.

**Usage** When the hello interval is configured, and the hello holdtime is not configured, or when the configured hello-holdtime value is less than the new hello-interval value; the holdtime value is modified to the (3.5 \* hello interval). Otherwise, the hello-holdtime value is the configured value.

**Example**

```
awplus# configure terminal
awplus(config)# ipv6 forwarding
awplus(config)# ipv6 multicast-routing
awplus(config)# interface vlan2
awplus(config-if)# ipv6 enable
awplus(config-if)# ipv6 pim hello-interval 123
awplus# configure terminal
awplus(config)# ipv6 forwarding
awplus(config)# ipv6 multicast-routing
awplus(config)# interface ppp0
awplus(config-if)# ipv6 enable
awplus(config-if)# ipv6 pim hello-interval 123
awplus# configure terminal
awplus(config)# interface vlan2
awplus(config-if)# no ipv6 pim hello-interval
```

# ipv6 pim ignore-rp-set-priority

**Overview** Use this command to ignore the RP-SET priority value, and use only the hashing mechanism for RP selection.

Use the **no** variant of this command to disable this setting.

**Syntax** `ipv6 pim ignore-rp-set-priority`  
`no ipv6 pim ignore-rp-set-priority`

**Mode** Global Configuration

**Usage** This command is used to inter-operate with older Cisco IOS versions.

**Example**

```
awplus# configure terminal
awplus(config)# ipv6 forwarding
awplus(config)# ipv6 multicast-routing
awplus(config)# ipv6 pim ignore-rp-set-priority
awplus# configure terminal
awplus(config)# no ipv6 pim ignore-rp-set-priority
```



# ipv6 pim jp-timer

**Overview** Use this command to set the PIM-SMv6 join/prune timer. Note that the value set by the join/prune timer is the value that the device puts into the holdtime field of the join/prune packets it sends to its neighbors.

Use the **no** variant of this command to return the PIM-SMv6 join/prune timer to its default value of 210 seconds.

**Syntax** `ipv6 pim jp-timer <1-65535>`  
`no ipv6 pim jp-timer [<1-65535>]`

| Parameter                    | Description                                                             |
|------------------------------|-------------------------------------------------------------------------|
| <code>&lt;1-65535&gt;</code> | Specifies the Join/Prune timer value. The default value is 210 seconds. |

**Default** The default PIM-SMv6 join/prune timer value is 210 seconds.

**Mode** Global Configuration

**Example**

```
awplus# configure terminal
awplus(config)# ipv6 forwarding
awplus(config)# ipv6 multicast-routing
awplus(config)# ipv6 pim jp-timer 300
awplus# configure terminal
awplus(config)# no ipv6 pim jp-timer
```

# ipv6 pim neighbor-filter

**Overview** The AR3050S and AR4050S devices don't support access control list in 5.4.5-0.1 release.

This command enables filtering of neighbors on the VLAN interface. When configuring a neighbor filter, PIM-SMv6 will either not establish adjacency with the neighbor, or terminate adjacency with the existing neighbors if denied by the filtering IPv6 access list.

Use the **no** variant of this command to disable this function.

**Syntax** `ipv6 pim neighbor-filter <IPv6-accesslist>`  
`no ipv6 pim neighbor-filter <IPv6-accesslist>`

| Parameter                            | Description                                                                                        |
|--------------------------------------|----------------------------------------------------------------------------------------------------|
| <code>&lt;IPv6-accesslist&gt;</code> | Specify a Standard or an Extended software IPv6 access list name for the PIM-SMv6 neighbor filter. |

**Default** By default, there is no neighbor filtering applied to an interface.

**Mode** Interface Configuration for a VLAN interface or a PPP interface.

**Example**

```
awplus# configure terminal
awplus(config)# ipv6 forwarding
awplus(config)# ipv6 multicast-routing
awplus(config)# interface ppp0
awplus(config-if)# ipv6 enable
awplus(config-if)# ipv6 pim neighbor-filter filter1
```

# ipv6 pim register-rate-limit

**Overview** Use this command to configure the rate of register packets sent by this DR, in units of packets per second. The configured rate is per (S, G) state, and is not a system wide rate.

Use the **no** variant of this command to remove the limit and reset to the default rate limit.

**Syntax** `ipv6 pim register-rate-limit <1-65535>`  
`no ipv6 pim register-rate-limit`

| Parameter | Description                                                          |
|-----------|----------------------------------------------------------------------|
| <1-65535> | Specifies the maximum number of packets that can be sent per second. |

**Mode** Global Configuration

**Default** The default is 0, as reset with the **no** variant, which also specifies an unlimited rate limit.

**Examples**

```
awplus# configure terminal
awplus(config)# ipv6 forwarding
awplus(config)# ipv6 multicast-routing
awplus(config)# ipv6 pim register-rate-limit 3444
awplus# configure terminal
awplus(config)# no ipv6 pim register-rate-limit 3444
```

# ipv6 pim register-rp-reachability

**Overview** Use this command to enable the RP reachability check for PIMv6 Register processing at the DR. The default setting is no checking for RP-reachability.

Use the **no** variant of this command to disable this processing.

**Syntax** `ipv6 pim register-rp-reachability`  
`no ipv6 pim register-rp-reachability`

**Default** This command is disabled; by default, there is no checking for RP-reachability.

**Mode** Global Configuration

**Examples** `awplus# configure terminal`  
`awplus(config)# ipv6 forwarding`  
`awplus(config)# ipv6 multicast-routing`  
`awplus(config)# ipv6 pim register-rp-reachability`  
`awplus# configure terminal`  
`awplus(config)# no ipv6 pim register-rp-reachability`

# ipv6 pim register-source

**Overview** Use this command to configure the source IPv6 address of register packets sent by this DR, overriding the default source IPv6 address, which is the IPv6 address of the RPF interface toward the source host.

Use the **no** variant of this command to remove the IPv6 source address of Register packets sent by this DR, reverting back to use the default IPv6 source address that is the address of the RPF interface toward the source host.

**Syntax** `ipv6 pim register-source [<source-IPv6-address>|<interface>]`  
`no ipv6 pim register-source`

| Parameter                                | Description                                                                                       |
|------------------------------------------|---------------------------------------------------------------------------------------------------|
| <code>&lt;source-IPv6-address&gt;</code> | The IPv6 address, entered in the form X:X::X:X, to be used as the source of the register packets. |
| <code>&lt;interface&gt;</code>           | The name of the VLAN interface to be used as the source of the register packets.                  |

**Usage** The configured address must be a reachable address to be used by the RP to send corresponding Register-Stop messages in response. It is normally the local loopback IPv6 interface address, but can also be a physical IPv6 address. This IPv6 address must be advertised by unicast routing protocols on the DR. The configured interface does not have to be PIM-SMv6 enabled.

**Mode** Global Configuration

**Examples**

```
awplus# configure terminal
awplus(config)# ipv6 forwarding
awplus(config)# ipv6 multicast-routing
awplus(config)# ipv6 pim register-source 3ffe::24:2
awplus# configure terminal
awplus(config)# ipv6 forwarding
awplus(config)# ipv6 multicast-routing
awplus(config)# ipv6 pim register-source vlan2
awplus# configure terminal
awplus(config)# ipv6 forwarding
awplus(config)# ipv6 multicast-routing
awplus(config)# no ipv6 pim register-source
```

# ipv6 pim register-suppression

**Overview** Use this command to configure the register-suppression time, in seconds, overriding the default of 60 seconds.

Use the **no** variant of this command to reset the value to its default of 60 seconds.

**Syntax** `ipv6 pim register-suppression <1-65535>`  
`no ipv6 pim register-suppression`

| Parameter | Description                              |
|-----------|------------------------------------------|
| <1-65535> | Register suppression on time in seconds. |

**Mode** Global Configuration

**Default** The default PIM-SMv6 register suppression time is 60 seconds, and is restored with the no variant of this command.

**Usage** Configuring this value modifies register-suppression time at the DR. Configuring this value at the RP modifies the RP-keepalive-period value if the [ipv6 pim rp-register-kat](#) command is not used.

**Examples**

```
awplus# configure terminal
awplus(config)# ipv6 forwarding
awplus(config)# ipv6 multicast-routing
awplus(config)# ipv6 pim register-suppression 192
awplus# configure terminal
awplus(config)# no ipv6 pim register-suppression
```

# ipv6 pim rp-address

**Overview** The AR3050S and AR4050 devices don't support access control list in 5.4.5-0.1 release.

Use this command to statically configure RP (Rendezvous Point) address for IPv6 multicast groups.

Use the **no** variant of this command to remove a statically configured RP (Rendezvous Point) address for IPv6 multicast groups.

**Syntax** `ipv6 pimv6 rp-address <IPv6-address>`  
`no ipv6 pim rp-address <IPv6-address>`

| Parameter      | Description                                                                     |
|----------------|---------------------------------------------------------------------------------|
| <IPv6-address> | Specify the IPv6 address of the Rendezvous Point, entered in the form X:X::X:X. |

**Mode** Global Configuration

**Usage** The AlliedWare Plus™ PIM-SMv6 implementation supports multiple static RPs. It also supports usage of static-RP and BSR mechanism simultaneously. The **ipv6 pim rp-address** command is used to statically configure the RP address for IPv6 multicast groups.

You need to understand the following information before using this command.

If the RP-address that is configured by the BSR, and the RP-address that is configured statically, are both available for a group range, then the RP-address configured through BSR is chosen over the statically configured RP-address.

If multiple static-RPs are available for a group range, then one with the highest IPv6 address is chosen.

After configuration, the RP-address is inserted into a static-RP group tree based on the configured group ranges. For each group range, multiple static-RPs are maintained in a list. This list is sorted in a descending order of IPv6 addresses. When selecting static-RPs for a group range, the first element (which is the static-RP with highest IPv6 address) is chosen.

RP-address deletion is handled by removing the static-RP from all the existing group ranges and recalculating the RPs for existing TIB states if required.

Group mode and RP address mappings learned through BSR take precedence over mappings statistically defined by the `ipv6 pim rp-address` command. Commands with the `override` keyword take precedence over dynamically learned mappings.

**Examples** `awplus# configure terminal`  
`awplus(config)# no ipv6 pim rp-address 3ffe:30:30:5::153 G2`

**Related  
commands** [ipv6 pim rp-candidate](#)  
[ipv6 pim rp-register-kat](#)



# ipv6 pim rp-candidate

**Overview** Use this command to make the device an RP (Rendezvous Point) candidate, using the IPv6 address of the specified VLAN interface.

Use the **no** variant of this command to stop the device from being an RP candidate.

**Syntax** `ipv6 pim rp-candidate <interface> [priority <priority>|interval <interval>|grouplist <accesslist>]`  
`no ipv6 pim rp-candidate [<interface>]`

| Parameter    | Description                                                                      |
|--------------|----------------------------------------------------------------------------------|
| <interface>  | Specify a VLAN interface name.                                                   |
| <priority>   | Specify the priority for the RP candidate in the range 0 to 255.                 |
| <interval>   | Specify a candidate RP advertisement interval in the range 1 to 16383 (seconds). |
| <accesslist> | Specify a Standard or an Extended software IPv6 access list name.                |

**Default** The priority value for a candidate RP is 192 by default until specified using the **priority** parameter.

**Mode** Global Configuration

**Usage** Note that issuing the command **ipv6 pim rp-candidate <interface>** without optional **priority**, **interval**, or **grouplist** parameters will configure the candidate RP with a priority value of 192.

**Examples** To specify a priority of 3, use the following commands:

```
awplus# configure terminal
awplus(config)# ipv6 forwarding
awplus(config)# ipv6 multicast-routing
awplus(config)# ipv6 pim rp-candidate vlan2 priority 3
```

To stop the device from being an RP candidate on vlan2 , use the following commands:

```
awplus# configure terminal
awplus(config)# no ipv6 pim rp-candidate vlan2
```

**Related commands** [ipv6 pim rp-address](#)  
[ipv6 pim rp-register-kat](#)

# ipv6 pim rp embedded

**Overview** Use this command to configure and enable embedded RP (Rendezvous Point) in PIM-SMv6.

This command only applies to the embedded RP group range **ff7x::/12** and **fffx::/12**.

Use the **no** variant of this command to disable embedded RP support. Since embedded RP support is enabled by default, use the **no** variant of this command to disable the default.

**Syntax** `ipv6 pim rp embedded`  
`no ipv6 pim rp embedded`

**Mode** Global Configuration

**Default** Embedded RP is enabled by default in the AlliedWare Plus implementation of PIM-SMv6.

**Examples** The following example re-enables embedded RP support, the default state in PIM-SMv6:

```
awplus# configure terminal
awplus(config)# ipv6 forwarding
awplus(config)# ipv6 multicast-routing
awplus(config)# ipv6 pim rp embedded
```

The following example disables embedded RP support, which is enabled by default in PIM-SMv6:

```
awplus# configure terminal
awplus(config)# no ipv6 pim rp embedded
```

# ipv6 pim rp-register-kat

**Overview** Use this command to configure the Keep Alive Time (KAT) for (S,G) states at the RP (Rendezvous Point) to monitor PIM-SMv6 Register packets.

Use the **no** variant of this command to return the PIM-SMv6 KAT timer to its default value of 210 seconds.

**Syntax** `ipv6 pim rp-register-kat <1-65535>`  
`no ipv6 pim rp-register-kat`

| Parameter | Description                                                         |
|-----------|---------------------------------------------------------------------|
| <1-65536> | Specify the KAT timer in seconds. The default value is 210 seconds. |

**Mode** Global Configuration

**Default** The default PIM-SMv6 KAT timer value is 210 seconds.

**Examples**

```
awplus# configure terminal
awplus(config)# ipv6 forwarding
awplus(config)# ipv6 multicast-routing
awplus(config)# ipv6 pim rp-register-kat 3454
awplus# configure terminal
awplus(config)# no ipv6 pim rp-register-kat
```

**Related commands** [ipv6 pim rp-address](#)  
[ipv6 pim rp-candidate](#)

# ipv6 pim sparse-mode

**Overview** Use this command to enable PIM-SMv6 on a VLAN interface or a PPP interface. Use the **no** variant of this command to disable PIM-SMv6 on a VLAN interface or a PPP interface.

**Syntax** `ipv6 pim sparse-mode`  
`no ipv6 pim sparse-mode`

**Mode** Interface Configuration for a VLAN interface or a PPP interface.

**Examples**

```
awplus# configure terminal
awplus(config)# ipv6 forwarding
awplus(config)# ipv6 multicast-routing
awplus(config)# interface vlan2
awplus(config-if)# ipv6 enable
awplus(config-if)# ipv6 pim sparse-mode
awplus# configure terminal
awplus(config)# interface vlan2
awplus(config-if)# no ipv6 pim sparse-mode
awplus# configure terminal
awplus(config)# ipv6 forwarding
awplus(config)# ipv6 multicast-routing
awplus(config)# interface ppp0
awplus(config-if)# ipv6 enable
awplus(config-if)# ipv6 pim sparse-mode
awplus# configure terminal
awplus(config)# interface ppp0
awplus(config-if)# no ipv6 pim sparse-mode
```

# ipv6 pim sparse-mode passive

**Overview** Use this command to enable and disable PIM-SMv6 passive mode operation for local members on a VLAN interface or a PPP interface.

Use the **no** variant of this command to disable PIM-SMv6 passive mode operation for local members on a VLAN interface or a PPP interface.

**Syntax** `ipv6 pim sparse-mode passive`  
`no ipv6 pim sparse-mode passive`

**Mode** Interface Configuration for a VLAN interface or a PPP interface.

**Usage** Passive mode essentially stops PIM-SMv6 transactions on the interface, allowing only the MLD mechanism to be active.

**Examples**

```
awplus# configure terminal
awplus(config)# ipv6 forwarding
awplus(config)# ipv6 multicast-routing
awplus(config)# interface vlan2
awplus(config-if)# ipv6 enable
awplus(config-if)# ipv6 pim sparse-mode passive
awplus# configure terminal
awplus(config)# interface vlan2
awplus(config-if)# no ipv6 pim sparse-mode passive
awplus# configure terminal
awplus(config)# ipv6 forwarding
awplus(config)# ipv6 multicast-routing
awplus(config)# interface ppp0
awplus(config-if)# ipv6 enable
awplus(config-if)# ipv6 pim sparse-mode passive
awplus# configure terminal
awplus(config)# interface ppp0
awplus(config-if)# no ipv6 pim sparse-mode passive
```

# ipv6 pim spt-threshold

**Overview** This command turns on the ability for the last-hop PIM-SMv6 router to switch to SPT (shortest-path tree).

The **no** variant of this command turns off the ability for the last-hop PIM-SMv6 router to switch to SPT.

**NOTE:** *The switching to SPT happens either at the receiving of the first data packet, or not at all; it is not rate-based.*

**Syntax** `ipv6 pim spt-threshold`  
`no ipv6 pim spt-threshold`

**Mode** Global Configuration

**Examples** To enable the last-hop PIM-SMv6 router to switch to SPT, use the following commands:

```
awplus# configure terminal
awplus(config)# ipv6 forwarding
awplus(config)# ipv6 multicast-routing
awplus(config)# ipv6 pim spt-threshold
```

To stop the last-hop PIM-SMv6 router from being able to switch to SPT, use the following commands:

```
awplus# configure terminal
awplus(config)# no ipv6 pim spt-threshold
```

# ipv6 pim ssm

**Overview** Use this command to define the Source Specific Multicast (SSM) range of IPv6 multicast addresses. PIM-SMv6 routers will only install (S,G) entries for multicast groups (addresses) residing in the SSM range.

Use the **no** variant of this command to disable the SSM range.

**Syntax** `ipv6 pim ssm [default]`  
`no ipv6 pim ssm`

| Parameter | Description                                                    |
|-----------|----------------------------------------------------------------|
| default   | Named Standard Access List. Use FF3x::/32 group range for SSM. |

**Default** By default, the command is disabled.

**Mode** Global Configuration

**Usage** Any (\*,G) or (S,G,rpt) joins received for multicast groups (addresses) within the range, are not installed in PIM-SMv6 mroute table.

**Examples** The following commands show how to set PIM-SSM as default:

```
awplus# configure terminal
awplus(config)# ipv6 pim ssm default
```

The following commands show how to disable PIM-SSM:

```
awplus# configure terminal
awplus(config)# no ipv6 pim ssm
```

# ipv6 pim unicast-bsm

**Overview** Use this command to enable support for the sending and receiving of unicast Boot Strap Messages (BSM) on a VLAN interface.

Use the **no** variant of this command to disable the sending and receiving of unicast BSM on a VLAN interface.

**Syntax** `ipv6 pim unicast-bsm`  
`no ipv6 pim unicast-bsm`

**Mode** Interface Configuration for a VLAN interface.

**Default** Unicast BSM is disabled by default on an interface.

**Usage** This command provides backward compatibility with older versions of the Boot Strap Router (BSR) specification, which directs unicast BSM to refresh the state of new or restarting neighbors. The current BSR specification defines a No Forward BSM to achieve the same result.

**Examples**

```
awplus# configure terminal
awplus(config)# ipv6 forwarding
awplus(config)# ipv6 multicast-routing
awplus(config)# interface vlan2
awplus(config-if)# ipv6 enable
awplus(config-if)# ipv6 pim unicast-bsm
awplus# configure terminal
awplus(config)# interface vlan2
awplus(config-if)# no ipv6 pim unicast-bsm
```



# show debugging ipv6 pim sparse-mode

**Overview** This command displays the status of the PIM-SMv6 debugging on your device.

For information on filtering and saving command output, see the [“Getting Started with AlliedWare Plus” Feature Overview and Configuration Guide](#).

**Syntax** `show debugging ipv6 pim sparse-mode`

**Mode** User Exec and Privileged Exec

**Example** To display PIM-SMv6 debugging settings, use the command:

```
awplus# show debugging ipv6 pim sparse-mode
```

Figure 39-2: Example output from the **show debugging ipv6 pim sparse-mode** command

```
awplus#show debugging ipv6 pim sparse-mode
Debugging status:
 PIM event debugging is on
 PIM MFC debugging is on
 PIM state debugging is on
 PIM packet debugging is on
 PIM Hello HT timer debugging is on
 PIM Hello NLT timer debugging is on
 PIM Hello THT timer debugging is on
 PIM Join/Prune JT timer debugging is on
 PIM Join/Prune ET timer debugging is on
 PIM Join/Prune PPT timer debugging is on
 PIM Join/Prune KAT timer debugging is on
 PIM Join/Prune OT timer debugging is on
 PIM Assert AT timer debugging is on
 PIM Register RST timer debugging is on
 PIM Bootstrap BST timer debugging is on
 PIM Bootstrap CRP timer debugging is on
```

**Related commands** [debug ipv6 pim sparse-mode](#)  
[undebug ipv6 pim sparse-mode](#)

# show ipv6 pim sparse-mode bsr-router

**Overview** Use this command to show the PIM-SMv6 Bootstrap Router (BSR) IPv6 address.

For information on filtering and saving command output, see the [“Getting Started with AlliedWare Plus” Feature Overview and Configuration Guide](#).

**Syntax** `show ipv6 pim sparse-mode bsr-router`

**Mode** User Exec and Privileged Exec

**Example** To display the BSR IPv6 address, use the command:

```
awplus# show ipv6 pim sparse-mode bsr-router
```

**Output** Figure 39-3: Example output from the **show ipv6 pim sparse-mode bsr-router** command

```
awplus#show ipv6 pim sparse-mode bsr-router
PIM6v2 Bootstrap information
 BSR address: 2001:203::213 (?)
 Uptime: 00:36:25, BSR Priority: 64, Hash mask length: 126
 Expires: 00:01:46
 Role: Candidate BSR
 State: Candidate BSR

Candidate RP: 2001:5::211(vlan5)
 Advertisement interval 60 seconds
 Next C-RP advertisement in 00:00:43
```

**Related commands** [show ipv6 pim sparse-mode rp mapping](#)  
[show ipv6 pim sparse-mode neighbor](#)

# show ipv6 pim sparse-mode interface

**Overview** Use this command to show PIM-SMv6 interface information. Note that you can specify an individual VLAN interface with the optional parameter. Alternatively, you can display PIM-SMv6 interface information for all interfaces if you omit the optional interface parameter.

For information on filtering and saving command output, see the [“Getting Started with AlliedWare Plus” Feature Overview and Configuration Guide](#).

**Syntax** `show ipv6 pim sparse-mode interface`

**Mode** User Exec and Privileged Exec

**Examples** To display information about all PIM-SMv6 interfaces, use the command:

```
awplus# show ipv6 pim sparse-mode interface
```

```
awplus#show ipv6 pim sparse-mode interface
Interface VIFindex Ver/ Nbr DR
 Mode Count Priority
vlan2 0 v2/S 2 1
 Address : fe80::207:e9ff:fe02:81d
 Global Address: 3ffe:192:168:1::53
 DR : fe80::20e:cff:fe01:facc
vlan3 2 v2/S 2 1
 Address : fe80::207:e9ff:fe02:21a2
 Global Address: 3ffe:192:168:10::53
 DR : this system
```

**Table 1:** Parameters in the output from the **show ipv6 pim sparse-mode interface** command

| Parameters  | Description                                |
|-------------|--------------------------------------------|
| Address     | Primary PIM-SMv6 address.                  |
| Interface   | Name of the PIM-SMv6 interface.            |
| VIF Index   | The Virtual Interface index of the VLAN.   |
| Ver/Mode    | PIMv6 version/Sparse mode.                 |
| Nbr Count   | Neighbor count of the PIM-SMv6 interface.  |
| DR Priority | Designated Router priority.                |
| DR          | The IPv6 address of the Designated Router. |

**Related commands**

- ipv6 pim sparse-mode
- show ipv6 pim sparse-mode rp mapping
- show ipv6 pim sparse-mode neighbor

# show ipv6 pim sparse-mode interface detail

**Overview** Use this command to show detailed PIM-SMv6 information for all PIM-SMv6 configured interfaces.

For information on filtering and saving command output, see the [“Getting Started with AlliedWare Plus” Feature Overview and Configuration Guide](#).

**Syntax** `show ipv6 pim sparse-mode interface detail`

**Mode** User Exec and Privileged Exec

**Example** To show detailed PIM-SMv6 information for all PIM-SMv6 configured interfaces, use the command:

```
awplus# show ipv6 pim sparse-mode interface detail
```

**Output** Figure 39-4: Example output from the **show ipv6 pim sparse-mode interface detail** command

```
awplus#show ipv6 pim sparse-mode interface detail
vlan2 (vif 0)
 Address fe80::207:e9ff:fe02:81d, DR fe80::20e:cff:fe01:facc
 Hello period 30 seconds, Next Hello in 21 seconds
 Triggered Hello period 5 seconds
 Secondary addresses:
 3ffe:192:168:1::53
 Neighbors:
 fe80::202:b3ff:fed4:69fe
 fe80::20e:cff:fe01:facc

vlan3 (vif 2):
 Address fe80::207:e9ff:fe02:21a2, DR fe80::207:e9ff:fe02:21a2
 Hello period 30 seconds, Next Hello in 20 seconds
 Triggered Hello period 5 seconds
 Secondary addresses:
 3ffe:192:168:10::53
 Neighbors:
```

# show ipv6 pim sparse-mode local-members

**Overview** Use this command to show detailed local member information on a VLAN interface configured for PIM-SMv6. If you do not specify a VLAN interface then detailed local member information is shown for all VLAN interfaces configured for PIM-SMv6.

For information on filtering and saving command output, see the [“Getting Started with AlliedWare Plus” Feature Overview and Configuration Guide](#).

**Syntax** `show ipv6 pim sparse-mode local-members [<interface>]`

| Parameter   | Description                                                                       |
|-------------|-----------------------------------------------------------------------------------|
| <interface> | Optional Specify the interface. For instance, VLAN interface <code>vlan2</code> . |

**Mode** User Exec and Privileged Exec

**Example** To show detailed PIM-SMv6 information for all PIM-SMv6 configured VLAN interfaces, use the command:

```
awplus# show ipv6 pim sparse-mode local-members
```

**Output** Figure 39-5: Example output from the **show ipv6 pim sparse-mode local-members** command

```
awplus#show ipv6 pim sparse-mode local-members
PIM Local membership information

vlan1:

 (*, ff02::1:ff6b:4783) : Include

vlan203:

 (*, ff0e:1::4) : Include
```

**Example** To show detailed PIM-SMv6 information for the PIM-SMv6 configured interface `vlan1`, use the command:

```
awplus# show ipv6 pim sparse-mode local-members vlan1
```

**Output** Figure 39-6: Example output from the **show ipv6 pim sparse-mode local-members vlan1** command

```
awplus#show ipv6 pim sparse-mode local-members vlan1
PIM Local membership information

vlan1:

(*, ff02::1:ff6b:4783) : Include
```

# show ipv6 pim sparse-mode mroute

**Overview** This command displays the IPv6 multicast routing table, or the IPv6 multicast routing table based on the specified IPv6 address or addresses.

Two group IPv6 addresses cannot be used simultaneously; two source IPv6 addresses cannot be used simultaneously.

For information on filtering and saving command output, see the [“Getting Started with AlliedWare Plus” Feature Overview and Configuration Guide](#).

**Syntax**

```
show ipv6 pim sparse-mode mroute
[<group-IPv6-address>|<source-IPv6-address>]

show ipv6 pim sparse-mode mroute [<group-IPv6-address>
<source-IPv6-address>]

show ipv6 pim sparse-mode mroute [<source-IPv6-address>
<group-IPv6-address>]
```

| Parameter                          | Description                                                                                                                                                             |
|------------------------------------|-------------------------------------------------------------------------------------------------------------------------------------------------------------------------|
| <i>&lt;group-IPv6-address&gt;</i>  | Group IPv6 address, entered in the form X:X::X:X. Based on the group and source IPv6 address, the output is the selected route if present in the multicast route tree.  |
| <i>&lt;source-IPv6-address&gt;</i> | Source IPv6 address, entered in the form X:X::X:X. Based on the source and group IPv6 address, the output is the selected route if present in the multicast route tree. |

**Mode** User Exec and Privileged Exec

**Usage** Note that when a feature license is enabled, the output for the `show ipv6 pim sparse-mode mroute` command will only show 100 interfaces because of the terminal display width limit. Use the `show ipv6 pim sparse-mode mroute detail` command to display detailed entries of the IPv6 multicast routing table.

**Examples**

```
awplus# show ipv6 pim sparse-mode mroute
awplus# show ipv6 pim sparse-mode mroute 2001:db8::
awplus# show ipv6 pim sparse-mode mroute 2001:db8:: 2002:db8::
```



Figure 39-7: Example output from the **show ipv6 pim sparse-mode mroute** command

```
awplus#show ipv6 pim sparse-mode mroute
IPv6 Multicast Routing Table

(*, *,RP) Entries: 0
(*,G) Entries: 2
(S,G) Entries: 0
(S,G,rpt) Entries: 0
FCR Entries: 2

(*, ff0x::db8:0:0/96)
RP: 3ffe:10:10:5::153
RPF nbr: fe80::202:b3ff:fed4:69fe
RPF idx: wm0
Upstream State: JOINED
 Local ..l.....
 Joined
 Asserted
FCR:
Source: 3ffe:10:10:1::96
 Outgoing ..o.....
 KAT timer running, 205 seconds remaining
 Packet count 1

(*, ff0x::db8:0:0/96)
RP: 3ffe:10:10:5::153
RPF nbr: fe80::202:b3ff:fed4:69fe
RPF idx: wm0
Upstream State: JOINED
 Local ..l.....
 Joined
 Asserted
FCR:
Source: 3ffe:10:10:1::96
 Outgoing ..o.....
 KAT timer running, 208 seconds remaining
 Packet count 1
```

# show ipv6 pim sparse-mode mroute detail

**Overview** This command displays detailed entries of the IPv6 multicast routing table, or detailed entries of the IPv6 multicast routing table based on the specified IPv6 address or addresses.

Two group IPv6 addresses cannot be used simultaneously; two IPv6 source addresses cannot be used simultaneously.

For information on filtering and saving command output, see the [“Getting Started with AlliedWare Plus” Feature Overview and Configuration Guide](#).

**Syntax** `show ipv6 pim sparse-mode mroute [<source-IPv6-address>] detail`

| Parameter                                | Description                                                                                                  |
|------------------------------------------|--------------------------------------------------------------------------------------------------------------|
| <code>&lt;source-IPv6-address&gt;</code> | Source IPv6 address, entered in the form X:X::X:X. Output is all multicast entries belonging to that source. |
| <code>detail</code>                      | Show detailed information.                                                                                   |

**Usage** Based on the group and source IPv6 address, the output is the selected route if present in the multicast route tree.

**Mode** User Exec and Privileged Exec

**Examples**

```
awplus# show ipv6 pim sparse-mode mroute detail
awplus# show ipv6 pim sparse-mode mroute 2001:db8:: detail
awplus# show ipv6 pim sparse-mode mroute 2001:db8:: 2002:db8::
detail
```

Figure 39-8: Example output from the **show ipv6 pim sparse-mode mroute detail** command

```
awplus#show ipv6 pim sparse-mode mroute detail
IPv6 Multicast Routing Table

(*,*,RP) Entries: 0
(*,G) Entries: 1
(S,G) Entries: 0
(S,G,rpt) Entries: 0
FCR Entries: 0

(*, ff13::10) Uptime: 00:00:09
RP: ::, RPF nbr: None, RPF idx: None
Upstream:
 State: JOINED, SPT Switch: Enabled, JT: off
 Macro state: Join Desired,
Downstream:
 vlan2:
 State: NO INFO, ET: off, PPT: off
 Assert State: NO INFO, AT: off
 Winner: ::, Metric: 42949672951, Pref: 42949672951, RPT bit: on
 Macro state: Could Assert, Assert Track
Local Olist:
 vlan3
FCR:
```

# show ipv6 pim sparse-mode neighbor

**Overview** Use this command to show the PIM-SMv6 neighbor information.

For information on filtering and saving command output, see the [“Getting Started with AlliedWare Plus” Feature Overview and Configuration Guide](#).

**Syntax** `show ipv6 pim sparse-mode neighbor [<interface>]  
[<IPv6-address>] [detail]`

| Parameter      | Description                                                                                              |
|----------------|----------------------------------------------------------------------------------------------------------|
| <interface>    | Interface name (e.g. vlan2). Show neighbors on an interface.                                             |
| <IPv6-address> | Show neighbors with a particular address on an interface. The IPv6 address entered in the form X:X::X:X. |
| detail         | Show detailed information.                                                                               |

**Mode** User Exec and Privileged Exec

**Examples** `awplus# show ipv6 pim sparse-mode neighbor`  
`awplus# show ipv6 pim sparse-mode neighbor vlan5 detail`

Figure 39-9: Example output from the **show ipv6 pim sparse-mode neighbor** command

```
awplus#show ipv6 pim sparse-mode neighbor
Neighbor Address Interface Uptime/Expires DR
 Pri/Mode
fe80::202:b3ff:fed4:69fe vlan2 05:33:52/00:01:41 1 /
fe80::20e:cff:fe01:facc vlan3 05:33:53/00:01:26 1 / DR
```

Figure 39-10: Example output from the **show ipv6 pim sparse-mode neighbor interface detail** command

```
awplus#show ipv6 pim sparse-mode neighbor detail
Nbr fe80::211:11ff:fe44:4cd8 (vlan1), DR
Expires in 64 seconds, uptime 00:00:53
Holdtime: 70 secs, T-bit: off, Lan delay: 1, Override interval: 3
DR priority: 100, Gen ID: 1080091886,
Secondary addresses:
3ffe:10:10:10:3::180
```

# show ipv6 pim sparse-mode nexthop

**Overview** Use this command to see the next hop information as used by PIM-SMv6.

For information on filtering and saving command output, see the [“Getting Started with AlliedWare Plus” Feature Overview and Configuration Guide](#).

**Syntax** show ipv6 pim sparse-mode nexthop

**Mode** User Exec and Privileged Exec

**Example** awplus# show ipv6 pim sparse-mode nexthop

Figure 39-11: Example output from the **show ipv6 pim sparse-mode nexthop** command

```
awplus#show ipv6 pim sparse-mode nexthop
Flags: N = New, R = RP, S = Source, U = Unreachable
Destination Type Nexthop Nexthop Nexthop Nexthop Metric Pref Refcnt
 Num Addr Ifindex Name

3ffe:10:10:5::153 .RS. 1 fe80::20e:cff:fe01:facc 2 30 110 1
```

**Table 2:** Parameters in output of the **show ipv6 pim sparse-mode nexthop** command

| Parameter       | Description                                                                                                  |
|-----------------|--------------------------------------------------------------------------------------------------------------|
| Destination     | The destination address for which PIM-SMv6 requires next hop information.                                    |
| Type            | The type of destination, as indicated by the Flags description. N = New, R= RP, S = Source, U = Unreachable. |
| Nexthop Num     | The number of next hops to the destination. PIM-SMv6 always uses only 1 next hop.                            |
| Nexthop Addr    | The address of the primary next hop gateway.                                                                 |
| Nexthop IfIndex | The interface on which the next hop gateway can be reached.                                                  |
| Nexthop Name    | The name of next hop interface.                                                                              |
| Metric          | The metric of the route towards the destination.                                                             |
| Preference      | The preference of the route towards destination.                                                             |
| Refcnt          | Only used for debugging.                                                                                     |

# show ipv6 pim sparse-mode rp-hash

**Overview** Use this command to display the Rendezvous Point (RP) to be chosen based on the IPv6 group address selected.

For information on filtering and saving command output, see the [“Getting Started with AlliedWare Plus” Feature Overview and Configuration Guide](#).

**Syntax** `show ipv6 pim sparse-mode rp-hash <IPv6-group-addr>`

| Parameter                            | Description                                                               |
|--------------------------------------|---------------------------------------------------------------------------|
| <code>&lt;IPv6-group-addr&gt;</code> | The IPv6 group address used to find the RP, entered in the form X:X::X:X. |

**Mode** User Exec and Privileged Exec

**Example** `awplus# show ipv6 pim sparse-mode rp-hash ff04:10`

Figure 39-12: Output from the **show ipv6 pim sparse-mode rp-hash** command:

```
awplus#show ipv6 pim sparse-mode rp-hash ff04::10
RP: 3ffe:10:10:5::153
Info source: 3ffe:10:10:5::153, via bootstrap
```

**Related commands** [show ipv6 pim sparse-mode rp mapping](#)

# show ipv6 pim sparse-mode rp mapping

**Overview** Use this command to show group-to-RP (Rendezvous Point) mappings, and the RP set.

For information on filtering and saving command output, see the [“Getting Started with AlliedWare Plus” Feature Overview and Configuration Guide](#).

**Syntax** `show ipv6 pim sparse-mode rp mapping`

**Mode** User Exec and Privileged Exec

**Example** `awplus# show ipv6 pim sparse-mode rp mapping`

Figure 39-13: Output from the **show ipv6 pim sparse-mode rp mapping** command

```
awplus#show ipv6 pim sparse-mode rp mapping
PIM Group-to-RP Mappings
Group(s): ff00::/8
 RP: 3ffe:10:10:5::153
 Info source: 3ffe:10:10:5::153, via bootstrap, priority 192
 Uptime: 05:36:40
```

**Related commands** [show ipv6 pim sparse-mode rp-hash](#)

# show ipv6 pim sparse-mode rp nexthop

**Overview** Use this command to display the RP (Rendezvous Point) next hop information used by PIM-SMv6.

For information on filtering and saving command output, see the [“Getting Started with AlliedWare Plus” Feature Overview and Configuration Guide](#).

**Syntax** `show ipv6 pim sparse-mode rp nexthop <RP-group-addr>`

| Parameter       | Description                                                                                         |
|-----------------|-----------------------------------------------------------------------------------------------------|
| <RP-group-addr> | Specify the RP group address used to display next hop RP information, entered in the form X:X::X:X. |

**Mode** User Exec and Privileged Exec

**Example** `awplus# show ipv6 pim sparse-mode rp nexthop 3ffe:10:10:5::153`

Figure 39-14: Example output from the **show ipv6 pim sparse-mode rp nexthop** command

```
awplus#show ipv6 pim sparse-mode rp nexthop 3ffe:10:10:5::153
Flags: N = New, R = RP, S = Source, U = Unreachable
Destination Type Nexthop Nexthop Nexthop Nexthop Metric Pref Refcnt
 Num Addr Ifindex Name

3ffe:10:10:5::153 .RS. 1 fe80::20e:cff:fe01:facc 2 30 110 1
```

**Table 3:** Parameters in output of the **show ipv6 pim sparse-mode rp nexthop** command

| Parameter       | Description                                                                                                  |
|-----------------|--------------------------------------------------------------------------------------------------------------|
| Destination     | The destination address for which PIM-SMv6 requires next hop information.                                    |
| Type            | The type of destination, as indicated by the Flags description. N = New, R= RP, S = Source, U = Unreachable. |
| Nexthop Num     | The number of next hops to the destination. PIM-SMv6 always uses only 1 next hop.                            |
| Nexthop Addr    | The address of the primary next hop gateway.                                                                 |
| Nexthop IfIndex | The interface on which the next hop gateway can be reached.                                                  |
| Nexthop Name    | The name of next hop interface.                                                                              |



**Table 3:** Parameters in output of the **show ipv6 pim sparse-mode rp nexthop** command (cont.)

| Parameter  | Description                                      |
|------------|--------------------------------------------------|
| Metric     | The metric of the route towards the destination. |
| Preference | The preference of the route towards destination. |
| Refcnt     | Only used for debugging.                         |

# undebbug all ipv6 pim sparse-mode

**Overview** Use this command to disable all PIM-SMv6 debugging.

**Syntax** `undebbug all ipv6 pim sparse-mode`

**Mode** Privileged Exec

**Example** `awplus# undebbug all ipv6 pim sparse-mode`

**Related commands** [debug ipv6 pim sparse-mode](#)

# undebg ipv6 pim sparse-mode

**Overview** Use this command to deactivate PIM-SMv6 debugging. Note that this command is an alias of the no variant of the [debug ipv6 pim sparse-mode](#) command.

**Syntax** `undebg ipv6 pim sparse-mode [all] [events] [mfc] [mib] [nexthop] [nsm] [state] [timer]`

| Parameter | Description                                                                     |
|-----------|---------------------------------------------------------------------------------|
| all       | Deactivates all PIM-SMv6 debugging.                                             |
| events    | Deactivates debug printing of PIM-SMv6 events.                                  |
| mfc       | Deactivates debug printing of MFC (Multicast Forwarding Cache).                 |
| mib       | Deactivates debug printing of PIM-SMv6 MIBs.                                    |
| nexthop   | Deactivates debug printing of PIM-SMv6 next hop communications.                 |
| nsm       | Deactivates debugging of PIM-SMv6 NSM (Network Services Module) communications. |
| state     | Deactivates debug printing of state transition on all PIM-SMv6 FSMs.            |
| timer     | Deactivates debug printing of PIM-SMv6 timers.                                  |

**Mode** Privileged Exec and Global Configuration

**Example**

```
awplus# configure terminal
awplus(config)# terminal monitor
awplus(config)# undebg ipv6 pim sparse-mode all
awplus# configure terminal
awplus(config)# terminal monitor
awplus(config)# undebg ipv6 pim sparse-mode events
awplus# configure terminal
awplus(config)# terminal monitor
awplus(config)# undebg ipv6 pim sparse-mode nexthop
```

**Validation Output** Figure 39-15: Example output from the **show debugging ipv6 pim sparse-mode** command after issuing the **undebug ipv6 pim sparse-mode all** command

```
awplus#undebug ipv6 pim sparse-mode all
awplus#show debugging ipv6 pim sparse-mode
PIM-SMv6 debugging status:
 PIM event debugging is off
 PIM MFC debugging is off
 PIM state debugging is off
 PIM packet debugging is off
 PIM Hello HT timer debugging is off
 PIM Hello NLT timer debugging is off
 PIM Hello THT timer debugging is off
 PIM Join/Prune JT timer debugging is off
 PIM Join/Prune ET timer debugging is off
 PIM Join/Prune PPT timer debugging is off
 PIM Join/Prune KAT timer debugging is off
 PIM Join/Prune OT timer debugging is off
 PIM Assert AT timer debugging is off
 PIM Register RST timer debugging is off
 PIM Bootstrap BST timer debugging is off
 PIM Bootstrap CRP timer debugging is off
 PIM mib debugging is off
 PIM nsm debugging is off
 PIM nexthop debugging is off
```

**Related commands**

- [debug ipv6 pim sparse-mode](#)
- [show debugging ipv6 pim sparse-mode](#)
- [undebug all ipv6 pim sparse-mode](#)

# Part 5: Access and Security

# 40

# Traffic Control Commands

## Introduction

**Overview** This chapter provides an alphabetical reference of commands used to configure traffic control. For more information, see the [Traffic Control Feature Overview and Configuration Guide](#).

- Command List**
- “class (htb)” on page 1800
  - “class (priority)” on page 1802
  - “class (wrr)” on page 1804
  - “debug traffic-control” on page 1806
  - “interface (traffic-control)” on page 1807
  - “l3-filtering enable” on page 1808
  - “move rule (traffic-control)” on page 1809
  - “policy (traffic-control)” on page 1810
  - “red-curve” on page 1812
  - “rule (traffic-control)” on page 1814
  - “show debugging traffic-control” on page 1816
  - “show running-config traffic-control” on page 1817
  - “show traffic-control counters” on page 1819
  - “show traffic-control interface” on page 1821
  - “show traffic-control policy” on page 1823
  - “show traffic-control red-curve” on page 1825
  - “show traffic-control rule config-check” on page 1827
  - “show traffic-control rule” on page 1828
  - “show traffic-control” on page 1829

- [“sub-class \(htb\)”](#) on page 1830
- [“sub-class \(priority\)”](#) on page 1832
- [“sub-class \(wrr\)”](#) on page 1834
- [“sub-sub-class \(htb\)”](#) on page 1836
- [“sub-sub-class \(priority\)”](#) on page 1838
- [“sub-sub-class \(wrr\)”](#) on page 1840
- [“traffic-control enable”](#) on page 1842
- [“traffic-control”](#) on page 1843

# class (htb)

**Overview** Use this command to configure a hierarchy token bucket (HTB) class within a traffic control policy.

Use the **no** variant of this command to delete an existing class under a current policy.

**Syntax** `class <class-name> [cir <committed-rate>] [pir <peak-rate>]  
[bc <1-100000000>] [be <1-100000000>] [preference <0-7>]  
[queue-length <2-65536>] [set-dscp <dscp-value>] [red-curve  
<red-curve-name>]`

`class <class-name> [cir <committed-rate>] [pir <peak-rate>]  
[bc <1-100000000>] [be <1-100000000>] [preference <0-7>]  
sub-class-policy htb`

`no class <class-name>`

| Parameter                                     | Description                                                                                                                                                                                                   |
|-----------------------------------------------|---------------------------------------------------------------------------------------------------------------------------------------------------------------------------------------------------------------|
| <code>&lt;class-name&gt;</code>               | Name of the class.                                                                                                                                                                                            |
| <code>cir &lt;committed-rate&gt;</code>       | Set the Committed Information Rate (CIR) for the queue. This parameter is compulsory when creating a new class. When editing an existing class, this parameter is optional.                                   |
| <code>pir &lt;peak-rate&gt;</code>            | Set the Peak Information Rate (PIR) for the queue. This is the rate of the queue under peak conditions. Specified in kbit/mbit/gbit per second, in the range 1kbit-100gbit.                                   |
| <code>bc &lt;1-100000000&gt;</code>           | Set the Committed Burst size (BC). This is the burst allowed above the CIR sent at the PIR rate.                                                                                                              |
| <code>be &lt;1-100000000&gt;</code>           | Set the Excess Burst size (BE). This is the burst allowed above the PIR sent at the maximum rate.                                                                                                             |
| <code>preference &lt;0-7&gt;</code>           | Set the preference for a class to receive spare bandwidth. Preference for the class to receive spare bandwidth (highest is 7).                                                                                |
| <code>queue-length &lt;2-65536&gt;</code>     | Set the maximum queue length.                                                                                                                                                                                 |
| <code>set-dscp &lt;dscp-value&gt;</code>      | Set the DSCP value to apply to the packets.                                                                                                                                                                   |
| <code>red-curve &lt;red-curve-name&gt;</code> | Apply a random early discard template with the class (only available on leaf queues when specifying class policy). If the keyword <code>&lt;default&gt;</code> is used then the default RED curve is applied. |
| <code>sub-class-policy</code>                 | Specify that the class will contain sub-classes.                                                                                                                                                              |
| <code>htb</code>                              | Sub-classes will use the Hierarchy Token Bucket (HTB) queueing discipline.                                                                                                                                    |

**Default** BC and BE are assigned suitable values proportional to the CIR and PIR respectively, and are larger than the MTU. The PIR defaults to the CIR. The Preference defaults to 7 and the queue-length defaults to 1000 (if the class is a leaf). If the keyword `<default>` is used then the default RED curve is applied.



**Mode** Traffic-Control Policy for an HTB policy.

**Usage** If there is already a class in the same level that has the specified name, the command will replace the configuration of the existing class if it does not have any sub-classes.

If a sub-class policy is specified, this command uses the Traffic-Control Class mode to apply it.

**Examples** To configure a leaf class, use the commands:

```
awplus#configure terminal
awplus (config) #traffic-control
awplus (config-tc) #policy p01 htb
awplus (config-tc-policy) #class c01 cir 100mbit pir 150mbit
```

To configure a class with a sub-sub-class as the leaf class, use the commands:

```
awplus#configure terminal
awplus (config) #traffic-control
awplus (config-tc) #policy p01 htb
awplus (config-tc-policy) #class c01 cir 100mbit pir 150mbit
sub-class-policy htb

awplus (config-tc-class) #sub-class s01 cir 10mbit sub-sub-class
policy htb

awplus (config-tc-subclass) #sub-sub-class ss01 cir 5mbit
queue-length 200 red-curve ss01-red
```

To enter Traffic-Control Class mode for an existing class, use the commands:

```
awplus#configure terminal
awplus (config) #traffic-control
awplus (config-tc) #policy p01
awplus (config-tc-policy) #class c01
awplus (config-tc-class) #
```

To delete an existing class, use the commands:

```
awplus#configure terminal
awplus (config) #traffic-control
awplus (config-tc) #policy p01
awplus (config-tc-policy) #no class c01
```

**Related  
Commands** [policy \(traffic-control\)](#)  
[sub-class \(htb\)](#)  
[traffic-control](#)

# class (priority)

**Overview** Use this command to configure a priority queue class within a traffic control policy.

Use the **no** variant of this command to delete an existing priority class under a current policy.

**Syntax** `class <class-name> [priority-level <0-15>] [max <max-rate>]  
[queue-length <2-65536>] [set-dscp <dscp-value>] [red-curve  
<red-curve-name>]`

`class <class-name> [priority-level <0-15>] sub-class-policy  
{priority|wrr|htb}`

`no class <class-name>`

| Parameter                                     | Description                                                                                                                                                                                                   |
|-----------------------------------------------|---------------------------------------------------------------------------------------------------------------------------------------------------------------------------------------------------------------|
| <code>&lt;class-name&gt;</code>               | Name of the class.                                                                                                                                                                                            |
| <code>priority-level &lt;0-15&gt;</code>      | Set the priority level (15 is the highest). This parameter is compulsory when creating a new class. When editing an existing class, this parameter is optional.                                               |
| <code>max &lt;max-rate&gt;</code>             | Set the maximum traffic rate of the queue (in kbit/mbit/gbit per second, 1kbit-100gbit).                                                                                                                      |
| <code>queue-length &lt;2-65535&gt;</code>     | Set the maximum queue length in packets (only available on leaf queues when specifying sub-class policy).                                                                                                     |
| <code>set-dscp &lt;dscp-value&gt;</code>      | Set the DSCP value to apply to the packets (only available on leaf queues when specifying sub-class policy).                                                                                                  |
| <code>red-curve &lt;red-curve-name&gt;</code> | Apply a random early discard template with the class (only available on leaf queues when specifying class policy). If the keyword <code>&lt;default&gt;</code> is used then the default RED curve is applied. |
| <code>sub-class-policy</code>                 | Create a sub-class within the policy.                                                                                                                                                                         |
| <code>priority</code>                         | Sub-classes use the Priority Queue scheduling algorithm.                                                                                                                                                      |
| <code>wrr</code>                              | Sub-classes use the Weighted Round Robin scheduling algorithm.                                                                                                                                                |
| <code>htb</code>                              | Sub-classes use the Hierarchy Token Bucket scheduling algorithm.                                                                                                                                              |

**Default** No priority class is applied. If the keyword `<default>` is used then the default RED curve is applied.

**Mode** Traffic Control Policy for a priority policy.

**Usage** If there is already a class in the same level with the specified name, the command will replace the configuration of the existing class if it does not have any sub-classes.

If a sub-class policy is specified, this command uses the Traffic-Control Class mode to apply it.

**Examples** To configure a leaf class, use the commands:

```
awplus#configure terminal
awplus (config) #traffic-control
awplus (config-tc) #policy p01 priority
awplus (config-tc-policy) #class c01 priority-level 5
```

To configure a class with a sub-sub-class as the leaf class, use the commands:

```
awplus#configure terminal
awplus (config) #traffic-control
awplus (config-tc) #policy p01 priority
awplus (config-tc-policy) #class c01 priority-level 5
sub-class-policy priority
awplus (config-tc-class) #sub-class s01 priority-level 7
sub-sub-class-policy priority
awplus (config-tc-subclass) #sub-sub-class ss01 priority-level 3
max 5mbit queue-length 200 red-curve ss01-red
```

To enter Traffic-Control Class mode for an existing class, use the commands:

```
awplus#configure terminal
awplus (config) #traffic-control
awplus (config-tc) #policy p01
awplus (config-tc-policy) #class c01
awplus (config-tc-class) #
```

To delete an existing policy class, use the commands:

```
awplus#configure terminal
awplus (config) #traffic-control
awplus (config-tc) #policy p01
awplus (config-tc-policy) #no class c01
```

**Related  
Commands**

- [policy \(traffic-control\)](#)
- [sub-class \(htb\)](#)
- [sub-class \(wrr\)](#)
- [traffic-control](#)

# class (wrr)

**Overview** Use this command to configure a Weighted Round-Robin (WRR) class within a traffic control policy.

Use the **no** variant of this command to delete an existing class under a current policy.

**Syntax** `class <class-name> [weight <1-100>] [queue-length <2-65536>]  
[set-dscp <dscp-value>] [red-curve <red-curve-name>]  
class <class-name> [weight <1-100>] sub-class-policy wrr  
no class <class-name>`

| Parameter                                     | Description                                                                                                                                                                                                                                                                   |
|-----------------------------------------------|-------------------------------------------------------------------------------------------------------------------------------------------------------------------------------------------------------------------------------------------------------------------------------|
| <code>&lt;class-name&gt;</code>               | Name of the class.                                                                                                                                                                                                                                                            |
| <code>weight &lt;1-100&gt;</code>             | Set the weight. The relative weight is the available bandwidth divided between sibling WRR classes according to the ratio of their configured weights.<br>This parameter is compulsory when creating a new class. When editing an existing class, this parameter is optional. |
| <code>queue-length &lt;2-65536&gt;</code>     | Set the maximum queue length in packets.                                                                                                                                                                                                                                      |
| <code>set-dscp &lt;dscp-value&gt;</code>      | Set the DSCP value to apply to packets.                                                                                                                                                                                                                                       |
| <code>red-curve &lt;red-curve-name&gt;</code> | Apply a random early discard template with the class (only available on leaf queues when specifying class policy). If the keyword <code>&lt;default&gt;</code> is used then the default RED curve is applied.                                                                 |
| <code>sub-class-policy</code>                 | Create a sub-class within the policy.                                                                                                                                                                                                                                         |
| <code>wrr</code>                              | Sub-classes use the Weighted Round Robin queueing algorithm.                                                                                                                                                                                                                  |

**Default** A weighted round-robin class has no DSCP value or sub-class policy. The queue length is 1000 by default. If the keyword `<default>` is used then the default RED curve is applied.

**Mode** Traffic-Control Policy for a WRR policy.

**Usage** If there is already a class in the same level with the specified name, the command will replace the configuration of the existing class if it does not have any sub-classes.

If a sub-class policy is specified, this command uses the Traffic-Control Class mode to apply it.

**Examples** To configure a leaf class, use the commands:

```
awplus#configure terminal
awplus (config) #traffic-control
awplus (config-tc) #policy p01 wrr
awplus (config-tc-policy) #class c01 weight 50
```

To configure a class with a sub-sub-class as the leaf class, use the commands:

```
awplus#configure terminal
awplus (config) #traffic-control
awplus (config-tc) #policy p01 wrr
awplus (config-tc-policy) #class c01 weight 50 sub-class-policy
wrr
awplus (config-tc-class) #sub-class s01 weight 30 sub-sub-class-
policy wrr
awplus (config-tc-subclass) #sub-sub-class ss01 weight 5
queue-length 200 red-curve ss01-red
```

To enter Traffic-Control Class mode for an existing class, use the commands:

```
awplus#configure terminal
awplus (config) #traffic-control
awplus (config-tc) #policy p01
awplus (config-tc-policy) #class c01
awplus (config-tc-class) #
```

To delete an existing class, use the commands:

```
awplus#configure terminal
awplus (config) #traffic-control
awplus (config-tc) #policy p01
awplus (config-tc-policy) #no class c01
```

**Related  
Commands** [traffic-control](#)  
[policy \(traffic-control\)](#)  
[sub-class \(wrr\)](#)

# debug traffic-control

**Overview** Use this command to enable traffic-control debugging. This will cause additional detailed debugging information to be logged and available using the show debugging traffic-control.

Use the **no** variant of this command to disable traffic-control debugging.

**Syntax** debug traffic-control  
no debug traffic-control

**Default** Disabled

**Mode** Privileged Exec

**Examples** To enable traffic control debugging, use the commands:

```
awplus#debug traffic-control
```

To disable traffic control debugging, use the commands:

```
awplus#no debug traffic-control
```

**Related Commands** traffic-control  
show debugging traffic-control

# interface (traffic-control)

**Overview** Use this command to configure interface specific parameters for traffic control.

**Syntax** `interface <interface-name> {overhead  
[<overhead-bytes>|ethernet]|virtual-bandwidth  
<bandwidth>|system-bandwidth <system-percentage>}`

| Parameter           | Description                                                                                                                                                   |
|---------------------|---------------------------------------------------------------------------------------------------------------------------------------------------------------|
| <interface-name>    | Name of interface to configure                                                                                                                                |
| overhead            | Set overhead to add to each packet when calculating the packet size                                                                                           |
| <overhead-bytes>    | Number of bytes to add to the packet for packet size calculations. The range is from 0 to 512 and the default is 0.                                           |
| ethernet            | Setting the overhead to 'ethernet' adds 24 bytes to the packet to account for preamble + CRC + inter-frame gap.                                               |
| virtual-bandwidth   | Specify the virtual-bandwidth of the interface. This is the maximum amount of traffic that traffic control will allow to be sent via the interface..          |
| <bandwidth>         | Value for the virtual bandwidth in kbit, mbit or gbits. For example 5mbit.                                                                                    |
| system-bandwidth    | Specify the percentage of the interface bandwidth to reserve for system traffic. The default when a traffic control policy is applied to the interface is 5%. |
| <system-percentage> | Percentage of the bandwidth to reserve for system traffic in the range from 1 to 99.                                                                          |

**Default** The default overhead is 0, the default bandwidth is the interface speed if it can be read. It is recommended to always set the virtual bandwidth when using traffic control. The system bandwidth default is 5%.

**Mode** Traffic-Control

**Usage** This command allows configuring traffic control parameters specific to the traffic egress interface.

**Examples** To rate limit eth1 to 10mbit while taking into account the ethernet framing overhead and reserving only 1% of the bandwidth for system traffic, use the commands:

```
awplus#configure terminal
awplus(config)#traffic-control
awplus(config-tc)#interface eth1 overhead ethernet
virtual-bandwidth 10mbit system-bandwidth 1
```

**Related Commands** [show running-config traffic-control](#)  
[show traffic-control interface](#)

# I3-filtering enable

**Overview** Use this command to enable traffic control for bridged traffic on a bridge interface.

Use the **no** variant of this command to disable traffic control for bridged traffic on a bridge interface.

**Syntax** l3-filtering enable  
no l3-filtering enable

**Default** Traffic control is disabled by default for bridged traffic.

**Mode** Interface mode for a bridge interface

**Usage** We do not recommend shaping bridged traffic on firewalls that are running Unified Threat Management (UTM) features, because both Traffic Control and UTM require significant CPU resources.

**Example** To enable traffic control for bridged traffic on br1, use the commands:

```
awplus# configure terminal
awplus(config)# interface br1
awplus(config-if)# l3-filtering enable
```

**Related  
Commands** [traffic-control](#)

**Command  
changes** Version 5.4.7-0.1: command added. Previously, traffic control was enabled by default on all bridge interfaces.



# move rule (traffic-control)

**Overview** Use this command to change the identification of an existing traffic control rule.

**Syntax** `move rule [<1-65535> to <1-65535>]`

| Parameter | Description                                         |
|-----------|-----------------------------------------------------|
| <1-65535> | Range of the rule ID to move from                   |
| <1-65535> | Range of the destination ID for the rule to move to |

**Default** None

**Mode** Traffic-Control

**Example** To change rule ID 10 to rule ID 25, use the commands:

```
awplus#configure terminal
awplus(config)#traffic-control
awplus(config-tc)#move rule 10 to 25
```

**Related Commands**

- [rule \(traffic-control\)](#)
- [traffic-control](#)
- [show traffic-control](#)
- [show traffic-control rule](#)
- [show traffic-control rule config-check](#)

# policy (traffic-control)

**Overview** Use this command to configure a traffic control policy, that can then be used with rules that have been created.

Use the **no** variant of this command to delete an existing policy.

**Syntax** `policy <policy-name> [priority|wrr|htb]`  
`no policy <policy-name>`

| Parameter                        | Description                      |
|----------------------------------|----------------------------------|
| <code>&lt;policy_name&gt;</code> | The name of the policy           |
| <code>priority</code>            | Use Priority Queueing (PQ)       |
| <code>wrr</code>                 | Use Weighted Round Robin (WRR)   |
| <code>htb</code>                 | Use Hierarchy Token Bucket (HTB) |

**Default** No policies are configured

**Mode** Traffic-Control

**Usage** A policy specifies a top-level queueing discipline which determines the type of classes that can be configured under the policy. This command uses the Traffic-Control Policy mode.

**Examples** To configure a policy, use the commands:

```
awplus#configure terminal
awplus(config)#traffic-control
awplus(config-tc)#policy p01 htb
awplus(config-tc-policy)#
```

To delete an existing policy, use the commands:

```
awplus#configure terminal
awplus(config)#traffic-control
awplus(config-tc)#no policy p01 htb
```

**Related Commands**

- [class \(htb\)](#)
- [class \(priority\)](#)
- [class \(wrr\)](#)
- [rule \(traffic-control\)](#)
- [traffic-control](#)
- [sub-class \(htb\)](#)

sub-class (priority)

sub-class (wrr)

sub-sub-class (htb)

sub-sub-class (priority)

sub-sub-class (wrr)

# red-curve

**Overview** Use this command to allow configuration of a RED (Random Early Discard) curve template.

Use the **no** variant of this command to set the RED curve back to the default.

**Syntax** `red-curve <red-curve-name> [limit <4-127>] [avpkt <64-1518>]  
[min <3-126>] [max <4-127>] [probability <1-100>]  
[ecn [ecn-drop]]  
no red-curve [<red-curve-name>]`

| Parameter                              | Description                                                                                                                                                                                                                                          |
|----------------------------------------|------------------------------------------------------------------------------------------------------------------------------------------------------------------------------------------------------------------------------------------------------|
| <code>&lt;red-curve-name&gt;</code>    | The RED curve name.                                                                                                                                                                                                                                  |
| <code>limit &lt;4-127&gt;</code>       | The hard queue length limit (in packets) for the RED curve. Once the queue length reaches the limit, all packets are dropped.                                                                                                                        |
| <code>avpkt &lt;64-1518&gt;</code>     | The average packet size to use for queue size calculations in bytes.                                                                                                                                                                                 |
| <code>min &lt;3-126&gt;</code>         | The minimum queue length for random early discard (in packets). Between <code>&lt;min&gt;</code> and <code>&lt;max&gt;</code> the drop probability will increase linearly.                                                                           |
| <code>max &lt;4-127&gt;</code>         | The maximum queue length where packets are probabilistically dropped. At <code>&lt;max&gt;</code> the drop probability equals <code>&lt;probability&gt;</code> . Beyond <code>&lt;max&gt;</code> the drop or marking probability is 100%.            |
| <code>probability &lt;1-100&gt;</code> | The probability of a packet being dropped when queue-length reaches <code>&lt;max&gt;</code> . The drop probability increases linearly from 0 to <code>&lt;probability&gt;</code> in between <code>&lt;min&gt;</code> and <code>&lt;max&gt;</code> . |
| <code>ecn</code>                       | Use explicit congestion notification marking instead of dropping the packet.                                                                                                                                                                         |
| <code>ecn-drop</code>                  | When average queue size exceeds <code>&lt;max&gt;</code> drop packets instead of marking.                                                                                                                                                            |

**Default** The default RED curve is **red-curve default limit 127 avpkt 576B min 10 max 32 prob 2**.

**Mode** Traffic-control

**Usage** The RED curve template can later be applied to a traffic control class, sub-class, or sub-sub-class.

**Example** To configure a RED curve with ECN dropping and the default curve shape, use the commands:

```
awplus# configure terminal
awplus(config)# traffic-control
awplus(config-tc)# red-curve red-ecn ecn
```

To configure an aggressive RED curve, use the commands:

```
awplus# configure terminal
awplus(config)# traffic-control
awplus(config-tc)# red-curve aggressive min 5 max 50
probability 70
```

**Related  
Commands**

- class (htb)
- class (priority)
- class (wrr)
- show traffic-control policy
- show running-config traffic-control
- show traffic-control red-curve
- sub-class (htb)
- sub-class (priority)
- sub-class (wrr)
- sub-sub-class (htb)
- sub-sub-class (priority)
- sub-sub-class (wrr)

# rule (traffic-control)

**Overview** Use this command to create a traffic-control rule.

Use the **no** variant of this command to remove a traffic-control rule

**Syntax** `rule [<1-65535>] match <application> from <source-entity> to <destination-entity> policy <policy>`  
`no rule [<1-65535>]`

| Parameter            | Description                                                                                                                                                                                                                                                                                                                                                    |
|----------------------|----------------------------------------------------------------------------------------------------------------------------------------------------------------------------------------------------------------------------------------------------------------------------------------------------------------------------------------------------------------|
| <1-65535>            | The rule ID is an integer in the range from 1 to 65535. If you do not designate a rule ID, one will be automatically generated and it will be greater than the current highest rule ID. Lower IDs have higher priority.                                                                                                                                        |
| match                | Application traffic to match                                                                                                                                                                                                                                                                                                                                   |
| <application>        | Application name                                                                                                                                                                                                                                                                                                                                               |
| from                 | Set the source of the entity                                                                                                                                                                                                                                                                                                                                   |
| <source_entity>      | Source entity name. Entities represent logical grouping of subnets, hosts or interfaces.                                                                                                                                                                                                                                                                       |
| to                   | Set the destination of the entity                                                                                                                                                                                                                                                                                                                              |
| <destination_entity> | Source entity name. Entities represent logical grouping of subnets, hosts or interfaces.                                                                                                                                                                                                                                                                       |
| policy               | Policy to apply to matched traffic                                                                                                                                                                                                                                                                                                                             |
| <policy>             | Traffic control policy. This consists of a top-level policy name followed by the name of a class within that policy, and sub-class (of the class) and a sub-sub-class if applicable. Examples are:<br>p01.c03<br>p01.c03.sc02<br>p01.c03.scc02.ssc01<br>P01 is the policy name, c03 is the class name, sc02 is the sub-class, and ssc01 is the sub-sub-class.. |

**Default** No rules

**Mode** Traffic-Control

**Usage** Rules are used to apply traffic-control policies to a type of traffic. When traffic control is enabled and no rules are added, a default traffic-control policy is installed on all supported interfaces.

If the application, source entity or destination entity specified in the rule is not configured correctly, the rule is not valid and is not installed.

You can change the rule order by using the `move rule (traffic-control)` command.

Rules are applied to destination interfaces in the order of their ID (lower IDs are applied first). If traffic matches a rule, then the rest are ignored. If traffic does not match any rule, then it is classified to the default class.

A rule can specify the system class as the policy. System traffic is high priority traffic that is allocated a fixed amount of bandwidth on an interface. Use the interface (traffic-control) command to configure system bandwidth on an interface.

**Examples** To configure a rule, use the commands:

```
awplus#configure terminal
awplus(config)#traffic-control
awplus(config-tc)#rule 10 match ftp from wan to private policy
p01.c02.sc03
```

To delete a rule, use the commands:

```
awplus#configure terminal
awplus(config)#traffic-control
awplus(config-tc)#no rule 10
```

**Related  
Commands**

[interface \(traffic-control\)](#)  
[move rule \(traffic-control\)](#)  
[policy \(traffic-control\)](#)  
[traffic-control](#)  
[show running-config traffic-control](#)  
[show traffic-control rule](#)

# show debugging traffic-control

**Overview** Use this command to display the status of traffic control debugging

**Syntax** `show debugging traffic-control`

**Default** None

**Mode** Privileged Exec

**Example** To show if traffic-control debugging is on or off, run the command:

```
awplus#show debugging traffic-control
```

**Output** Figure 40-1: Example output from **show debugging traffic-control**

```
awplus#show debugging traffic-control
Traffic-control Debugging Status: off
```

**Related Commands** [debug traffic-control](#)  
[show debugging](#)



# show running-config traffic-control

**Overview** Use this command to display the current traffic control configuration.

**Syntax** `show running-config traffic-control`

**Default** None

**Mode** Privileged Exec

**Example** To show the traffic control configuration section of the running configuration, use the command:

```
awplus#show running-config traffic-control
```

**Output** Figure 40-2: Example output from **show running-config traffic-control**

```
awplus#show running-config traffic-control
traffic-control
policy A wrr
 class B5001 weight 30
 class B5002 weight 60
policy P priority
 class P10 priority-level 10 max 5mbit
 class P3 priority-level 3 max 8mbit sub-class-policy htb
 sub-class H cir 3mbit bc 100000
 sub-class I cir 5mbit bc 100000
 class P2 priority-level 2
policy token-bucket htb
 class A cir 5mbit pir 6mbit preference 2
 class B cir 2mbit pir 4mbit bc 100000 be 100000 preference 3 sub-class-policy htb
 sub-class C cir 1mbit pir 4mbit bc 50000
 sub-class D cir 1mbit pir 4mbit bc 50000 sub-sub-class-policy htb
 sub-sub-class E cir 500kbit pir 4mbit bc 50000 set-dscp af23
 sub-sub-class F cir 500kbit pir 4mbit bc 50000 set-dscp af31
rule 10 match udp-5001 from ipv6.vlan3 to ipv6.eth2 policy A.B5001
rule 20 match udp-5002 from ipv6.vlan3 to ipv6.eth2 policy A.B5002
rule 30 match udp-5001 from main.vlan to main.wan policy A.B5001
rule 40 match udp-5002 from main.vlan to main.wan policy A.B5002
rule 50 match udp-5002 from main.vlan to main.eth1 policy A.B5002
interface eth2 virtual-bandwidth 2mbit overhead ethernet
traffic-control enable
```

**Related Commands**

- [interface \(traffic-control\)](#)
- [show running-config](#)
- [show traffic-control counters](#)
- [show traffic-control interface](#)
- [show traffic-control policy](#)
- [show traffic-control rule](#)
- [show traffic-control rule config-check](#)

## traffic-control

# show traffic-control counters

**Overview** Use this command to display counters related to traffic control. This command displays counters for the number of packets sent, queued or dropped by each traffic control class. The information is shown by each interface. There is an overall counter for the policy, and counters for each leaf class in the policy.

If no interface name is specified then information for all interfaces with traffic control policies applied is displayed.

**Syntax** `show traffic-control counters [<interface-name>]`

| Parameter                           | Description                                           |
|-------------------------------------|-------------------------------------------------------|
| <code>&lt;interface-name&gt;</code> | Name of Interface to display traffic control counters |

**Default** None

**Mode** Privileged Exec

**Examples** To show the traffic control counters for all interfaces, use the commands:

```
awplus#show traffic-control counters
```

Figure 40-3: Example output from **show traffic-control counters**

```
awplus#show traffic-control counters
Traffic Control Counters
Interface eth1:
Class Counter Bytes Packets

A Sent 0 0
 Currently Queued 0 0
 Dropped 0 0
A.B5001 Sent 0 0
 Currently Queued 0 0
 Dropped 0 0
A.B5002 Sent 0 0
 Currently Queued 0 0
 Dropped 0 0
A.default Sent 0 0
 Currently Queued 0 0
 Dropped 0 0
system Sent 0 0
 Currently Queued 0 0
 Dropped 0 0
```

| Interface eth2: |                  |          |         |
|-----------------|------------------|----------|---------|
| Class           | Counter          | Bytes    | Packets |
| A               | Sent             | 58681224 | 232862  |
|                 | Currently Queued | 0        | 383     |
|                 | Dropped          |          | 1039845 |
| A.B5001         | Sent             | 10671444 | 42347   |
|                 | Currently Queued | 32004    | 128     |
|                 | Dropped          |          | 164954  |
| A.B5002         | Sent             | 17661924 | 70087   |
|                 | Currently Queued | 32004    | 127     |
|                 | Dropped          |          | 123470  |
| A.default       | Sent             | 30348360 | 120430  |
|                 | Currently Queued | 32004    | 128     |
|                 | Dropped          |          | 751421  |
| system          | Sent             | 42       | 1       |
|                 | Currently Queued | 0        | 0       |
|                 | Dropped          |          | 0       |

**Related Commands** [show running-config traffic-control](#)

# show traffic-control interface

**Overview** Use this command to display information about interfaces known to traffic control, such as the applied policy, the virtual-bandwidth configured on the interface, the bandwidth reserved for system traffic and the overhead applied to the packet size calculations. If no interface name is specified, information is shown for all interfaces known to traffic control.

**Syntax** `show traffic-control interface [<interface-name>]`

| Parameter                           | Description                              |
|-------------------------------------|------------------------------------------|
| <code>&lt;interface-name&gt;</code> | Name of interface to display information |

**Default** None

**Mode** Privileged Exec

**Examples** To show traffic control information for all interfaces, use the command:

```
awplus#show traffic-control interface
```

**Output** Figure 40-4: Example output from **show traffic-control interface**

```
awplus#show traffic-control interface
Traffic Control Interface Information

eth1:

Policy: A
Virtual bandwidth: Not set (optional)
System bandwidth: 5%
Packet overhead: 0 Bytes

eth2:

Policy: A
Virtual bandwidth: 2000 kbit
System bandwidth: 5%
Packet overhead 24 Bytes (Ethernet transport layer)

vlan1:

Policy: Default policy
Virtual bandwidth: Not set (optional)
Packet overhead: 0 Bytes
```

```
vlan10:
Policy: Default policy
Virtual bandwidth: Not set (optional)
Packet overhead: 0 Bytes

vlan3:
Policy: Default policy
Virtual bandwidth: Not set (optional)
Packet overhead: 0 Bytes

vlan4:
Policy: Default policy
Virtual bandwidth: Not set (optional)
Packet overhead: 0 Bytes

vlan666:
Policy: Default policy
Virtual bandwidth: Not set (optional)
Packet overhead: 0 Bytes
```

**Related Commands** [interface \(traffic-control\)](#)  
[show running-config traffic-control](#)

# show traffic-control policy

**Overview** Use this command to show information about the configured traffic control policies and classes. This command shows the configured traffic control policies and the interfaces that they are applied to. Only non-default configuration parameters are shown.

If no policy name is given, all configured policies are displayed.

**Syntax** `show traffic-control policy [<policy-name>]`

| Parameter     | Description               |
|---------------|---------------------------|
| <policy-name> | Name of policy to display |

**Default** None

**Mode** Privileged Exec

**Examples** To show all traffic control policies, use the command:

```
awplus#show traffic-control policy
```

**Output** Figure 40-5: Example output from **show traffic-control policy**

```
awplus#show traffic-control policy
Traffic Control Policies:
Policy A:
 Type: wrd
 Applied interfaces: eth1 eth2
 Classes:
 Class B5001:
 Weight: 30
 Class B5002:
 Weight: 60
 Red curve: default
Policy P:
 Type: priority
 Applied interfaces: None
 Classes:
 Class P10:
 Priority: 10
 Peak rate (PIR): 5000kbit
 Class P3:
 Priority: 3
 Peak rate (PIR): 8000kbit
 Sub-queue type: htb
 Red curve TCP_session_1
```

```
Class H:
 Committed rate (CIR): 3000kbit
 Burst (Bc): 100000B
Class I:
 Committed rate (CIR): 5000kbit
 Burst (Bc): 100000B
Class P2:
 Priority: 2
 Red curve: TCP_session_2
Policy token-bucket:
 Type: htb
 Applied interfaces: None
Classes:
 Class A:
 Committed rate (CIR): 5000kbit
 Peak rate (PIR): 6000kbit
 Preference: 2
 Class B:
 Committed rate (CIR): 2000kbit
 Peak rate (PIR): 4000kbit
 Burst (Bc): 100000B
 Excess Burst (Be): 100000B
 Preference: 3
 Sub-queue type: htb
 Class C:
 Committed rate (CIR): 2000kbit
 Peak rate (PIR): 4000kbit
 Burst (BC): 50000B
 Class D:
 Committed rate (CIR): 1000kbit
 Peak rate (PIR): 4000kbit
 Burst (Bc): 50000B
 Sub-queue type: htb
 Class E:
 Committed rate (CIR): 500kbit
 Peak rate (PIR): 4000kbit
 Burst (Bc): 50000B
 Set DSCP: af23
 Class F:
 Committed rate (CIR): 500kbit
 Peak rate (PIR): 4000kbit
 Burst (Bc): 50000B
 Set DSCP: af31
```

**Related Commands** [show running-config](#)  
[show running-config traffic-control](#)



# show traffic-control red-curve

**Overview** Use this command to show configured RED curve templates.

**Syntax** show traffic-control red-curve <red-curve-name>

| Parameter        | Description                                                                                                             |
|------------------|-------------------------------------------------------------------------------------------------------------------------|
| <red-curve-name> | The name of the RED curve. The default RED curve is <b>red-curve default limit 127 avpkt 576B min 10 max 32 prob 2.</b> |

**Default** None

**Mode** Privileged Exec

**Usage** If you have not configured some parameters, default values will display. If no RED curve name is given, all configured RED curves are shown.

**Example** To show all RED curves, use the command:

```
awplus# show traffic-control red-curve
```

To show a specified red curve called "TCP\_session\_1", use the command:

```
awplus# show traffic-control red-curve TCP_session_1
```

**Output** Figure 40-6: Example output from **show traffic-control red-curve**

```
awplus#show traffic-control red-curve
Traffic Control RED Curves:

RED curve default:
 Average packet size: 576 bytes
 Minimum: 10 packets
 Maximum: 32 packets
 Limit: 127 packets
 Drop probability: 2%
 ECN marking: disabled

RED curve TCP_session_1:
 Average packet size: 576 bytes
 Minimum: 20 packets
 Maximum: 60 packets
 Limit: 127 packets
 Drop probability: 20%
 ECN marking: disabled
```

Figure 40-7: Example output from **show traffic-control red-curve TCP\_session\_1**

```
awplus#show traffic-control red-curve TCP_session_1
Traffic Control RED Curves
RED curve TCP_session_1:
Average packet size: 576 bytes
Minimum: 20 packets
Maximum: 60 packets
Limit: 127 packets
Drop probability: 20%
ECN marking: disabled
```

**Related Commands**

- [red-curve](#)
- [show running-config](#)
- [show running-config traffic-control](#)
- [show traffic-control policy](#)

# show traffic-control rule config-check

**Overview** Use this command to show information about traffic control rule validity.

**Syntax** `show traffic-control rule config-check`

**Default** None

**Mode** Privileged Exec

**Usage** An asterisk is printed before each rule that is invalid. To help determine why the rule is invalid, the `show traffic-control rule config-check` command will print the reasons why the rule is invalid. Information is only shown for invalid rules. If all rules are valid, a message will be printed showing all rules are valid.

**Example** To check if configured rules are valid, use the commands:

```
awplus#show traffic-control rule config-check
```

**Output** Figure 40-8: Example output from **show traffic-control rule config-check**

```
awplus#show traffic-control rule config-check

Rule 30:
 "From" entity does not exist
 "To" entity does not exist
 Policy doesn't exist or is not leaf
```

**Related Commands**

- [move rule \(traffic-control\)](#)
- [rule \(traffic-control\)](#)
- [show traffic-control rule](#)
- [show running-config traffic-control](#)

# show traffic-control rule

**Overview** Use this command to show specific rules or a complete list of rules configured for traffic control.

**Syntax** `show traffic-control rule [<1-65535>]`

| Parameter | Description                                                                           |
|-----------|---------------------------------------------------------------------------------------|
| <1-65535> | The ID of the rule you want to display. If no ID is entered, all rules are displayed. |

**Default** None

**Mode** Privileged Exec

**Usage** An asterisk will be printed at the start of a row if the rule is invalid. The rules are shown in a table showing the rule ID, the application, source and destination that the rule matches on and the policy and class that the matching traffic will be sent to.

**Examples** To show a list of all traffic control rules configured, use the command:

```
awplus#show traffic-control rule
```

To show traffic control rule 10 configured, use the command:

```
awplus#show traffic-control rule 10
```

**Output** Figure 40-9: Example output from **show traffic-control rule**

```
awplus#show traffic-control rule

[* - Rule is not valid - see "show traffic-control rule config-check"]
 ID APP From To Policy

 10 udp-5001 ipv6.vlan3 ipv6.eth2 A.B5001
 20 udp-5002 ipv6.vlan3 ipv6.eth2 A.B5002
* 30 aserf asdf fasdf sadf.asdf
```

**Related Commands**

- [move rule \(traffic-control\)](#)
- [rule \(traffic-control\)](#)
- [show running-config traffic-control](#)
- [show traffic-control](#)
- [show traffic-control rule config-check](#)

# show traffic-control

**Overview** Use this command to display a brief overview of the status of the traffic control information on the router.

**Syntax** `show traffic-control`

**Mode** Privileged Exec

**Usage** This command shows if traffic control is enabled, how many rules are configured and how many interfaces have a virtual bandwidth applied.

**Example** To show an overview of the status of the traffic control information, use the commands:

```
awplus# show traffic-control
```

**Output** Figure 40-10: Example output from **show traffic-control**

```
awplus#show traffic-control
Traffic control is enabled
Policy configured on 5 interfaces
2 rules configured (2 valid rules)
Virtual-bandwidth configured on 1 interfaces
```

**Related Commands** [traffic-control](#)  
[traffic-control enable](#)

# sub-class (htb)

**Overview** Use this command to configure a hierarchy token bucket (HTB) sub-class within an existing class.

Use the **no** variant of this command to delete an existing sub-class under the current class.

**Syntax**

```
sub-class <class-name> [cir <committed-rate>] [pir <peak-rate>]
[bc <1-100000000>] [be <1-100000000>] [preference <0-7>]
[queue-length <2-65536>] [set-dscp <dscp-value>] [red-curve
<red-curve-name>]

sub-class <class-name> [cir <committed-rate>] [pir <peak-rate>]
[bc <1-100000000>] [be <1-100000000>] [preference <0-7>]
sub-sub-class-policy htb

no sub-class <class-name>
```

| Parameter                  | Description                                                                                                                                                                                                                                |
|----------------------------|--------------------------------------------------------------------------------------------------------------------------------------------------------------------------------------------------------------------------------------------|
| <class-name>               | Name of the class.                                                                                                                                                                                                                         |
| cir <committed-rate>       | Set the Committed Information Rate (CIR) for the queue. Specified in kbit/mbit/gbit per second, 1kbit-100gbit. This parameter is compulsory when creating a new sub-class. When editing an existing sub-class, this parameter is optional. |
| pir <peak-rate>            | Set the Peak Information Rate (PIR) for the queue. This is the rate of the queue under peak conditions. Specified in kbit/mbit/gbit per second, in the range 1kbit-100gbit.                                                                |
| bc <1-100000000>           | Set the Committed Burst size (BC). This is the burst allowed above the CIR, sent at the PIR rate.                                                                                                                                          |
| be <1-100000000>           | Set the Excess Burst size (BE). This is the burst allowed above the PIR, sent at the maximum rate.                                                                                                                                         |
| preference <0-7>           | Set the preference for a class to receive spare bandwidth (highest is 7).                                                                                                                                                                  |
| queue-length <2-65536>     | Set the maximum queue length in packets.                                                                                                                                                                                                   |
| set-dscp <dscp-value>      | Set the DSCP value to apply to the packets.                                                                                                                                                                                                |
| red-curve <red-curve-name> | Apply a random early discard template with the sub-class and enter the name of the red curve template to apply.                                                                                                                            |
| sub-sub-class-policy       | Specify that the sub-class will contain sub-sub-classes.                                                                                                                                                                                   |
| htb                        | Sub-sub-classes will use the Hierarchy Token Bucket (HTB) queueing discipline.                                                                                                                                                             |

**Default** BC and BE are assigned suitable values proportional to the CIR and PIR respectively and are larger than the MTU. PIR defaults to the CIR. Preference defaults to 7 and the queue length default to 1000 if the class is a leaf.

**Mode** Traffic-Control Class for an HTB sub-class policy.

**Usage** If there is already a sub-class in the same level with the specified name, the command will replace the configuration of the existing sub class if it does not have any sub-sub-classes.

If you specify a sub-sub-class policy, this command puts you into sub-class mode so you can specify the sub-sub-class.

**Examples** To configure a leaf sub-class, use the commands:

```
awplus#configure terminal
awplus(config)#traffic-control
awplus(config-tc)#policy p01 htb
awplus(config-tc-policy)#class c01 cir 100mbit pir 150mbit
sub-class-policy htb
wplus(config-tc-class)#sub-class s02 cir 20mbit queue-length
200 red-curve s02-red
```

To enter Traffic-Control Class mode for an existing sub-class, use the commands:

```
awplus#configure terminal
awplus(config)#traffic-control
awplus(config-tc)#policy p01
awplus(config-tc-policy)#class c01
awplus(config-tc-class)#sub-class s01
awplus(config-tc-subclass)#
```

To delete an existing sub-class, use the commands:

```
awplus#configure terminal
awplus(config)#traffic-control
awplus(config-tc)#policy p01
awplus(config-tc-policy)#class c01
awplus(config-tc-class)#no sub-class s01
```

**Related  
Commands**

- [class \(htb\)](#)
- [class \(priority\)](#)
- [policy \(traffic-control\)](#)
- [sub-sub-class \(htb\)](#)
- [traffic-control](#)

# sub-class (priority)

**Overview** Use this command to configure a priority queue sub-class within a class.

Use the **no** variant of this command to delete an existing sub-class under the current class.

**Syntax** `sub-class <class-name> [priority-level <0-15>] [max <max-rate>]  
[queue-length <2-65536>] [set-dscp <dscp_value>] [red-curve  
<red-curve-name>]`

`sub-class <class-name> [priority-level <0-15>]`

`sub-sub-class-policy {priority|wrr|htb}`

`no sub-class <class-name>`

| Parameter                                     | Description                                                                                                                                                             |
|-----------------------------------------------|-------------------------------------------------------------------------------------------------------------------------------------------------------------------------|
| <code>&lt;class-name&gt;</code>               | Name of the class.                                                                                                                                                      |
| <code>priority-level &lt;0-15&gt;</code>      | Set the priority level (15 is the highest). This parameter is compulsory when creating a new sub-class. When editing an existing sub-class, this parameter is optional. |
| <code>max &lt;max-rate&gt;</code>             | Set the maximum traffic rate of the queue (in kbit/mbit/gbit per second, 1kbit-100gbit).                                                                                |
| <code>queue-length &lt;2-65536&gt;</code>     | Set the maximum queue length in packets.                                                                                                                                |
| <code>set-dscp&lt;dscp-value&gt;</code>       | Set the DSCP value to apply to the packets.                                                                                                                             |
| <code>red-curve &lt;red-curve-name&gt;</code> | Apply a random early discard template with the sub class and enter the name of the red curve template to apply.                                                         |
| <code>sub-sub-class-policy</code>             | Create a sub-sub-class for the policy.                                                                                                                                  |
| <code>priority</code>                         | Sub-sub-classes will use the Priority Queue queueing algorithm.                                                                                                         |
| <code>wrr</code>                              | Sub-sub-classes will use the Weighted Round Robin (WRR) queueing algorithm.                                                                                             |
| <code>htb</code>                              | Sub-classes will use the Hierarchy Token Bucket (HTB) queueing algorithm.                                                                                               |

**Default** A priority queue sub class has no max rate, DSCP value or sub-sub class policy. The queue length is 1000 by default if the class is a leaf.

**Mode** Traffic-Control Class for a priority sub-class policy.

**Usage** If there is already a sub-class in the same level with the specified name, the command will replace the configuration of the existing sub class if it does not have any sub-sub classes.

If a sub-sub class policy is specified, this command uses the Traffic-Control Class mode to apply it.



**Examples** To configure a sub-class as the leaf class, use the commands:

```
awplus#configure terminal
awplus(config)#traffic-control
awplus(config-tc)#policy p01 priority
awplus(config-tc-policy)#class c01 priority-level 5
sub-class-policy priority
awplus(config-tc-class)#sub-class s02 priority-level 8 max
50mbit queue-length 200 red-curve ss01-red
```

To enter Traffic-Control Class mode for an existing sub-class, use the commands:

```
awplus#configure terminal
awplus(config)#traffic-control
awplus(config-tc)#policy p01 priority
awplus(config-tc-policy)#class c01
awplus(config-tc-class)#sub-class s01
awplus(config-tc-subclass)#
```

To delete an existing class, use the commands:

```
awplus#configure terminal
awplus(config)#traffic-control
awplus(config-tc)#policy p01
awplus(config-tc-policy)#class c01
awplus(config-tc-class)#no sub-class s01
```

**Related  
Commands**

[class \(priority\)](#)  
[policy \(traffic-control\)](#)  
[sub-sub-class \(htb\)](#)  
[sub-sub-class \(priority\)](#)  
[sub-sub-class \(wrr\)](#)  
[traffic-control](#)

# sub-class (wrr)

**Overview** Use this command to configure a Weighted Round-Robin (WRR) sub-class within a class.

Use the **no** variant of this command to delete an existing sub-class under the current class.

**Syntax** `sub-class <class-name> [weight <1-100>] [queue-length <2-65536>] [set-dscp <dscp-value>] [red-curve <red-curve-name>]`  
`sub-class <class-name> [weight <1-100>] sub-sub-class-policy wrr`  
`no sub-class <class-name>`

| Parameter                                     | Description                                                                                                                                                                                                                                                                        |
|-----------------------------------------------|------------------------------------------------------------------------------------------------------------------------------------------------------------------------------------------------------------------------------------------------------------------------------------|
| <code>&lt;class-name&gt;</code>               | Name of the sub-class.                                                                                                                                                                                                                                                             |
| <code>weight&lt;1-100&gt;</code>              | Set the weight. The relative weight is the available bandwidth divided between sibling WRR classes according to the ratio of their configured weights. This parameter is compulsory when creating a new sub-class. When editing an existing sub-class, this parameter is optional. |
| <code>queue-length&lt;2-65536&gt;</code>      | Set the maximum queue length in packets.                                                                                                                                                                                                                                           |
| <code>set-dscp</code>                         | Set the DSCP value to apply to packets.                                                                                                                                                                                                                                            |
| <code>&lt;dscp-value&gt;</code>               | DSCP value as an integer or lower-case DSCP name.                                                                                                                                                                                                                                  |
| <code>red curve &lt;red-curve-name&gt;</code> | Apply a random early discard template with the sub-class and enter the name of the red curve template to apply.                                                                                                                                                                    |
| <code>sub-sub-class-policy</code>             | Create a sub-sub-class within the policy.                                                                                                                                                                                                                                          |
| <code>wrr</code>                              | Sub sub classes use the Weighted Round Robin queueing discipline.                                                                                                                                                                                                                  |

**Default** A weighted round-robin sub class has no DSCP value or sub-sub-class policy. The queue length is 1000 by default.

**Mode** Traffic-Control Class for a WRR sub-class policy.

**Usage** If there is already a class in the same level with the specified name, the command will replace the configuration of the existing class if it does not have any sub-classes.

If a sub class policy is specified, this command uses the Traffic-Control Class mode to apply it.

**Examples** To configure a sub-class as a leaf class, use the commands:

```
awplus#configure terminal
awplus(config)#traffic-control
awplus(config-tc)#policy p01 wrr
awplus(config-tc-policy)#class c02 weight 30 sub-class-policy
wrr
awplus(config-tc-class)#sub-class s02 weight 40 queue-length
200 red-curve s02-red
```

To enter Traffic-Control Class mode for an existing sub-class, use the commands:

```
awplus#configure terminal
awplus(config)#traffic-control
awplus(config-tc)#policy p01
awplus(config-tc-policy)#class c01
awplus(config-tc-class)#sub-class s01
awplus(config-tc-subclass)#
```

To delete an existing sub-class, use the commands:

```
awplus#configure terminal
awplus(config)#traffic-control
awplus(config-tc)#policy p01
awplus(config-tc-policy)#class c01
awplus(config-tc-class)#no sub-class s01
```

**Related  
Commands**

- [class \(priority\)](#)
- [class \(wrr\)](#)
- [policy \(traffic-control\)](#)
- [traffic-control](#)
- [sub-sub-class \(wrr\)](#)

## sub-sub-class (htb)

**Overview** Use this command to configure a Hierarchy Token Bucket (HTB) sub-sub-class for a sub-class.

Use the **no** variant of this command to delete an existing sub-sub-class from the current sub-class.

**Syntax** `sub-sub-class <class-name> [cir <committed-rate>] [pir <peak-rate>] [bc <1-100000000>] [be <1-100000000>] [preference <0-7>] [queue-length <2-65536>] [set-dscp <dscp-value>] [red-curve <red-curve-name>]`  
`no sub-sub-class <class-name>`

| Parameter                                     | Description                                                                                                                                                                                                                                        |
|-----------------------------------------------|----------------------------------------------------------------------------------------------------------------------------------------------------------------------------------------------------------------------------------------------------|
| <code>&lt;class-name&gt;</code>               | Name of the sub-sub-class.                                                                                                                                                                                                                         |
| <code>cir &lt;committed-rate&gt;</code>       | Set the Committed Information Rate (CIR) for the queue. Specified in kbit/mbit/gbit per second, 1kbit-100gbit. This parameter is compulsory when creating a new sub-sub-class. When editing an existing sub-sub-class, this parameter is optional. |
| <code>pir &lt;peak-rate&gt;</code>            | Set the Peak Information Rate (PIR) for the queue. This is the rate of the queue under peak conditions. Specified in kbit/mbit/gbit per second, in the range 1kbit-100gbit.                                                                        |
| <code>bc &lt;1-100000000&gt;</code>           | Set the Committed Burst size (BC). This is the burst allowed above the CIR, sent at the PIR rate.                                                                                                                                                  |
| <code>be &lt;1-100000000&gt;</code>           | Set the Excess Burst size (BE. This is the burst allowed above the PIR, sent at the maximum rate..                                                                                                                                                 |
| <code>preference &lt;0-7&gt;</code>           | Set the preference for a class to receive spare bandwidth (highest is 7).                                                                                                                                                                          |
| <code>queue-length &lt;2-65536&gt;</code>     | Set the maximum queue length.                                                                                                                                                                                                                      |
| <code>set-dscp &lt;dscp-value&gt;</code>      | Set the DSCP value to apply to the packets.                                                                                                                                                                                                        |
| <code>red-curve &lt;red-curve-name&gt;</code> | Apply a random early discard template with the sub-sub-class and enter the name of the red curve template to apply.                                                                                                                                |

**Default** BC and BE are assigned suitable values proportional to the CIR and PIR respectively and are larger than the MTU. PIR defaults to the CIR. Preference defaults to 7 and Queue length defaults to 1000.

**Mode** Traffic-Control Sub-class for an HTB sub-sub-class policy.

**Usage** If there is already a sub-sub-class in the same level with the specified name, this command will replace the configuration of the existing sub-sub-class.

**Examples** To configure a sub-sub-class, use the commands:

```
awplus#configure terminal
awplus(config)#traffic-control
awplus(config-tc)#policy p01 htb
awplus(config-tc-policy)#class c01 cir 100mbit pir 150mbit
sub-class-policy htb
awplus(config-tc-class)#sub-class s01 cir 10mbit
```

To configure a leaf sub-sub-class with a RED curve, use the commands:

```
awplus#configure terminal
awplus(config)#traffic-control
awplus(config-tc)#policy p01 htb
awplus(config-tc-policy)#class c01 cir 100mbit pir 150mbit
sub-class-policy htb
awplus(config-tc-class)#sub-class s01 cir 10mbit
sub-sub-class-policy htb
awplus(config-tc-subclass)#sub-sub-class ss01 cir 5mbit
queue-length 200 red-curve ss01-red
```

To delete an existing sub-sub-class, use the commands:

```
awplus#configure terminal
awplus(config)#traffic-control
awplus(config-tc)#policy p01
awplus(config-tc-policy)#class c01
awplus(config-tc-class)#sub-class s01
awplus(config-tc-subclass)#no sub-sub-class ss01
```

**Related  
Commands**

- [policy \(traffic-control\)](#)
- [sub-class \(htb\)](#)
- [sub-class \(priority\)](#)
- [traffic-control](#)

# sub-sub-class (priority)

**Overview** Use this command to configure a priority queue sub-sub-class for a sub-class.  
Use the **no** variant of this command to delete an existing sub-sub-class from the current sub-class.

**Syntax** `sub-sub-class <class-name> [priority-level <0-15>] [max <max-rate>] [queue-length <2-65536>] [set-dscp <dscp-value>] [red-curve <red-curve-name>]`  
`no sub-sub-class <class-name>`

| Parameter                                     | Description                                                                                                                                                                     |
|-----------------------------------------------|---------------------------------------------------------------------------------------------------------------------------------------------------------------------------------|
| <code>&lt;class-name&gt;</code>               | Name of the class.                                                                                                                                                              |
| <code>priority-level &lt;0-15&gt;</code>      | Set the priority level (15 is the highest). This parameter is compulsory when creating a new sub-sub-class. When editing an existing sub-sub-class, this parameter is optional. |
| <code>max &lt;max-rate&gt;</code>             | Set the maximum traffic rate of the queue (in kbit/mbit/gbit per second, 1kbit-100gbit).                                                                                        |
| <code>queue-length &lt;2-65536&gt;</code>     | Set the maximum queue length in packets.                                                                                                                                        |
| <code>set-dscp &lt;dscp-value&gt;</code>      | Set the DSCP value to apply to the packets.                                                                                                                                     |
| <code>red-curve &lt;red-curve-name&gt;</code> | Apply a random early discard template with the sub-sub-class and enter the name of the red curve template to apply.                                                             |

**Default** A priority queue sub-sub-class has no max rate or DSCP value. The queue length is 1000.

**Mode** Traffic-Control Sub-class for a priority sub-sub-class policy.

**Usage** If there is already a sub-sub-class in the same level with the specified name, this command will replace the configuration of the existing sub-sub-class.

**Examples** To configure a sub-sub-class, use the commands:

```
awplus#configure terminal
awplus(config)#traffic-control
awplus(config-tc)#policy p01 priority
awplus(config-tc-policy)#class c01 priority-level 5
awplus(config-tc-class)#sub-class s01 priority-level 7
awplus(config-tc-subclass)#sub-sub-class ss01 priority-level 3
```

To configure a sub-sub-class with a RED curve, use the commands:

```
awplus#configure terminal
awplus(config)#traffic-control
awplus(config-tc)#policy p01 priority
awplus(config-tc-policy)#class c01 priority-level 5
sub-class-policy priority
awplus(config-tc-class)#sub-class s01 priority-level 7
sub-sub-class-policy priority
awplus(config-tc-subclass)#sub-sub-class ss01 priority-level 3
max 5mbit queue-length 200 red-curve ss01-red
```

To delete an existing sub-sub-class, use the commands:

```
awplus#configure terminal
awplus(config)#traffic-control
awplus(config-tc)#policy p01
awplus(config-tc-policy)#class c01
awplus(config-tc-class)#sub-class s01
awplus(config-tc-subclass)#no sub-sub-class ss01
```

**Related  
Commands**

- [traffic-control](#)
- [policy \(traffic-control\)](#)
- [sub-class \(priority\)](#)

# sub-sub-class (wrr)

**Overview** Use this command to configure a Weighted Round-Robin (WRR) sub-sub-class within a sub-class.

Use the **no** variant of this command to delete an existing sub-sub-class from the current sub-class.

**Syntax** `sub-sub-class <class-name> [weight <1-100>] [queue-length <2-65536>] [set-dscp <dscp-value>] [red-curve <red-curve-name>]`  
`no sub-sub-class <class-name>`

| Parameter                                     | Description                                                                                                                                                                                                                                                                                |
|-----------------------------------------------|--------------------------------------------------------------------------------------------------------------------------------------------------------------------------------------------------------------------------------------------------------------------------------------------|
| <code>&lt;class-name&gt;</code>               | Name of the sub-class.                                                                                                                                                                                                                                                                     |
| <code>weight &lt;1-100&gt;</code>             | Set the weight. The relative weight is the available bandwidth divided between sibling WRR classes according to the ratio of their configured weights. This parameter is compulsory when creating a new sub-sub-class. When editing an existing sub-sub-class, this parameter is optional. |
| <code>queue-length &lt;2-65536&gt;</code>     | Set the maximum queue length in packets.                                                                                                                                                                                                                                                   |
| <code>set-dscp &lt;dscp-value&gt;</code>      | Set the DSCP value to apply to packets.                                                                                                                                                                                                                                                    |
| <code>red-curve &lt;red-curve-name&gt;</code> | Apply a random early discard template with the sub-sub-class and enter the name of the red curve template to apply.                                                                                                                                                                        |

**Default** A weighted round-robin sub-sub-class has no DSCP value. The queue length is 1000 by default.

**Mode** Traffic-Control Sub-class for a WRR sub-sub-class policy.

**Usage** If there is already a sub-sub-class in the same level with the specified name, this command will replace the configuration of the existing sub-sub-class.

**Examples** To configure a sub-sub-class as a leaf class, use the commands:

```
awplus#configure terminal
awplus(config)#traffic-control
awplus(config-tc)#policy p01 wrr
awplus(config-tc-policy)#class c01 weight 50 sub-class-policy
wrr
awplus(config-tc-class)#sub-class s01 weight 30 sub-sub-class
policy wrr
awplus(config-tc-subclass)#sub-sub-class ss01 weight 5
queue-length 200
```



To configure a sub-sub-class with a RED curve, use the commands:

```
awplus#configure terminal
awplus(config)#traffic-control
awplus(config-tc)#policy p01 wrr
awplus(config-tc-policy)#class c01 weight 50 sub-class-policy
wrr
awplus(config-tc-class)#sub-class s01 weight 30
sub-sub-class-policy wrr
awplus(config-tc-subclass)#sub-sub-class ss01 weight 5
queue-length 200 red-curve ss01-red
```

To delete an existing sub-sub-class, use the commands:

```
awplus#configure terminal
awplus(config)#traffic-control
awplus(config-tc)#policy p01 htb
awplus(config-tc-policy)#class c01
awplus(config-tc-class)#sub-class s01
awplus(config-tc-subclass)#no sub-sub-class ss01
```

**Related  
Commands**

[traffic-control](#)  
[policy \(traffic-control\)](#)  
[sub-class \(priority\)](#)  
[sub-class \(wrr\)](#)

# traffic-control enable

**Overview** Use this command to enable traffic control.  
Use the **no** variant of this command to disable traffic control without losing your existing traffic control configuration.

**Syntax** `traffic-control enable`  
`no traffic-control enable`

**Default** Disabled

**Mode** Traffic-Control

**Usage** When traffic control is enabled and no rules are added, a default queueing discipline is applied to all interfaces that support traffic control. You can use the `policy` command to configure traffic control policies and the `rule (traffic-control)` command to apply the configured policies to the traffic.

**Examples** To enable traffic control, use the commands:

```
awplus#configure terminal
awplus (config) #traffic-control
awplus (config-tc) #traffic-control enable
```

To disable traffic control, use the commands:

```
awplus#configure terminal
awplus (config) #traffic-control
awplus (config-tc) #no traffic-control enable
```

**Related  
Commands** [policy \(traffic-control\)](#)  
[rule \(traffic-control\)](#)  
[traffic-control](#)

# traffic-control

**Overview** Use this command to enter into Traffic-Control configuration mode.  
Use the **no** variant of this command to remove all traffic control configuration.

**Syntax** traffic-control  
no traffic-control

**Default** Disabled

**Mode** Global Configuration

**Usage** This command enters you into Traffic-Control configuration mode.  
In Traffic-Control Configuration mode you can:

- enable or disable traffic control
- create and delete traffic control policies
- create, move and delete rules for traffic control
- set and unset packet overhead, system bandwidth and virtual bandwidth of interfaces

**Examples** To configure traffic-control, use the commands:

```
awplus#configure terminal
awplus(config)#traffic-control
awplus(config-tc)#
```

To remove all traffic control configuration, use the commands:

```
awplus#configure terminal
awplus(config)#no traffic-control
awplus(config)#
```

**Related Commands**

- class (htb)
- class (priority)
- class (wrr)
- debug traffic-control
- interface (traffic-control)
- move rule (traffic-control)
- policy (traffic-control)
- rule (traffic-control)
- traffic-control enable
- show debugging traffic-control

show running-config traffic-control  
show traffic-control  
show traffic-control counters  
show traffic-control interface  
show traffic-control policy  
show traffic-control rule  
show traffic-control rule config-check  
sub-class (htb)  
sub-class (priority)  
sub-class (wrr)  
sub-sub-class (htb)  
sub-sub-class (priority)  
sub-sub-class (wrr)

# 41

# Traffic Shaping Commands (deleted)

## Introduction

**Overview** Traffic Shaping has been replaced with Traffic Control, and Traffic Shaping commands have been deleted in version 5.4.7-0.1. If you are running Traffic Shaping and you want to upgrade to 5.4.7-0.x from 5.4.5-x.x or an earlier version, upgrade to a 5.4.6-x.x version first and then save your configuration. AlliedWare Plus will convert your configuration automatically to a Traffic Control configuration.

For more information about Traffic Control, see the [Traffic Control Feature Overview and Configuration Guide](#)

# 42

# Authentication Commands

## Introduction

**Overview** This chapter provides an alphabetical reference for authentication commands. For more information, see the [AAA and Port Authentication Feature Overview and Configuration Guide](#).

- Command List**
- “[auth critical](#)” on page 1849
  - “[auth host-mode](#)” on page 1850
  - “[auth log](#)” on page 1852
  - “[auth max-supPLICANT](#)” on page 1854
  - “[auth profile \(Global Configuration\)](#)” on page 1856
  - “[auth profile \(Interface Configuration\)](#)” on page 1857
  - “[auth reauthentication](#)” on page 1858
  - “[auth supplicant-ip](#)” on page 1859
  - “[auth supplicant-mac](#)” on page 1861
  - “[auth timeout connect-timeout](#)” on page 1864
  - “[auth timeout quiet-period](#)” on page 1865
  - “[auth timeout reauth-period](#)” on page 1866
  - “[auth timeout server-timeout](#)” on page 1868
  - “[auth-web accounting](#)” on page 1869
  - “[auth-web authentication](#)” on page 1870
  - “[auth-web enable](#)” on page 1871
  - “[auth-web forward](#)” on page 1873
  - “[auth-web idle-timeout enable](#)” on page 1876
  - “[auth-web idle-timeout timeout](#)” on page 1877

- [“auth-web max-auth-fail”](#) on page 1878
- [“auth-web method”](#) on page 1880
- [“auth-web-server dhcp ipaddress”](#) on page 1881
- [“auth-web-server dhcp lease”](#) on page 1882
- [“auth-web-server dhcp-wpad-option”](#) on page 1883
- [“auth-web-server host-name”](#) on page 1884
- [“auth-web-server intercept-port”](#) on page 1885
- [“auth-web-server ipaddress”](#) on page 1886
- [“auth-web-server page language”](#) on page 1887
- [“auth-web-server login-url”](#) on page 1888
- [“auth-web-server page logo”](#) on page 1889
- [“auth-web-server page sub-title”](#) on page 1890
- [“auth-web-server page success-message”](#) on page 1891
- [“auth-web-server page title”](#) on page 1892
- [“auth-web-server page welcome-message”](#) on page 1893
- [“auth-web-server ping-poll enable”](#) on page 1894
- [“auth-web-server ping-poll failcount”](#) on page 1895
- [“auth-web-server ping-poll interval”](#) on page 1896
- [“auth-web-server ping-poll reauth-timer-refresh”](#) on page 1897
- [“auth-web-server ping-poll timeout”](#) on page 1898
- [“auth-web-server port”](#) on page 1899
- [“auth-web-server redirect-delay-time”](#) on page 1900
- [“auth-web-server redirect-url”](#) on page 1901
- [“auth-web-server session-keep”](#) on page 1902
- [“auth-web-server ssl”](#) on page 1903
- [“auth-web-server ssl intercept-port”](#) on page 1904
- [“copy proxy-autoconfig-file”](#) on page 1905
- [“copy web-auth-https-file”](#) on page 1906
- [“description \(Authentication Profile\)”](#) on page 1907
- [“erase proxy-autoconfig-file”](#) on page 1908
- [“erase web-auth-https-file”](#) on page 1909
- [“show auth”](#) on page 1910
- [“show auth diagnostics”](#) on page 1911
- [“show auth interface”](#) on page 1912
- [“show auth sessionstatistics”](#) on page 1915

- “show auth statistics interface” on page 1916
- “show auth supplicant” on page 1917
- “show auth supplicant interface” on page 1920
- “show auth-web-server” on page 1921
- “show auth-web-server page” on page 1922
- “show proxy-autoconfig-file” on page 1923



# auth critical

**Overview** This command enables the critical port feature on the interface. When the critical port feature is enabled on an interface, and all the RADIUS servers are unavailable, then the interface becomes authorized.

The **no** variant of this command disables critical port feature on the interface.

**Syntax** `auth critical`  
`no auth critical`

**Default** The critical port of port authentication is disabled.

**Mode** Interface Configuration for an Ethernet port, or Authentication Profile mode.

**Examples** To enable the critical port feature on interface `eth1`, use the following commands:

```
awplus# configure terminal
awplus(config)# interface eth1
awplus(config-if)# auth critical
```

To disable the critical port feature on interface `eth1`, use the following commands:

```
awplus# configure terminal
awplus(config)# interface eth1
awplus(config-if)# no auth critical
```

To enable the critical port feature on authentication profile 'student', use the commands:

```
awplus# configure terminal
awplus(config)# auth profile student
awplus(config-auth-profile)# auth critical
```

To disable the critical port feature on authentication profile 'student', use the commands:

```
awplus# configure terminal
awplus(config)# auth profile student
awplus(config-auth-profile)# no auth critical
```

**Related Commands** [auth profile \(Global Configuration\)](#)  
[show auth-web-server](#)  
[show running-config](#)

# auth host-mode

**Overview** This command selects the host mode on the specified interface.

Use the **no** variant of this command to set host mode to the default setting (single host).

**Syntax** `auth host-mode {single-host|multi-host|multi-supPLICANT}`  
`no auth host-mode`

| Parameter                     | Description                                                                                                                                                                                                                                                                                                                                                                                                                                                               |
|-------------------------------|---------------------------------------------------------------------------------------------------------------------------------------------------------------------------------------------------------------------------------------------------------------------------------------------------------------------------------------------------------------------------------------------------------------------------------------------------------------------------|
| <code>single-host</code>      | Single host mode. In this mode, only one host may be authorized with the port. If other hosts out the interface attempt to authenticate, the authenticator blocks the attempt.                                                                                                                                                                                                                                                                                            |
| <code>multi-host</code>       | Multi host mode. In this mode, multiple hosts may be authorized with the port; however only one host must be successfully authenticated at the Authentication Server for all hosts to be authorized with the port. Upon one host being successfully authenticated (state Authenticated), the other hosts will be automatically authorized at the port (state ForceAuthorized). If no host is successfully authenticated, then all hosts are not authorized with the port. |
| <code>multi-supPLICANT</code> | Multi supplicant (client device) mode. In this mode, multiple hosts may be authorized with the port, but each host must be individually authenticated with the Authentication Server to be authorized with the port. Supplicants which are not authenticated are not authorized with the port, while supplicants which are successfully authenticated are authorized with the port.                                                                                       |

**Default** The default host mode for port authentication is for a single host.

**Mode** Interface Configuration for an Ethernet port, or Authentication Profile mode.

**Usage** Ports residing in the unauthorized state for host(s) or supplicant(s), change to an authorized state when the host or supplicant has successfully authenticated with the Authentication Server.

When multi-host mode is used or auth critical feature is used, all hosts do not need to be authenticated.

**Examples** To set the host mode to multi-supPLICANT on interface `eth1`, use the following commands:

```
awplus# configure terminal
awplus(config)# interface eth1
awplus(config-if)# auth host-mode multi-supPLICANT
```

To set the host mode to default (single host) on interface `eth1`, use the following commands:

```
awplus# configure terminal
awplus(config)# interface eth1
awplus(config-if)# no auth host-mode
```

To set the host mode to multi-supPLICANT on authentication profile 'student', use the commands:

```
awplus# configure terminal
awplus(config)# auth profile student
awplus(config-auth-profile)# auth host-mode multi-supPLICANT
```

To set the host mode to default (single host) on authentication profile 'student', use the commands:

```
awplus# configure terminal
awplus(config)# auth profile student
awplus(config-auth-profile)# no auth host-mode
```

**Related Commands** [auth profile \(Global Configuration\)](#)  
[show running-config](#)

# auth log

**Overview** Use this command to configure the types of authentication feature log messages that are output to the log file.

Use the **no** variant of this command to remove either specified types or all types of authentication feature log messages that are output to the log file.

**Syntax** `auth log auth-web {success|failure|logoff|all}`  
`no auth log auth-web {success|failure|logoff|all}`

| Parameter | Description                                                                                                                                                 |
|-----------|-------------------------------------------------------------------------------------------------------------------------------------------------------------|
| auth-web  | Specify only Web-Authentication log messages are output to the log file.                                                                                    |
| success   | Specify only successful authentication log messages are output to the log file.                                                                             |
| failure   | Specify only authentication failure log messages are output to the log file.                                                                                |
| logoff    | Specify only authentication log-off messages are output to the log file. Note that link down, age out and expired ping polling messages will be included.   |
| all       | Specify all types of authentication log messages are output to the log file. Note that this is the default behavior for the authentication logging feature. |

**Default** All types of authentication log messages are output to the log file by default.

**Mode** Interface Configuration for an Ethernet port, or Authentication Profile mode.

**Examples** To configure the logging of web authentication failures to the log file for supplicants (client devices) connected to interface `eth1`, use the following commands:

```
awplus# configure terminal
awplus(config)# interface eth1
awplus(config-if)# auth log auth-web failure
```

To configure the logging of web authentication failures to the log file for supplicants (client devices) connected to authentication profile 'student', use the commands:

```
awplus# configure terminal
awplus(config)# auth profile student
awplus(config-auth-profile)# auth log auth-web failure
```

To disable the logging of all types of authentication log messages to the log file for supplicants (client devices) connected to authentication profile 'student', use the commands:

```
awplus# configure terminal
awplus(config)# auth profile student
awplus(config-auth-profile)# no auth log all
```

**Related Commands** [auth profile \(Global Configuration\)](#)  
[show running-config](#)

# auth max-supPLICANT

**Overview** This command sets the maximum number of supplicants (client devices) that can be authenticated on the selected port. Once this value is exceeded, further supplicants will not be authenticated.

The **no** variant of this command resets the maximum supplicant number to the default.

**Syntax** `auth max-supPLICANT <2-1024>`  
`no auth max-supPLICANT`

| Parameter | Description   |
|-----------|---------------|
| <2-1024>  | Limit number. |

**Default** The max supplicant of port authentication is 1024.

**Mode** Interface Configuration for an Ethernet port, or Authentication Profile mode.

**Examples** To set the maximum number of supplicants to 10 on interface `eth1`, use the following commands:

```
awplus# configure terminal
awplus(config)# interface eth1
awplus(config-if)# auth max-supPLICANT 10
```

To reset the maximum number of supplicant to default on interface `eth1`, use the following commands:

```
awplus# configure terminal
awplus(config)# interface eth1
awplus(config-if)# no auth max-supPLICANT
```

To set the maximum number of supplicants to 10 on authentication profile 'student', use the commands:

```
awplus# configure terminal
awplus(config)# auth profile student
awplus(config-auth-profile)# auth max-supPLICANT 10
```

To reset the maximum number of supplicant to default on authentication profile 'student', use the commands:

```
awplus# configure terminal
awplus(config)# auth profile student
awplus(config-auth-profile)# no auth max-supPLICANT
```

**Related  
Commands** [auth profile \(Global Configuration\)](#)  
[show running-config](#)

# auth profile (Global Configuration)

**Overview** Use this command to enter port authentication profile mode and configure a port authentication profile.

If the specified profile does not exist a new authentication profile is created with the name provided.

Use the **no** variant of this command to delete the specified port authentication profile.

**Syntax** `auth profile <profile-name>`  
`no auth profile <profile-name>`

| Parameter                    | Description                                 |
|------------------------------|---------------------------------------------|
| <code>&lt;varname&gt;</code> | Name of the profile to create or configure. |

**Default** No port authentication profiles are created by default.

**Mode** Global Configuration

**Usage** A port authentication profile is a configuration object that aggregates multiple port authentication commands. These profiles are attached or detached from an interface using the [auth profile \(Interface Configuration\)](#) command.

**Example** To create a new authentication profile 'student', use the following commands:

```
awplus# configure terminal
awplus(config)# auth profile student
awplus(config-auth-profile)#
```

To delete an authentication profile 'student', use the following commands:

```
awplus# configure terminal
awplus(config)# no auth profile student
```

**Related Commands** [auth profile \(Interface Configuration\)](#)  
[description \(Authentication Profile\)](#)



# auth profile (Interface Configuration)

**Overview** Use this command to attach a port authentication profile to the current interface. Use the **no** variant of this command to detach a port authentication profile from the current interface.

**Syntax** `auth profile <profile-name>`  
`no auth profile <profile-name>`

| Parameter                         | Description                                                 |
|-----------------------------------|-------------------------------------------------------------|
| <code>&lt;profile-name&gt;</code> | The name of the profile to attach to the current interface. |

**Default** No profile is attached by default.

**Mode** Interface Configuration for an Ethernet port, or Authentication Profile mode.

**Usage** This command attaches a authentication profile, created using the [auth profile \(Global Configuration\)](#) command, to an Ethernet port.

You can only attach one profile to an interface at a time, use the **no** variant of the command to detach a profile before attempting to attach another one.

**Example** To attach the authentication profile 'student' to eth1, use the following commands:

```
awplus# configure terminal
awplus(config)# interface eth1
awplus(config-if)# auth profile student
```

To detach the authentication profile 'student' from eth1, use the following commands:

```
awplus# configure terminal
awplus(config)# interface eth1
awplus(config-if)# no auth profile student
```

**Related Commands** [auth profile \(Global Configuration\)](#)

# auth reauthentication

**Overview** This command enables re-authentication on the interface specified in the Interface mode.

Use the **no** variant of this command to disables reauthentication on the interface.

**Syntax** `auth reauthentication`  
`no auth reauthentication`

**Default** Reauthentication of port authentication is disabled by default.

**Mode** Interface Configuration for an Ethernet port, or Authentication Profile mode.

**Examples** To enable reauthentication on interface `eth1`, use the following commands:

```
awplus# configure terminal
awplus(config)# interface eth1
awplus(config-if)# auth reauthentication
```

To disable reauthentication on interface `eth1`, use the following commands:

```
awplus# configure terminal
awplus(config)# interface eth1
awplus(config-if)# no auth reauthentication
```

To enable reauthentication on authentication profile 'student', use the commands:

```
awplus# configure terminal
awplus(config)# auth profile student
awplus(config-auth-profile)# auth reauthentication
```

To disable reauthentication on authentication profile 'student', use the commands:

```
awplus# configure terminal
awplus(config)# auth profile student
awplus(config-auth-profile)# no auth reauthentication
```

**Related Commands** [auth profile \(Global Configuration\)](#)  
[show running-config](#)

# auth supplicant-ip

**Overview** This command adds a supplicant (client device) IP address on a given interface and provides parameters for its configuration.

Use the **no** variant of this command to delete the supplicant IP address and reset other parameters to their default values. The IP address can be determined before authentication for only auth-web client.

**Syntax**

```
auth supplicant-ip <ip-addr> [max-reauth-req <1-10>]
[port-control {auto|force-authorized|force-unauthorized}]
[quiet-period <1-65535>] [reauth-period <1-4294967295>]
[supp-timeout <1-65535>] [server-timeout <1-65535>]
[reauthentication]

no auth supplicant-ip <ip-addr> [reauthentication]
```

| Parameter          | Description                                                                        |
|--------------------|------------------------------------------------------------------------------------|
| <ip-addr>          | IP address of the supplicant entry in A.B.C.D/P format.                            |
| max-reauth-req     | The number of reauthentication attempts before becoming unauthorized.              |
| <1-10>             | Count of reauthentication attempts (default 2).                                    |
| port-control       | Port control commands.                                                             |
| auto               | A port control parameter that allows port clients to negotiate authentication.     |
| force-authorized   | A port control parameter that forces the port state to authorized.                 |
| force-unauthorized | A port control parameter that forces the port state to unauthorized.               |
| quiet-period       | Quiet period during which the port remains in the HELD state (default 60 seconds). |
| <1-65535>          | Seconds for quiet period.                                                          |
| reauth-period      | Seconds between reauthorization attempts (default 3600 seconds).                   |
| <1-4294967295>     | Seconds for reauthorization attempts (reauth-period).                              |
| supp-timeout       | Supplicant response timeout.                                                       |
| <1-65535>          | Seconds for supplicant response timeout (default 30 seconds).                      |
| server-timeout     | The period, in seconds, before the authentication server response times out.       |
| <1-65535>          | The server-timeout period, in seconds, default 3600 seconds.                       |
| reauthentication   | Enable reauthentication on a port.                                                 |

**Default** No supplicant IP address for port authentication exists by default until first created with the **auth supplicant-ip** command. The defaults for parameters applied are as shown in the table above.

**Mode** Interface Configuration for an Ethernet port, or Authentication Profile.

**Examples** To add the supplicant IP address 192.168.10.0/24 to force authorized port control for interface eth1, use the commands:

```
awplus# configure terminal
awplus(config)# interface eth1
awplus(config-if)# auth supplicant-ip 192.168.10.0/24
port-control force-authorized
```

To delete the supplicant IP address 192.168.10.0/24 for interface eth1, use the commands:

```
awplus# configure terminal
awplus(config)# interface eth1
awplus(config-if)# no auth supplicant-ip 192.168.10.0/24
```

To disable reauthentication for the supplicant(s) IP address 192.168.10.0/24 for interface eth1, use the commands:

```
awplus# configure terminal
awplus(config)# interface eth1
awplus(config-if)# no auth supplicant-ip 192.168.10.0/24
reauthentication
```

To add the supplicant IP address 192.168.10.0/24 to force authorized port control for auth profile 'student', use the commands:

```
awplus# configure terminal
awplus(config)# auth profile student
awplus(config-auth-profile)# auth supplicant-ip
192.168.10.0/24 port-control force-authorized
```

To disable reauthentication for the supplicant IP address 192.168.10.0/24, for auth profile 'student', use the commands:

```
awplus# configure terminal
awplus(config)# auth profile student
awplus(config-if)# no auth supplicant-ip 192.168.10.0/24
reauthentication
```

**Related  
Commands** [show running-config](#)

# auth supplicant-mac

**Overview** This command adds a supplicant (client device) MAC address or MAC mask on a given interface with the parameters as specified in the table below.

Use the **no** variant of this command to delete the supplicant MAC address and reset other parameters to their default values.

**Syntax**

```
auth supplicant-mac <mac-addr> [mask <mac-addr-mask>]
[max-reauth-req <1-10>] [port-control
{auto|force-authorized|force-unauthorized} [quiet-period
<1-65535>] [reauth-period <1-4294967295>] [supp-timeout
<1-65535>] [server-timeout <1-65535>] [reauthentication]
no auth supplicant-mac <mac-addr> [reauthentication]
```

| Parameter          | Description                                                                                                                                                                                                                                                                                                                                                                                                                                                                                                                                                                                                                                                                             |
|--------------------|-----------------------------------------------------------------------------------------------------------------------------------------------------------------------------------------------------------------------------------------------------------------------------------------------------------------------------------------------------------------------------------------------------------------------------------------------------------------------------------------------------------------------------------------------------------------------------------------------------------------------------------------------------------------------------------------|
| <mac-addr>         | MAC (hardware) address of the supplicant entry in HHHH.HHHH.HHHH MAC address hexadecimal format.                                                                                                                                                                                                                                                                                                                                                                                                                                                                                                                                                                                        |
| mask               | A mask applied to MAC addresses in order to select only those addresses containing a specific string.                                                                                                                                                                                                                                                                                                                                                                                                                                                                                                                                                                                   |
| <mac-addr-mask>    | The mask comprises a string of three (period separated) bytes, where each byte comprises four hexadecimal characters that will generally be either 1 or 0. When the mask is applied to a specific MAC address, a match is only required for characters that correspond to a 1 in the mask. Characters that correspond to a 0 in the mask are effectively ignored.<br>In the examples section below, the mask ffff.ff00.0000 is applied for the MAC address 0000.5E00.0000. The applied mask will then match only those MAC addresses that begin with 0000.5E (in this case the OUI component). The remaining portion of the addresses (in this case the NIC component) will be ignored. |
| port-control       | Port control commands.                                                                                                                                                                                                                                                                                                                                                                                                                                                                                                                                                                                                                                                                  |
| auto               | Allow port client to negotiate authentication.                                                                                                                                                                                                                                                                                                                                                                                                                                                                                                                                                                                                                                          |
| force-authorized   | Force port state to authorized.                                                                                                                                                                                                                                                                                                                                                                                                                                                                                                                                                                                                                                                         |
| force-unauthorized | Force port state to unauthorized.                                                                                                                                                                                                                                                                                                                                                                                                                                                                                                                                                                                                                                                       |
| quiet-period       | Quiet period in the HELD state (default 60 seconds).                                                                                                                                                                                                                                                                                                                                                                                                                                                                                                                                                                                                                                    |
| <1-65535>          | Seconds for quiet period.                                                                                                                                                                                                                                                                                                                                                                                                                                                                                                                                                                                                                                                               |
| reauth-period      | Seconds between reauthorization attempts (default 3600 seconds).                                                                                                                                                                                                                                                                                                                                                                                                                                                                                                                                                                                                                        |
| <1-4294967295>     | Seconds for reauthorization attempts (reauth-period).                                                                                                                                                                                                                                                                                                                                                                                                                                                                                                                                                                                                                                   |
| supp-timeout       | Supplicant response timeout (default 30 seconds).                                                                                                                                                                                                                                                                                                                                                                                                                                                                                                                                                                                                                                       |
| <1-65535>          | Seconds for supplicant response timeout.                                                                                                                                                                                                                                                                                                                                                                                                                                                                                                                                                                                                                                                |

| Parameter        | Description                                                               |
|------------------|---------------------------------------------------------------------------|
| server-timeout   | Authentication server response timeout (default 30 seconds).              |
| <1-65535>        | Seconds for authentication server response timeout.                       |
| reauthentication | Enable reauthentication on a port.                                        |
| max-reauth-req   | No of reauthentication attempts before becoming unauthorized (default 2). |
| <1-10>           | Count of reauthentication attempts.                                       |

**Default** No supplicant MAC address for port authentication exists by default until first created with the **auth supplicant-mac** command. The defaults for parameters are shown in the table above.

**Mode** Interface Configuration for an Ethernet port, or Authentication Profile mode.

**Examples** To add the supplicant MAC address 0000.5E00.5343 to force authorized port control for interface eth1, use the commands:

```
awplus# configure terminal
awplus(config)# interface eth1
awplus(config-if)# auth supplicant-mac 0000.5E00.5343
port-control force-authorized
```

To apply the mask ffff.ff00.0000 in order to add any supplicant MAC addresses whose MAC address begins with 0000.5E, and then to force authorized port control for interface eth1, use the commands:

```
awplus# configure terminal
awplus(config)# interface eth1
awplus(config-if)# auth supplicant-mac 0000.5E00.0000 mask
ffff.ff00.0000 port-control force-authorized
```

To delete the supplicant MAC address 0000.5E00.5343 for interface eth1, use the commands:

```
awplus# configure terminal
awplus(config)# interface eth1
awplus(config-if)# no auth supplicant-mac 0000.5E00.5343
```

To disable reauthentication for the supplicant MAC address 0000.5E00.5343 for interface eth1, use the commands:

```
awplus# configure terminal
awplus(config)# interface eth1
awplus(config-if)# no auth supplicant-mac 0000.5E00.5343
reauthentication
```

To add the supplicant MAC address 0000.5E00.5343 to force authorized port control for authentication profile 'student', use the commands:

```
awplus# configure terminal
awplus(config)# auth profile student
awplus(config-auth-profile)# auth supplicant-mac
0000.5E00.5343 port-control force-authorized
```

To delete the supplicant MAC address 0000.5E00.5343 for authentication profile 'student', use the commands:

```
awplus# configure terminal
awplus(config)# auth profile student
awplus(config-auth-profile)# no auth supplicant-mac
0000.5E00.5343
```

To disable reauthentication for the supplicant MAC address 0000.5E00.5343 for authentication profile 'student', use the commands:

```
awplus# configure terminal
awplus(config)# auth profile student
awplus(config-auth-profile)# no auth supplicant-mac
0000.5E00.5343 reauthentication
```

**Related  
Commands**    [show auth](#)  
                  [show running-config](#)

# auth timeout connect-timeout

**Overview** This command sets the connect-timeout period for the interface.

Use the **no** variant of this command to reset the connect-timeout period to the default.

```
auth timeout connect-timeout <1-65535>
no auth timeout connect-timeout
```

| Parameter | Description                                        |
|-----------|----------------------------------------------------|
| <1-65535> | Specifies the connect-timeout period (in seconds). |

**Mode** Interface Configuration for an Ethernet port, or Authentication Profile mode.

This command is used for Web-Authentication. If the connect-timeout has lapsed and the supplicant has the state **connecting**, then the supplicant is deleted. When [auth-web-server session-keep](#) is enabled, we recommend you configure a longer connect-timeout period.

To set the connect-timeout period to 3600 seconds for interface eth1, use the following commands:

```
awplus# configure terminal
awplus(config)# interface eth1
awplus(config-if)# auth timeout connect-timeout 3600
```

To reset the connect-timeout period to the default (30 seconds) for interface eth1, use the following commands:

```
awplus# configure terminal
awplus(config)# interface eth1
awplus(config-if)# no auth timeout connect-timeout
```

To set the connect-timeout period to 3600 seconds for authentication profile 'student', use the commands:

```
awplus# configure terminal
awplus(config)# auth profile student
awplus(config-auth-profile)# auth timeout connect-timeout 3600
```

To reset the connect-timeout period to the default (30 seconds) for authentication profile 'student', use the commands:

```
awplus# configure terminal
awplus(config)# auth profile student
awplus(config-auth-profile)# no auth timeout connect-timeout
```

[auth profile \(Global Configuration\)](#)



# auth timeout quiet-period

**Overview** This command sets a time period for which another authentication request is not accepted on a given interface, after an authentication request has failed.

Use the **no** variant of this command to reset the quiet period to the default.

**Syntax** `auth timeout quiet-period <1-65535>`  
`no auth timeout quiet-period`

| Parameter | Description                              |
|-----------|------------------------------------------|
| <1-65535> | Specifies the quiet period (in seconds). |

**Default** The quiet period for port authentication is 60 seconds.

**Mode** Interface Configuration for an Ethernet port, or Authentication Profile mode.

**Examples** To set the quiet period to 10 seconds for interface eth1, use the commands:

```
awplus# configure terminal
awplus(config)# interface eth1
awplus(config-if)# auth timeout quiet-period 10
```

To reset the quiet period to the default (60 seconds) for interface eth1, use the commands:

```
awplus# configure terminal
awplus(config)# interface eth1
awplus(config-if)# no auth timeout quiet-period
```

To set the quiet period to 10 seconds for authentication profile 'student', use the commands:

```
awplus# configure terminal
awplus(config)# auth profile student
awplus(config-auth-profile)# auth timeout quiet-period 10
```

To reset the quiet period to the default (60 seconds) for authentication profile 'student', use the commands:

```
awplus# configure terminal
awplus(config)# auth profile student
awplus(config-auth-profile)# no auth timeout quiet-period
```

**Related Commands** [auth profile \(Global Configuration\)](#)

# auth timeout reauth-period

**Overview** This command sets the timer for reauthentication on a given interface. The re-authentication for the supplicant (client device) is executed at this timeout. The timeout is only applied if the **auth reauthentication** command is applied.

Use the **no** variant of this command to reset the **reauth-period** parameter to the default (3600 seconds).

**Syntax** `auth timeout reauth-period <1-4294967295>`  
`no auth timeout reauth-period`

| Parameter      | Description                                       |
|----------------|---------------------------------------------------|
| <1-4294967295> | The reauthentication timeout period (in seconds). |

**Default** The default reauthentication period for port authentication is 3600 seconds, when reauthentication is enabled on the port.

**Mode** Interface Configuration for an Ethernet port, or Authentication Profile mode.

**Examples** To set the reauthentication period to 1 day for interface `eth1`, use the following commands:

```
awplus# configure terminal
awplus(config)# interface eth1
awplus(config-if)# auth timeout reauth-period 86400
```

To reset the reauthentication period to the default (3600 seconds) for interface `eth1`, use the following commands:

```
awplus# configure terminal
awplus(config)# interface eth1
awplus(config-if)# no auth timeout reauth-period
```

To set the reauthentication period to 1 day for authentication profile 'student', use the commands:

```
awplus# configure terminal
awplus(config)# auth profile student
awplus(config-auth-profile)# auth timeout reauth-period 86400
```

To reset the reauthentication period to the default (3600 seconds) for authentication profile 'student', use the commands:

```
awplus# configure terminal
awplus(config)# auth profile student
awplus(config-auth-profile)# no auth timeout reauth-period
```

**Related  
Commands**    [auth profile \(Global Configuration\)](#)  
                  [auth reauthentication](#)  
                  [show running-config](#)

# auth timeout server-timeout

**Overview** This command sets the timeout for the waiting response from the RADIUS server on a given interface.

The **no** variant of this command resets the server-timeout to the default (30 seconds).

**Syntax** `auth timeout server-timeout <1-65535>`  
`no auth timeout server-timeout`

| Parameter | Description                         |
|-----------|-------------------------------------|
| <1-65535> | Server timeout period (in seconds). |

**Default** The server timeout for port authentication is 30 seconds.

**Mode** Interface Configuration for an Ethernet port, or Authentication Profile mode.

**Examples** To set the server timeout to 120 seconds for interface `eth1`, use the following commands:

```
awplus# configure terminal
awplus(config)# interface eth1
awplus(config-if)# auth timeout server-timeout 120
```

To set the server timeout to the default (30 seconds) for interface `eth1`, use the following commands:

```
awplus# configure terminal
awplus(config)# interface eth1
awplus(config-if)# no auth timeout server-timeout
```

To set the server timeout to 120 seconds for authentication profile 'student', use the commands:

```
awplus# configure terminal
awplus(config)# auth profile student
awplus(config-auth-profile)# auth timeout server-timeout 120
```

To set the server timeout to the default (30 seconds) for authentication profile 'student', use the commands:

```
awplus# configure terminal
awplus(config)# auth profile student
awplus(config-auth-profile)# no auth timeout server-timeout
```

**Related Commands** [auth profile \(Global Configuration\)](#)  
[show running-config](#)

# auth-web accounting

**Overview** This command overrides the **default** RADIUS accounting method for Web-based authentication on an interface by allowing you to apply a user-defined named list.

Use the **no** variant of this command to remove the named list from the interface and apply the **default** method.

**Syntax** `auth-web accounting {default|<list-name>}`  
`no auth-web accounting`

| Parameter   | Description                              |
|-------------|------------------------------------------|
| default     | Apply the default accounting method list |
| <list-name> | Apply a named accounting method list     |

**Default** The **default** method list is applied to an interface by default.

**Mode** Interface Mode

**Example** To apply the named list 'example\_acct' on the eth1 interface, use the commands:

```
awplus# configure terminal
awplus(config)# interface eth1
awplus(config-if)# auth-web accounting example_acct
```

To remove the named list from the eth1 interface and set the accounting method back to **default**, use the commands:

```
awplus# configure terminal
awplus(config)# interface eth1
awplus(config-if)# no auth-web accounting
```

**Related Commands** [aaa accounting auth-web](#)

# auth-web authentication

**Overview** This command overrides the **default** Web-based authentication method on an interface by allowing you to apply a user-defined named list.

Use the **no** variant of this command to remove the named list from the interface and apply the **default** method.

**Syntax** `auth-web authentication {default|<list-name>}`  
`no auth-web authentication`

| Parameter   | Description                                  |
|-------------|----------------------------------------------|
| default     | Apply the default authentication method list |
| <list-name> | Apply the user-defined named list            |

**Default** The **default** method list is applied to an interface by default.

**Mode** Interface Mode

**Example** To apply the named list 'example\_auth' on the eth1 interface, use the commands:

```
awplus# configure terminal
awplus(config)# interface eth1
awplus(config-if)# auth-web authentication example_auth
```

To remove the named list from the eth1 interface and set the authentication method back to **default**, use the commands:

```
awplus# configure terminal
awplus(config)# interface eth1
awplus(config-if)# no auth-web authentication
```

**Related Commands** [aaa authentication auth-web](#)

# auth-web enable

**Overview** This command enables Web-based authentication in Interface mode on the interface specified.

Use the **no** variant of this command to apply its default.

**Syntax** auth-web enable  
no auth-web enable

**Default** Web-Authentication is disabled by default.

**Mode** Interface Configuration for an Ethernet port, or Authentication Profile mode.

**Usage** You need to configure an IPv4 address for the Ethernet interface on which Web Authentication is running.

When the **protect (firewall)** command and the **web-auth enable** command are both configured, you need to configure a firewall rule to allow Auth-web traffic to pass through the firewall. Web-auth uses TCP ports 8081, 8082, 8083 and 8084. You can create a firewall rule like the following example:

```
!
application auth-apl
protocol tcp
dport 8081 to 8084
!
!
firewall
 rule 65 permit auth-apl from private.supPLICANT to
private.supPLICANT.router
!
```

**Examples** To enable Web-Authentication on eth1, use the following commands:

```
awplus# configure terminal
awplus(config)# interface eth1
awplus(config-if)# auth-web enable
```

To disable Web-Authentication on eth1, use the following commands:

```
awplus# configure terminal
awplus(config)# interface eth1
awplus(config-if)# no auth-web enable
```

To enable Web authentication on authentication profile 'student', use the commands:

```
awplus# configure terminal
awplus(config)# auth profile student
awplus(config-auth-profile)# auth-web enable
```

To disable Web authentication on authentication profile 'student', use the commands:

```
awplus# configure terminal
awplus(config)# auth profile student
awplus(config-auth-profile)# no auth-web enable
```

**Related  
Commands**

- [auth profile \(Global Configuration\)](#)
- [show auth](#)
- [show auth interface](#)
- [show running-config](#)



# auth-web forward

**Overview** This command enables the Web-authentication packet forwarding feature on the interface specified. This command also enables ARP forwarding, and adds forwarded packets to the **tcp** or **udp** port number specified.

The **no** variant of this command disables the specified packet forwarding feature on the interface.

**Syntax** `auth-web forward [<ip-address>|<ip-address/prefix-length>]  
{dns|tcp <1-65535>|udp <1-65535>}`

Or

`auth-web forward {arp|dhcp|dns|tcp <1-65535>|udp <1-65535>}`

The **no** variant of this command are:

`no auth-web forward [<ip-address>|<ip-address/prefix-length>]  
{dns|tcp <1-65535>|udp <1-65535>}`

Or

`no auth-web forward {arp|dhcp|dns|tcp <1-65535>|udp <1-65535>}`

| Parameter                                                                             | Description                                                                |
|---------------------------------------------------------------------------------------|----------------------------------------------------------------------------|
| <code>&lt;ip-address&gt;</code><br><code>&lt;ip-address/<br/>prefix-length&gt;</code> | The IP address or subnet on which the Web-authentication is to be enabled. |
| <code>arp</code>                                                                      | Enable forwarding of ARP.                                                  |
| <code>dhcp</code>                                                                     | Enable forwarding of DHCP (67/udp).                                        |
| <code>dns</code>                                                                      | Enable forwarding of DNS (53/udp).                                         |
| <code>tcp</code>                                                                      | Enable forwarding of TCP specified port number.                            |
| <code>&lt;1-65535&gt;</code>                                                          | TCP Port number.                                                           |
| <code>udp</code>                                                                      | Enable forwarding of UDP specified port number.                            |
| <code>&lt;1-65535&gt;</code>                                                          | UDP Port number.                                                           |

**Default** Packet forwarding for port authentication is enabled by default for "arp", "dhcp" and "dns".

**Mode** Interface Configuration for an Ethernet port, or Authentication Profile mode.

**Usage** For more information about the `<ip-address>` parameter, and an example, see the "auth- web forward" section in the [AlliedWare Plus Technical Tips and Tricks](#).

**Examples** To enable the ARP forwarding feature on interface eth1, use the following commands:

```
awplus# configure terminal
awplus(config)# interface eth1
awplus(config-if)# auth-web forward arp
```

To add the TCP forwarding port 137 on interface eth1, use the following commands:

```
awplus# configure terminal
awplus(config)# interface eth1
awplus(config-if)# auth-web forward tcp 137
```

To disable the ARP forwarding feature on interface eth1, use the following commands:

```
awplus# configure terminal
awplus(config)# interface eth1
awplus(config-if)# no auth-web forward arp
```

To delete the TCP forwarding port 137 on interface eth1, use the following commands:

```
awplus# configure terminal
awplus(config)# interface eth1
awplus(config-if)# no auth-web forward tcp 137
```

To delete the all of TCP forwarding on interface eth1, use the following commands:

```
awplus# configure terminal
awplus(config)# interface eth1
awplus(config-if)# no auth-web forward tcp
```

To enable the arp forwarding feature on authentication profile 'student', use the commands:

```
awplus# configure terminal
awplus(config)# auth profile student
awplus(config-auth-profile)# auth-web forward arp
```

To add the tcp forwarding port 137 on authentication profile 'student', use the commands:

```
awplus# configure terminal
awplus(config)# auth profile student
awplus(config-auth-profile)# auth-web forward tcp 137
```

To disable the ARP forwarding feature on authentication profile 'student', use the commands:

```
awplus# configure terminal
awplus(config)# auth profile student
awplus(config-auth-profile)# no auth-web forward arp
```

To delete the tcp forwarding port 137 on authentication profile 'student', use the commands:

```
awplus# configure terminal
awplus(config)# auth profile student
awplus(config-auth-profile)# no auth-web forward tcp 137
```

To delete all tcp forwarding on authentication profile 'student', use the commands:

```
awplus# configure terminal
awplus(config)# auth profile student
awplus(config-auth-profile)# no auth-web forward tcp
```

**Related Commands**

- [auth profile \(Global Configuration\)](#)
- [show auth](#)
- [show auth interface](#)

# auth-web idle-timeout enable

**Overview** Use this command to enable the idle-timeout for client of web authentication on the interface.

The **no** variant of this command to disable the idle-timeout for client of web authentication on the interface.

**Syntax** `auth-web idle-timeout enable`  
`no auth-web idle-timeout enable`

**Default** The idle-timeout is disabled by default.

**Mode** Interface Mode and Auth Profile

**Example** To enable the idle-timeout on an interface, use the following commands:

```
awplus# configure terminal
awplus(config)# interface eth1
awplus(config)# auth-web enable
awplus(config-if)# auth-web idle-timeout enable
```

To disable the idle-timeout on an interface, use the following commands:

```
awplus# configure terminal
awplus(config)# interface eth1
awplus(config-if)# no auth-web idle-timeout enable
```

**Related Commands** [auth-web enable](#)  
[auth-web idle-timeout timeout](#)

# auth-web idle-timeout timeout

**Overview** Use this command to set the timeout value for web authentication client in seconds. The client will be unauthorized when it does not have any activity for a period that exceeds the timeout value.

The **no** variant of this command sets the timeout value to the default setting, 3600 seconds.

**Syntax** `auth-web idle-timeout timeout <420-86400>`  
`no auth-web idle-timeout timeout`

| Parameter   | Description      |
|-------------|------------------|
| <420-86400> | Time in seconds. |

**Default** The timeout is 3600 seconds by default.

**Mode** Interface Mode and Auth Profile

**Example** To set 30 minutes as the idle-timeout, use the following commands:

```
awplus# configure terminal
awplus(config)# interface eth1
awplus(config-if)# auth-web idle-timeout timeout 1800
```

To return the idle-timeout to the default, use the following commands:

```
awplus# configure terminal
awplus(config)# interface eth1
awplus(config-if)# no auth-web idle-timeout timeout
```

**Related Commands** [auth-web enable](#)  
[auth-web idle-timeout enable](#)

# auth-web max-auth-fail

**Overview** This command sets the number of authentication failures allowed before rejecting further authentication requests. When the supplicant (client device) fails more than the specified number of times, then login requests are refused during the quiet period.

The **no** variant of this command resets the maximum number of authentication failures to the default.

**Syntax** `auth-web max-auth-fail <0-10>`  
`no auth-web max-auth-fail`

| Parameter | Description                                                           |
|-----------|-----------------------------------------------------------------------|
| <0-10>    | The maximum number of authentication requests allowed before failing. |

**Default** The maximum number of authentication failures is set to 3.

**Mode** Interface Configuration for an Ethernet port, or Authentication Profile mode.

**Examples** To set the lock count to 5 on interface `eth1`, use the following commands:

```
awplus# configure terminal
awplus(config)# interface eth1
awplus(config-if)# auth-web max-auth-fail 5
```

To set the lock count to the default on interface `eth1`, use the following commands:

```
awplus# configure terminal
awplus(config)# interface eth1
awplus(config-if)# no auth-web max-auth-fail
```

To set the lock count to 5 on authentication profile 'student', use the commands:

```
awplus# configure terminal
awplus(config)# auth profile student
awplus(config-auth-profile)# auth-web max-auth-fail 5
```

To set the lock count to the default on authentication profile 'student', use the commands:

```
awplus# configure terminal
awplus(config)# auth profile student
awplus(config-auth-profile)# no auth-web max-auth-fail
```

**Related  
Commands**    auth profile (Global Configuration)  
                  auth timeout quiet-period  
                  show auth  
                  show auth interface  
                  show running-config

# auth-web method

**Overview** This command sets the Web-authentication access method that is used with RADIUS on the interface specified.

The **no** variant of this command sets the authentication method to PAP for the interface specified when Web-Authentication is also used with the RADIUS authentication method.

**Syntax** `auth-web method {eap-md5|pap}`  
`no auth-web method`

| Parameter            | Description                                  |
|----------------------|----------------------------------------------|
| <code>eap-md5</code> | Enable EAP-MD5 as the authentication method. |
| <code>pap</code>     | Enable PAP as the authentication method.     |

**Default** The Web-Authentication method is set to PAP by default.

**Mode** Interface Configuration for an Ethernet port, or Authentication Profile mode.

**Example** To set the Web-Authentication method to `eap-md5` on interface `eth1`, use the following commands:

```
awplus# configure terminal
awplus(config)# interface eth1
awplus(config-if)# auth-web method eap-md5
```

To set the web authentication method to `eap-md5` for authentication profile 'student', use the commands:

```
awplus# configure terminal
awplus(config)# auth profile student
awplus(config-auth-profile)# auth-web method eap-md5
```

To reset the web authentication method to the default (PAP) for authentication profile 'student', use the commands:

```
awplus# configure terminal
awplus(config)# auth profile student
awplus(config-auth-profile)# no auth-web method
```

**Related Commands**

- [auth profile \(Global Configuration\)](#)
- [show auth](#)
- [show auth interface](#)
- [show running-config](#)



# auth-web-server dhcp ipaddress

**Overview** Use this command to assign an IP address and enable the DHCP service on the Web-Authentication server for supplicants (client devices).

Use the **no** variant of this command to remove an IP address and disable the DHCP service on the Web-Authentication server for supplicants.

**Syntax** `auth-web-server dhcp ipaddress <ip-address/prefix-length>`  
`no auth-web-server dhcp ipaddress`

| Parameter                                       | Description                                                                                                        |
|-------------------------------------------------|--------------------------------------------------------------------------------------------------------------------|
| <code>&lt;ip-addr/<br/>prefix-length&gt;</code> | The IPv4 address and prefix length assigned for the DHCP service on the Web-Authentication server for supplicants. |

**Default** No IP address for the Web-Authentication server is set by default.

**Mode** Global Configuration

**Usage** See the [AAA and Port Authentication Feature Overview and Configuration Guide](#) for information about:

- using DHCP with web authentication, and
- restrictions regarding combinations of authentication enhancements working together

You cannot use the IPv4 address assigned to the device's interface as the Web-Authentication server address.

**Examples** To assign the IP address 10.0.0.1 to the Web-Authentication server, use the following commands:

```
awplus# configure terminal
awplus(config)# auth-web-server dhcp ipaddress 10.0.0.1/8
```

To remove an IP address on the Web-Authentication server, use the following commands:

```
awplus# configure terminal
awplus(config)# no auth-web-server dhcp ipaddress
```

**Validation Commands** `show running-config`

**Related Commands** `show auth-web-server`  
`auth-web-server dhcp lease`

# auth-web-server dhcp lease

**Overview** Use this command to set the DHCP lease time for supplicants (client devices) using the DHCP service on the Web-Authentication server.

Use the **no** variant of this command to reset to the default DHCP lease time for supplicants using the DHCP service on the Web-Authentication server.

**Syntax** `auth-web-server dhcp lease <20-60>`  
`no auth-web-server dhcp lease`

| Parameter | Description                                                                                         |
|-----------|-----------------------------------------------------------------------------------------------------|
| <20-60>   | DHCP lease time for supplicants using the DHCP service on the Web-Authentication server in seconds. |

**Default** The default DHCP lease time for supplicants using the DHCP service on the Web-Authentication server is set to 30 seconds.

**Mode** Global Configuration

**Usage** See the [AAA and Port Authentication Feature Overview and Configuration Guide](#) for information about:

- using DHCP with web authentication, and
- restrictions regarding combinations of authentication enhancements working together

**Examples** To set the DHCP lease time to 1 minute for supplicants using the DHCP service on the Web-Authentication server, use the following commands:

```
awplus# configure terminal
awplus(config)# auth-web-server dhcp lease 60
```

To reset the DHCP lease time to the default setting (30 seconds) for supplicants using the DHCP service on the Web-Authentication server, use the following commands:

```
awplus# configure terminal
awplus(config)# no auth-web-server dhcp lease
```

**Validation Commands** `show running-config`

**Related Commands** `show auth-web-server`  
`auth-web-server dhcp ipaddress`

# auth-web-server dhcp-wpad-option

**Overview** This command sets the DHCP WPAD (Web Proxy Auto-Discovery) option for the Web-Authentication temporary DHCP service.

For more information and examples, see the “Web Auth Proxy” section in the [AlliedWare Plus Technical Tips and Tricks](#).

Use the **no** variant of this command to disable the DHCP WPAD function.

**Syntax** `auth-web-server dhcp wpad-option <url>`  
`no auth-web-server dhcp wpad-option`

| Parameter                | Description                               |
|--------------------------|-------------------------------------------|
| <code>&lt;url&gt;</code> | URL to the server which gets a .pac file. |

**Default** The Web-Authentication server DHCP WPAD option is not set.

**Mode** Global Configuration

**Usage** If the supplicant is configured to use WPAD, the supplicant’s web browser will use TCP port 80 as usual. Therefore, the packet can be intercepted by Web-Authentication as normal, and the Web-Authentication Login page can be sent. However, after authentication, the browser does not know where to get the WPAD file and so cannot access external web pages. The WPAD file is usually named proxy.pac file and tells the browser what web proxy to use.

Use this command to tell the supplicant where it can get this file from. The switch itself can be specified as the source for this file, and it can deliver it to the supplicant on request.

**Example** To specify that the proxy.pac file is found on the server at 192.168.1.100, use the following commands:

```
awplus# configure terminal
awplus(config)# auth-web-server dhcp wpad-option
http://192.168.1.100/proxy/proxy.pac
```

**Related Commands** [show auth-web-server](#)

# auth-web-server host-name

**Overview** This command assigns a hostname to the web authentication server.  
Use the **no** variant of this command to remove the hostname from the web authentication server.

**Syntax** `auth-web-server host-name <hostname>`  
`no auth-web-server host-name`

| Parameter                     | Description                |
|-------------------------------|----------------------------|
| <code>&lt;hostname&gt;</code> | URL string of the hostname |

**Default** The web authentication server has no hostname.

**Mode** Global Configuration

**Usage** When the web authentication server uses HTTPS protocol, the web browser will validate the certificate. If the certificate is invalid, the web page gives a warning message before displaying server content. However, the web page will not give warning message if the server has a hostname same as the one stored in the installed certificate.

**Examples** To set the `auth.example.com` as the hostname of the web authentication server, use the commands:

```
awplus# configure terminal
awplus(config)# auth-web-server host-name auth.example.com
```

To remove hostname `auth.example.com` from the web authentication server, use the commands:

```
awplus# configure terminal
awplus(config)# no auth-web-server host-name
```

**Related Commands** [aaa authentication auth-web](#)  
[auth-web enable](#)

# auth-web-server intercept-port

**Overview** This command specifies any additional TCP port numbers that the Web-Authentication server is to intercept.

Use the **no** variant of this command to stop intercepting the TCP port numbers.

**Syntax** `auth-web-server intercept-port {<1-65535>|any}`  
`no auth-web-server intercept-port {<1-65535>|any}`

| Parameter | Description               |
|-----------|---------------------------|
| <1-65535> | TCP port number.          |
| any       | Intercept all TCP packets |

**Default** No additional TCP port numbers are intercepted by default.

**Mode** Global Configuration

**Usage** If this command is not specified, AlliedWare Plus Web-Authentication intercepts the supplicant's initial TCP port 80 connection to a web page and sends it the Web-Authentication Login page. However, if the supplicant is configured to use a web proxy, then it will usually be using TCP port 8080 (or another user configured port number). In this case Web-Authentication cannot intercept the connection.

To overcome this limitation you can use this command to tell the switch which additional port it should intercept, and then send the Web-Authentication Login page to the supplicant.

When the web authentication switch is in a guest network, the switch does not know the proxy server's port number in the supplicant's proxy setting. To overcome this limitation, you can use the **any** option in this command to intercept all TCP packets.

When you use this command in conjunction with a proxy server configured in the web browser, you must add the proxy server's network as a 'No Proxy' network. You can specify 'No Proxy' networks in the proxy settings in your web browser. For more information, see the "Web Auth Proxy" section in the [Alliedware Plus Technical Tips and Tricks](#).

**Example** To additionally intercept port number 3128, use the following commands:

```
awplus# configure terminal
awplus(config)# auth-web-server intercept-port 3128
```

**Related Commands** [show auth-web-server](#)

# auth-web-server ipaddress

**Overview** This command sets the IP address for the Web-Authentication server.

Use the **no** variant of this command to delete the IP address for the Web-Authentication server.

You cannot use the IPv4 address assigned to the device's interface as the Web-Authentication server address.

**Syntax** `auth-web-server ipaddress <ip-address>`  
`no auth-web-server ipaddress`

| Parameter                       | Description                                                            |
|---------------------------------|------------------------------------------------------------------------|
| <code>&lt;ip-address&gt;</code> | Web-Authentication server dotted decimal IP address in A.B.C.D format. |

**Default** The Web-Authentication server address on the system is not set by default.

**Mode** Global Configuration

**Examples** To set the IP address 10.0.0.1 to the Web-Authentication server, use the following commands:

```
awplus# configure terminal
awplus(config)# auth-web-server ipaddress 10.0.0.1
```

To delete the IP address from the Web-Authentication server, use the following commands:

```
awplus# configure terminal
awplus(config)# no auth-web-server ipaddress
```

**Validation Commands** `show auth`  
`show auth-web-server`  
`show running-config`

# auth-web-server page language

**Overview** Use this command to set the presentation language of Web authentication pages. Titles and subtitles of Web authentication pages will be set accordingly. Note that presently only English or Japanese are offered.

Use the **no** variant of this command to set the presentation language of Web authentication pages to its default (English).

**Syntax** `auth-web-server page language {english|japanese}`  
`no auth-web-server page language`

| Parameter | Description                                         |
|-----------|-----------------------------------------------------|
| english   | Web authentication pages are presented in English.  |
| japanese  | Web authentication pages are presented in Japanese. |

**Default** Web authentication pages are presented in English by default.

**Mode** Global Configuration

**Examples** To set Japanese as the presentation language of Web authentication pages, use the following commands:

```
awplus# configure terminal
awplus(config)# auth-web-server page language japanese
```

To set English as the presentation language of Web authentication pages, use the following commands:

```
awplus# configure terminal
awplus(config)# auth-web-server page language english
```

To unset the presentation language of Web authentication pages and use English as the default presentation language, use the following commands:

```
awplus# configure terminal
awplus(config)# no auth-web-server page language
```

**Related Commands** [auth-web-server page title](#)  
[auth-web-server page sub-title](#)  
[show auth-web-server page](#)

# auth-web-server login-url

**Overview** This command sets the web-authentication login page URL. This lets you replace the login page with your own page. See “Customising the Login Page” in the [AAA and Port Authentication Feature Overview and Configuration Guide](#) for details.

Use the **no** variant of this command to delete the URL.

**Syntax** `auth-web-server login-url <URL>`  
`no auth-web-server login-url`

| Parameter | Description        |
|-----------|--------------------|
| <URL>     | Set login page URL |

**Default** The built-in login page is set by default.

**Mode** Global Configuration

**Examples** To set `http://example.com/login.html` as the login page, use the commands:

```
awplus# configure terminal
awplus(config)# auth-web-server login-url
http://example.com/login.html
```

To unset the login page URL, use the commands:

```
awplus# configure terminal
awplus(config)# no auth-web-server login-url
```

**Related Commands** [show running-config](#)



# auth-web-server page logo

**Overview** This command sets the type of logo that will be displayed on the web authentication page.

Use the **no** variant of this command to set the logo type to **auto**.

Note that if you need to customize the login page extensively, you can instead replace it with your own page. See “Customising the Login Page” in the [AAA and Port Authentication Feature Overview and Configuration Guide](#).

**Syntax** `auth-web-server page logo {auto|default|hidden}`  
`no auth-web-server page logo`

| Parameter | Description                                                              |
|-----------|--------------------------------------------------------------------------|
| auto      | Display the custom logo if installed; otherwise display the default logo |
| default   | Display the default logo                                                 |
| hidden    | Hide the logo                                                            |

**Default** Logo type is **auto** by default.

**Mode** Global Configuration

**Examples** To display the default logo with ignoring installed custom logo, use the commands:

```
awplus# configure terminal
awplus(config)# auth-web-server page logo default
```

To set back to the default logo type **auto**, use the commands:

```
awplus# configure terminal
awplus(config)# no auth-web-server page logo
```

**Validation Commands** `show auth-web-server page`

# auth-web-server page sub-title

**Overview** This command sets the custom sub-title on the web authentication page.

Use the **no** variant of this command to reset the sub-title to its default.

Note that if you need to customize the login page extensively, you can instead replace it with your own page. See “Customising the Login Page” in the [AAA and Port Authentication Feature Overview and Configuration Guide](#).

**Syntax** `auth-web-server page sub-title {hidden|text <sub-title>}`  
`no auth-web-server page sub-title`

| Parameter   | Description                  |
|-------------|------------------------------|
| hidden      | Hide the sub-title           |
| <sub-title> | Text string of the sub-title |

**Default** “Allied-Telesis” is displayed by default.

**Mode** Global Configuration

**Examples** To set the custom sub-title, use the commands:

```
awplus# configure terminal
awplus(config)# auth-web-server page sub-title text Web
Authentication
```

To hide the sub-title, use the commands:

```
awplus# configure terminal
awplus(config)# auth-web-server page sub-title hidden
```

To change back to the default title, use the commands:

```
awplus# configure terminal
awplus(config)# no auth-web-server page sub-title
```

**Validation Commands** `show auth-web-server page`

# auth-web-server page success-message

**Overview** This command sets the success message on the web-authentication page.

Use the **no** variant of this command to remove the success message.

Note that if you need to customize the login page extensively, you can instead replace it with your own page. See “Customising the Login Page” in the [AAA and Port Authentication Feature Overview and Configuration Guide](#).

**Syntax** `auth-web-server page success-message text <success-message>`  
`no auth-web-server page success-message`

| Parameter                            | Description                        |
|--------------------------------------|------------------------------------|
| <code>&lt;success-message&gt;</code> | Text string of the success message |

**Default** No success message is set by default.

**Mode** Global Configuration

**Examples** To set the success message on the web-authentication page, use the commands:

```
awplus# configure terminal
awplus(config)# auth-web-server page success-message text Your
success message
```

To unset the success message on the web-authentication page, use the commands:

```
awplus# configure terminal
awplus(config)# no auth-web-server page success-message
```

**Validation Commands** [show auth-web-server page](#)

# auth-web-server page title

**Overview** This command sets the custom title on the web authentication page.

Use the **no** variant of this command to remove the custom title.

Note that if you need to customize the login page extensively, you can instead replace it with your own page. See “Customising the Login Page” in the [AAA and Port Authentication Feature Overview and Configuration Guide](#).

**Syntax** `auth-web-server page title {hidden|text <title>}`  
`no auth-web-server page title`

| Parameter | Description              |
|-----------|--------------------------|
| hidden    | Hide the title           |
| <title>   | Text string of the title |

**Default** “Web Access Authentication Gateway” is displayed by default.

**Mode** Global Configuration

**Examples** To set the custom title on the web authentication page, use the commands:

```
awplus# configure terminal
awplus(config)# auth-web-server page title text Login
```

To hide the title on the web authentication page, use the commands:

```
awplus# configure terminal
awplus(config)# auth-web-server page title hidden
```

To unset the custom title on the web authentication page, use the commands:

```
awplus# configure terminal
awplus(config)# no auth-web-server page title
```

**Validation Commands** `show auth-web-server page`

# auth-web-server page welcome-message

**Overview** This command sets the welcome message on the web-authentication login page.

Use the **no** variant of this command to remove the welcome message.

Note that if you need to customize the login page extensively, you can instead replace it with your own page. See “Customising the Login Page” in the [AAA and Port Authentication Feature Overview and Configuration Guide](#).

**Syntax** `auth-web-server page welcome-message text <welcome-message>`  
`no auth-web-server page welcome-message`

| Parameter                            | Description                        |
|--------------------------------------|------------------------------------|
| <code>&lt;welcome-message&gt;</code> | Text string of the welcome message |

**Default** No welcome message is set by default.

**Mode** Global Configuration

**Examples** To set the welcome message on the web-authentication page, use the commands:

```
awplus# configure terminal
awplus(config)# auth-web-server page welcome-message text Your
welcome message
```

To remove the welcome message on the web-authentication page, use the commands:

```
awplus# configure terminal
awplus(config)# no auth-web-server page welcome-message
```

**Validation Commands** [show auth-web-server page](#)

# auth-web-server ping-poll enable

**Overview** This command enables the ping polling to the supplicant (client device) that is authenticated by Web-Authentication.

The **no** variant of this command disables the ping polling to the supplicant that is authenticated by Web-Authentication.

**Syntax** `auth-web-server ping-poll enable`  
`no auth-web-server ping-poll enable`

**Default** The ping polling feature for Web-Authentication is disabled by default.

**Mode** Global Configuration

**Examples** To enable the ping polling feature for Web-Authentication, use the following commands:

```
awplus# configure terminal
awplus(config)# auth-web-server ping-poll enable
```

To disable the ping polling feature for Web-Authentication, use the following commands:

```
awplus# configure terminal
awplus(config)# no auth-web-server ping-poll enable
```

**Validation Commands** `show auth`  
`show auth-web-server`  
`show running-config`

# auth-web-server ping-poll failcount

**Overview** This command sets a fail count for the ping polling feature when used with Web-Authentication. The **failcount** parameter specifies the number of unanswered pings. A supplicant (client device) is logged off when the number of unanswered pings are greater than the failcount set with this command.

Use the **no** variant of this command to resets the fail count for the ping polling feature to the default (5 pings).

**Syntax** `auth-web-server ping-poll failcount <1-100>`  
`no auth-web-server ping-poll failcount`

| Parameter | Description |
|-----------|-------------|
| <1-100>   | Count.      |

**Default** The default failcount for ping polling is 5 pings.

**Mode** Global Configuration

**Examples** To set the failcount of ping polling to 10 pings, use the following commands:

```
awplus# configure terminal
awplus(config)# auth-web-server ping-poll failcount 10
```

To set the failcount of ping polling to default, use the following commands:

```
awplus# configure terminal
awplus(config)# no auth-web-server ping-poll failcount
```

**Validation Commands** `show auth`  
`show auth-web-server`  
`show running-config`

# auth-web-server ping-poll interval

**Overview** This command is used to change the ping poll interval. The interval specifies the time period between pings when the supplicant (client device) is reachable.

Use the **no** variant of this command to reset to the default period for ping polling (30 seconds).

**Syntax** `auth-web-server ping-poll interval <1-65535>`  
`no auth-web-server ping-poll interval`

| Parameter | Description |
|-----------|-------------|
| <1-65535> | Seconds.    |

**Default** The interval for ping polling is 30 seconds by default.

**Mode** Global Configuration

**Examples** To set the interval of ping polling to 60 seconds, use the following commands:

```
awplus# configure terminal
awplus(config)# auth-web-server ping-poll interval 60
```

To set the interval of ping polling to the default (30 seconds), use the following commands:

```
awplus# configure terminal
awplus(config)# no auth-web-server ping-poll interval
```

**Validation Commands** `show auth`  
`show auth-web-server`  
`show running-config`



# auth-web-server ping-poll reauth-timer-refresh

**Overview** This command modifies the **reauth-timer-refresh** parameter for the Web-Authentication feature. The **reauth-timer-refresh** parameter specifies whether a re-authentication timer is reset and when the response from a supplicant (a client device) is received.

Use the **no** variant of this command to reset the **reauth-timer-refresh** parameter to the default setting (disabled).

**Syntax** `auth-web-server ping-poll reauth-timer-refresh`  
`no auth-web-server ping-poll reauth-timer-refresh`

**Default** The `reauth-timer-refresh` parameter is disabled by default.

**Mode** Global Configuration

**Examples** To enable the `reauth-timer-refresh` timer, use the following commands:

```
awplus# configure terminal
awplus(config)# auth-web-server ping-poll reauth-timer-refresh
```

To disable the `reauth-timer-refresh` timer, use the following commands:

```
awplus# configure terminal
awplus(config)# no auth-web-server ping-poll
reauth-timer-refresh
```

**Validation  
Commands** `show auth`  
`show auth-web-server`  
`show running-config`

# auth-web-server ping-poll timeout

**Overview** This command modifies the ping poll **timeout** parameter for the Web-Authentication feature. The **timeout** parameter specifies the time in seconds to wait for a response to a ping packet.

Use the **no** variant of this command to reset the timeout of ping polling to the default (1 second).

**Syntax** `auth-web-server ping-poll timeout <1-30>`  
`no auth-web-server ping-poll timeout`

| Parameter | Description |
|-----------|-------------|
| <1-30>    | Seconds.    |

**Default** The default timeout for ping polling is 1 second.

**Mode** Global Configuration

**Examples** To set the timeout of ping polling to 2 seconds, use the command:

```
awplus# configure terminal
awplus(config)# auth-web-server ping-poll timeout 2
```

To set the timeout of ping polling to the default (1 second), use the command:

```
awplus# configure terminal
awplus(config)# no auth-web-server ping-poll timeout
```

**Validation Commands** `show auth`  
`show auth-web-server`  
`show running-config`

# auth-web-server port

**Overview** This command sets the HTTP port number for the Web-Authentication server. Use the **no** variant of this command to reset the HTTP port number to the default (80).

**Syntax** `auth-web-server port <port-number>`  
`no auth-web-server port`

| Parameter                        | Description                                                                               |
|----------------------------------|-------------------------------------------------------------------------------------------|
| <code>&lt;port-number&gt;</code> | Set the local Web-Authentication server port within the TCP port number range 1 to 65535. |

**Default** The Web-Authentication server HTTP port number is set to 80 by default.

**Mode** Global Configuration

**Examples** To set the HTTP port number 8080 for the Web-Authentication server, use the following commands:

```
awplus# configure terminal
awplus(config)# auth-web-server port 8080
```

To reset to the default HTTP port number 80 for the Web-Authentication server, use the following commands:

```
awplus# configure terminal
awplus(config)# no auth-web-server port
```

**Validation Commands** `show auth`  
`show auth-web-server`  
`show running-config`

# auth-web-server redirect-delay-time

**Overview** Use this command to set the delay time in seconds before redirecting the supplicant to a specified URL when the supplicant is authorized.

Use the variant **no** to reset the delay time set previously.

**Syntax** `auth-web-server redirect-delay-time <5-60>`  
`no auth-web-server redirect-delay-time`

| Parameter                        | Description                                                                              |
|----------------------------------|------------------------------------------------------------------------------------------|
| <code>redirect-delay-time</code> | Set the delay time before jumping to a specified URL after the supplicant is authorized. |
| <code>&lt;5-60&gt;</code>        | The time in seconds.                                                                     |

**Default** The default redirect delay time is 5 seconds.

**Mode** Global Configuration

**Examples** To set the delay time to 60 seconds for the Web-Authentication server, use the following commands:

```
awplus# configure terminal
awplus(config)# auth-web-server redirect-delay-time 60
```

To reset the delay time, use the following commands:

```
awplus# configure terminal
awplus(config)# no auth-web-server redirect-delay-time
```

**Related Commands** [auth-web-server redirect-url](#)  
[show auth-web-server](#)  
[show running-config](#)

# auth-web-server redirect-url

**Overview** This command sets a URL for supplicant (client device) authentication. When a supplicant is authorized it will be automatically redirected to the specified URL. Note that if the http redirect feature is used then this command is ignored.

Use the **no** variant of this command to delete the URL string set previously.

**Syntax** `auth-web-server redirect-url <url>`  
`no auth-web-server redirect-url`

| Parameter                | Description                           |
|--------------------------|---------------------------------------|
| <code>&lt;url&gt;</code> | URL (hostname or dotted IP notation). |

**Default** The redirect URL for the Web-Authentication server feature is not set by default (null).

**Mode** Global Configuration

**Examples** To enable and set redirect a URL string `www.alliedtelesis.com` for the Web-Authentication server, use the following commands:

```
awplus# configure terminal
awplus(config)# auth-web-server redirect-url
http://www.alliedtelesis.com
```

To delete a redirect URL string, use the following commands:

```
awplus# configure terminal
awplus(config)# no auth-web-server redirect-url
```

**Related Commands** [auth-web-server redirect-delay-time](#)  
[show auth](#)  
[show auth-web-server](#)  
[show running-config](#)

# auth-web-server session-keep

**Overview** This command enables the session-keep feature to jump to the original URL after being authorized by Web-Authentication.

Use the **no** variant of this command to disable the session keep feature.

**Syntax** `auth-web-server session-keep`  
`no auth-web-server session-keep`

**Default** The session-keep feature is disabled by default.

**Mode** Global Configuration

**Usage** This function doesn't ensure to keep session information in all cases. Authenticated supplicant may be redirected to unexpected page when session-keep is enabled. This issue occurred by supplicant sending HTTP packets automatically after authentication page is displayed and the URL is written.

**Examples** To enable the session-keep feature, use the following commands:

```
awplus# configure terminal
awplus(config)# auth-web-server session-keep
```

To disable the session-keep feature, use the following commands:

```
awplus# configure terminal
awplus(config)# no auth-web-server session-keep
```

**Validation  
Commands** `show auth`  
`show auth-web-server`  
`show running-config`

# auth-web-server ssl

**Overview** This command enables HTTPS functionality for the Web-Authentication server feature.

Use the **no** variant of this command to disable HTTPS functionality for the Web-Authentication server.

**Syntax** `auth-web-server ssl`  
`no auth-web-server ssl`

**Default** HTTPS functionality for the Web-Authentication server feature is disabled by default.

**Mode** Global Configuration

**Examples** To enable HTTPS functionality for the Web-Authentication server feature, use the following commands:

```
awplus# configure terminal
awplus(config)# auth-web-server ssl
```

To disable HTTPS functionality for the Web-Authentication server feature, use the following commands:

```
awplus# configure terminal
awplus(config)# no auth-web-server ssl
```

**Validation Commands** `show auth`  
`show auth-web-server`  
`show running-config`

# auth-web-server ssl intercept-port

**Overview** Use this command to register HTTPS intercept port numbers when the HTTPS server uses custom port number (not TCP port number 443).

Note that you need to use the **auth-web-server intercept-port** command to register HTTP intercept port numbers.

Use the **no** variant of this command to delete registered port number.

**Syntax** `auth-web-server ssl intercept-port <1-65535>`  
`no auth-web-server ssl intercept-port <1-65535>`

| Parameter                    | Description                                       |
|------------------------------|---------------------------------------------------|
| <code>&lt;1-65535&gt;</code> | TCP port number in the range from 1 through 65535 |

**Default** 443/TCP is registered by default.

**Mode** Global Configuration

**Examples** To register HTTPS port number 3128, use the commands:

```
awplus# configure terminal
awplus(config)# auth-web-server ssl intercept-port 3128
```

To delete HTTPS port number 3128, use the commands:

```
awplus# configure terminal
awplus(config)# no auth-web-server ssl intercept-port 3128
```

**Validation Commands** `show auth-web-server`

**Related Commands** `auth-web-server intercept-port`



# copy proxy-autoconfig-file

**Overview** Use this command to download the proxy auto configuration (PAC) file to your switch. The Web-Authentication supplicant can get the downloaded file from the system web server.

**Syntax** `copy <filename> proxy-autoconfig-file`

| Parameter                     | Description              |
|-------------------------------|--------------------------|
| <code>&lt;filename&gt;</code> | The URL of the PAC file. |

**Mode** Privileged Exec

**Example** To download the PAC file to this device, use the command:

```
awplus# copy tftp://server/proxy.pac proxy-autoconfig-file
```

**Related Commands** [show proxy-autoconfig-file](#)  
[erase proxy-autoconfig-file](#)

# copy web-auth-https-file

**Overview** Use this command to download the SSL server certificate for web-based authentication. The file must be in PEM (Privacy Enhanced Mail) format, and contain the private key and the server certificate.

**Syntax** `copy <filename> web-auth-https-file`

| Parameter                     | Description                             |
|-------------------------------|-----------------------------------------|
| <code>&lt;filename&gt;</code> | The URL of the server certificate file. |

**Mode** Privileged Exec

**Example** To download the server certificate file `verisign_cert.pem` from the TFTP server directory `server`, use the command:

```
awplus# copy tftp://server/verisign_cert.pem
web-auth-https-file
```

**Related Commands**

- [auth-web-server ssl](#)
- [erase web-auth-https-file](#)
- [show auth-web-server](#)

# description (Authentication Profile)

**Overview** Use this command to add a description to an authentication profile in Authentication Profile mode.  
Use the **no** variant of this command to remove the current description.

**Syntax** `description <description>`

| Parameter                        | Description                                          |
|----------------------------------|------------------------------------------------------|
| <code>&lt;description&gt;</code> | Text describing the selected authentication profile. |

**Default** No description configured by default.

**Mode** Authentication Profile

**Example** To add a description to the authentication profile 'student', use the following commands:

```
awplus# configure terminal
awplus(config)# auth profile student
awplus(config-auth-profile)# description student room setting
```

To remove a description from the authentication profile 'student', use the following commands:

```
awplus# configure terminal
awplus(config)# auth profile student
awplus(config-auth-profile)# no description
```

**Related Commands** [auth profile \(Global Configuration\)](#)

# erase proxy-autoconfig-file

**Overview** Use this command to remove the proxy auto configuration file.

**Syntax** `erase proxy-autoconfig-file`

**Mode** Privileged Exec

**Example** To remove the proxy auto configuration file, use the command:

```
awplus# erase proxy-autoconfig-file
```

**Related  
Commands** [show proxy-autoconfig-file](#)  
[copy proxy-autoconfig-file](#)

# erase web-auth-https-file

**Overview** Use this command to remove the SSL server certificate for web-based authentication.

**Syntax** `erase web-auth-https-file`

**Mode** Privileged Exec

**Example** To remove the SSL server certificate file for web-based authentication use the command:

```
awplus# erase web-auth-https-file
```

**Related Commands**

- [auth-web-server ssl](#)
- [copy web-auth-https-file](#)
- [show auth-web-server](#)

# show auth

**Overview** This command shows the configuration state of authentication.

**Syntax** show auth [all]

| Parameter | Description                                                                                                                                                                           |
|-----------|---------------------------------------------------------------------------------------------------------------------------------------------------------------------------------------|
| all       | Display all authentication information for each authenticated interface. This can be a static channel (or static aggregator), or a dynamic (or LACP) channel group, or a switch port. |

**Mode** Privileged Exec

**Example** To display all authentication information, enter the command:

```
awplus# show auth all
```

**Output** Figure 42-1: Example output from the **show auth** command

```
awplus# show auth all
802.1X Port-Based Authentication Enabled
MAC-based Port Authentication Disabled
WEB-based Port Authentication Enabled
 RADIUS server address (auth): 150.87.17.192:1812
 Last radius message id: 4
Authentication Info for interface eth1 portEnabled: true - portControl: Auto
 portStatus: Authorized
 reAuthenticate: disabled
 reAuthPeriod: 3600
 PAE: quietPeriod: 60 - maxReauthReq: 2 - txPeriod: 30
 BE: suppTimeout: 30 - serverTimeout: 30
 CD: adminControlledDirections: in
 KT: keyTxEnabled: false
 critical: disabled
 guestVlan: disabled
 authFailVlan: disabled
 dynamicVlanCreation: disabled
 hostMode: single-host
 dot1x: enabled
 protocolVersion: 1
 authMac: disabled
 authWeb: enabled
 method: PAP
 maxAuthFail: 3
 packetForwarding:
 10.0.0.1 80/tcp
 dns
 dhcp
```

# show auth diagnostics

**Overview** This command shows authentication diagnostics, optionally for the specified interface, which may be an Ethernet port.

If no interface is specified then authentication diagnostics are shown for all interfaces.

**Syntax** `show auth diagnostics [interface <interface-list>]`

| Parameter        | Description                                                                                                                                                                                                                                                                                             |
|------------------|---------------------------------------------------------------------------------------------------------------------------------------------------------------------------------------------------------------------------------------------------------------------------------------------------------|
| interface        | Specify ports to show.                                                                                                                                                                                                                                                                                  |
| <interface-list> | The interfaces or ports to configure. An interface-list can be: <ul style="list-style-type: none"><li>• an interface (e.g. eth1)</li><li>• a continuous range of interfaces, e.g. eth1-2</li><li>• a comma-separated list of the above; e.g. eth1, eth2.</li></ul> The specified interfaces must exist. |

**Mode** Privileged Exec

**Example** To display authentication diagnostics for eth1, enter the command:

```
awplus# show auth diagnostics interface eth1
```

**Output** Figure 42-2: Example output from the **show auth diagnostics** command

```
Authentication
Diagnostics for interface eth1
Authentication Diagnostics
for interface port1.0.6
 Supplicant address: 00d0.59ab.7037
 authEnterConnecting: 2
 authEaplogoffWhileConnecting: 1
 authEnterAuthenticating: 2
 authSuccessWhileAuthenticating: 1
 authTimeoutWhileAuthenticating: 1
 authFailWhileAuthenticating: 0
 authEapstartWhileAuthenticating: 0
 authEaplogoggWhileAuthenticating: 0
 authReauthsWhileAuthenticated: 0
 authEapstartWhileAuthenticated: 0
 authEaplogoffWhileAuthenticated: 0
 BackendResponses: 2
 BackendAccessChallenges: 1
 BackendOtherrequestToSupplicant: 3
 BackendAuthSuccess: 1
```

# show auth interface

**Overview** This command shows the status of port authentication on the specified interface.

Use the optional **diagnostics** parameter to show authentication diagnostics for the specified interface. Use the optional **sessionstatistics** parameter to show authentication session statistics for the specified interface. Use the optional **statistics** parameter to show authentication diagnostics for the specified interface. Use the optional **supplicant** (client device) parameter to show the supplicant state for the specified interface.

**Syntax** `show auth interface <interface-list>  
[diagnostics|sessionstatistics|statistics|supplicant [brief]]`

| Parameter                           | Description                                                                                                                                                                                                                                                                                            |
|-------------------------------------|--------------------------------------------------------------------------------------------------------------------------------------------------------------------------------------------------------------------------------------------------------------------------------------------------------|
| <code>&lt;interface-list&gt;</code> | The interfaces or ports to configure. An interface-list can be: <ul style="list-style-type: none"><li>• an interface (e.g. eth1)</li><li>• a continuous range of interfaces, e.g. eth1-2</li><li>• a comma-separated list of the above; e.g. eth1, eth2</li></ul> The specified interfaces must exist. |
| <code>diagnostics</code>            | Diagnostics.                                                                                                                                                                                                                                                                                           |
| <code>sessionstatistics</code>      | Session statistics.                                                                                                                                                                                                                                                                                    |
| <code>statistics</code>             | Statistics.                                                                                                                                                                                                                                                                                            |
| <code>supplicant</code>             | Supplicant (client device).                                                                                                                                                                                                                                                                            |
| <code>brief</code>                  | Brief summary of supplicant state.                                                                                                                                                                                                                                                                     |

**Mode** Privileged Exec

**Example** To display the Port based authentication status for eth1, enter the command:

```
awplus# show auth interface eth1
```

If port-based authentication is not configured, the output will be

```
% Port-Control not configured on eth1
```

To display the Port based authentication status for eth1, enter the command:

```
awplus# show auth interface eth1
```



```
awplus# show auth interface eth1
Authentication Info for interface eth1
portEnabled: true - portControl: Auto
portStatus: Authorized
reAuthenticate: disabled
reAuthPeriod: 3600
PAE: quietPeriod: 60 - maxReauthReq: 2 - txPeriod: 30
BE: suppTimeout: 30 - serverTimeout: 30
CD: adminControlledDirections: in
KT: keyTxEnabled: false
critical: disabled
guestVlan: disabled
authFailVlan: disabled
dynamicVlanCreation: disabled
hostMode: single-host
dot1x: enabled
 protocolVersion: 1
authMac: disabled
authWeb: enabled
 method: PAP
 maxAuthFail: 3
 packetForwarding:
 10.0.0.1 80/tcp
 dns
 dhcp
twoStepAuthentication:
 configured: enabled
 actual: enabled
supplicantMac: none
```

To display Port-Authentication diagnostics for `eth1`, enter the command:

```
awplus# show auth interface eth1 diagnostics
```

```
Authentication Diagnostics for interface eth1

Supplicant address: 00d0.59ab.7037
authEnterConnecting: 2
authEaplogoffWhileConnecting: 1
 authEnterAuthenticating: 2
 authSuccessWhileAuthenticating: 1
 authTimeoutWhileAuthenticating: 1
 authFailWhileAuthenticating: 0
 authEapstartWhileAuthenticating: 0
 authEaplogoggWhileAuthenticating: 0
 authReauthsWhileAuthenticated: 0
 authEapstartWhileAuthenticated: 0
 authEaplogoffWhileAuthenticated: 0
BackendResponses: 2
BackendAccessChallenges: 1
BackendOtherrequestToSupplicant: 3
BackendAuthSuccess: 1
```

To display Port-Authentication session statistics for `eth1`, enter the command:

```
awplus# show auth interface eth1 sessionstatistics
```

```
Authentication
session
statistics for interface eth1
 session user name: manager
 session authentication method: Remote server
 session time: 19440 secs
 session terminat cause: Not terminated yet
```

To display Port-Authentication statistics for `eth1`, enter the command:

```
awplus# show auth statistics interface eth1
```

To display the Port-Authenticated supplicant on interface `eth1`, enter the command:

```
awplus# show auth interface eth1 supplicant
```

**Related  
Commands** [show auth diagnostics](#)

# show auth sessionstatistics

**Overview** This command shows authentication session statistics for the specified interface.

**Syntax** `show auth sessionstatistics [interface <interface-list>]`

| Parameter        | Description                                                                                                                                                                                                                                                                                            |
|------------------|--------------------------------------------------------------------------------------------------------------------------------------------------------------------------------------------------------------------------------------------------------------------------------------------------------|
| interface        | Specify ports to show.                                                                                                                                                                                                                                                                                 |
| <interface-list> | The interfaces or ports to configure. An interface-list can be: <ul style="list-style-type: none"><li>• an interface (e.g. eth1)</li><li>• a continuous range of interfaces, e.g. eth1-2</li><li>• a comma-separated list of the above; e.g. eth1, eth2</li></ul> The specified interfaces must exist. |

**Mode** Privileged Exec

**Example** To display authentication statistics for eth1, enter the command:

```
awplus# show auth sessionstatistics interface eth1
```

**Output** Figure 42-3: Example output from the **show auth sessionstatistics** command

```
Authentication
session statistics for interface eth1
 session user name: manager
 session authentication method: Remote server
 session time: 19440 secs
 session terminat cause: Not terminated yet
```

# show auth statistics interface

**Overview** This command shows the authentication statistics for the specified interface.

**Syntax** `show auth statistics interface <interface-list>`

| Parameter                           | Description                                                                                                                                                                                                                                                                                            |
|-------------------------------------|--------------------------------------------------------------------------------------------------------------------------------------------------------------------------------------------------------------------------------------------------------------------------------------------------------|
| <code>&lt;interface-list&gt;</code> | The interfaces or ports to configure. An interface-list can be: <ul style="list-style-type: none"><li>• an interface (e.g. eth1)</li><li>• a continuous range of interfaces, e.g. eth1-2</li><li>• a comma-separated list of the above; e.g. eth1, eth2</li></ul> The specified interfaces must exist. |

**Mode** Privileged Exec

**Example** To display Port-Authentication statistics for eth1, enter the command:

```
awplus# show auth statistics interface eth1
```

# show auth supplicant

**Overview** This command shows the supplicant (client device) state when authentication is configured for the switch. Use the optional **brief** parameter to show a summary of the supplicant state.

**Syntax** show auth supplicant [<macadd>] [brief]

| Parameter | Description                                                                             |
|-----------|-----------------------------------------------------------------------------------------|
| <macadd>  | Mac (hardware) address of the supplicant. Entry format is HHHH.HHHH.HHHH (hexadecimal). |
| brief     | Brief summary of the supplicant state.                                                  |

**Mode** Privileged Exec

**Examples** To display a summary of authenticated supplicant information on the device, enter the command:

```
awplus# show auth supplicant brief
```

To display authenticated supplicant information on the device, enter the command:

```
awplus# show auth supplicant
```

To display authenticated supplicant information for device with MAC address 0000.5E00.5301, enter the command:

```
awplus# show auth supplicant 0000.5E00.5301
```

**Output** Figure 42-4: Example output from **show auth supplicant brief**

```
awplus#show auth supplicant brief
Interface port2.0.3
 authenticationMethod: dot1x/mac/web
 Two-Step Authentication
 firstMethod: mac
 secondMethod: dot1x/web
 totalSupplicantNum: 1
 authorizedSupplicantNum: 1
 macBasedAuthenticationSupplicantNum: 0
 dot1xAuthenticationSupplicantNum: 0
 webBasedAuthenticationSupplicantNum: 1
 otherAuthenticationSupplicantNum: ORADIUS Group Configuration

Interface VID Mode MAC Address Status IP Address Username
===== == == ===== =
port2.0.3 1 W 001c.233e.e15a Authenticated 192.168.1.181 test
```

Figure 42-5: Example output from **show auth supplicant**

```
awplus#show auth supplicant
Interface port2.0.3
 authenticationMethod: dot1x/mac/web
 Two-Step Authentication
 firstMethod: mac
 secondMethod: dot1x/web
 totalSupplicantNum: 1
 authorizedSupplicantNum: 1
 macBasedAuthenticationSupplicantNum: 0
 dot1xAuthenticationSupplicantNum: 0
 webBasedAuthenticationSupplicantNum: 1
 otherAuthenticationSupplicantNum: 0

 Supplicant name: test
 Supplicant address: 0000.5E00.5301
 authenticationMethod: WEB-based Authentication
 Two-Step Authentication:
 firstAuthentication: Pass - Method: mac
 secondAuthentication: Pass - Method: web
 portStatus: Authorized - currentId: 1
 abort:F fail:F start:F timeout:F success:T
 PAE: state: Authenticated - portMode: Auto
 PAE: reAuthCount: 0 - rxRespId: 0
 PAE: quietPeriod: 60 - maxReauthReq: 2
 BE: state: Idle - reqCount: 0 - idFromServer: 0
 CD: adminControlledDirections: in - operControlledDirections: in
 CD: bridgeDetected: false
 KR: rxKey: false
 KT: keyAvailable: false - keyTxEnabled: false
 RADIUS server group (auth): radius
 RADIUS server (auth): 192.168.1.40
```

Figure 42-6: Example output from **show auth supplicant 0000.5E00.5301**

```
awplus#show auth supplicant 0000.5E00.5301
Interface port2.0.3
 Supplicant name: test
 Supplicant address: 0000.5E00.5301
 authenticationMethod: WEB-based Authentication
 Two-Step Authentication:
 firstAuthentication: Pass - Method: mac
 secondAuthentication: Pass - Method: web
 portStatus: Authorized - currentId: 1
 abort:F fail:F start:F timeout:F success:T
 PAE: state: Authenticated - portMode: Auto
 PAE: reAuthCount: 0 - rxRespId: 0
 PAE: quietPeriod: 60 - maxReauthReq: 2
 BE: state: Idle - reqCount: 0 - idFromServer: 0
 CD: adminControlledDirections: in - operControlledDirections: in
 CD: bridgeDetected: false
 KR: rxKey: false
 KT: keyAvailable: false - keyTxEnabled: false
 RADIUS server group (auth): radius
 RADIUS server (auth): 192.168.1.40
```

**Related  
Commands**   aaa accounting auth-web  
                  aaa authentication auth-web

# show auth supplicant interface

**Overview** This command shows the supplicant (client device) state for the authentication mode set for the interface. Use the optional **brief** parameter to show a summary of the supplicant state.

**Syntax** `show auth-web supplicant interface <interface-list> [brief]`

| Parameter                           | Description                                                                                                                                                                                                                                                                                            |
|-------------------------------------|--------------------------------------------------------------------------------------------------------------------------------------------------------------------------------------------------------------------------------------------------------------------------------------------------------|
| <code>&lt;interface-list&gt;</code> | The interfaces or ports to configure. An interface-list can be: <ul style="list-style-type: none"><li>• an interface (e.g. eth1)</li><li>• a continuous range of interfaces, e.g. eth1-2</li><li>• a comma-separated list of the above; e.g. eth1, eth2</li></ul> The specified interfaces must exist. |
| <code>brief</code>                  | Brief summary of the supplicant state.                                                                                                                                                                                                                                                                 |

**Mode** Privileged Exec

**Examples** To display the authenticated supplicant on the interface eth1, enter the command:

```
awplus# show auth supplicant interface eth1
```

To display brief summary output for the authenticated supplicant, enter the command:

```
awplus# show auth supplicant brief
```



# show auth-web-server

**Overview** This command shows the Web-Authentication server configuration and status on the switch.

**Syntax** `show auth-web-server`

**Mode** Privileged Exec

**Example** To display Web-Authentication server configuration and status, enter the command:

```
awplus# show auth-web-server
```

**Output** Figure 42-7: Example output from the **show auth-web-server** command

```
Web authentication server
 Server status: enabled
 Server mode: none
 Server address: 192.168.1.1/24
 DHCP server enabled
 DHCP lease time: 20
 DHCP WPAD Option URL: http://192.168.1.1/proxy.pac
 HTTP Port No: 80
 Security: disabled
 Certification: default
 SSL Port No: 443
 Redirect URL: --
 Redirect Delay Time: 5
 HTTP Redirect: enabled
 Session keep: disabled
 PingPolling: disabled
 PingInterval: 30
 Timeout: 1
 FailCount: 5
 ReauthTimerReFresh: disabled
```

**Related Commands**

- [auth-web-server ipaddress](#)
- [auth-web-server port](#)
- [auth-web-server redirect-delay-time](#)
- [auth-web-server redirect-url](#)
- [auth-web-server session-keep](#)
- [auth-web-server ssl](#)

# show auth-web-server page

**Overview** This command displays the web-authentication page configuration and status.

**Syntax** show auth-web-server page

**Mode** Privileged Exec

**Examples** To show the web-authentication page information, use the command:

```
awplus# show auth-web-server page
```

Figure 42-8: Example output from the **show auth-web-server page** command

```
awplus#show auth-web-server page
Web authentication page
 Logo: auto
 Title: default
 Sub-Title: Web Authentication
 Welcome message: Your welcome message
 Success message: Your success message
```

**Related  
Commands**

[auth-web forward](#)  
[auth-web-server page logo](#)  
[auth-web-server page sub-title](#)  
[auth-web-server page success-message](#)  
[auth-web-server page title](#)  
[auth-web-server page welcome-message](#)

# show proxy-autoconfig-file

**Overview** This command displays the contents of the proxy auto configuration (PAC) file.

**Syntax** show proxy-autoconfig-file

**Mode** Privileged Exec

**Example** To display the contents of the proxy auto configuration (PAC) file, enter the command:

```
awplus# show auth proxy-autoconfig-file
```

**Output** Figure 42-9: Example output from **show proxy-autoconfig-file**

```
function FindProxyForURL(url,host)
{
 if (isPlainHostName(host) ||
 isInNet(host, "192.168.1.0", "255.255.255.0")) {
 return "DIRECT";
 }
 else {
 return "PROXY 192.168.110.1:8080";
 }
}
```

**Related Commands** [copy proxy-autoconfig-file](#)  
[erase proxy-autoconfig-file](#)

# 43

# AAA Commands

## Introduction

**Overview** This chapter provides an alphabetical reference for AAA commands for Authentication, Authorization and Accounting. For more information, see the [AAA and Port\\_Authentication Feature Overview and Configuration Guide](#).

- Command List**
- [“aaa accounting auth-web”](#) on page 1926
  - [“aaa accounting commands”](#) on page 1928
  - [“aaa accounting login”](#) on page 1930
  - [“aaa authentication auth-web”](#) on page 1933
  - [“aaa authentication enable default group tacacs+”](#) on page 1935
  - [“aaa authentication enable default local”](#) on page 1937
  - [“aaa authentication login”](#) on page 1938
  - [“aaa authentication openvpn”](#) on page 1940
  - [“aaa authorization commands”](#) on page 1941
  - [“aaa authorization config-commands”](#) on page 1943
  - [“aaa group server”](#) on page 1944
  - [“aaa local authentication attempts lockout-time”](#) on page 1945
  - [“aaa local authentication attempts max-fail”](#) on page 1946
  - [“aaa login fail-delay”](#) on page 1947
  - [“accounting login”](#) on page 1948
  - [“authorization commands”](#) on page 1949
  - [“clear aaa local user lockout”](#) on page 1951
  - [“debug aaa”](#) on page 1952
  - [“login authentication”](#) on page 1953

- [“proxy-port”](#) on page 1954
- [“radius-secure-proxy aaa”](#) on page 1955
- [“server \(radsecproxy-aaa\)”](#) on page 1956
- [“server mutual-authentication”](#) on page 1958
- [“server name-check”](#) on page 1959
- [“server trustpoint”](#) on page 1960
- [“show aaa local user locked”](#) on page 1962
- [“show aaa server group”](#) on page 1963
- [“show debugging aaa”](#) on page 1964
- [“show radius server group”](#) on page 1965
- [“undebug aaa”](#) on page 1967

# aaa accounting auth-web

**Overview** This command configures an accounting method list for Web-based authentication. An accounting method list specifies what type of accounting messages are sent and which RADIUS servers the accounting messages are sent to. Use this command to configure either the default method list, which is automatically applied to interfaces with Web-based authentication enabled, or a named method list, which can be applied to an interface with the [auth-web accounting](#) command.

Use the **no** variant of this command to disable either the default or a named accounting method list for Web-based authentication. Once all method lists are disabled, AAA accounting for Web-based authentication is disabled globally.

**Syntax**

```
aaa accounting auth-web {default|<list-name>}
{start-stop|stop-only|none} group {<group-name>|radius}
no aaa accounting auth-web {default|<list-name>}
```

| Parameter    | Description                                                                                                               |
|--------------|---------------------------------------------------------------------------------------------------------------------------|
| default      | Configure the default accounting method list                                                                              |
| <list-name>  | Configure a named accounting method list                                                                                  |
| start-stop   | Sends a start accounting message at the beginning of the session and a stop accounting message at the end of the session. |
| stop-only    | Only sends a stop accounting message at the end of the session.                                                           |
| none         | No accounting record sent.                                                                                                |
| group        | Use a server group                                                                                                        |
| <group-name> | Server group name.                                                                                                        |
| radius       | Use all RADIUS servers.                                                                                                   |

**Default** RADIUS accounting for Web-based authentication is disabled by default.

**Mode** Global Configuration

**Usage** This command can be used to configure either the default accounting method list or a named accounting method list:

- **default:** the default accounting method list which is automatically applied to all interfaces with Web-based authentication enabled.
- **<list-name>:** a user named list which can be applied to an interface using the [auth-web accounting](#) command.

There are two ways to define servers where RADIUS accounting messages are sent:

- **group radius:** use all RADIUS servers configured by [radius-server host](#) command

- **group** <group-name>: use the specified RADIUS server group configured with the `aaa group server` command

Configure the accounting event to be sent to the RADIUS server with the following options:

- **start-stop**: sends a start accounting message at the beginning of a session and a stop accounting message at the end of the session.
- **stop-only**: sends a stop accounting message at the end of a session.
- **none**: disables accounting.

**Examples** To enable the default RADIUS accounting method for Web-based authentication, and use all available RADIUS servers, use the commands:

```
awplus# configure terminal
awplus(config)# aaa accounting auth-web default start-stop
group radius
```

To disable the default RADIUS accounting method for Web-based authentication, use the commands:

```
awplus# configure terminal
awplus(config)# no aaa accounting auth-web default
```

To enable a named RADIUS accounting method list 'example\_acct' for Web-based authentication, with the RADIUS server group 'rad\_group\_example', use the commands:

```
awplus# configure terminal
awplus(config)# aaa accounting auth-web example_acct start-stop
group rad_group_example
```

To disable a named RADIUS accounting method list 'example\_acct' for Web-based authentication, use the commands:

```
awplus# configure terminal
awplus(config)# no aaa accounting auth-web example_acct
```

**Related Commands**

- [aaa authentication auth-web](#)
- [aaa group server](#)
- [auth-web accounting](#)
- [auth-web enable](#)
- [radius-server host](#)
- [show aaa server group](#)

# aaa accounting commands

**Overview** This command configures and enables TACACS+ accounting on commands entered at a specified privilege level. Once enabled for a privilege level, accounting messages for commands entered at that privilege level will be sent to a TACACS+ server.

In order to account for all commands entered on a device, configure command accounting for each privilege level separately.

The command accounting message includes, the command as entered, the date and time the command finished executing, and the user-name of the user who executed the command.

Use the **no** variant of this command to disable command accounting for a specified privilege level.

**Syntax** `aaa accounting commands <1-15> default stop-only group tacacs+`  
`no aaa accounting commands <1-15> default`

| Parameter | Description                                                                                                        |
|-----------|--------------------------------------------------------------------------------------------------------------------|
| <1-15>    | The privilege level being configured, in the range 1 to 15.                                                        |
| default   | Use the default method list, this means the command is applied globally to all user exec sessions.                 |
| stop-only | Send accounting message when the commands have stopped executing.                                                  |
| group     | Specify the server group where accounting messages are sent. Only the tacacs+ group is available for this command. |
| tacacs+   | Use all TACACS+ servers configured by the <code>tacacs-server host</code> command.                                 |

**Default** TACACS+ command accounting is disabled by default.

**Mode** Global Configuration

**Usage** This command only supports a **default** method list, this means that it is applied to every console and VTY line.

The **stop-only** parameter indicates that the command accounting messages are sent to the TACACS+ server when the commands have stopped executing.

The **group tacacs+** parameters signifies that the command accounting messages are sent to the TACACS+ servers configured by the `tacacs-server host` command.

Note that up to four TACACS+ servers can be configured for accounting. The servers are checked for reachability in the order they are configured with only the first reachable server being used. If no server is found, the accounting message is dropped.



Command accounting cannot coexist with triggers. An error message is displayed if you attempt to enable command accounting while a trigger is configured. Likewise, an error message is displayed if you attempt to configure a trigger while command accounting is configured.

**Examples** To configure command accounting for privilege levels 1, 7, and 15, use the following commands:

```
awplus# configure terminal
awplus(config)# aaa accounting commands 1 default stop-only
group tacacs+
awplus(config)# aaa accounting commands 7 default stop-only
group tacacs+
awplus(config)# aaa accounting commands 15 default stop-only
group tacacs+
```

To disable command accounting for privilege levels 1, 7, and 15, use the following commands:

```
awplus# configure terminal
awplus(config)# no aaa accounting commands 1 default
awplus(config)# no aaa accounting commands 7 default
awplus(config)# no aaa accounting commands 15 default
```

**Related  
Commands**

- [aaa authentication login](#)
- [aaa accounting login](#)
- [accounting login](#)
- [tacacs-server host](#)

# aaa accounting login

**Overview** This command configures RADIUS and TACACS+ accounting for login shell sessions. The specified method list name can be used by the **accounting login** command in the Line Configuration mode. If the **default** parameter is specified, then this creates a default method list that is applied to every console and VTY line, unless another accounting method list is applied on that line.

Note that unlimited RADIUS servers and up to four TACACS+ servers can be configured and consulted for accounting. The first server configured is regarded as the primary server and if the primary server fails then the backup servers are consulted in turn. A backup server is consulted if the primary server fails, i.e. is unreachable.

Use the **no** variant of this command to remove an accounting method list for login shell sessions configured by an **aaa accounting login** command. If the method list being deleted is already applied to a console or VTY line, accounting on that line will be disabled. If the default method list name is removed by this command, it will disable accounting on every line that has the default accounting configuration.

**Syntax**

```
aaa accounting login
{default|<list-name>} {start-stop|stop-only|none} {group
{radius|tacacs+|<group-name>}}

no aaa accounting login {default|<list-name>}
```

| Parameter    | Description                                                                                           |
|--------------|-------------------------------------------------------------------------------------------------------|
| default      | Default accounting method list.                                                                       |
| <list-name>  | Named accounting method list.                                                                         |
| start-stop   | Start and stop records to be sent.                                                                    |
| stop-only    | Stop records to be sent.                                                                              |
| none         | No accounting record to be sent.                                                                      |
| group        | Specify the servers or server group where accounting packets are sent.                                |
| radius       | Use all RADIUS servers configured by the <a href="#">radius-server host</a> command.                  |
| tacacs+      | Use all TACACS+ servers configured by the <a href="#">tacacs-server host</a> command.                 |
| <group-name> | Use the specified RADIUS server group, as configured by the <a href="#">aaa group server</a> command. |

**Default** Accounting for login shell sessions is disabled by default.

**Mode** Global Configuration

**Usage** This command enables you to define a named accounting method list. The items that you define in the accounting options are:

- the types of accounting packets that will be sent
- the set of servers to which the accounting packets will be sent

You can define a default method list with the name **default** and any number of other named method lists. The name of any method list that you define can then be used as the *<list-name>* parameter in the [accounting login](#) command.

If the method list name already exists, the command will replace the existing configuration with the new one.

There are two ways to define servers where RADIUS accounting messages are sent:

- **group radius** : use all RADIUS servers configured by [radius-server host](#) command
- **group <group-name>** : use the specified RADIUS server group configured with the [aaa group server](#) command

There is one way to define servers where TACACS+ accounting messages are sent:

- **group tacacs+** : use all TACACS+ servers configured by [tacacs-server host](#) command

The accounting event to send to the RADIUS or TACACS+ server is configured with the following options:

- **start-stop** : sends a **start** accounting message at the beginning of a session and a **stop** accounting message at the end of the session.
- **stop-only** : sends a **stop** accounting message at the end of a session.
- **none** : disables accounting.

**Examples** To configure RADIUS accounting for login shell sessions, use the following commands:

```
awplus# configure terminal
awplus(config)# aaa accounting login default start-stop group
radius
```

To configure TACACS+ accounting for login shell sessions, use the following commands:

```
awplus# configure terminal
awplus(config)# aaa accounting login default start-stop group
tacacs+
```

To reset the configuration of the default accounting list, use the following commands:

```
awplus# configure terminal
awplus(config)# no aaa accounting login default
```

**Related  
Commands**

- [aaa accounting commands](#)
- [aaa authentication login](#)
- [aaa accounting login](#)
- [accounting login](#)
- [radius-server host](#)
- [tacacs-server host](#)

# aaa authentication auth-web

**Overview** This command enables Web-based authentication globally and allows you to enable either the default authentication method list (in this case, a list of RADIUS servers), which is automatically applied to every interface running Web-based authentication, or a user named authentication method list, which is applied to an interface with the [auth-web authentication](#) command.

Use the **no** variant of this command to disable either the default or a named method list for Web-based authentication. Once all method lists are disabled Web-based authentication is disabled globally.

**Syntax**

```
aaa authentication auth-web {default|<list-name>} group
{<group-name>|radius}

no aaa authentication auth-web {default|<list-name>}
```

| Parameter    | Description                                      |
|--------------|--------------------------------------------------|
| default      | Configure the default authentication method list |
| <list-name>  | Configure a named authentication method list     |
| group        | Use a server group                               |
| <group-name> | Server group name.                               |
| radius       | Use all RADIUS servers.                          |

**Default** Web-based authentication is disabled by default.

**Mode** Global Configuration

**Usage** This command can be used to configure either the default authentication method list or a named authentication method list:

- **default:** the default authentication method list which is automatically applied to all interfaces with Web-based authentication enabled.
- **<list-name>:** a user named list which can be applied to an interface using the [auth-web authentication](#) command.

There are two ways to define servers where RADIUS accounting messages are sent:

- **group radius:** use all RADIUS servers configured by [radius-server host](#) command
- **group <group-name>:** use the specified RADIUS server group configured with the [aaa group server](#) command

Note that you need to configure an IPv4 address for the VLAN interface on which Web authentication is running.

**Examples** To enable Web-based authentication globally for all RADIUS servers, and use all available RADIUS servers, use the commands:

```
awplus# configure terminal
awplus(config)# aaa authentication auth-web default group
radius
```

To disable Web-based authentication, use the commands:

```
awplus# configure terminal
awplus(config)# no aaa authentication auth-web default
```

To enable Web-based authentication for named list 'example\_auth', with RADIUS server group 'rad\_group\_example, use the commands:

```
awplus# configure terminal
awplus(config)# aaa authentication auth-web example_auth group
rad_group_example
```

To disable Web-based authentication for named list 'example\_auth', use the commands:

```
awplus# configure terminal
awplus(config)# no aaa authentication example_auth
```

**Related  
Commands**

- [aaa accounting auth-web](#)
- [aaa group server](#)
- [auth-web authentication](#)
- [radius-server host](#)

# aaa authentication enable default group tacacs+

**Overview** This command enables AAA authentication to determine the privilege level a user can access for passwords authenticated against the TACACS+ server.

Use the **no** variant of this command to disable privilege level authentication.

**Syntax** `aaa authentication enable default group tacacs+ [local] [none]`  
`no aaa authentication enable default`

| Parameter | Description                                                                                      |
|-----------|--------------------------------------------------------------------------------------------------|
| local     | Use the locally configured enable password ( <b>enable password</b> command) for authentication. |
| none      | No authentication.                                                                               |

**Default** Local privilege level authentication is enabled by default ([aaa authentication enable default local](#) command).

**Mode** Global Configuration

**Usage** A user is configured on a TACACS+ server with a maximum privilege level. When they enter the [enable \(Privileged Exec mode\)](#) command they are prompted for an enable password which is authenticated against the TACACS+ server. If the password is correct and the specified privilege level is equal to or less than the users maximum privilege level, then they are granted access to that level. If the user attempts to access a privilege level that is higher than their maximum configured privilege level, then the authentication session will fail and they will remain at their current privilege level.

**NOTE:** If both **local** and **none** are specified, you must always specify **local** first.

If the TACACS+ server goes offline, or is not reachable during enable password authentication, and command level authentication is configured as:

- **aaa authentication enable default group tacacs+**  
then the user is never granted access to Privileged Exec mode.
- **aaa authentication enable default group tacacs+ local**  
then the user is authenticated using the locally configured enable password, which if entered correctly grants the user access to Privileged Exec mode. If no enable password is locally configured (**enable password** command), then the enable authentication will fail until the TACACS+ server becomes available again.

- **aaa authentication enable default group tacacs+ none**  
then the user is granted access to Privileged Exec mode with no authentication. This is true even if a locally configured enable password is configured.
- **aaa authentication enable default group tacacs+ local none**  
then the user is authenticated using the locally configured enable password. If no enable password is locally configured, then the enable authentication will grant access to Privileged Exec mode with no authentication.

If the password for the user is not successfully authenticated by the server, then the user is again prompted for an enable password when they enter **enable** via the CLI.

**Examples** To enable a privilege level authentication method that will not allow the user to access Privileged Exec mode if the TACACS+ server goes offline, or is not reachable during enable password authentication, use the following commands:

```
awplus# configure terminal
awplus(config)# aaa authentication enable default group tacacs+
```

To enable a privilege level authentication method that will allow the user to access Privileged Exec mode if the TACACS+ server goes offline, or is not reachable during enable password authentication, and a locally configured enable password is configured, use the following commands:

```
awplus# configure terminal
awplus(config)# aaa authentication enable default group tacacs+
local
```

To disable privilege level authentication, use the following commands:

```
awplus# configure terminal
awplus(config)# no aaa authentication enable default
```

**Related Commands**

- [aaa authentication login](#)
- [aaa authentication enable default local](#)
- [enable \(Privileged Exec mode\)](#)
- [enable password](#)
- [enable secret](#)
- [tacacs-server host](#)



# aaa authentication enable default local

**Overview** This command enables AAA authentication to determine the privilege level a user can access for passwords authenticated locally.

**Syntax** `aaa authentication enable default local`

**Default** Local privilege level authentication is enabled by default.

**Mode** Global Configuration

**Usage** The privilege level configured for a particular user in the local user database is the privilege threshold above which the user is prompted for an [enable \(Privileged Exec mode\)](#) command.

**Examples** To enable local privilege level authentication command, use the following commands:

```
awplus# configure terminal
awplus(config)# aaa authentication enable default local
```

To disable privilege level authentication, use the following commands:

```
awplus# configure terminal
awplus(config)# no aaa authentication enable default
```

**Related Commands**

- [aaa authentication enable default group tacacs+](#)
- [aaa authentication login](#)
- [enable \(Privileged Exec mode\)](#)
- [enable password](#)
- [enable secret](#)
- [tacacs-server host](#)

# aaa authentication login

**Overview** Use this command to create an ordered list of methods to use to authenticate user login, or to replace an existing method list with the same name. Specify one or more of the options **local** or **group**, in the order you want them to be applied. If the **default** method list name is specified, it is applied to every console and VTY line immediately unless another method list is applied to that line by the [login authentication](#) command. To apply a non-default method list, you must also use the [login authentication](#) command.

Use the **no** variant of this command to remove an authentication method list for user login. The specified method list name is deleted from the configuration. If the method list name has been applied to any console or VTY line, user login authentication on that line will fail.

Note that the **no aaa authentication login default** command does not remove the default method list. This will return the default method list to its default state (**local** is the default).

**Syntax**

```
aaa authentication login {default|<list-name>} {[local] [group
{radius|tacacs+|<group-name>}]}
no aaa authentication login {default|<list-name>}
```

| Parameter    | Description                                                                                           |
|--------------|-------------------------------------------------------------------------------------------------------|
| default      | Set the default authentication server for user login.                                                 |
| <list-name>  | Name of authentication server.                                                                        |
| local        | Use the local username database.                                                                      |
| group        | Use server group.                                                                                     |
| radius       | Use all RADIUS servers configured by the <a href="#">radius-server host</a> command.                  |
| tacacs+      | Use all TACACS+ servers configured by the <a href="#">tacacs-server host</a> command.                 |
| <group-name> | Use the specified RADIUS server group, as configured by the <a href="#">aaa group server</a> command. |

**Default** If the default server is not configured using this command, user login authentication uses the local user database only.

If the **default** method list name is specified, it is applied to every console and VTY line immediately unless a named method list server is applied to that line by the **login authentication** command.

**local** is the default state for the default method list unless a named method list is applied to that line by the **login authentication** command. Reset to the default method list using the **no aaa authentication login default** command.

**Mode** Global Configuration

**Usage** When a user attempts to log in, the switch sends an authentication request to the first authentication server in the method list. If the first server in the list is reachable and it contains a username and password matching the authentication request, the user is authenticated and the login succeeds. If the authentication server denies the authentication request because of an incorrect username or password, the user login fails. If the first server in the method list is unreachable, the switch sends the request to the next server in the list, and so on.

For example, if the method list specifies **group tacacs+ local**, and a user attempts to log in with a password that does not match a user entry in the first TACACS+ server, if this TACACS+ server denies the authentication request, then the switch does not try any other TACACS+ servers not the local user database; the user login fails.

**Examples** To configure the default authentication method list for user login to first use all available RADIUS servers for user login authentication, and then use the local user database, use the following commands:

```
awplus# configure terminal
awplus(config)# aaa authentication login default group radius
local
```

To configure a user login authentication method list called **USERS** to first use the RADIUS server group `RAD_GROUP1` for user login authentication, and then use the local user database, use the following commands:

```
awplus# configure terminal
awplus(config)# aaa authentication login USERS group RAD_GROUP1
local
```

To configure a user login authentication method list called **USERS** to first use the TACACS+ servers for user login authentication, and then use the local user database, use the following commands:

```
awplus# configure terminal
awplus(config)# aaa authentication login USERS group tacacs+
local
```

To return to the default method list (**local** is the default server), use the following commands:

```
awplus# configure terminal
awplus(config)# no aaa authentication login default
```

To delete an existing authentication method list **USERS** created for user login authentication, use the following commands:

```
awplus# configure terminal
awplus(config)# no aaa authentication login USERS
```

**Related Commands** [aaa accounting commands](#)  
[aaa authentication enable default group tacacs+ login authentication](#)

# aaa authentication openvpn

**Overview** This command enables RADIUS authentication of OpenVPN tunnels globally. It is automatically applied to every OpenVPN tunnel interface.

Use the **no** variant of this command to globally disable RADIUS authentication of OpenVPN tunnels.

**Syntax** `aaa authentication openvpn default group {<group-name>|radius}`  
`no aaa authentication openvpn default`

| Parameter    | Description             |
|--------------|-------------------------|
| radius       | Use all RADIUS servers. |
| <group-name> | Server group name.      |

**Default** RADIUS authentication of OpenVPN tunnels is disabled by default.

**Mode** Global Configuration

**Usage** Use the **no** variant of this command to reset the default authentication method for OpenVPN tunnels, to its default, that is, to use the group **radius**, containing all RADIUS servers configured by the **radius-server host** command.

Note that if the default authentication method is used, all OpenVPN tunnels will use the group **radius**, containing all RADIUS servers.

There are two ways to define servers where RADIUS accounting messages are sent:

- **group radius** : use all RADIUS servers configured by [radius-server host](#) command
- **group <group-name>** : use the specified RADIUS server group configured with the [aaa group server](#) command

**Examples** To enable RADIUS authentication of OpenVPN tunnels globally and use all available RADIUS servers, use the commands:

```
awplus# configure terminal
awplus(config)# aaa authentication openvpn default group radius
```

To disable RADIUS authentication of OpenVPN tunnels, use the commands:

```
awplus# configure terminal
awplus(config)# no aaa authentication openvpn default
```

**Related Commands** [aaa group server](#)  
[radius-server host](#)

# aaa authorization commands

**Overview** This command configures a method list for commands authorization that can be applied to console or VTY lines. When command authorization is enabled for a privilege level, only authorized users can executed commands in that privilege level.

Use the **no** variant of this command to remove a named method list or disable the default method list for a privilege level.

**Syntax**

```
aaa authorization commands <privilege-level>
{default|<list-name>} group tacacs+ [none]

no aaa authorization commands <privilege-level>
{default|<list-name>}
```

| Parameter         | Description                                                                                                                                                                                                                                                                                                                                                                                                                                                                                  |
|-------------------|----------------------------------------------------------------------------------------------------------------------------------------------------------------------------------------------------------------------------------------------------------------------------------------------------------------------------------------------------------------------------------------------------------------------------------------------------------------------------------------------|
| <privilege-level> | The privilege level of the set of commands the method list will be applied to. AlliedWare Plus defines three sets of commands, that are indexed by a level value:<br><b>Level = 1:</b> All commands that can be accessed by a user with privilege level between 1 and 6 inclusive<br><b>Level = 7:</b> All commands that can be accessed by a user with privilege level between 7 and 14 inclusive<br><b>Level = 15:</b> All commands that can be accessed by a user with privilege level 15 |
| group             | Specify the server group where authorization messages are sent. Only the <code>tacacs+</code> group is available for this command.                                                                                                                                                                                                                                                                                                                                                           |
| tacacs+           | Use all TACACS+ servers configured by the <code>tacacs-server host</code> command.                                                                                                                                                                                                                                                                                                                                                                                                           |
| default           | Configure the default authorization commands method list.                                                                                                                                                                                                                                                                                                                                                                                                                                    |
| <list-name>       | Configure a named authorization commands method list                                                                                                                                                                                                                                                                                                                                                                                                                                         |
| none              | If specified, this provides a local fallback to command authorization so that if authorization servers become unavailable then the device will accept all commands normally allowed for the privilege level of the user.                                                                                                                                                                                                                                                                     |

**Mode** Global Configuration

**Usage** TACACS+ command authorization provides centralized control of the commands available to a user of an AlliedWare Plus device. Once enabled:

- The command string and username are encrypted and sent to the first available configured TACACS+ server (the first server configured) for authorization.

- The TACACS+ server decides if the user is authorized to execute the command and returns the decision to the AlliedWare Plus device.
- Depending on this decision the device will then either execute the command or notify the user that authorization has failed.

If multiple TACACS+ servers are configured, and the first server is unreachable or does not respond, the other servers will be queried, in turn, for an authorization decision. If all servers are unreachable and a local fallback has been configured, with the **none** parameter, then commands are authorized based on the user's privilege level; the same behavior as if command authorization had not been configured. If, however, the local fallback is not configured and all servers become unreachable then all commands except **logout**, **exit**, and **quit** will be denied.

The **default** method list is defined with a local fallback unless configured differently using this command.

**Example** To configure a commands authorization method list, named TAC15, using all TACACS+ servers to authorize commands for privilege level 15, with a local fallback, use the following commands:

```
awplus# configure terminal
awplus(config)# aaa authorization commands 15 TAC15 group
tacacs+ none
```

To configure the default method list to authorize commands for privilege level 7, with no local fallback, use the following commands:

```
awplus# configure terminal
awplus(config)# aaa authorization commands 7 default group
tacacs+
```

To remove the authorization method list TAC15, use the following commands:

```
awplus# configure terminal
awplus(config)# no aaa authorization commands 15 TAC15
```

**Related Commands** [aaa authorization config-commands](#)  
[authorization commands](#)  
[tacacs-server host](#)

**Command changes** Version 5.4.6-2.1: command added

# aaa authorization config-commands

**Overview** Use this command to enable command authorization on configuration mode commands. By default, command authorization applies to commands in exec mode only.

Use the **no** variant of this command to disable command authorization on configuration mode commands.

**Syntax** `aaa authorization config-commands`  
`no aaa authorization config-commands`

**Default** By default, command authorization is disabled on configuration mode commands.

**Mode** Global Configuration

**Usage** If authorization of configuration mode commands is not enabled then all configuration commands are accepted by default, including command authorization commands.

**NOTE:** *Authorization of configuration commands is required for a secure TACACS+ command authorization configuration as it prevents the feature from being disabled to gain access to unauthorized exec mode commands.*

**Example** To enable command authorization for configuration mode commands, use the commands:

```
awplus# configure terminal
awplus(config)# aaa authorization config-commands
```

To disable command authorization for configuration mode commands, use the commands:

```
awplus# configure terminal
awplus(config)# no aaa authorization config-commands
```

**Related Commands** [aaa authorization commands](#)  
[authorization commands](#)  
[tacacs-server host](#)

**Command changes** Version 5.4.6-2.1: command added

# aaa group server

**Overview** This command configures a RADIUS server group. A server group can be used to specify a subset of RADIUS servers in **aaa** commands. The group name **radius** is predefined, which includes all RADIUS servers configured by the **radius-server host** command.

RADIUS servers are added to a server group using the **server** command. Each RADIUS server should be configured using the **radius-server host** command.

Use the **no** variant of this command to remove an existing RADIUS server group.

**Syntax** `aaa group server radius <group-name>`  
`no aaa group server radius <group-name>`

| Parameter                       | Description        |
|---------------------------------|--------------------|
| <code>&lt;group-name&gt;</code> | Server group name. |

**Mode** Global Configuration

**Usage** Use this command to create an AAA group of RADIUS servers, and to enter Server Group Configuration mode, in which you can add servers to the group. Use a server group to specify a subset of RADIUS servers in AAA commands. Each RADIUS server must be configured by the **radius-server host** command. To add RADIUS servers to a server group, use the **server** command.

**Examples** To create a RADIUS server group named `GROUP1` with hosts `192.168.1.1`, `192.168.2.1` and `192.168.3.1`, use the commands:

```
awplus(config)# aaa group server radius GROUP1
awplus(config-sg)# server 192.168.1.1 auth-port 1812 acct-port 1813
awplus(config-sg)# server 192.168.2.1 auth-port 1812 acct-port 1813
awplus(config-sg)# server 192.168.3.1 auth-port 1812 acct-port 1813
```

To remove a RADIUS server group named `GROUP1` from the configuration, use the command:

```
awplus(config)# no aaa group server radius GROUP1
```

**Related Commands**

- [aaa accounting login](#)
- [aaa authentication login](#)
- [radius-server host](#)
- [server \(Server Group\)](#)
- [show radius server group](#)



# aaa local authentication attempts lockout-time

**Overview** This command configures the duration of the user lockout period.

Use the **no** variant of this command to restore the duration of the user lockout period to its default of 300 seconds (5 minutes).

**Syntax** `aaa local authentication attempts lockout-time <lockout-time>`  
`no aaa local authentication attempts lockout-time`

| Parameter                         | Description                                                         |
|-----------------------------------|---------------------------------------------------------------------|
| <code>&lt;lockout-time&gt;</code> | <code>&lt;0-10000&gt;</code> . Time in seconds to lockout the user. |

**Mode** Global Configuration

**Default** The default for the lockout-time is 300 seconds (5 minutes).

**Usage** While locked out all attempts to login with the locked account will fail. The lockout can be manually cleared by another privileged account using the [clear aaa local user lockout](#) command.

**Examples** To configure the lockout period to 10 minutes (600 seconds), use the commands:

```
awplus# configure terminal
awplus(config)# aaa local authentication attempts lockout-time
600
```

To restore the default lockout period of 5 minutes (300 seconds), use the commands:

```
awplus# configure terminal
awplus(config)# no aaa local authentication attempts
lockout-time
```

**Related Commands** [aaa local authentication attempts max-fail](#)

# aaa local authentication attempts max-fail

**Overview** This command configures the maximum number of failed login attempts before a user account is locked out. Every time a login attempt fails the failed login counter is incremented.

Use the **no** variant of this command to restore the maximum number of failed login attempts to the default setting (five failed login attempts).

**Syntax** `aaa local authentication attempts max-fail <failed-logins>`  
`no aaa local authentication attempts max-fail`

| Parameter                          | Description                                                                             |
|------------------------------------|-----------------------------------------------------------------------------------------|
| <code>&lt;failed-logins&gt;</code> | <code>&lt;1-32&gt;</code> . Number of login failures allowed before locking out a user. |

**Mode** Global Configuration

**Default** The default for the maximum number of failed login attempts is five failed login attempts.

**Usage** When the failed login counter reaches the limit configured by this command that user account is locked out for a specified duration configured by the [aaa local authentication attempts lockout-time](#) command.

When a successful login occurs the failed login counter is reset to 0. When a user account is locked out all attempts to login using that user account will fail.

**Examples** To configure the number of login failures that will lock out a user account to two login attempts, use the commands:

```
awplus# configure terminal
awplus(config)# aaa local authentication attempts max-fail 2
```

To restore the number of login failures that will lock out a user account to the default number of login attempts (five login attempts), use the commands:

```
awplus# configure terminal
awplus(config)# no aaa local authentication attempts max-fail
```

**Related Commands** [aaa local authentication attempts lockout-time](#)  
[clear aaa local user lockout](#)

# aaa login fail-delay

**Overview** Use this command to configure the minimum time period between failed login attempts. This setting applies to login attempts via the console, SSH and Telnet. Use the **no** variant of this command to reset the minimum time period to its default value.

**Syntax** `aaa login fail-delay [<1-10>]`  
`no aaa login fail-delay [<1-10>]`

| Parameter | Description                                                   |
|-----------|---------------------------------------------------------------|
| <1-10>    | The minimum number of seconds required between login attempts |

**Default** 1 second

**Mode** Global configuration

**Example** To apply a delay of at least 5 seconds between login attempts, use the following commands:

```
awplus# configure terminal
awplus(config)# aaa login fail-delay 5
```

**Related Commands** [aaa authentication login](#)

# accounting login

**Overview** This command applies a login accounting method list to console or VTY lines for user login. When login accounting is enabled using this command, logging events generate an accounting record to the accounting server.

The accounting method list must be configured first using this command. If an accounting method list is specified that has not been created by this command then accounting will be disabled on the specified lines.

The **no** variant of this command resets AAA Accounting applied to console or VTY lines for local or remote login. **default** login accounting is applied after issuing the **no accounting login** command. Accounting is disabled with **default**.

**Syntax** `accounting login {default|<list-name>}`  
`no accounting login`

| Parameter   | Description                     |
|-------------|---------------------------------|
| default     | Default accounting method list. |
| <list-name> | Named accounting method list.   |

**Default** By default login accounting is disabled in the **default** accounting server. No accounting will be performed until accounting is enabled using this command.

**Mode** Line Configuration

**Examples** To apply the accounting server `USERS` to all VTY lines, use the following commands:

```
awplus# configure terminal
awplus(config)# line vty 0 32
awplus(config-line)# accounting login USERS
```

To reset accounting for login sessions on the console, use the following commands:

```
awplus# configure terminal
awplus(config)# line console 0
awplus(config-line)# no accounting login
```

**Related Commands** [aaa accounting commands](#)  
[aaa accounting login](#)

# authorization commands

**Overview** This command applies a command authorization method list, defined using the [aaa authorization commands](#) command, to console and VTY lines.

Use the **no** variant of this command to reset the command authorization configuration on the console and VTY lines.

**Syntax** `authorization commands <privilege-level> {default|<list-name>}`  
`no authorization commands <privilege-level>`

| Parameter                            | Description                                                                                                                                                                                                                                                                                                                                                                                                                                                                                     |
|--------------------------------------|-------------------------------------------------------------------------------------------------------------------------------------------------------------------------------------------------------------------------------------------------------------------------------------------------------------------------------------------------------------------------------------------------------------------------------------------------------------------------------------------------|
| <code>&lt;privilege-level&gt;</code> | The privilege level of the set of commands the method list will be applied to.<br>AlliedWare Plus defines three sets of commands, that are indexed by a level value:<br><b>Level = 1:</b> All commands that can be accessed by a user with privilege level between 1 and 6 inclusive<br><b>Level = 7:</b> All commands that can be accessed by a user with privilege level between 7 and 14 inclusive<br><b>Level = 15:</b> All commands that can be accessed by a user with privilege level 15 |
| <code>default</code>                 | Configure the default authorization commands method list.                                                                                                                                                                                                                                                                                                                                                                                                                                       |
| <code>&lt;list-name&gt;</code>       | Configure a named authorization commands method list                                                                                                                                                                                                                                                                                                                                                                                                                                            |

**Default** The **default** method list is applied to each console and VTY line by default.

**Mode** Line Configuration

**Usage** If the specified method list does not exist users will not be able to execute any commands in the specified method list on the specified VTY lines.

**Example** To apply the TAC15 command authorization method list with privilege level 15 to VTY lines 0 to 5, use the following commands:

```
awplus# configure terminal
awplus(config)# line vty 0 5
awplus(config-line)# authorization commands 15 TAC15
```

To reset the command authorization configuration with privilege level 15 on VTY lines 0 to 5, use the following commands:

```
awplus# configure terminal
awplus(config)# line vty 0 5
awplus(config-line)# no authorization commands 15
```

**Related Commands** [aaa authorization commands](#)

aaa authorization config-commands

tacacs-server host

**Command changes** Version 5.4.6-2.1: command added

# clear aaa local user lockout

**Overview** Use this command to clear the lockout on a specific user account or all user accounts.

**Syntax** `clear aaa local user lockout {username <username>|all}`

| Parameter  | Description                           |
|------------|---------------------------------------|
| username   | Clear lockout for the specified user. |
| <username> | Specifies the user account.           |
| all        | Clear lockout for all user accounts.  |

**Mode** Privileged Exec

**Examples** To unlock the user account 'bob' use the following command:

```
awplus# clear aaa local user lockout username bob
```

To unlock all user accounts use the following command:

```
awplus# clear aaa local user lockout all
```

**Related Commands** [aaa local authentication attempts lockout-time](#)

# debug aaa

**Overview** This command enables AAA debugging.  
Use the **no** variant of this command to disable AAA debugging.

**Syntax** debug aaa [accounting|all|authentication|authorization]  
no debug aaa [accounting|all|authentication|authorization]

| Parameter      | Description                        |
|----------------|------------------------------------|
| accounting     | Accounting debugging.              |
| all            | All debugging options are enabled. |
| authentication | Authentication debugging.          |
| authorization  | Authorization debugging.           |

**Default** AAA debugging is disabled by default.

**Mode** Privileged Exec

**Examples** To enable authentication debugging for AAA, use the command:

```
awplus# debug aaa authentication
```

To disable authentication debugging for AAA, use the command:

```
awplus# no debug aaa authentication
```

**Related Commands** [show debugging aaa](#)  
[undebug aaa](#)



# login authentication

**Overview** Use this command to apply an AAA server for authenticating user login attempts from a console or remote logins on these console or VTY lines. The authentication method list must be specified by the **aaa authentication login** command. If the method list has not been configured by the **aaa authentication login** command, login authentication will fail on these lines.

Use the **no** variant of this command to reset AAA Authentication configuration to use the default method list for login authentication on these console or VTY lines.

**Command Syntax**

```
login authentication {default|<list-name>}
no login authentication
```

| Parameter   | Description                                                                                                                                                                                                        |
|-------------|--------------------------------------------------------------------------------------------------------------------------------------------------------------------------------------------------------------------|
| default     | The default authentication method list. If the default method list has not been configured by the <a href="#">aaa authentication login</a> command, the local user database is used for user login authentication. |
| <list-name> | Named authentication server.                                                                                                                                                                                       |

**Default** The default login authentication method list, as specified by the [aaa authentication login](#) command, is used to authenticate user login. If this has not been specified, the default is to use the local user database.

**Mode** Line Configuration

**Examples** To apply the authentication method list called `CONSOLE` to the console port terminal line (asyn 0), use the following commands:

```
awplus# configure terminal
awplus(config)# line console 0
awplus(config-line)# login authentication CONSOLE
```

To reset user authentication configuration on all VTY lines, use the following commands:

```
awplus# configure terminal
awplus(config)# line vty 0 32
awplus(config-line)# no login authentication
```

**Related Commands** [aaa authentication login](#)  
[line](#)

# proxy-port

**Overview** Use this command to change the local UDP port used for communication between local RADIUS client applications and the RadSecProxy AAA application. Any unused UDP port may be selected. The default port is 1645.

Use the **no** variant of this command to change the UDP port back to the default of 1645.

**Syntax** `proxy-port <port>`  
`no proxy-port`

| Parameter                 | Description               |
|---------------------------|---------------------------|
| <code>&lt;port&gt;</code> | UDP Port Number, 1-65536. |

**Default** The default port is 1645.

**Mode** RadSecProxy AAA Configuration Mode

**Usage** It is not necessary to change the value from the default unless UDP port 1645 is required for another purpose. RADIUS requests received on this port from external devices will be ignored. The port is only used for local (intra-device) communication.

**Example** To configure change the UDP port to 7001, use the following commands:

```
awplus# configure terminal
awplus(config)# radius-secure-proxy aaa
awplus(config-radsecproxy-aaa)# proxy-port 7001
```

**Related Commands** [radius-secure-proxy aaa](#)  
[server \(radsecproxy-aaa\)](#)  
[server name-check](#)  
[server trustpoint](#)

# radius-secure-proxy aaa

**Overview** Use this command to enter the RadSecProxy AAA (authentication, authorization, and accounting) application configuration mode. This application allows local RADIUS-based clients on system to communicate with remote RadSec servers via a secure (TLS) proxy.

**Syntax** `radius-secure-proxy aaa`

**Mode** Global Configuration Mode

**Example** To change mode from User Exec mode to the RadSecProxy AAA configuration mode, use the commands:

```
awplus# configure terminal
awplus(config)# radius-secure-proxy aaa
awplus(config-radsecproxy-aaa)#
```

**Related Commands**

- [proxy-port](#)
- [server \(radsecproxy-aaa\)](#)
- [server name-check](#)
- [server trustpoint](#)

# server (radsecproxy-aaa)

**Overview** Use this command to add a server to the RadSecProxy AAA application. Local RADIUS client applications will attempt, via the proxy, to communicate with any RadSec servers that are operational (in addition to any non-TLS RADIUS servers that are configured).

Use the **no** variant of this command to delete a previously-configured server from the RadSecProxy AAA application.

**Syntax** `server {<hostname>|<ip-addr>} [timeout <1-1000>] [name-check {on|off}]`

`no server {<hostname>|<ip-addr>}`

| Parameter                     | Description                                                                                                                                                                     |
|-------------------------------|---------------------------------------------------------------------------------------------------------------------------------------------------------------------------------|
| <code>&lt;hostname&gt;</code> | Hostname of RadSec server                                                                                                                                                       |
| <code>&lt;ip-addr&gt;</code>  | Specify the client IPv4 address, in dotted decimal notation (A.B.C.D).                                                                                                          |
| <code>timeout</code>          | Specify the amount of time that the RadSecProxy AAA application should wait before receiving replies from this server. RADIUS server timeout (which defaults to 5 seconds).     |
| <code>&lt;1-1000&gt;</code>   | Time in seconds to wait for a server reply.                                                                                                                                     |
| <code>name-check</code>       | Specify whether or not to enforce certificate name checking for this client. If the parameter is not specified then the global behavior, which defaults to <b>on</b> , is used. |
| <code>on</code>               | Enable name checking for this client.                                                                                                                                           |
| <code>off</code>              | Disable name checking for this client.                                                                                                                                          |

**Mode** RadSecProxy AAA Configuration Mode

**Usage** The server may be specified by its domain name or by its IPv4 address. If a domain name is used, it must be resolvable using a configured DNS name server.

Each server may be configured with a timeout; if not specified, the global timeout value for RADIUS servers will be used. The global timeout may be changed using the **radius-server timeout** command. The default global timeout is 5 seconds.

Each server may be configured to use certificate name-checking; if not specified, the global behavior defined by **server name-check** or **no server name-check** will be used. If name checking is enabled, the Common Name portion of the subject field of the server's X.509 certificate must match the domain name or IP address specified in this command.

**Example** To add a server which waits 3 seconds before receiving replies, use the commands:

```
awplus# configure terminal
awplus(config)# radius-secure-proxy aaa
awplus(config-radsecproxy-aaa)# client mynas.local name-check
off
```

**Related  
Commands**

- proxy-port
- radius-secure-proxy aaa
- server name-check
- server trustpoint

# server mutual-authentication

**Overview** This command enables or disables mutual certificate authentication for all RadSecProxy servers. When enabled, the RadSecProxy AAA application will send a local X.509 certificate to the server when establishing a TLS connection.

Use the **no** variant of this command to disable mutual certificate validation causing the RadSecProxy AAA application to not transmit a certificate to the server.

**NOTE:** *If mutual authentication is disabled on the client (AAA) application but enabled on the server, a connection will not be established.*

**Syntax** `server mutual-authentication`  
`no server mutual-authentication`

**Default** Mutual authentication is enabled by default.

**Mode** RadSecProxy AAA Configuration Mode

**Example** Disable mutual certificate validation with the following command:

```
awplus# configure terminal
awplus(config)# radius-secure-proxy aaa
awplus(config-radsecproxy-aaa)# no server
mutual-authentication
```

**Related  
Commands** [radius-secure-proxy aaa](#)  
[server name-check](#)  
[server \(radsecproxy-aaa\)](#)

**Command  
changes** Version 5.4.6-2.1: command added

# server name-check

**Overview** This command sets the global behavior for certificate name-checking for the RadSecProxy AAA application to **on**. This behavior will be used for all servers associated with the application that do not specify a behavior on a per-server basis. If name-checking is enabled, the Common Name portion of the subject field of the client's X.509 certificate must match the domain name or IP address specified in the **server (radsecproxy-aaa)** command.

Use the **no** variant of this command to set the global behavior for certificate name checking to **off**

**Syntax** `server name-check`  
`no server name-check`

**Default** Certificate name checking is on by default.

**Mode** RadSecProxy AAA Configuration Mode

**Example** Disable certificate name checking globally with the following command:

```
awplus# configure terminal
awplus(config)# radius-secure-proxy aaa
awplus(config-radsecproxy-aaa)# no server name-check
```

**Related Commands** [proxy-port](#)  
[radius-secure-proxy aaa](#)  
[server \(radsecproxy-aaa\)](#)  
[server trustpoint](#)

# server trustpoint

**Overview** This command adds one or more trustpoints to be used with the RadSecProxy AAA application. Multiple trustpoints may be specified, or the command may be executed more than once, to add multiple trustpoints to the application.

The **no** version of this command removes one or more trustpoints from the list of trustpoints associated with the application.

**Syntax** `server trustpoint [<trustpoint-list>]`  
`no server trustpoint [<trustpoint-list>]`

| Parameter         | Description                                             |
|-------------------|---------------------------------------------------------|
| <trustpoint-list> | Specify one or more trustpoints to be added or deleted. |

**Default** By default, no trustpoints are associated with the application.

**Mode** RadSecProxy AAA Configuration Mode

**Usage** The device certificate associated with first trustpoint added to the application will be transmitted to remote servers. The certificate received from the remote server must have an issuer chain that terminates with the root CA certificate for any of the trustpoints that are associated with the application.

If no trustpoints are specified in the command, the trustpoint list will be unchanged.

If **no server trustpoint** is issued without specifying any trustpoints, then all trustpoints will be disassociated from the application.

**Example** You can add multiple trustpoints to the RadSecProxy AAA application by executing the command multiple times:

```
awplus# configure terminal
awplus(config)# radius-secure-proxy aaa
awplus(config-radsecproxy-aaa)# server trustpoint example_1
awplus(config-radsecproxy-aaa)# server trustpoint example_2
```

Alternatively, add multiple trustpoints with a single command:

```
awplus(config-radsecproxy-aaa)# server trustpoint example_3
example_4
```

Disassociate all trustpoints from the RadSecProxy AAA application using the command:

```
awplus(config-radsecproxy-aaa)# no server trustpoint
```

**Related Commands** [proxy-port](#)  
[radius-secure-proxy aaa](#)



server (radsecproxy-aaa)  
server name-check

# show aaa local user locked

**Overview** This command displays the current number of failed attempts, last failure time and location against each user account attempting to log into the device.

Note that once the lockout count has been manually cleared by another privileged account using the [clear aaa local user lockout](#) command or a locked account successfully logs into the system after waiting for the lockout time, this command will display nothing for that particular account.

**Syntax** `show aaa local user locked`

**Mode** User Exec and Privileged Exec

**Example** To display the current failed attempts for local users, use the command:

```
awplus# show aaa local user locked
```

**Output** Figure 43-1: Example output from the **show aaa local user locked** command

```
awplus# show aaa local user locked
Login Failures Latest failure From
bob 3 05/23/14 16:21:37 ttyS0
manager 5 05/23/14 16:31:44 192.168.1.200
```

**Related Commands**

- [aaa local authentication attempts lockout-time](#)
- [aaa local authentication attempts max-fail](#)
- [clear aaa local user lockout](#)

# show aaa server group

**Overview** Use this command to list AAA users and any method lists applied to them.

**Syntax** show aaa server group

**Mode** Privileged Exec

**Example** To show the AAA configuration on a device, use the command:

```
awplus# aaa server group
```

**Output** Figure 43-2: Example output from **aaa server group**

```
awplus#show aaa server group
```

| User     | List Name       | Method          | Acct-Event       |
|----------|-----------------|-----------------|------------------|
| login    | auth default    | -               | local -          |
| login    | acct -          | -               | -                |
| auth-web | auth default    | radius          | group -          |
| auth-web | auth list1_auth | rad_group_list1 | group -          |
| auth-web | auth list2_auth | rad_group_list2 | group -          |
| auth-web | acct list1_acct | rad_group_list1 | group start-stop |
| auth-web | acct list2_acct | rad_group_list2 | group start-stop |

**Related Commands** [aaa accounting auth-web](#)  
[aaa authentication auth-web](#)

# show debugging aaa

**Overview** This command displays the current debugging status for AAA (Authentication, Authorization, Accounting).

**Syntax** `show debugging aaa`

**Mode** User Exec and Privileged Exec

**Example** To display the current debugging status of AAA, use the command:

```
awplus# show debug aaa
```

**Output** Figure 43-3: Example output from the **show debug aaa** command

```
AAA debugging status:
Authentication debugging is on
Accounting debugging is off
```

# show radius server group

**Overview** Use this command to show the RADIUS server group configuration.

**Syntax** show radius server group [<group-name>]

| Parameter    | Description               |
|--------------|---------------------------|
| <group-name> | RADIUS server group name. |

**Default** Command name is set to something by default.

**Mode** Privileged Exec

**Usage** Use this command with the <group-name> parameter to display information for a specific RADIUS server group, or without the parameter to display information for all RADIUS server groups.

**Example** To display information for all RADIUS server groups, use the command:

```
awplus# show radius server group
```

To display a information for a RADIUS server group named 'rad\_group\_list1', use the command:

```
awplus# show radius server group rad_group_list1
```

**Output** Figure 43-4: Example output from **show radius server group**

```
awplus#show radius server group
RADIUS Group Configuration
 Group Name : radius?
 Server Host/ Auth Acct Auth Acct
 IP Address Port Port Status Status

 192.168.1.101 1812 1813 Active Active
 192.168.1.102 1812 1813 Active Active

 Group Name : rad_group_list1
 Server Host/ Auth Acct Auth Acct
 IP Address Port Port Status Status

 192.168.1.101 1812 1813 Active Active

 Group Name : rad_group_list2
 Server Host/ Auth Acct Auth Acct
 IP Address Port Port Status Status

 192.168.1.102 1812 1813 Active Active
```

Figure 43-5: Example output from **show radius server group rad\_group\_list1**

```
awplus#show radius server group rad_group_list1
RADIUS Group Configuration
 Group Name : rad_group_list1
 Server Host/ Auth Acct Auth Acct
 IP Address Port Port Status Status

 192.168.1.101 1812 1813 Active Active
```

**Related  
Commands**    [aaa group server](#)

# undebbug aaa

**Overview** This command applies the functionality of the **no debug aaa** command.

# 44

# RADIUS Commands

## Introduction

**Overview** This chapter provides an alphabetical reference for commands used to configure the device to use RADIUS servers. For more information, see the [RADIUS Feature Overview and Configuration Guide](#).

- Command List**
- “[deadtime \(RADIUS server group\)](#)” on page 1969
  - “[debug radius](#)” on page 1970
  - “[ip radius source-interface](#)” on page 1971
  - “[radius-server deadtime](#)” on page 1972
  - “[radius-server host](#)” on page 1973
  - “[radius-server key](#)” on page 1976
  - “[radius-server retransmit](#)” on page 1977
  - “[radius-server timeout](#)” on page 1979
  - “[server \(Server Group\)](#)” on page 1981
  - “[show debugging radius](#)” on page 1983
  - “[show radius](#)” on page 1984
  - “[undebug radius](#)” on page 1987



# deadtime (RADIUS server group)

**Overview** Use this command to configure the **deadtime** parameter for the RADIUS server group. This command overrides the global dead-time configured by the [radius-server deadtime](#) command. The configured deadtime is the time period in minutes to skip a RADIUS server for authentication or accounting requests if the server is “dead”. Note that a RADIUS server is considered “dead” if there is no response from the server within a defined time period.

Use the **no** variant of this command to reset the deadtime configured for the RADIUS server group. If the global deadtime for RADIUS server is configured the value will be used for the servers in the group. The global deadtime for the RADIUS server is set to 0 minutes by default.

**Syntax** `deadtime <0-1440>`  
`no deadtime`

| Parameter                   | Description                |
|-----------------------------|----------------------------|
| <code>&lt;0-1440&gt;</code> | Amount of time in minutes. |

**Default** The deadtime is set to 0 minutes by default.

**Mode** Server Group Configuration

**Usage** If the RADIUS server does not respond to a request packet, the packet is retransmitted the number of times configured for the **retransmit** parameter (after waiting for a **timeout** period to expire). The server is then marked “dead”, and the time is recorded. The **deadtime** parameter configures the amount of time to skip a dead server; if a server is dead, no request message is sent to the server for the **deadtime** period.

**Examples** To configure the deadtime for 5 minutes for the RADIUS server group “GROUP1”, use the command:

```
awplus(config)# aaa group server radius GROUP1
awplus(config-sg)# server 192.168.1.1
awplus(config-sg)# deadtime 5
```

To remove the deadtime configured for the RADIUS server group “GROUP1”, use the command:

```
awplus(config)# aaa group server radius GROUP1
awplus(config-sg)# no deadtime
```

**Related Commands** [aaa group server](#)  
[radius-server deadtime](#)

# debug radius

**Overview** This command enables RADIUS debugging. If no option is specified, all debugging options are enabled.

Use the **no** variant of this command to disable RADIUS debugging. If no option is specified, all debugging options are disabled.

**Syntax** debug radius [packet|event|all]  
no debug radius [packet|event|all]

| Parameter | Description                                          |
|-----------|------------------------------------------------------|
| packet    | Debugging for RADIUS packets is enabled or disabled. |
| event     | Debugging for RADIUS events is enabled or disabled.  |
| all       | Enable or disable all debugging options.             |

**Default** RADIUS debugging is disabled by default.

**Mode** Privileged Exec

**Examples** To enable debugging for RADIUS packets, use the command:

```
awplus# debug radius packet
```

To enable debugging for RADIUS events, use the command:

```
awplus# debug radius event
```

To disable debugging for RADIUS packets, use the command:

```
awplus# no debug radius packet
```

To disable debugging for RADIUS events, use the command:

```
awplus# no debug radius event
```

**Related Commands** [show debugging radius](#)  
[undebug radius](#)

# ip radius source-interface

**Overview** This command configures the source IP address of every outgoing RADIUS packet to use a specific IP address or the IP address of a specific interface. If the specified interface is down or there is no IP address on the interface, then the source IP address of outgoing RADIUS packets depends on the interface the packets leave.

Use the **no** variant of this command to remove the source interface configuration. The source IP address in outgoing RADIUS packets will be the IP address of the interface from which the packets are sent.

**Syntax** `ip radius source-interface {<interface>|<ip-address>}`  
`no ip radius source-interface`

| Parameter                       | Description                                      |
|---------------------------------|--------------------------------------------------|
| <code>&lt;interface&gt;</code>  | Interface name.                                  |
| <code>&lt;ip-address&gt;</code> | IP address in the dotted decimal format A.B.C.D. |

**Default** Source IP address of outgoing RADIUS packets depends on the interface the packets leave.

**Mode** Global Configuration

**Examples** To configure all outgoing RADIUS packets to use the IP address of the interface "vlan1" for the source IP address, use the following commands:

```
awplus# configure terminal
awplus(config)# ip radius source-interface vlan1
```

To configure the source IP address of all outgoing RADIUS packets to use 192.168.1.10, use the following commands:

```
awplus# configure terminal
awplus(config)# ip radius source-interface 192.168.1.10
```

To reset the source interface configuration for all outgoing RADIUS packets, use the following commands:

```
awplus# configure terminal
awplus(config)# no ip radius source-interface
```

**Related Commands** [radius-server host](#)

# radius-server deadtime

**Overview** Use this command to specify the global **deadtime** for all RADIUS servers. If a RADIUS server is considered dead, it is skipped for the specified deadtime. This command specifies for how many minutes a RADIUS server that is not responding to authentication requests is passed over by requests for RADIUS authentication.

Use the **no** variant of this command to reset the global deadtime to the default of 0 seconds, so that RADIUS servers are not skipped even if they are dead.

**Syntax** `radius-server deadtime <minutes>`  
`no radius-server deadtime`

| Parameter                    | Description                                                          |
|------------------------------|----------------------------------------------------------------------|
| <code>&lt;minutes&gt;</code> | RADIUS server deadtime in minutes in the range 0 to 1440 (24 hours). |

**Default** The default RADIUS deadtime configured on the system is 0 seconds.

**Mode** Global Configuration

**Usage** The RADIUS client considers a RADIUS server to be dead if it fails to respond to a request after it has been retransmitted as often as specified globally by the [radius-server retransmit](#) command or for the server by the [radius-server host](#) command. To improve RADIUS response times when some servers may be unavailable, set a **deadtime** to skip dead servers.

**Examples** To set the dead time of the RADIUS server to 60 minutes, use the following commands:

```
awplus# configure terminal
awplus(config)# radius-server deadtime 60
```

To disable the dead time of the RADIUS server, use the following commands:

```
awplus# configure terminal
awplus(config)# no radius-server deadtime
```

**Related Commands** [deadtime \(RADIUS server group\)](#)  
[radius-server host](#)  
[radius-server retransmit](#)

# radius-server host

**Overview** Use this command to specify a remote RADIUS server host for authentication or accounting, and to set server-specific parameters. The parameters specified with this command override the corresponding global parameters for RADIUS servers. This command specifies the IP address or host name of the remote RADIUS server host and assigns authentication and accounting destination UDP port numbers.

This command adds the RADIUS server address and sets parameters to the RADIUS server. The RADIUS server is added to the running configuration after you issue this command. If parameters are not set using this command then common system settings are applied.

Use the **no** variant of this command to remove the specified server host as a RADIUS authentication and/or accounting server and set the destination port to the default RADIUS server port number (1812).

**Syntax**

```
radius-server host {<host-name>|<ip-address>} [acct-port <0-65535>] [auth-port <0-65535>] [key <key-string>] [retransmit <0-100>] [timeout <1-1000>]
```

```
no radius-server host {<host-name>|<ip-address>} [acct-port <0-65535>] [auth-port <0-65535>]
```

| Parameter    | Description                                                                                                                                                                                                     |
|--------------|-----------------------------------------------------------------------------------------------------------------------------------------------------------------------------------------------------------------|
| <host-name>  | Server host name. The DNS name of the RADIUS server host.                                                                                                                                                       |
| <ip-address> | The IP address of the RADIUS server host.                                                                                                                                                                       |
| acct-port    | Accounting port. Specifies the UDP destination port for RADIUS accounting requests. If 0 is specified, the server is not used for accounting. The default UDP port for accounting is 1813.                      |
| <0-65535>    | UDP port number<br>(Accounting port number is set to 1813 by default)<br>Specifies the UDP destination port for RADIUS accounting requests. If 0 is specified, the host is not used for accounting.             |
| auth-port    | Authentication port. Specifies the UDP destination port for RADIUS authentication requests. If 0 is specified, the server is not used for authentication. The default UDP port for authentication is 1812.      |
| <0-65535>    | UDP port number<br>(Authentication port number is set to 1812 by default)<br>Specifies the UDP destination port for RADIUS authentication requests. If 0 is specified, the host is not used for authentication. |
| timeout      | Specifies the amount of time to wait for a response from the server. If this parameter is not specified the global value configured by the <b>radius-server timeout</b> command is used.                        |

| Parameter    | Description                                                                                                                                                                                                                                                                                                                                                                                                                                                                                                                                                                                                      |
|--------------|------------------------------------------------------------------------------------------------------------------------------------------------------------------------------------------------------------------------------------------------------------------------------------------------------------------------------------------------------------------------------------------------------------------------------------------------------------------------------------------------------------------------------------------------------------------------------------------------------------------|
| <1-1000>     | Time in seconds to wait for a server reply (timeout is set to 5 seconds by default)<br>The time interval (in seconds) to wait for the RADIUS server to reply before retransmitting a request or considering the server dead. This setting overrides the global value set by the <b>radius-server timeout</b> command.<br>If no timeout value is specified for this server, the global value is used.                                                                                                                                                                                                             |
| retransmit   | Specifies the number of retries before skip to the next server. If this parameter is not specified the global value configured by the <b>radius-server retransmit</b> command is used.                                                                                                                                                                                                                                                                                                                                                                                                                           |
| <0-100>      | Maximum number of retries (maximum number of retries is set to 3 by default)<br>The maximum number of times to resend a RADIUS request to the server, if it does not respond within the timeout interval, before considering it dead and skipping to the next RADIUS server. This setting overrides the global setting of the <b>radius-server retransmit</b> command.<br>If no retransmit value is specified, the global value is used.                                                                                                                                                                         |
| key          | Set shared secret key with RADIUS servers                                                                                                                                                                                                                                                                                                                                                                                                                                                                                                                                                                        |
| <key-string> | Shared key string applied<br>Specifies the shared secret authentication or encryption key for all RADIUS communications between this device and the RADIUS server. This key must match the encryption used on the RADIUS daemon. All leading spaces are ignored, but spaces within and at the end of the string are used. If spaces are used in the string, do not enclose the string in quotation marks unless the quotation marks themselves are part of the key. This setting overrides the global setting of the <b>radius-server key c</b> command. If no key value is specified, the global value is used. |

**Default** The RADIUS client address is not configured (null) by default. No RADIUS server is configured.

**Mode** Global Configuration

**Usage** Multiple **radius-server host** commands can be used to specify multiple hosts. The software searches for hosts in the order they are specified. If no host-specific timeout, retransmit, or key values are specified, the global values apply to that host. If there are multiple RADIUS servers for this client, use this command multiple times—once to specify each server.

If you specify a host without specifying the auth port or the acct port, it will by default be configured for both authentication and accounting, using the default UDP ports. To set a host to be a RADIUS server for authentication requests only, set the **acct-port** parameter to 0; to set the host to be a RADIUS server for accounting requests only, set the auth-port parameter to 0.

A RADIUS server is identified by IP address, authentication port and accounting port. A single host can be configured multiple times with different authentication or accounting ports. All the RADIUS servers configured with this command are

included in the predefined RADIUS server group radius, which may be used by AAA authentication, authorization and accounting commands. The client transmits (and retransmits, according to the **retransmit** and **timeout** parameters) RADIUS authentication or accounting requests to the servers in the order you specify them, until it gets a response.

**Examples** To add the RADIUS server 10.0.0.20, use the following commands:

```
awplus# configure terminal
awplus(config)# radius-server host 10.0.0.20
```

To set the secret key to **allied** on the RADIUS server 10.0.0.20, use the following commands:

```
awplus# configure terminal
awplus(config)# radius-server host 10.0.0.20 key allied
```

To delete the RADIUS server 10.0.0.20, use the following commands:

```
awplus# configure terminal
awplus(config)# no radius-server host 10.0.0.20
```

To configure rad1.company.com for authentication only, use the following commands:

```
awplus# configure terminal
awplus(config)# radius-server host rad1.company.com acct-port 0
```

To remove the RADIUS server rad1.company.com configured for authentication only, use the following commands:

```
awplus# configure terminal
awplus(config)# no radius-server host rad1.company.com
acct-port 0
```

To configure rad2.company.com for accounting only, use the following commands:

```
awplus# configure terminal
awplus(config)# radius-server host rad2.company.com auth-port 0
```

To configure 192.168.1.1 with authentication port 1000, accounting port 1001 and retransmit count 5, use the following commands:

```
awplus# configure terminal
awplus(config)# radius-server host 192.168.1.1 auth-port 1000
acct-port 1001 retransmit 5
```

**Related  
Commands**

- [aaa group server](#)
- [radius-server key](#)
- [radius-server retransmit](#)
- [radius-server timeout](#)

# radius-server key

**Overview** This command sets a global secret key for RADIUS authentication on the device. The shared secret text string is used for RADIUS authentication between the device and a RADIUS server.

Note that if no secret key is explicitly specified for a RADIUS server, the global secret key will be used for the shared secret for the server.

Use the **no** variant of this command to reset the secret key to the default (null).

**Syntax** `radius-server key <key>`  
`no radius-server key`

| Parameter                | Description                                          |
|--------------------------|------------------------------------------------------|
| <code>&lt;key&gt;</code> | Shared secret among radius server and 802.1X client. |

**Default** The RADIUS server secret key on the system is not set by default (null).

**Mode** Global Configuration

**Usage** Use this command to set the global secret key shared between this client and its RADIUS servers. If no secret key is specified for a particular RADIUS server using the **radius-server host c** command, this global key is used.

After enabling AAA authentication with the **aaa authentication login** command, set the authentication and encryption key using the **radius-server key** command so the key entered matches the key used on the RADIUS server.

**Examples** To set the global secret key to **allied** for RADIUS server, use the following commands:

```
awplus# configure terminal
awplus(config)# radius-server key allied
```

To set the global secret key to **secret** for RADIUS server, use the following commands:

```
awplus# configure terminal
awplus(config)# radius-server key secret
```

To delete the global secret key for RADIUS server, use the following commands:

```
awplus# configure terminal
awplus(config)# no radius-server key
```

**Related Commands** [radius-server host](#)



# radius-server retransmit

**Overview** This command sets the retransmit counter to use RADIUS authentication on the device. This command specifies how many times the device transmits each RADIUS request to the RADIUS server before giving up.

This command configures the **retransmit** parameter for RADIUS servers globally. If the **retransmit** parameter is not specified for a RADIUS server by the **radius-server host** command then the global configuration set by this command is used for the server instead.

Use the **no** variant of this command to reset the re-transmit counter to the default (3).

**Syntax** `radius-server retransmit <retries>`  
`no radius-server retransmit`

| Parameter                    | Description                                                                                                                                                                                                                                                                                                                                 |
|------------------------------|---------------------------------------------------------------------------------------------------------------------------------------------------------------------------------------------------------------------------------------------------------------------------------------------------------------------------------------------|
| <code>&lt;retries&gt;</code> | RADIUS server retries in the range <0-100>. The number of times a request is resent to a RADIUS server that does not respond, before the server is considered dead and the next server is tried. If no retransmit value is specified for a particular RADIUS server using the <b>radius-server host</b> command, this global value is used. |

**Default** The default RADIUS retransmit count on the device is 3.

**Mode** Global Configuration

**Examples** To set the RADIUS **retransmit** count to 1, use the following commands:

```
awplus# configure terminal
awplus(config)# radius-server retransmit 1
```

To set the RADIUS **retransmit** count to the default (3), use the following commands:

```
awplus# configure terminal
awplus(config)# no radius-server retransmit
```

To configure the RADIUS **retransmit** count globally with 5, use the following commands:

```
awplus# configure terminal
awplus(config)# radius-server retransmit 5
```

To disable retransmission of requests to a RADIUS server, use the following commands:

```
awplus# configure terminal
awplus(config)# radius-server retransmit 0
```

**Related  
Commands** [radius-server deadtime](#)  
[radius-server host](#)

# radius-server timeout

**Overview** Use this command to specify the RADIUS global timeout value. This is how long the device waits for a reply to a RADIUS request before retransmitting the request, or considering the server to be dead. If no timeout is specified for the particular RADIUS server by the **radius-server host** command, it uses this global timeout value.

Note that this command configures the **timeout** parameter for RADIUS servers globally.

The **no** variant of this command resets the transmit timeout to the default (5 seconds).

**Syntax** `radius-server timeout <seconds>`  
`no radius-server timeout`

| Parameter                    | Description                                                                                                                                                                                                                                                               |
|------------------------------|---------------------------------------------------------------------------------------------------------------------------------------------------------------------------------------------------------------------------------------------------------------------------|
| <code>&lt;seconds&gt;</code> | RADIUS server timeout in seconds in the range 1 to 1000. The global time in seconds to wait for a RADIUS server to reply to a request before retransmitting the request, or considering the server to be dead (depending on the <b>radius-server retransmit</b> command). |

**Default** The default RADIUS transmit timeout on the system is 5 seconds.

**Mode** Global Configuration

**Examples** To globally set the device to wait 20 seconds before retransmitting a RADIUS request to unresponsive RADIUS servers, use the following commands:

```
awplus# configure terminal
awplus(config)# radius-server timeout 20
```

To set the RADIUS **timeout** parameter to 1 second, use the following commands:

```
awplus# configure terminal
awplus(config)# radius-server timeout 1
```

To set the RADIUS **timeout** parameter to the default (5 seconds), use the following commands:

```
awplus# configure terminal
awplus(config)# no radius-server timeout
```

To configure the RADIUS server **timeout** period globally with 3 seconds, use the following commands:

```
awplus# configure terminal
awplus(config)# radius-server timeout 3
```

To reset the global **timeout** period for RADIUS servers to the default, use the following command:

```
awplus# configure terminal
awplus(config)# no radius-server timeout
```

**Related  
Commands**

[radius-server deadtime](#)  
[radius-server host](#)  
[radius-server retransmit](#)

# server (Server Group)

**Overview** This command adds a RADIUS server to a server group in Server-Group Configuration mode. The RADIUS server should be configured by the [radius-server host](#) command.

The server is appended to the server list of the group and the order of configuration determines the precedence of servers. If the server exists in the server group already, it will be removed before added as a new server.

The server is identified by IP address and authentication and accounting UDP port numbers. So a RADIUS server can have multiple entries in a group with different authentication and/or accounting UDP ports. The **auth-port** specifies the UDP destination port for authentication requests to the server. To disable authentication for the server, set `auth-port` to 0. If the authentication port is missing, the default port number is 1812. The **acct-port** specifies the UDP destination port for accounting requests to the server. To disable accounting for the server, set `acct-port` to 0. If the accounting port is missing, the default port number is 1813.

Use the **no** variant of this command to remove a RADIUS server from the server group.

**Syntax**

```
server {<hostname>|<ip-address>} [auth-port <0-65535>] [acct-port <0-65535>]
no server {<hostname>|<ip-address>} [auth-port <0-65535>] [acct-port <0-65535>]
```

| Parameter                       | Description                                                                                                                                                                                                                                                            |
|---------------------------------|------------------------------------------------------------------------------------------------------------------------------------------------------------------------------------------------------------------------------------------------------------------------|
| <code>&lt;hostname&gt;</code>   | Server host name                                                                                                                                                                                                                                                       |
| <code>&lt;ip-address&gt;</code> | Server IP address<br>The server is identified by IP address, authentication and accounting UDP port numbers. So a RADIUS server can have multiple entries in a group with different authentication and/or accounting UDP ports.                                        |
| <code>auth-port</code>          | Authentication port<br>The <b>auth-port</b> specifies the UDP destination port for authentication requests to the server. To disable authentication for the server, set <b>auth-port</b> to 0. If the authentication port is missing, the default port number is 1812. |
| <code>&lt;0-65535&gt;</code>    | UDP port number (default: 1812)                                                                                                                                                                                                                                        |
| <code>acct-port</code>          | Accounting port<br>The <b>acct-port</b> specifies the UDP destination port for accounting requests to the server. To disable accounting for the server, set <b>acct-port</b> to 0. If the accounting port is missing, the default port number is 1813.                 |
| <code>&lt;0-65535&gt;</code>    | UDP port number (default: 1813)                                                                                                                                                                                                                                        |

**Default** The default Authentication port number is 1812 and the default Accounting port number is 1813.

**Mode** Server Group Configuration

**Usage** The RADIUS server to be added must be configured by the **radius-server host** command. In order to add or remove a server, the **auth-port** and **acct-port** parameters in this command must be the same as the corresponding parameters in the **radius-server host** command.

**Examples** To create a RADIUS server group RAD\_AUTH1 for authentication, use the following commands:

```
awplus# configure terminal
awplus(config)# aaa group server radius RAD_AUTH1
awplus(config-sg)# server 192.168.1.1 acct-port 0
awplus(config-sg)# server 192.168.2.1 auth-port 1000 acct-port 0
```

To create a RADIUS server group RAD\_ACCT1 for accounting, use the following commands:

```
awplus# configure terminal
awplus(config)# aaa group server radius RAD_ACCT1
awplus(config-sg)# server 192.168.2.1 auth-port 0 acct-port 1001
awplus(config-sg)# server 192.168.3.1 auth-port 0
```

To remove server 192.168.3.1 from the existing server group **GROUP1**, use the following commands:

```
awplus# configure terminal
awplus(config)# aaa group server radius GROUP1
awplus(config-sg)# no server 192.168.3.1
```

**Related Commands**

- [aaa accounting login](#)
- [aaa authentication login](#)
- [aaa group server](#)
- [radius-server host](#)

# show debugging radius

**Overview** This command displays the current debugging status for the RADIUS servers.

**Syntax** `show debugging radius`

**Mode** User Exec and Privileged Exec

**Example** To display the current debugging status of RADIUS servers, use the command:

```
awplus# show debugging radius
```

**Output** Figure 44-1: Example output from the **show debugging radius** command

```
RADIUS debugging status:
RADIUS event debugging is off
RADIUS packet debugging is off
```

# show radius

**Overview** This command displays the current RADIUS server configuration and status.

**Syntax** show radius

**Mode** User Exec and Privileged Exec

**Example** To display the current status of RADIUS servers, use the command:

```
awplus# show radius
```

**Output** Figure 44-2: Example output from the **show radius** command showing RADIUS servers

```
RADIUS Global Configuration
Source Interface : not configured
Secret Key : secret
Timeout : 5 sec
Retransmit Count : 3
Deadtime : 20 min
Server Host : 192.168.1.10
Authentication Port : 1812
Accounting Port : 1813
Secret Key : secret
Timeout : 3 sec
Retransmit Count : 2
Server Host : 192.168.1.11
Authentication Port : 1812
Accounting Port : not configured

Server Name/ Auth Acct Auth Acct
IP Address Port Port Status Status

192.168.1.10 1812 1813 Alive Alive
192.168.1.11 1812 N/A Alive N/A
```

**Example** See the sample output below showing RADIUS client status and RADIUS configuration:

```
awplus# show radius
```



**Output** Figure 44-3: Example output from the **show radius** command showing RADIUS client status

```
RADIUS global interface name: awplus
 Secret key:
 Timeout: 5
 Retransmit count: 3
 Deadtime: 0

Server Address: 150.87.18.89
 Auth destination port: 1812
 Accounting port: 1813
 Secret key: swg
 Timeout: 5
 Retransmit count: 3
 Deadtime: 0
show radius local-server group
```

| Output Parameter    | Meaning                                                                                            |
|---------------------|----------------------------------------------------------------------------------------------------|
| Source Interface    | The interface name or IP address to be used for the source address of all outgoing RADIUS packets. |
| Secret Key          | A shared secret key to a radius server.                                                            |
| Timeout             | A time interval in seconds.                                                                        |
| Retransmit Count    | The number of retry count if a RADIUS server does not response.                                    |
| Deadtime            | A time interval in minutes to mark a RADIUS server as "dead".                                      |
| Interim-Update      | A time interval in minutes to send Interim-Update Accounting report.                               |
| Group Deadtime      | The deadtime configured for RADIUS servers within a server group.                                  |
| Server Host         | The RADIUS server hostname or IP address.                                                          |
| Authentication Port | The destination UDP port for RADIUS authentication requests.                                       |
| Accounting Port     | The destination UDP port for RADIUS accounting requests.                                           |

| Output Parameter | Meaning                                                                                                                                                                            |
|------------------|------------------------------------------------------------------------------------------------------------------------------------------------------------------------------------|
| Auth Status      | The status of the authentication port.<br>The status ("dead", "error", or "alive") of the RADIUS authentication server and, if dead, how long it has been dead for.                |
|                  | Alive      The server is alive.                                                                                                                                                    |
|                  | Error      The server is not responding.                                                                                                                                           |
|                  | Dead      The server is detected as dead and it will not be used for deadtime period. The time displayed in the output shows the server is in dead status for that amount of time. |
|                  | Unknown    The server is never used or the status is unknown.                                                                                                                      |
| Acct Status      | The status of the accounting port.<br>The status ("dead", "error", or "alive") of the RADIUS accounting server and, if dead, how long it has been dead for.                        |

# undebug radius

**Overview** This command applies the functionality of the **no debug radius** command.

# 45

# Local RADIUS Server Commands

## Introduction

**Overview** This chapter provides an alphabetical reference for commands used to configure the local RADIUS server on the device. For more information, see the [Local RADIUS Server Feature Overview and Configuration Guide](#).

- Command List**
- ["attribute"](#) on page 1990
  - ["authentication"](#) on page 1993
  - ["client \(radsecproxy-srv\)"](#) on page 1994
  - ["client mutual-authentication"](#) on page 1996
  - ["client name-check"](#) on page 1997
  - ["client trustpoint"](#) on page 1998
  - ["clear radius local-server statistics"](#) on page 1999
  - ["copy fdb-radius-users \(to file\)"](#) on page 2000
  - ["copy local-radius-user-db \(from file\)"](#) on page 2002
  - ["copy local-radius-user-db \(to file\)"](#) on page 2003
  - ["crypto pki enroll local \(deleted\)"](#) on page 2004
  - ["crypto pki enroll local local-radius-all-users \(deleted\)"](#) on page 2005
  - ["crypto pki enroll local user \(deleted\)"](#) on page 2006
  - ["crypto pki export local pem \(deleted\)"](#) on page 2007
  - ["crypto pki export local pkcs12 \(deleted\)"](#) on page 2008
  - ["crypto pki trustpoint local \(deleted\)"](#) on page 2009
  - ["debug crypto pki \(deleted\)"](#) on page 2010
  - ["domain-style"](#) on page 2011
  - ["egress-vlan-id"](#) on page 2012

- [“egress-vlan-name”](#) on page 2013
- [“group”](#) on page 2014
- [“nas”](#) on page 2015
- [“radius-secure-proxy local-server”](#) on page 2016
- [“radius-server local”](#) on page 2017
- [“server auth-port”](#) on page 2018
- [“server enable”](#) on page 2019
- [“show crypto pki certificates \(deleted\)”](#) on page 2020
- [“show crypto pki certificates local-radius-all-users \(deleted\)”](#) on page 2021
- [“show crypto pki certificates user \(deleted\)”](#) on page 2022
- [“show crypto pki trustpoints \(deleted\)”](#) on page 2023
- [“show radius local-server group”](#) on page 2024
- [“show radius local-server nas”](#) on page 2025
- [“show radius local-server statistics”](#) on page 2026
- [“show radius local-server user”](#) on page 2027
- [“user \(RADIUS server\)”](#) on page 2029
- [“vlan \(RADIUS server\)”](#) on page 2031

# attribute

**Overview** Use this command to define a RADIUS attribute for the local RADIUS server user group.

For a complete list of defined RADIUS attributes and values, see the [Local RADIUS Server Feature Overview and Configuration Guide](#).

When used with the **help** parameter the **attribute** command displays a list of standard and vendor specific valid RADIUS attributes that are supported by the local RADIUS server.

If an attribute name is specified with the **help** parameter, then the **attribute** command displays a list of predefined attribute names. Note that you can only use the defined RADIUS attribute names and not define your own.

When used with the **value** parameter the **attribute** command configures RADIUS attributes to the user group. If the specified attribute is already defined then it is replaced with the new value.

Use the **no** variant of this command to delete an attribute from the local RADIUS server user group.

**Syntax**

```
attribute [<attribute-name>|<attribute-id>] help
attribute {<attribute-name>|<attribute-id>} <value>
no attribute {<attribute-name>|<attribute-id>}
```

| Parameter        | Description                                                                                                                                                                                  |
|------------------|----------------------------------------------------------------------------------------------------------------------------------------------------------------------------------------------|
| <attribute-name> | RADIUS attribute name for standard attributes or Vendor-Specific attributes (see the <a href="#">Local RADIUS Server Feature Overview and Configuration Guide</a> for tables of attributes). |
| <attribute-id>   | RADIUS attribute numeric identifier for standard attributes.                                                                                                                                 |
| <value>          | RADIUS attribute value.                                                                                                                                                                      |
| help             | Display a list of available attribute types.                                                                                                                                                 |

**Default** By default, no attributes are configured.

**Mode** RADIUS Server Group Configuration

**Usage** For the Standard attributes, the attribute may be specified using either the attribute name, or its numeric identifier. For example, the command:

```
awplus(config-radsrv-group)# attribute acct-terminate-cause
help
```

will produce the same results as the command:

```
awplus(config-radsrv-group)# attribute 49 help
```

In the same way, where the specific attribute has a pre-defined value, the parameter *<value>* may be substituted with the Value Name or with its numeric value, for example the command:

```
awplus(config-radsrv-group)# attribute acct-terminate-cause
user-request
```

will produce the same results as the command:

```
awplus(config-radsrv-group)# attribute 49 1
```

or the command:

```
awplus(config-radsrv-group)# attribute acct-terminate-cause 1
```

**Examples** To check a list of all available defined RADIUS attribute names, use the following commands:

```
awplus# configure terminal
awplus(config)# radius-server local
awplus(config-radsrv)# group Admin
awplus(config-radsrv-group)# attribute help
```

A list of Vendor-specific Attributes displays after the list of defined Standard Attributes.

To get help for valid RADIUS attribute values for the attribute *Service-Type*, use the following commands:

```
awplus# configure terminal
awplus(config)# radius-server local
awplus(config-radsrv)# group Admin
awplus(config-radsrv-group)# attribute Service-Type help
```

This results in the following output:

```
Service-Type : integer (Integer number)

Pre-defined values :
 Administrative-User (6)
 Authenticate-Only (8)
 Authorize-Only (17)
 Callback-Administrative (11)
 Callback-Framed-User (4)
 Callback-Login-User (3)
 Callback-NAS-Prompt (9)
 Call-Check (10)
 Framed-User (2)
 Login-User (1)
 NAS-Prompt-User (7)
 Outbound-User (5)
```

To define the attribute name 'Service-Type' with Administrative User (6) to the RADIUS User Group 'Admin', use the following commands:

```
awplus# configure terminal
awplus(config)# radius-server local
awplus(config-radsrv)# group Admin
awplus(config-radsrv-group)# attribute Service-Type 6
```

To delete the attribute 'Service-Type' from the RADIUS User Group 'Admin', use the following commands:

```
awplus# configure terminal
awplus(config)# radius-server local
awplus(config-radsrv)# group Admin
awplus(config-radsrv-group)# no attribute Service-Type
```

**Related  
Commands** [egress-vlan-id](#)  
[egress-vlan-name](#)



# authentication

**Overview** Use this command to enable the specified authentication methods on the local RADIUS server.

Use the **no** variant of this command to disable specified authentication methods on the local RADIUS server.

**Syntax** authentication {mac|eapmd5|eaptls|peap}  
no authentication {mac|eapmd5|eaptls|peap}

| Parameter | Description                            |
|-----------|----------------------------------------|
| mac       | Enable MAC authentication method.      |
| eapmd5    | Enable EAP-MD5 authentication method.  |
| eaptls    | Enable EAP-TLS authentication method.  |
| peap      | Enable EAP-PEAP authentication method. |

**Default** All authentication methods are enabled by default.

**Mode** RADIUS Server Configuration

**Examples** The following commands enable EAP-MD5 authentication methods on the local RADIUS server.

```
awplus# configure terminal
awplus(config)# radius-server local
awplus(config-radsrv)# authentication eapmd5
```

The following commands disable EAP-MD5 authentication methods on Local RADIUS server.

```
awplus# configure terminal
awplus(config)# radius-server local
awplus(config-radsrv)# no authentication eapmd5
```

**Related Commands** [server enable](#)  
[show radius local-server statistics](#)

# client (radsecproxy-srv)

**Overview** Use this command to add a RadSec client (for example, a NAS device) to the RadSecProxy local-server application. The application will accept RADIUS requests from all configured clients.

Use the **no** variant of this command to delete a previously-configured client from the RadSecProxy local-server application.

**Syntax** `client {<hostname>|<ip-addr>} [name-check {on|off}]`  
`no client {<hostname>|<ip-addr>}`

| Parameter  | Description                                                                                                                                                                     |
|------------|---------------------------------------------------------------------------------------------------------------------------------------------------------------------------------|
| <hostname> | Hostname of client.                                                                                                                                                             |
| <ip-addr>  | Specify the client IPv4 address, in dotted decimal notation (A.B.C.D).                                                                                                          |
| name-check | Specify whether or not to enforce certificate name checking for this client. If the parameter is not specified then the global behavior, which defaults to <b>on</b> , is used. |
| on         | Enable name checking for this client.                                                                                                                                           |
| off        | Disable name checking for this client.                                                                                                                                          |

**Mode** RadSecProxy Local Server Configuration

**Usage** The client may be specified by its domain name or by its IPv4 address. If a domain name is used, it must be resolvable using a configured DNS name server.

Each client may be configured to use certificate name-checking; if not specified, the global behavior defined by **client name-check** or **no client name-check** will be used. If name checking is enabled, the Common Name portion of the subject field of the client's X.509 certificate must match the domain name or IP address specified in this command.

**NOTE:** *If mutual authentication is disabled then this parameter has no effect, see the [client mutual-authentication](#) command.*

**Example** To add a client called 'mynas.local' with certificate name checking **off**, use the commands:

```
awplus# configure terminal
awplus(config)# radius-secure-proxy local-server
awplus(config-radsecproxy-srv)# client mynas.local name-check
off
```

**Related Commands** [client mutual-authentication](#)  
[client name-check](#)

client trustpoint  
radius-secure-proxy local-server

# client mutual-authentication

**Overview** This command enables or disables mutual certificate authentication for all RadSecProxy clients. When enabled, the RadSecProxy local-server application will request and validate an X.509 certificate from the client when establishing a connection.

The **no** variant of this command disables mutual certificate validation. The local-server application will still transmit the local server certificate to the client, but will not expect or validate a certificate from the client.

**Syntax** `client mutual-authentication`  
`no client mutual-authentication`

**Default** Mutual authentication is enabled by default.

**Mode** RadSecProxy Local Server Configuration

**Example** Disable mutual certificate validation with the following command:

```
awplus# configure terminal
awplus(config)# radius-secure-proxy local-server
awplus(config-radsecproxy-srv)# no client
mutual-authentication
```

**Related Commands** [client \(radsecproxy-srv\)](#)  
[client name-check](#)  
[radius-secure-proxy local-server](#)

**Command changes** Version 5.4.6-2.1: command added

# client name-check

**Overview** This command sets the global behavior for certificate name-checking for the RadSecProxy localserver application to **on**. This behavior will be used for all clients associated with the application that do not specify a behavior on a per-client basis. If name-checking is enabled, the Common Name portion of the subject field of the client's X.509 certificate must match the domain name or IP address specified in the **client (radsecproxy-aaa)** command.

Use the **no** variant of this command to set the global behavior for certificate name checking to **off**

**Syntax** `client name-check`  
`no client name-check`

**Default** Certificate name checking is on by default.

**Mode** RadSecProxy Local Server Configuration

**Example** Disable certificate name checking globally with the following command:

```
awplus# configure terminal
awplus(config)# radius-secure-proxy local-server
awplus(config-radsecproxy-srv)# no client name-check
```

**Related Commands** [client \(radsecproxy-srv\)](#)  
[client trustpoint](#)  
[radius-secure-proxy local-server](#)

# client trustpoint

**Overview** This command adds one or more trustpoints to be used with the RadSecProxy local-server application. Multiple trustpoints may be specified, or the command may be executed more than once, to add multiple trustpoints to the application.

The **no** version of this command removes one or more trustpoints from the list of trustpoints associated with the application.

**Syntax** `client trustpoint [<trustpoint-list>]`  
`no client trustpoint [<trustpoint-list>]`

| Parameter         | Description                                             |
|-------------------|---------------------------------------------------------|
| <trustpoint-list> | Specify one or more trustpoints to be added or deleted. |

**Mode** RadSecProxy Local Server Configuration

**Usage** The device certificate associated with first trustpoint added to the application will be transmitted to remote servers. The certificate received from the remote server must have an issuer chain that terminates with the root CA certificate for any of the trustpoints that are associated with the application.

If no trustpoints are specified in the command, the trustpoint list will be unchanged.

If **no client trustpoint** is issued without specifying any trustpoints, then all trustpoints will be disassociated from the application.

**Example** You can add multiple trustpoints to the RadSecProxy local-server by executing the command multiple times:

```
awplus# configure terminal
awplus(config)# radius-secure-proxy local-server
awplus(config-radsecproxy-srv)# client trustpoint example_1
awplus(config-radsecproxy-srv)# client trustpoint example_2
```

Alternatively, add multiple trustpoints with a single command:

```
awplus(config-radsecproxy-srv)# client trustpoint example_3
example_4
```

Disassociate all trustpoints from the RadSecProxy local-server application using the command:

```
awplus(config-radsecproxy-srv)# no client trustpoint
```

**Related Commands** [client \(radsecproxy-srv\)](#)  
[client name-check](#)  
[radius-secure-proxy local-server](#)

# clear radius local-server statistics

**Overview** Use this command to clear the statistics stored on the device for the local RADIUS server.

Use this command without any parameters to clear all types of local RADIUS server statistics.

**Syntax** `clear radius local-server statistics [nas|server|user]`

| Parameter | Description                                                                                                                                  |
|-----------|----------------------------------------------------------------------------------------------------------------------------------------------|
| nas       | Clear the NAS (Network Access Server) statistics on the device. For example, clearing statistics stored for NAS server invalid passwords.    |
| server    | Clear the Local RADIUS Server statistics on the device. For example, clearing Local RADIUS Servers statistics for all failed login attempts. |
| user      | Clear the Local RADIUS Server user statistics. For example, clearing statistics stored for the number of successful user logins.             |

**Mode** Privileged Exec

**Usage** Refer to the sample output for the [show radius local-server statistics](#) for further information about the type of statistics each parameter option for this command clears. Both the **nas** and **server** parameters clear unknown username and invalid passwords statistics, while the **user** parameter clears the number of successful and failed logins for each local RADIUS server user.

**Examples** To clear the NAS (Network Access Server) statistics stored on the device, use the command:

```
awplus# clear radius local-server statistics nas
```

To clear the local RADIUS server statistics stored on the device, use the command:

```
awplus# clear radius local-server statistics server
```

To clear the local RADIUS server user statistics stored on the device, use the command:

```
awplus# clear radius local-server statistics user
```

**Related Commands** [show radius local-server statistics](#)

# copy fdb-radius-users (to file)

**Overview** Use this command to create a set of local RADIUS server users from MAC addresses in the local FDB. A local RADIUS server user created using this command can be used for MAC authentication.

**Syntax** `copy fdb-radius-users  
{local-radius-user-db|nvs|flash|usb|debug|tftp|scp|  
fserver|<url>} [interface <port>] [vlan <vid>] [group <name>]  
[export-vlan [<radius-group-name>]]`

| Parameter            | Description                                                                                                          |
|----------------------|----------------------------------------------------------------------------------------------------------------------|
| local-radius-user-db | Copy the local RADIUS server users created to the local RADIUS server.                                               |
| nvs                  | Copy the local RADIUS server users created to NVS memory.                                                            |
| flash                | Copy the local RADIUS server users created to Flash memory.                                                          |
| card                 | Copy the local RADIUS server users created to SD card.                                                               |
| usb                  | Copy the local RADIUS server users created to USB storage device.                                                    |
| debug                | Copy the local RADIUS server users created to debug.                                                                 |
| tftp                 | Copy the local RADIUS server users created to the TFTP destination.                                                  |
| scp                  | Copy the local RADIUS server users created to the SCP destination.                                                   |
| fserver              | Copy the local RADIUS server users created to the remote file server.                                                |
| <url>                | Copy the local RADIUS server users created to the specified URL.                                                     |
| interface <port>     | Copy only MAC addresses learned on a specified device port. Wildcards may be used when specifying an interface name. |
| vlan <vid>           | Copy only MAC addresses learned on a specified VLAN.                                                                 |
| group <name>         | Assign a group name to the local RADIUS server users created.                                                        |
| export-vlan          | Export VLAN ID assigned to exported FDB entry.                                                                       |
| <radius-group-name>  | Prefix for Radius group name storing VLAN ID                                                                         |

**Mode** Privileged Exec

**Usage** The local RADIUS server users created are written to a specified destination file in local RADIUS user CSV (Comma Separated Values) format. The local RADIUS server users can then be imported to a local RADIUS server using the [copy local-radius-user-db \(from file\)](#) command.



The name and password of the local RADIUS server users created use a MAC address, which can be used for MAC authentication.

This command does not copy a MAC address learned by the CPU or the management port.

This command can filter FDB entries by the interface name and the VLAN ID. When the interface name and the VLAN ID are specified, this command generates local RADIUS server users from only the MAC address learned on the specified interface and on the specified VLAN.

**Examples** To register the local RADIUS server users from the local FDB directly to the local RADIUS server, use the command:

```
awplus# copy fdb-radius-users local-radius-user-db
```

To register the local RADIUS server users from the interface `port1.0.1` to the local RADIUS server, use the command:

```
awplus# copy fdb-radius-users local-radius-user-db interface port1.0.1
```

To copy output generated as local RADIUS server user data from MAC addresses learned on `vlan10` on interface `port1.0.1` to the file `radius-user.csv`, use the command:

```
awplus# copy fdb-radius-users radius-user.csv interface port1.0.1 vlan10
```

To copy output generated as local RADIUS server user data from MAC addresses learned on `vlan10` on interface `port1.0.1` to a file on the remote file server, use the command:

```
awplus# copy fdb-radius-users fserver interface port1.0.1 vlan10
```

**Related Commands** [copy local-radius-user-db \(to file\)](#)  
[copy local-radius-user-db \(from file\)](#)

# copy local-radius-user-db (from file)

**Overview** Use this command to copy the Local RADIUS server user data from a file. The file, including the RADIUS user data in the file, must be in the CSV (Comma Separated Values) format.

You can select **add** or **replace** as the copy method. The **add** parameter option copies the contents of specified file to the local RADIUS server user database. If the same user exists then the old user is removed before adding a new user. The **replace** parameter option deletes all contents of the local RADIUS server user database before copying the contents of specified file.

**Syntax** `copy <source-url> local-radius-user-db [add|replace]`

| Parameter                       | Description                                                           |
|---------------------------------|-----------------------------------------------------------------------|
| <code>&lt;source-url&gt;</code> | URL of the source file.                                               |
| <code>add</code>                | Add file contents to local RADIUS server user database.               |
| <code>replace</code>            | Replace current local RADIUS server user database with file contents. |

**Default** When no copy method is specified with this command the **replace** option is applied.

**Mode** Privileged Exec

**Examples** To replace the current local RADIUS server user data to the contents of `http://datahost/ user.csv`, use the following command:

```
awplus# copy http://datahost/user.csv local-radius-user-db
```

To add the contents of `http://datahost/user.csv` to the current local RADIUS server user database, use the following command:

```
awplus# copy http://datahost/user.csv local-radius-user-db add
```

**Related commands** [copy fdb-radius-users \(to file\)](#)  
[copy local-radius-user-db \(to file\)](#)

# copy local-radius-user-db (to file)

**Overview** Use this command to copy the local RADIUS server user data to a file. The output file produced is CSV (Comma Separated Values) format.

**Syntax** `copy local-radius-user-db  
{nvs|flash|card|usb|tftp|scp|<destination-url>}`

| Parameter         | Description                  |
|-------------------|------------------------------|
| nvs               | Copy to NVS memory.          |
| flash             | Copy to Flash memory.        |
| card              | Copy to SD card.             |
| usb               | Copy to USB storage device.  |
| tftp              | Copy to TFTP destination.    |
| scp               | Copy to SCP destination.     |
| <destination-url> | URL of the Destination file. |

**Mode** Privileged Exec

**Example** Copy the current local RADIUS server user data to `http://datahost/user.csv`.

```
awplus# copy local-radius-user-db http://datahost/user.csv
```

**Related Commands** [copy fdb-radius-users \(to file\)](#)  
[copy local-radius-user-db \(from file\)](#)

# crypto pki enroll local (deleted)

**Overview** This command is no longer available. Please use the following command instead:

```
crypto pki enroll <trustpoint>
```

Note that “local” is a valid name for a trustpoint, so you do not need to modify existing configurations or scripts.

# crypto pki enroll local local-radius-all-users (deleted)

**Overview** This command is no longer available. Please use the following command instead:

```
crypto pki enroll <trustpoint> local-radius-all-users
```

Note that "local" is a valid name for a trustpoint, so you do not need to modify existing configurations or scripts.

# crypto pki enroll local user (deleted)

**Overview** This command is no longer available. Please use the following command instead:

```
crypto pki enroll <trustpoint> user <username>
```

Note that “local” is a valid name for a trustpoint, so you do not need to modify existing configurations or scripts.

# crypto pki export local pem (deleted)

**Overview** This command is no longer available. Please use the [crypto pki export pem](#) command instead:

```
crypto pki export <trustpoint> pem [terminal|<url>]
```

Note that "local" is a valid name for a trustpoint, so you do not need to modify existing configurations or scripts.

# crypto pki export local pkcs12 (deleted)

**Overview** This command is no longer available. Please use the [crypto pki export pkcs12](#) command instead:

```
crypto pki export <trustpoint> pkcs12 {ca|server|<username>}
<url>
```

Note that "local" is a valid name for a trustpoint, so you do not need to modify existing configurations or scripts.



# crypto pki trustpoint local (deleted)

**Overview** This command is no longer available. Please use the following command instead:

```
crypto pki trustpoint <trustpoint>
```

Note that "local" is a valid name for a trustpoint, so you do not need to modify existing configurations or scripts.

# debug crypto pki (deleted)

**Overview** This command is no longer available.

# domain-style

**Overview** Use this command to enable a specified domain style on the local RADIUS server. The local RADIUS server decodes the domain portion of a username login string when this command is enabled.

Use the **no** variant of this command to disable the specified domain style on the local RADIUS server.

**Syntax** `domain-style {suffix-atsign|ntdomain}`  
`no domain-style {suffix-atsign|ntdomain}`

| Parameter                  | Description                                                    |
|----------------------------|----------------------------------------------------------------|
| <code>suffix-atsign</code> | Enable at sign "@" delimited suffix style, i.e. "user@domain". |
| <code>ntdomain</code>      | Enable NT domain style, i.e. "domain\user".                    |

**Default** This feature is disabled by default.

**Mode** RADIUS Server Configuration

**Usage** When both domain styles are enabled, the first domain style configured has the highest priority. A username login string is matched against the first domain style enabled. Then, if the username login string is not decoded, it is matched against the second domain style enabled.

**Examples** To enable NT domain style on the local RADIUS server, use the commands:

```
awplus# configure terminal
awplus(config)# radius-server local
awplus(config-radsrv)# domain-style ntdomain
```

To disable NT domain style on the local RADIUS server, use the commands:

```
awplus# configure terminal
awplus(config)# radius-server local
awplus(config-radsrv)# no domain-style ntdomain
```

**Related Commands** [server enable](#)

# egress-vlan-id

**Overview** Use this command to configure the standard RADIUS attribute “Egress-VLANID (56)” for the local RADIUS Server user group.

Use the **no** variant of this command to remove the Egress-VLANID attribute from the local RADIUS server user group.

**Syntax** `egress-vlan-id <vid> [tagged|untagged]`  
`no egress-vlan-id`

| Parameter | Description                                                                                                                       |
|-----------|-----------------------------------------------------------------------------------------------------------------------------------|
| <vid>     | The VLAN identifier to be used for the Egress VLANID attribute, in the range 1 to 4094.                                           |
| tagged    | Set frames on the VLAN as tagged. This sets the tag indication field to indicate that all frames on this VLAN are tagged.         |
| untagged  | Set all frames on the VLAN as untagged. This sets the tag indication field to indicate that all frames on this VLAN are untagged. |

**Default** By default, no Egress-VLANID attributes are configured.

**Mode** RADIUS Server Group Configuration

**Examples** To set the “Egress-VLANID” attribute for the *NormalUsers* local RADIUS server user group to VLAN identifier 200, with tagged frames, use the commands:

```
awplus# configure terminal
awplus(config)# radius-server local
awplus(config-radsrv)# group NormalUsers
awplus(config-radsrv-group)# egress-vlan-id 200 tagged
```

To remove the “Egress-VLANID” attribute for the *NormalUsers* local RADIUS server user group, use the commands:

```
awplus# configure terminal
awplus(config)# radius-server local
awplus(config-radsrv)# group NormalUsers
awplus(config-radsrv-group)# no egress-vlan-id
```

**Related Commands** [attribute](#)  
[egress-vlan-name](#)

# egress-vlan-name

**Overview** Use this command to configure the standard RADIUS attribute “Egress-VLAN-Name (58)” for the local RADIUS server user group.

Use the **no** variant of this command to remove the Egress-VLAN-Name attribute from the local RADIUS server user group.

**Syntax** `egress-vlan-name <vlan-name> [tagged|untagged]`  
`no egress-vlan-name`

| Parameter                      | Description                                                                                                                       |
|--------------------------------|-----------------------------------------------------------------------------------------------------------------------------------|
| <code>&lt;vlan-name&gt;</code> | The VLAN name to be configured as the Egress-VLAN-Name attribute.                                                                 |
| <code>tagged</code>            | Set frames on the VLAN as tagged. This sets the tag indication field to indicate that all frames on this VLAN are tagged.         |
| <code>untagged</code>          | Set all frames on the VLAN as untagged. This sets the tag indication field to indicate that all frames on this VLAN are untagged. |

**Default** By default, no Egress-VLAN-Name attributes are configured.

**Mode** RADIUS Server Group Configuration

**Examples** To configure the “Egress-VLAN-Name” attribute for the RADIUS server user group *NormalUsers* with the VLAN name *vlan2* and all frames on this VLAN tagged, use the commands:

```
awplus# configure terminal
awplus(config)# radius-server local
awplus(config-radsrv)# group NormalUsers
awplus(config-radsrv-group)# egress-vlan-name vlan2 tagged
```

To delete the “Egress-VLAN-Name” attribute for the *NormalUsers* group, use the commands:

```
awplus# configure terminal
awplus(config)# radius-server local
awplus(config-radsrv)# group NormalUsers
awplus(config-radsrv-group)# no egress-vlan-name
```

**Related Commands** [attribute](#)  
[egress-vlan-id](#)

# group

**Overview** Use this command to create a local RADIUS server user group, and enter local RADIUS Server User Group Configuration mode.

Use the **no** variant of this command to delete the local RADIUS server user group.

**Syntax** `group <user-group-name>`  
`no group <user-group-name>`

| Parameter                            | Description             |
|--------------------------------------|-------------------------|
| <code>&lt;user-group-name&gt;</code> | User group name string. |

**Mode** RADIUS Server Configuration

**Examples** The following command creates the user group NormalUsers.

```
awplus# configure terminal
awplus(config)# radius-server local
awplus(config-radsrv)# group NormalUsers
```

The following command deletes user group NormalUsers.

```
awplus# configure terminal
awplus(config)# radius-server local
awplus(config-radsrv)# no group NormalUsers
```

**Related Commands** [user \(RADIUS server\)](#)  
[show radius local-server user](#)  
[vlan \(RADIUS server\)](#)

# nas

**Overview** This command adds a client device (the Network Access Server or the NAS) to the list of devices that are able to send authentication requests to the local RADIUS server. The NAS is identified by its IP address and a shared secret (also referred to as a shared key) must be defined that the NAS will use to establish its identity.

Use the **no** variant of this command to remove a NAS client from the list of devices that are allowed to send authentication requests to the local RADIUS server.

**Syntax** `nas <ip-address> key <nas-keystring>`  
`no nas <ip-address>`

| Parameter                          | Description            |
|------------------------------------|------------------------|
| <code>&lt;ip-address&gt;</code>    | RADIUS NAS IP address. |
| <code>&lt;nas-keystring&gt;</code> | NAS shared keystring.  |

**Mode** RADIUS Server Configuration

**Examples** The following commands add the NAS with an IP address of 192.168.1.2 to the list of clients that may send authentication requests to the local RADIUS server. Note the shared key that this NAS will use to establish its identify is NAS\_PASSWORD.

```
awplus# configure terminal
awplus(config)# radius-server local
awplus(config-radsrv)# nas 192.168.1.2 key NAS_PASSWORD
```

The following commands remove the NAS with an IP address of 192.168.1.2 from the list of clients that are allowed to send authentication requests to the local RADIUS server:

```
awplus# configure terminal
awplus(config)# radius-server local
awplus(config-radsrv)# no nas 192.168.1.2
```

**Related Commands** [show radius local-server nas](#)

# radius-secure-proxy local-server

**Overview** Use this command to enter the RadSecProxy local-server application configuration mode. This application allows remote RadSec clients to communicate with the local RADIUS server process via a secure (TLS) proxy.

**Syntax** `radius-secure-proxy local-server`

**Mode** Global Configuration Mode

**Example** To change mode from User Exec mode to the RadSecProxy local-server configuration mode, use the commands:

```
awplus# configure terminal
awplus(config)# radius-secure-proxy local-server
awplus(config-radsecproxy-srv)#
```

**Related Commands**

- [client \(radsecproxy-srv\)](#)
- [client name-check](#)
- [client trustpoint](#)



# radius-server local

**Overview** Use this command to navigate to the Local RADIUS server configuration mode (`config-radsrv`) from the Global Configuration mode (`config`).

**Syntax** `radius-server local`

**Mode** Global Configuration

**Example** Local RADIUS Server commands are available from `config-radsrv` configuration mode. To change mode from User Exec mode to the Local RADIUS Server mode (`config-radsrv`), use the commands:

```
awplus# configure terminal
awplus(config)# radius-server local
awplus(config-radsrv)#
```

## Output

```
awplus(config)#radius-server local
Creating Local CA repository.....OK
Enrolling Local System to local trustpoint..OK
awplus(config-radsrv)#
```

**Related Commands**

- [server enable](#)
- [show radius local-server group](#)
- [show radius local-server nas](#)
- [show radius local-server statistics](#)
- [show radius local-server user](#)

# server auth-port

**Overview** Use this command to change the UDP port number for local RADIUS server authentication.

Use the **no** variant of this command to reset the RADIUS server authentication port back to the default.

**Syntax** `server auth-port <1-65535>`  
`no server auth-port`

| Parameter | Description      |
|-----------|------------------|
| <1-65535> | UDP port number. |

**Default** The default local RADIUS server UDP authentication port number is 1812.

**Mode** RADIUS Server Configuration

**Examples** The following commands set the RADIUS server authentication port to 10000.

```
awplus# configure terminal
awplus(config)# radius-server local
awplus(config-radsrv)# server auth-port 10000
```

The following commands reset the RADIUS server authentication port back to the default UDP port of 1812.

```
awplus# configure terminal
awplus(config)# radius-server local
awplus(config-radsrv)# no server auth-port
```

**Related Commands** [server enable](#)  
[show radius local-server statistics](#)

# server enable

**Overview** This command enables the local RADIUS server. The local RADIUS server feature is started immediately when this command is issued.

The **no** variant of this command disables local RADIUS server. When this command is issued, the local RADIUS server stops operating.

**Syntax** `server enable`  
`no server enable`

**Default** The local RADIUS server is disabled by default and must be enabled for use with this command.

**Mode** RADIUS Server Configuration

**Examples** To enable the local RADIUS server, use the following commands:

```
awplus# configure terminal
awplus(config)# radius-server local
awplus(config-radsrv)# server enable
```

To disable the local RADIUS server, use the command:

```
awplus# configure terminal
awplus(config)# radius-server local
awplus(config-radsrv)# no server enable
```

**Related Commands** [server auth-port](#)  
[show radius local-server statistics](#)

# show crypto pki certificates (deleted)

**Overview** This command is no longer available. Please use the following command instead:

```
show crypto pki certificates <trustpoint>
```

Note that "local" is a valid name for a trustpoint.

# show crypto pki certificates local-radius-all-users (deleted)

**Overview** This command is no longer available because user certificates are not stored on the system; they are generated for export and then removed.

# show crypto pki certificates user (deleted)

**Overview** This command is no longer available because user certificates are not stored on the system; they are generated for export and then removed.

# show crypto pki trustpoints (deleted)

**Overview** This command is no longer available. Please use the following command instead:

```
show crypto pki trustpoint [<trustpoint>]
```

Note that "local" is a valid name for a trustpoint.

# show radius local-server group

**Overview** Use this command to display information about the local RADIUS server user group.

For information on filtering and saving command output, see the [“Getting Started with AlliedWare Plus” Feature Overview and Configuration Guide](#).

**Syntax** `show radius local-server group [<user-group-name>]`

| Parameter         | Description             |
|-------------------|-------------------------|
| <user-group-name> | User group name string. |

**Mode** User Exec and Privileged Exec

**Example** The following command displays Local RADIUS server user group information.

```
awplus# show radius local-server group
```

## Output

**Table 1:** Example output from the **show radius local-server group** command

|                  |               |
|------------------|---------------|
| Group-Name       | Vlan          |
| -----            |               |
| NetworkOperators | ManagementNet |
| NormalUsers      | CommonNet     |

**Table 2:** Parameters in the output of the **show radius local-server group** command

| Parameter  | Description                      |
|------------|----------------------------------|
| Group-Name | Group name.                      |
| Vlan       | VLAN name assigned to the group. |

**Related Commands** [group](#)



# show radius local-server nas

**Overview** Use this command to display information about NAS (Network Access Servers) registered to the local RADIUS server.

For information on filtering and saving command output, see the [“Getting Started with AlliedWare Plus” Feature Overview and Configuration Guide](#).

**Syntax** `show radius local-server nas [<ip-address>]`

| Parameter    | Description                             |
|--------------|-----------------------------------------|
| <ip-address> | Specify NAS IP address for show output. |

**Mode** User Exec and Privileged Exec

**Example** The following command displays NAS information.

```
awplus# show radius local-server nas
```

## Output

**Table 3:** Example output from the **show radius local-server nas** command

| NAS-Address | Shared-Key                 |
|-------------|----------------------------|
| 127.0.0.1   | awplus-local-radius-server |

**Table 4:** Parameters in the output of the **show radius local-server nas** command

| Parameter   | Description                            |
|-------------|----------------------------------------|
| NAS-Address | IP address of NAS.                     |
| Shared-Key  | Shared key used for RADIUS connection. |

**Related Commands** [nas](#)

# show radius local-server statistics

**Overview** Use this command to display statistics about the local RADIUS server.  
For information on filtering and saving command output, see the [“Getting Started with AlliedWare Plus” Feature Overview and Configuration Guide](#).

**Syntax** `show radius local-server statistics`

**Mode** User Exec and Privileged Exec

**Usage** Both unknown usernames and invalid passwords will display as failed logins in the show output.

**Example** The following command displays Local RADIUS server statistics.

```
awplus# show radius local-server statistics
```

## Output

**Table 5:** Example output from the **show radius local-server statistics** command

```
Server status : Run (administrative status is enable)
Enabled methods: MAC EAP-MD5 EAP-TLS EAP-PEAP

Successes :1 Unknown NAS :0
Failed Logins :0 Invalid packet from NAS :0
Internal Error :0 Unknown Error :0

NAS : 127.0.0.1
Successes :0 Shared key mismatch :0
Failed Logins :0 Unknown RADIUS message :0
Unknown EAP message :0 Unknown EAP auth type :0
Corrupted packet :0

NAS : 192.168.1.61
Successes :0 Shared key mismatch :0
Failed Logins :0 Unknown RADIUS message :0
Unknown EAP message :0 Unknown EAP auth type :0
Corrupted packet :0

Username Successes Failures
a 1 0
admin 0 0
```

**Related Commands**

- [clear radius local-server statistics](#)
- [radius-server local](#)
- [server enable](#)
- [server auth-port](#)

# show radius local-server user

**Overview** Use this command to display information about the local RADIUS server user.

For information on filtering and saving command output, see the [“Getting Started with AlliedWare Plus” Feature Overview and Configuration Guide](#).

**Syntax** `show radius local-server user [<user-name>]`  
`show radius local-server user <user-name> format csv`

| Parameter   | Description                                                                             |
|-------------|-----------------------------------------------------------------------------------------|
| <user-name> | RADIUS user name. If no user name is specified, information for all users is displayed. |
| format      | File format.                                                                            |
| csv         | Comma separated value format.                                                           |

**Mode** User Exec and Privileged Exec

**Examples** The following command displays Local RADIUS server user information for user Tom.

```
awplus# show radius local-server user Tom
```

**Table 6:** Example output from the **show radius local-server user** command

| User-Name | Password | Group            | Vlan          |
|-----------|----------|------------------|---------------|
| Tom       | abcd     | NetworkOperators | ManagementNet |

The following command displays all Local RADIUS server information for all users.

```
awplus# show radius local-server user
```

The following command displays Local RADIUS server user information for Tom in CSV format.

```
awplus# show radius local-server user Tom format csv
```

**Table 7:** Example output from the **show radius local-server user csv** command

|                                                                                                                 |
|-----------------------------------------------------------------------------------------------------------------|
| true,"NetworkOperators","Tom",<br>"abcd",0,2099/01/<br>01,1,"","","ManagementNet",false,3600,false,0,"",false," |
|-----------------------------------------------------------------------------------------------------------------|

**Table 8:** Parameters in the output from the **show radius local-server user** command

| Parameter | Description                      |
|-----------|----------------------------------|
| User-Name | User name.                       |
| Password  | User password.                   |
| Group     | Group name assigned to the user. |
| Vlan      | VLAN name assigned to the user.  |

**Related Commands** [group](#)  
[user \(RADIUS server\)](#)

# user (RADIUS server)

**Overview** Use this command to register a user to the local RADIUS server.  
Use the **no** variant of this command to delete a user from the local RADIUS server.

**Syntax** `user <radius-user-name> [encrypted] password <user-password>  
[group <user-group>]`  
`no user <radius-user-name>`

| Parameter                             | Description                                                                                                                                                                                                                                                                                                                                                                                                                                                                                                                                       |
|---------------------------------------|---------------------------------------------------------------------------------------------------------------------------------------------------------------------------------------------------------------------------------------------------------------------------------------------------------------------------------------------------------------------------------------------------------------------------------------------------------------------------------------------------------------------------------------------------|
| <code>&lt;radius-user-name&gt;</code> | RADIUS user name. This can also be a MAC address in the IEEE standard format of HH-HH-HH-HH-HH-HH if you are configuring MAC authentication to use local RADIUS server.                                                                                                                                                                                                                                                                                                                                                                           |
| <code>encrypted</code>                | Specifies that the password is being entered in its encrypted form, so that it is not further encrypted. When creating a new user, enter the password in plaintext, and do not use the <b>encrypted</b> parameter. Use the <b>encrypted</b> parameter only when referring to a user that has previously been created. For instance, when adding an existing user from another RADIUS server, use the <b>encrypted</b> parameter, and enter the encrypted version of the password that appears in the output of <b>show</b> commands for the user. |
| <code>&lt;user-password&gt;</code>    | User password. This can also be a MAC address in the IEEE standard format of HH-HH-HH-HH-HH-HH if you are configuring MAC authentication to use local RADIUS server.                                                                                                                                                                                                                                                                                                                                                                              |
| <code>group</code>                    | Specify the group for the user.                                                                                                                                                                                                                                                                                                                                                                                                                                                                                                                   |
| <code>&lt;user-group&gt;</code>       | User group name.                                                                                                                                                                                                                                                                                                                                                                                                                                                                                                                                  |

**Mode** RADIUS Server Configuration

**Usage** RADIUS user names cannot contain question mark (?), space ( ), or quote (" ") characters. RADIUS user names containing the below characters cannot use certificate authentication:

`/ \ '$ & () * ; < > ` |`

Certificates cannot be created and exported for RADIUS user names that contain the above characters. We advise you to avoid using these characters in RADIUS user names if you need to use certificate authentication, because you will not be able to create and export certificates.

You also can use the IEEE standard format hexadecimal notation (HH-HH-HH-HH-HH-HH) to specify a supplicant MAC address to configure the user name and user password parameters to use local RADIUS server for MAC Authentication. See the [AAA and Port\\_Authentication Feature Overview and Configuration\\_Guide](#) for a sample MAC configuration. See also the command **user**

**00-db-59-ab-70-37 password 00-db-59-ab-70-37** as shown in the command examples.

**Examples** The following commands add user "Tom" to the local RADIUS server and sets his password to "QwerSD".

```
awplus# configure terminal
awplus(config)# radius-server local
awplus(config-radsrv)# user Tom password QwerSD
```

The following commands add user "Tom" to the local RADIUS server user group "NormalUsers" and sets his password "QwerSD".

```
awplus# configure terminal
awplus(config)# radius-server local
awplus(config-radsrv)# user Tom password QwerSD group
NormalUsers
```

The following commands remove user "Tom" from the local RADIUS server:

```
awplus# configure terminal
awplus(config)# radius-server local
awplus(config-radsrv)# no user Tom
```

The following commands add the supplicant MAC address 00-d0-59-ab-70-37 to the local RADIUS server:

```
awplus# configure terminal
awplus(config)# radius-server local
awplus(config-radsrv)# user 00-db-59-ab-70-37 password
00-db-59-ab-70-37
```

The following commands remove the supplicant MAC address 00-d0-59-ab-70-37 from the local RADIUS server:

```
awplus# configure terminal
awplus(config)# radius-server local
awplus(config-radsrv)# no user 00-db-59-ab-70-37
```

**Related Commands** [group](#)  
[show radius local-server user](#)

# vlan (RADIUS server)

**Overview** Use this command to set the VLAN ID or name for the local RADIUS server user group. The VLAN information is used for authentication with the dynamic VLAN feature.

Use the **no** variant of this command to clear the VLAN ID or VLAN name for the local RADIUS server user group.

**Syntax** `vlan {<vid>|<vlan-name>}`  
`no vlan`

| Parameter                      | Description |
|--------------------------------|-------------|
| <code>&lt;vid&gt;</code>       | VLAN ID.    |
| <code>&lt;vlan-name&gt;</code> | VLAN name.  |

**Default** VLAN information is not set by default.

**Mode** RADIUS Server Group Configuration

**Examples** The following commands set VLAN ID 200 to the group named *NormalUsers*:

```
awplus# configure terminal
awplus(config)# radius-server local
awplus(config-radsrv)# group NormalUsers
awplus(config-radsrv-group)# vlan 200
```

The following commands remove VLAN ID 200 from the group named *NormalUsers*:

```
awplus# configure terminal
awplus(config)# radius-server local
awplus(config-radsrv)# group NormalUsers
awplus(config-radsrv-group)# no vlan
```

**Related Commands** [group](#)  
[show radius local-server user](#)

# 46

# Public Key Infrastructure Commands

## Introduction

**Overview** This chapter provides an alphabetical reference of commands used to configure the Public Key Infrastructure (PKI) capabilities on an AlliedWare Plus device. For more information about PKI, see the [Public Key Infrastructure \(PKI\) Feature Overview and Configuration Guide](#).

- Command List**
- [“crypto key generate rsa”](#) on page 2033
  - [“crypto key zeroize”](#) on page 2034
  - [“crypto pki authenticate”](#) on page 2035
  - [“crypto pki enroll”](#) on page 2036
  - [“crypto pki enroll user”](#) on page 2037
  - [“crypto pki export pem”](#) on page 2039
  - [“crypto pki export pkcs12”](#) on page 2040
  - [“crypto pki import pem”](#) on page 2042
  - [“crypto pki import pkcs12”](#) on page 2044
  - [“crypto pki trustpoint”](#) on page 2045
  - [“enrollment \(trustpoint configuration mode\)”](#) on page 2046
  - [“fingerprint \(trustpoint configuration mode\)”](#) on page 2047
  - [“no crypto pki certificate”](#) on page 2049
  - [“rsakeypair \(trustpoint configuration mode\)”](#) on page 2050
  - [“show crypto key mypubkey rsa”](#) on page 2051
  - [“show crypto pki certificates”](#) on page 2052
  - [“show crypto pki enrollment user”](#) on page 2054
  - [“show crypto pki trustpoint”](#) on page 2055
  - [“subject-name \(trustpoint configuration\)”](#) on page 2056



# crypto key generate rsa

**Overview** Use this command to generate a cryptographic public/private key pair for the Rivest-Shamir-Adleman (RSA) encryption algorithm.

**Syntax** `crypto key generate rsa [label <keylabel>] [<1024-4096>]`

| Parameter                      | Description                                                                                                                                                                                                                                                                                 |
|--------------------------------|---------------------------------------------------------------------------------------------------------------------------------------------------------------------------------------------------------------------------------------------------------------------------------------------|
| <code>&lt;keylabel&gt;</code>  | The name of the key to be created. The name must start with an alphanumeric character, and may only contain alphanumeric characters, underscores, dashes, or periods. The maximum length of the name is 63 characters. If no label is specified the default value "server-default" is used. |
| <code>&lt;1024-4096&gt;</code> | The bit length for the key. If no bit length is specified the default of 2048 is used.                                                                                                                                                                                                      |

**Mode** Privileged Exec

**Usage** The generated key may be used for multiple server certificates in the system. A key is referenced by its label. A bit length between 1024 and 4096 bits may be specified. Larger bit lengths are more secure, but require more computation time. The specified key must not already exist.

**Example** To create a key with the label "example-server-key" and a bit length of 2048, use the commands:

```
awplus> enable
awplus# crypto key generate rsa label example-server-key 2048
```

**Related Commands** [crypto key zeroize](#)  
[rsakeypair \(trustpoint configuration mode\)](#)  
[show crypto key mypubkey rsa](#)

# crypto key zeroize

**Overview** Use this command to delete one or all cryptographic public/private key pairs.

**Syntax** `crypto key zeroize rsa <keylabel>`  
`crypto key zeroize all`

| Parameter                         | Description                                                                        |
|-----------------------------------|------------------------------------------------------------------------------------|
| <code>rsa &lt;keylabel&gt;</code> | Delete a single key pair for the Rivest-Shamir-Adleman (RSA) encryption algorithm. |
| <code>all</code>                  | Delete all keys.                                                                   |

**Mode** Privileged Exec

**Usage** Note that this command has the same effect as using the **delete** command (it deletes the file from Flash memory but does not overwrite it with zeros).

The specified key must exist but must not be in use for any existing server certificates.

A key may not be deleted if it is associated with the server certificate or server certificate signing request for an existing trustpoint. To remove a server certificate so that the key may be deleted, use the **no crypto pki enroll** command to de-enroll the server.

**Example** To delete an RSA key named "example-server-key", use the following command:

```
awplus# crypto key zeroize rsa example-server-key
```

**Related Commands** [crypto key generate rsa](#)  
[show crypto key mypubkey rsa](#)

# crypto pki authenticate

**Overview** Use this command to authenticate a trustpoint by generating or importing the root CA certificate. This must be done before the server can be enrolled to the trustpoint.

**Syntax** `crypto pki authenticate <trustpoint>`

| Parameter                       | Description                                     |
|---------------------------------|-------------------------------------------------|
| <code>&lt;trustpoint&gt;</code> | The name of the trustpoint to be authenticated. |

**Mode** Privileged Exec

**Usage** If the trustpoint's **enrollment** setting is "selfsigned", then this command causes a private key to be generated for the root CA, and a self-signed certificate to be generated based on that key.

If the trustpoint's **enrollment** setting is "terminal", then this command prompts the user to paste a certificate Privacy Enhanced Mail (PEM) file at the CLI terminal. If the certificate is a valid selfsigned CA certificate, then it will be stored as the trustpoint's root CA certificate.

The specified trustpoint must already exist, and its enrollment mode must have been defined.

**Example** To show the **enrollment** setting of a trustpoint named "example" and then generate a certificate from it, use the commands:

```
awplus> enable
awplus# configure terminal
awplus(config)# crypto pki trustpoint example
awplus(ca-trustpoint)# enrollment selfsigned
awplus(config)# exit
awplus# exit
awplus# crypto pki authenticate example
```

**Related Commands**

- [crypto pki import pem](#)
- [crypto pki trustpoint](#)
- [enrollment \(trustpoint configuration mode\)](#)

# crypto pki enroll

**Overview** Use this command to enroll the local server to the specified trustpoint.  
Use the **no** variant of this command to de-enroll the server by removing its certificate

**Syntax** `crypto pki enroll <trustpoint>`  
`no crypto pki enroll <trustpoint>`

| Parameter                       | Description                               |
|---------------------------------|-------------------------------------------|
| <code>&lt;trustpoint&gt;</code> | The name of the trustpoint to be enrolled |

**Mode** Privileged Exec

**Usage** For the local server, “enrollment” is the process of creating of a certificate for the server that has been signed by a CA associated with the trustpoint. The public portion of the RSA key pair specified using the `rsa` parameter for the trustpoint will be included in the server certificate.

If the trustpoint represents a locally self-signed certificate authority, then this command results in the direct generation of the server certificate, signed by the root CA for the trustpoint.

If the trustpoint represents an external certificate authority, then this command results in the generation of a Certificate Signing Request (CSR) file, which is displayed at the terminal in Privacy-Enhanced Mail (PEM) format, suitable for copying and pasting into a file or message. The CSR must be sent to the external CA for processing. When the CA replies with the signed certificate, that certificate should be imported using the `crypto pki import pem` command, to complete the enrollment process.

The specified trustpoint must already exist, and it must already be authenticated.

**Example** To enroll the local server with the trustpoint “example”, use the following commands:

```
awplus> enable
awplus# crypto pki enroll example
```

**Related Commands**

- [crypto pki enroll user](#)
- [crypto pki import pem](#)
- [crypto pki trustpoint](#)
- [enrollment \(trustpoint configuration mode\)](#)

# crypto pki enroll user

**Overview** Use this command to enroll a single RADIUS user or all RADIUS users to the specified trustpoint.

Use the **no** variant of this command to remove the PKCS#12 file from the system. Note that the PKCS#12 files are generated in a temporary (volatile) file system, so a system restart also results in removal of all of the files.

**Syntax**

```
crypto pki enroll <trustpoint>
{user <username>|local-radius-all-users}

no crypto pki enroll <trustpoint>
{user <username>|local-radius-all-users}
```

| Parameter    | Description                                                   |
|--------------|---------------------------------------------------------------|
| <trustpoint> | The name of the trustpoint to which users are to be enrolled. |
| <username>   | The name of the user to enroll to the trustpoint.             |

**Mode** Privileged Exec

**Usage** For RADIUS users, “enrollment” is the process of generating a private key and a corresponding client certificate for each user, with the certificate signed by the root CA for the trustpoint. The resulting certificates may be exported to client devices, for use with PEAP or EAP-TLS authentication with the local RADIUS server.

The specified trustpoint must represent a locally self-signed certificate authority.

The private key and certificate are packaged into a PKCS#12-formatted file, suitable for export using the **crypto pki export pkcs12** command. The private key is encrypted for security, with a passphrase that is entered at the command line. The passphrase is required when the PKCS#12 file is imported on the client system. The passphrase is not stored anywhere on the device, so users are responsible for remembering it until the export-import process is complete.

If **local-radius-all-users** is specified instead of an individual user, then keys and certificates for all RADIUS users will be generated at once. All the keys will be encrypted using the same passphrase.

The specified trustpoint must already exist, it must represent a locally self-signed CA, and it must already have been authenticated.

**Example** To enroll the user “example-user” with the trustpoint “example”, use the following commands:

```
awplus> enable
awplus# crypto pki enroll example user example-user
```

To enroll all local RADIUS users with the trustpoint "example", use the following commands:

```
awplus> enable
```

```
awplus# crypto pki enroll example local-radius-all-users
```

**Related  
Commands** [crypto pki export pkcs12](#)  
[crypto pki trustpoint](#)

# crypto pki export pem

**Overview** Use this command to export the root CA certificate for the given trustpoint to a file in Privacy-Enhanced Mail (PEM) format. The file may be transferred to the specified destination URL, or displayed at the terminal.

**Syntax** `crypto pki export <trustpoint> pem [terminal|<url>]`

| Parameter                       | Description                                                                     |
|---------------------------------|---------------------------------------------------------------------------------|
| <code>&lt;trustpoint&gt;</code> | The name of the trustpoint for which the root CA certificate is to be exported. |
| <code>terminal</code>           | Display the PEM file to the terminal.                                           |
| <code>&lt;url&gt;</code>        | Transfer the PEM file to the specified URL.                                     |

**Default** The PEM will be displayed to the terminal by default.

**Mode** Privileged Exec

**Usage** The specified trustpoint must already exist, and it must already be authenticated.

**Example** To display the PEM file for the trustpoint "example" to the terminal, use the following commands:

```
awplus> enable
awplus# crypto pki export example pem terminal
```

To export the PEM file "example.pem" for the trustpoint "example" to the URL "tftp://server\_a/", use the following commands:

```
awplus> enable
awplus# crypto pki export example pem
tftp://server_a/example.pem
```

**Related Commands**

- [crypto pki authenticate](#)
- [crypto pki import pem](#)
- [crypto pki trustpoint](#)

# crypto pki export pkcs12

**Overview** Use this command to export a certificate and private key for an entity in a trustpoint to a file in PKCS#12 format at the specified URL. The private key is encrypted with a passphrase for security.

**Syntax** `crypto pki export <trustpoint> pkcs12 {ca|server|<username>} <url>`

| Parameter    | Description                                                                                                                                                                                                                                        |
|--------------|----------------------------------------------------------------------------------------------------------------------------------------------------------------------------------------------------------------------------------------------------|
| <trustpoint> | The name of the trustpoint for which the certificate and key are to be exported.                                                                                                                                                                   |
| ca           | If this option is specified, the command exports the root CA certificate and corresponding key.                                                                                                                                                    |
| server       | If this option is specified, the command exports the server certificate and corresponding key.                                                                                                                                                     |
| <username>   | If a RADIUS username is specified, the command exports the PKCS#12 file that was previously generated using the <code>crypto pki enroll user</code> command. To avoid ambiguity with keywords, the username may be prefixed by the string "user:". |
| <url>        | The destination URL for the PKCS#12 file. The format of the URL is the same as any valid destination for a file copy command.                                                                                                                      |

**Mode** Privileged Exec

**Usage** If the **ca** option is specified, this command exports the root CA certificate and the corresponding private key, if the trustpoint has been authenticated as a locally selfsigned CA. (If the trustpoint represents an external CA, then there is no private key on the system corresponding to the root CA certificate. Use the **crypto pki export pem** file to export the certificate by itself.) The command prompts for a passphrase to encrypt the private key.

If the **server** option is specified, this command exports the server certificate and the corresponding private key, if the server has been enrolled to the trustpoint. The command prompts for a passphrase to encrypt the private key.

If a RADIUS username is specified, this command exports the PKCS#12 file that was generated using the **crypto pki enroll user** command. (The key within the file was already encrypted as part of the user enrollment process.)

In the event that there is a RADIUS user named "ca" or "server", enter "user:ca" or "user:server" as the username.

The key and certificate must already exist.



**Example** To export the PKCS#12 file "example.pk12" for the trustpoint "example" to the URL "tftp://backup/", use the following commands:

```
awplus> enable
awplus# crypto pki export example pkcs12 ca
tftp://backup/example.pk12
```

**Related  
Commands**

- crypto pki enroll user
- crypto pki export pem
- crypto pki import pkcs12

# crypto pki import pem

**Overview** This command imports a certificate for the given trustpoint from a file in Privacy-Enhanced Mail (PEM) format. The file may be transferred from the specified destination URL, or entered at the terminal.

**Syntax** `crypto pki import <trustpoint> pem [terminal|<url>]`

| Parameter                       | Description                                                                                                                                                                |
|---------------------------------|----------------------------------------------------------------------------------------------------------------------------------------------------------------------------|
| <code>&lt;trustpoint&gt;</code> | The name of the trustpoint for which the root CA certificate is to be imported.                                                                                            |
| <code>terminal</code>           | Optional parameter, If specified, the command prompts the user to enter (or paste) the PEM file at the terminal. If parameter is specified terminal is assumed by default. |
| <code>&lt;url&gt;</code>        | Optional parameter, If specified, the PEM file is transferred from the specified URL                                                                                       |

**Default** The PEM will be imported from the terminal by default.

**Mode** Privileged Exec

**Usage** The command is generally used for trustpoints representing external certificate authorities. It accepts root CA certificates, intermediate CA certificates, and server certificates. The system automatically detects the certificate type upon import.

Using this command to import root CA certificates at the terminal is identical to the functionality provided by the `crypto pki authenticate` command, for external certificate authorities. The imported certificate is validated to ensure it is a proper CA certificate.

Intermediate CA certificates are validated to ensure they are proper CA certificates, and that the issuer chain ends in a root CA certificate already installed for the trustpoint. If there is no root CA certificate for the trustpoint (i.e., if the trustpoint is unauthenticated) then intermediate CA certificates may not be imported.

Server certificates are validated to ensure that the issuer chain ends in a root CA certificate already installed for the trustpoint. If there is no root CA certificate for the trustpoint (i.e., if the trustpoint is unauthenticated) then server certificates may not be imported.

The specified trustpoint must already exist. If the imported certificate is self-signed, then no certificates may exist for the trustpoint. Otherwise, the issuer's certificate must already be present for the trustpoint.

**Example** To import the PEM file for the trustpoint "example" from the terminal, use the following commands:

```
awplus> enable
awplus# crypto pki import example pem
```

To import the PEM file for the trustpoint "example" from the URL "tftp://server\_a/", use the following commands:

```
awplus> enable
awplus# crypto pki import example pem
tftp://server_a/example.pem
```

**Related  
Commands**

- crypto pki authenticate
- crypto pki export pem
- crypto pki trustpoint

# crypto pki import pkcs12

**Overview** This command imports a certificate and private key for an entity in a trustpoint from a file in PKCS#12 format at the specified URL. The command prompts for a passphrase to decrypt the private key within the file.

**Syntax** `crypto pki import <trustpoint> pkcs12 {ca|server} <url>`

| Parameter    | Description                                                                                                              |
|--------------|--------------------------------------------------------------------------------------------------------------------------|
| <trustpoint> | The name of the trustpoint for which the certificate and key are to be imported.                                         |
| ca           | If this option is specified, the command imports the root CA certificate and corresponding key.                          |
| server       | If this option is specified, the command imports the server certificate and corresponding key.                           |
| <url>        | The source URL for the PKCS#12 file. The format of the URL is the same as any valid destination for a file copy command. |

**Mode** Privileged Exec

**Usage** If the **ca** option is specified, this command imports the root CA certificate and the corresponding private key. This is only valid if the root CA certificate does not already exist for the trustpoint (i.e., if the trustpoint is unauthenticated).

If the **server** option is specified, this command imports the server certificate and the corresponding private key. The imported private key is given a new unique label of the form "localN", where N is a non-negative integer. This operation is only valid if the server certificate does not already exist for the trustpoint (i.e., if the server is not enrolled to the trustpoint).

PKCS#12 files for RADIUS users may not be imported with this command. (There is no value in doing so, as the files are not needed on the local system.)

The specified trustpoint must already exist. The key and certificate must not already exist.

**Example** To import the PKCS#12 file "example.pk12" for the trustpoint "example" to the URL "tftp://backup/", use the following commands:

```
awplus> enable
awplus# crypto pki import example pkcs12 ca
tftp://backup/example.pk12
```

**Related Commands** [crypto pki export pkcs12](#)  
[crypto pki import pem](#)

# crypto pki trustpoint

**Overview** Use this command to declare the named trustpoint and enter trustpoint configuration mode.

Use the **no** variant of this command to destroy the trustpoint.

**Syntax** `crypto pki trustpoint <trustpoint>`  
`no crypto pki trustpoint <trustpoint>`

| Parameter                       | Description                                                                                                                                                                                                     |
|---------------------------------|-----------------------------------------------------------------------------------------------------------------------------------------------------------------------------------------------------------------|
| <code>&lt;trustpoint&gt;</code> | The name of the trustpoint. The name must start with an alphanumeric character, and may only contain alphanumeric characters, underscores, dashes, or periods. The maximum length of the name is 63 characters. |

**Mode** Global Configuration

**Usage** If the trustpoint did not previously exist, it is created as a new trustpoint. The trustpoint will be empty (unauthenticated) unless the name "local" is selected, in which case the system will automatically authenticate the trustpoint as a local self-signed certificate authority.

The **no** variant of this command destroys the trustpoint by removing all CA and server certificates associated with the trustpoint, as well as the private key associated with the root certificate (if the root certificate was locally self-signed). This is a destructive and irreversible operation, so this command should be used with caution.

**Example** To configure a trustpoint named "example", use the following commands:

```
awplus> enable
awplus# configure terminal
awplus(config)# crypto pki trustpoint example
```

**Related Commands** [show crypto pki certificates](#)  
[show crypto pki trustpoint](#)

# enrollment (trustpoint configuration mode)

**Overview** Use this command to declare how certificates will be added to the system for the current trustpoint.

**Syntax** `enrollment {selfsigned|terminal}`

| Parameter               | Description                                                        |
|-------------------------|--------------------------------------------------------------------|
| <code>selfsigned</code> | Sets the enrollment mode for the current trustpoint to selfsigned. |
| <code>terminal</code>   | Sets the enrollment mode for the current trustpoint to terminal.   |

**Mode** Trustpoint Configuration

**Usage** If the enrollment is set to **selfsigned**, then the system will generate a root CA certificate and its associated key when the **crypto pki authenticate** command is issued. It will generate a server certificate (signed by the root CA certificate) when the **crypto pki enroll** command is issued.

If the enrollment is set to **terminal**, then the system will prompt the user to paste the root CA certificate Privacy Enhanced Mail (PEM) file at the terminal, when the **crypto pki authenticate** command is issued. It will create a Certificate Signing Request (CSR) file for the local server when the **crypto pki enroll** command is issued. The server certificate received from the external CA should be imported using the **crypto pki import pem** command.

The trustpoint named "local" may only use the **selfsigned** enrollment setting.

If no enrollment mode is specified, the **crypto pki authenticate** command will fail for the trustpoint.

**Example** To configure the trustpoint named "example" and set its enrollment to **selfsigned**, use the following commands:

```
awplus> enable
awplus# configure terminal
awplus(config)# crypto pki trustpoint example
awplus(ca-trustpoint)# enrollment selfsigned
```

**Related Commands** [crypto pki enroll](#)

# fingerprint (trustpoint configuration mode)

**Overview** Use this command to declare that certificates with the specified fingerprint should be automatically accepted, when importing certificates from an external certificate authority. This can affect the behavior of the **crypto pki authenticate** and **crypto pki import pem** commands.

Use the **no** variant of this command to remove the specified fingerprint from the pre-accepted list.

**Syntax** fingerprint <word>  
no fingerprint <word>

| Parameter | Description                                                                                                     |
|-----------|-----------------------------------------------------------------------------------------------------------------|
| <word>    | The fingerprint as a series of 40 hexadecimal characters, optionally separated into multiple character strings. |

**Default** By default, no fingerprints are pre-accepted for the trustpoint.

**Mode** Trustpoint Configuration

**Usage** Specifying a fingerprint adds it to a list of pre-accepted fingerprints for the trustpoint. When a certificate is imported, if it matches any of the pre-accepted values, then it will be saved in the system automatically. If the imported certificate's fingerprint does not match any pre-accepted value, then the user will be prompted to verify the certificate contents and fingerprint visually.

This command is useful when certificates from an external certificate authority are being transmitted over an insecure channel. If the certificate fingerprint is delivered via a separate messaging channel, then pre-entering the fingerprint value via cut-and-paste may be less errorprone than attempting to verify the fingerprint value visually.

The fingerprint is a series of 40 hexadecimal characters. It may be entered as a continuous string, or as a series of up to multiple strings separated by spaces. The input format is flexible because different certificate authorities may provide the fingerprint string in different formats.

**Example** To configure a fingerprint "5A81D34C 759CC4DA CFCA9F65 0303AD83 410B03AF" for the trustpoint named "example", use the following commands:

```
awplus> enable
awplus# configure terminal
awplus(config)# crypto pki trustpoint example
awplus(ca-trustpoint)# fingerprint 5A81D34C 759CC4DA CFCA9F65
0303AD83 410B03AF
```

**Related Commands** [crypto pki authenticate](#)

`crypto pki import pem`



# no crypto pki certificate

**Overview** Use this command to delete a certificate with the specified fingerprint from the specified trustpoint.

**Syntax** no crypto pki certificate *<trustpoint>* *<word>*

| Parameter                 | Description                                                                                                     |
|---------------------------|-----------------------------------------------------------------------------------------------------------------|
| <i>&lt;trustpoint&gt;</i> | The name of the trustpoint.                                                                                     |
| <i>&lt;word&gt;</i>       | The fingerprint as a series of 40 hexadecimal characters, optionally separated into multiple character strings. |

**Default** By default, no fingerprints are pre-accepted for the trustpoint.

**Mode** Privileged Exec

**Usage** The fingerprint can be found in the output of the **show crypto pki certificates** command. If there are dependent certificates in the trustpoint (i.e., if other certificates were signed by the specified certificate), the command will be rejected. If the specified certificate is the root CA certificate and the trustpoint represents a locally selfsigned CA, then the corresponding private key is also deleted from the system. Deleting the root CA certificate effectively resets the trustpoint to an unauthenticated state.

**Example** To delete a certificate with the fingerprint "594EDEF9 C7C4308C 36D408E0 77E784F0 A59E8792" from the trustpoint "example", use the following commands:

```
awplus> enable
awplus# no crypto pki certificate example
594EDEF9 C7C4308C 36D408E0 77E784F0 A59E8792
```

**Related Commands** [no crypto pki trustpoint](#)  
[show crypto pki certificates](#)

# rsakeypair (trustpoint configuration mode)

**Overview** Use this command to declare which RSA key pair should be used to enroll the local server with the trustpoint. Note that this defines the key pair used with the server certificate, not the key pair used with the root CA certificate.

Use the **no** variant of this command to restore the default value, "server-default".

**Syntax** `rsakeypair <keylabel> [<1024-4096>]`  
`no rsakeypair`

| Parameter                      | Description                                                                                                                                                                                                                                             |
|--------------------------------|---------------------------------------------------------------------------------------------------------------------------------------------------------------------------------------------------------------------------------------------------------|
| <code>&lt;keylabel&gt;</code>  | The key to be used with the server certificate for this trustpoint. The name must start with an alphanumeric character, and may only contain alphanumeric characters, underscores, dashes, or periods. The maximum length of the name is 63 characters. |
| <code>&lt;1024-4096&gt;</code> | The bit length for the key, to be used if the key is implicitly generated during server enrollment.                                                                                                                                                     |

**Default** The default value for **keylabel** is "server-default".  
The default value for the key bit length is 2048.

**Mode** Trustpoint Configuration

**Usage** If the label specified does not refer to an existing key created by the **crypto key generate rsa** command, the key will be implicitly generated when the **crypto pki enroll** command is issued to generate the server certificate or the server certificate signing request. The optional numeric parameter defines the bit length for the key, and is only applicable for keys that are implicitly created during enrollment.

This command does not affect server certificates or server certificate signing requests that have already been generated. The trustpoint's server certificate is set to use whatever key pair was specified for the trustpoint at the time the **crypto pki enroll** command is issued.

The default key pair is "server-default". The default bit length is 2048 bits.

**Example** To configure trustpoint "example" to use the key pair "example-server-key" with a bit length of 2048, use the following commands:

```
awplus> enable
awplus# configure terminal
awplus(config)# crypto pki trustpoint example
awplus(ca-trustpoint)# rsakeypair example-server-key 2048
```

**Related Commands** [crypto key generate rsa](#)

# show crypto key mypubkey rsa

**Overview** Use this command to display information about the specified Rivest-Shamir-Adleman encryption key.

**Syntax** `show crypto key mypubkey rsa [<keylabel>]`

| Parameter  | Description                                    |
|------------|------------------------------------------------|
| <keylabel> | The name of the key to be shown, if specified. |

**Default** By default, all keys will be shown.

**Mode** Privileged Exec

**Usage** If no key label is specified, information about all keys is shown. The command displays the bit length of the key, a key fingerprint (a hash of the key contents to help uniquely identify a key), and a list of trustpoints in which the server certificate is using the key.

The specified keys must exist.

**Example** To show all keys, use the following commands:

```
awplus> enable
awplus# show crypto key mypubkey rsa
```

**Output** Figure 46-1: Example output from **show crypto key mypubkey rsa**

```
awplus#show crypto key mypubkey rsa

RSA Key Pair "example-server-key":
 Key size : 2048 bits
 Fingerprint : 1A605D73 C2274CB7 853886B3 1C802FC6 7CDE45FB
 Trustpoints : example

RSA Key Pair "server-default":
 Key size : 2048 bits
 Fingerprint : 34AC4D2D 5249A168 29D426A3 434FFC59 C4A19901
 Trustpoints : local
```

**Related Commands** [crypto key generate rsa](#)

# show crypto pki certificates

**Overview** Use this command to display information about existing certificates for the specified trustpoint.

**Syntax** `show crypto pki certificates [<trustpoint>]`

| Parameter                       | Description                                                |
|---------------------------------|------------------------------------------------------------|
| <code>&lt;trustpoint&gt;</code> | The trustpoint for which the certificates are to be shown. |

**Default** By default, the certificates for all trustpoints are shown.

**Mode** Privileged Exec

**Usage** If no trustpoint is specified, certificates for all trustpoints are shown. The command displays the certificates organized into certificate chains. It starts with the server certificate and then displays its issuer, and continues up the issuer chain until the root CA certificate is reached.

For each certificate, the command displays the certificate type, the subject's distinguished name (the entity identified by the certificate), the issuer's distinguished name (the entity that signed the certificate), the validity dates for the certificate, and the fingerprint of the certificate. The fingerprint is a cryptographic hash of the certificate contents that uniquely identifies the certificate.

The specified trustpoints must already exist.

**Example** To show the certificates for the trustpoint "example", use the following command:

```
awplus> enable
awplus# show crypto pki certificates example
```

**Output** Figure 46-2: Example output from **show crypto pki certificates**

```
awplus>enable
awplus#show crypto pki certificates example

Trustpoint "example" Certificate Chain

Server certificate
 Subject : /O=local/CN=local.loc.lc
 Issuer : /C=NZ/CN=local_Signing_CA
 Valid From : Nov 11 15:35:21 2015 GMT
 Valid To : Aug 31 15:35:21 2018 GMT
 Fingerprint : 5A81D34C 759CC4DA CFCA9F65 0303AD83 410B03AF
Intermediate CA certificate
 Subject : /C=NZ/CN=example_Signing_CA
 Issuer : /C=NZ/CN=example_Root_CA
 Valid From : Sep 3 18:45:01 2015 GMT
 Valid To : Oct 10 18:45:01 2020 GMT
 Fingerprint : AE2D5850 9867D258 ABBEE95E 2E0E3D81 60714920
Imported root certificate
 Subject : /C=NZ/CN=example_Root_CA
 Issuer : /C=NZ/CN=example_Root_CA
 Valid From : Jul 23 18:12:10 2015 GMT
 Valid To : May 12 18:12:10 2025 GMT
 Fingerprint : 594EDEF9 C7C4308C 36D408E0 77E784F0 A59E8792
```

**Related Commands** [crypto pki trustpoint](#)

# show crypto pki enrollment user

**Overview** Use this command to display a list of trustpoints for which RADIUS user enrollments have been performed, using the **crypto pki enroll user** command. This indicates that PKCS#12 files for the user are available for export for the given trustpoints, using the **crypto pki export pkcs12** command.

**Syntax** `crypto pki enrollment user <username>`

| Parameter                     | Description                                     |
|-------------------------------|-------------------------------------------------|
| <code>&lt;username&gt;</code> | The user for which enrollments are to be shown. |

**Mode** Privileged Exec

**Example** To show the list of trustpoints to which user "exampleuser1" is enrolled, use the following commands:

```
awplus> enable
awplus(config)# show crypto pki enrollment user exampleuser1
```

**Output** Figure 46-3: Example output from **show crypto pki enrollment user**

```
awplus> enable
awplus# show crypto pki enrollment user exampleuser1
User "exampleuser1" is enrolled to the following trustpoints:
local,example
```

**Related Commands** [crypto pki enroll user](#)  
[crypto pki export pkcs12](#)

# show crypto pki trustpoint

**Overview** Use this command to display information about the specified trustpoint.

**Syntax** `show crypto pki trustpoint [<trustpoint>]`

| Parameter                       | Description                            |
|---------------------------------|----------------------------------------|
| <code>&lt;trustpoint&gt;</code> | The name of the trustpoint to be shown |

**Default** By default, all trustpoints are shown.

**Mode** Privileged Exec

**Usage** If no trustpoint is specified, information about all trustpoints is shown. The command displays the authentication status of the trustpoint, the fingerprint of the root CA certificate (if it exists), the enrollment status of the local server with the trustpoint, a list of any applications that are configured to use the trustpoint, and the trustpoint parameters that were configured from trustpoint-configuration mode.

The specified trustpoints must already exist.

**Example** To show the details of the trustpoint "example", use the following commands:

```
awplus> enable
awplus# show crypto pki trustpoint example
```

**Output** Figure 46-4: Example output from **show crypto pki trustpoint**

```
awplus> enable
awplus# show crypto pki trustpoint example

Trustpoint "example"
 Type : Self-signed certificate authority
 Root Certificate: 50C1856B EEC7555A 0F3A61F6 690D9463 67DF74D1
 Local Server : The server is enrolled to this trustpoint.
 Server Key : example-server-key
 Applications : RADIUS

Authentication and Enrollment Parameters:
 Enrollment : selfsigned
 RSA Key Pair : example-server-key (2048 bits)

```

**Related Commands** [crypto pki trustpoint](#)  
[show crypto pki certificates](#)

# subject-name (trustpoint configuration)

**Overview** Use this command to specify the distinguished name string that should be used for the subject field in the server certificate, when enrolling the server (generating the server certificate or server certificate signing request).

**Syntax** `subject-name <word>`

| Parameter                 | Description                                                                                                                                                   |
|---------------------------|---------------------------------------------------------------------------------------------------------------------------------------------------------------|
| <code>&lt;word&gt;</code> | Specify the subject name as a distinguished name string. Complex strings (e.g., strings containing spaces) should be surrounded with double-quote characters. |

**Default** If no subject name is specified for the trustpoint, then the system automatically builds a name of the form `/O=AlliedWare Plus/CN=xxxx.yyyy.zzz`, where `xxxx` is the hostname of the system and `yyyy.zzz` is the default search domain for the system.

**Mode** Trustpoint Configuration

**Usage** The subject name is specified as a variable number of fields, where each field begins with a forward-slash character (`/`). Each field is of the form `XX=value`, where `XX` is the abbreviation of the node type in the tree.

Common values include:

- `"C"` (country),
- `"ST"` (state),
- `"L"` (locality),
- `"O"` (organization),
- `"OU"` (organizational unit), and
- `"CN"` (common name).

Of these fields, `"CN"` is usually the most important.

**NOTE:** For a server certificate, many applications require that the network name of the server matches the common name in the server's certificate.

**Example** To configure the trustpoint named "example" and set its subject name, use the following commands:

```
awplus> enable
awplus# configure terminal
awplus(config)# crypto pki trustpoint example
awplus(ca-trustpoint)# subject-name "/O=My
Company/CN=192.168.1.1
```



**Related  
Commands** `crypto pki enroll`

# 47

# TACACS+ Commands

## Introduction

**Overview** This chapter provides an alphabetical reference for commands used to configure the device to use TACACS+ servers. For more information about TACACS+, see the [TACACS+ Feature Overview and Configuration Guide](#).

- Command List**
- [“authorization commands”](#) on page 2059
  - [“aaa authorization commands”](#) on page 2061
  - [“aaa authorization config-commands”](#) on page 2063
  - [“ip tacacs source-interface”](#) on page 2064
  - [“show tacacs+”](#) on page 2065
  - [“tacacs-server host”](#) on page 2067
  - [“tacacs-server key”](#) on page 2069
  - [“tacacs-server timeout”](#) on page 2070

# authorization commands

**Overview** This command applies a command authorization method list, defined using the [aaa authorization commands](#) command, to console and VTY lines.

Use the **no** variant of this command to reset the command authorization configuration on the console and VTY lines.

**Syntax** `authorization commands <privilege-level> {default|<list-name>}`  
`no authorization commands <privilege-level>`

| Parameter                            | Description                                                                                                                                                                                                                                                                                                                                                                                                                                                                                     |
|--------------------------------------|-------------------------------------------------------------------------------------------------------------------------------------------------------------------------------------------------------------------------------------------------------------------------------------------------------------------------------------------------------------------------------------------------------------------------------------------------------------------------------------------------|
| <code>&lt;privilege-level&gt;</code> | The privilege level of the set of commands the method list will be applied to.<br>AlliedWare Plus defines three sets of commands, that are indexed by a level value:<br><b>Level = 1:</b> All commands that can be accessed by a user with privilege level between 1 and 6 inclusive<br><b>Level = 7:</b> All commands that can be accessed by a user with privilege level between 7 and 14 inclusive<br><b>Level = 15:</b> All commands that can be accessed by a user with privilege level 15 |
| <code>default</code>                 | Configure the default authorization commands method list.                                                                                                                                                                                                                                                                                                                                                                                                                                       |
| <code>&lt;list-name&gt;</code>       | Configure a named authorization commands method list                                                                                                                                                                                                                                                                                                                                                                                                                                            |

**Default** The **default** method list is applied to each console and VTY line by default.

**Mode** Line Configuration

**Usage** If the specified method list does not exist users will not be able to execute any commands in the specified method list on the specified VTY lines.

**Example** To apply the TAC15 command authorization method list with privilege level 15 to VTY lines 0 to 5, use the following commands:

```
awplus# configure terminal
awplus(config)# line vty 0 5
awplus(config-line)# authorization commands 15 TAC15
```

To reset the command authorization configuration with privilege level 15 on VTY lines 0 to 5, use the following commands:

```
awplus# configure terminal
awplus(config)# line vty 0 5
awplus(config-line)# no authorization commands 15
```

**Related Commands** [aaa authorization commands](#)

aaa authorization config-commands

tacacs-server host

**Command changes** Version 5.4.6-2.1: command added

# aaa authorization commands

**Overview** This command configures a method list for commands authorization that can be applied to console or VTY lines. When command authorization is enabled for a privilege level, only authorized users can executed commands in that privilege level.

Use the **no** variant of this command to remove a named method list or disable the default method list for a privilege level.

**Syntax**

```
aaa authorization commands <privilege-level>
{default|<list-name>} group tacacs+ [none]

no aaa authorization commands <privilege-level>
{default|<list-name>}
```

| Parameter         | Description                                                                                                                                                                                                                                                                                                                                                                                                                                                                                  |
|-------------------|----------------------------------------------------------------------------------------------------------------------------------------------------------------------------------------------------------------------------------------------------------------------------------------------------------------------------------------------------------------------------------------------------------------------------------------------------------------------------------------------|
| <privilege-level> | The privilege level of the set of commands the method list will be applied to. AlliedWare Plus defines three sets of commands, that are indexed by a level value:<br><b>Level = 1:</b> All commands that can be accessed by a user with privilege level between 1 and 6 inclusive<br><b>Level = 7:</b> All commands that can be accessed by a user with privilege level between 7 and 14 inclusive<br><b>Level = 15:</b> All commands that can be accessed by a user with privilege level 15 |
| group             | Specify the server group where authorization messages are sent. Only the <code>tacacs+</code> group is available for this command.                                                                                                                                                                                                                                                                                                                                                           |
| tacacs+           | Use all TACACS+ servers configured by the <code>tacacs-server host</code> command.                                                                                                                                                                                                                                                                                                                                                                                                           |
| default           | Configure the default authorization commands method list.                                                                                                                                                                                                                                                                                                                                                                                                                                    |
| <list-name>       | Configure a named authorization commands method list                                                                                                                                                                                                                                                                                                                                                                                                                                         |
| none              | If specified, this provides a local fallback to command authorization so that if authorization servers become unavailable then the device will accept all commands normally allowed for the privilege level of the user.                                                                                                                                                                                                                                                                     |

**Mode** Global Configuration

**Usage** TACACS+ command authorization provides centralized control of the commands available to a user of an AlliedWare Plus device. Once enabled:

- The command string and username are encrypted and sent to the first available configured TACACS+ server (the first server configured) for authorization.

- The TACACS+ server decides if the user is authorized to execute the command and returns the decision to the AlliedWare Plus device.
- Depending on this decision the device will then either execute the command or notify the user that authorization has failed.

If multiple TACACS+ servers are configured, and the first server is unreachable or does not respond, the other servers will be queried, in turn, for an authorization decision. If all servers are unreachable and a local fallback has been configured, with the **none** parameter, then commands are authorized based on the user's privilege level; the same behavior as if command authorization had not been configured. If, however, the local fallback is not configured and all servers become unreachable then all commands except **logout**, **exit**, and **quit** will be denied.

The **default** method list is defined with a local fallback unless configured differently using this command.

**Example** To configure a commands authorization method list, named TAC15, using all TACACS+ servers to authorize commands for privilege level 15, with a local fallback, use the following commands:

```
awplus# configure terminal
awplus(config)# aaa authorization commands 15 TAC15 group
tacacs+ none
```

To configure the default method list to authorize commands for privilege level 7, with no local fallback, use the following commands:

```
awplus# configure terminal
awplus(config)# aaa authorization commands 7 default group
tacacs+
```

To remove the authorization method list TAC15, use the following commands:

```
awplus# configure terminal
awplus(config)# no aaa authorization commands 15 TAC15
```

**Related Commands** [aaa authorization config-commands](#)  
[authorization commands](#)  
[tacacs-server host](#)

**Command changes** Version 5.4.6-2.1: command added

# aaa authorization config-commands

**Overview** Use this command to enable command authorization on configuration mode commands. By default, command authorization applies to commands in exec mode only.

Use the **no** variant of this command to disable command authorization on configuration mode commands.

**Syntax** `aaa authorization config-commands`  
`no aaa authorization config-commands`

**Default** By default, command authorization is disabled on configuration mode commands.

**Mode** Global Configuration

**Usage** If authorization of configuration mode commands is not enabled then all configuration commands are accepted by default, including command authorization commands.

**NOTE:** *Authorization of configuration commands is required for a secure TACACS+ command authorization configuration as it prevents the feature from being disabled to gain access to unauthorized exec mode commands.*

**Example** To enable command authorization for configuration mode commands, use the commands:

```
awplus# configure terminal
awplus(config)# aaa authorization config-commands
```

To disable command authorization for configuration mode commands, use the commands:

```
awplus# configure terminal
awplus(config)# no aaa authorization config-commands
```

**Related Commands** [aaa authorization commands](#)  
[authorization commands](#)  
[tacacs-server host](#)

**Command changes** Version 5.4.6-2.1: command added

# ip tacacs source-interface

**Overview** This command sets the source interface, or IP address, to use for all TACACS+ packets sent from the device. By default, TACACS+ packets use the source IP address of the egress interface.

Use the **no** variant of this command to remove the source interface configuration and use the source IP address of the egress interface.

**Syntax** `ip tacacs source-interface {<interface>|<ip-address>}`  
`no ip tacacs source-interface`

| Parameter                       | Description                                      |
|---------------------------------|--------------------------------------------------|
| <code>&lt;interface&gt;</code>  | Interface name.                                  |
| <code>&lt;ip-address&gt;</code> | IP address in the dotted decimal format A.B.C.D. |

**Default** The source IP address of outgoing TACACS+ packets default to the IP address of the egress interface.

**Mode** Global Configuration

**Usage** Setting the source interface ensures that all TACACS+ packets sent from the device will have the same source IP address. Once configured this affects all TACACS+ packets, namely accounting, authentication, and authorization.

If the specified interface is down or there is no IP address on the interface, then the source IP address of outgoing TACACS+ packets will default to the IP address of the egress interface.

**Example** To configure all outgoing TACACS+ packets to use the IP address of the loop-back "lo" interface as the source IP address, use the following commands:

```
awplus# configure terminal
awplus(config)# ip tacacs source-interface lo
```

To reset the source interface configuration for all TACACS+ packets, use the following commands:

```
awplus# configure terminal
awplus(config)# no ip tacacs source-interface
```

**Related Commands** [tacacs-server host](#)  
[show tacacs+](#)

**Command changes** Version 5.4.6-2.1: command added



# show tacacs+

**Overview** This command displays the current TACACS+ server configuration and status.

**Syntax** show tacacs+

**Mode** User Exec and Privileged Exec

**Example** To display the current status of TACACS+ servers, use the command:

```
awplus# show tacacs+
```

**Output** Figure 47-1: Example output from the **show tacacs+** command

```
TACACS+ Global Configuration
 Source Interface : not configured
 Timeout : 5 sec

Server Host/ Server
IP Address Status

192.168.1.10 Alive
192.168.1.11 Unknown
```

**Table 1:** Parameters in the output of the **show tacacs+** command

| Output Parameter       | Meaning                                                                              |                                                                              |
|------------------------|--------------------------------------------------------------------------------------|------------------------------------------------------------------------------|
| Source Interface       | IP address of source interface if set with <code>ip tacacs source-interface</code> . |                                                                              |
| Timeout                | A time interval in seconds.                                                          |                                                                              |
| Server Host/IP Address | TACACS+ server hostname or IP address.                                               |                                                                              |
| Server Status          | The status of the authentication port.                                               |                                                                              |
|                        | Alive                                                                                | The server is alive.                                                         |
|                        | Dead                                                                                 | The server has timed out.                                                    |
|                        | Error                                                                                | The server is not responding or there is an error in the key string entered. |
|                        | Unknown                                                                              | The server is never used or the status is unknown.                           |
|                        | Unreachable                                                                          | The server is unreachable.                                                   |
| Unresolved             | The server name can not be resolved.                                                 |                                                                              |

**Command changes** Version 5.4.6-2.1: **Source Interface** parameter added

# tacacs-server host

**Overview** Use this command to specify a remote TACACS+ server host for authentication, authorization and accounting, and to set the shared secret key to use with the TACACS+ server. The parameters specified with this command override the corresponding global parameters for TACACS+ servers.

Use the **no** variant of this command to remove the specified server host as a TACACS+ authentication and authorization server.

**Syntax** `tacacs-server host {<host-name>|<ip-address>} [key [8]<key-string>]`  
`no tacacs-server host {<host-name>|<ip-address>}`

| Parameter                       | Description                                                                                                                                                                                                                                                                                                                                                                                                                 |
|---------------------------------|-----------------------------------------------------------------------------------------------------------------------------------------------------------------------------------------------------------------------------------------------------------------------------------------------------------------------------------------------------------------------------------------------------------------------------|
| <code>&lt;host-name&gt;</code>  | Server host name. The DNS name of the TACACS+ server host.                                                                                                                                                                                                                                                                                                                                                                  |
| <code>&lt;ip-address&gt;</code> | The IP address of the TACACS+ server host, in dotted decimal notation A.B.C.D.                                                                                                                                                                                                                                                                                                                                              |
| <code>key</code>                | Set shared secret key with TACACS+ servers.                                                                                                                                                                                                                                                                                                                                                                                 |
| <code>8</code>                  | Specifies that you are entering a password as a string that has already been encrypted instead of entering a plain text password. The running config displays the new password as an encrypted string even if password encryption is turned off.                                                                                                                                                                            |
| <code>&lt;key-string&gt;</code> | Shared key string applied, a value in the range 1 to 64 characters. Specifies the shared secret authentication or encryption key for all TACACS+ communications between this device and the TACACS+ server. This key must match the encryption used on the TACACS+ server. This setting overrides the global setting of the <code>tacacs-server key</code> command. If no key value is specified, the global value is used. |

**Default** No TACACS+ server is configured by default.

**Mode** Global Configuration

**Usage** A TACACS+ server host cannot be configured multiple times like a RADIUS server.

As many as four TACACS+ servers can be configured and consulted for login authentication, enable password authentication and accounting. The first server configured is regarded as the primary server and if the primary server fails then the backup servers are consulted in turn. A backup server is consulted if the primary server fails, not if a login authentication attempt is rejected. The reasons a server would fail are:

- it is not network reachable
- it is not currently TACACS+ capable

- it cannot communicate with the switch properly due to the switch and the server having different secret keys

**Examples** To add the server `tacl.company.com` as the TACACS+ server host, use the following commands:

```
awplus# configure terminal
awplus(config)# tacacs-server host tacl.company.com
```

To set the secret key to `secret` on the TACACS+ server `192.168.1.1`, use the following commands:

```
awplus# configure terminal
awplus(config)# tacacs-server host 192.168.1.1 key secret
```

To remove the TACACS+ server `tacl.company.com`, use the following commands:

```
awplus# configure terminal
awplus(config)# no tacacs-server host tacl.company.com
```

**Related  
Commands**

- [aaa accounting commands](#)
- [aaa authentication login](#)
- [tacacs-server key](#)
- [tacacs-server timeout](#)
- [show tacacs+](#)

# tacacs-server key

**Overview** This command sets a global secret key for TACACS+ authentication, authorization and accounting. The shared secret text string is used for TACACS+ communications between the switch and all TACACS+ servers.

Note that if no secret key is explicitly specified for a TACACS+ server with the [tacacs-server host](#) command, the global secret key will be used for the shared secret for the server.

Use the **no** variant of this command to remove the global secret key.

**Syntax** `tacacs-server key [8] <key-string>`  
`no tacacs-server key`

| Parameter    | Description                                                                                                                                                                                                                                                                 |
|--------------|-----------------------------------------------------------------------------------------------------------------------------------------------------------------------------------------------------------------------------------------------------------------------------|
| 8            | Specifies a string in an encrypted format instead of plain text. The running config will display the new password as an encrypted string even if password encryption is turned off.                                                                                         |
| <key-string> | Shared key string applied, a value in the range 1 to 64 characters. Specifies the shared secret authentication or encryption key for all TACACS+ communications between this device and all TACACS+ servers. This key must match the encryption used on the TACACS+ server. |

**Mode** Global Configuration

**Usage** Use this command to set the global secret key shared between this client and its TACACS+ servers. If no secret key is specified for a particular TACACS+ server using the [tacacs-server host](#) command, this global key is used.

**Examples** To set the global secret key to `secret` for TACACS+ server, use the following commands:

```
awplus# configure terminal
awplus(config)# tacacs-server key secret
```

To delete the global secret key for TACACS+ server, use the following commands:

```
awplus# configure terminal
awplus(config)# no tacacs-server key
```

**Related Commands** [tacacs-server host](#)  
[show tacacs+](#)

# tacacs-server timeout

**Overview** Use this command to specify the TACACS+ global timeout value. The timeout value is how long the device waits for a reply to a TACACS+ request before considering the server to be dead.

Note that this command configures the **timeout** parameter for TACACS+ servers globally.

The **no** variant of this command resets the transmit timeout to the default (5 seconds).

**Syntax** `tacacs-server timeout <seconds>`  
`no tacacs-server timeout`

| Parameter                    | Description                                                |
|------------------------------|------------------------------------------------------------|
| <code>&lt;seconds&gt;</code> | TACACS+ server timeout in seconds, in the range 1 to 1000. |

**Default** The default timeout value is 5 seconds.

**Mode** Global Configuration

**Examples** To set the timeout value to 3 seconds, use the following commands:

```
awplus# configure terminal
awplus(config)# tacacs-server timeout 3
```

To reset the timeout period for TACACS+ servers to the default, use the following commands:

```
awplus# configure terminal
awplus(config)# no tacacs-server timeout
```

**Related Commands** [tacacs-server host](#)  
[show tacacs+](#)

# Part 6: High Availability

# 48

# High Availability Commands

## Introduction

**Overview** This chapter provides an alphabetical reference of commands used to configure high availability. For more information, see the [High Availability Feature Overview and Configuration\\_Guide](#).

**Command List** • [“ha associate”](#) on page 2073



# ha associate

**Overview** This command is used to change the mode of a VRRP session to High Availability (HA) mode, and to associate it with a HA bypass port.

Use the **no** variant of this command to take the VRRP session out of HA-Mode.

**Syntax** `ha associate [wan-bypass <1-2>]`  
`no ha associate [wan-bypass <1-2>]`

| Parameter                       | Description                               |
|---------------------------------|-------------------------------------------|
| <code>&lt;wan-bypass&gt;</code> | The control wan bypass port.              |
| <code>&lt;1-2&gt;</code>        | The identifier number of wan bypass port. |

**Default** The default state of bypass port 1 and port 2 is deactivated.

**Mode** Router Configuration

**Usage** One VRRP session can have the control of one or two bypass ports. After VRRP has the control of the wan-bypass ports, the state of the wan-bypass ports will be determined by the VRRP state. If the VRRP session is in master state, then the associated wan-bypass ports will be deactivated. If the VRRP session is in backup or initial state, then the associated wan-bypass ports will be activated.

If no wan-bypass ports are specified, then it puts the VRRP session in HA mode and the wan-bypass ports will always be deactivated.

If there are one or more VRRP sessions running in HA mode, then the wan-bypass ports should not be controlled by an other feature.

**Examples** To change a VRRP session into HA mode, use the following commands:

```
awplus#configure terminal
awplus(config)#router vrrp 1 vlan1
awplus(config-router)#ha associate
```

To change a VRRP session into HA mode and allow it to control wan-bypass port 1, use the following commands:

```
awplus#configure terminal
awplus(config)#vrrp 1 vlan1
awplus(config-router)#ha associate wan-bypass 1
```

To change a VRRP session to stop control of a wan-bypass port 1, use the following commands:

```
awplus#configure terminal
awplus(config)#router vrrp 1 vlan1
awplus(config-router)#no ha associate wan-bypass 1
```

To change a VRRP session out of HA-mode, use the following commands:

```
awplus#configure terminal
awplus(config)#router vrrp 1 vlan1
awplus(config-router)#no ha associate
```

**Related  
Commands** [show vrrp](#)

# 49

# VRRP Commands

## Introduction

**Overview** This chapter provides an alphabetical reference for commands used to configure the Virtual Router Redundancy Protocol (VRRP). For more information, see the [VRRP Feature Overview and Configuration Guide](#).

For information on filtering and saving command output, see the [“Getting Started with AlliedWare Plus” Feature Overview and Configuration Guide](#).

- Command List**
- [“advertisement-interval”](#) on page 2077
  - [“alternate-checksum-mode”](#) on page 2079
  - [“circuit-failover”](#) on page 2080
  - [“debug vrrp”](#) on page 2082
  - [“debug vrrp events”](#) on page 2083
  - [“debug vrrp packet”](#) on page 2084
  - [“disable \(VRRP\)”](#) on page 2085
  - [“enable \(VRRP\)”](#) on page 2086
  - [“preempt-mode”](#) on page 2087
  - [“priority”](#) on page 2089
  - [“router ipv6 vrrp \(interface\)”](#) on page 2091
  - [“router vrrp \(interface\)”](#) on page 2093
  - [“show debugging vrrp”](#) on page 2095
  - [“show running-config router ipv6 vrrp”](#) on page 2096
  - [“show running-config router vrrp”](#) on page 2097
  - [“show vrrp”](#) on page 2098
  - [“show vrrp counters”](#) on page 2100
  - [“show vrrp ipv6”](#) on page 2103

- [“show vrrp \(session\)”](#) on page 2104
- [“transition-mode”](#) on page 2106
- [“undebug vrrp”](#) on page 2108
- [“undebug vrrp events”](#) on page 2109
- [“undebug vrrp packet”](#) on page 2110
- [“virtual-ip”](#) on page 2111
- [“virtual-ipv6”](#) on page 2113
- [“vrrp vmac”](#) on page 2115

# advertisement-interval

**Overview** Use this command to configure the advertisement interval of the virtual router. This is the length of time, in seconds, between each advertisement sent from the master to its backup(s).

IPv6 VRRP advertisements are sent to the multicast address assigned to the VRRP group (ff02:0:0:0:0) and a backup virtual router has to join all multicast groups within this range. VRRP advertisements are sent to a multicast address (ff02::12) every second by default.

Use the **no** variant of this command to remove an advertisement interval of the virtual router, which has been set using the **advertisement-interval** command, and revert to the default advertisement interval of 1 second.

**Syntax** advertisement-interval [**<1-255>**|csec **<1-4095>**]  
no advertisement-interval

| Parameter             | Description                                                         |
|-----------------------|---------------------------------------------------------------------|
| <b>&lt;1-255&gt;</b>  | Specifies the advertisement interval in seconds.                    |
| csec                  | Use centiseconds instead of seconds for the advertisement interval. |
| <b>&lt;1-4095&gt;</b> | Specifies the advertisement interval in centiseconds.               |

**Default** The default advertisement interval is 1 second.

**Mode** Router Configuration

**Usage** See the [VRRP Feature Overview and Configuration Guide](#) for more information about:

- setting the advertisement-interval when configuring VRRP
- using seconds for VRRPv2 host compatibility whenever you use [transition-mode](#) to upgrade or transition from VRRPv2 to VRRPv3
- VRRPv3 IPv4 configuration details
- VRRPv3 IPv6 configuration details

**Examples** The example below shows you how to configure the advertisement interval to 6 seconds for the VRRP IPv4 session with VR ID 5 on interface vlan2:

```
awplus# configure terminal
awplus(config)# router vrrp 5 vlan2
awplus(config-router)# advertisement-interval 6
```

The example below shows you how to reset the advertisement interval to the default of 1 second for the VRRP IPv4 session with VR ID 5 on interface vlan2:

```
awplus# configure terminal
awplus(config)# router vrrp 5 vlan2
awplus(config-router)# no advertisement-interval
```

The example below shows you how to configure the advertisement interval to 6 seconds for the VRRPv3 IPv6 session with VR ID 5 on interface vlan2:

```
awplus# configure terminal
awplus(config)# router ipv6 vrrp 5 vlan2
awplus(config-router)# advertisement-interval 6
```

**Related  
Commands**    [router vrrp \(interface\)](#)  
                  [router ipv6 vrrp \(interface\)](#)

# alternate-checksum-mode

**Overview** Use this command to enable an alternate checksum mode for VRRPv3 to allow inter-operability with some other vendors' products. The IPv4 checksum for VRRPv3 advertisements will then use a pseudo header in the calculation.

This mode may be required if the other product indicates checksum errors on VRRP packets sent by AlliedWare Plus devices.

Use the **no** variant of this command to disable the alternate checksum mode.

**Syntax** `alternate-checksum-mode`  
`no alternate-checksum-mode`

**Default** Disabled

**Mode** Router Configuration

**Example** To turn on the alternate checksum mode for VRRP instance 1 on VLAN1, use the commands:

```
awplus# configure terminal
awplus(config)# router vrrp 1 vlan1
awplus(config-router)# alternate-checksum-mode
```

To turn off the alternate checksum mode for VRRP instance 1 on VLAN1, use the commands:

```
awplus# configure terminal
awplus(config)# router vrrp 1 vlan1
awplus(config-router)# no alternate-checksum-mode
```

**Related Commands** [show running-config](#)

**Command changes** Version 5.4.7-1.1: command added

# circuit-failover

**Overview** Use this command to enable the VRRP circuit failover feature.

Circuit failover enables the device to take action if the uplink interface goes down, so that the VRRP backup, whose uplink interface is still active, takes over as VRRP master. See the Usage section below and the [VRRP Feature Overview and Configuration Guide](#) for more information.

Use the **no** variant of this command to disable this feature.

**Syntax** `circuit-failover <interface> <1-253>`  
`no circuit-failover [<interface> <1-253>]`

| Parameter                      | Description                                                                                                                                                                                                                                                                                                                                                                                  |
|--------------------------------|----------------------------------------------------------------------------------------------------------------------------------------------------------------------------------------------------------------------------------------------------------------------------------------------------------------------------------------------------------------------------------------------|
| <code>&lt;interface&gt;</code> | The interface of the router that is monitored. The interface must exist on the router, and is usually an upstream interface. Should the interface go down, then another router that is configured as a backup router in the group takes over as the master. You should configure the circuit failover on an interface other than the active VRRP interface - generally the uplink interface. |
| <code>&lt;1-253&gt;</code>     | Delta value. The value by which virtual routers decrement their priority value during a circuit failover event. Configure this value to be greater than the difference of priorities on the master and backup routers. In the case of failover, this priority delta value is subtracted from the current VR Master Router priority value.                                                    |

**Mode** Router Configuration

**Usage** You can use Circuit Failover to monitor up to 32 interfaces per VRRP instance. If a VRRP instance is configured to monitor multiple interfaces, the VRRP priority will be cumulatively decremented by the configured delta for each interface as it goes down.

For example, if VRRP is configured to monitor VLAN2 and VLAN3 with the commands:

```
awplus# configure terminal
awplus(config)# interface vlan1
awplus(config-if)# ip address 192.168.1.1/24
awplus(config-if)# exit
awplus(config)# router vrrp 1 vlan1
awplus(config-router)# virtual-ip 192.168.1.10 backup
awplus(config-router)# priority 100
awplus(config-router)# circuit-failover vlan2 10
awplus(config-router)# circuit-failover vlan3 20
```



then the following examples explain the effect of each VLAN going down:

- If only VLAN2 fails, then the VRRP priority will be decremented by 10. VRRP priority would be adjusted to become 90, because  $100 - 10 = 90$ .
- If only VLAN3 fails, then the VRRP priority will be decremented by 20. VRRP priority would be adjusted to become 80, because  $100 - 20 = 80$ .
- If both VLAN2 and VLAN3 fail, then the VRRP priority will be decremented by the cumulative delta values of all monitored interfaces. VRRP priority would therefore be adjusted to become 70, because  $100 - 10 - 20 = 70$ .

As each monitored interface recovers, the VRRP priority is incremented by the same delta value.

When you configure the delta values of the monitored interfaces, make sure their sum is high enough to ensure that the VRRP priority stays above zero if all the interfaces go down.

**Examples** To configure circuit failover on an IPv4 VRRP instance, so that if interface VLAN3 goes down, then the priority of VRRP instance 1 is reduced by 30, use the commands:

```
awplus# configure terminal
awplus(config)# router vrrp 1 vlan2
awplus(config-router)# circuit-failover vlan3 30
```

To remove all configured circuit failovers for the VRRP IPv4 session with VR ID 1 on interface vlan2, use the commands:

```
awplus# configure terminal
awplus(config)# router vrrp 1 vlan2
awplus(config-router)# no circuit-failover
```

To configure circuit failover on a VRRPv3 IPv6 session with VR ID 1, so that when interface VLAN3 goes down, the priority of VRRP instance 1 is reduced by 30, use the commands:

```
awplus# configure terminal
awplus(config)# router ipv6 vrrp 1 vlan2
awplus(config-router)# circuit-failover vlan3 30
```

To remove all configured circuit failovers for the VRRPv3 IPv6 session with VR ID 1 on interface vlan2, use the commands:

```
awplus# configure terminal
awplus(config)# router ipv6 vrrp 1 vlan2
awplus(config-router)# no circuit-failover
```

**Related Commands** [router vrrp \(interface\)](#)  
[router ipv6 vrrp \(interface\)](#)

# debug vrrp

**Overview** Use this command to specify debugging options for VRRP. The **all** parameter turns on all the debugging options.

Use the **no** variant of this command to disable this function.

**Syntax** `debug vrrp [all]`  
`no debug vrrp [all]`

**Mode** Privileged Exec and Global Configuration

**Usage** See the [VRRP Feature Overview and Configuration Guide](#) for more information about VRRPv3 debugging details.

**Examples** The example below shows you how to enable all debugging for VRRP:

```
awplus# configure terminal
awplus(config)# debug vrrp all
```

The example below shows you how to disable all debugging for VRRP:

```
awplus# configure terminal
awplus(config)# no debug vrrp all
```

**Related Commands** [show debugging vrrp](#)  
[undebug vrrp](#)

# debug vrrp events

**Overview** Use this command to specify debugging options for VRRP event troubleshooting. Use the **no** variant of this command to disable this function.

**Syntax** `debug vrrp events`  
`no debug vrrp events`

**Mode** Privileged Exec and Global Configuration

**Usage** The **debug vrrp events** command enables the display of debug information related to VRRP internal events.  
See the [VRRP Feature Overview and Configuration Guide](#) for more information about VRRPv3 debugging details.

**Examples** The example below shows you how to enable events debugging for VRRP:

```
awplus# configure terminal
awplus(config)# debug vrrp events
```

The example below shows you how to disable events debugging for VRRP:

```
awplus# configure terminal
awplus(config)# no debug vrrp events
```

**Related Commands** [show debugging vrrp](#)  
[undebug vrrp events](#)

# debug vrrp packet

**Overview** Use this command to specify debugging options for VRRP packets.  
Use the **no** variant of this command to disable this function.

**Syntax** debug vrrp packet [send|recv]  
no debug vrrp packet [send|recv]

| Parameter | Description                                          |
|-----------|------------------------------------------------------|
| send      | Specifies the debug option set for sent packets.     |
| recv      | Specifies the debug option set for received packets. |

**Mode** Privileged Exec and Global Configuration

**Usage** The **debug vrrp packet** command enables the display of debug information related to the sending and receiving of packets.

See the [VRRP Feature Overview and Configuration Guide](#) for more information about VRRPv3 debugging details.

**Examples** The example below shows you how to enable received and sent packet debugging for VRRP:

```
awplus# configure terminal
awplus(config)# debug vrrp packet
```

The example below shows you how to enable only received packet debugging for VRRP:

```
awplus# configure terminal
awplus(config)# debug vrrp packet recv
```

The example below shows you how to enable only sent packet debugging for VRRP:

```
awplus# configure terminal
awplus(config)# debug vrrp packet send
```

The example below shows you how to disable packet debugging for VRRP:

```
awplus# configure terminal
awplus(config)# no debug vrrp packet
```

**Related Commands** [show debugging vrrp](#)  
[undebug vrrp packet](#)

# disable (VRRP)

**Overview** Use this command to disable a VRRP IPv4 session or a VRRPv3 IPv6 session on the router to stop it participating in virtual routing. Note that when this command is configured then a backup router assumes the role of master router depending on its priority. See the [enable \(VRRP\)](#) command to enable a VRRP IPv4 session or a VRRPv3 IPv6 session on the router.

**Syntax** `disable`

**Mode** Router Configuration

**Usage** See the [VRRP Feature Overview and Configuration Guide](#) for more information about VRRPv3 IPv4 and IPv6 configuration details.

**Examples** The example below shows you how to disable the VRRP session for VRRP VR ID 5 on vlan2:

```
awplus# configure terminal
awplus(config)# router vrrp 5 vlan2
awplus(config-router)# disable
```

The example below shows you how to disable the VRRPv3 session for VRRPv3 VR ID 3 on vlan1:

```
awplus# configure terminal
awplus(config)# router ipv6 vrrp 3 vlan1
awplus(config-router)# disable
```

**Related Commands**

- [enable \(VRRP\)](#)
- [router vrrp \(interface\)](#)
- [router ipv6 vrrp \(interface\)](#)
- [show vrrp](#)

# enable (VRRP)

**Overview** Use this command to enable the VRRP session on the router to make it participate in virtual routing. To make changes to the VRRP configuration, first disable the router from participating in virtual routing using the [disable \(VRRP\)](#) command.

**Syntax** enable

**Mode** Router Configuration

**Usage** You must configure the virtual IP address and define the interface for the VRRP session (using the [virtual-ip](#) or [virtual-ipv6](#) and the [router vrrp \(interface\)](#) or [router ipv6 vrrp \(interface\)](#) commands) before using this command.

See the [VRRP Feature Overview and Configuration Guide](#) for more information about VRRPv3 IPv4 and IPv6 configuration details.

**Examples** To enable the VRRP session for VRRP VR ID 5 on vlan2, use the commands:

```
awplus# configure terminal
awplus(config)# router vrrp 5 vlan2
awplus(config-router)# enable
```

To enable the VRRPv3 session for VRRPv3 VR ID 3 on vlan1, use the commands:

```
awplus# configure terminal
awplus(config)# router ipv6 vrrp 3 vlan1
awplus(config-router)# enable
```

**Related Commands**

- [disable \(VRRP\)](#)
- [router vrrp \(interface\)](#)
- [router ipv6 vrrp \(interface\)](#)
- [show vrrp](#)
- [virtual-ip](#)
- [virtual-ipv6](#)

# preempt-mode

**Overview** Use this command to configure preempt mode. If preempt-mode is set to **true**, then the highest priority backup will always be the master when the default master is unavailable.

If preempt-mode is set to **false**, then a higher priority backup will not preempt a lower priority backup who is acting as master.

**Syntax** `preempt-mode {true|false}`

| Parameter          | Description             |
|--------------------|-------------------------|
| <code>true</code>  | Preemption is enabled.  |
| <code>false</code> | Preemption is disabled. |

**Default** The default is **true**.

**Mode** Router Configuration

**Usage** When the master router fails, the backup routers come online in priority order—highest to lowest. Preempt mode means that a higher priority back up router will take over the master role from a lower priority back up. Preempt mode on **true** allows a higher priority backup router to relieve a lower priority backup router.

By default, a preemptive scheme is enabled whereby a higher priority backup virtual router that becomes available take over for the backup virtual router that was elected to become the master virtual router.

This preemptive scheme can be disabled using the **preempt-mode false** command. If preemption is disabled, the backup virtual router that is currently elected as the master virtual router does not transition to backup virtual router again whenever the alternate backup router with a higher priority becomes available.

See the [VRRP Feature Overview and Configuration Guide](#) for more information about:

- VRRPv3 IPv4 configuration details
- VRRPv3 IPv6 configuration details
- preempt mode

**Examples** The example below shows you how to configure preempt-mode as true for VRRP VR ID 5 on vlan2:

```
awplus# configure terminal
awplus(config)# router vrrp 5 vlan2
awplus(config-router)# preempt-mode true
```

The example below shows you how to configure preempt-mode as false for VRRP VR ID 5 on vlan2:

```
awplus# configure terminal
awplus(config)# router vrrp 5 vlan2
awplus(config-router)# preempt-mode false
```

The example below shows you how to configure preempt-mode as true for VRRPv3 VR ID 3 on vlan1:

```
awplus# configure terminal
awplus(config)# router ipv6 vrrp 3 vlan1
awplus(config-router)# preempt-mode true
```

The example below shows you how to configure preempt-mode as false for VRRPv3 VR ID 3 on vlan1:

```
awplus# configure terminal
awplus(config)# router ipv6 vrrp 3 vlan1
awplus(config-router)# preempt-mode false
```

**Related  
Commands**

[circuit-failover](#)

[priority](#)

[router vrrp \(interface\)](#)

[router ipv6 vrrp \(interface\)](#)



# priority

**Overview** Use this command to configure the VRRP router priority within the virtual router. The highest priority router is Master (unless [preempt-mode](#) is false).

Use the **no** variant of this command to remove the VRRP router priority within the virtual router, which has been set using the **priority** command.

**Syntax** `priority <1-255>`  
`no priority`

| Parameter | Description                                                                                                       |
|-----------|-------------------------------------------------------------------------------------------------------------------|
| <1-255>   | The priority. For the master router, use 255 for this parameter; otherwise use any number from the range <1-254>. |

**Default** Defaults for priority are: **master router**= 255; **backup**= 100.

**Mode** Router Configuration

**Usage** Priority determines the role that each VRRP router plays and what happens if the master virtual router fails. If a VRRP router owns the IP address of the virtual router and the IP address of the interface, then this VRRP router functions as the master virtual router.

Priority also determines whether a VRRP router functions as a backup virtual router and the order of ascendancy to becoming a master virtual router if the master virtual router fails. Configure the priority of each backup virtual router with a value of 1 through 254.

See the [VRRP Feature Overview and Configuration Guide](#) for more information about VRRPv3 IPv4 and IPv6 configuration details.

**Examples** The example below shows you how to configure 101 as the priority for VRRP VR ID 5 on vlan2:

```
awplus# configure terminal
awplus(config)# router vrrp 5 vlan2
awplus(config-router)# priority 101
```

The example below shows you how to remove the priority configured for VRRP VR ID 5 on vlan2:

```
awplus# configure terminal
awplus(config)# router vrrp 5 vlan2
awplus(config-router)# no priority
```

The example below shows you how to configure 101 as the priority for VRRPv3 VR ID 3 on vlan1:

```
awplus# configure terminal
awplus(config)# router ipv6 vrrp 3 vlan1
awplus(config-router)# priority 101
```

The example below shows you how to remove the configured priority for VRRPv3 VR ID 3 on vlan1:

```
awplus# configure terminal
awplus(config)# router ipv6 vrrp 3 vlan1
awplus(config-router)# no priority
```

**Related  
Commands** [circuit-failover](#)  
[preempt-mode](#)

# router ipv6 vrrp (interface)

**Overview** Use this command to configure VRRPv3 for IPv6 and define the interface that will participate in virtual routing to send and receive advertisement messages. This command allows you to enter the Router Configuration mode.

Use the **no** variant of this command to remove the VRRPv3 for IPv6 configuration. Disable the VRRP session before using the **no** variant of this command.

**Syntax** `router ipv6 vrrp <vrid> <interface>`  
`no router ipv6 vrrp <vrid> <interface>`

| Parameter   | Description                                                                                                                                                                                            |
|-------------|--------------------------------------------------------------------------------------------------------------------------------------------------------------------------------------------------------|
| <vrid>      | <1-255> The ID of the virtual router VRRPv3 IPv6 session to create.                                                                                                                                    |
| <interface> | Specify the name of the interface that will participate in the virtual routing. The interface must exist on the router. The interface specified sends and receives VRRPv3 IPv6 advertisement messages. |

**Mode** Global Configuration

**Usage** Use the required <interface> placeholder to define the interface that will participate in virtual routing. This interface is used for two purposes - to send/receive advertisement messages and to forward on behalf of the virtual router when in master state.

**NOTE:** *Tunnels and PPP interfaces are not supported.*

**NOTE:** *Configuring a high number of instances may adversely affect the device's performance, depending on the device CPU, the other protocols it is running, and whether you set the advertisement interval to less than 1 second.*

See the [VRRP Feature Overview and Configuration Guide](#) for more information about VRRPv3 IPv6 configuration details.

**Examples** The example below shows you how to enable a VRRPv3 session with VR ID 3 on vlan2:

```
awplus# configure terminal
awplus(config)# router ipv6 vrrp 3 vlan2
awplus(config-router)# enable
awplus(config-router)#
```

The example below shows you how to disable a VRRPv3 session with VR ID 3 on vlan2:

```
awplus(config-router)# disable
awplus(config-router)# exit
awplus(config)# no router ipv6 vrrp 3 vlan2
awplus(config)#
```

**Related  
Commands** advertisement-interval  
circuit-failover

# router vrrp (interface)

**Overview** Use this command to configure VRRP IPv4 and define the interface that will participate in virtual routing to send and receive advertisement messages. This command allows you to enter the Router Configuration mode.

Use the **no** variant of this command to remove the VRRP IPv4 configuration. Disable the VRRP session before using the **no** variant of this command.

**Syntax** `router vrrp <vrid> <interface>`  
`no router vrrp <vrid> <interface>`

| Parameter                      | Description                                                                                                                                                                                          |
|--------------------------------|------------------------------------------------------------------------------------------------------------------------------------------------------------------------------------------------------|
| <code>&lt;vrid&gt;</code>      | <code>&lt;1-255&gt;</code> The ID of the virtual router VRRP IPv4 session to create.                                                                                                                 |
| <code>&lt;interface&gt;</code> | Specify the name of the interface that will participate in the virtual routing. The interface must exist on the router. The interface specified sends and receives VRRP IPv4 advertisement messages. |

**Mode** Global Configuration

**Usage** Use the required `<interface>` placeholder to define the interface that will participate in virtual routing. This interface is used for two purposes - to send/receive advertisement messages and to forward on behalf of the virtual router when in master state.

**NOTE:** *Tunnels and PPP interfaces are not supported.*

**NOTE:** *Configuring a high number of instances may adversely affect the device's performance, depending on the device CPU, the other protocols it is running, and whether you set the advertisement interval to less than 1 second.*

See the [VRRP Feature Overview and Configuration Guide](#) for more information about VRRPv3 IPv4 configuration details.

**Examples** To enable a VRRP session with VR ID 5 on vlan1, use the commands:

```
awplus# configure terminal
awplus(config)# router vrrp 5 vlan1
awplus(config-router)# enable
```

To disable a VRRP session with VR ID 5 on vlan1, use the commands:

```
awplus(config-router)# disable
awplus(config-router)# exit
awplus(config)# no router vrrp 5 vlan1
```

**Related  
Commands**

- advertisement-interval
- circuit-failover
- disable (VRRP)
- enable (VRRP)

# show debugging vrrp

**Overview** Use this command to display the set VRRP debugging option. Use the terminal monitor command to display output on the console otherwise debug output is in the log file.

For information on filtering and saving command output, see the [“Getting Started with AlliedWare Plus” Feature Overview and Configuration Guide](#).

See the [VRRP Feature Overview and Configuration Guide](#) for more information about VRRPv3 debugging details.

**Syntax** `show debugging vrrp`

**Mode** User Exec and Privileged Exec

**Example** The example below shows you how to display VRRP debugging:

```
awplus# show debugging vrrp
```

**Related Commands**

- [debug vrrp](#)
- [debug vrrp events](#)
- [debug vrrp packet](#)

# show running-config router ipv6 vrrp

**Overview** Use this command to show the running configuration for VRRPv3 IPv6.

For information on filtering and saving command output, see the [“Getting Started with AlliedWare Plus” Feature Overview and Configuration Guide](#).

See the [VRRP Feature Overview and Configuration Guide](#) for more information about VRRPv3 IPv6 configuration details.

**Syntax** `show running-config router vrrp`

**Mode** Privileged Exec, Global Configuration, Line Configuration, and Interface Configuration.

**Example** The example below shows you how to display the running configuration for VRRPv3 IPv6:

```
awplus# show running-config router ipv6 vrrp
```

**Output** Figure 49-1: Example output from the **show running-config router ipv6 vrrp** command

```
!
router ipv6 vrrp 3 vlan3
 virtual-ip fe80::202:b3ff:fed5:983e master
 circuit-failover vlan3 3
 advertisement-interval 6
 preempt-mode false
!
```



# show running-config router vrrp

**Overview** Use this command to show the running configuration for VRRP IPv4.

For information on filtering and saving command output, see the [“Getting Started with AlliedWare Plus” Feature Overview and Configuration Guide](#).

See the [VRRP Feature Overview and Configuration Guide](#) for more information about VRRPv3 IPv4 configuration details.

**Syntax** `show running-config router vrrp`

**Mode** Privileged Exec, Global Configuration, Line Configuration, and Interface Configuration.

**Example** The example below shows you how to display the running configuration for VRRP IPv4:

```
awplus# show running-config router vrrp
```

**Output** Figure 49-2: Example output from the **show running-config router vrrp** command

```
!
router vrrp 2 vlan2
 circuit-failover vlan2 2
 advertisement-interval 4
 preempt-mode true
!
```

# show vrrp

**Overview** Use this command to display information about all VRRP IPv4 sessions. This command shows a summary when the optional **brief** parameter is used.

For information on filtering and saving command output, see the [“Getting Started with AlliedWare Plus” Feature Overview and Configuration Guide](#).

See the [VRRP Feature Overview and Configuration Guide](#) for more information about VRRPv3 IPv4 configuration details.

**Syntax** show vrrp [brief]

| Parameter | Description                     |
|-----------|---------------------------------|
| brief     | Brief summary of VRRP sessions. |

**Mode** User Exec and Privileged Exec

**Example** To display information about all VRRP IPv4 sessions, enter the command:

```
awplus# show vrrp
```

To display brief summary output about VRRP IPv4 sessions, enter the command:

```
awplus# show vrrp brief
```

**Output** Figure 49-3: Example output from the **show vrrp** command

```
awplus#show vrrp
VMAC enabled
Address family IPv4
VRRP Id: 1 on interface: vlan2
State: AdminUp - Master
Virtual IP address: 192.168.1.2 (Not-owner)
Priority is 100
Advertisement interval: 100 centiseconds
Preempt mode: TRUE
Multicast membership on IPv4 interface vlan2: JOINED
Transition mode: FALSE
Accept mode: FALSE
Master address: 192.168.1.3
High Availability: enabled
wan-bypass 1 (eth1) is on
```

Figure 49-4: Example output from the **show vrrp brief** command

```
awplus#show vrrp brief
Interface Grp Prio Own Pre State Master addr Group addr
vlan10 1 200 N P Master 192.168.10.4 192.168.10.253
vlan10 2 150 N P Backup 192.168.10.4 192.168.10.254
vlan11 3 200 N P Master 192.168.11.4 192.168.11.253
vlan11 4 150 N P Backup 192.168.11.4 192.168.11.254
```

**Related  
Commands**    enable (VRRP)  
                  disable (VRRP)

# show vrrp counters

**Overview** This command displays VRRP SNMP counters on the console, as described in the VRRP MIB and RFC2787, for debugging use while you configure VRRP with commands in this chapter.

For information on filtering and saving command output, see the [“Getting Started with AlliedWare Plus” Feature Overview and Configuration Guide](#).

**Syntax** show vrrp counters

**Mode** User Exec and Privileged Exec

**Usage** The output has a section for global counters and a section of counters for each VRRP instance configured. See the descriptions of the counters below the sample output as per RFC2787.

**NOTE:** Note that the counters displayed with this commands are the same counters as described in RFC 2787 (Copyright (C) The Internet Society (2000). All Rights Reserved) except for the “Monitored Circuit Up” and “Monitored Circuit Down” counters, which are additions beyond the MIB.

**Example** To display information about VRRP SNMP counters on the console, enter the command:

```
awplus# show vrrp counters
```

Figure 49-5: Example output from the **show vrrp counters** command

```
awplus#show vrrp counters
VRRP Global Counters:
 Checksum Errors 230
 Version Errors 0
 VRID Errors 230

VRRP IPv4 counters for VR 10/vlan10:
 Master Transitions 0
 Received Advertisements ... 0
 Internal Errors 0
 TTL Errors 0
 Received Priority 0 Pkt ... 0
 Sent Priority 0 Pkt 0
 Received Invalid Type 0
 Address List Errors 0
 Packet Length Errors 0
 Monitored Circuit Up 0
 Monitored Circuit Down..... 0
```

```
VRRP IPv4 counters for VR 100/vlan100:
Master Transitions 1
Received Advertisements ... 1614
Internal Errors 0
TTL Errors 0
Received Priority 0 Pkt ... 0
Sent Priority 0 Pkt 0
Received Invalid Type 0
Address List Errors 0
Packet Length Errors 0
Monitored Circuit Up 0
Monitored Circuit Down.... 2
```

**Table 1:** Global counters with descriptions for the **show vrrp counters** command:

| Counter         | Description                                                                              |
|-----------------|------------------------------------------------------------------------------------------|
| Checksum Errors | The total number of VRRP packets received with an invalid VRRP checksum value.           |
| Version Errors  | The total number of VRRP packets received with an unknown or unsupported version number. |
| VRID Errors     | The total number of VRRP packets received with an invalid VRID for this virtual router.  |

**Table 2:** Per VR counters with descriptions for the **show vrrp counters** command:

| Counter                 | Description                                                                                                                                                     |
|-------------------------|-----------------------------------------------------------------------------------------------------------------------------------------------------------------|
| Master Transitions      | The total number of times that this virtual router's state has transitioned to MASTER.                                                                          |
| Received Advertisements | The total number of VRRP advertisements received by this virtual router.                                                                                        |
| Internal Errors         | The total number of VRRP advertisement packets received for which the advertisement interval is different than the one configured for the local virtual router. |
| TTL Errors              | The total number of VRRP packets received by the virtual router with IP TTL (Time-To-Live) not equal to 255.                                                    |
| Received Priority 0 Pkt | The total number of VRRP packets received by the virtual router with a priority of '0'.                                                                         |
| Sent Priority 0 Pkt     | The total number of VRRP packets sent by the virtual router with a priority of '0'.                                                                             |
| Received Invalid Type   | The number of VRRP packets received by the virtual router with an invalid value in the 'type' field.                                                            |
| Address List Errors     | The total number of packets received for which the address list does not match the locally configured list for the virtual router.                              |

**Table 2:** Per VR counters with descriptions for the **show vrrp counters** command: (cont.)

| Counter                | Description                                                                                        |
|------------------------|----------------------------------------------------------------------------------------------------|
| Packet Length Errors   | The total number of packets received with a packet length less than the length of the VRRP header. |
| Monitored Circuit Up   | The total number of times the monitored circuit has generated the UP event.                        |
| Monitored Circuit Down | The total number of times the monitored circuit has generated the down event.                      |

# show vrrp ipv6

**Overview** Use this command to display information about all configured VRRPv3 IPv6 sessions for all interfaces, or all VRRPv3 IPv6 sessions for a given interface with the optional parameter.

For information on filtering and saving command output, see the [“Getting Started with AlliedWare Plus” Feature Overview and Configuration Guide](#).

See the [VRRP Feature Overview and Configuration Guide](#) for more information about VRRPv3 IPv6 configuration details.

**Syntax** `show vrrp ipv6 [<interface>]`

| Parameter   | Description                                                                                                                                                                                            |
|-------------|--------------------------------------------------------------------------------------------------------------------------------------------------------------------------------------------------------|
| <interface> | Specify the name of the interface that will participate in the virtual routing. The interface must exist on the router. The interface specified sends and receives VRRPv3 IPv6 advertisement messages. |

**Mode** User Exec and Privileged Exec

**Example** To display information about all VRRPv3 IPv6 sessions, enter the command:

```
awplus# show vrrp ipv6
```

**Output** Figure 49-6: Example output from the **show vrrp ipv6 vlan2** command

```
awplus#show vrrp ipv6 vlan2
VrId <1>
 State is Master
 Virtual IP is fe80::202:b3ff:fed5:983e (Owner)
 Interface is vlan2
 Priority is 255
 Advertisement interval is 4 sec
 Preempt mode is FALSE
```

**Related Commands** [enable \(VRRP\)](#)  
[disable \(VRRP\)](#)

# show vrrp (session)

**Overview** Use this command to display information for a particular VRRP session.

For information on filtering and saving command output, see the [“Getting Started with AlliedWare Plus” Feature Overview and Configuration Guide](#).

See the [VRRP Feature Overview and Configuration Guide](#) for more information about VRRPv3 IPv4 configuration details.

**Syntax** `show vrrp <vrid> <interface>`

| Parameter                      | Description                                                                                                    |
|--------------------------------|----------------------------------------------------------------------------------------------------------------|
| <code>&lt;vrid&gt;</code>      | <code>&lt;1-255&gt;</code> The virtual router ID for which to display information. Session must already exist. |
| <code>&lt;interface&gt;</code> | The interface to display information about, for instance, <code>vlan2</code> .                                 |

**Mode** User Exec and Privileged Exec

**Usage** See the below sample output from the **show vrrp** command displaying information about VRRP session 1 configured on **vlan2**. Output shows that a Virtual IP address has been set.

```
awplus# show vrrp 1 vlan2
```

```
awplus#show vrrp 1 vlan2
Address family IPv4
VrId <1>
 Interface is vlan2
 State is Initialize
 Virtual IP address is 10.10.11.250 (Not IP owner)
 Priority is 100
 Advertisement interval is 1 sec
 Preempt mode is TRUE
 Multicast membership on IPv4 interface vlan1: JOINED
 Transition mode: FALSE
 Accept mode: TRUE
 Master address: 192.168.24.5
 High Availability:
 enabled
 wan-bypass 1 (eth1) is on
```

See the below sample output from the **show vrrp** command displaying information about VRRP session 1 configured on **vlan3**. Output shows a Virtual IP address has not been set.

```
awplus# show vrrp 1 vlan3
```



```
awplus#show vrrp 1 vlan3
Address family IPv4
VrId <1>
 Interface is vlan3
 State is Initialize
 Virtual IP address is unset
 Priority is 100
 Advertisement interval is 1 sec
 Preempt mode is TRUE
Preempt mode is TRUE
Multicast membership on IPv4 interface vlan3: JOINED
Transition mode: FALSE
Accept mode: TRUE
Master address: 192.168.24.5
High Availability:
enabled
 wan-bypass 1 (eth1) is on
```

**Example** The following command shows information about VRRP session 5 for interface **vlan2**.

```
awplus# show vrrp 5 vlan2
```

# transition-mode

**Overview** Use this command to configure the IPv4 transition mode. Transition mode allows you to upgrade from VRRPv2 to VRRPv3 and gives interoperability between VRRPv2 and VRRPv3.

If transition-mode is set to **true**, then the IPv4 transition mode is enabled and VRRPv2 and VRRPv3 advertisements are sent allowing VRRPv2 and VRRPv3 interoperability. Received VRRPv2 advertisement packets are accepted and processed when transition-mode is true.

If transition-mode is set to **false**, then the IPv4 transition mode is disabled and only VRRPv3 advertisements are sent. Received VRRPv2 advertisement packets are dropped.

Note the [advertisement-interval](#) should not be configured to less than 1 second when using transition-mode. VRRPv2 can only use advertisements in whole second intervals.

**Syntax** `transition-mode {true|false}`

| Parameter | Description                                                                                                                                                                                           |
|-----------|-------------------------------------------------------------------------------------------------------------------------------------------------------------------------------------------------------|
| true      | Transition mode is enabled. This results in VRRPv2 and VRRPv3 IPv4 advertisements being sent. Transition mode is only available on VRRPv3 for interoperability with VRRPv2 while upgrading to VRRPv3. |
| false     | Transition mode is disabled. This stops VRRPv2 IPv4 advertisements being sent. Only VRRPv3 advertisements are sent when disabled. Disable transition-mode after upgrading from VRRPv2 to VRRPv3.      |

**Default** The default is **false**.

**Mode** Router Configuration

**Usage** See the [VRRP Feature Overview and Configuration Guide](#) for more information:

- VRRPv3 IPv4 configuration details
- VRRPv3 IPv6 configuration details
- further information about configuring transition mode to upgrade from VRRPv2 to VRRPv3

**Examples** The example below shows you how to configure IPv4 transition-mode as true for VRRP VR ID 5 on vlan2:

```
awplus# configure terminal
awplus(config)# router vrrp 5 vlan2
awplus(config-router)# transition-mode true
```

The example below shows you how to configure IPv4 transition-mode as false for VRRP VR ID 5 on vlan2:

```
awplus# configure terminal
awplus(config)# router vrrp 5 vlan2
awplus(config-router)# transition-mode false
```

**Related  
Commands** [router vrrp \(interface\)](#)

# undebug vrrp

**Overview** Use this command to disable all VRRP debugging.

**Syntax** undebug vrrp all

**Mode** Privileged Exec

**Example** The example below shows you how to disable all VRRP debugging:

```
awplus# undebug vrrp all
```

**Related  
Commands** [debug vrrp](#)

# undebg vrrp events

**Overview** Use this command to disable debugging options for VRRP event troubleshooting.

**Syntax** undebg vrrp events

**Mode** Privileged Exec

**Example** The example below shows you how to disable VRRP event debugging:

```
awplus# undebg vrrp events
```

**Related  
Commands** [debug vrrp events](#)

# undebbug vrrp packet

**Overview** Use this command to disable debugging options for VRRP packets.

**Syntax** `undebbug vrrp packet [send|recv]`

| Parameter | Description                                        |
|-----------|----------------------------------------------------|
| send      | Disable the debug option set for sent packets.     |
| recv      | Disable the debug option set for received packets. |

**Mode** Privileged Exec

**Examples** The example below shows you how to disable VRRP sent packet debugging:

```
awplus# undebbug vrrp packet send
```

The example below shows you how to disable VRRP received packet debugging:

```
awplus# undebbug vrrp packet recv
```

The example below shows you how to disable all VRRP packet debugging:

```
awplus# undebbug vrrp packet
```

**Related  
Commands** [debug vrrp packet](#)

# virtual-ip

**Overview** Use this command to set the virtual IP address for the VRRP session. This is the IP address of the virtual router that end hosts set as their default gateway.

Use the **no** variant of this command to disable this feature.

**Syntax** `virtual-ip <ip-address> [master|backup|owner]`  
`no virtual-ip`

| Parameter                       | Description                                                                                                                                                                                                       |
|---------------------------------|-------------------------------------------------------------------------------------------------------------------------------------------------------------------------------------------------------------------|
| <code>&lt;ip-address&gt;</code> | The virtual IPv4 address of the virtual router, entered in dotted decimal format A.B.C.D.                                                                                                                         |
| <code>master</code>             | Sets the default state of the VRRP router within the Virtual Router as <b>master</b> . For master, the router must own the Virtual IP address. Specify the <b>owner</b> option before using <b>master</b> option. |
| <code>backup</code>             | Sets the default state of the VRRP router within the Virtual Router as <b>backup</b> .                                                                                                                            |
| <code>owner</code>              | Sets the IPv6 address of the VRRP router within the Virtual Router as the <b>owner</b> . Specify this before using the <b>master</b> option.                                                                      |

**Mode** Router Configuration

**Usage** The VRRP master and owner of the virtual IPv4 address for the VRRP session only responds to the packets destined to the virtual IPv4 address. The VRRP master that is not an owner of the virtual IPv4 address for the VRRP session does not respond to the packets destined to the virtual IPv4 address, but forwards packets with a VMAC as the destination address. See the [vrrp vmac](#) command to enable and disable this feature.

See the [VRRP Feature Overview and Configuration Guide](#) for more information about VRRPv3 IPv4 configuration details.

**Examples** The example below shows you how to set the virtual IP address for VRRP VR ID 5 and the router as the VRRP master:

```
awplus# configure terminal
awplus(config)# router vrrp 5 vlan2
awplus(config-router)# virtual-ip 192.0.2.30 master
```

The example below shows you how to set the virtual IPv4 address for VRRP VR ID 5 and the router as the VRRP backup:

```
awplus# configure terminal
awplus(config)# router vrrp 5 vlan2
awplus(config-router)# virtual-ip 192.0.2.30 backup
```

The example below shows you how to set the virtual IPv4 address for VRRP VR ID 5 and the router as owner of the virtual IPv4 address:

```
awplus# configure terminal
awplus(config)# router vrrp 5 vlan2
awplus(config-router)# virtual-ip 192.0.2.30 owner
```

The example below shows you how to disable the virtual IPv4 address for VRRP VR ID 5

```
awplus# configure terminal
awplus(config)# router vrrp 5 vlan2
awplus(config-router)# no virtual-ip
```

**Related  
Commands**

- [router vrrp \(interface\)](#)
- [enable \(VRRP\)](#)
- [vrrp vmac](#)



# virtual-ipv6

**Overview** Use this command to set the virtual IPv6 address for the VRRPv3 session. This is the IPv6 address of the virtual router that end hosts set as their default gateway.

Note that the primary IPv6 address specified is an IPv6 link-local address. See the Usage note below for further information.

Use the **no** variant of this command to disable this feature.

**Syntax** `virtual-ipv6 <ipv6-address> [master|backup]  
[primary|secondary]`  
`no virtual-ipv6`

| Parameter                         | Description                                                                                                                                                                                                                                          |
|-----------------------------------|------------------------------------------------------------------------------------------------------------------------------------------------------------------------------------------------------------------------------------------------------|
| <code>&lt;ipv6-address&gt;</code> | The IPv6 address of the virtual router, entered in hexadecimal, in the format X:X::X.X.                                                                                                                                                              |
| <code>master</code>               | Sets <b>master</b> to be the default state of the VRRPv3 router within the Virtual Router. For <b>master</b> , we recommend using a Virtual IP address that is not owned by any of the VRRP routers in the same grouping (that share the same VRID). |
| <code>backup</code>               | Sets <b>backup</b> to be the default state of the VRRPv3 router within the Virtual Router.                                                                                                                                                           |
| <code>primary</code>              | Sets the specified address as the primary IPv6 address. The primary address must be a link-local IPv6 address.                                                                                                                                       |
| <code>secondary</code>            | Sets the specified address as the secondary IPv6 address. Normally this would be a globally-routable IPv6 address. This enables you to specify a globally-routable address as the default gateway address for all the hosts on a VLAN.               |

**Mode** Router Configuration

**Usage** The virtual router will reply to ping, telnet, and SSH requests to the virtual IP address. The virtual router will reply even if it does not own the virtual IP address.

The AlliedWare Plus VRRPv3 implementation supports one IPv6 virtual link local address per virtual router ID. Note that in the command examples fe80::1 is an IPv6 link-local address. An IPv6 link-local address is used because IPv6 link-local addresses are used by IPv6 ND (Neighbor Discovery). A host's default route to a router points to the IPv6 link-local address, not a specific global IPv6 address for the router. For the host's traffic to switch over to a backup router, the IPv6 link-local address of the router is used by VRRPv3.

See the [VRRP Feature Overview and Configuration Guide](#) for more information about VRRPv3 IPv6 configuration details.

**Examples** The example below shows you how to set the virtual IPv6 address for VRRPv3 VR ID 3 and the router as the VRRPv3 master:

```
awplus# configure terminal
awplus(config)# router ipv6 vrrp 3 vlan1
awplus(config-router)# virtual-ipv6 fe80::1 master
```

The example below shows you how to set the virtual IPv6 address for VRRPv3 VR ID 3 and the router as the VRRPv3 backup:

```
awplus# configure terminal
awplus(config)# router ipv6 vrrp 3 vlan1
awplus(config-router)# virtual-ipv6 fe80::1 backup
```

The example below shows you disable the virtual IPv6 address for VRRPv3 VR ID 3:

```
awplus# configure terminal
awplus(config)# router ipv6 vrrp 3 vlan1
awplus(config-router)# no virtual-ipv6
```

**Related  
Commands** [router ipv6 vrrp \(interface\)](#)  
[enable \(VRRP\)](#)  
[vrrp vmac](#)

## vrrp vmac

**Overview** Use this command to enable or disable the VRRP Virtual MAC feature. This feature is used by VRRP to make the hosts use the virtual MAC address as the physical hardware address of their gateway.

A VRRP router master will use the virtual MAC address for any ARP responses associated with the virtual IP address, or any gratuitous ARPs sent on behalf of the virtual IP address.

All VRRP advertisements are sent using this virtual MAC address as the source MAC address.

The virtual MAC address has the form 00:00:5e:00:01:<VRID>, where VRID is the ID of the Virtual Router.

**Syntax** `vrrp vmac {enable|disable}`

**Mode** Global Configuration

**Examples** To enable Virtual MAC enter:

```
awplus# configure terminal
awplus(config)# vrrp vmac enable
```

To disable Virtual MAC enter:

```
awplus# configure terminal
awplus(config)# vrrp vmac disable
```

**Related  
Commands** [virtual-ip](#)  
[virtual-ipv6](#)

# Part 7: Network Management

# 50

# Allied Telesis Management Framework™ (AMF) Commands

## Introduction

**Overview** This chapter provides an alphabetical reference for Allied Telesis Management Framework™ (AMF) commands.

**AMF master nodes** Every AMF network must have at least one master node, which acts as the core of the AMF network. Not all AlliedWare Plus devices are capable of acting as an AMF master. See the [AMF Feature Overview and Configuration Guide](#) for information about AMF master support.

**AMF edge** CentreCOM® FS980M, GS900MX, GS970M, and XS900MX Series switches can only be used as edge switches in an AMF network. The full management power and convenience of AMF is available on these switches, but they can only link to one other AMF node. They cannot form cross-links or virtual links.

**AMF naming convention** When AMF is enabled on a device, it will automatically be assigned a host name. If a host name has already been assigned, by using the command [hostname](#) on page 238, this will remain. If however, no host name has been assigned, then the name applied will be the prefix, **host\_** followed (without a space) by the MAC address of the device. For example, a device whose MAC address is **0016.76b1.7a5e** will have the name **host\_0016\_76b1\_7a5e** assigned to it.

To efficiently manage your network using AMF, we strongly advise that you devise a naming convention for your network devices, and accordingly apply an appropriate hostname to each device in your AMF network.

**AMF and STP** On AR-Series firewalls, you cannot use STP at the same time as AMF.

- Command List**
- [“area-link”](#) on page 2122
  - [“atmf area”](#) on page 2124
  - [“atmf area password”](#) on page 2126
  - [“atmf authorize”](#) on page 2128
  - [“atmf authorize provision”](#) on page 2130

- [“atmf backup”](#) on page 2132
- [“atmf backup area-masters delete”](#) on page 2133
- [“atmf backup area-masters enable”](#) on page 2134
- [“atmf backup area-masters now”](#) on page 2135
- [“atmf backup area-masters synchronize”](#) on page 2136
- [“atmf backup bandwidth”](#) on page 2137
- [“atmf backup delete”](#) on page 2138
- [“atmf backup enable”](#) on page 2139
- [“atmf backup guests delete”](#) on page 2140
- [“atmf backup guests enable”](#) on page 2141
- [“atmf backup guests now”](#) on page 2142
- [“atmf backup guests synchronize”](#) on page 2143
- [“atmf backup now”](#) on page 2144
- [“atmf backup redundancy enable”](#) on page 2146
- [“atmf backup server”](#) on page 2147
- [“atmf backup stop”](#) on page 2149
- [“atmf backup synchronize”](#) on page 2150
- [“atmf cleanup”](#) on page 2151
- [“atmf container”](#) on page 2152
- [“atmf container login”](#) on page 2153
- [“atmf controller”](#) on page 2154
- [“atmf distribute firmware”](#) on page 2155
- [“atmf domain vlan”](#) on page 2157
- [“atmf enable”](#) on page 2160
- [“atmf group \(membership\)”](#) on page 2161
- [“atmf guest-class”](#) on page 2163
- [“atmf log-verbose”](#) on page 2165
- [“atmf management subnet”](#) on page 2166
- [“atmf management vlan”](#) on page 2169
- [“atmf master”](#) on page 2171
- [“atmf mtu”](#) on page 2172
- [“atmf network-name”](#) on page 2173
- [“atmf provision”](#) on page 2174
- [“atmf provision node clone”](#) on page 2175
- [“atmf provision node configure boot config”](#) on page 2177

- [“atmf provision node configure boot system”](#) on page 2178
- [“atmf provision node create”](#) on page 2179
- [“atmf provision node delete”](#) on page 2181
- [“atmf provision node license-cert”](#) on page 2183
- [“atmf provision node locate”](#) on page 2185
- [“atmf reboot-rolling”](#) on page 2186
- [“atmf recover”](#) on page 2190
- [“atmf recover guest”](#) on page 2192
- [“atmf recover led-off”](#) on page 2193
- [“atmf remote-login”](#) on page 2194
- [“atmf restricted-login”](#) on page 2196
- [“atmf secure-mode”](#) on page 2198
- [“atmf secure-mode certificate expire”](#) on page 2200
- [“atmf secure-mode certificate expiry”](#) on page 2201
- [“atmf secure-mode certificate renew”](#) on page 2202
- [“atmf secure-mode enable-all”](#) on page 2203
- [“atmf select-area”](#) on page 2205
- [“atmf topology-gui enable”](#) on page 2206
- [“atmf virtual-crosslink”](#) on page 2207
- [“atmf virtual-link”](#) on page 2209
- [“atmf working-set”](#) on page 2211
- [“bridge-group”](#) on page 2213
- [“clear atmf links statistics”](#) on page 2214
- [“clear atmf secure-mode certificates”](#) on page 2215
- [“clear atmf secure-mode statistics”](#) on page 2216
- [“debug atmf”](#) on page 2217
- [“debug atmf packet”](#) on page 2219
- [“discovery”](#) on page 2222
- [“description \(amf container\)”](#) on page 2224
- [“erase factory-default”](#) on page 2225
- [“http-enable”](#) on page 2226
- [“log event-host”](#) on page 2228
- [“modeltype”](#) on page 2229
- [“show atmf”](#) on page 2230
- [“show atmf area”](#) on page 2234

- “show atmf area guests” on page 2237
- “show atmf area guests-detail” on page 2239
- “show atmf area nodes” on page 2241
- “show atmf area nodes-detail” on page 2243
- “show atmf area summary” on page 2245
- “show atmf authorization” on page 2246
- “show atmf backup” on page 2249
- “show atmf backup area” on page 2253
- “show atmf backup guest” on page 2255
- “show atmf container” on page 2257
- “show atmf detail” on page 2260
- “show atmf group” on page 2262
- “show atmf group members” on page 2264
- “show atmf guests” on page 2266
- “show atmf guests detail” on page 2268
- “show atmf links” on page 2271
- “show atmf links detail” on page 2273
- “show atmf links guest” on page 2282
- “show atmf links guest detail” on page 2284
- “show atmf links statistics” on page 2288
- “show atmf nodes” on page 2291
- “show atmf provision nodes” on page 2293
- “show atmf secure-mode” on page 2294
- “show atmf secure-mode audit” on page 2296
- “show atmf secure-mode audit link” on page 2297
- “show atmf secure-mode certificates” on page 2298
- “show atmf secure-mode sa” on page 2301
- “show atmf secure-mode statistics” on page 2304
- “show atmf tech” on page 2306
- “show atmf virtual-links” on page 2309
- “show atmf working-set” on page 2311
- “show debugging atmf” on page 2312
- “show debugging atmf packet” on page 2313
- “show running-config atmf” on page 2314
- “state” on page 2315



- [“switchport atmf-agentlink”](#) on page 2317
- [“switchport atmf-arealink remote-area”](#) on page 2318
- [“switchport atmf-crosslink”](#) on page 2320
- [“switchport atmf-guestlink”](#) on page 2322
- [“switchport atmf-link”](#) on page 2324
- [“type atmf node”](#) on page 2325
- [“undebug atmf”](#) on page 2328
- [“username”](#) on page 2329

# area-link

**Overview** Use this command to create an area-link between a Virtual AMF Appliance (VAA) host controller and an AMF container.

An AMF container is an isolated instance of AlliedWare Plus with its own network interfaces, configuration, and file system. The features available inside an AMF container are a sub-set of the features available on the host VAA. These features enable the AMF container to function as a uniquely identifiable AMF master and allows for multiple tenants (up to 60) to run on a single VAA host. See the [AMF Feature Overview and Configuration Guide](#) for more information on running multiple tenants on a single VAA host.

Use the **no** variant of this command to remove an area-link from a container.

**Syntax** `area-link <area-name>`  
`no area-link`

| Parameter                      | Description                            |
|--------------------------------|----------------------------------------|
| <code>&lt;area-name&gt;</code> | AMF area name of the container's area. |

**Mode** AMF Container Configuration

**Usage** The AMF area-link connects the AMF controller on a VAA host to the AMF container. Once a container has been created with the [atmf container](#) command and an area-link configured with the **area-link** command, it can be enabled using the [state](#) command.

You can only configure a single area-link on a container. You will see the following message if you try and configure a second one:

```
% AreaLink already configured for this container
```

Each container has two virtual interfaces:

- Interface eth0, used to connect to the AMF controller on the VAA host via an AMF area-link, configured using this area-link command.
- Interface eth1, used to connect to the outside world using a bridged L2 network link, configured using the [bridge-group](#) command.

See the [AMF Feature Overview and Configuration\\_Guide](#) for more information on these virtual interfaces and links.

**Example** To create the area-link to "wlg" on container "vac-wlg-1", use the commands:

```
awplus# configure terminal
awplus(config)# atmf container vac-wlg-1
awplus(config-atmf-container)# area-link wlg
```

To remove an area-link from container “vac-wlg-1”, use the commands:

```
awplus# configure terminal
awplus(config)# atmf container vac-wlg-1
awplus(config-atmf-container)# no area-link
```

**Related  
Commands**

[atmf container](#)  
[show atmf container](#)

**Command  
changes**

Version 5.4.7-0.1: command added

# atmf area

**Overview** This command creates an AMF area and gives it a name and ID number. Use the **no** variant of this command to remove the AMF area. This command is only valid on AMF controllers, master nodes and gateway nodes.

**Syntax** `atmf area <area-name> id <1-126> [local]`  
`no atmf area <area-name>`

| Parameter   | Description                                                                                                               |
|-------------|---------------------------------------------------------------------------------------------------------------------------|
| <area-name> | The AMF area name. The area name can be up to 15 characters long. Valid characters are:<br>a..z<br>A..Z<br>0..9<br>-<br>_ |
| <1-126>     | An ID number that uniquely identifies this area.                                                                          |
| local       | Set the area to be the local area. The local area contains the device you are configuring.                                |

**Mode** Global Configuration

**Usage** This command enables you to divide your AMF network into areas. Each area is managed by at least one AMF master node. Each area can have up to 120 nodes, depending on the license installed on that area's master node.

The whole AMF network is managed by up to 8 AMF controllers. Each AMF controller can communicate with multiple areas. The number of areas supported on a controller depends on the license installed on that controller.

You must give each area in an AMF network a unique name and ID number.

Only one local area can be configured on a device. You must specify a local area on each controller, remote AMF master, and gateway node.

**Example** To create the AMF area named *New-Zealand*, with an ID of 1, and specify that it is the local area, use the command:

```
controller-1(config)# atmf area New-Zealand id 1 local
```

To configure a remote area named *Auckland*, with an ID of 100, use the command:

```
controller-1(config)# atmf area Auckland id 100
```

**Related  
Commands**

- atmf area password
- show atmf area
- show atmf area summary
- show atmf area nodes
- switchport atmf-arealink remote-area

# atmf area password

**Overview** This command sets a password on an AMF area.

Use the **no** variant of this command to remove the password.

This command is only valid on AMF controllers, master nodes and gateway nodes. The area name must have been configured first.

**Syntax** `atmf area <area-name> password [8] <password>`  
`no atmf area <area-name> password`

| Parameter   | Description                                                                                                                                                                           |
|-------------|---------------------------------------------------------------------------------------------------------------------------------------------------------------------------------------|
| <area-name> | The AMF area name.                                                                                                                                                                    |
| 8           | This parameter is displayed in <b>show running-config</b> output to indicate that it is displaying the password in encrypted form. You should not enter <b>8</b> on the CLI yourself. |
| <password>  | The password is between 8 and 32 characters long. It can include spaces.                                                                                                              |

**Mode** Global Configuration

**Usage** You must configure a password on each area that an AMF controller communicates with, except for the controller's local area. The areas must already have been created using the `atmf area` command.

Enter the password identically on both of:

- the area that locally contains the controller, and
- the remote AMF area masters

The command **show running-config atmf** will display the encrypted version of this password. The encryption keys will match between the controller and the remote AMF master.

If multiple controller and masters exist in an area, they must all have the same area configuration.

**Example** To give the AMF area named *Auckland* a password of "secure#1" use the following command on the controller:

```
controller-1(config)# atmf area Auckland password secure#1
```

and also use the following command on the master node for the Auckland area:

```
auck-master(config)# atmf area Auckland password secure#1
```

**Related  
Commands**

- atmf area
- show atmf area
- show atmf area summary
- show atmf area nodes
- switchport atmf-arealink remote-area

# atmf authorize

**Overview** On an AMF network, with secure mode enabled, use this command on an AMF master to authorize an AMF node to join the network. AMF nodes waiting to be authorized appear in the pending authorization queue, which can be examined using the [show atmf authorization](#) command with the **pending** parameter.

Use the **no** variant of this command to revoke authorization for an AMF node on an AMF master.

**Syntax** `atmf authorize {<node-name> [area <area-name>]|all-pending}`  
`no atmf authorize <node-name> [area <area-name>]`

| Parameter   | Description                                                              |
|-------------|--------------------------------------------------------------------------|
| <node-name> | The name of the node to be authorized or have its authorization revoked. |
| area        | Specify an AMF area.                                                     |
| <area-name> | This is the name of the area the node belongs to.                        |
| all-pending | Authorize all nodes in the pending queue.                                |

**Mode** Privileged Exec

**Usage** On an AMF controller, AMF remote-area masters must be authorized by the controller, and the AMF remote-area masters will also need to authorized access from the AMF controller.

**Example** To authorize all AMF nodes in the pending authorization queue on an AMF master, use the command:

```
awplus# atmf authorize all-pending
```

To authorize a node called "node2" in remote AMF area "area3", use the command:

```
awplus# atmf authorize node2 area "area3"
```

To authorize a node called "node4" on an AMF master, use the command:

```
awplus# atmf authorize node4
```

To revoke authorization for a node called "node4" on an AMF master, use the command:

```
awplus# no atmf authorize node4
```

**Related Commands**

- [atmf secure-mode](#)
- [clear atmf secure-mode certificates](#)
- [show atmf authorization](#)
- [show atmf secure-mode](#)



show atmf secure-mode certificates

show atmf secure-mode statistics

**Command changes** Version 5.4.7-0.3: command added

# atmf authorize provision

**Overview** Use this command from an AMF controller or AMF master to pre-authorize a node on an AMF network running in secure mode. This allows a node to join the AMF network the moment the `atmf secure-mode` command is run on that node.

Use the **no** variant of this command to remove a provisional authorization from and AMF controller or AMF master.

**Syntax**

```
atmf authorize provision [timeout <minutes>] node <node-name>
interface <interface-name> [area <area-name>]

atmf authorize provision [timeout <minutes>] mac <mac-address>

atmf authorize provision [timeout <minutes>] all

no atmf authorize provision node <node-name> interface
<interface-name> [area <area-name>]

no atmf authorize provision mac <mac-address>

no atmf authorize provision all
```

| Parameter        | Description                                                                                                            |
|------------------|------------------------------------------------------------------------------------------------------------------------|
| timeout          | Timeout for provisional authorization. Authorization for provisioned nodes expires after the timeout period specified. |
| <minutes>        | Timeout in minutes. A value between 1 and 6000 is permissible with the default being 60 minutes.                       |
| node             | Specify a node to provision by node name.                                                                              |
| <node-name>      | The name of the node to provisionally authorize.                                                                       |
| interface        | Specify the interface the node will connect on.                                                                        |
| <interface-name> | The name of the interface, this can be a switchport, link aggregator, LACP link, or virtual link.                      |
| area             | Specify the AMF area.                                                                                                  |
| <area-name>      | This is the name of the area the node belongs to.                                                                      |
| mac              | Specify a node to provision by MAC address.                                                                            |
| <mac-address>    | Enter a MAC address to provisionally authorize in the format HHHH.HHHH.HHHH.                                           |
| all              | Provision authorization for all secure mode capable nodes.                                                             |

**Default** The default timeout is 60 minutes.

**Mode** Privileged Exec

**Example** To provisionally authorize all non-secure AMF nodes, use the command:

```
awplus# atmf authorize provision all
```

To authorize a node with a MAC address of 0000.cd28.0880 for 2 hours, use the command:

```
awplus# authorize provision timeout 120 mac 0000.cd28.0880
```

To remove all provisional authorization, on an AMF master, use the command:

```
awplus# no atmf authorize provision all
```

**Related  
Commands**    [show atmf authorization](#)  
              [show atmf secure-mode](#)

**Command  
changes**    Version 5.4.7-0.3: command added

# atmf backup

**Overview** This command can only be applied to a master node. It manually schedules an AMF backup to start at a specified time and to execute a specified number of times per day.

Use the **no** variant of this command to disable the schedule.

**Syntax** `atmf backup {default|<hh:mm> frequency <1-24>}`

| Parameter        | Description                                                                                                            |
|------------------|------------------------------------------------------------------------------------------------------------------------|
| default          | Restore the default backup schedule.                                                                                   |
| <hh:mm>          | Sets the time of day to apply the first backup, in hours and minutes. Note that this parameter uses the 24 hour clock. |
| backup           | Enables AMF backup to external media.                                                                                  |
| frequency <1-24> | Sets the number of times within a 24 hour period that backups will be taken.                                           |

**Default** Backups run daily at 03:00 AM, by default

**Mode** Global Configuration

**Usage** Running this command only configures the schedule. To enable the schedule, you should then apply the command [atmf backup enable](#).

We recommend using the ext3 or ext4 filesystem on external media that are used for AMF backups.

**Example** To schedule backup requests to begin at 11 am and execute twice per day (11 am and 11 pm), use the following command:

```
node_1# configure terminal
node_1(config)# atmf backup 11:00 frequency 2
```

**CAUTION:** File names that comprise identical text, but with differing case, such as *Test.txt* and *test.txt*, will not be recognized as being different on FAT32 based backup media such as a USB storage device. However, these filenames will be recognized as being different on your Linux based device. Therefore, for good practice, ensure that you apply a consistent case structure for your back-up file names.

**Related Commands**

- [atmf backup enable](#)
- [atmf backup stop](#)
- [show atmf backup](#)

# atmf backup area-masters delete

**Overview** Use this command to delete from external media, a backup of a specified node in a specified area.

Note that this command can only be run on an AMF controller.

**Syntax** `atmf backup area-masters delete area <area-name> node <node-name>`

| Parameter                      | Description                                                   |
|--------------------------------|---------------------------------------------------------------|
| <code>&lt;area-name&gt;</code> | The area that contains the node whose backup will be deleted. |
| <code>&lt;node-name&gt;</code> | The node whose backup will be deleted.                        |

**Mode** Privileged Exec

**Example** To delete the backup of the remote area-master named “well-gate” in the AMF area named Wellington, use the command:

```
controller-1# atmf backup area-masters delete area Wellington
node well-gate
```

**Related Commands** [show atmf backup area](#)

# atmf backup area-masters enable

**Overview** Use this command to enable backup of remote area-masters from the AMF controller. This command is only valid on AMF controllers.

Use the **no** form of the command to stop backups of remote area-masters.

**Syntax** `atmf backup area-masters enable`  
`no atmf backup area-masters enable`

**Mode** Global configuration

**Default** Remote area backups are disabled by default

**Usage** Use the following commands to configure the remote area-master backups:

- `atmf backup` to configure when the backups begin and how often they run
- `atmf backup server` to configure the backup server.

We recommend using the ext3 or ext4 filesystem on external media that are used for AMF backups.

**Example** To enable scheduled backups of AMF remote area-masters, use the commands:

```
controller-1# configure terminal
controller-1(config)# atmf backup area-masters enable
```

To disable scheduled backups of AMF remote area-masters, use the commands:

```
controller-1# configure terminal
controller-1(config)# no atmf backup area-masters enable
```

**Related  
Commands** `atmf backup server`  
`atmf backup`  
`show atmf backup area`

# atmf backup area-masters now

**Overview** Use this command to run an AMF backup of one or more remote area-masters from the AMF controller immediately.

This command is only valid on AMF controllers.

**Syntax** `atmf backup area-masters now [area <area-name>|area <area-name>  
node <node-name>]`

| Parameter   | Description                                    |
|-------------|------------------------------------------------|
| <area-name> | The area whose area-masters will be backed up. |
| <node-name> | The node that will be backed up.               |

**Mode** Privileged Exec

**Example** To back up all local master nodes in all areas controlled by controller-1, use the command

```
controller-1# atmf backup area-masters now
```

To back up all local masters in the AMF area named Wellington, use the command

```
controller-1# atmf backup area-masters now area Wellington
```

To back up the local master "well-master" in the Wellington area, use the command

```
controller-1# atmf backup area-masters now area Wellington node
well-master
```

**Related Commands** [atmf backup area-masters enable](#)  
[atmf backup area-masters synchronize](#)  
[show atmf backup area](#)

# atmf backup area-masters synchronize

**Overview** Use this command to synchronize backed-up area-master files between the active remote file server and the backup remote file server. Files are copied from the active server to the remote server.

Note that this command is only valid on AMF controllers.

**Syntax** `atmf backup area-masters synchronize`

**Mode** Privileged Exec

**Example** To synchronize backed-up files between the remote file servers for all area-masters, use the command:

```
controller-1# atmf backup area-masters synchronize
```

**Related Commands**

- [atmf backup area-masters enable](#)
- [atmf backup area-masters now](#)
- [show atmf backup area](#)



# atmf backup bandwidth

**Overview** This command sets the maximum bandwidth in kilobytes per second (kBps) available to the AMF backup process. This command enables you to restrict the bandwidth that is utilized for downloading file contents during a backup.

**NOTE:** *This command will only run on an AMF master. An error message will be generated if the command is attempted on node that is not a master.*

*Also note that setting the bandwidth value to zero will allow the transmission of as much bandwidth as is available, which can exceed the maximum configurable speed of 1000 kBps. In effect, zero means unlimited.*

Use the **no** variant of this command to reset (to its default value of zero) the maximum bandwidth in kilobytes per second (kBps) available when initiating an AMF backup. A value of zero tells the backup process to transfer files using unlimited bandwidth.

**Syntax** `atmf backup bandwidth <0-1000>`  
`no atmf backup bandwidth`

| Parameter                   | Description                                       |
|-----------------------------|---------------------------------------------------|
| <code>&lt;0-1000&gt;</code> | Sets the bandwidth in kilobytes per second (kBps) |

**Default** The default value is zero, allowing unlimited bandwidth when executing an AMF backup.

**Mode** Global Configuration

**Examples** To set an atmf backup bandwidth of 750 kBps, use the commands:

```
node2# configure terminal
node2(config)# atmf backup bandwidth 750
```

To set the AMF backup bandwidth to the default value for unlimited bandwidth, use the commands:

```
node2# configure terminal
node2(config)# no atmf backup bandwidth
```

**Related Commands** [show atmf backup](#)

# atmf backup delete

**Overview** This command removes the backup file from the external media of a specified AMF node.

Note that this command can only be run from an AMF master node.

**Syntax** `atmf backup delete <node-name>`

| Parameter                      | Description                                         |
|--------------------------------|-----------------------------------------------------|
| <code>&lt;node-name&gt;</code> | The AMF node name of the backup file to be deleted. |

**Mode** Privileged Exec

**Example** To delete the backup file from node2, use the following command:

```
Node_1# atmf backup delete node2
```

**Related Commands**

- `show atmf backup`
- `atmf backup now`
- `atmf backup stop`

# atmf backup enable

**Overview** This command enables automatic AMF backups on the AMF master node that you are connected to. By default, automatic backup starts at 3:00 AM. However, this schedule can be changed by the [atmf backup](#) command. Note that backups are initiated and stored only on the master nodes.

Use the **no** variant of this command to disable any AMF backups that have been scheduled and previously enabled.

**Syntax** `atmf backup enable`  
`no atmf backup enable`

**Default** Automatic AMF backup functionality is enabled on the AMF master when it is configured and external media, i.e. an SD card or a USB storage device or remote server, is detected.

**Mode** Global Configuration

**Usage** A warning message will appear if you run the [atmf backup enable](#) command with either insufficient or marginal memory availability on your external storage device.

You can use the command [show atmf backup](#) on page 2249 to check the amount of space available on your external storage device.

We recommend using the ext3 or ext4 filesystem on external media that are used for AMF backups.

**Example** To turn on automatic AMF backup, use the following command:

```
AMF_Master_1# configure terminal
AMF_Master_1(config)# atmf backup enable
```

**Related Commands** [show atmf](#)  
[show atmf backup](#)  
[atmf backup](#)  
[atmf backup now](#)  
[atmf enable](#)

# atmf backup guests delete

**Overview** This command removes a guest node's backup files from external media such as a USB drive, SD card, or an external file server.

**Syntax** `atmf backup guests delete <node-name> <guest-port>`

| Parameter                       | Description                          |
|---------------------------------|--------------------------------------|
| <code>&lt;node-name&gt;</code>  | The name of the guest's parent node. |
| <code>&lt;guest-port&gt;</code> | The port number on the parent node.  |

**Mode** User Exec/Privileged Exec

**Example** On a parent node named "node1" (which, in this case, the user has a direct console connection to) use the following command to remove the backup files of the guest node that is directly connected to port1.0.3.

```
node1# atmf backup guests delete node1 port1.0.3
```

**Related Command** [atmf backup delete](#)  
[atmf backup area-masters delete](#)  
[show atmf backup guest](#)

# atmf backup guests enable

**Overview** Use this command to enable backups of remote guest nodes from an AMF master. Use the **no** variant of this command to disable the ability of the guest nodes to be backed up.

**Syntax** `atmf backup guests enable`  
`no atmf backup guests enable`

**Default** Guest node backups are enabled by default.

**Mode** Global Config

**Usage** We recommend using the ext3 or ext4 filesystem on external media that are used for AMF backups.

**Example** On the AMF master node, enable all scheduled guest node backups:

```
atmf-master# configure terminal
atmf-master(config)# atmf backup guests enable
```

**Related Commands** [atmf backup area-masters enable](#)  
[show atmf backup guest](#)  
[atmf backup guests synchronize](#)

# atmf backup guests now

**Overview** This command manually triggers an AMF backup of guest nodes on a AMF Master.

**Syntax** `atmf backup guests now [<node-name>] [<guest-port>]`

| Parameter                       | Description                                      |
|---------------------------------|--------------------------------------------------|
| <code>&lt;node-name&gt;</code>  | The name of the guest's parent node.             |
| <code>&lt;guest-port&gt;</code> | The port number that connects to the guest node. |

**Default** N/A

**Mode** Privileged Exec

**Example** Use the following command to manually trigger the backup of all guests in the AMF network

```
awplus# atmf backup guests now
```

**Example** To manually trigger the backup of a guest node connected to port 1.0.23 of node1, use the following command:

```
awplus# atmf backup guests now node1 port1.0.23
```

**Related Commands** [show atmf backup guest](#)

# atmf backup guests synchronize

**Overview** This command initiates a manual synchronization of all guest backup file-sets across remote file servers and various redundancy backup media, such as USB storage devices. This facility ensures that each device contains the same backup image files. Note that this backup synchronization process will occur as part of the regular backups scheduled by the [atmf backup](#) command.

**Syntax** `atmf backup guests synchronize`

**Default** N/A

**Mode** User Exec/Privileged Exec

**Example** To synchronize backups across remote file servers and storage devices, use the command:

```
Node1#atmf backup guests synchronize
```

**Related Commands** [atmf backup redundancy enable](#)  
[show atmf guests](#)  
[atmf backup guests enable](#)

# atmf backup now

**Overview** This command initiates an immediate AMF backup of either all AMF members, or a selected AMF member. Note that this backup information is stored in the external media on the master node of the device on which this command is run, even though the selected AMF member may not be a master node.

Note that this command can only be run on an AMF master node.

**Syntax** `atmf backup now [<nodename>]`

| Parameter                      | Description                                                                                                                                                                                                                                                                                                                                                                                                                                     |
|--------------------------------|-------------------------------------------------------------------------------------------------------------------------------------------------------------------------------------------------------------------------------------------------------------------------------------------------------------------------------------------------------------------------------------------------------------------------------------------------|
| <nodename><br>or<br><hostname> | The name of the AMF member to be backed up, as set by the command <code>hostname</code> on page 238. Where no name has been assigned to this device, then you must use the default name, which is the word "host", then an underscore, then (without a space) the MAC address of the device to be backed up. For example <code>host_0016_76b1_7a5e</code> . Note that the node-name appears as the command Prompt when in Privileged Exec mode. |

**Default** A backup is initiated for all nodes on the AMF (but stored on the master nodes).

**Mode** Privileged Exec

**Usage** Although this command will select the AMF node to be backed-up, it can only be run from any AMF master node.

**NOTE:** *The backup produced will be for the selected node but the backed-up config will reside on the external media of the AMF master node on which the command was run. However, this process will result in the information on one master being more up-to-date. To maintain concurrent backups on both masters, you can apply the backup now command to the master working-set. This is shown in Example 4 below.*

**Example 1** In this example, an AMF member has not been assigned a host name. The following command is run on the `AMF_Master_2` node to immediately backup the device that is identified by its MAC address of `0016.76b1.7a5e`:

```
AMF_Master_2# atmf backup now host_0016_76b1_7a5e
```

**NOTE:** *When a host name is derived from its MAC address, the syntax format entered changes from `XXXX.XXXX.XXXX` to `XXXX_XXXX_XXXX`.*

**Example 2** In this example, an AMF member has the host name, **office\_annex**. The following command will immediately backup this device:

```
AMF_Master_2# atmf backup now office_annex
```

This command is initiated on the device's master node named **AMF\_Master\_2** and initiates an immediate backup on the device named **office\_annex**.



**Example 3** To initiate from AMF\_master\_1 an immediate backup of all AMF member nodes, use the following command:

```
AMF_Master_1# amf backup now
```

**Example 4** To initiate an immediate backup of the node with the host-name “office\_annex” and store the configuration on both masters, use the following process:

From the AMF\_master\_1, set the working-set to comprise only of the automatic group, master nodes.

```
AMF_Master_1# atmf working-set group master
```

This command returns the following display:

```
=====
AMF_Master_1, AMF_Master_2
=====

Working set join
```

Backup the AMF member with the host name, **office\_annex** on both the master nodes as defined by the working set.

```
AMF_Master[2]# atmf backup now office_annex
```

Note that the [2] shown in the command prompt indicates a 2 node working-set.

- Related Commands**
- [atmf backup](#)
  - [atmf backup stop](#)
  - [hostname](#)
  - [show atmf backup](#)

# atmf backup redundancy enable

**Overview** This command is used to enable or disable AMF backup redundancy.

**Syntax** `atmf backup redundancy enable`  
`no atmf backup redundancy enable`

**Default** Disabled

**Mode** Global Configuration

**Usage** If the AMF Master or Controller supports any removable media (SD card/USB), it uses the removable media as the redundant backup for the AMF data backup.

This feature is valid only if remote file servers are configured on the AMF Master or Controller.

We recommend using the ext3 or ext4 filesystem on external media that are used for AMF backups.

**Example** To enable AMF backup redundancy, use the commands:

```
awplus# configure terminal
awplus(config)# atmf backup redundancy enable
```

To disable AMF backup redundancy, use the commands:

```
awplus# configure terminal
awplus(config)# no atmf backup redundancy enable
```

**Related Commands** [atmf backup synchronize](#)  
[show atmf backup](#)  
[show atmf backup area](#)

# atmf backup server

**Overview** This command configures remote file servers as the destination for AMF backups.

Use the **no** variant of this command to remove the destination server(s). When all servers are removed the system will revert to backup from external media.

**Syntax** `atmf backup server id {1|2} <hostlocation> username <username>`  
`[path <path>|port <1-65535>]`  
`no atmf backup server id {1|2}`

| Parameter      | Description                                                                                                                                                                                      |
|----------------|--------------------------------------------------------------------------------------------------------------------------------------------------------------------------------------------------|
| id             | Remote server backup server identifier.                                                                                                                                                          |
| {1 2}          | The backup server identifier number (1 or 2). Note that there can be up to two backup servers, numbered 1 and 2 respectively, and you would need to run this command separately for each server. |
| <hostlocation> | Either the name or the IP address (IPv4 or IPv6) of the selected backup server (1 or 2).                                                                                                         |
| username       | Configure the username to log in with on the selected remote file server.                                                                                                                        |
| <username>     | The selected remote file server's username.                                                                                                                                                      |
| path           | The location of the backup files on the selected remote file server. By default this will be the home directory of the username used to log in with.                                             |
| <path>         | The directory path utilized to store the backup files on the selected remote file server. No spaces are allowed in the path.                                                                     |
| port           | The connection to the selected remote backup file server using SSH. By default SSH connects to a device on TCP port 22 but this can be changed with this command.                                |
| <1-65535>      | A TCP port within the specified range.                                                                                                                                                           |

**Defaults** Remote backup servers are not configured. The default SSH TCP port is 22. The path utilized on the remote file server is the home directory of the username.

**Mode** Global Exec

**Usage** The hostname and username parameters must both be configured.

**Examples** To configure server 1 with an IPv4 address and a username of *backup1*, use the commands:

```
AMF_Master_1# configure terminal
AMF_Master_1(config)# atmf backup server id 1 192.168.1.1
username backup1
```

To configure server 1 with an IPv6 address and a username of *backup1*, use the command:

```
AMF_backup1_1# configure terminal
AMF_Master_1(config)# atmf backup server id 1 FFEE::01 username
backup1
```

To configure server 2 with a hostname and username, use the command:

```
AMF_Master_1# configure terminal
AMF_Master_1(config)# atmf backup server id 2 www.example.com
username backup2
```

To configure server 2 with a hostname and username in addition to the optional path and port parameters, use the command:

```
AMF_Master_1# configure terminal
AMF_Master_1(config)# atmf backup server id 2 www.example.com
username backup2 path tokyo port 1024
```

To unconfigure the AMF remote backup file server 1, use the command:

```
AMF_Master_1# configure terminal
AMF_Master_1(config)# no atmf backup server id 1
```

**Related  
Commands**    [show atmf backup](#)

# atmf backup stop

**Overview** Running this command stops a backup that is currently running on the master node you are logged onto. Note that if you have two masters and want to stop both, then you can either run this command separately on each master node, or add both masters to a working set, and issue this command to the working set.

Note that this command can only be run on a master node.

**Syntax** `atmf backup stop`

**Mode** Privileged Exec

**Usage** This command is used to halt an AMF backup that is in progress. In this situation the backup process will finish on its current node and then stop.

**Example** To stop a backup that is currently executing on master node node-1, use the following command:

```
AMF_Master_1# amf backup stop
```

**Related Commands**

- [atmf backup](#)
- [atmf backup enable](#)
- [atmf backup now](#)
- [show atmf backup](#)

# atmf backup synchronize

**Overview** For the master node you are connected to, this command initiates a system backup of files from the node's active remote file server to its backup remote file server. Note that this process happens automatically each time the network is backed up.

Note that this command can only be run from a master node.

**Syntax** `atmf backup synchronize`

**Mode** Privileged Exec

**Example** When connected to the master node `AMF_Master_1`, the following command will initiate a backup of all system related files from its active remote file server to its backup remote file server.

```
AMF_Master_1# atmf backup synchronize
```

**Related Commands**

- [atmf backup enable](#)
- [atmf backup redundancy enable](#)
- [show atmf](#)
- [show atmf backup](#)

# atmf cleanup

**Overview** This command erases all data from NVS and all data from Flash **excluding** the following:

- the current release file
- the backup release file
- license files

It then reboots to put the device in a clean state ready to be used as a replacement node on a provisioned port.

**Syntax** `atmf cleanup`

**Mode** Privileged Exec

**Usage** This command is an alias to the [erase factory-default](#) command.

**Example** To erase data, use the command:

```
Node_1# atmf cleanup
```

```
This command will erase all NVS, all flash contents except for
the boot release, and any license files, and then reboot the
switch. Continue? (y/n):y
```

**Related  
Commands** [erase factory-default](#)

# atmf container

**Overview** Use this command to create or update an AMF container on a Virtual AMF Appliance (VAA) virtual machine.

An AMF container is an isolated instance of AlliedWare Plus with its own network interfaces, configuration, and file system. The features available inside an AMF container are a sub-set of the features available on the host VAA. These features enable the AMF container to function as a uniquely identifiable AMF master and allows for multiple tenants (up to 60) to run on a single VAA host. See the [AMF Feature Overview and Configuration Guide](#) for more information on running multiple tenants on a single VAA host.

Use the **no** variant of this command to remove an AMF container.

**Syntax** `atmf container <container-name>`  
`no atmf container <container-name>`

| Parameter                           | Description                                                 |
|-------------------------------------|-------------------------------------------------------------|
| <code>&lt;container-name&gt;</code> | The name of the AMF container to create, update, or remove. |

**Mode** AMF Container Configuration

**Usage** You cannot delete a container while it is still running. First use the **state disable** command to stop the container.

**Examples** To create or update the AMF container "vac-wlg-1", use the commands:

```
awplus# configure terminal
awplus(config)# atmf container vac-wlg-1
awplus(config-atmf-container)#
```

To remove the AMF container "vac-wlg-1", use the commands:

```
awplus# configure terminal
awplus(config)# no atmf container vac-wlg-1
```

**Related Commands**

- [area-link](#)
- [atmf container login](#)
- [bridge-group](#)
- [description \(amf container\)](#)
- [show atmf container](#)
- [state](#)

**Command changes** Version 5.4.7-0.1: command added



# atmf container login

**Overview** Use this command to login to an AMF container on a Virtual AMF Appliance (VAA).

An AMF container is an isolated instance of AlliedWare Plus with its own network interfaces, configuration, and file system. The features available inside an AMF container are a sub-set of the features available on the host VAA. These features enable the AMF container to function as a uniquely identifiable AMF master and allows for multiple tenants (up to 60) to run on a single VAA host. See the [AMF Feature Overview and Configuration Guide](#) for more information on running multiple tenants on a single VAA host.

**Syntax** `atmf container login <container-name>`

| Parameter                           | Description                                           |
|-------------------------------------|-------------------------------------------------------|
| <code>&lt;container-name&gt;</code> | The name of the AMF container you wish to login into. |

**Mode** Privileged Exec

**Usage** If you try to login to a AMF container that has not been created, or is not running, you will see the following message:

```
% Container does not exist or is not running.
```

To exit from a container and return to the host VAA press `<Ctrl+a q>`.

**Example** To login to container “vac-wlg-1”, use the command:

```
awplus# atmf container login vac-wlg-1
```

You will then be presented with a login screen for that container:

```
Connected to tty 1
Type <Ctrl+a q> to exit the console, <Ctrl+a Ctrl+a> to enter Ctrl+a itself

vac-wlg-1 login: manager
Password: friend

AlliedWare Plus (TM) 5.4.7 02/03/17 08:46:12

vac-wlg-1>
```

**Related Commands** [atmf container](#)  
[show atmf container](#)

**Command changes** Version 5.4.7-0.1: command added

# atmf controller

**Overview** Use this command to configure the device as an AMF controller. This enables you to split a large AMF network into multiple areas.

AMF controller is a licensed feature. The number of areas supported on a controller depends on the license installed on that controller.

Use the **no** variant of this command to remove the AMF controller functionality.

**Syntax** `atmf controller`  
`no atmf controller`

**Mode** Global configuration

**Usage** If a valid AMF controller license is not available on the device, the device will accept this command but will not act as a controller until you install a valid license. The following message will warn you of this:

“An AMF Controller license must be installed before this feature will become active”

**NOTE:** *If the AMF controller functionality is removed from a device using the **no atmf controller** command then the device must be rebooted if it is to function properly as an AMF master.*

**Example** To configure the node named *controller-1* as an AMF controller, use the commands:

```
controller-1# configure terminal
controller-1(config)# atmf controller
```

To stop the node named *controller-1* from being an AMF controller, use the commands:

```
controller-1# configure terminal
controller-1(config)# no atmf controller
```

**Related  
Commands** [atmf area](#)  
[show atmf](#)

# atmf distribute firmware

**Overview** This command can be used to upgrade software one AMF node at a time. A URL can be selected from any media location. The latest compatible release for a node will be selected from this location.

Several procedures are performed to ensure the upgrade will succeed. This includes checking the current node release boots from flash. If there is enough space on flash the software release is copied to flash on the new location.

The new release name is updated using the [boot system](#) command. The old release will become the backup release file. If a release file exists in a remote device (such as TFTP or HTTP, for example) then the URL should specify the exact release filename without using a wild card character.

The command will continue to upgrade software until all nodes are upgraded. At the end of the upgrade cycle the command should be used on the working-set.

**Syntax** `atmf distribute firmware <filename>`

| Parameter                     | Description                                                                                                                           |
|-------------------------------|---------------------------------------------------------------------------------------------------------------------------------------|
| <code>&lt;filename&gt;</code> | The filename and path of the file. See the <a href="#">File Management Feature Overview and Configuration Guide</a> for valid syntax. |

**Mode** Privileged Exec

**Examples** To upgrade nodes in a AMF network with a predefined AMF group called "teams", use the following commands:

```
Team1# atmf working-set group teams
```

```
=====
Team1, Team2, Team3:
=====
Working set join
```

```
ATMF_NETWORK[3]# atmf distribute firmware card:*.rel
```

```
Retrieving data from Team1
Retrieving data from Team2
Retrieving data from Team3

ATMF Firmware Upgrade:

Node Name New Release File Status

Team1 x510-5.4.7-1.1.rel Release ready
Team2 x930-5.4.7-1.1.rel Release ready
Team3 x930-5.4.7-1.1.rel Release ready
Continue the rolling reboot ? (y/n):y
=====
Copying Release : x510-5.4.7-1.1.rel to Team1
Updating Release : x510-5.4.7-1.1.rel information on Team1
=====
Copying Release : x930-5.4.7-1.1.rel to Team2
Updating Release : x930-5.4.7-1.1.rel information on Team2
=====
Copying Release : x930-5.4.7-1.1.rel to Team3
Updating Release : x930-5.4.7-1.1.rel information on Team3
=====
New firmware will not take effect until nodes are rebooted.
=====

ATMF_NETWORK[3]#
```

**Related** [atmf working-set](#)  
**Commands**

# atmf domain vlan

**Overview** The AMF domain VLAN is created when the AMF network is first initiated and is assigned a default VID of 4091. This command enables you to change the VID from this default value on this device.

The AMF domain VLAN is one of AMF's internal VLANs (the management VLAN is the other internal VLAN). AMF uses these internal VLANs to communicate network status information between nodes. These VLANs must be reserved for AMF and not used for other purposes.

An important point conceptually is that although the domain VLAN exists globally across the AMF network, it is assigned separately to each domain. The AMF network therefore can be thought of as comprising a series of domain VLANs each having the same VID and each being applied to a horizontal slice (domain) of the AMF. It follows therefore that the domain VLANs are only applied to ports that form cross-links and not to ports that form uplinks/downlinks.

**CAUTION:** Every member of your AMF network must have the same domain VLAN, management VLAN, and management subnet.

**CAUTION:** If you change the domain VLAN, management VLAN, or management subnet of a node, that change takes effect immediately and the node will immediately leave the AMF network and try to rejoin it. The AMF network will not be complete until you have given all devices the same setting, so they can all rejoin the AMF network.

Use the **no** variant of this command to reset the VLAN ID to its default value of 4091.

**Syntax** `atmf domain vlan <2-4090>`  
`no atmf domain vlan`

| Parameter                   | Description                             |
|-----------------------------|-----------------------------------------|
| <code>&lt;2-4090&gt;</code> | The VLAN number in the range 2 to 4090. |

**Default** VLAN 4091

**Mode** Global Configuration

**Usage** We recommend you only change the domain VLAN when first creating the AMF network, and only if VLAN 4091 is already being used in your network.

However, if you do need to change the VLAN on an existing AMF network, use the following steps:

- 1) Create a working set of the whole of your AMF network, using the commands:

```
master# atmf working-set group all
```

You must use **working-set group all** if changing the domain VLAN. If you use a different working-set, nodes that are not in that working-set will lose contact with the AMF network.

- 2) The prompt will display the number of nodes in the AMF network. Record this number. In this example, the network is named "test" and has 10 nodes:

```
test[10]#
```

- 3) Enter the new VLAN ID, using the commands:

```
test[10]# configure terminal
test(config)[10]# atmf domain vlan <2-4090>
```

The nodes will execute the command in parallel, leave the AMF network, and attempt to rejoin through the new VLAN.

- 4) Create the working set again, using the commands:

```
master(config)# exit
master# atmf working-set group all
```

- 5) Save the configuration, using the command:

```
test[10]# write
```

- 6) The prompt will display the number of nodes in the AMF network. Check that this is the same as the number in step 1. If it is not, you will need to change the VLAN on missing devices by logging into their consoles directly.

**NOTE:** The domain VLAN will automatically be assigned an IP subnet address based on the value configured by the command *atmf management subnet*.

The default VLAN ID lies outside the user-configurable range. If you need to reset the VLAN to the default VLAN ID, use the **no** variant of this command to do so.

**Examples** To change the AMF domain VLAN to 4090 in an existing AMF network, use the following commands:

```
master# atmf working-set group all
test[10]# configure terminal
test(config)[10]# atmf domain vlan 4090
master(config)# exit
master# atmf working-set group all
test[10]# write
```

To reset the AMF domain VLAN to its default of 4091 in an existing AMF network, use the following commands:

```
master# atmf working-set group all
test[10]# configure terminal
test(config)[10]# no atmf domain vlan
master(config)# exit
master# atmf working-set group all
test[10]# write
```

**Related commands** [atmf management subnet](#)  
[atmf management vlan](#)

# atmf enable

**Overview** This command manually enables (turns on) the AMF feature for the device being configured.

Use the **no** variant of this command to disable (turn off) the AMF feature on the member node.

**Syntax** atmf enable  
no atmf enable

**Default** Once AMF is configured, the AMF feature starts automatically when the device starts up.

**Mode** Global Configuration

**Usage** The device does not auto negotiate AMF domain specific settings such as the Network Name. You should therefore, configure your device with any domain specific (non default) settings before enabling AMF.

**Examples** To turn off AMF, use the command:

```
MyNode# config terminal
MyNode(config)# no atmf enable
```

To turn on AMF, use the command:

```
MyNode(config)# atmf enable
```

This command returns the following display:

```
% Warning: The ATMF network config has been set to enable
% Save the config and restart the system for this change to take
effect.
```



# atmf group (membership)

**Overview** This command configures a device to be a member of one or more AMF groups. Groups exist in three forms: Implicit Groups, Automatic Groups, and User-defined Groups.

- Implicit Groups
  - all: All nodes in the AMF
  - current: The current working-set
  - local: The originating node.

Note that the Implicit Groups do not appear in show group output.

- Automatic Groups - These are defined by hardware architecture, e.g. x510, x230, x8100, AR3050S, AR4050S.
- User-defined Groups - These enable you to define arbitrary groups of AMF members based on your own criteria.

Each node in the AMF is automatically assigned membership to the implicit groups, and the automatic groups that are appropriate to its node type, e.g. x230, PoE. Similarly, nodes that are configured as masters are automatically assigned to the master group.

Use the **no** variant of this command to remove the membership.

**Syntax** `atmf group <group-list>`  
`no atmf group <group-list>`

| Parameter                       | Description                                                                                                                                                  |
|---------------------------------|--------------------------------------------------------------------------------------------------------------------------------------------------------------|
| <code>&lt;group-list&gt;</code> | A list of group names. These should be entered as a comma delimited list without spaces. Names can contain alphanumeric characters, hyphens and underscores. |

**Mode** Global Configuration

**Usage** You can use this command to define your own arbitrary groups of AMF members based on your own network's configuration requirements. Applying a node to a non existing group will result in the group automatically being created.

Note that the master nodes are automatically assigned to be members of the pre-existing master group.

The following example configures the device to be members of three groups; two are company departments, and one comprises all devices located in building\_2. To avoid having to run this command separately on each device that is to be added to these groups, you can remotely assign all of these devices to a working-set, then use the capabilities of the working-set to apply the [atmf group \(membership\)](#) command to all members of the working set.

**Example 1** To specify the device to become a member of AMF groups named *marketing*, *sales*, and *building\_2*, use the following commands:

```
node-1# configure terminal
node-1(config)# atmf group marketing,sales,building_2
```

**Example 2** To add the nodes *member\_node\_1* and *member\_node\_2* to groups *building1* and *sales*, first add the nodes to the working-set:

```
master_node# atmf working-set member_node_1,member_node_2
```

This command returns the following output confirming that the nodes *member\_node\_1* and *member\_node\_2* are now part of the working-set:

```
=====
member_node_1, member_node_2
=====

Working set join
```

Then add the members of the working set to the groups:

```
atmf-net[2]# configure terminal
atmf-net[2](config)# atmf group building1,sales
atmf-net[2](config)# exit
atmf-net[2]# show atmf group
```

This command returns the following output displaying the groups that are members of the working-set.

```
=====
member_node_1
=====

AMF group information

building1, sales
```

**Related Commands** [show atmf group](#)  
[show atmf group members](#)

# atmf guest-class

**Overview** This modal command creates a guest-class. Guest-classes are modal templates that can be applied to selected guest types. Once you have created a guest-class, you can select it by entering its mode. From here, you can then configure a further set of operational settings specifically for the new guest-class. These settings can then all be applied to a guest link by running the [switchport atmf-guestlink](#) command. The following settings can be configured from each guest class mode:

- discovery method
- model type
- http-enable setting
- guest port, user name, and password

The **no** variant of this command removes the guest-class. Note that you cannot remove a guest-class that is assigned to a port.

**Syntax** `atmf guest-class <guest-class-name>`  
`no atmf guest-class`

| Parameter                             | Description                                                                                                    |
|---------------------------------------|----------------------------------------------------------------------------------------------------------------|
| <code>&lt;guest-class-name&gt;</code> | The name assigned to the guest-class type. This can be chosen from an arbitrary string of up to 15 characters. |

**Mode** Interface

**Example 1** To create a guest-class named **camera** use the following commands:

```
node1# configure terminal
node1(config)# atmf guest-class camera
node1(config-atmf-guest)# end
```

**Example 2** To remove the guest-class named **phone** use the following commands:

```
node1# configure terminal
node1(config)# no atmf guest-class phone
node1(config-atmf-guest)# end
```

**Related Commands**

- [show atmf area guests](#)
- [discovery](#)
- [http-enable](#)
- [username](#)
- [modeltype](#)
- [switchport atmf-guestlink](#)

show atmf links guest

show atmf guests

# atmf log-verbose

**Overview** This command limits the number of log messages displayed on the console or permanently logged.

Use the **no** variant of this command to reset to the default.

**Syntax** atmf log-verbose <1-3>  
no atmf log-verbose

| Parameter | Description                                         |
|-----------|-----------------------------------------------------|
| <1-3>     | The verbose limitation (3 = noisiest, 1 = quietest) |

**Default** The default log display is 3.

**Usage** This command is intended for use in large networks where verbose output can make the console unusable for periods of time while nodes are joining and leaving.

**Mode** Global Configuration

**Example** To set the log-verbose to noise level 2, use the command:

```
node-1# configure terminal
node-1(config)# atmf log-verbose 2
```

**Validation Command** `show atmf`

# atmf management subnet

**Overview** This command is used to assign a subnet that will be allocated to the AMF management and domain management VLANs. From the address space defined by this command, two subnets are created, a management subnet component and a domain component, as explained in the Usage section below.

AMF uses these internal IPv4 subnets to communicate network status information between nodes. These subnet addresses must be reserved for AMF and not used for other purposes.

**CAUTION:** Every member of your AMF network must have the same domain VLAN, management VLAN, and management subnet.

**CAUTION:** If you change the domain VLAN, management VLAN, or management subnet of a node, that change takes effect immediately and the node will immediately leave the AMF network and try to rejoin it. The AMF network will not be complete until you have given all devices the same setting, so they can all rejoin the AMF network.

Use the **no** variant of this command to remove the assigned subnet.

**Syntax** atmf management subnet <a.b.0.0>  
no atmf management subnet

| Parameter | Description                                                                                                                                                                                                                                                                                                                                                      |
|-----------|------------------------------------------------------------------------------------------------------------------------------------------------------------------------------------------------------------------------------------------------------------------------------------------------------------------------------------------------------------------|
| <a.b.0.0> | The IP address selected for the management subnet. Because a mask of 255.255.0.0 (i.e. /16) will be applied automatically, an IP address in the format a.b.0.0 must be selected. Usually this subnet address is selected from an appropriate range from within the private address space of 172.16.0.0 to 172.31.255.255, or 192.168.0.0, as defined in RFC1918. |

**Default** 172.31.0.0. A subnet mask of 255.255.0.0 will automatically be applied.

**Mode** Global Configuration

**Usage** Running this command will result in the creation of a further two subnets (within the class B address space assigned) and the mask will extend from /16 to /17.

For example, if the management subnet is assigned the address 172.31.0.0/16, this will result in the automatic creation of the following two subnets:

- 172.31.0.0/17 assigned to the [atmf management vlan](#)
- 172.31.128.0/17 assigned to the [atmf domain vlan](#).

We recommend you only change the management subnet when first creating the AMF network, and only if 172.31.0.0 is already being used in your network.

However, if you do need to change the subnet on an existing AMF network, use the following steps:

- 1) Create a working set of the whole of your AMF network, using the commands:

```
master# atmf working-set group all
```

You must use **working-set group all** if changing the domain VLAN, management VLAN, or management subnet. If you use a different working-set, nodes that are not in that working-set will lose contact with the AMF network.

- 2) The prompt will display the number of nodes in the AMF network. Record this number. In this example, the network is named "test" and has 10 nodes:

```
test[10]#
```

- 3) Enter the new subnet address, using the commands:

```
test[10]# configure terminal
```

```
test(config)[10]# atmf management subnet <a.b.0.0>
```

The nodes will execute the command in parallel, leave the AMF network, and attempt to rejoin through the new subnet.

- 4) Create the working set again, using the commands:

```
master(config)# exit
```

```
master# atmf working-set group all
```

- 5) Save the configuration, using the command:

```
test[10]# write
```

- 6) The prompt will display the number of nodes in the AMF network. Check that this is the same as the number in step 1. If it is not, you will need to change the subnet on missing devices by logging into their consoles directly.

**Examples** To change the AMF management subnet address to 172.25.0.0 in an existing AMF network, use the following commands:

```
master# atmf working-set group all
```

```
test[10]# configure terminal
```

```
test(config)[10]# atmf management subnet 172.25.0.0
```

```
master(config)# exit
```

```
master# atmf working-set group all
```

```
test[10]# write
```

To reset the AMF management subnet address to its default of 172.31.0.0 in an existing AMF network, use the following commands:

```
master# atmf working-set group all
test[10]# configure terminal
test(config)[10]# no atmf management subnet
master(config)# exit
master# atmf working-set group all
test[10]# write
```

**Related commands**

- [atmf domain vlan](#)
- [atmf management vlan](#)



# atmf management vlan

**Overview** The AMF management VLAN is created when the AMF network is first initiated and is assigned a default VID of 4092. This command enables you to change the VID from this default value on this device.

The AMF management VLAN is one of AMF's internal VLANs (the domain VLAN is the other internal VLAN). AMF uses these internal VLANs to communicate network status information between nodes. These VLANs must be reserved for AMF and not used for other purposes.

**CAUTION:** Every member of your AMF network must have the same domain VLAN, management VLAN, and management subnet.

**CAUTION:** If you change the domain VLAN, management VLAN, or management subnet of a node, that change takes effect immediately and the node will immediately leave the AMF network and try to rejoin it. The AMF network will not be complete until you have given all devices the same setting, so they can all rejoin the AMF network.

Use the **no** variant of this command to restore the VID to the default of 4092.

**Syntax** `atmf management vlan <2-4090>`  
`no atmf management vlan`

| Parameter | Description                                  |
|-----------|----------------------------------------------|
| <2-4090>  | The VID assigned to the AMF management VLAN. |

**Default** VLAN 4092

**Mode** Global Configuration

**Usage** We recommend you only change the management VLAN when first creating the AMF network, and only if VLAN 4092 is already being used in your network.

However, if you do need to change the VLAN on an existing AMF network, use the following steps to ensure you change it on all nodes simultaneously:

- 1) Create a working set of the whole of your AMF network, using the commands:

```
master# atmf working-set group all
```

You must use **working-set group all** if changing the management VLAN. If you use a different working-set, nodes that are not in that working-set will lose contact with the AMF network.

- 2) The prompt will display the number of nodes in the AMF network. Record this number. In this example, the network is named "test" and has 10 nodes:

```
test[10]#
```

- 3) Enter the new VLAN ID, using the commands:

```
test[10]# configure terminal
test(config)[10]# atmf management vlan <2-4090>
```

The nodes will execute the command in parallel, leave the AMF network, and attempt to rejoin through the new VLAN.

- 4) Create the working set again, using the commands:

```
master(config)# exit
master# atmf working-set group all
```

- 5) Save the configuration, using the command:

```
test[10]# write
```

- 6) The prompt will display the number of nodes in the AMF network. Check that this is the same as the number in step 1. If it is not, you will need to change the VLAN on missing devices by logging into their consoles directly.

**NOTE:** The management VLAN will automatically be assigned an IP subnet address based on the value configured by the command *atmf management subnet*.

The default VLAN ID lies outside the user-configurable range. If you need to reset the VLAN to the default VLAN ID, use the **no** variant of this command to do so.

**Examples** To change the AMF management VLAN to 4090 in an existing AMF network, use the following commands:

```
master# atmf working-set group all
test[10]# configure terminal
test(config)[10]# atmf management vlan 4090
master(config)# exit
master# atmf working-set group all
test[10]# write
```

To reset the AMF management VLAN to its default of 4092 in an existing AMF network, use the following commands:

```
master# atmf working-set group all
test[10]# configure terminal
test(config)[10]# no atmf management vlan
master(config)# exit
master# atmf working-set group all
test[10]# write
```

**Related commands** [atmf domain vlan](#)  
[atmf management subnet](#)

# atmf master

**Overview** This command configures the device to be an AMF master node and automatically creates an AMF master group. The master node is considered to be the core of the AMF network, and must be present for the AMF to form. The AMF master has its node depth set to 0. Note that the node depth vertical distance is determined by the number of uplinks/downlinks that exist between the node and its master.

An AMF master node must be present for an AMF network to form. Up to two AMF master nodes may exist in a network, and they **must** be connected by an AMF crosslink.

**NOTE:** Master nodes are an essential component of an AMF network. In order to run AMF, an AMF License is required for each master node.

If the crosslink between two AMF masters fails, then one of the masters will become isolated from the rest of the AMF network.

Use the **no** variant of this command to remove the device as an AMF master node. The node will retain its node depth of 0 until the network is rebooted.

**NOTE:** Node depth is the vertical distance (or level) from the master node (whose depth value is 0).

**Syntax** `atmf master`  
`no atmf master`

**Default** The device is not configured to be an AMF master node.

**Mode** Global Configuration

**Example** To specify that this node is an AMF master, use the following command:

```
node-1# configure terminal
node-1(config)# atmf master
```

**Related Commands** [show atmf](#)  
[show atmf group](#)

# atmf mtu

**Overview** This command configures the AMF network Maximum Transmission Unit (MTU). The MTU value will be applied to the AMF Management VLAN, the AMF Domain VLAN and AMF Area links.

Use the **no** variant of this command to restore the default MTU.

**Syntax** `atmf mtu <1300-1442>`  
`no atmf mtu`

| Parameter   | Description                                                                                                                               |
|-------------|-------------------------------------------------------------------------------------------------------------------------------------------|
| <1300-1442> | The value of the maximum transmission unit for the AMF network, which sets the maximum size of all AMF packets generated from the device. |

**Default** 1300

**Mode** Global Configuration

**Usage** The default value of 1300 will work for all AMF networks (including those that involve virtual links over IPsec tunnels). If there are virtual links over IPsec tunnels anywhere in the AMF network, we recommend not changing this default. If there are no virtual links over IPsec tunnels, then this AMF MTU value may be increased for network efficiency.

**Example** To change the ATMF network MTU to 1442, use the command:

```
awplus(config)# atmf mtu 1442
```

**Related Commands** [show atmf detail](#)

# atmf network-name

**Overview** This command applies an AMF network name to a (prospective) AMF node. In order for an AMF network to be valid, its network-name must be configured on at least two nodes, one of which must be configured as a master and have an AMF License applied. These nodes may be connected using either AMF downlinks or crosslinks.

For more information on configuring an AMF master node, see the command [atmf master](#).

Use the **no** variant of this command to remove the AMF network name.

**Syntax** `atmf network-name <name>`  
`no atmf network-name`

| Parameter                 | Description                                                                              |
|---------------------------|------------------------------------------------------------------------------------------|
| <code>&lt;name&gt;</code> | The AMF network name. Up to 15 printable characters can be entered for the network-name. |

**Mode** Global Configuration

**Usage** This is one of the essential commands when configuring AMF and must be entered on each node that is to be part of the AMF.

A switching node (master or member) may be a member of only one AMF network.

**CAUTION:** *Ensure that you enter the correct network name. Entering an incorrect name will cause the AMF network to fragment (at the next reboot).*

**Example** To set the AMF network name to `amf_net` use the command:

```
Node_1(config)# atmf network-name amf_net
```

# atmf provision

**Overview** This command configures a specified port on an AMF node to accept a provisioned node, via an AMF link, some time in the future.

Use the **no** variant of this command to remove the provisioning on the node.

**Syntax** `atmf provision [<nodename>]`  
`no atmf provision`

| Parameter  | Description                                                                         |
|------------|-------------------------------------------------------------------------------------|
| <nodename> | The name of the provisioned node that will appear on the AMF network in the future. |

**Default** No AMF provisioning.

**Mode** Interface Configuration for a switchport, a static aggregator or a dynamic channel group.

**Usage** The port should be configured as an AMF link or cross link and should be “down” to add or remove a provisioned node.

**Example** To provision an AMF node named node1 for port1.0.1, use the command:

```
host1(config)# interface port1.0.1
host1(config-if)# atmf provision node1
```

**Related Commands** [switchport atmf-link](#)  
[switchport atmf-crosslink](#)  
[show atmf links](#)

# atmf provision node clone

**Overview** This command sets up a space on the backup media for use with a provisioned node and copies into it almost all files and directories from a chosen backup or provisioned node.

Alternatively, you can set up a new, unique provisioned node by using the command [atmf provision node create](#).

**Syntax** `atmf provision node <nodename> clone <source-nodename>`

| Parameter                            | Description                                                                        |
|--------------------------------------|------------------------------------------------------------------------------------|
| <code>&lt;nodename&gt;</code>        | The name that will be assigned to the clone when connected.                        |
| <code>&lt;source-nodename&gt;</code> | The name of the node whose configuration is to be copied for loading to the clone. |

**Mode** Privileged Exec

**Usage** This command is only available on master nodes in the AMF network.

You must run either this command or [atmf provision node create](#) command, before you can use other **atmf provision node** commands using the specified node name. If a backup or provisioned node already exists for the specified node then you must delete it before using the **atmf provision node clone** command.

When using this command it is important to be aware of the following:

- A copy of `<media>:atmf/<atmf_name>/nodes/<source_node>/flash` will be made for the provisioned node and stored in the backup media.
- The directory `<node_backup_dir>/flash/.config/ssh` is excluded from the copy.
- All contents of `<root_backup_dir>/nodes/<nodename>` will be deleted or overwritten.
- Settings for the expected location of other provisioned nodes are excluded from the copy.

The active and backup configuration files are automatically modified in the following ways:

- The **hostname** command is modified to match the name of the provisioned node.
- The **stack virtual-chassis-id** command is removed, if present.

**Example** To copy from the backup of device2 to create backup files for the new provisioned node device3 use the following command:

```
device1# atmf provision node device3 clone device2
```

Figure 50-1: Sample output from the **atmf provision node clone** command

```
device1#atmf provision node device3 clone device2
Copying...
Successful operation
```

To confirm that a new provisioned node has been cloned, use the command:

```
device1# show atmf backup
```

The output from this command is shown in the following figure, and shows the details of the new provisioned node device3.

Figure 50-2: Sample output from the **show atmf backup** command

```
device1#show atmf backup

Scheduled Backup Enabled
 Schedule 1 per day starting at 03:00
 Next Backup Time 01 Oct 2016 03:00
Backup Bandwidth Unlimited
Backup Media USB (Total 7446.0MB, Free 7297.0MB)
Server Config
 Synchronization Unsynchronized
 Last Run -
 1 Unconfigured
 2 Unconfigured
Current Action Idle
 Started -
 Current Node -

Node Name Date Time In ATMF On Media Status

device3 - - No Yes Prov
device1 30 Sep 2016 00:05:49 No Yes Good
device2 30 Sep 2016 00:05:44 Yes Yes Good
```



# atmf provision node configure boot config

**Overview** This command sets the configuration file to use during the next boot cycle. This command can also set a backup configuration file to use if the main configuration file cannot be accessed for an AMF provisioned node. To unset the boot configuration or the backup boot configuration use the **no boot** command.

Use the **no** variant of this command to set back to the default.

**Syntax** `atmf provision node <nodename> configure boot config [backup] [<file-path|URL>]`  
`atmf provision node [<nodename>] configure no boot config [backup]`

| Parameter       | Description                                         |
|-----------------|-----------------------------------------------------|
| <nodename>      | The name of the provisioned node.                   |
| <file-path URL> | The path or URL and name of the configuration file. |

**Default** No boot configuration files or backup configuration files are specified for the provisioned node.

**Mode** Privileged Exec

**Usage** When using this command to set a backup configuration file, the specified AMF provisioned node must exist. The specified file must exist in the flash directory created for the provisioned node in the AMF remote backup media.

**Examples** To set the configuration file `branch.cfg` on the AMF provisioned node `node1`, use the command:

```
MasterNodeName# atmf provision node node1 configure boot config
branch.cfg
```

To set the configuration file `backup.cfg` as the backup to the main configuration file on the AMF provisioned node `node1`, use the command:

```
MasterNodeName# atmf provision node node1 configure boot config
backup usb:/atmf/amf_net/nodes/node1/config/backup.cfg
```

To unset the boot configuration, use the command:

```
MasterNodeName# atmf provision node node1 configure no boot
config
```

To unset the backup boot configuration, use the command:

```
MasterNodeName# atmf provision node node1 configure no boot
config backup
```

**Related Commands** [atmf provision node configure boot system](#)  
[show atmf provision nodes](#)

# atmf provision node configure boot system

**Overview** This command sets the release file that will load onto a specified provisioned node during the next boot cycle. This command can also set the backup release file to be loaded for an AMF provisioned node. To unset the boot system release file or the backup boot release file use the **no boot** command.

Use the **no** variant of this command to return to the default.

This command can only be run on AMF master nodes.

**Syntax** `atmf provision node <nodename> configure boot system [backup] [<file-path|URL>]`  
`atmf provision node <nodename> configure no boot system [backup]`

| Parameter       | Description                                   |
|-----------------|-----------------------------------------------|
| <nodename>      | The name of the provisioned node.             |
| <file-path URL> | The path or URL and name of the release file. |

**Default** No boot release file or backup release files are specified for the provisioned node.

**Mode** Privileged Exec

**Usage** When using this command to set a backup release file, the specified AMF provisioned node must exist. The specified file must exist in the flash directory created for the provisioned node in the AMF remote backup media.

**Examples** To set the release file x930-5.4.7-1.1.rel on the AMF provisioned node "node1", use the command:

```
MasterNodeName# atmf provision node node1 configure boot system x930-5.4.7-1.1.rel
```

To set the backup release file x930-5.4.7-0.4.rel as the backup to the main release file on the AMF provisioned node "node1", use the command:

```
MasterNodeName# atmf provision node node1 configure boot system backup card:/atmf/amf_net/nodes/node1/flash/x930-5.4.7-0.4.rel
```

To unset the boot release, use the command:

```
MasterNodeName# atmf provision node node1 configure no boot system
```

To unset the backup boot release, use the command:

```
MasterNodeName# atmf provision node node1 configure no boot system backup
```

**Related Commands** [atmf provision node configure boot config](#)  
[show atmf provision nodes](#)

# atmf provision node create

**Overview** This command sets up an empty directory on the backup media for use with a provisioned node. This directory can have configuration and release files copied to it from existing devices. Alternatively, the configuration files can be created by the user.

An alternative way to create a new provisioned node is with the command [atmf provision node clone](#).

This command can only run on AMF master nodes.

**Syntax** `atmf provision node <nodename> create`

| Parameter  | Description                                     |
|------------|-------------------------------------------------|
| <nodename> | The name of the node that is being provisioned. |

**Mode** Privileged Exec

**Usage** This command is only available on master nodes in the AMF network.

The [atmf provision node create](#) command (or [atmf provision node clone](#)) must be executed before you can use other **atmf provision node** commands with the specified node name. If a backup or provisioned node already exists for the specified node name then you must delete it before using this command.

A date and time is assigned to the new provisioning directory reflecting when this command was executed. If there is a backup or provisioned node with the same name on another AMF master then the most recent one will be used.

**Example** To create a new provisioned node named "device2" use the command:

```
device1# atmf provision node device2 create
```

Running this command will create the following directories:

- `<media>:atmf/<atmf_name>/nodes/<node>`
- `<media>:atmf/<atmf_name>/nodes/<node>/flash`

To confirm the new node's settings, use the command:

```
device1# show atmf backup
```

The output for the **show atmf backup** command is shown in the following figure, and shows details for the new provisioned node device2.

Figure 50-3: Sample output from the **show atmf backup** command

```
device1#show atmf backup

Scheduled Backup Enabled
 Schedule 1 per day starting at 03:00
 Next Backup Time 01 Oct 2016 03:00
Backup Bandwidth Unlimited
Backup Media USB (Total 7446.0MB, Free 7315.2MB)
Server Config
 Synchronization Unsynchronized
 Last Run -
 1 Unconfigured
 2 Unconfigured
Current Action Idle
 Started -
 Current Node -

Node Name Date Time In ATMF On Media Status

device2 - - No Yes Prov
device1 30 Sep 2016 00:05:49 No Yes Good
```

For instructions on how to configure on a provisioned node, see the [AMF Feature Overview and Configuration Guide](#).

**Related commands** [atmf provision node clone](#)

# atmf provision node delete

**Overview** This command deletes files that have been created for loading onto a provisioned node. It can only be run on master nodes.

**Syntax** `atmf provision node <nodename> delete`

| Parameter  | Description                                     |
|------------|-------------------------------------------------|
| <nodename> | The name of the provisioned node to be deleted. |

**Mode** Privileged Exec

**Usage** This command is only available on master nodes in the AMF network. The command will only work if the provisioned node specified in the command has already been set up (although the device itself is still yet to be installed). Otherwise, an error message is shown when the command is run.

You may want to use the **atmf provision node delete** command to delete a provisioned node that was created in error or that is no longer needed.

This command cannot be used to delete backups created by the AMF backup procedure. In this case, use the command [atmf backup delete](#) to delete the files.

**NOTE:** *This command allows provisioned entries to be deleted even if they have been referenced by the [atmf provision](#) command, so take care to only delete unwanted entries.*

**Example** To delete backup files for a provisioned node named device3 use the command:

```
device1# atmf provision node device3 delete
```

To confirm that the backup files for provisioned node device3 have been deleted use the command:

```
device1# show atmf backup
```

The output should show that the provisioned node device3 no longer exists in the backup file, as shown in the figure below:

Figure 50-4: Sample output showing the **show atmf backup** command

```
device1#show atmf backup

Scheduled Backup Enabled
 Schedule 1 per day starting at 03:00
 Next Backup Time 01 Oct 2016 03:00
Backup Bandwidth Unlimited
Backup Media USB (Total 7446.0MB, Free 7297.0MB)
Server Config
 Synchronization Unsynchronized
 Last Run -
 1 Unconfigured
 2 Unconfigured
Current Action Idle
 Started -
 Current Node -

Node Name Date Time In ATMF On Media Status

device1 30 Sep 2016 00:05:49 No Yes Good
device2 30 Sep 2016 00:05:44 Yes Yes Good
```

**Related commands** [atmf provision node create](#)

# atmf provision node license-cert

**Overview** This command is used to set up the license certificate for a provisioned node.

The certificate file usually has all the license details for the network, and can be stored anywhere in the network. This command makes a hidden copy of the certificate file and stores it in the space set up for the provisioned node on AMF backup media.

For node provisioning, the new device has not yet been part of the AMF network, so the user is unlikely to know its product ID or its MAC address. When such a device joins the network, assuming that this command has been applied successfully, the copy of the certificate file will be applied automatically to the provisioned node.

Once the new device has been resurrected on the network and the certificate file has been downloaded to the provisioned node, the hidden copy of the certificate file is deleted from AMF backup media.

Use the **no** variant of this command to set it back to the default.

This command can only be run on AMF master nodes.

**Syntax** `atmf provision node <nodename> license-cert <file-path|URL>`  
`no atmf provision node <nodename> license-cert`

| Parameter                          | Description                                                                   |
|------------------------------------|-------------------------------------------------------------------------------|
| <code>&lt;nodename&gt;</code>      | The name of the provisioned node.                                             |
| <code>&lt;file-path URL&gt;</code> | The name of the certificate file. This can include the file-path of the file. |

**Default** No license certificate file is specified for the provisioned node.

**Mode** Privileged Exec

**Usage** This command is only available on master nodes in the AMF network. It will only operate if the provisioned node specified in the command has already been set up, and if the license certification is present in the backup file. Otherwise, an error message is shown when the command is run.

**Example 1** To apply the license certificate "cert1.txt" stored on a TFTP server for AMF provisioned node "device2", use the command:

```
device1# atmf provision node device2 license-cert
tftp://192.168.1.1/cert1.txt
```

**Example 2** To apply the license certificate "cert2.txt" stored in the AMF master's flash directory for AMF provisioned node "host2", use the command:

```
device1# atmf provision node host2 license-cert /cert2.txt
```

To confirm that the license certificate has been applied to the provisioned node, use the command [show atmf provision nodes](#). The output from this command is shown below, and displays license certification details in the last line.

Figure 50-5: Sample output from the **show atmf provision nodes** command

```
device1#show atmf provision nodes

ATMF Provisioned Node Information:

Backup Media: SD (Total 3827.0MB, Free 3481.1MB)

Node Name : device2
Date & Time : 06-Oct-2016 & 23:25:44
Provision Path : card:/atmf/nodes

Boot configuration :
Current boot image : x510-5.4.6-1.4.rel (file exists)
Backup boot image : x510-5.4.6-1.3.rel (file exists)
Default boot config : flash:/default.cfg (file exists)
Current boot config : flash:/abc.cfg (file exists)
Backup boot config : flash:/xyz.cfg (file exists)

Software Licenses :
Repository file : ../configs/.sw_v2.lic
 : ../configs/.swfeature.lic
Certificate file : card:/atmf/lok/nodes/awplus1/flash/.atmf-lic-cert
```

**Related commands** [show atmf provision nodes](#)



# atmf provision node locate

**Overview** This command changes the present working directory to the directory of a provisioned node. This makes it easier to edit files and create a unique provisioned node in the backup.

This command can only be run on AMF master nodes.

**Syntax** `atmf provision node <nodename> locate`

| Parameter                     | Description                       |
|-------------------------------|-----------------------------------|
| <code>&lt;nodename&gt;</code> | The name of the provisioned node. |

**Mode** Privileged Exec

**Usage** This command is only available on master nodes in the AMF network. The command will only work if the provisioned node specified in the command has already been set up. Otherwise, an error message is shown when the command is run.

**NOTE:** We advise that after running this command, you return to a known working directory, typically flash.

**Example** To change the working directory that happens to be on device1 to the directory of provisioned node device2, use the following command:

```
device1# atmf provision node device2 locate
```

The directory of the node device2 should now be the working directory. You can use the command `pwd` to check this, as shown in the following figure.

Figure 50-6: Sample output from the `pwd` command

```
device2#pwd
card:/atmf/building_2/nodes/device2/flash
```

The output above shows that the working directory is now the flash of device2.

**Related commands**

- [atmf provision node create](#)
- [atmf provision node clone](#)
- [pwd](#)

# atmf reboot-rolling

**Overview** This command enables you to reboot the nodes in an AMF working-set, one at a time, as a rolling sequence in order to minimize downtime. Once a rebooted node has finished running its configuration and its ports are up, it re-joins the AMF network and the next node is rebooted.

By adding the *url* parameter, you can also upgrade your devices' software one AMF node at a time.

The **force** parameter forces the rolling reboot to continue even if a previous node does not rejoin the AMF network. Without the **force** parameter, the unsuitable node will time-out and the rolling reboot process will stop. However, with the **force** parameter applied, the process will ignore the timeout and move on to reboot the next node in the sequence.

This command can take a significant amount of time to complete.

**Syntax** `atmf reboot-rolling [force] [<url>]`

| Parameter                | Description                                                                                                                                          |
|--------------------------|------------------------------------------------------------------------------------------------------------------------------------------------------|
| <code>force</code>       | Ignore a failed node and move on to the next node. Where a node fails to reboot a timeout is applied based on the time taken during the last reboot. |
| <code>&lt;url&gt;</code> | The path to the software upgrade file.                                                                                                               |

**Mode** Privileged Exec

**Usage** You can load the software from a variety of locations. The latest compatible release for a node will be selected from your selected location, based on the parameters and URL you have entered.

For example `card:/5.4.6/x*-5.4.6-*.rel` will select from the folder `card:/5.4.6` the latest file that matches the selection `x` (wildcard) `-5.4.6-` (wildcard).`rel`. Because `x*` is applied, each device type will be detected and its appropriate release file will be installed.

Other allowable entries are:

| Entry                                 | Used when loading software                              |
|---------------------------------------|---------------------------------------------------------|
| <code>card:*.rel:</code>              | from an SD card                                         |
| <code>tftp:&lt;ip-address&gt;:</code> | from a TFTP server                                      |
| <code>usb:</code>                     | from a USB flash drive                                  |
| <code>flash:</code>                   | from flash memory, e.g. from one x930 switch to another |
| <code>scp:</code>                     | using secure copy                                       |
| <code>http:</code>                    | from an HTTP file server                                |

Several checks are performed to ensure the upgrade will succeed. These include checking the current node release boots from flash. If there is enough space on flash, the software release is copied to flash to a new location on each node as it is processed. The new release name will be updated using the **boot system**<release-name> command, and the old release will become the backup release file.

**NOTE:** *If you are using TFTP or HTTP, for example, to access a file on a remote device then the URL should specify the exact release filename without using wild card characters.*

On bootup the software release is verified. Should an upgrade fail, the upgrading unit will revert back to its previous software version. At the completion of this command, a report is run showing the release upgrade status of each node.

**NOTE:** *Take care when removing external media or rebooting your devices. Removing an external media while files are being written entails a significant risk of causing a file corruption.*

**Example 1** To reboot all x510 nodes in an AMF network, use the following command:

```
Bld2_Floor_1# atmf working-set group x510
```

This command returns the following type of screen output:

```
=====
node1, node2, node3:
=====

Working set join

AMF_NETWORK[3]#
```

```
ATMF_NETWORK[3]# atmf reboot-rolling
```

When the reboot has completed, a number of status screens appear. The selection of these screens will depend on the parameters set.

```
Bld2_Floor_1#atmf working-set group x510

=====
SW_Team1, SW_Team2, SW_Team3:
=====

Working set join

ATMF_NETWORK[3]#atmf reboot-rolling
ATMF Rolling Reboot Nodes:

Node Name Timeout
 (Minutes)

SW_Team1 14
SW_Team2 8
SW_Team3 8
Continue the rolling reboot ? (y/n):y
=====
ATMF Rolling Reboot: Rebooting SW_Team1
=====

% SW_Team1 has left the working-set
Reboot of SW_Team1 has completed
=====
ATMF Rolling Reboot: Rebooting SW_Team2
=====

% SW_Team2 has left the working-set
Reboot of SW_Team2 has completed
=====
ATMF Rolling Reboot: Rebooting SW_Team3
=====

% SW_Team3 has left the working-set
Reboot of SW_Team3 has completed
=====
ATMF Rolling Reboot Complete
Node Name Reboot Status

SW_Team1 Rebooted
SW_Team2 Rebooted
SW_Team3 Rebooted
=====
```

**Example 2** To update firmware releases, use the following command:

```
Node_1# atmf working-set group all

ATMF_NETWORK[9]# atmf reboot-rolling
card:/5.4.6/x*-5.4.6-*.rel
```

```
ATMF Rolling Reboot Nodes:
```

| Node Name    | Timeout<br>(Minutes) | New Release File   | Status        |
|--------------|----------------------|--------------------|---------------|
| SW_Team1     | 8                    | x510-5.4.6-0.1.rel | Release Ready |
| SW_Team2     | 10                   | x510-5.4.6-0.1.rel | Release Ready |
| SW_Team3     | 8                    | ---                | Not Supported |
| HW_Team1     | 6                    | ---                | Incompatible  |
| Bld1_Floor_2 | 2                    | x930-5.4.6-0.1.rel | Release Ready |
| Bld1_Floor_1 | 4                    | ---                | Incompatible  |
| Building_1   | 2                    | ---                | Incompatible  |
| Building_2   | 2                    | x908-5.4.6-0.1.rel | Release Ready |

Continue upgrading releases ? (y/n):

# atmf recover

**Overview** This command is used to manually initiate the recovery (or replication) of an AMF node, usually when a node is being replaced.

**Syntax** `atmf recover [<node-name> master <node-name>]`  
`atmf recover [<node-name> controller <node-name>]`

| Parameter                           | Description                                                                                                                                                                                                                              |
|-------------------------------------|------------------------------------------------------------------------------------------------------------------------------------------------------------------------------------------------------------------------------------------|
| <i>&lt;node-name&gt;</i>            | The name of the device whose configuration is to be recovered or replicated.                                                                                                                                                             |
| master<br><i>&lt;node-name&gt;</i>  | The name of the master device that holds the required configuration information.<br>Note that although you can omit both the node name and the master name; you cannot specify a master name unless you also specify the node name.      |
| controller <i>&lt;node-name&gt;</i> | The name of the controller that holds the required configuration information.<br>Note that although you can omit both the node name and the controller name; you cannot specify a controller name unless you also specify the node name. |

**Mode** Privileged Exec

**Usage** The recovery/replication process involves loading the configuration file for a node that is either about to be replaced or has experienced some problem. You can specify the configuration file of the device being replaced by using the *<node-name>* parameter, and you can specify the name of the master node or controller holding the configuration file.

If the *<node-name>* parameter is not entered then the node will attempt to use one that has been previously configured. If the replacement node has no previous configuration (and has no previously used node-name), then the recovery will fail.

If the master or controller name is not specified then the device will poll all known AMF masters and controllers and execute an election process (based on the last successful backup and its timestamp) to determine which to use. If no valid backup master or controller is found, then this command will fail.

No error checking occurs when this command is run. Regardless of the last backup status, the recovering node will attempt to load its configuration from the specified master node or controller.

If the node has previously been configured, we recommend that you suspend any AMF backup before running this command. This is to prevent corruption of the backup files on the AMF master as it attempts to both backup and recover the node at the same time.

**Example** To recover the AMF node named Node\_10 from the AMF master node named Master\_2, use the following command:

```
Master_2# atmf recover Node_10 master Master_2
```

**Related  
Commands**

- atmf backup stop
- show atmf backup
- show atmf

# atmf recover guest

**Overview** Use this command to initiate a guest node recovery or replacement by reloading its backup file-set that is located within the AMF backup system. Note that this command must be run on the edge node device that connects to the guest node.

**Syntax** `atmf recover guest [<guest-port>]`

| Parameter                       | Description                                      |
|---------------------------------|--------------------------------------------------|
| <code>&lt;guest-port&gt;</code> | The port number that connects to the guest node. |

**Mode** User Exec/Privileged Exec

**Example** To recover a guest on node1 port1.0.1, use the following command

```
node1# atmf recover guest port1.0.1
```

**Related Commands** [show atmf backup guest](#)



# atmf recover led-off

**Overview** This command turns off the recovery failure flashing port LEDs. It reverts the LED's function to their normal operational mode, and in doing so assists with resolving the recovery problem. You can repeat this process until the recovery failure has been resolved. For more information, see the [AMF Feature Overview and Configuration Guide](#).

**Syntax** `atmf recover led-off`

**Default** Normal operational mode

**Mode** Privileged Exec

**Example** To revert the LEDs on Node1 from recovery mode display to their normal operational mode, use the command:

```
Node1# atmf recover led-off
```

**Related Commands** [atmf recover](#)

# atmf remote-login

**Overview** Use this command to remotely login to other AMF nodes in order to run commands as if you were a local user of that node.

**Syntax** `atmf remote-login [user <name>] <nodename>`

| Parameter  | Description                                            |
|------------|--------------------------------------------------------|
| <name>     | The name of a user on the remote node.                 |
| <nodename> | The name of the remote AMF node you are connecting to. |

**Mode** Privileged Exec (This command will only run at privilege level 15)

**Usage** You do not need a valid login on the local device in order to run this command. The session will take you to the enable prompt on the new device. If the remote login session exits for any reason (e.g. device reboot) you will be returned to the originating node.

You can create additional user accounts on nodes. AMF's goal is to provide a uniform management plane across the whole network, so we recommend you use the same user accounts on all the nodes in the network.

In reality, though, it is not essential to have the same accounts on all the nodes. Users can remote login from one node to a second node even if they are logged into the first node with a user account that does not exist on the second node (provided that `atmf restricted-login` is disabled and the user account on the first node has privilege level 15).

Moreover, it is possible to use a RADIUS or TACACS+ server to manage user authentication, so users can log into AMF nodes using user accounts that are present on the RADIUS or TACACS+ server, and not present in the local user databases of the AMF nodes.

The software will not allow you to run multiple remote login sessions. You must exit an existing session before starting a new one.

If you disconnect from the VTY session without first exiting from the AMF remote session, the device will keep the AMF remote session open until the `exec-timeout` time expires (10 minutes by default). If the `exec-timeout` time is set to infinity (`exec-timeout 0 0`), then the device is unable to ever close the remote session. To avoid this, we recommend you use the `exit` command to close AMF remote sessions, instead of closing the associated VTY sessions. We also recommend you avoid setting the `exec-timeout` to infinity.

**Example** To remotely login from node Node10 to Node20, use the following command:

```
Node10# atmf remote-login node20
Node20>
```

To close the session on Node20 and return to Node10's command line, use the following command:

```
Node20# exit
Node10#
```

In this example, user User1 is a valid user of node5. They can remotely login from node5 to node3 by using the following commands:

```
node5# atmf remote-login user User1 node3
node3> enable
```

**Related  
Commands** [atmf restricted-login](#)

**Command  
changes** Version 5.4.6-2.1: changes to AMF user account requirements

# atmf restricted-login

**Overview** By default, users who are logged into any node on an AMF network are able to manage any other node by using either working-sets or an AMF remote login. If the access provided by this feature is too wide, or contravenes network security restrictions, it can be limited by running this command, which changes the access so that:

- users who are logged into non-master nodes cannot execute any commands that involve working-sets, and
- from non-master nodes, users can use remote-login, but only to login to a user account that is valid on the remote device (via a statically configured account or RADIUS/TACACS+). Users are also required to enter the password for that user account.

Once entered on any AMF master node, this command will propagate across the network.

Use the **no** variant of this command to disable restricted login on the AMF network. This allows access to the **atmf working-set** command from any node in the AMF network.

**Syntax** `atmf restricted-login`  
`no atmf restricted-login`

**Mode** Privileged Exec

**Default** Master nodes operate with **atmf restricted-login** disabled.  
Member nodes operate with **atmf restricted-login** enabled.

**NOTE:** *The default conditions of this command vary from those applied by its “no” variant. This is because the restricted-login action is only applied by **master** nodes, and in the absence of a master node, the default is to apply the restricted action to all **member** nodes with AMF configured.*

**Usage** In the presence of a **master** node, its default of **atmf restricted-login disabled** will propagate to all its member nodes. Similarly, any change in this command’s status that is made on a master node, will also propagate to all its member nodes

Note that once you have run this command, certain other commands that utilize the AMF working-set command, such as the **include**, **atmf reboot-rolling** and **show atmf group members** commands, will operate only on master nodes.

Restricted-login must be enabled on AMF areas with more than 120 nodes.

**Example** To enable restricted login, use the command

```
Node_20(config)# atmf restricted-login node20
```

**Related Commands** [atmf remote-login](#)  
[show atmf](#)

**Command changes** Version 5.4.6-2.1: changes to AMF user account requirements

# atmf secure-mode

**Overview** Use this command to enable AMF secure mode on an AMF node. AMF secure mode makes an AMF network more secure by:

- Adding an authorization mechanism before and AMF member is allowed to join an AMF network.
- The encryption of all AMF packets sent between AMF nodes.
- Adding support for user login authentication by RADIUS or TACACS+, and removing the requirement to have the same privileged user account in the local user database on all devices in the AMF network.
- Adding additional logging which enables network administrators to monitor attempts to gain unauthorized access to the AMF network.

Once the secure mode command is run on all nodes on an AMF network, the AMF masters and AMF controllers manage the addition of AMF nodes and AMF areas to the AMF network.

Use the **no** variant of this command to disable AMF secure mode on an AMF node.

**Syntax** `atmf secure-mode`  
`no atmf secure-mode`

**Default** Secure mode is disabled by default.

**Mode** Global Configuration

**Usage** When an AMF network is running in AMF secure mode the [atmf restricted-login](#) feature is automatically enabled. This restricts the [atmf working-set](#) command to users that are logged on to an AMF master. This feature cannot be disabled independently of secure mode.

When AMF secure mode is enabled the AMF controllers and masters in the AMF network form a group of certificate authorities. A node may only join a secure AMF network once it has been authorized by a master or controller. When enabled, all devices in the AMF network must be running in secure mode. Unsecured devices will not be able to join a secure AMF network.

**Example** To enable AMF secure mode on an AMF node, use the commands:

```
awplus# configure terminal
awplus(config)# atmf secure-mode
```

To disable AMF secure mode on an AMF node, use the commands:

```
awplus# configure terminal
awplus(config)# no atmf secure-mode
```

**Related Commands** [atmf authorize](#)  
[atmf secure-mode certificate expiry](#)

clear atmf secure-mode certificates  
clear atmf secure-mode statistics  
show atmf  
show atmf authorization  
show atmf secure-mode  
show atmf secure-mode certificates  
show atmf secure-mode sa  
show atmf secure-mode statistics

**Command changes** Version 5.4.7-0.3: command added

# atmf secure-mode certificate expire

**Overview** Use this command on an AMF master to expire a secure mode certificate. Running this command will force the removal of the AMF node from the network.

**Syntax** `atmf secure-mode certificate expire <node-name> [area <area-name>]`

| Parameter                      | Description                                                            |
|--------------------------------|------------------------------------------------------------------------|
| <code>&lt;node-name&gt;</code> | Name of the AMF node you want to expire the certificate for.           |
| <code>area</code>              | Specify an AMF area.                                                   |
| <code>&lt;area-name&gt;</code> | Name of the AMF area you want to expire the AMF nodes certificate for. |

**Mode** Privileged Exec

**Example** To remove an AMF node named "node3" from an AMF network, use the following command on the AMF master:

```
awplus# atmf secure-mode certificate expire node3
```

To remove an AMF node named "node2" in an area named "area2", use the following command on the AMF master:

```
awplus# atmf secure-mode certificate expire node2 area area2
```

**Related Commands**

- [atmf secure-mode](#)
- [show atmf secure-mode](#)
- [show atmf secure-mode certificates](#)

**Command changes** Version 5.4.7-0.3: command added



# atmf secure-mode certificate expiry

**Overview** Use this command to set the expiry time of AMF secure mode certificates. Once an AMF node's certificate expires it must re-authorize and obtain a new certificate from the AMF master.

Use the **no** variant of this command to reset the expiry time to 180 days.

**Syntax** `atmf secure-mode certificate expiry {<days>|infinite}`  
`no atmf secure-mode certificate expiry`

| Parameter                 | Description                                                                                            |
|---------------------------|--------------------------------------------------------------------------------------------------------|
| <code>&lt;days&gt;</code> | Length of time, in days, that an AMF secure mode certificate remains valid. A value between 1 and 365. |
| <code>infinite</code>     | The authorization certificate does not expire, in other words AMF nodes stay authorized indefinitely.  |

**Default** The default expiry time is 180 days.

**Mode** Global Configuration

**Example** To set AMF secure mode certificate expiry to 7 days, use the commands:

```
awplus# configure terminal
awplus(config)# atmf secure-mode certificate expiry 7
```

To set AMF secure mode certificates to never expire, use the commands:

```
awplus# configure terminal
awplus(config)# atmf secure-mode certificate expiry infinite
```

To reset the certificate expiry to 180 days, use the commands:

```
awplus# configure terminal
awplus(config)# no atmf secure-mode certificate expiry
```

**Related Commands** [atmf secure-mode](#)  
[show atmf secure-mode](#)  
[show atmf secure-mode certificates](#)

**Command changes** Version 5.4.7-0.3: command added

# atmf secure-mode certificate renew

**Overview** Use this command to force all local certificates to expire and be renewed on an AMF secure mode network.

Secure mode certificates renew automatically but this command could be used to renew a certificate in a situation where the automatic renewal may happen while the device is not attached to the AMF network.

**Syntax** `atmf secure-mode certificate renew`

**Mode** Privileged Exec

**Example** To renew a local certificate on a AMF member or AMF master, use the command:

```
awplus# atmf secure-mode certificate renew
```

**Related Commands** [show atmf secure-mode certificates](#)  
[show atmf secure-mode statistics](#)

**Command changes** Version 5.4.7-0.3: command added

# atmf secure-mode enable-all

**Overview** Use this command to enable AMF secure mode on an entire network. AMF secure mode makes an AMF network more secure by:

- Adding an authorization mechanism before an AMF member is allowed to join an AMF network.
- The encryption of all AMF packets sent between AMF nodes.
- Adding support for user login authentication by RADIUS or TACACS+, and removing the requirement to have the same privileged user account in the local user database on all devices in the AMF network.
- Adding additional logging which enables network administrators to monitor attempts to gain unauthorized access to the AMF network.

Once this command is run on an AMF network, the AMF masters and AMF controllers manage the addition of AMF nodes and AMF areas to the AMF network.

This command can only be run on an AMF master.

Use the **no** variant of this command to disable AMF secure mode on an entire network.

**Syntax** `atmf secure-mode enable-all`  
`no atmf secure-mode enable-all`

**Default** Secure mode is disabled by default.

**Mode** Privileged Exec

**Usage** When an AMF network is running in AMF secure mode the [atmf restricted-login](#) feature is automatically enabled. This restricts the [atmf working-set](#) command to users that are logged on to an AMF master. This feature cannot be disabled independently of secure mode.

When AMF secure mode is enabled the AMF controllers and masters in the AMF network form a group of certificate authorities. A node may only join a secure AMF network once it has been authorized by a master or controller. When enabled, all devices in the AMF network must be running in secure mode. Unsecured devices will not be able to join a secure AMF network.

Running **atmf secure-mode enable-all**:

- Groups all AMF members in a working set.
- Executes [clear atmf secure-mode certificates](#) on the working set of members, which removes existing secure mode certificates from all the nodes.
- Groups all the AMF masters in a working set.
- Executes [atmf authorize provision all](#) on the working set of masters, so all masters provision all nodes.
- Groups all AMF nodes in a working set.

- Runs a script which executes `atmf secure-mode` and then writes the configuration file on each node.
- Starts a timer that ticks every 10 seconds, for a maximum of 10 times, and checks if all the secure mode capable nodes rejoin the AMF network.

Running **no atmf secure-mode enable-all**:

- Groups all AMF nodes in a working set.
- Runs a script which executes **no atmf secure-mode** and then writes the configuration file on each node.
- Starts a timer that ticks every 10 seconds, for a maximum of 10 times, and checks if all the secure mode capable nodes rejoin the AMF network.

**NOTE:** Enabling or disabling secure mode on the network saves the running-config on every device.

**Example** To enable AMF secure mode on the entire network, use the command:

```
awplus# atmf secure-mode enable-all
```

You will be prompted to confirm the action:

```
Total number of nodes 21
21 nodes support secure-mode

Enable secure-mode across the AMF network ? (y/n): y
```

To disable AMF secure mode on the entire network, use the command:

```
awplus# no atmf secure-mode enable-all
```

You will be prompted to confirm the action:

```
% Warning: All security certificates will be deleted.
Disable secure-mode across the AMF network ? (y/n): y
```

**Related Commands** [aaa authentication auth-web](#)  
[show atmf](#)

**Command changes** Version 5.4.7-0.3: command added

# atmf select-area

**Overview** Use this command to access devices in an area outside the core area on the controller network. This command will connect you to the remote area-master of the specified area.

This command is only valid on AMF controllers.

The **no** variant of this command disconnects you from the remote area-master.

**Syntax** `atmf select-area {<area-name>|local}`  
`no atmf select-area`

| Parameter                      | Description                                                   |
|--------------------------------|---------------------------------------------------------------|
| <code>&lt;area-name&gt;</code> | Connect to the remote area-master of the area with this name. |
| <code>local</code>             | Return to managing the local controller area.                 |

**Mode** Privileged Exec

**Usage** After running this command, use the [atmf working-set](#) command to select the set of nodes you want to access in the remote area.

**Example** To access nodes in the area Canterbury, use the command

```
controller-1# atmf select-area Canterbury
```

This displays the following output:

```
Test_network[3]#atmf select-area Canterbury
=====
Connected to area Canterbury via host Avensis:
=====
```

To return to the local area for controller-1, use the command

```
controller-1# atmf select-area local
```

Alternatively, to return to the local area for controller-1, use the command

```
controller-1# no atmf select-area
```

**Related Commands** [atmf working-set](#)

# atmf topology-gui enable

**Overview** Use this command to enable the operation of Vista Manager EX on the Master device.

Vista Manager EX delivers state-of-the-art monitoring and management for your Autonomous Management Framework™ (AMF) network, by automatically creating a complete topology map of switches, firewalls and wireless access points (APs). An expanded view includes third-party devices such as security cameras.

Use the **no** variant of this command to disable operation of Vista Manager EX.

**Syntax** atmf topology-gui enable  
no atmf topology-gui enable

**Default** Disabled by default on AMF Master and member nodes. Enabled by default on Controllers.

**Mode** Global Configuration mode

**Usage** To use Vista Manager EX, you must also enable the HTTP service on all AMF nodes, including all AMF masters and controllers. The HTTP service is enabled by default on AlliedWare Plus switches and disabled by default on AR-Series firewalls. To enable it, use the commands:

```
Node1# configure terminal
Node1(config)# service http
```

On one master in each AMF area in your network, you also need to configure the master to send event notifications to Vista Manager EX. To do this, use the commands:

```
Node1# configure terminal
Node1(config)# log event-host <ip-address> atmf-topology-event
```

**Example** To enable Vista Manager EX on Node1, use the following commands:

```
Node1# configure terminal
Node1(config)# atmf topology-gui enable
```

To disable Vista Manager EX on Node1, use the following commands:

```
Node1# configure terminal
Node1(config)# no atmf topology-gui enable
```

**Related  
Commands** [atmf enable](#)  
[log event-host](#)  
[service http](#)

# atmf virtual-crosslink

**Overview** Use this command to create a virtual crosslink. A virtual crosslink connects an AMF master or controller on a physical device to a Virtual AMF Appliance (VAA) master or controller.

All AMF master nodes must reside in the same AMF domain and are required to be directly connected using AMF crosslinks. In order to be able to meet this requirement for AMF masters running on VAAs, a virtual crosslink connects the AMF master or controller on the physical device to the master or controller on the VAA.

Use the **no** variant of this command to remove a virtual crosslink.

**Syntax**

```
atmf virtual-crosslink id <local-id> ip <local-ip> remote-id <remote-id> remote-ip <remote-ip>
no atmf virtual-crosslink id <local-id>
```

| Parameter   | Description                                               |
|-------------|-----------------------------------------------------------|
| <local-id>  | ID of the local tunnel port, a value between 1 and 4094.  |
| <local-ip>  | IPv4 address of the local tunnel port in a.b.c.d format.  |
| <remote-id> | ID of the remote tunnel port, a value between 1 and 4094. |
| <remote-ip> | IPv4 address of the remote tunnel port in a.b.c.d format. |

**Default** No AMF virtual crosslinks are created by default.

**Mode** Global Configuration

**Usage** This command allows a virtual tunnel to be created between two remote sites over a layer 3 link. The tunnel encapsulates AMF packets and allows them to be sent transparently across a Wide Area Network (WAN) such as the Internet.

Configuration involves creating a local tunnel ID, a local IP address, a remote tunnel ID and a remote IP address. Each side of the tunnel must be configured with the same, but mirrored parameters.

**NOTE:** *Virtual crosslinks are not supported on AMF container masters, therefore if multiple tenants on a single VAA host are configured for secure mode, only a single AMF master is supported per area.*

**Example** To setup a virtual link from a local site, "siteA", to a remote site, "siteB", (assuming there is already IP connectivity between the sites), run the following commands at the local site:

```
siteA# configure terminal
siteA(config)# atmf virtual-crosslink id 5 ip 192.168.100.1
remote-id 10 remote-ip 192.168.200.1
```

At the remote site, run the commands:

```
siteB# configure terminal
siteB(config)# atmf virtual-crosslink id 10 ip 192.168.200.1
remote-id 5 remote-ip 192.168.100.1
```

To remove this virtual crosslink, run the following commands on the local site:

```
siteA# configure terminal
siteA(config)# no atmf virtual-crosslink id 5
```

On the remote site, run the commands:

```
siteB# configure terminal
siteB(config)# no atmf virtual-crosslink id 10
```

**Related  
Commands**

[atmf virtual-crosslink](#)  
[show atmf links](#)  
[switchport atmf-crosslink](#)

**Command  
changes**

Version 5.4.7-0.3: command added



# atmf virtual-link

**Overview** This command creates one or more Layer 2 tunnels that enable AMF nodes to transparently communicate across a wide area network using Layer 2 connectivity protocols.

Once connected through the tunnel, the remote member will have the same AMF capabilities as a directly connected AMF member.

Use the **no** variant of this command to remove the specified virtual link.

**Syntax** `atmf virtual-link id <1-4094> ip <a.b.c.d> remote-id <1-4094>  
remote-ip <a.b.c.d> [remote-area <area-name>]  
no atmf virtual-link id <1-4094>`

| Parameter   | Description                                                                                                                                                                                                                                                       |
|-------------|-------------------------------------------------------------------------------------------------------------------------------------------------------------------------------------------------------------------------------------------------------------------|
| ip          | The Internet Protocol (IP).                                                                                                                                                                                                                                       |
| <a.b.c.d>   | The IP address, of the local amf node (at its interface to the tunnel) entered in a.b.c.d format.                                                                                                                                                                 |
| remote-id   | The ID of the (same) tunnel that will be applied by the remote node. Note that this must match the local-id that is defined on the remote node. This means that (for the same tunnel) the local and remote tunnel IDs are reversed on the local and remote nodes. |
| <1-4094>    | The ID range 1-4094.                                                                                                                                                                                                                                              |
| remote-ip   | The IP address of the remote node                                                                                                                                                                                                                                 |
| <a.b.c.d>   | The IP address, of the remote node (at its interface to the tunnel) entered in a.b.c.d format.                                                                                                                                                                    |
| remote-area | The remote area connected to this area virtual link                                                                                                                                                                                                               |
| <area-name> | The name of the remote area connected to this virtual link.                                                                                                                                                                                                       |

**Mode** Global Configuration

**Usage** The Layer 2 tunnel that this command creates enables a local AMF session to appear to pass transparently across a Wide Area Network (WAN) such as the Internet. The addresses configured as the local and remote tunnel IP addresses must have IP connectivity to each other. If the tunnel is configured to connect a head office and branch office over the Internet, typically this would involve using some type of managed WAN service such as a site-to-site VPN. Tunnels are only supported using IPv4.

Configuration involves creating a local tunnel ID, a local IP address, a remote tunnel ID and a remote IP address. A reciprocal configuration is also required on the corresponding remote device. The local tunnel ID must be unique to the device on which it is configured.

The tunneled link may operate via external (non AlliedWare Plus) routers in order to provide wide area network connectivity. However in this configuration, the routers perform a conventional router to router connection. The protocol tunneling function is accomplished by the AMF nodes.

**NOTE:** AMF cannot achieve zero touch replacement of the remote device that terminates the tunnel connection, because you must pre-configure the local IP address and tunnel ID on that remote device.

**Example 1** Use the following commands to create the tunnel shown in the figure below.

Figure 50-7: AMF virtual link example

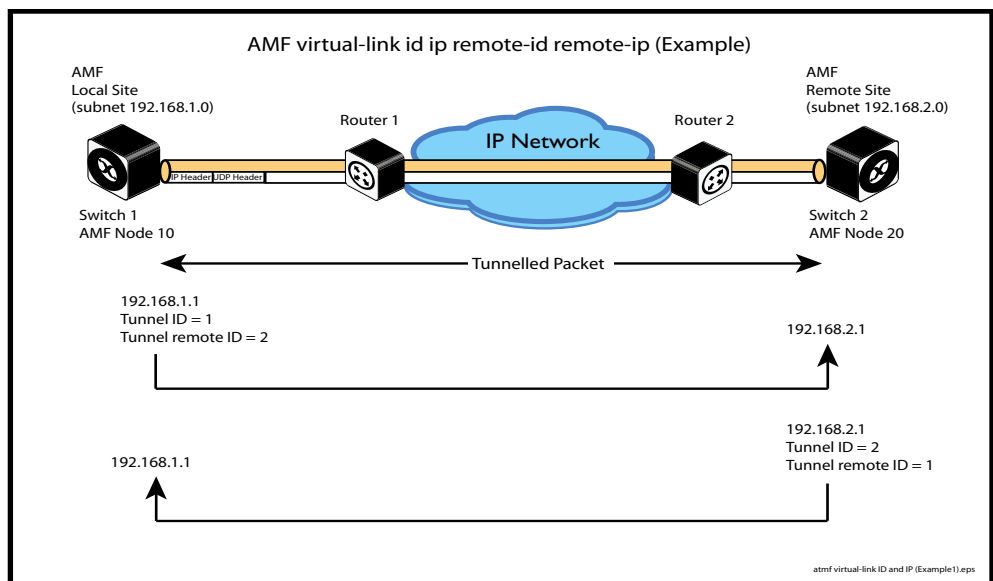

```
Node_10(config)# atmf virtual-link id 1 ip 192.168.1.1
remote-id 2 remote-ip 192.168.2.1

Node_20(config)# atmf virtual-link id 2 ip 192.168.2.1
remote-id 1 remote-ip 192.168.1.1
```

**Example 2** To set up an area virtual link to a remote site (assuming IP connectivity between the sites already), one site must run the following commands:

```
SiteA# configure terminal

SiteA(config)# atmf virtual-link id 5 ip 192.168.100.1
remote-id 10 remote-ip 192.168.200.1 remote-area SiteB-AREA
```

The second site must run the following commands:

```
SiteB# configure terminal

SiteB(config)# atmf virtual-link id 10 ip 192.168.200.1
remote-id 5 remote-ip 192.168.100.1 remote-area SiteA-AREA
```

Before you can apply the above **atmf virtual-link** command, you must configure the area names *SiteB-AREA* and *SiteA-AREA*.

**Validation Command** `show atmf`  
`show atmf links`

# atmf working-set

**Overview** Use this command to execute commands across an individually listed set of AMF nodes or across a named group of nodes.

Note that this command can only be run on a master node.

Use the **no** variant of this command to remove members or groups from the current working-set.

**Syntax** `atmf working-set { [<node-list> ] | [group <group-list> | all | local | current] }`  
`no atmf working-set { [<node-list> ] | [group <group-list> ] }`

| Parameter                       | Description                                                                                                                                                                                                                      |
|---------------------------------|----------------------------------------------------------------------------------------------------------------------------------------------------------------------------------------------------------------------------------|
| <code>&lt;node-list&gt;</code>  | A comma delimited list (without spaces) of nodes to be included in the working-set.                                                                                                                                              |
| <code>group</code>              | The AMF group.                                                                                                                                                                                                                   |
| <code>&lt;group-list&gt;</code> | A comma delimited list (without spaces) of groups to be included in the working-set. Note that this can include either defined groups, or any of the Automatic, or Implicit Groups shown earlier in the bulleted list of groups. |
| <code>all</code>                | All nodes in the AMF.                                                                                                                                                                                                            |
| <code>local</code>              | Local node<br>Running this command with the parameters <b>group local</b> will return you to the local prompt and local node connectivity.                                                                                       |
| <code>current</code>            | Nodes in current list.                                                                                                                                                                                                           |

**Mode** Privileged Exec

**Usage** You can put AMF nodes into groups by using the [atmf group \(membership\)](#) command.

This command opens a session on multiple network devices. When you change the working set to anything other than the local device, the prompt will change to the AMF network name, followed by the size of the working set, shown in square brackets. This command has to be run at privilege level 15.

In addition to the user defined groups, the following system assigned groups are automatically created:

- Implicit Groups
  - local: The originating node.
  - current: All nodes that comprise the current working-set.
  - all: All nodes in the AMF.

- Automatic Groups - These can be defined by hardware architecture, e.g. x510, x610, x8100, AR3050S or AR4050S, or by certain AMF nodal designations such as master.

Note that the Implicit Groups do not appear in `show atmf group` command output. If a node is an AMF master it will be automatically added to the master group.

**Example 1** To add all nodes in the AMF to the working-set, use the command:

```
node1# atmf working-set group all
```

**NOTE:** This command adds the implicit group "all" to the working set, where "all" comprises all nodes in the AMF.

This command displays an output screen similar to the one shown below:

```
=====
node1, node2, node3, node4, node5, node6:
=====

Working set join

ATMF_NETWORK_Name[6]#
```

**Example 2** To return to the local prompt, and connect to only the local node, use the command:

```
ATMF_Network_Name[6]# atmf working-set group local
node1#
```

The following table describes the meaning of the prompts in this example.

| Parameter         | Description                                                                        |
|-------------------|------------------------------------------------------------------------------------|
| ATMF_Network_Name | The name of the AMF network, as set by the <code>atmf network-name</code> command. |
| [6]               | The number of nodes in the working-set.                                            |
| node1             | The name of the local node, as set by the <code>hostname</code> command.           |

# bridge-group

**Overview** Use this command to connect an AMF container to a bridge created on a Virtual AMF Appliance (VAA) virtual machine. This allows the AMF container to connect to a physical network.

An AMF container is an isolated instance of AlliedWare Plus with its own network interfaces, configuration, and file system. The features available inside an AMF container are a sub-set of the features available on the host VAA. These features enable the AMF container to function as a uniquely identifiable AMF master and allows for multiple tenants (up to 60) to run on a single VAA host. See the [AMF Feature Overview and Configuration Guide](#) for more information on running multiple tenants on a single VAA host.

Use the **no** variant of this command to remove a bridge-group from an AMF container.

**Syntax** `bridge-group <bridge-id>`  
`no bridge-group`

| Parameter                      | Description                                                    |
|--------------------------------|----------------------------------------------------------------|
| <code>&lt;bridge-id&gt;</code> | The ID of the bridge group to join, a number between 1 and 64. |

**Mode** AMF Container Configuration

**Usage** Each container has two virtual interfaces:

- 1) Interface eth0, used to connect to the AMF controller on the VAA host via an AMF area-link, and configured using this [area-link](#) command.
- 2) Interface eth1, used to connect to the outside world using a bridged L2 network link, and configured using the **bridge-group** command.

Before using this command, a bridge must be created with the same bridge-id on the VAA host using the **bridge <bridge-id>** command.

See the [AMF Feature Overview and Configuration Guide](#) for more information on configuring the bridge.

**Example** To create a bridge group for AMF container "vac-wlg-1" and , use the commands:

```
awplus# configure terminal
awplus(config)# atmf container vac-wlg-1
awplus(config-atmf-container)# bridge-group 1
```

**Related Commands** [atmf container](#)  
[show atmf container](#)

**Command changes** Version 5.4.7-0.1: command added

# clear atmf links statistics

**Overview** This command resets the values of all AMF link, port, and global statistics to zero.

**Syntax** `clear atmf links statistics`

**Mode** Privilege Exec

**Example** To reset the AMF link statistics values, use the command:

```
node_1# clear atmf links statistics
```

**Related  
Commands** [show atmf links statistics](#)

# clear atmf secure-mode certificates

**Overview** Use this command to remove all certificates from an AMF member or master. AMF nodes will need to be re-authorized once this command has been run.

**Syntax** `clear atmf secure-mode certificates`

**Mode** Privileged Exec

**Example** To clear all certificates from an AMF node, use the command:

```
awplus# clear atmf secure-mode certificates
```

If this is the only master on the network you will see the following warning:

```
% Warning: This node is the only master in the network!
All the nodes will become isolated and refuse to join any ATMF
network. The certificates on all the isolated nodes must be
cleared before rejoining an ATMF network will be possible.

To clear certificates a reboot of the device is required.
Clear certificates and Reboot ? (y/n):
```

On an AMF member you will see the following message:

```
To clear certificates a reboot of the device is required.
Clear certificates and Reboot ? (y/n):
```

**Related Commands**

- [atmf authorize](#)
- [atmf secure-mode](#)
- [show atmf authorization](#)
- [show atmf secure-mode certificates](#)

**Command changes** Version 5.4.7-0.3: command added

# clear atmf secure-mode statistics

**Overview** Use this command to reset all secure mode statistics to 0.

**Syntax** `clear atmf secure-mode statistics`

**Mode** Privileged Exec

**Example** To reset the AMF secure mode statistics information, use the command:

```
awplus# clear atmf secure-mode statistic
```

**Related  
Commands** [show atmf secure-mode](#)  
[show atmf secure-mode statistics](#)

**Command  
changes** Version 5.4.7-0.3: command added



# debug atmf

**Overview** This command enables the AMF debugging facilities, and displays information that is relevant (only) to the current node. The detail of the debugging displayed depends on the parameters specified.

If no additional parameters are specified, then the command output will display all AMF debugging information, including link events, topology discovery messages and all notable AMF events.

The **no** variant of this command disables either all AMF debugging information, or only the particular information as selected by the command's parameters.

**Syntax**

```
debug atmf
[link|crosslink|arealink|database|neighbor|error|all]

no debug atmf
[link|crosslink|arealink|database|neighbor|error|all]
```

| Parameter | Description                                                                       |
|-----------|-----------------------------------------------------------------------------------|
| link      | Output displays debugging information relating to uplink or downlink information. |
| crosslink | Output displays all crosslink events.                                             |
| arealink  | Output displays all arealink events.                                              |
| database  | Output displays only notable database events.                                     |
| neighbor  | Output displays only notable AMF neighbor events.                                 |
| error     | Output displays AMF error events.                                                 |
| all       | Output displays all AMF events.                                                   |

**Default** All debugging facilities are disabled.

**Mode** User Exec and Global Configuration

**Usage** If no additional parameters are specified, then the command output will display all AMF debugging information, including link events, topology discovery messages and all notable AMF events.

**NOTE:** An alias to the **no** variant of this command is [undebg atmf](#) on page 2328.

**Examples** To enable all AMF debugging, use the command:

```
node_1# debug atmf
```

To enable AMF uplink and downlink debugging, use the command:

```
node_1# debug atmf link
```

To enable AMF error debugging, use the command:

```
node_1# debug atmf error
```

**Related  
Commands** [no debug all](#)

# debug atmf packet

**Overview** This command configures AMF Packet debugging parameters. The debug only displays information relevant to the current node. The command has following parameters:

**Syntax** debug atmf packet [direction {rx|tx|both}] [level {1|2|3}]  
[timeout <seconds>] [num-pkts <quantity>]  
[filter {node <name>|interface <ifname>}  
[pkt-type [1][2][3][4][5][6][7][8][9][10][11][12][13]]]

## Simplified Syntax

|                          |                                                            |
|--------------------------|------------------------------------------------------------|
| debug atmf packet        | [direction {rx tx both}]                                   |
|                          | [level {[1][2 3]}]                                         |
|                          | [timeout <seconds>]                                        |
|                          | [num-pkts <quantity>]                                      |
| debug atmf packet filter | [node <name>]                                              |
|                          | [interface <ifname>]                                       |
|                          | [pkt-type<br>[1][2][3][4][5][6][7][8][9][10][11][12][13]]] |

**NOTE:** You can combine the syntax components shown, but when doing so, you must retain their original order.

**Default** Level 1, both Tx and Rx, a timeout of 60 seconds with no filters applied.

**NOTE:** An alias to the **no** variant of this command - *undebug atmf* - can be found elsewhere in this chapter.

**Mode** User Exec and Global Configuration

**Usage** If no additional parameters are specified, then the command output will apply a default selection of parameters shown below:

| Parameter | Description                                                                                  |
|-----------|----------------------------------------------------------------------------------------------|
| direction | Sets debug to packet received, transmitted, or both                                          |
| rx        | packets received by this node                                                                |
| tx        | Packets sent from this node                                                                  |
| 1         | AMF Packet Control header Information, Packet Sequence Number. Enter 1 to select this level. |
| 2         | AMF Detailed Packet Information. Enter 2 to select this level.                               |
| 3         | AMF Packet HEX dump. Enter 3 to select this level.                                           |
| timeout   | Sets the execution timeout for packet logging                                                |

| Parameter  | Description                                                                                       |
|------------|---------------------------------------------------------------------------------------------------|
| <seconds>  | Seconds                                                                                           |
| num-pkts   | Sets the number of packets to be dumped                                                           |
| <quantity> | The actual number of packets                                                                      |
| filter     | Sets debug to filter packets                                                                      |
| node       | Sets the filter on packets for a particular Node                                                  |
| <name>     | The name of the remote node                                                                       |
| interface  | Sets the filter to dump packets from an interface (portx.x.x) on the local node                   |
| <ifname>   | Interface port or virtual-link                                                                    |
| pkt-type   | Sets the filter on packets with a particular AMF packet type                                      |
| 1          | Crosslink Hello BPDU packet with crosslink links information. Enter 1 to select this packet type. |
| 2          | Crosslink Hello BPDU packet with downlink domain information. Enter 2 to select this packet type. |
| 3          | Crosslink Hello BPDU packet with uplink information. Enter 3 to select this packet type.          |
| 4          | Downlink and uplink hello BPDU packets. Enter 4 to select this packet type.                       |
| 5          | Non broadcast hello unicast packets. Enter 5 to select this packet type.                          |
| 6          | Stack hello unicast packets. Enter 6 to select this packet type.                                  |
| 7          | Database description. Enter 7 to select this packet type.                                         |
| 8          | DBE request. Enter 8 to select this packet type.                                                  |
| 9          | DBE update. Enter 9 to select this packet type.                                                   |
| 10         | DBE bitmap update. Enter 10 to select this packet type.                                           |
| 11         | DBE acknowledgment. Enter 11 to select this packet type.                                          |
| 12         | Area Hello Packets. Enter 12 to select this packet type.                                          |
| 13         | Gateway Hello Packets. Enter 13 to select this packet type.                                       |

**Examples** To set a packet debug on node 1 with level 1 and no timeout, use the command:

```
node_1# debug atmf packet direction tx timeout 0
```

To set a packet debug with level 3 and filter packets received from AMF node 1:

```
node_1# debug atmf packet direction tx level 3 filter node_1
```

To enable send and receive 500 packets only on vlink1 for packet types 1, 7, and 11, use the command:

```
node_1# debug atmf packet num-pkts 500 filter interface vlink1
pkt-type 1 7 11
```

This example applies the **debug atmf packet** command and combines many of its options:

```
node_1# debug atmf packet direction rx level 1 num-pkts 60
filter node x930 interface port1.0.1 pkt-type 4 7 10
```

# discovery

**Overview** AMF nodes gather information about guest nodes by using one of two internally defined discovery methods: static or dynamic. This is one of several modal commands that are configured from within its specific guest-class (mode).

Dynamic discovery (the default method) involves learning IP address and MAC addresses of guest nodes from protocols outside of AMF such as LLDP or DHCP snooping. Dynamic learning is only supported when using IPv4. For IPv6 the static discovery method must be used.

The static method involves entering the guest class name and IP address using the `switchport atmf-guestlink` command to separately assign an individual switch port to each of the guest nodes. The MAC addresses of each of the guests of that class can then be learned from ARP or Neighbor discovery tables. If you are using the static discovery method, you must ensure that you have configured the appropriate class type for each of your statically discovered guest nodes.

The **no** variant of this command returns the discovery method to **dynamic**.

**Syntax** `discovery [static|dynamic]`  
`no discovery`

| Parameter            | Description                  |
|----------------------|------------------------------|
| <code>static</code>  | Statically assigned          |
| <code>dynamic</code> | Learned from DCHCPSN or LLDP |

**Default** Dynamic

**Mode** ATMF Guest Configuration Mode

**Usage** This command is one of several modal commands that are configured and applied for a specific guest-class (mode) and whose settings are automatically applied to a guest-node link by the `switchport atmf-guestlink` command.

**Example 1** To configure the discovery of the guest-class camera to operate statically, use the following commands:

```
Node1#conf t
Node1(config)#atmf guest-class camera
Node1(config-guest)#discovery static
Node1(config-guest)#end
```

**Example 2** To return the discovery method for the guest class TQ4600-1 to its default of **dynamic**, use the following commands:

```
Node1#conf t
Node1(config)#atmf guest-class TQ4600-1
Node1(config-guest)#no discovery
Node1(config-guest)#end
```

**Related  
Commands**

- atmf guest-class
- switchport atmf-guestlink
- show atmf links guest
- show atmf nodes

# description (amf container)

**Overview** Use this command to set the description on an AMF container on a Virtual AMF Appliance (VAA).

An AMF container is an isolated instance of AlliedWare Plus with its own network interfaces, configuration, and file system. The features available inside an AMF container are a sub-set of the features available on the host VAA. These features enable the AMF container to function as a uniquely identifiable AMF master and allows for multiple tenants (up to 60) to run on a single VAA host. See the [AMF Feature Overview and Configuration Guide](#) for more information on running multiple tenants on a single VAA host.

Use the **no** variant of this command to remove the description from an AMF container.

**Syntax** `description <description>`  
`no description`

| Parameter                        | Description                                                      |
|----------------------------------|------------------------------------------------------------------|
| <code>&lt;description&gt;</code> | Enter up to 128 characters of text describing the AMF container. |

**Mode** AMF Container Configuration

**Example** To set the description for AMF container “vac-wlg-1” to “Wellington area”, use the commands:

```
awplus# configure terminal
awplus(config)# atmf container vac-wlg-1
awplus(config-atmf-container)# description Wellington area
```

To remove the description for AMF container “vac-wlg-1”, use the commands:

```
awplus# configure terminal
awplus(config)# atmf container vac-wlg-1
awplus(config-atmf-container)# no description
```

**Related Commands** [atmf container](#)  
[show atmf container](#)

**Command changes** Version 5.4.7-0.1: command added



# erase factory-default

**Overview** This command erases all data from NVS and all data from Flash **excluding** the following:

- the current release file
- the backup release file
- license files

The device is then rebooted and returned to its factory default condition. The device can then be used for AMF automatic node recovery.

**Syntax** `erase factory-default`

**Mode** Privileged Exec.

**Usage** This command is an alias to the [atmf cleanup](#) command.

**Example** To erase data, use the command:

```
Node_1# erase factory-default
```

```
This command will erase all NVS, all flash contents except for
the boot release, and any license files, and then reboot the
switch. Continue? (y/n):y
```

**Related  
Commands** [atmf cleanup](#)

# http-enable

**Overview** This command is used to enable GUI access to a guest node. When http-enable is configured the port number is set to its default of 80. If the guest node is using a different port for HTTP, you can configure this using the port <PORTNO> attribute.

This command is used to inform the GUI that this device has an HTTP interface at the specified port number so that a suitable URL can be provided to the user.

Use the **no** variant of this command to disable HTTP.

**Syntax** http-enable [port <port-number>]  
no http-enable

| Parameter     | Description                       |
|---------------|-----------------------------------|
| port          | TCP port number.                  |
| <port-number> | The port number to be configured. |

**Default** http-enable is off.  
If http-enable is selected without a port parameter the port number will default to 80.

**Mode** ATMF Guest Configuration Mode

**Example 1** To enable HTTP access to a guest node on port 80 (the default), use the following commands:

```
node1# conf t
node1(config)#atmf guest-class Camera
node1(config-atmf-guest)#http-enable
node1(config-atmf-guest)#
```

**Example 2** To enable HTTP access to a guest node on port 400, use the following commands:

```
node1# conf t
node1(config)#atmf guest-class Camera
node1(config-atmf-guest)#http-enable port 400
node1(config-atmf-guest)#
```

**Example 3** To disable HTTP access to a guest node, use the following commands:

```
node1# conf t
node1(config)#atmf guest-class Camera
node1(config-atmf-guest)#no http-enable
node1(config-atmf-guest)#
```

**Related  
Commands**    `atmf guest-class`  
                  `switchport atmf-guestlink`  
                  `show atmf links guest`  
                  `show atmf nodes`

# log event-host

**Overview** Use this command to set up an external host to log AMF topology events through Vista Manager. This command is run on the Master device.

Use the **no** variant of this command to disable log events through Vista Manager.

**Syntax** `log event-host [<ipv4-addr>|<ipv6-addr>] atmf-topology-event`  
`no log event-host [<ipv4-addr>|<ipv6-addr>] atmf-topology-event`

| Parameter                      | Description                    |
|--------------------------------|--------------------------------|
| <code>&lt;ipv4-addr&gt;</code> | ipv4 address of the event host |
| <code>&lt;ipv6-addr&gt;</code> | ipv6 address of the event host |

**Default** Log events are disabled by default.

**Mode** Global Configuration

**Usage** Event hosts are set so syslog sends the messages out as they come.

**NOTE:** *There is a difference between log event and log host messages:*

- Log event messages are sent out as they come by syslog
- Log host messages are set to wait for a number of messages (20) to send them out together for traffic optimization.

**Example** To enable Node 1 to log event messages from host IP address 192.0.2.31, use the following commands:

```
Node1# configure terminal
Node1(config)# log event-host 192.0.2.31 atmf-topology-event
```

To disable Node 1 to log event messages from host IP address 192.0.2.31, use the following commands:

```
Node1# configure terminal
Node1(config)# no log event-host 192.0.2.31 atmf-topology-event
```

**Related Commands** [atmf topology-gui enable](#)

# modeltype

**Overview** This command sets the expected model type of the guest node. Guest nodes can be one of various types: alliedware, aw+, tq or other. The model type will default to **other** if nothing is set.

Use the **no** variant of this command to reset the model type to **other**.

**Syntax** `modeltype [alliedware|aw+|tq|other]`

| Parameter  | Description                                                 |
|------------|-------------------------------------------------------------|
| alliedware | A legacy Allied Telesis operating system.                   |
| aw+        | The Allied Telesis AlliedWare Plus operating system.        |
| tq         | An Allied Telesis TQ Series wireless access point.          |
| other      | Used where the model type is outside the above definitions. |

**Default** Will default to **other**

**Mode** ATMF Guest Configuration Mode

**Example 1** To assign the model type **tq** to the guest-class called **tq\_device**, use the following commands:

```
node1# conf t
node1(config)# atmf guest-class tq_device
node1(config-atmf-guest)# modeltype tq
node1(config-atmf-guest)# end
```

**Example 2** To remove the model type **tq** from the guest-class called **tq\_device**, and reset it to the default of **other**, use the following commands:

```
node1# conf t
node1(config)# atmf guest-class tq_device
node1(config-atmf-guest)# no modeltype
node1(config-atmf-guest)# end
```

**Related Commands**

- [atmf guest-class](#)
- [switchport atmf-guestlink](#)
- [show atmf links guest](#)

# show atmf

**Overview** Displays information about the current AMF node.

**Syntax** `show atmf [summary|tech|nodes|session]`

| Parameter | Description                                               |
|-----------|-----------------------------------------------------------|
| summary   | Displays summary information about the current AMF node.  |
| tech      | Displays global AMF information.                          |
| nodes     | Displays a list of AMF nodes together with brief details. |
| session   | Displays information on an AMF session.                   |

**Default** Only summary information is displayed.

**Mode** User Exec and Privileged Exec

**Usage** AMF uses internal VLANs to communicate between nodes about the state of the AMF network. Two VLANs have been selected specifically for this purpose. Once these have been assigned, they are reserved for AMF and cannot be used for other purposes

For information on filtering and saving command output, see the [“Getting Started with AlliedWare Plus” Feature Overview and Configuration Guide](#).

**Example 1** To show summary information on AMF node\_1 use the following command:

```
node_1# show atmf summary
```

**Table 1:** Output from the **show atmf summary** command

```
node_1#show atmf summary
ATMF Summary Information:

ATMF Status : Enabled
Network Name : Test_network
Node Name : node_1
Role : Master
Restricted login : Disabled
Current ATMF Nodes : 3
```

**Example 2** To show information specific to AMF nodes use the following command:

```
node_1# show atmf nodes
```

**Example 3** The **show amf session** command displays all CLI (Command Line Interface) sessions for users that are currently logged in and running a CLI session.

To display AMF active sessions, use the following command:

```
node_1# show atmf session
```

For example, in the output below, node\_1 and node\_5 have active users logged in.

**Table 2:** Output from the **show atmf session** command

```
node_1#show atmf session

CLI Session Neighbors

Session ID : 73518
Node Name : node_1
PID : 7982
Link type : Broadcast-cli
MAC Address : 0000.0000.0000
Options : 0
Our bits : 0
Link State : Full
Domain Controller : 0
Backup Domain Controller : 0
Database Description Sequence Number : 00000000
First Adjacency : 1
Number Events : 0
DBE Retransmit Queue Length : 0
DBE Request List Length : 0
Session ID : 410804
Node Name : node_5
PID : 17588
Link type : Broadcast-cli
MAC Address : 001a.eb56.9020
Options : 0
Our bits : 0
Link State : Full
Domain Controller : 0
Backup Domain Controller : 0
Database Description Sequence Number : 00000000
First Adjacency : 1
Number Events : 0
DBE Retransmit Queue Length : 0
DBE Request List Length : 0
```

**Example 4** The AMF tech command collects all the AMF commands, and displays them. You can use this command when you want to see an overview of the AMF network.

To display AMF technical information, use the following command:

```
node_1# show atmf tech
```

**Table 3:** Output from the **show atmf tech** command

```
node_1#show atmf tech
ATMF Summary Information:

ATMF Status : Enabled
Network Name : ATMF_NET
Node Name : node_1
Role : Master
Current ATMF Nodes : 8

ATMF Technical information:

Network Name : ATMF_NET
Domain : node_1's domain
Node Depth : 0
Domain Flags : 0
Authentication Type : 0
MAC Address : 0014.2299.137d
Board ID : 287
Domain State : DomainController
Domain Controller : node_1
Backup Domain Controller : node2
Domain controller MAC : 0014.2299.137d
Parent Domain : -
Parent Domain Controller : -
Parent Domain Controller MAC : 0000.0000.0000
Number of Domain Events : 0
Crosslink Ports Blocking : 0
Uplink Ports Waiting on Sync : 0
Crosslink Sequence Number : 7
Domains Sequence Number : 28
Uplink Sequence Number : 2
Number of Crosslink Ports : 1
Number of Domain Nodes : 2
Number of Neighbors : 5
Number of Non Broadcast Neighbors : 3
Number of Link State Entries : 1
Number of Up Uplinks : 0
Number of Up Uplinks on This Node : 0
DBE Checksum : 84fc6
Number of DBE Entries : 0
Management Domain Ifindex : 4391
Management Domain VLAN : 4091
Management ifindex : 4392
Management VLAN : 4092
```

**Table 4:** Parameter definitions from the **show atmf tech** command

| Parameter    | Definition                                         |
|--------------|----------------------------------------------------|
| ATMF Status  | The Node's AMF status, either Enabled or Disabled. |
| Network Name | The AMF network that a particular node belongs to. |



**Table 4:** Parameter definitions from the **show atmf tech** command (cont.)

| Parameter          | Definition                                                                                                                                                                                                                                                                                                                                                                                                                                                       |
|--------------------|------------------------------------------------------------------------------------------------------------------------------------------------------------------------------------------------------------------------------------------------------------------------------------------------------------------------------------------------------------------------------------------------------------------------------------------------------------------|
| Node Name          | The name assigned to a particular node.                                                                                                                                                                                                                                                                                                                                                                                                                          |
| Role               | The role configured for this AMF device, either Master or Member.                                                                                                                                                                                                                                                                                                                                                                                                |
| Current ATMF Nodes | The count of AMF nodes in an AMF Network.                                                                                                                                                                                                                                                                                                                                                                                                                        |
| Node Address       | An address used to access a remotely located node (.atmf).                                                                                                                                                                                                                                                                                                                                                                                                       |
| Node ID            | A unique identifier assigned to a Node on an AMF network.                                                                                                                                                                                                                                                                                                                                                                                                        |
| Node Depth         | The number of nodes in path from this node to level of the AMF root node. It can be thought of as the vertical depth of the AMF network from a particular node to the zero level of the AMF root node.                                                                                                                                                                                                                                                           |
| Domain State       | The state of Node in a Domain in AMF network as Controller/Backup.                                                                                                                                                                                                                                                                                                                                                                                               |
| Recovery State     | The AMF node recovery status. Indicates whether a node recovery is in progress on this device - Auto, Manual, or None.                                                                                                                                                                                                                                                                                                                                           |
| Management VLAN    | The VLAN created for traffic between Nodes of different domain (up/down links). <ul style="list-style-type: none"> <li>• VLAN ID - In this example VLAN 4092 is configured as the Management VLAN.</li> <li>• Management Subnet - Network prefix for the subnet.</li> <li>• Management IP Address - The IP address allocated for this traffic.</li> <li>• Management Mask - The subnet mask used to create a subnet for this traffic (255.255.128.0).</li> </ul> |
| Domain VLAN        | The VLAN assigned for traffic between Nodes of same domain (crosslink). <ul style="list-style-type: none"> <li>• VLAN ID - In this example VLAN 4091 is configured as the domain VLAN.</li> <li>• Domain Subnet. The subnet address used for this traffic.</li> <li>• Domain IP Address. The IP address allocated for this traffic.</li> <li>• Domain Mask. The subnet mask used to create a subnet for this traffic (255.255.128.0).</li> </ul>                 |
| Device Type        | The Product Series name.                                                                                                                                                                                                                                                                                                                                                                                                                                         |
| ATMF Master        | Whether the node is an AMF master node for its area ('Y' if it is and 'N' if it is not).                                                                                                                                                                                                                                                                                                                                                                         |
| SC                 | The device configuration, one of C - Chassis (SBx8100 Series), S - Stackable (VCS) or N - Standalone.                                                                                                                                                                                                                                                                                                                                                            |
| Parent             | The node to which the current node has an active uplink.                                                                                                                                                                                                                                                                                                                                                                                                         |
| Node Depth         | The number of nodes in the path from this node to the master node.                                                                                                                                                                                                                                                                                                                                                                                               |

**Related Commands** [show atmf detail](#)

# show atmf area

**Overview** Use this command to display information about an AMF area. On AMF controllers, this command displays all areas that the controller is aware of. On remote AMF masters, this command displays the controller area and the remote local area. On gateways, this command displays the controller area and remote master area.

**Syntax** `show atmf area [detail] [<area-name>]`

| Parameter   | Description                                                                     |
|-------------|---------------------------------------------------------------------------------|
| detail      | Displays detailed information                                                   |
| <area-name> | Displays information about master and gateway nodes in the specified area only. |

**Mode** Privileged Exec

**Example 1** To show information about all areas, use the command:

```
controller-1# show atmf area
```

The following figure shows example output from running this command on a controller.

**Table 5:** Example output from the **show atmf area** command on a Controller.

```
controller-1#show atmf area

ATMF Area Information:

* = Local area

Area Area Local Remote Remote Node
Name ID Gateway Gateway Master Count

* NZ 1 Reachable N/A N/A 3
Wellington 2 Reachable Reachable Auth OK 120
Canterbury 3 Reachable Reachable Auth Error -
SiteA-AREA 14 Unreachable Unreachable Unreachable -
Auckland 100 Reachable Reachable Auth Start -
Southland 120 Reachable Reachable Auth OK 54

Area count: 6 Area node count: 177
```

The following figure shows example output from running this command on a remote master.

**Table 6:** Example output from the **show atmf area** command on a remote master.

```

Canterbury#show atmf area

 ATMF Area Information:

 * = Local area

 Area Area Local Remote Remote Node
 Name ID Gateway Gateway Master Count

 NZ 1 Reachable N/A N/A -
 * Canterbury 3 Reachable N/A N/A 40

 Area count: 2 Local area node count: 40

```

**Table 7:** Parameter definitions from the **show atmf area** command

| Parameter       | Definition                                                                                                                                                                                                                                                                                                                                                                                                                                                                                                                                                                                                                                                                                                                                                                                                                                                                                                                                                                                                                                                                                                        |
|-----------------|-------------------------------------------------------------------------------------------------------------------------------------------------------------------------------------------------------------------------------------------------------------------------------------------------------------------------------------------------------------------------------------------------------------------------------------------------------------------------------------------------------------------------------------------------------------------------------------------------------------------------------------------------------------------------------------------------------------------------------------------------------------------------------------------------------------------------------------------------------------------------------------------------------------------------------------------------------------------------------------------------------------------------------------------------------------------------------------------------------------------|
| *               | Indicates the area of the device on which the command is being run.                                                                                                                                                                                                                                                                                                                                                                                                                                                                                                                                                                                                                                                                                                                                                                                                                                                                                                                                                                                                                                               |
| Area Name       | The name of each area.                                                                                                                                                                                                                                                                                                                                                                                                                                                                                                                                                                                                                                                                                                                                                                                                                                                                                                                                                                                                                                                                                            |
| Area ID         | The ID of the area.                                                                                                                                                                                                                                                                                                                                                                                                                                                                                                                                                                                                                                                                                                                                                                                                                                                                                                                                                                                                                                                                                               |
| Local Gateway   | Whether the local gateway node is reachable or not.                                                                                                                                                                                                                                                                                                                                                                                                                                                                                                                                                                                                                                                                                                                                                                                                                                                                                                                                                                                                                                                               |
| Remote Gateway  | Whether the remote gateway node is reachable or not. This is one of the following: <ul style="list-style-type: none"> <li>Reachable, if the link has been established.</li> <li>Unreachable, if a link to the remote area has not been established. This could mean that a port or vlan is down, or that inconsistent VLANs have been configured using the <a href="#">switchport atmf-arealink remote-area</a> command.</li> <li>N/A for the area of the controller or remote master on which the command is being run, because the gateway node on that device is local.</li> <li>Auth Start, which may indicate that the area names match on the controller and remote master, but the IDs do not match.</li> <li>Auth Error, which indicates that the areas tried to authenticate but there is a problem. For example, the passwords configured on the controller and remote master may not match, or a password may be missing on the remote master.?</li> <li>Auth OK, which indicates that area authentication was successful and you can now use the <a href="#">atmf select-area</a> command.</li> </ul> |
| Remote Master   | Whether the remote master node is reachable or not. This is N/A for the area of the controller or remote master on which the command is being run, because the master node on that device is local.                                                                                                                                                                                                                                                                                                                                                                                                                                                                                                                                                                                                                                                                                                                                                                                                                                                                                                               |
| Node Count      | The number of nodes in the area.                                                                                                                                                                                                                                                                                                                                                                                                                                                                                                                                                                                                                                                                                                                                                                                                                                                                                                                                                                                                                                                                                  |
| Area Count      | The number of areas controlled by the controller.                                                                                                                                                                                                                                                                                                                                                                                                                                                                                                                                                                                                                                                                                                                                                                                                                                                                                                                                                                                                                                                                 |
| Area Node Count | The total number of nodes in the area.                                                                                                                                                                                                                                                                                                                                                                                                                                                                                                                                                                                                                                                                                                                                                                                                                                                                                                                                                                                                                                                                            |

**Example 2** To show detailed information about the areas, use the command:

```
controller-1# show atmf area detail
```

The following figure shows example output from running this command.

**Table 8:** Output from the **show atmf area detail** command

```
controller-1#show atmf area detail

ATMF Area Detail Information:

Controller distance : 0

Controller Id : 21
Backup Available : FALSE

Area Id : 2
Gateway Node Name : controller-1
Gateway Node Id : 342
Gateway Ifindex : 6013
Masters Count : 1
Master Node Name : well-master (329)
Node Count : 2

Area Id : 3
Gateway Node Name : controller-1
Gateway Node Id : 342
Gateway Ifindex : 4511
Masters Count : 2
Master Node Name : cant1-master (15)
Master Node Name : cant2-master (454)
Node Count : 2
```

**Related Commands**

- [show atmf area summary](#)
- [show atmf area nodes](#)
- [show atmf area nodes-detail](#)

# show atmf area guests

**Overview** This command will display details of all guests that the controller is aware of.

**Syntax** `show atmf area guests [<area-name> [<node-name>]]`

| Parameter   | Description                                       |
|-------------|---------------------------------------------------|
| <area-name> | The area name for guest information               |
| <node-name> | The name of the node that connects to the guests. |

**Default** N/A

**Mode** User Exec/Privileged Exec

**Example 1** To display atmf area guest nodes on a controller, use the command,

```
GuestNode[1]#show atmf area guests
```

**Output** Figure 50-8: Example output from the **show atmf area guests** command

```
main-building Area Guest Node Information:
Device MAC IP/IPv6
Type Address Parent Port Address

- 0008.5d10.7635 x230 1.0.3 192.168.5.4
AT-TQ4600 eccd.6df2.da60 wireless-node1 1.0.4 192.168.5.3
- 0800.239e.f1fe x230 1.0.4 192.168.4.8
AT-TQ4600 001a.eb3b.dc80 wireless-node2 1.0.7 192.168.4.12

main-building guest node count 4

GuestNode[1]#
```

**Table 9:** Parameters in the output from **show atmf area guests** command

| Parameter   | Description                                                         |
|-------------|---------------------------------------------------------------------|
| Device Type | The device type as read from the guest node.                        |
| MAC Address | The MAC address of the guest-node                                   |
| Parent      | The device that directly connects to the guest-node                 |
| Port        | The port number on the parent node that connects to the guest node. |
| IP/IPv6     | The IP or IPv6 address of the guest node.                           |

**Related  
Commands** [show atmf area](#)  
[show atmf area nodes](#)  
[show atmf backup guest](#)  
[show atmf area guests-detail](#)

# show atmf area guests-detail

**Overview** This command displays the local and remote guest information from an AMF controller.

**Syntax** `show atmf area guests-detail [<area-name> [<node-name>]]`

| Parameter   | Description                                                                                                  |
|-------------|--------------------------------------------------------------------------------------------------------------|
| <area-name> | The name assigned to the AMF area. An area is an AMF network that is under the control of an AMF Controller. |
| <node-name> | The name assigned to the network node.                                                                       |

**Default** N/A.

**Mode** Privileged Exec

**Example** To display detailed information for all guest nodes attached to “node1”, which is located within the area named “northern”, use the following command:

```
AMF_controller#show atmf area guests-detail northern node1
```

**Output** Figure 50-9: Example output from the **show atmf guest detail** command.

```
#show atmf guest detail

Node Name : Node1
Port Name : port1.0.5
Ifindex : 5005
Guest Description : tq4600
Device Type : AT-TQ4600
Configuration Mismatch : No
Backup Supported : Yes
MAC Address : eccd.6df2.da60
IP Address : 192.168.4.50
IPv6 Address : Not Set
HTTP Port : 80
Firmware Version :
Node Name : poe
Port Name : port1.0.6
Ifindex : 5006
Guest Description : tq3600
Device Type : AT-TQ2450
Configuration Mismatch : No
Backup Supported : Yes
MAC Address : 001a.eb3b.cb80
IP Address : 192.168.4.9
IPv6 Address : Not Set
HTTP Port : 80
Firmware Version :
```

**Table 10:** Parameters shown in the output of the **show atmf guest detail** command

| Parameter         | Description                                                                                                                                                                            |
|-------------------|----------------------------------------------------------------------------------------------------------------------------------------------------------------------------------------|
| Node Name         | The name of the guest's parent node.                                                                                                                                                   |
| Port Name         | The port on the parent node that connects to the guest.                                                                                                                                |
| IFindex           | An internal index number that maps to the port number on the parent node.                                                                                                              |
| Guest Description | A brief description of the guest node as manually entered into the <code>description (interface)</code> command for the guest node port on the parent node.                            |
| Device Type       | The device type as supplied by the guest node itself.                                                                                                                                  |
| Backup Supported  | Indicates whether AMF supports backup of this guest node.                                                                                                                              |
| MAC Address       | The MAC address of the guest node.                                                                                                                                                     |
| IP Address        | The IP address of the guest node.                                                                                                                                                      |
| IPv6 Address      | The IPv6 address of the guest node.                                                                                                                                                    |
| HTTP Port         | The HTTP port enables you to specify a port when enabling http to allow a URL for the http user interface of a Guest Node. This is determined by the <code>http-enable</code> command. |
| Firmware Version  | The firmware version that the guest node is currently running.                                                                                                                         |

**Related Commands** [show atmf area nodes-detail](#)  
[show atmf area guests](#)



# show atmf area nodes

**Overview** Use this command to display summarized information about an AMF controller's remote nodes.

Note that this command can only be run from a controller node.

**Syntax** `show atmf area nodes [<area-name> [<node-name>]]`

| Parameter   | Description                                             |
|-------------|---------------------------------------------------------|
| <area-name> | Displays information about nodes in the specified area. |
| <node-name> | Displays information about the specified node.          |

**Mode** Privileged Exec

**Usage** If you do not limit the output to a single area or node, this command lists all remote nodes that the controller is aware of. This can be a very large number of nodes.

**Example** To show summarized information about all the nodes the controller is aware of, use the command:

```
controller-1# show atmf area nodes
```

The following figure shows partial example output from running this command.

**Table 11:** Output from the **show atmf area nodes** command

```
controller-1#show atmf area nodes

Wellington Area Node Information:

Node Device ATMF Node
Name Type Master SC Parent Depth

well-gate x230-18GP N N well-master 1
well-master AT-x930-28GPX Y N none 0

Wellington node count 2

...
```

**Table 12:** Parameter definitions from the **show atmf area nodes** command

| Parameter   | Definition                              |
|-------------|-----------------------------------------|
| Node Name   | The name assigned to a particular node. |
| Device Type | The Product series name.                |

**Table 12:** Parameter definitions from the **show atmf area nodes** command (cont.)

| Parameter   | Definition                                                                                            |
|-------------|-------------------------------------------------------------------------------------------------------|
| ATMF Master | Whether the node is an AMF master node for its area ('Y' if it is and 'N' if it is not).              |
| SC          | The device configuration, one of C - Chassis (SBx8100 series), S - Stackable (VCS) or N - Standalone. |
| Parent      | The node to which the current node has an active uplink.                                              |
| Node Depth  | The number of nodes in the path from this node to the master node.                                    |

**Related Commands** [show atmf area](#)  
[show atmf area nodes-detail](#)

# show atmf area nodes-detail

**Overview** Use this command to display detailed information about an AMF controller's remote nodes.

Note that this command can only be run from a controller node.

**Syntax** `show atmf area nodes-detail [<area-name> [<node-name>]]`

| Parameter                      | Description                                                      |
|--------------------------------|------------------------------------------------------------------|
| <code>&lt;area-name&gt;</code> | Displays detailed information about nodes in the specified area. |
| <code>&lt;node-name&gt;</code> | Displays detailed information about the specified node.          |

**Mode** Privileged Exec

**Usage** If you do not limit the output to a single area or node, this command displays information about all remote nodes that the controller is aware of. This can be a very large number of nodes.

**Example** To show information about all the nodes the controller is aware of, use the command:

```
controller-1# show atmf area nodes-detail
```

The following figure shows partial example output from running this command.

**Table 13:** Output from the **show atmf area nodes-detail** command

```
controller-1#show atmf area nodes-detail

Wellington Area Node Information:
Node name well-gate
Parent node name : well-master
Domain id : well-gate's domain
Board type : 368
Distance to core : 1
Flags : 50
Extra flags : 0x00000006
MAC Address : 001a.eb56.9020

Node name well-master
Parent node name : none
Domain id : well-master's domain
Board type : 333
Distance to core : 0
Flags : 51
Extra flags : 0x0000000c
MAC Address : eccd.6d3f.fef7

...
```

**Table 14:** Parameter definitions from the **show atmf area nodes-detail** command

| Parameter        | Definition                                                                            |
|------------------|---------------------------------------------------------------------------------------|
| Node name        | The name assigned to a particular node.                                               |
| Parent node name | The node to which the current node has an active uplink.                              |
| Domain id        |                                                                                       |
| Board type       | The Allied Telesis code number for the device.                                        |
| Distance to core | The number of nodes in the path from the current node to the master node in its area. |
| Flags            | Internal AMF information                                                              |
| Extra flags      | Internal AMF information                                                              |
| MAC Address      | The MAC address of the current node                                                   |

**Related Commands** [show atmf area](#)  
[show atmf area nodes](#)

# show atmf area summary

**Overview** Use this command to display a summary of IPv6 addresses used by AMF, for one or all of the areas controlled by an AMF controller.

**Syntax** `show atmf area summary [<area-name>]`

| Parameter                      | Description                                       |
|--------------------------------|---------------------------------------------------|
| <code>&lt;area-name&gt;</code> | Displays information for the specified area only. |

**Mode** Privileged Exec

**Example 1** To show a summary of IPv6 addresses used by AMF, for all of the areas controlled by controller-1, use the command:

```
controller-1# show atmf area summary
```

The following figure shows example output from running this command.

**Table 15:** Output from the **show atmf area summary** command

```
controller-1#show atmf area summary

ATMF Area Summary Information:

Management Information
Local IPv6 Address : fd00:4154:4d46:1::15

Area Information
Area Name : NZ (Local)
Area ID : 1
Area Master IPv6 Address : -

Area Name : Wellington
Area ID : 2
Area Master IPv6 Address : fd00:4154:4d46:2::149

Area Name : Canterbury
Area ID : 3
Area Master IPv6 Address : fd00:4154:4d46:3::f

Area Name : Auckland
Area ID : 100
Area Master IPv6 Address : fd00:4154:4d46:64::17
Interface : vlink2000
```

**Related Commands**

- [show atmf area](#)
- [show atmf area nodes](#)
- [show atmf area nodes-detail](#)

# show atmf authorization

**Overview** Use this command on an AMF master to display the authorization status of other AMF members and masters on the network.

On an AMF controller this command will show the authorization status of remote area AMF masters.

**Syntax** `show atmf authorization {current|pending|provisional}`

| Parameter   | Description                                                                                                                                                                                                 |
|-------------|-------------------------------------------------------------------------------------------------------------------------------------------------------------------------------------------------------------|
| current     | Show the status of all authorized nodes.                                                                                                                                                                    |
| pending     | Show the status of unauthorized nodes in the pending queue. These are nodes that enabled secure mode with <code>atmf secure-mode</code> but have not yet been authorized with <code>atmf authorize</code> . |
| provisional | Show the status of provisionally authorized nodes. These are nodes that have been provisioned with <code>atmf authorize provision</code> .                                                                  |

**Mode** Privileged Exec

**Example** To display all authorized AMF nodes on an AMF controller or AMF master, use the command:

```
awplus# show atmf authorization current
```

To display AMF nodes which are requesting authorization on an AMF controller or AMF master, use the command:

```
awplus# show atmf authorization pending
```

To display AMF nodes which have provisional authorization, use the command:

```
awplus# show atmf authorization provisional
```

**Output** Figure 50-10: Example output from **show atmf authorization current**

| NZ Authorized Nodes: |          |            |
|----------------------|----------|------------|
| Node Name            | Signer   | Expires    |
| -----                | -----    | -----      |
| master_1             | master_1 | 4 Mar 2017 |
| area_1_node_1        | master_1 | 4 Mar 2017 |
| area_1_node_2        | master_1 | 4 Mar 2017 |

Table 50-1: Parameters in the output from **show atmf authorization current**

| Parameter | Description                                                                                                                 |
|-----------|-----------------------------------------------------------------------------------------------------------------------------|
| Node Name | AMF node name of the authorized node.                                                                                       |
| Signer    | Name of the AMF master that authorized the node.                                                                            |
| Expires   | Expiry date of the authorization. Authorization expiry time is set using <code>atmf secure-mode certificate expiry</code> . |

**Output** Figure 50-11: Example output from **show atmf authorization pending**

```

Pending Authorizations:

NZ Requests:
Node Name Product Parent Node Interface

area_1_node_3 x230-18GP master_1 port1.2.9
area_1_node_4 x510-52GTX master_1 sa1

```

Table 50-2: Parameters in the output from **show atmf authorization pending**

| Parameter   | Description                                          |
|-------------|------------------------------------------------------|
| Node Name   | Name of the node that is requesting authorization.   |
| Product     | Product name.                                        |
| Parent Node | Authorization authority of the requesting node.      |
| Interface   | Interface that the authorization request came in on. |

**Output** Figure 50-12: Example output from **show atmf authorization provisional**

```

ATMF Provisional Authorization:

Area - Node Name Start Timeout
or MAC Address Interface Time Minutes

3333.4444.5555 5 Sep 2016 02:35:54 3
1111.2222.3333 5 Sep 2016 02:35:24 60
NZ - blue port1.0.3 5 Sep 2016 02:35:06 60

```

Table 50-3: Parameters in the output from **show atmf authorization provisional**

| Parameter                          | Description                                                                  |
|------------------------------------|------------------------------------------------------------------------------|
| Area - Node Name<br>or MAC Address | MAC address or node name of the node that has been provisionally authorized. |
| Interface                          | Interface that the node has been provisioned on.                             |
| Start Time                         | Time the node was provisioned.                                               |
| Timeout Minutes                    | Length of time from Start Time until the provisional authorization expires.  |

**Related  
Commands**

[atmf authorize](#)  
[atmf authorize provision](#)  
[atmf secure-mode](#)  
[clear atmf secure-mode certificates](#)  
[show atmf](#)  
[show atmf secure-mode](#)  
[show atmf secure-mode certificates](#)

**Command  
changes**

Version 5.4.7-0.3: command added



# show atmf backup

**Overview** This command displays information about AMF backup status for all the nodes in an AMF network. It can only be run on AMF master and controller nodes.

**Syntax** `show atmf backup [logs|server-status|synchronize [logs]]`

| Parameter     | Description                                                                           |
|---------------|---------------------------------------------------------------------------------------|
| logs          | Displays detailed log information.                                                    |
| server-status | Displays connectivity diagnostics information for each configured remote file server. |
| synchronize   | Display the file server synchronization status                                        |
| logs          | For each remote file server, display the logs for the last synchronization            |

**Mode** Privileged Exec

**Example 1** To display the AMF backup information, use the command:

```
node_1# show atmf backup
```

To display log messages to do with backups, use the command:

```
node_1# show atmf backup logs
```

Table 50-4: Output from **show atmf backup**

```
Node_1# show atmf backup
ScheduledBackupEnabled
 Schedule.....1 per day starting at 03:00
 Next Backup Time...01 Oct 2016 03:00
Backup BandwidthUnlimited
Backup Media.....SD (Total 1974.0 MB, Free197.6MB)
Current Action.....Starting manual backup
Started.....30 Sep 2016 10:08
CurrentNode.....atmf_testbox1
Backup Redundancy ...Enabled
 Local mediaSD (Total 3788.0MB, Free 3679.5MB)
 StateActive
```

| Node Name     | Date        | Time     | In ATMF | On Media | Status      |
|---------------|-------------|----------|---------|----------|-------------|
| atmf_testbox1 | 30 Sep 2016 | 09:58:59 | Yes     | Yes      | In Progress |
| atmf_testbox2 | 30 Sep 2016 | 10:01:23 | Yes     | Yes      | Good        |

Table 50-5: Output from **show atmf backup logs**

```
Node_1#show atmf backup logs

Backup Redundancy Enabled
Local media SD (Total 3788.0MB, Free 1792.8MB)
State Inactive (Remote file server is not available)

Log File Location: card:/atmf/ATMF/logs/rsync_<node name>.log

Node
Name Log Details

atmf_testbox
2016/09/30 18:16:51 [9045] receiving file list
2016/09/30 18:16:51 [9047] .d..t.... flash/
2016/09/30 18:16:52 [9047] >f+++++++ flash/a.rel
```

**Example 2** To display the AMF backup synchronization status, use the command:

```
node_1# show atmf backup synchronize
```

To display log messages to do with synchronization of backups, use the command:

```
node_1# show atmf backup synchronize logs
```

Table 50-6: Output from **show atmf backup synchronize**

```
Node_1#show atmf backup synchronize

ATMF backup synchronization:

* = Active file server

 Id Date Time Status

 1 30 Sep 2016 22:25:57 Synchronized
* 2 - - Active
```

Table 50-7: Output from **show atmf backup synchronize logs**

```
Node_1#show atmf backup synchronize logs

Id Log Details

1 2016/09/30 22:25:54 [8039] receiving file list
 2016/09/30 22:25:54 [8039] >f..t.... backup_Box1.info
 2016/09/30 22:25:54 [8039] sent 46 bytes received 39 bytes total size 40
```

**Example 3** To display the AMF backup information with the optional parameter **server-status**, use the command:

```
Node_1# show atmf backup server-status
```

```
Node1#sh atmf backup server-status

Id Last Check State

1 186 s File server ready
2 1 s SSH no route to host
```

**Table 51:** Parameter definitions from the **show atmf backup** command

| Parameter         | Definition                                                                                                                                                                                                                                  |
|-------------------|---------------------------------------------------------------------------------------------------------------------------------------------------------------------------------------------------------------------------------------------|
| Scheduled Backup  | Indicates whether AMF backup scheduling is enabled or disabled.                                                                                                                                                                             |
| Schedule          | Displays the configured backup schedule.                                                                                                                                                                                                    |
| Next Backup Time  | Displays the date and time of the next scheduled.                                                                                                                                                                                           |
| Backup Media      | The current backup medium in use. This will be SD or NONE. SD card only (and not USB) is supported for AMF backup. Utilized and available memory (MB) will be indicated if backup media memory is present.                                  |
| Current Action    | The task that the AMF backup mechanism is currently performing. This will be a combination of either (Idle, Starting, Doing, Stopping), or (manual, scheduled).                                                                             |
| Started           | The date and time that the currently executing task was initiated in the format DD MMM YYYY HH:MM                                                                                                                                           |
| Current Node      | The name of the node that is currently being backed up.                                                                                                                                                                                     |
| Backup Redundancy | Whether backup redundancy is enabled or disabled.                                                                                                                                                                                           |
| Local media       | The local media to be used for backup redundancy; SD or USB or NONE, and total and free memory available on the media.                                                                                                                      |
| State             | Whether SD or USB media is installed and available for backup redundancy. May be Active (if backup redundancy is functional—requires both the local redundant backup media and a remote server to be configured and available) or Inactive. |
| Node Name         | The name of the node that is storing backup data - on its backup media.                                                                                                                                                                     |
| Date              | The data of the last backup in the format DD MMM YYYY.                                                                                                                                                                                      |
| Time              | The time of the last backup in the format HH:MM:SS.                                                                                                                                                                                         |
| In ATMF           | Whether the node shown is active in the AMF network, (Yes or No).                                                                                                                                                                           |
| On Media          | Whether the node shown has a backup on the backup media (Yes or No).                                                                                                                                                                        |

**Table 51:** Parameter definitions from the **show atmf backup** command (cont.)

| Parameter         | Definition                                                                                                                                                                                                                                                                                                                                                                                                                                                                                                                         |
|-------------------|------------------------------------------------------------------------------------------------------------------------------------------------------------------------------------------------------------------------------------------------------------------------------------------------------------------------------------------------------------------------------------------------------------------------------------------------------------------------------------------------------------------------------------|
| Status            | The output can contain one of four values: <ul style="list-style-type: none"><li>• “-” meaning that the status file cannot be found or cannot be read.</li><li>• “Errors” meaning that there are issues - note that the backup may still be deemed successful depending on the errors.</li><li>• “Stopped” meaning that the backup attempt was manually aborted.</li><li>• “Good” meaning that the backup was completed successfully.</li><li>• “In Progress” meaning that the backup is currently running on that node.</li></ul> |
| Log File Location | All backup attempts will generate a result log file in the identified directory based on the node name. In the above example this would be:<br>card:/amf/office/logs/rsync_amf_testbox1.log.                                                                                                                                                                                                                                                                                                                                       |
| Log Details       | The contents of the backup log file.                                                                                                                                                                                                                                                                                                                                                                                                                                                                                               |
| server-status     | Displays connectivity diagnostics information for each configured remove file server.                                                                                                                                                                                                                                                                                                                                                                                                                                              |

For information on filtering and saving command output, see the [“Getting Started with AlliedWare Plus” Feature Overview and Configuration Guide](#).

**Related Commands** [show atmf](#)  
[atmf network-name](#)

# show atmf backup area

**Overview** Use this command to display backup status information for the master nodes in one or more areas.

Note that this command is only available on AMF controllers.

**Syntax** `show atmf backup area [<area-name> [<node-name>]] [logs]`

| Parameter   | Description                                             |
|-------------|---------------------------------------------------------|
| logs        | Displays the logs for the last backup of each node.     |
| <area-name> | Displays information about nodes in the specified area. |
| <node-name> | Displays information about the specified node.          |

**Mode** Privileged Exec

**Example** To show information about backups for an area, use the command:

```
controller-1# show atmf backup area
```

**Table 52:** Output from the **show atmf backup area** command

```

controller-1#show atmf backup area

Scheduled Backup Enabled
 Schedule 12 per day starting at 14:30
 Next Backup Time 15 Oct 2016 04:30
Backup Bandwidth Unlimited
Backup Media FILE SERVER 1 (Total 128886.5MB, Free 26234.2MB)
Server Config
 * 1 Configured (Mounted, Active)
 Host 10.37.74.1
 Username root
 Path /tftpboot/backups_from_controller-1
 Port -
 2 Configured (Unmounted)
 Host 10.37.142.1
 Username root
 Path -
 Port -
Current Action Idle
Started -
Current Node -

Backup Redundancy Enabled
 Local media USB (Total 7604.0MB, Free 7544.0MB)
 State Active

Area Name Node Name Id Date Time Status

Wellington camry 1 14 Oct 2016 02:30:22 Good
Canterbury corona 1 14 Oct 2016 02:30:23 Good
Canterbury Avensis 1 14 Oct 2016 02:30:22 Good
Auckland RAV4 1 14 Oct 2016 02:30:23 Good
Southland MR2 1 14 Oct 2016 02:30:24 Good

```

- Related Commands**
- [atmf backup area-masters enable](#)
  - [show atmf area](#)
  - [show atmf area nodes-detail](#)
  - [switchport atmf-arealink remote-area](#)

# show atmf backup guest

**Overview** This command displays backup status information of guest nodes in an AMF network. This command can only be run on a device configured as an AMF Master and has an AMF guest license.

**Syntax** show atmf backup guest [*<node-name>*] [*<guest-port>*] [logs]

| Parameter                 | Description                        |
|---------------------------|------------------------------------|
| <i>&lt;node-name&gt;</i>  | The name of parent guest node      |
| <i>&lt;guest-port&gt;</i> | The port number on the parent node |

**Mode** User Exec/Privileged Exec

**Example** On the switch named x930-master, to display information about the AMF backup guest status, use the command:

```
x930-master# show atmf backup guest
```

**Output** Figure 50-13: Example output from **show atmf backup guest**

```
x930-master#sh atmf backup guest
Guest Backup Enabled
Scheduled Backup Disabled
 Schedule 1 per day starting at 03:00
 Next Backup Time ... 20 Jan 2016 03:00
Backup Bandwidth Unlimited
Backup Media FILE SERVER 2 (Total 655027.5MB,
 Free 140191.5MB)
Server Config
 1 Configured (Mounted)
 Host 11.0.24.1
 Username bob
 Path guest-project
 Port -
* 2 Configured (Mounted, Active)
 Host 11.0.24.1
 Username bob
 Path guest-project-second
 Port.....-
Current ActionIdle
Started -
Current Node -
Backup Redundancy ...Enabled
Local media USB (Total 7376.0MB, Free 7264.1MB)
State Active
```

| Parent Node Name | Port Name | Id  | Date        | Time     | Status |
|------------------|-----------|-----|-------------|----------|--------|
| x230             | port1.0.4 | 2   | 19 Jan 2016 | 22:21:46 | Good   |
|                  |           | 1   | 19 Jan 2016 | 22:21:46 | Good   |
|                  |           | USB | 19 Jan 2016 | 22:21:46 | Good   |

Table 50-1: Parameters in the output from **show atmf backup guest**

| Parameter        | Description                                                                                                                                                                |
|------------------|----------------------------------------------------------------------------------------------------------------------------------------------------------------------------|
| Guest Backup     | The status of the guest node backup process                                                                                                                                |
| Scheduled Backup | The timing configured for guest backups.                                                                                                                                   |
| Schedule         | Displays the configured backup schedule.                                                                                                                                   |
| Next Backup Time | The time the next backup process will be initiated.                                                                                                                        |
| Backup Bandwidth | The bandwidth limit applied to the backup data flow measured in kilo Bytes /second. Note that unlimited means there is no limit set specifically for the backup data flow. |
| Backup Media     | Detail of the memory media used to store the backup files and the current memory capacity available.                                                                       |

- Related Commands**
- show atmf backup area
  - show atmf backup
  - show atmf links guest
  - show atmf nodes
  - show atmf backup guest
  - atmf backup guests delete
  - atmf backup guests enable



# show atmf container

**Overview** Use this command to display information about the AMF containers created on a Virtual AMF Appliance (VAA).

An AMF container is an isolated instance of AlliedWare Plus with its own network interfaces, configuration, and file system. The features available inside an AMF container are a sub-set of the features available on the host VAA. These features enable the AMF container to function as a uniquely identifiable AMF master and allows for multiple tenants (up to 60) to run on a single VAA host. See the [AMF Feature Overview and Configuration Guide](#) for more information on running multiple tenants on a single VAA host.

**Syntax** `show atmf container [detail] [<container-name>]`

| Parameter        | Description                                                        |
|------------------|--------------------------------------------------------------------|
| detail           | Show detailed information.                                         |
| <container-name> | The name of the AMF container you wish to display information for. |

**Mode** Privileged Exec

**Output** Figure 50-14: Example output from **show atmf container**

```
awplus#show atmf container
ATMF Container Information:
 Container Area Bridge State Memory CPU%

 vac-wlg-1 wlg br1 running 70.3 MB 1.2
 vac-akl-1 ak1 br2 stopped 0 bytes 0.0
 vac-nsn-1 nsn br3 running 53.2 MB 0.7
Current ATMF Container count: 3
```

Figure 50-15: Example output from **show atmf container vac-wlg-1**

```
awplus#show atmf container vac-wlg-1
ATMF Container Information:
 Container Area Bridge State Memory CPU%

 vac-wlg-1 wlg br1 running 70.3 MB 1.2
Current ATMF Container count: 1
```

Table 50-2: Parameters in the output from **show atmf container**

| Parameter | Description                                                                                                      |
|-----------|------------------------------------------------------------------------------------------------------------------|
| Container | Name of the AMF container.                                                                                       |
| Area      | Name of the area the container is in.                                                                            |
| Bridge    | Name of the bridge connecting the container to the physical network.                                             |
| State     | Container state, <code>running</code> or <code>stopped</code> . This is set with the <code>state</code> command. |
| Memory    | The amount of memory the container is using on the VAA host.                                                     |
| CPU%      | The percentage of CPU time the container is using on the VAA, at the time the show command is run.               |

Figure 50-16: Example output from **show atmf container detail vac-wlg-1**

```
awplus#show atmf container detail vac-wlg-1

ATMF Container Information:

Name: vac-wlg-1
State: RUNNING
PID: 980
IP: 172.31.0.1
IP: 192.168.0.2
IP: fd00:4154:4d46:3c::1
CPU use: 3.95 seconds
Memory use: 67.07 MiB
Memory use: 0 bytes
Link: vethP31UFA
TX bytes: 166.01 KiB
RX bytes: 141.44 KiB
Total bytes: 307.45 KiB
Link: vethYCT7BB
TX bytes: 674.27 KiB
RX bytes: 698.27 KiB
Total bytes: 1.34 MiB
```

Table 50-3: Parameters in the output from **show atmf container detail**

| Parameter | Description                                                                                                      |
|-----------|------------------------------------------------------------------------------------------------------------------|
| Name      | Name of the AMF container.                                                                                       |
| State     | Container state, <code>RUNNING</code> or <code>STOPPED</code> . This is set with the <code>state</code> command. |

Table 50-3: Parameters in the output from **show atmf container detail** (cont.)

| Parameter   | Description                                                                                                                                                                                                                                                                                                                                                                                                                                                            |
|-------------|------------------------------------------------------------------------------------------------------------------------------------------------------------------------------------------------------------------------------------------------------------------------------------------------------------------------------------------------------------------------------------------------------------------------------------------------------------------------|
| PID         | Internal container id.                                                                                                                                                                                                                                                                                                                                                                                                                                                 |
| IP          | This lists the IP addresses used by the container. These include the eth1 IP address and the AMF management IP address.                                                                                                                                                                                                                                                                                                                                                |
| CPU use     | The CPU usage of the container since it was enabled.                                                                                                                                                                                                                                                                                                                                                                                                                   |
| Memory use  | Container memory usage.                                                                                                                                                                                                                                                                                                                                                                                                                                                |
| Link        | Each container has two links:<br><ol style="list-style-type: none"><li>1 An AMF area-link, this connects the container to the AMF controller and uses virtual interface eth0 on the AMF container.</li><li>2 A bridged L2 network link, this connects the container to the outside world and uses the virtual interface eth1 on the AMF container.</li></ol> See the <a href="#">AMF Feature Overview and Configuration_Guide</a> for more information on these links. |
| TX/RX bytes | Bytes sent and received on a link.                                                                                                                                                                                                                                                                                                                                                                                                                                     |
| Total bytes | Total bytes transferred on a link.                                                                                                                                                                                                                                                                                                                                                                                                                                     |

**Related  
Commands**

[area-link](#)  
[atmf area](#)  
[atmf area password](#)  
[atmf container](#)  
[atmf container login](#)  
[bridge-group](#)  
[description \(amf container\)](#)  
[state](#)

**Command  
changes**

Version 5.4.7-0.1: command added

# show atmf detail

**Overview** This command displays details about an AMF node. It can only be run on AMF master and controller nodes.

**Syntax** show atmf detail

| Parameter | Description                       |
|-----------|-----------------------------------|
| detail    | Displays output in greater depth. |

**Mode** Privileged Exec

**Example 1** To display the AMF node1 information in detail, use the command:

```
controller-1# show atmf detail
```

A typical output screen from this command is shown below:

```
atmf-1#show atmf detail
ATMF Detail Information:

Network Name : Test_network
Network Mtu : 1300
Node Name : controller-1
Node Address : controller-1.atmf
Node ID : 342
Node Depth : 0
Domain State : BackupDomainController
Recovery State : None
Log Verbose Setting : Verbose

Management VLAN
VLAN ID : 4000
Management Subnet : 172.31.0.0
Management IP Address : 172.31.1.86
Management Mask : 255.255.128.0
Management IPv6 Address : fd00:4154:4d46:1::156
Management IPv6 Prefix Length : 64

Domain VLAN
VLAN ID : 4091
Domain Subnet : 172.31.128.0
Domain IP Address : 172.31.129.86
Domain Mask : 255.255.128.0
```

**Table 51:** Parameter definitions from the **show atmf detail** command

| Parameter       | Definition                                                                                                                                                                                                                                                                                                                                                                                                                                                       |
|-----------------|------------------------------------------------------------------------------------------------------------------------------------------------------------------------------------------------------------------------------------------------------------------------------------------------------------------------------------------------------------------------------------------------------------------------------------------------------------------|
| Network MTU     | The network MTU for the ATMF network.                                                                                                                                                                                                                                                                                                                                                                                                                            |
| Network Name    | The AMF network that a particular node belongs to.                                                                                                                                                                                                                                                                                                                                                                                                               |
| Node Name       | The name assigned to a particular node.                                                                                                                                                                                                                                                                                                                                                                                                                          |
| Node Address    | An Address used to access a remotely located node. This is simply the Node Name plus the dotted suffix atmf (.atmf).                                                                                                                                                                                                                                                                                                                                             |
| Node ID         | A Unique identifier assigned to a Node on an AMF network.                                                                                                                                                                                                                                                                                                                                                                                                        |
| Node Depth      | The number of nodes in path from this node to level of the AMF root node. It can be thought of as the vertical depth of the AMF network from a particular node to the zero level of the AMF root node.                                                                                                                                                                                                                                                           |
| Domain State    | The state of Node in a Domain in AMF network as Controller/Backup.                                                                                                                                                                                                                                                                                                                                                                                               |
| Recovery State  | The AMF node recovery status. Indicates whether a node recovery is in progress on this device - Auto, Manual, or None.                                                                                                                                                                                                                                                                                                                                           |
| Management VLAN | The VLAN created for traffic between Nodes of different domain (up/down links). <ul style="list-style-type: none"> <li>• VLAN ID - In this example VLAN 4092 is configured as the Management VLAN.</li> <li>• Management Subnet - Network prefix for the subnet.</li> <li>• Management IP Address - The IP address allocated for this traffic.</li> <li>• Management Mask - The subnet mask used to create a subnet for this traffic (255.255.128.0).</li> </ul> |
| Domain VLAN     | The VLAN assigned for traffic between Nodes of same domain (crosslink). <ul style="list-style-type: none"> <li>• VLAN ID - In this example VLAN 4091 is configured as the domain VLAN.</li> <li>• Domain Subnet. The subnet address used for this traffic.</li> <li>• Domain IP Address. The IP address allocated for this traffic.</li> <li>• Domain Mask. The subnet mask used to create a subnet for this traffic (255.255.128.0).</li> </ul>                 |
| Node Depth      | The number of nodes in the path from this node to the Core domain.                                                                                                                                                                                                                                                                                                                                                                                               |

# show atmf group

**Overview** This command can be used to display the group membership within to a particular AMF node. It can also be used with the working-set command to display group membership within a working set.

Each node in the AMF is automatically added to the group that is appropriate to its hardware architecture, e.g. x510, x230. Nodes that are configured as masters are automatically assigned to the master group.

You can create arbitrary groups of AMF members based on your own selection criteria. You can then assign commands collectively to any of these groups.

**Syntax** `show atmf group [user-defined|automatic]`

| Parameter                 | Description                             |
|---------------------------|-----------------------------------------|
| <code>user-defined</code> | User-defined-group information display. |
| <code>automatic</code>    | Automatic group information display.    |

**Default** All groups are displayed

**Mode** Privileged Exec

**Example 1** To display group membership of node2, use the following command:

```
node2# show atmf group
```

A typical output screen from this command is shown below:

```
ATMF group information

master, x510

node2#
```

This screen shows that node2 contains the groups **master** and **x510**. Note that although the node also contains the implicit groups, these do not appear in the show output.

**Example 2** The following commands (entered on *node2*) will display all the automatic groups within the working set containing *node1* and all nodes that have been pre-defined to contain the *sysadmin* group:

First define the working-set:

```
node1# #atmf working-set node1 group sysadmin
```

A typical output screen from this command is shown below:

```

ATMF group information

master, poe, x8100

=====
node1, node2, node3, node4, node5, node6:
=====

ATMF group information

sysadmin, x8100

AMF_NETWORK[6]#

```

This confirms that the six nodes (*node1* to *node6*) are now members of the working-set and that these nodes reside within the *AMF-NETWORK*.

Note that to run this command, you must have previously entered the command [atmf working-set](#) on page 2211. This can be seen from the network level prompt, which in this case is *AMF\_NETWORK[6]#*.

**Table 52:** Sample output from the **show atmf group** command for a working set.

```

AMF_NETWORK[6]#show atmf group
=====
node3, node4, node5, node6:
=====

ATMF group information

edge_switches, x510

```

**Table 53:** Parameter definitions from the **show atmf group** command for a working set

| Parameter              | Definition                                                                                                                                                                                                                                                                                                                                                                                                        |
|------------------------|-------------------------------------------------------------------------------------------------------------------------------------------------------------------------------------------------------------------------------------------------------------------------------------------------------------------------------------------------------------------------------------------------------------------|
| ATMF group information | Displays a list of nodes and the groups that they belong to, for example: <ul style="list-style-type: none"> <li>• master - Shows a common group name for Nodes configured as AMF masters.</li> <li>• Hardware Arch - Shows a group for all Nodes sharing a common Hardware architecture, e.g. x8100, x230, for example.</li> <li>• User-defined - Arbitrary groups created by the user for AMF nodes.</li> </ul> |

# show atmf group members

**Overview** This command will display all group memberships within an AMF working-set. Each node in the AMF working set is automatically added to automatic groups which are defined by hardware architecture, e.g. x510, x230. Nodes that are configured as masters are automatically assigned to the master group. Users can define arbitrary groupings of AMF members based on their own criteria, which can be used to select groups of nodes.

**Syntax** `show atmf group members [user-defined|automatic]`

| Parameter    | Description                            |
|--------------|----------------------------------------|
| user-defined | User defined group membership display. |
| automatic    | Automatic group membership display.    |

**Mode** Privileged Exec

**Example** To display group membership of all nodes in a working-set, use the command:

```
ATMF_NETWORK[9]# show atmf group members
```

**Table 54:** Sample output from the **show atmf group members** command

```
ATMF Group membership
Automatic Total
Groups Members Members

master 1 Building_1
poe 1 HW_Team1
x510 3 SW_Team1 SW_Team2 SW_Team3
x930 1 HW_Team1
x8100 2 Building_1 Building_2

ATMF Group membership
User-defined Total
Groups Members Members

marketing 1 Bld1_Floor_1
software 3 SW_Team1 SW_Team2 SW_Team3
```



**Table 55:** Parameter definitions from the **show atmf group members** command

| Parameter           | Definition                                                                                                                                                       |
|---------------------|------------------------------------------------------------------------------------------------------------------------------------------------------------------|
| Automatic Groups    | Lists the Automatic Groups and their nodal composition. The sample output shows AMF nodes based on the same Hardware type or belonging to the same Master group. |
| User-defined Groups | Shows the grouping of AMF nodes in user defined groups.                                                                                                          |
| Total Members       | Shows the total number of members in each group.                                                                                                                 |
| Members             | Shows the list of AMF nodes in each group.                                                                                                                       |

**Related Commands**

- [show atmf group](#)
- [show atmf](#)
- [atmf group \(membership\)](#)

# show atmf guests

**Overview** This command is available on any AMF master or controller in the network. It displays a summary of the AMF guest nodes that exist in the AMF network, including device type, parent node, and IP address.

**Syntax** show atmf guests

**Mode** User Exec/Privileged Exec

**Usage** Use this command to display all guest nodes in a network. If you want to see only the guests attached to a single node, use the [show atmf links guest](#) command, which shows information about the guest nodes and also about their link to their parent node.

**Example** To display the AMF guest output, use the command:

```
awplus# show atmf guests
```

**Output** Figure 50-17: Example output from the **show atmf guests** command

```
master#show atmf guests

Guest Information:

Device Device Parent Guest IP/IPv6
Name Type Node Port Address

node1-2.0.1 x600-24Ts node1 2.0.1 192.168.2.10
wireless-zone1 AT-TQ4600 node2 1.0.1 192.168.1.10
wireless-zone2 AT-TQ4600 node2 1.0.2 192.168.1.12

Current ATMF guest node count 3
```

**Table 56:** Parameters shown in the output of the **show atmf guests** command

| Parameter   | Description                                                                                                                                                                                                                                        |
|-------------|----------------------------------------------------------------------------------------------------------------------------------------------------------------------------------------------------------------------------------------------------|
| Device Name | The name that is discovered from the device, or failing that, a name that is auto-assigned by AMF. The auto-assigned name consists of: <parent node name>-<attached port number> You can change this by configuring a description on the port.     |
| Device Type | The product name of the guest node, which is discovered from the device. If no device type can be discovered, this shows the name of the AMF guest-class that has been assigned to the guest node by the <a href="#">atmf guest-class</a> command. |

**Table 56:** Parameters shown in the output of the **show atmf guests** command

| Parameter       | Description                                                                                        |
|-----------------|----------------------------------------------------------------------------------------------------|
| Parent Node     | The name of the AMF node that directly connects to the guest node.                                 |
| Guest Port      | The port on the parent node that directly connects to the guest node.                              |
| IP/IPv6 Address | The address discovered from the node, or statically configured on the parent node's attached port. |

**Related  
Commands**

[atmf guest-class](#)  
[switchport atmf-guestlink](#)  
[show atmf backup guest](#)  
[show atmf links guest](#)

# show atmf guests detail

**Overview** This command is available on any AMF master in the network. It displays details about the AMF guest nodes that exist in the AMF network, such as device type, IP address, MAC address etc.

**Syntax** `show atmf guests detail [<node-name>] [<guest-port>]`

| Parameter                       | Description                          |
|---------------------------------|--------------------------------------|
| <code>&lt;node-name&gt;</code>  | The name of the guest node's parent. |
| <code>&lt;guest-port&gt;</code> | The port name on the parent node.    |

**Mode** User Exec/Privileged Exec

**Usage** If you want to see only the guests attached to a single node, you can use either:

- this command and specify the node name, or
- [show atmf links guest detail](#), which shows information about the guest nodes and also about their link to their parent node.

Note that the parameters that are displayed depend on the guest node's model.

**Example** To display the AMF guest output, use the command:

```
awplus# show atmf guests detail
```

**Output** Figure 50-18: Example output from **show atmf guests detail**

```
master#show atmf guests detail

ATMF Guest Node Information:

Node Name : master
Port Name : port1.0.9
Ifindex : 5009
Guest Description : red-1.0.9
Device Type : x600-24Ts
Backup Supported : No
MAC Address : 0000.cd38.0c4d
IP Address : 192.168.1.5
IPv6 Address : Not Set
HTTP Port : 0
Firmware Version : 5.4.2-0.1
```

|                   |                  |
|-------------------|------------------|
| Node Name         | : node1          |
| Port Name         | : port1.0.13     |
| Ifindex           | : 5013           |
| Guest Description | : node1-1.0.13   |
| Device Type       | : AT-TQ4600      |
| Backup Supported  | : Yes            |
| MAC Address       | : eccd.6df2.daa0 |
| IP Address        | : 192.168.5.6    |
| IPv6 Address      | : Not Set        |
| HTTP Port         | : 80             |
| Firmware Version  | : 3.1.0 B01      |

**Table 57:** Parameters in the output from **show atmf guests detail**.

| Parameter         | Description                                                                                                                                                                                                                                        |
|-------------------|----------------------------------------------------------------------------------------------------------------------------------------------------------------------------------------------------------------------------------------------------|
| Node Name         | The name of the parent node, which is the AMF node that directly connects to the guest node.                                                                                                                                                       |
| Port Name         | The port on the parent node that connects to the guest.                                                                                                                                                                                            |
| IfIndex           | An internal index number that maps to the port number on the parent node.                                                                                                                                                                          |
| Guest Description | A description that is discovered from the device, or failing that, auto-assigned by AMF. The auto-assigned name consists of:<br><parent node name>-<attached port number>.<br>You can change this by configuring a description on the port.        |
| Device Type       | The product name of the guest node, which is discovered from the device. If no device type can be discovered, this shows the name of the AMF guest-class that has been assigned to the guest node by the <a href="#">atmf guest-class</a> command. |
| Username          | The user name configured on the guest node.                                                                                                                                                                                                        |
| Backup Supported  | Whether the guest node supports AMF backup functionality.                                                                                                                                                                                          |
| MAC Address       | The MAC address of the guest node.                                                                                                                                                                                                                 |
| IP Address        | The IP address of the guest node.                                                                                                                                                                                                                  |
| IPv6 Address      | The IPv6 address of the guest node.                                                                                                                                                                                                                |
| Firmware Version  | The version of the firmware operating on the guest node.                                                                                                                                                                                           |
| HTTP port         | The HTTP port as specified with the <a href="#">http-enable</a> command when defining a guest class. You can set this if the guest node provides an HTTP user interface on a non-standard port (any port other than port 80).                      |

**Related  
Commands**    `atmf guest-class`  
                  `switchport atmf-guestlink`  
                  `show atmf backup guest`

# show atmf links

**Overview** This command displays information about AMF links on a switch. The display output contains link status state information.

**Syntax** `show atmf links [brief]`

| Parameter | Description                                                   |
|-----------|---------------------------------------------------------------|
| brief     | A brief summary of AMF links, their configuration and status. |

**Mode** User Exec and Privileged Exec

**Usage** The **show atmf links** and **show atmf links brief** commands both produce a table of summarized link information. For a more detailed view use the [show atmf links detail](#) command.

**Example** To display a brief summary of the AMF links, use the following command:

```
node-1# show atmf links brief
```

Figure 50-19: Example output from **show atmf links brief**

```
Example-core# show atmf links
ATMF Link Brief Information:
Local Link Link ATMF Adjacent Adjacent Link
Port Type Status State Node Ifindex State

1.0.10 Crosslink Down Init *crosslink1 - Blocking
1.0.14 Crosslink Down Init *crosslink2 - Blocking
1.0.1 Downlink Down Init - - Blocking
1.0.2 Downlink Up Full Node2 5001 Forwarding
1.0.8 Downlink Up Full downlink1 5001 Forwarding

* = Provisioned.
```

Table 50-1: Parameter in the output from **show atmf links brief**

| Parameter   | Definition                                                                                     |
|-------------|------------------------------------------------------------------------------------------------|
| Local Port  | Shows the local port on the selected node.                                                     |
| Link Type   | Shows link type as Uplink or Downlink (parent and child) or Cross-link (nodes in same domain). |
| Link Status | Shows the link status of the local port on the node as either Up or Down.                      |

Table 50-1: Parameter in the output from **show atmf links brief** (cont.)

| Parameter         | Definition                                                                                                                                                                                                                                                                                                                                                                                                                                                                                                                                                                                                                                                                                                                                                |
|-------------------|-----------------------------------------------------------------------------------------------------------------------------------------------------------------------------------------------------------------------------------------------------------------------------------------------------------------------------------------------------------------------------------------------------------------------------------------------------------------------------------------------------------------------------------------------------------------------------------------------------------------------------------------------------------------------------------------------------------------------------------------------------------|
| ATMF State        | Shows AMF state of the local port: <ul style="list-style-type: none"> <li>• Init - Link is down.</li> <li>• Hold - Link transitioned to up state, but waiting for hold period to ensure link is stable.</li> <li>• Incompatible - Neighbor rejected the link because of inconsistency in AMF configurations.</li> <li>• OneWay - Link is up and has waited the hold down period and now attempting to link to another unit in another domain.</li> <li>• OneWaySim - Device is running in secure mode and link is up but waiting for authorization from an AMF master.</li> <li>• Full - Link hello packets are sent and received from its neighbor with its own node id.</li> <li>• Shutdown - Link has been shut down by user configuration.</li> </ul> |
| Adjacent Node     | Shows the Adjacent AMF Node to the one being configured.                                                                                                                                                                                                                                                                                                                                                                                                                                                                                                                                                                                                                                                                                                  |
| Adjacent IF Index | Shows the IF index for the Adjacent AMF Node connected to the node being configured.                                                                                                                                                                                                                                                                                                                                                                                                                                                                                                                                                                                                                                                                      |
| Link State        | Shows the state of the AMF link. Valid states are either Forwarding or Blocking.                                                                                                                                                                                                                                                                                                                                                                                                                                                                                                                                                                                                                                                                          |

For information on filtering and saving command output, see the [“Getting Started with AlliedWare\\_Plus” Feature Overview and Configuration Guide](#).

**Related Commands**

- no debug all
- clear atmf links statistics
- show atmf
- show atmf links detail
- show atmf links guest
- show atmf links guest detail
- show atmf links statistics
- show atmf nodes



# show atmf links detail

**Overview** This command displays detailed information on all the links configured in the AMF network. It can only be run on AMF master and controller nodes.

**Syntax** show atmf links detail

| Parameter | Description                     |
|-----------|---------------------------------|
| detail    | Detailed AMF links information. |

**Mode** User Exec

**Example** To display the AMF link details use this command:

```
device1# show atmf links detail
```

The output from this command will display all the internal data held for AMF links. The following example gives details of the links that are summarized in the example in [show atmf links](#).

**Table 51:** Sample output from the **show atmf links detail** command

```
device1# show atmf links detail

Crosslink Ports Information

Port : sa1
Ifindex : 4501
Port Status : Down
Port State : Init
Last event :
Port BPDU Receive Count : 0
Port : po10
Ifindex : 4610
Port Status : Up
Port State : Full
Last event : AdjNodeLSEPresent
Port BPDU Receive Count : 140
Adjacent Node Name : Building-B
Adjacent Ifindex : 4610
Adjacent MAC : eccd.6dd1.64d0
Port Last Message Response : 0
```

**Table 51:** Sample output from the **show atmf links detail** command (cont.)

```

Port : po30
Ifindex : 4630
Port Status : Up
Port State : Full
Last event : AdjNodeLSEPresent
Port BPDU Receive Count : 132
Adjacent Node Name : Building-A
Adjacent Ifindex : 4630
Adjacent MAC : eccd.6daa.c861
Port Last Message Response : 0

Link State Entries:

Crosslink Ports Blocking : False
Node.Ifindex : Building-A.4630 - Example-core.4630
Transaction ID : 2 - 2
MAC Address : eccd.6daa.c861 - 0000.cd37.054b
Link State : Full - Full

Node.Ifindex : Building-B.4610 - Example-core.4610
Transaction ID : 2 - 2
MAC Address : eccd.6ddl.64d0 - 0000.cd37.054b
Link State : Full - Full

Domain Nodes Tree:

Node : Building-A
 Links on Node : 1
 Link 0 : Building-A.4630 - Example-core.4630
 Forwarding State : Forwarding
Node : Building-B
 Links on Node : 1
 Link 0 : Building-B.4610 - Example-core.4610
 Forwarding State : Forwarding
Node : Example-core
 Links on Node : 2
 Link 0 : Building-A.4630 - Example-core.4630
 Forwarding State : Forwarding
 Link 1 : Building-B.4610 - Example-core.4610
 Forwarding State : Forwarding

Crosslink Transaction Entries:

Node : Building-B
Transaction ID : 2
Uplink Transaction ID : 6
Node : Building-A
Transaction ID : 2
Uplink Transaction ID : 6

Uplink Information:

Waiting for Sync : 0
Transaction ID : 6
Number of Links : 0
Number of Local Uplinks : 0

```

**Table 51:** Sample output from the **show atmf links detail** command (cont.)

```
Originating Node : Building-A
Domain : -'s domain
Node : Building-A
Ifindex : 0
Node Depth : 0
Transaction ID : 6
Flags : 32
Domain Controller : -
Domain Controller MAC : 0000.0000.0000

Originating Node : Building-B
Domain : -'s domain
Node : Building-B
Ifindex : 0
Node Depth : 0
Transaction ID : 6
Flags : 32
Domain Controller : -
Domain Controller MAC : 0000.0000.0000

Downlink Domain Information:

Domain : Dept-A's domain
 Domain Controller : Dept-A
 Domain Controller MAC : eccd.6d20.c1d9
 Number of Links : 2
 Number of Links Up : 2
 Number of Links on This Node : 2
 Links are Blocked : 0
 Node Transaction List
 Node : Building-B
 Transaction ID : 8
 Node : Building-A
 Transaction ID : 8
 Domain List
 Domain : Dept-A's domain
 Node : Example-core
 Ifindex : 4621
 Transaction ID : 8
 Flags : 1
 Domain : Dept-A's domain
 Node : Example-core
 Ifindex : 4622
 Transaction ID : 8
 Flags : 1
```

**Table 51:** Sample output from the **show atmf links detail** command (cont.)

```
Domain : Dorm-D's domain
 Domain Controller : Dorm-D
 Domain Controller MAC : 0000.cd37.082c
 Number of Links : 2
 Number of Links Up : 2
 Number of Links on This Node : 2
 Links are Blocked : 0
 Node Transaction List
 Node : Building-B
 Transaction ID : 20
 Node : Building-A
 Transaction ID : 20
 Domain List
 Domain : Dorm-D's domain
 Node : Building-A
 Ifindex : 0
 Transaction ID : 20
 Flags : 32
 Domain : Dorm-D's domain
 Node : Building-B
 Ifindex : 0
 Transaction ID : 20
 Flags : 32
 Domain : Dorm-D's domain
 Node : Example-core
 Ifindex : 4510
 Transaction ID : 20
 Flags : 1
 Domain : Dorm-D's domain
 Node : Example-core
 Ifindex : 4520
 Transaction ID : 20
 Flags : 1
 Domain : Example-edge's domain
 Domain Controller : Example-edge
 Domain Controller MAC : 001a.eb93.7aa6
 Number of Links : 1
 Number of Links Up : 1
 Number of Links on This Node : 0
 Links are Blocked : 0
 Node Transaction List
 Node : Building-B
 Transaction ID : 9
 Node : Building-A
 Transaction ID : 9
```

**Table 51:** Sample output from the **show atmf links detail** command (cont.)

```
Domain List
Domain : Example-edge's domain
Node : Building-A
Ifindex : 0
Transaction ID : 9
Flags : 32
Domain : Example-edge's domain
Node : Building-B
Ifindex : 5027
Transaction ID : 9
Flags : 1

Up/Downlink Ports Information

Port : sa10
Ifindex : 4510
Port Status : Up
Port State : Full
Last event : LinkComplete
Adjacent Node : Dorm-A
Adjacent Internal ID : 211
Adjacent Ifindex : 4510
Adjacent Board ID : 387
Adjacent MAC : eccd.6ddf.6cdf
Adjacent Domain Controller : Dorm-D
Adjacent Domain Controller MAC : 0000.cd37.082c
Port Forwarding State : Forwarding
Port BPDU Receive Count : 95
Port Sequence Number : 11
Port Adjacent Sequence Number : 7
Port Last Message Response : 0
Port : po21
Ifindex : 4621
Port Status : Up
Port State : Full
Last event : LinkComplete
Adjacent Node : Dept-A
Adjacent Internal ID : 29
Adjacent Ifindex : 4621
Adjacent Board ID : 340
Adjacent MAC : eccd.6d20.c1d9
Adjacent Domain Controller : Dept-A
Adjacent Domain Controller MAC : eccd.6d20.c1d9
Port Forwarding State : Forwarding
Port BPDU Receive Count : 96
Port Sequence Number : 8
Port Adjacent Sequence Number : 9
Port Last Message Response : 0
Special Link Present : FALSE
```

**Table 52:** Parameter definitions from the **show atmf links detail** command output

| Parameter                     | Definition                                                                                                                                                                                                                                                                                                                                                                                                                                                                                                                                                                                                                                                                                                                                                                                                                                                                                                                                                                                                                                                                                                                                                                                                                                                                                                                                                                                                                                                                                                                                                                                               |
|-------------------------------|----------------------------------------------------------------------------------------------------------------------------------------------------------------------------------------------------------------------------------------------------------------------------------------------------------------------------------------------------------------------------------------------------------------------------------------------------------------------------------------------------------------------------------------------------------------------------------------------------------------------------------------------------------------------------------------------------------------------------------------------------------------------------------------------------------------------------------------------------------------------------------------------------------------------------------------------------------------------------------------------------------------------------------------------------------------------------------------------------------------------------------------------------------------------------------------------------------------------------------------------------------------------------------------------------------------------------------------------------------------------------------------------------------------------------------------------------------------------------------------------------------------------------------------------------------------------------------------------------------|
| Crosslink Ports Information   | <p>Show details of all Crosslink ports on this Node:</p> <ul style="list-style-type: none"> <li>• Port - Name of the Port or static aggregation (sa&lt;*&gt;).</li> <li>• Ifindex - Interface index for the crosslink port.</li> <li>• VR ID - Virtual router id for the crosslink port.</li> <li>• Port Status - Status of the local port on the Node as UP or DOWN.</li> <li>• Port State - AMF State of the local port.               <ul style="list-style-type: none"> <li>– Init - Link is down.</li> <li>– Hold - Link transitioned to up state, but waiting for hold period to ensure link is stable.</li> <li>– Incompatible - Neighbor rejected the link because of inconsistency in AMF configurations.</li> <li>– OneWay - Link is up and has waited the hold down period and now attempting to link to another unit in another domain</li> <li>– Full - Link hello packets are sent and received from its neighbor with its own node id.</li> <li>– Shutdown - Link has been shut down by user configuration.</li> </ul> </li> </ul> <p>Port BPDU Receive Count - The number of AMF protocol PDU's received.</p> <ul style="list-style-type: none"> <li>• Adjacent Node Name - The name of the adjacent node connected to this node.</li> <li>• Adjacent Ifindex - Adjacent AMF Node connected to this Node.</li> <li>• Adjacent VR ID - Virtual router id of the adjacent node in the domain.</li> <li>• Adjacent MAC - MAC address of the adjacent node in the domain.</li> <li>• Port Last Message Response - Response from the remote neighbor to our AMF last hello packet.</li> </ul> |
| Link State Entries            | <p>Shows all the link state database entries:</p> <ul style="list-style-type: none"> <li>• Node.Ifindex - Shows adjacent Node names and Interface index.</li> <li>• Transaction ID - Shows transaction id of the current crosslink transaction.</li> <li>• MAC Address - Shows adjacent Node MAC addresses.</li> <li>• Link State - Shows AMF states of adjacent nodes on the link.</li> </ul>                                                                                                                                                                                                                                                                                                                                                                                                                                                                                                                                                                                                                                                                                                                                                                                                                                                                                                                                                                                                                                                                                                                                                                                                           |
| Domain Nodes Tree             | <p>Shows all the nodes in the domain:</p> <ul style="list-style-type: none"> <li>• Node - Name of the node in the domain.</li> <li>• Links on Node - Number of crosslinks on a vertex/node.</li> <li>• Link no - Shows adjacent Node names and Interface index.</li> <li>• Forwarding State - Shows state of AMF link Forwarding/Blocking.</li> </ul>                                                                                                                                                                                                                                                                                                                                                                                                                                                                                                                                                                                                                                                                                                                                                                                                                                                                                                                                                                                                                                                                                                                                                                                                                                                    |
| Crosslink Transaction Entries | <p>Shows all the transaction entries:</p> <ul style="list-style-type: none"> <li>• Node - Name of the AMF node.</li> <li>• Transaction ID - transaction id of the node.</li> <li>• Uplink Transaction ID - transaction id of the remote node.</li> </ul>                                                                                                                                                                                                                                                                                                                                                                                                                                                                                                                                                                                                                                                                                                                                                                                                                                                                                                                                                                                                                                                                                                                                                                                                                                                                                                                                                 |

**Table 52:** Parameter definitions from the **show atmf links detail** command output (cont.)

| Parameter                   | Definition                                                                                                                                                                                                                                                                                                                                                                                                                                                                                                                                                                                                                                                                                                                                                                                                                                                                                                                                                                                                                                                                                                                                                                                                                                                                                                                                                                                                                                                                                                                                                                              |
|-----------------------------|-----------------------------------------------------------------------------------------------------------------------------------------------------------------------------------------------------------------------------------------------------------------------------------------------------------------------------------------------------------------------------------------------------------------------------------------------------------------------------------------------------------------------------------------------------------------------------------------------------------------------------------------------------------------------------------------------------------------------------------------------------------------------------------------------------------------------------------------------------------------------------------------------------------------------------------------------------------------------------------------------------------------------------------------------------------------------------------------------------------------------------------------------------------------------------------------------------------------------------------------------------------------------------------------------------------------------------------------------------------------------------------------------------------------------------------------------------------------------------------------------------------------------------------------------------------------------------------------|
| Uplink Information          | <p>Show all uplink entries.</p> <ul style="list-style-type: none"> <li>• Waiting for Sync - Flag if uplinks are currently waiting for synchronization.</li> <li>• Transaction ID - Shows transaction id of the local node.</li> <li>• Number of Links - Number of up downlinks in the domain.</li> <li>• Number of Local Uplinks - Number of uplinks on this node to the parent domain.</li> <li>• Originating Node - Node originating the uplink information.</li> <li>• Domain - Name of the parent uplink domain.</li> <li>• Node - Name of the node in the parent domain, that is connected to the current domain.</li> <li>• Ifindex - Interface index of the parent node's link to the current domain.</li> <li>• VR ID - Virtual router id of the parent node's link to the current domain.</li> <li>• Transaction ID - Transaction identifier for the neighbor in crosslink.</li> <li>• Flags - Used in domain messages to exchange the state:<br/>                     ATMF_DOMAIN_FLAG_DOWN = 0<br/>                     ATMF_DOMAIN_FLAG_UP = 1<br/>                     ATMF_DOMAIN_FLAG_BLOCK = 2<br/>                     ATMF_DOMAIN_FLAG_NOT_PRESENT = 4<br/>                     ATMF_DOMAIN_FLAG_NO_NODE = 8<br/>                     ATMF_DOMAIN_FLAG_NOT_ACTIVE_PARENT = 16<br/>                     ATMF_DOMAIN_FLAG_NOT_LINKS = 32<br/>                     ATMF_DOMAIN_FLAG_NO_CONFIG = 64</li> <li>• Domain Controller - Domain Controller in the uplink domain</li> <li>• Domain Controller MAC - MAC address of Domain Controller in uplink domain</li> </ul> |
| Downlink Domain Information | <p>Shows all the downlink entries:</p> <ul style="list-style-type: none"> <li>• Domain - Name of the downlink domain.</li> <li>• Domain Controller - Controller of the downlink domain.</li> <li>• Domain Controller MAC - MAC address of the domain controller.</li> <li>• Number of Links - Total number of links to this domain from the Node.</li> <li>• Number of Links Up - Total number of links that are in UP state.</li> <li>• Number of Links on This Node - Number of links terminating on this node.</li> <li>• Links are Blocked - 0 links are not blocked to the domain. 1 All links are blocked to the domain.</li> </ul>                                                                                                                                                                                                                                                                                                                                                                                                                                                                                                                                                                                                                                                                                                                                                                                                                                                                                                                                               |

**Table 52:** Parameter definitions from the **show atmf links detail** command output (cont.)

| Parameter                     | Definition                                                                                                                                                                                                                                                                                                                                                                                                                                                                                                                                                                                                                                                                                                                                                                                                                                                                                                                                                                                                                                                                                                                                                                                                                                                                                                                                                                                                                                                                                                                                                                                                                    |
|-------------------------------|-------------------------------------------------------------------------------------------------------------------------------------------------------------------------------------------------------------------------------------------------------------------------------------------------------------------------------------------------------------------------------------------------------------------------------------------------------------------------------------------------------------------------------------------------------------------------------------------------------------------------------------------------------------------------------------------------------------------------------------------------------------------------------------------------------------------------------------------------------------------------------------------------------------------------------------------------------------------------------------------------------------------------------------------------------------------------------------------------------------------------------------------------------------------------------------------------------------------------------------------------------------------------------------------------------------------------------------------------------------------------------------------------------------------------------------------------------------------------------------------------------------------------------------------------------------------------------------------------------------------------------|
| Node Transaction List         | <p>List of transactions from this downlink domain node.</p> <ul style="list-style-type: none"> <li>• Node - 0 links are not blocked to the domain. 1 All links are blocked to the domain.</li> <li>• Transaction ID - Transaction id for this node.</li> <li>• Domain List: Shows list of nodes in the current domain and their links to the downlink domain.:</li> <li>• Domain - Domain name of the downlink node.</li> <li>• Node - Name of the node in the current domain.</li> <li>• Ifindex - Interface index for the link from the node to the downlink domain.</li> <li>• Transaction ID - Transaction id of the node in the current domain.</li> <li>• Flags - As mentioned above.</li> </ul>                                                                                                                                                                                                                                                                                                                                                                                                                                                                                                                                                                                                                                                                                                                                                                                                                                                                                                                        |
| Up/Downlink Ports Information | <p>Shows all the configured up and down link ports on this node:</p> <ul style="list-style-type: none"> <li>• Port - Name of the local port.</li> <li>• Ifindex - Interface index of the local port.</li> <li>• VR ID - Virtual router id for the local port.</li> <li>• Port Status - Shows status of the local port on the Node as UP/DOWN.</li> <li>• Port State - AMF state of the local port.</li> <li>• Adjacent Node - nodename of the adjacent node.</li> <li>• Adjacent Internal ID - Unique node identifier of the remote node.</li> <li>• Adjacent Ifindex - Interface index for the port of adjacent AMF node.</li> <li>• Adjacent Board ID - Product identifier for the adjacent node.</li> <li>• Adjacent VR ID - Virtual router id for the port on adjacent AMF node.</li> <li>• Adjacent MAC - MAC address for the port on adjacent AMF node.</li> <li>• Adjacent Domain Controller - nodename of the Domain controller for Adjacent AMF node.</li> <li>• Adjacent Domain Controller MAC - MAC address of the Domain controller for Adjacent AMF node.</li> <li>• Port Forwarding State - Local port forwarding state Forwarding or Blocking.</li> <li>• Port BPDU Receive Count - count of AMF protocol PDU's received.</li> <li>• Port Sequence Number - hello sequence number, incremented every time the data in the hello packet changes.</li> <li>• Port Adjacent Sequence Number - remote ends sequence number used to check if we need to process this packet or just note it arrived.</li> <li>• Port Last Message Response - response from the remote neighbor to our last hello packet.</li> </ul> |

For information on filtering and saving command output, see the [“Getting Started with AlliedWare Plus” Feature Overview and Configuration Guide](#).



**Related  
Commands**    no debug all  
                  clear atmf links statistics  
                  show atmf

# show atmf links guest

**Overview** This command displays information about guest nodes visible to an AMF device.

**Syntax** `show atmf links guest [interface <interface-range>]`

| Parameter                      | Description                                                                |
|--------------------------------|----------------------------------------------------------------------------|
| interface<br><interface-range> | Select a specific range of ports to display information about guest nodes. |

**Default** With no parameters specified this command will display its standard output for all ports with guest nodes connected.

**Mode** User Exec/Privileged Exec

**Usage** Use this command to display the guest nodes connected to a single parent node. If you want to see a list of all the guests in the AMF network, use [show atmf guests](#).

**Example 1** To display information about AMF guests that are connectible from node1, use the command:

```
node1# show atmf links guest
```

**Output** Figure 50-20: Example output from **show atmf links guest**

```
node1#sh atmf links guest

Guest Link Information:

DC = Discovery configuration
S = static D = dynamic

Local Guest Model MAC IP / IPv6
Port Class Type DC Address Address

1.0.1 - other D 0013.1a1e.4589 192.168.1.2
1.0.2 aastra-phone other D 0008.5d10.7635 192.168.1.3
1.0.3 cisco-phone2 other S - 192.168.2.1
1.0.4 panasonic... other D 0800.239e.f1fe 192.168.1.5
```

Table 50-1: Parameters in the output from **show atmf links guest**

| Parameter   | Description                                                                                                                |
|-------------|----------------------------------------------------------------------------------------------------------------------------|
| Local Port  | The port on the parent node that connects to the guest.                                                                    |
| Guest Class | The name of the ATMF guest-class that has been assigned to the guest node by the <a href="#">atmf guest-class</a> command. |

Table 50-1: Parameters in the output from **show atmf links guest** (cont.)

| Parameter         | Description                                                                                                                                                                                                              |
|-------------------|--------------------------------------------------------------------------------------------------------------------------------------------------------------------------------------------------------------------------|
| Model Type        | The model type of the guest node, as entered by the <code>modeltype</code> command. Can be one of the following: <ul style="list-style-type: none"><li>• alliedware</li><li>• aw+</li><li>• tq</li><li>• other</li></ul> |
| DC                | The discovery method as applied by the <code>discovery</code> command. This can be either dynamic (D) or static (S).                                                                                                     |
| MAC Address       | The MAC address of the guest node.                                                                                                                                                                                       |
| IP / IPv6 Address | The IP address of the guest node.                                                                                                                                                                                        |

**Related Commands**

- `atmf guest-class`
- `discovery`
- `http-enable`
- `username`
- `modeltype`
- `switchport atmf-guestlink`
- `show atmf backup guest`

# show atmf links guest detail

**Overview** This command displays detailed information about guest nodes visible to an AMF device.

**Syntax** `show atmf links guest detail [interface <interface-range>]`

| Parameter                                                      | Description                                                                |
|----------------------------------------------------------------|----------------------------------------------------------------------------|
| <code>interface</code><br><code>&lt;interface-range&gt;</code> | Select a specific range of ports to display information about guest nodes. |

**Default** Display details for all ports with guest nodes connected.

**Mode** User Exec/Privileged Exec

**Usage** Use this command to display the guest nodes connected to a single parent node. If you want to see a list of all the guests in the AMF network, use [show atmf guests detail](#).

Note that the parameters that are displayed depend on the guest node's model and state.

**Example** To display detailed information about AMF guests, use the command:

```
node1# show atmf links guest detail
```

**Output** Figure 50-21: Example output from **show atmf links guest detail**

```

node1#show atmf links guest detail

Detailed Guest Link Information:

Interface : port1.0.13
Link State : Down
Class Name : test
Model Type : Other
Discovery Method : Static
IP Address : 192.168.1.13
Node State : Down

Interface : port1.0.17
Link State : Full
Class Name : access
Model Type : TQ
Discovery Method : Dynamic
IP Address : 192.168.5.8
Username : manager
Node State : Full
Backup Supported : Yes
MAC address : 001a.ebad.ce60
Device Type : AT-TQ3400
Description : node1-1.0.17
Firmware Version : 3.2.1 A02

```

Table 50-2: Parameters in the output from **show atmf links guest detail**

| Parameter  | Description                                                                                                                                                                                                                                                                                                                                                                                                                                                                                                                                                                                                                                                                             |
|------------|-----------------------------------------------------------------------------------------------------------------------------------------------------------------------------------------------------------------------------------------------------------------------------------------------------------------------------------------------------------------------------------------------------------------------------------------------------------------------------------------------------------------------------------------------------------------------------------------------------------------------------------------------------------------------------------------|
| Interface  | The port on the parent node that connects to the guest.                                                                                                                                                                                                                                                                                                                                                                                                                                                                                                                                                                                                                                 |
| Link State | The state of the link to the guest node; one of: <ul style="list-style-type: none"> <li>Down: The physical link is down.</li> <li>Up: The physical link has come up, but it is still during a timeout period that is enforced to allow other links to come up.</li> <li>Learn: The timeout period described above has elapsed, and the link is now learning information from the AMF guest node. You can see what information it is learning from the "Node State" field below.</li> <li>Full: The node connected by this link has joined the AMF network.</li> <li>Fail: The port is physically up but something has prevented the guest node from joining the AMF network.</li> </ul> |
| Class Name | The name of the ATMF guest-class that has been assigned to the guest node by the <code>atmf guest-class</code> command.                                                                                                                                                                                                                                                                                                                                                                                                                                                                                                                                                                 |

Table 50-2: Parameters in the output from **show atmf links guest detail** (cont.)

| Parameter        | Description                                                                                                                                                                                                                                                                                                                                                                                                                                                                                                                                                                                                                                                                                                                                                                                                                                                                                                                                                                                                       |
|------------------|-------------------------------------------------------------------------------------------------------------------------------------------------------------------------------------------------------------------------------------------------------------------------------------------------------------------------------------------------------------------------------------------------------------------------------------------------------------------------------------------------------------------------------------------------------------------------------------------------------------------------------------------------------------------------------------------------------------------------------------------------------------------------------------------------------------------------------------------------------------------------------------------------------------------------------------------------------------------------------------------------------------------|
| Model Type       | The model type of the guest node, as entered by the <code>modeltype</code> command. Can be one of the following: <ul style="list-style-type: none"> <li>• alliedware</li> <li>• aw+</li> <li>• tq</li> <li>• other</li> </ul>                                                                                                                                                                                                                                                                                                                                                                                                                                                                                                                                                                                                                                                                                                                                                                                     |
| Discovery Method | The discovery method as applied by the <code>discovery</code> command. This can be either dynamic or static.                                                                                                                                                                                                                                                                                                                                                                                                                                                                                                                                                                                                                                                                                                                                                                                                                                                                                                      |
| IP Address       | The IP address of the guest node.                                                                                                                                                                                                                                                                                                                                                                                                                                                                                                                                                                                                                                                                                                                                                                                                                                                                                                                                                                                 |
| Username         | The user name configured on the guest node.                                                                                                                                                                                                                                                                                                                                                                                                                                                                                                                                                                                                                                                                                                                                                                                                                                                                                                                                                                       |
| Node state       | The state of the guest node; one of: <ul style="list-style-type: none"> <li>• Down: The initial state when a link to a guest node is first configured. This is also the state if the physical link goes down.</li> <li>• Getting IP: The AMF device is in the process of retrieving the IP address of the guest node.</li> <li>• Getting Mac: The AMF device is in the process of retrieving the MAC address of the guest node.</li> <li>• Getting Info: The AMF device is in the process of retrieving any other available information from the guest (firmware version etc). The information available depends on what device the guest node is.</li> <li>• Full: The AMF device has retrieved all necessary information and the guest node has joined the AMF network. Once this state is reached, the Link State also changes to "Full".</li> <li>• Failure: The physical link is up but the AMF member has failed to retrieve enough information to allow the guest node to join the AMF network.</li> </ul> |
| Backup Supported | Whether the guest node supports AMF backup functionality.                                                                                                                                                                                                                                                                                                                                                                                                                                                                                                                                                                                                                                                                                                                                                                                                                                                                                                                                                         |
| MAC Address      | The MAC address of the guest node.                                                                                                                                                                                                                                                                                                                                                                                                                                                                                                                                                                                                                                                                                                                                                                                                                                                                                                                                                                                |
| Device Type      | Model information for the guest node. This field shows the model information that AMF retrieved from the guest node. In contrast, the Model Type shows what a user entered as the type of device they intended this guest node to be.                                                                                                                                                                                                                                                                                                                                                                                                                                                                                                                                                                                                                                                                                                                                                                             |
| Description      | By default, this is a concatenation of the guest node's parent node and the port to which it is attached. You can change it by configuring a description on the port.                                                                                                                                                                                                                                                                                                                                                                                                                                                                                                                                                                                                                                                                                                                                                                                                                                             |

Table 50-2: Parameters in the output from **show atmf links guest detail** (cont.)

| Parameter        | Description                                                                                                                                                                                                                   |
|------------------|-------------------------------------------------------------------------------------------------------------------------------------------------------------------------------------------------------------------------------|
| Serial Number    | The serial number of the guest node.                                                                                                                                                                                          |
| Firmware Name    | The name of the firmware operating on the guest node.                                                                                                                                                                         |
| Firmware Version | The version of the firmware operating on the guest node.                                                                                                                                                                      |
| HTTP port        | The HTTP port as specified with the <a href="#">http-enable</a> command when defining a guest class. You can set this if the guest node provides an HTTP user interface on a non-standard port (any port other than port 80). |

**Related  
Commands**

[atmf guest-class](#)  
[discovery](#)  
[http-enable](#)  
[username](#)  
[modeltype](#)  
[switchport atmf-guestlink](#)  
[show atmf backup guest](#)

# show atmf links statistics

**Overview** This command displays details of the AMF links configured on the device and also displays statistics about the AMF packet exchanges between the devices.

It is also possible to display the AMF link configuration and packet exchange statistics for a specified interface.

This command can only be run on AMF master and controller nodes

**Syntax** `show atmf links statistics [interface [<port_number>]]`

| Parameter     | Description                                                                                                                                                                                                              |
|---------------|--------------------------------------------------------------------------------------------------------------------------------------------------------------------------------------------------------------------------|
| interface     | Specifies that the command applies to a specific interface (port) or range of ports. Where both the interface and port number are unspecified, full statistics (not just those relating to ports) will be displayed.     |
| <port_number> | Enter the port number for which statistics are required. A port range, a static channel or LACP link can also be specified. Where no port number is specified, statistics will be displayed for all ports on the device. |

**Mode** User Exec

**Example 1** To display AMF link statistics for the whole device, use the command:

```
device1# show atmf links statistics
```

**Table 51:** Sample output from the **show atmf links statistics** command

| ATMF Statistics:       |         |          |
|------------------------|---------|----------|
|                        | Receive | Transmit |
| -----                  | -----   | -----    |
| Arealink Hello         | 318     | 327      |
| Crosslink Hello        | 164     | 167      |
| Crosslink Hello Domain | 89      | 92       |
| Crosslink Hello Uplink | 86      | 88       |
| Hello Link             | 0       | 0        |
| Hello Neighbor         | 628     | 630      |
| Hello Stack            | 0       | 0        |
| Hello Gateway          | 1257    | 1257     |
| Database Description   | 28      | 28       |
| Database Request       | 8       | 6        |
| Database Update        | 66      | 162      |
| Database Update Bitmap | 0       | 29       |
| Database Acknowledge   | 144     | 51       |



**Table 51:** Sample output from the **show atmf links statistics** command (cont.)

```

Transmit Fails 0 1
Discards 0 0
Total ATMF Packets 2788 2837

ATMF Database Statistics:

Database Entries 18
Database Full Ages 0
ATMF Virtual Link Statistics:

Virtual Receive Receive Transmit
link Receive Dropped Transmit Dropped

vlink2000 393 0 417 0

ATMF Packet Discards:
Type0 0 : Gateway hello msg received from unexpected neighbor
Type1 0 : Stack hello msg received from unexpected neighbor
Type2 0 : Discard TX update bitmap packet - bad checksum
Type3 0 : Discard TX update packet - neighbor not in correct state
Type4 0 : Discard update packet - bad checksum or type
Type5 0 : Discard update packet - neighbor not in correct state
Type6 0 : Discard update bitmap packet - bad checksum or type
Type7 0 : Incarnation is not possible with the data received
Type8 0 : Discard crosslink hello received - not correct state
Type9 0 : Discard crosslink domain hello received on non crosslink
Type10 0 : Discard crosslink domain hello - not in correct state
Type11 0 : Crosslink uplink hello received on non crosslink port
Type12 0 : Discard crosslink uplink hello - not in correct state
Type13 0 : Wrong network-name for this ATMF
Type14 0 : Packet received on port is too long
Type15 0 : Bad protocol version, received on port
Type16 0 : Bad packet checksum calculation
Type17 0 : Bad authentication type
Type18 0 : Bad simple password
Type19 0 : Unsupported authentication type
Type20 0 : Discard packet - unknown neighbor
Type21 0 : Discard packet - port is shutdown
Type22 0 : Non broadcast hello msg received from unexpected neighbor
Type23 0 : Arealink hello msg received on non arealink port
Type24 0 : Discard arealink hello packet - not in correct state
Type25 0 : Discard arealink hello packet - failed basic processing
Type26 0 : Discard unicast packet - MAC address does not match node
Type27 0 : AMF Master license node limit exceeded

```

**Example 2** To display the AMF links statistics on interface port1.0.5, use the command:

```

device1# show atmf links statistics interface
port1.0.5

```

Figure 50-22: Sample output from the **show atmf links statistics** command for interface 1.0.5

```

device1# show atmf links statistics interface port1.0.5

ATMF Port Statistics:

Transmit Receive

port1.0.5 Crosslink Hello 231 232
port1.0.5 Crosslink Hello Domain 116 116
port1.0.5 Crosslink Hello Uplink 116 115
port1.0.5 Hello Link 0 0
port1.0.5 Arealink Hello 0 0

```

Figure 50-23: Parameter definitions from the **show atmf links statistics** command output

| Parameter            | Definition                                                             |
|----------------------|------------------------------------------------------------------------|
| Receive              | Shows a count of AMF protocol packets received per message type.       |
| Transmit             | Shows the number of AMF protocol packets transmitted per message type. |
| Database Entries     | Shows the number of AMF elements existing in the distributed database. |
| Database Full Ages   | Shows the number of times the entries aged in the database.            |
| ATMF Packet Discards | Shows the number of discarded packets of each type.                    |

For information on filtering and saving command output, see the [“Getting Started with AlliedWare Plus” Feature Overview and Configuration Guide](#).

- Related Commands**
- no debug all
  - clear atmf links statistics
  - show atmf

# show atmf nodes

**Overview** This command displays nodes currently configured within the AMF network.

Note that the output also tells you whether or not node map exchange is active. Node map exchange improves the tracking of nodes joining and leaving an AMF network. This improves the efficiency of AMF networks. Node map exchange is only available if every node in your AMF network is running version 5.4.6-2.1 or later. We recommend running the latest version on all nodes in your network, so you receive the advantages of node map exchange and other improvements.

**Syntax** `show atmf nodes [guest|all]`

| Parameter | Description                                                  |
|-----------|--------------------------------------------------------------|
| guest     | Display only guest nodes in the AMF network.                 |
| all       | Display all nodes in the AMF network, including guest nodes. |

**Mode** Privileged Exec

**Usage** You can use this command to display one of three sets of nodes:

- all nodes except guest nodes, by specifying **show atmf nodes**
- all nodes including guest nodes, by specifying **show atmf nodes all**
- only guest nodes, by specifying **show atmf nodes guest**

**Examples** To display AMF information for all nodes except guest nodes, use the command:

```
node1# show atmf nodes
```

Table 50-1: Sample output from **show atmf nodes**

```
node1#show atmf nodes guest

Node Information:

* = Local device

SC = Switch Configuration:
C = Chassis S = Stackable N = Standalone

Node Device ATMF Parent Node
Name Type Master SC Domain Depth

* M1 x510-28GTX Y S none 0
N3 x230-18GP N N M1 1
N1 AR4050S N N M1 1

Node map exchange is active
Current ATMF node count 3
```

To display AMF information for all nodes, including guest nodes, use the command:

```
node1# show atmf nodes all
```

**Table 51:** Sample output from **show atmf nodes all**. In this example, not all nodes support node map exchange, as shown by the message at the end

```
node1#show atmf nodes all

Node and Guest Information:

* = Local device

SC = Switch Configuration:
C = Chassis S = Stackable N = Standalone G = Guest
```

| Node/Guest Name | Device Type | ATMF Master | SC | Parent Domain | Node Depth |
|-----------------|-------------|-------------|----|---------------|------------|
| * M1            | x510-28GTX  | Y           | S  | none          | 0          |
| N3              | x230-18GP   | N           | N  | M1            | 1          |
| N1              | AR4050S     | N           | N  | M1            | 1          |
| N3-1.0.24       | AT-TQ4600   | N           | G  | N3            | -          |

```

Node map exchange is inactive
Firmware on some nodes does not support node map exchange, eg AR4050S
Current ATMF node count 4 (guests 1)

```

To display AMF information for guest nodes only, use the command:

```
node1# show atmf nodes guest
```

**Table 50-1:** Sample output from **show atmf nodes guest**

```
node1#show atmf nodes guest

Guest Information:
```

| Device Name | MAC Address    | Parent | Port  | IP/IPv6 Address |
|-------------|----------------|--------|-------|-----------------|
| aastra-...  | 0008.5d10.7635 | Node-1 | 1.0.2 | 192.168.4.7     |
| poe-1.0.1   | 0013.1a1e.4589 | Node-1 | 1.0.1 | 192.168.4.6     |
| ip-camera   | 0800.239e.f1fe | Node-1 | 1.0.4 | 192.168.4.8     |
| tq4600      | eccd.6df2.da60 | Node-1 | 1.0.5 | 192.168.4.50    |

- Related Commands**
- [show atmf](#)
  - [show atmf area nodes](#)
  - [discovery](#)
  - [http-enable](#)
  - [show atmf backup guest](#)

# show atmf provision nodes

**Overview** This command displays information about each provisioned node with details about date and time of creation, boot and configuration files available in the backup, and license files present in the provisioned backup. This includes nodes that have joined the network but are yet to run their first backup.

This command can only be run on AMF master and controller nodes.

**Syntax** `show atmf provision nodes`

**Mode** Privileged Exec

**Usage** This command will only work if provisioned nodes have already been set up. Otherwise, an error message is shown when the command is run.

**Example** To show the details of all the provisioned nodes in the backup use the command:

```
NodeName# show atmf provision nodes
```

Figure 50-24: Sample output from the **show atmf provision nodes** command

```
device1#show atmf provision nodes

ATMF Provisioned Node Information:

Backup Media: SD (Total 3827.0MB, Free 3481.1MB)

Node Name : device2
Date& Time : 06-Oct-2016 & 23:25:44
Provision Path : card:/atmf/provision_nodes

Boot configuration :
Current boot image : x510-5.4.6-1.4.rel (file exists)
Backup boot image : x510-5.4.6-1.3.rel (file exists)
Default boot config : flash:/default.cfg (file exists)
Current boot config : flash:/abc.cfg (file exists)
Backup boot config : flash:/xyz.cfg (file exists)

Software Licenses :
Repository file : ../configs/.sw_v2.lic
 : ../configs/.swfeature.lic
Certificate file : card:/atmf/nodes/awplus1/flash/.atmf-lic-cert
```

- Related commands**
- [atmf provision node create](#)
  - [atmf provision node clone](#)
  - [atmf provision node configure boot config](#)
  - [atmf provision node configure boot system](#)
  - [show atmf backup](#)

# show atmf secure-mode

**Overview** Use this command to display an overview of the secure mode status of an AMF network.

**Syntax** show atmf secure-mode

**Mode** Privileged Exec

**Example** To display an overview of AMF secure mode on an AMF master or member node, use the command:

```
awplus# show atmf secure-mode
```

**Output** Figure 50-25: Example output from **show atmf secure-mode** on an AMF master

```
ATMF Secure Mode:

Secure Mode Status : Enabled
Certificate Expiry : 180 Days
Certificates Total : 8
Certificates Revoked : 0
Certificates Rejected : 0
Certificates Active : 8

Provisional Authorization : 0
Pending Requests : 0

Trusted Master : master_1
Trusted Master : master_2

Key Fingerprint:
 48:37:d9:a0:37:32:22:9b:5c:22:da:a2:62:49:a7:e5:a9:bc:12:88
```

Figure 50-26: Example output from **show atmf secure-mode** on an AMF node

```
ATMF Secure Mode:

Secure Mode Status : Enabled
Trusted Master : master_1
Trusted Master : master_2

Key Fingerprint:
 93:f0:52:a9:74:8f:ae:ea:5b:e2:ee:62:cb:6b:21:22:5a:08:db:98
```

Table 50-2: Parameters in the output from **show atmf secure-mode**

| Parameter                 | Description                                                                                                                                        |
|---------------------------|----------------------------------------------------------------------------------------------------------------------------------------------------|
| Secure Mode Status        | Shows the status of secure mode, Enabled or Disabled.                                                                                              |
| Certificate Expiry        | Certificate expiry time. Set with <a href="#">atmf secure-mode certificate expiry</a>                                                              |
| Certificates Total        | Total number of certificates.                                                                                                                      |
| Certificates Revoked      | Certificates that have been revoked by the AMF master.                                                                                             |
| Certificates Rejected     | Certificates that have been rejected by the AMF master.                                                                                            |
| Certificates Active       | Certificates that are currently active.                                                                                                            |
| Provisional Authorization | Number of nodes with provisional authorization. For more information use the <a href="#">show atmf authorization provisional</a> command.          |
| Pending Requests          | Number of nodes waiting for authorization on the AMF master. For more information use the <a href="#">show atmf authorization pending</a> command. |
| Trusted Master            | List of trusted masters in the AMF area.                                                                                                           |
| Key Fingerprint           | The AMF node's key fingerprint.                                                                                                                    |

**Related Commands**

- [atmf authorize](#)
- [atmf secure-mode](#)
- [atmf secure-mode certificate expiry](#)
- [show atmf authorization](#)
- [show atmf secure-mode audit link](#)

**Command changes** Version 5.4.7-0.3: command added

# show atmf secure-mode audit

**Overview** Use this command to detect security vulnerabilities on a node.

**Syntax** show atmf secure-mode audit

**Mode** Privileged Exec

**Example** To display AMF secure mode link audits for a node, use the command

```
awplus# show atmf secure-mode audit
```

**Output** Figure 50-27: Example output from **show atmf secure-mode audit**

```
ATMF Secure Mode Audit:

Warning : The default username and password is enabled.
Good : SNMP V1 or V2 is disabled.
Warning : Telnet server is enabled.
Good : ATMF is enabled. Secure-Mode is on.
Good : ATMF Topology-GUI is disabled. No trustpoints configured.

ATMF Secure Mode Log Events:

2017 Feb 2 00:59:25 user.notice node1 ATMF[848]: Sec_Audit - ATMF Secure
Mode is enabled.
2017 Feb 2 01:30:00 user.notice node1 ATMF[848]: Sec_Audit - Established
secure connection to area_1_node_1 on interface vlink1.
```

Table 50-3: Parameters in the output from **show atmf secure-mode audit link**

| Parameter                   | Description                                                                                                                                                                                                     |
|-----------------------------|-----------------------------------------------------------------------------------------------------------------------------------------------------------------------------------------------------------------|
| ATMF Secure Mode Audit      | A list of security recommendations to secure the AMF network. Items prefaced with <code>Warning</code> need to be fixed. In the sample above the default username and password, and telnet, should be disabled. |
| ATMF Secure Mode Log Events | A list of recorded secure mode log events.                                                                                                                                                                      |

**Related Commands** [show atmf secure-mode](#)

**Command changes** Version 5.4.7-0.3: command added



# show atmf secure-mode audit link

**Overview** Use this command to detect security vulnerabilities by identifying devices that are connected to a secure mode node that are not in secure mode or are not authorized.

**Syntax** `show atmf secure-mode audit link`

**Mode** Privileged Exec

**Example** To display AMF secure mode link audits for a node, use the command  
`awplus# show atmf secure-mode audit link`

**Output** Figure 50-28: Example output from **show atmf secure-mode audit link**

```
ATMF Secure Mode Audit Link:

* ATMF links connected to devices which are not authorized
 or are not in secure-mode.

Port Link Type Discovered Node/Area Name

vlink1 Downlink 16/02/2017 09:28:22 Member3
```

Table 50-4: Parameters in the output from **show atmf secure-mode audit link**

| Parameter      | Description                         |
|----------------|-------------------------------------|
| Port           | Port name on local device.          |
| Link Type      | Link type.                          |
| Discovered     | Date discovered                     |
| Node/Area Name | Node or area name of remote device. |

**Related Commands** [show atmf](#)  
[show atmf secure-mode](#)

**Command changes** Version 5.4.7-0.3: command added

# show atmf secure-mode certificates

**Overview** Use this command to display the certificate status details when secure mode is enabled on an AMF network.

**Syntax** `show atmf secure-mode certificates [detail] [area <area-name>]  
[node <node-name>]`

| Parameter   | Description                                                   |
|-------------|---------------------------------------------------------------|
| detail      | Display detailed certificate information.                     |
| area        | Specify an AMF area.                                          |
| <area-name> | The AMF area you want to see the certificate information for. |
| node        | Specify an AMF node.                                          |
| <node-name> | The AMF node you want to see information for.                 |

**Mode** Privileged Exec

**Example** To display AMF secure mode certificates on a master or member node, use the command:

```
awplus# show atmf secure-mode certificates
```

To display detailed information about AMF secure mode certificates for a node named "area\_2\_node\_1" in an area named "area-2", use the command:

```
awplus# show atmf secure-mode certificates detail area area-2
node area_2_node_1
```

**Output** Figure 50-29: Example output from **show atmf secure-mode certificates**

```
Area-1 Certificates:
Node Name Signer Expires Status

area_1_node_1 master_1 11 Mar 2017
 master_2 4 Mar 2017 Active
area_1_node_2 master_1 11 Mar 2017
 master_2 4 Mar 2017 Revoked

Area-2 Certificates:
Node Name Signer Expires Status

area_2_node_1 master_1 18 Mar 2017 Active
area_2_node_2 master_1 18 Mar 2017 Rejected
```

Table 50-5: Parameters in the output from **show atmf secure-mode certificates**

| Parameter | Description                                                                                                                                                                                     |
|-----------|-------------------------------------------------------------------------------------------------------------------------------------------------------------------------------------------------|
| Node Name | Name of AMF node the certificate was issued to.                                                                                                                                                 |
| Signer    | Name of AMF master that issued the certificate.                                                                                                                                                 |
| Expires   | Certificate expiry date.                                                                                                                                                                        |
| Status    | The status column will display <i>Active</i> before a member node is trusted, and can be accessed using AMF commands. Valid statuses are <i>Active</i> , <i>Revoked</i> , and <i>Rejected</i> . |

**Output** Figure 50-30: Example output from **show atmf secure-mode certificates detail area area-2 node area\_2\_node\_1**

```

Certificates Detail:

area_2_node_1 (area:area-2)
 MAC Address : 0000.cd37.0003
 Status : Active
 Serial Number : A24SC8001
 Product : x510-28GTX
 Key Fingerprint : cd:b4:c9:cd:7b:87:6a:30:98:25:d7:3c:89:8e:cb:74:e8:91:56:9d
 Flags : 00000011
 Signer : master_1
 Expiry Date : 18 Mar 2017 21:17:42

```

Table 50-6: Parameters in the output from **show atmf secure-mode certificates detail**

| Parameter       | Description                                                                                                                                                                              |
|-----------------|------------------------------------------------------------------------------------------------------------------------------------------------------------------------------------------|
| MAC Address     | MAC address of AMF node.                                                                                                                                                                 |
| Status          | The device status will show <i>Active</i> if a member node is trusted, and can be accessed using AMF commands. Valid statuses are <i>Active</i> , <i>Revoked</i> , and <i>Rejected</i> . |
| Serial Number   | Device serial number.                                                                                                                                                                    |
| Product         | Device product type.                                                                                                                                                                     |
| Key Fingerprint | AMF node key fingerprint.                                                                                                                                                                |
| Flags           | Internal AMF information.                                                                                                                                                                |
| Signer          | Name of AMF master that issued the certificate.                                                                                                                                          |
| Expiry Date     | Certificate expiry date.                                                                                                                                                                 |

**Related  
Commands** atmf authorize  
atmf secure-mode  
atmf secure-mode certificate expire  
atmf secure-mode certificate renew  
clear atmf secure-mode certificates  
show atmf secure-mode sa

**Command  
changes** Version 5.4.7-0.3: command added

# show atmf secure-mode sa

**Overview** Use this command to display the security associations on the network. This is the list of links and neighbors that are trusted.

**Syntax** `show atmf secure-mode sa [detail] [link|neighbor|broadcast]`

| Parameter | Description                                        |
|-----------|----------------------------------------------------|
| detail    | Display detailed security association information. |
| link      | Display security associations for type links.      |
| neighbor  | Display security associations for type neighbors.  |
| broadcast | Display security associations for type broadcast.  |

**Mode** Privileged Exec

**Example** To display an overview of AMF secure mode security associations on a master or member node, use the command:

```
awplus# show atmf secure-mode sa
```

To display a detailed overview of AMF secure mode neighbor security associations on a master or member node, use the command:

```
awplus# show atmf secure-mode sa detail neighbor
```

**Output** Figure 50-31: Example output from **show atmf secure-mode sa**

```
ATMF Security Associations:
```

| Type                 | State         | ID       | Details    |
|----------------------|---------------|----------|------------|
| Neighbor Node        | Complete      | 175      | master_1   |
| Broadcast            | Complete      | 4095     |            |
| CrossLink            | Complete      | 4501     | sa1        |
| AreaLink             | Cert Exchg    | 4511     | sa11       |
| Link                 | Complete      | 6009     | port1.2.9  |
| AreaLink             | CA Exchg Init | 6013     | port1.2.13 |
| AreaLink             | Cert Exchg    | 13001    | port1.9.1  |
| Link                 | CA Exchg Init | 16779521 | vlink3     |
| Neighbor Gateway     | Complete      | 83       | master_2   |
| Neighbor Gateway     | Complete      | 175      | master_1   |
| Neighbor Cntl-Master | Complete      | 83       | master_2   |
| Neighbor Cntl-Master | Complete      | 175      | master_1   |

Figure 50-32: Example output from **show atmf secure-mode sa detail neighbor**

```
Security Associations Detail:

Id : 175 (af)
 Type : Neighbor Node
 State : Complete
 Remote MAC Address : eccd.6d82.6c16
 Flags : 000003c0

Id : 83 (40000053)
 Type : Neighbor Gateway
 State : Complete
 Remote MAC Address : 001a.eb54.e53b
 Flags : 000003c0

Id : 175 (400000af)
 Type : Neighbor Gateway
 State : Complete
 Remote MAC Address : eccd.6d82.6c16
 Flags : 000003c0

Id : 83 (80000053)
 Type : Neighbor Cntl-Master
 State : Complete
 Remote MAC Address : 001a.eb54.e53b
 Flags : 000003c0

Id : 175 (800000af)
 Type : Neighbor Cntl-Master
 State : Complete
 Remote MAC Address : eccd.6d82.6c16
 Flags : 000003c0

Id : 321 (80000141)
 Type : Neighbor Cntl-Master
 State : Complete
 Remote MAC Address : 0000.f427.93da
 Flags : 000003c0
```

Table 50-7: Parameters in the output from **show atmf secure-mode sa**

| Parameter          | Description                                                                                                                                                                                                                                                                                                                                                                                                                                                                                                        |
|--------------------|--------------------------------------------------------------------------------------------------------------------------------------------------------------------------------------------------------------------------------------------------------------------------------------------------------------------------------------------------------------------------------------------------------------------------------------------------------------------------------------------------------------------|
| Type               | Security Association (SA) types: <ul style="list-style-type: none"> <li>• Link - SA for link</li> <li>• CrossLink - SA for crosslink</li> <li>• AreaLink - SA for area link</li> <li>• Neighbor Node - SA for node neighbor relationship</li> <li>• Neighbor Gateway - SA for gateway neighbor relationship</li> <li>• Neighbor Cntl-Master - SA for controller/master neighbor relationship</li> <li>• Broadcast - SA for working-set broadcast requests</li> </ul>                                               |
| State              | Current state of the Security Association. The state must be <code>Complete</code> before a member node is trusted, and can be accessed using AMF commands. <ul style="list-style-type: none"> <li>• CA Exchg Init - SA is ready to begin the SA exchange process</li> <li>• CA Exchg - SA is currently exchanging CAs</li> <li>• Cert Exchg - SA is currently exchanging certificates</li> <li>• Key Exchg - SA is currently exchanging ephemeral keys</li> <li>• Complete - SA exchange has completed</li> </ul> |
| ID                 | Security Association ID. <ul style="list-style-type: none"> <li>• For Neighbor types this is the remote node ID.</li> <li>• For Link types this is the local ifindex.</li> <li>• For Broadcast type this is always 4095.</li> </ul>                                                                                                                                                                                                                                                                                |
| Details            | Human readable translation of ID. <ul style="list-style-type: none"> <li>• For Neighbor types this is the node name</li> <li>• For Link types this is the interface name</li> </ul>                                                                                                                                                                                                                                                                                                                                |
| Remote MAC Address | MAC address of the remote partner of the security association.                                                                                                                                                                                                                                                                                                                                                                                                                                                     |
| Flags              | Internal AMF information.                                                                                                                                                                                                                                                                                                                                                                                                                                                                                          |

**Related Commands**

- [atmf secure-mode](#)
- [show atmf secure-mode](#)
- [show atmf secure-mode certificates](#)

**Command changes**

Version 5.4.7-0.3: command added

# show atmf secure-mode statistics

**Overview** Use this command to display AMF secure mode statistics. These statistics are from when AMF secure mode was first enabled or the statistics were cleared with the `clear atmf secure-mode statistics` command.

**Syntax** `show atmf secure-mode statistics`

**Mode** Privileged Exec

**Example** To display AMF secure mode statistics on a master or member node, use the command:

```
awplus# show atmf secure-mode statistics
```

**Output** Figure 50-33: Example output from `show atmf secure-mode statistics` on an AMF master.

```
ATMF Secure Mode Statistics:

Certificates:
New 7 Expired 0
Updated 7 Deleted 0
Revoked 1 Renewed 2
Rejected 1 Re-authorized 1
Authorized 0

Local Certificates:
Valid 4 Invalid 0
Certificates Validation:
Request Valid 2
Request Invalid 0
Common Valid 13
Common Invalid 0
Issuer Valid 14
Issuer Invalid 0
Signature Verified 29
Signature Invalid 0
Signature Purpose Invalid 0

Signatures Signed 12
Master Certificates:
Re-issued 3
Downgraded to member 0

Public key change 2
Invalid SA public key 0
```



**Output** Figure 50-34: Example output from **show atmf secure-mode statistics** on an AMF node.

```
ATMF Secure Mode Statistics:

Local Certificates:
Valid 3 Invalid 0

Certificates Validation:
Request Valid 0
Request Invalid 0
Common Valid 0
Common Invalid 0
Issuer Valid 12
Issuer Invalid 0
Signature Verified 12
Signature Invalid 3
Signature Purpose Invalid 0

Signatures Signed 0

Master Certificates:
Re-issued 0
Downgraded to member 0

Public key change 2
Invalid SA public key 0
```

- Related Commands**
- [atmf authorize](#)
  - [atmf secure-mode](#)
  - [atmf secure-mode certificate renew](#)
  - [clear atmf secure-mode statistics](#)
  - [show atmf secure-mode](#)

**Command changes** Version 5.4.7-0.3: command added

# show atmf tech

**Overview** This command collects and displays all the AMF command output. The command can thus be used to display a complete picture of an AMF network.

**Syntax** show atmf tech

**Mode** Privileged Exec

**Example** To display output for all AMF commands, use the command:

```
NodeName# show atmf tech
```

**Table 51:** Sample output from the **show atmf tech** command.

```
node1#show atmf tech
ATMF Summary Information:

ATMF Status : Enabled
Network Name : ATMF_NET
Node Name : node1
Role : Master
Current ATMF Nodes : 8

ATMF Technical information:

Network Name : ATMF_NET
Domain : node1's domain
Node Depth : 0
Domain Flags : 0
Authentication Type : 0
MAC Address : 0014.2299.137d
Board ID : 287
Domain State : DomainController
Domain Controller : node1
Backup Domain Controller : node2
Domain controller MAC : 0014.2299.137d
Parent Domain : -
Parent Domain Controller : -
Parent Domain Controller MAC : 0000.0000.0000
Number of Domain Events : 0
Crosslink Ports Blocking : 0
Uplink Ports Waiting on Sync : 0
```

**Table 51:** Sample output from the **show atmf tech** command. (cont.)

|                                   |         |
|-----------------------------------|---------|
| Crosslink Sequence Number         | : 7     |
| Domains Sequence Number           | : 28    |
| Uplink Sequence Number            | : 2     |
| Number of Crosslink Ports         | : 1     |
| Number of Domain Nodes            | : 2     |
| Number of Neighbors               | : 5     |
| Number of Non Broadcast Neighbors | : 3     |
| Number of Link State Entries      | : 1     |
| Number of Up Uplinks              | : 0     |
| Number of Up Uplinks on This Node | : 0     |
| DBE Checksum                      | : 84fc6 |
| Number of DBE Entries             | : 0     |
| ...                               |         |

**Table 52:** Parameter definitions from the **show atmf tech** command

| Parameter          | Definition                                                                                                                                                                                                                                                                                                                                                                                           |
|--------------------|------------------------------------------------------------------------------------------------------------------------------------------------------------------------------------------------------------------------------------------------------------------------------------------------------------------------------------------------------------------------------------------------------|
| ATMF Status        | Shows status of AMF feature on the Node as Enabled/Disabled.                                                                                                                                                                                                                                                                                                                                         |
| Network Name       | The name of the AMF network to which this node belongs.                                                                                                                                                                                                                                                                                                                                              |
| Node Name          | The name assigned to the node within the AMF network.                                                                                                                                                                                                                                                                                                                                                |
| Role               | The role configured on the device within the AMF - either master or member.                                                                                                                                                                                                                                                                                                                          |
| Current ATMF Nodes | A count of the AMF nodes in the AMF network.                                                                                                                                                                                                                                                                                                                                                         |
| Node Address       | The identity of a node (in the format name.atmf) that enables its access it from a remote location.                                                                                                                                                                                                                                                                                                  |
| Node ID            | A unique identifier assigned to an AMF node.                                                                                                                                                                                                                                                                                                                                                         |
| Node Depth         | The number of nodes in the path from this node to the core domain.                                                                                                                                                                                                                                                                                                                                   |
| Domain State       | A node's state within an AMF Domain - either controller or backup.                                                                                                                                                                                                                                                                                                                                   |
| Recovery State     | The AMF node recovery status. Indicates whether a node recovery is in progress on this device - either Auto, Manual, or None.                                                                                                                                                                                                                                                                        |
| Management VLAN    | The VLAN created for traffic between nodes of different domains (up/down links).<br>VLAN ID - In this example VLAN 4092 is configured as the Management VLAN.<br>Management Subnet - the Network prefix for the subnet.<br>Management IP Address - the IP address allocated for this traffic.<br>Management Mask - the Netmask used to create a subnet for this traffic 255.255.128.0 (= prefix /17) |

**Table 52:** Parameter definitions from the **show atmf tech** command (cont.)

| Parameter   | Definition                                                                                                                                                                                                                                                                                                                                                                            |
|-------------|---------------------------------------------------------------------------------------------------------------------------------------------------------------------------------------------------------------------------------------------------------------------------------------------------------------------------------------------------------------------------------------|
| Domain VLAN | The VLAN assigned for traffic between Nodes of same domain (crosslink).<br>VLAN ID - In this example VLAN 4091 is configured as the domain VLAN.<br>Domain Subnet - the Subnet address used for this traffic.<br>Domain IP Address - the IP address allocated for this traffic.<br>Domain Mask - the Netmask used to create a subnet for this traffic 255.255.128.0<br>(= prefix /17) |
| Device Type | Shows the Product Series Name.                                                                                                                                                                                                                                                                                                                                                        |
| ATMF Master | Indicates the node's membership of the core domain (membership is indicated by Y)                                                                                                                                                                                                                                                                                                     |
| SC          | Shows switch configuration: <ul style="list-style-type: none"><li>• C - Chassis (such as SBx8100 series)</li><li>• S - Stackable (VCS)</li><li>• N - Standalone</li></ul>                                                                                                                                                                                                             |
| Parent      | A node that is connected to the present node's uplink, i.e. one layer higher in the hierarchy.                                                                                                                                                                                                                                                                                        |
| Node Depth  | Shows the number of nodes in path from the current node to the Core domain.                                                                                                                                                                                                                                                                                                           |

**NOTE:** The **show atmf tech** command can produce very large output. For this reason only the most significant terms are defined in this table.

# show atmf virtual-links

**Overview** This command displays a summary of all virtual links (L2TP tunnels) currently in the running configuration.

**Syntax** `show atmf virtual-links [macaddr]`

| Parameter | Description                                   |
|-----------|-----------------------------------------------|
| macaddr   | Display the virtual AMF links' MAC addresses. |

**Mode** Privileged Exec

**Example 1** To display AMF virtual links, use the command:

```
node_1# show atmf virtual-links
```

Table 50-1: Example output from **show atmf virtual-links**

```
ATMF Link Remote Information:
```

| Local Port | Local Ip   | Local Id | Remote Ip   | Remote Id | Retries | State |
|------------|------------|----------|-------------|-----------|---------|-------|
| vlink1     | 192.0.2.33 | 1        | 192.168.1.1 | 2         | 0       | Down  |
| vlink2     | 192.0.2.65 | 2        | 192.168.2.0 | 3         | 0       | Up    |

In the above example, a centrally located switch has the IP address space 192.0.2.x/24. It has two VLANs assigned the subnets 192.0.2.33 and 192.0.2.65 using the prefix /27. Each subnet connects to a virtual link. The first link has the IP address 192.168.1.1 and has a Local ID of 1. The second has the IP address 192.168.2.1 and has the Local ID of 2.

**Example 2** To display AMF virtual links' MAC address information, use the command:

```
node_1# show atmf virtual-links macaddr
```

Table 50-2: Example output from **show atmf virtual-links macaddr**

```
ATMF Link Remote Information:
```

```
ATMF Management Bridge Information:
```

```
Bridge: br-atmfmgmt
```

| port no | mac addr          | is local? | ageing timer |
|---------|-------------------|-----------|--------------|
| 1       | 00:00:cd:27:c2:07 | yes       | 0.00         |
| 2       | 8e:c7:ae:81:7e:68 | yes       | 0.00         |
| 2       | 00:00:cd:28:bf:e7 | no        | 0.01         |

Table 50-3: Parameters in the output from **show atmf virtual-links**

| Parameter    | Definition                                                                                                                                 |
|--------------|--------------------------------------------------------------------------------------------------------------------------------------------|
| vlink1       | The tunnel named vlink1, equivalent to an L2TP tunnel.                                                                                     |
| Local ID     | The local ID of the virtual link. This matches the vlink<number>                                                                           |
| State        | The operational state of the vlink (either Up or Down). This state is always displayed once a vlink has been created.                      |
| mac addr     | AMF virtual links terminate on an internal soft bridge. The “show atmf virtual-links macaddress” command displays MAC Address information. |
| is local?    | Indicates whether the MAC displayed is for a local or a remote device.                                                                     |
| ageing timer | Indicates the current aging state for each MAC address.                                                                                    |

**Related Commands** [atmf virtual-link](#)

# show atmf working-set

**Overview** This command displays the nodes that form the current AMF working-set.

**Syntax** `show atmf working-set`

**Mode** Privileged Exec

**Example** To show current members of the working-set, use the command:

```
ATMF_NETWORK[6]# show atmf working-set
```

**Table 51:** Sample output from the **show atmf working-set** command.

```
ATMF Working Set Nodes:
node1, node2, node3, node4, node5, node6
Working set contains 6 nodes
```

**Related Commands**

- [atmf working-set](#)
- [show atmf](#)
- [show atmf group](#)

# show debugging atmf

**Overview** This command shows the debugging modes status for AMF.

**Syntax** `show debugging atmf`

**Mode** User Exec and Global Configuration

**Example** To display the AMF debugging status, use the command:

```
node_1# show debugging atmf
```

Figure 50-35: Sample output from the **show debugging atmf** command.

Table 50-1:

```
node1# show debugging atmf
ATMF debugging status:
ATMF arealink debugging is on
ATMF link debugging is on
ATMF crosslink debugging is on
ATMF database debugging is on
ATMF neighbor debugging is on
ATMF packet debugging is on
ATMF error debugging is on
```

**Related Commands** [debug atmf packet](#)



# show debugging atmf packet

**Overview** This command shows details of AMF Packet debug command settings.

**Syntax** show debugging atmf packet

**Mode** User Exec and Global Configuration

**Example** To display the AMF packet debugging status, use the command:

```
node_1# show debug atmf packet
```

Figure 50-36: Sample output from the **show debugging atmf packet** command.

Table 50-2:

```
ATMF packet debugging is on
=== ATMF Packet Debugging Parameters===
Node Name: x908
Port name: port1.1.1
Limit: 500 packets
Direction: TX
Info Level: Level 2
Packet Type Bitmap:
2. Crosslink Hello BPDU pkt with downlink domain info
3. Crosslink Hello BPDU pkt with uplink info
4. Down and up link Hello BPDU pkts
6. Stack hello unicast pkts
8. DBE request
9. DBE update
10. DBE bitmap update
```

**Related Commands** [debug atmf](#)  
[debug atmf packet](#)

# show running-config atmf

**Overview** This command displays the running system information that is specific to AMF.

**Syntax** `show running-config atmf`

**Mode** User Exec and Global Configuration

**Example** To display the current configuration of AMF, use the following commands:

```
node_1# show running-config atmf
```

For information on filtering and saving command output, see the [“Getting Started with AlliedWare Plus” Feature Overview and Configuration Guide](#).

**Related Commands** `show running-config`  
`no debug all`

# state

**Overview** This command sets the running state of an AMF container on a Virtual AMF Appliance (VAA).

An AMF container is an isolated instance of AlliedWare Plus with its own network interfaces, configuration, and file system. The features available inside an AMF container are a sub-set of the features available on the host VAA. These features enable the AMF container to function as a uniquely identifiable AMF master and allows for multiple tenants (up to 60) to run on a single VAA host. See the [AMF Feature Overview and Configuration Guide](#) for more information on running multiple tenants on a single VAA host.

**Syntax** `state {enable|disable}`

| Parameter | Description                                                        |
|-----------|--------------------------------------------------------------------|
| disable   | Stop the AMF container. The container's state changes to stopped.  |
| enable    | Start the AMF container. The container's state changes to running. |

**Default** By default, **state** is disabled.

**Mode** AMF Container Configuration

**Usage** The first time the **state enable** command is executed on a container it assigns the container to an area and configures it as an AMF master. This is achieved by automatically adding the following configuration to the AMF container:

```
atmf network-name <AMF network-name>
atmf master
atmf area <container area-name> <container area-id> local
atmf area <container area-name> password <container area-password>
atmf area <host area-name> <host area-id>

interface eth0
 atmf-arealink remote-area <host area-name> vlan 4094
```

For this reason the **state enable** command should be run after the container has been created with the [atmf container](#) command and an area-link configured with the [area-link](#) command.

Once the start-up configuration has been saved from within the AMF container, all further configuration changes need to be made manually.

**Example** To start the AMF container “vac-wlg-1” use the commands:

```
awplus# configure terminal
awplus(config)# atmf container vac-wlg-1
awplus(config-atmf-container)# state enable
```

To stop the AMF container “vac-wlg-1” use the commands:

```
awplus# configure terminal
awplus(config)# atmf container vac-wlg-1
awplus(config-atmf-container)# state disable
```

**Related  
Commands** [atmf container](#)  
[show atmf container](#)

**Command  
changes** Version 5.4.7-0.1: command added

# switchport atmf-agentlink

**Overview** Use this command to configure a link between this device and an x600 Series switch, in order to integrate the x600 Series switch into your AMF network. The x600 Series switch is called an “AMF agent”, and the link between the x600 and this device is called an “agent link”.

The x600 Series switch must be running version 5.4.2-3.16 or later.

Use the **no** variant of this command to remove the agent link. If the x600 Series switch is still connected to the switch port, it will no longer be part of the AMF network.

**Syntax** `switchport atmf-agentlink`  
`no switchport atmf-agentlink`

**Default** By default, no agent links exist and x600 Series switches are not visible to AMF networks.

**Mode** Interface mode for a switch port. Note that the link between the x600 and the AMF network must be a single link, not an aggregated link.

**Usage** The x600 Series switch provides the following information to the AMF node that it is connected to:

- The MAC address
- The IPv4 address
- The IPv6 address
- The name/type of the device (Allied Telesis x600)
- The name of the current firmware
- The version of the current firmware
- The configuration name

AMF guestnode also makes most of this information available from x600 Series switches, but requires configuration with DHCP and/or LLDP. AMF agent is simpler; as soon the x600 is connected to an appropriately configured port of an AMF node, it is immediately integrated into the AMF network.

To see information about the x600 Series switch, use the **show atmf links guest detail** command.

**Example** To configure port 1.0.1 as an agent link, use the commands:

```
awplus# configure terminal
awplus(config)# interface port1.0.1
awplus(config-if)# switchport atmf-agentlink
```

**Related Commands** [show atmf links guest](#)

# switchport atmf-arealink remote-area

**Overview** This command enables you to configure a port or aggregator to be an AMF arealink. AMF arealinks are designed to operate between two nodes in different areas in an AMF network.

Use the **no** variant of this command to remove any AMF-arealink that may exist for the selected port or aggregated link.

This command is only available on AMF controllers and master nodes.

**Syntax** `switchport atmf-arealink remote-area <area-name> vlan <2-4094>`  
`no switchport atmf-arealink`

| Parameter   | Description                                                                                                                          |
|-------------|--------------------------------------------------------------------------------------------------------------------------------------|
| <area-name> | The name of the remote area that the port is connecting to.                                                                          |
| <2-4094>    | The VLAN ID for the link. This VLAN cannot be used for any other purpose, and the same VLAN ID must be used at each end of the link. |

**Default** By default, no arealinks are configured

**Mode** Interface Configuration for a switchport, a static aggregator or a dynamic channel group.

**Usage** Run this command on the port or aggregator at both ends of the link.

Each area must have the area-name configured, and the same area password must exist on both ends of the link.

Running this command will automatically place the port or static aggregator into trunk mode (i.e. switchport mode trunk) and will synchronize the area information stored on the two nodes.

You can configure multiple arealinks between two area nodes, but only one arealink at any time will be in use. All other arealinks will block information, to prevent network storms.

**Example** To make a switchport 1.2.1 an arealink to the *Auckland* area on VLAN 6, use the following commands

```
controller-1# configure terminal
controller-1(config)# interface port1.2.1
controller-1(config-if)# switchport atmf-arealink remote-area
Auckland vlan 6
```

**Related  
Commands**    [atmf area](#)  
                  [atmf area password](#)  
                  [atmf virtual-link](#)  
                  [show atmf links](#)

# switchport atmf-crosslink

**Overview** This command configures the selected port, statically aggregated link or dynamic channel group (LACP) to be an AMF crosslink. Running this command will automatically place the port or aggregator into trunk mode (i.e. **switchport mode trunk**).

The connection between two AMF masters must utilize a crosslink. Crosslinks are used to carry the AMF control information between master nodes. Multiple crosslinks can be configured between two master nodes, but only one crosslink can be active at any particular time. All other crosslinks between masters will be placed in the blocking state, in order to prevent broadcast storms.

Use the **no** variant of this command to remove any crosslink that may exist for the selected port or aggregated link.

**Syntax** `switchport atmf-crosslink`  
`no switchport atmf-crosslink`

**Mode** Interface Configuration for a switchport, a static aggregator or a dynamic channel group.

**Usage** Crosslinks can be used anywhere within an AMF network. They have the effect of separating the AMF network into separate domains.

Where this command is used, it is also good practice to use the [switchport trunk native vlan](#) command with the parameter **none** selected. This is to prevent a network storm on a topology of ring connected devices.

**Example 1** To make a switchport 1.0.1 an AMF crosslink, use the following commands:

```
Node_1# configure terminal
Node_1(config)# interface port1.0.1
Node_1(config-if)# switchport atmf-crosslink
```

**Example 2** This example is shown twice. Example 2A is the most basic command sequence. Example 2B is a good practice equivalent that avoids problems such as broadcast storms that can otherwise occur.

**Example 2A** To make static aggregator sa1 an AMF crosslink, use the following commands:

```
Node_1# configure terminal
Node_1(config)# interface sa1
Node_1(config-if)# switchport atmf-crosslink
```



**Example 2B** To make static aggregator sa1 an AMF crosslink, use the following commands for good practice:

```
Node_1# configure terminal
Node_1(config)# interface sa1
Node_1(config-if)# switchport atmf-crosslink
Node_1(config-if)# switchport trunk allowed vlan add 2
Node_1(config-if)# switchport trunk native vlan none
```

In this example VLAN 2 is assigned to the static aggregator, and the native VLAN (VLAN 1) is explicitly excluded from the aggregated ports and the crosslink assigned to it.

**NOTE:** *The AMF management and domain VLANs are automatically added to the aggregator and the crosslink.*

**Related Commands** [show atmf links statistics](#)

# switchport atmf-guestlink

**Overview** Guest links are used to provide basic AMF functionality to non AMF capable devices. Guest links can be configured for either a selected switch port or a range of switch ports and use generic protocols to collect status and configuration information that the guest devices make available.

Use the **no** variant of this command to remove the guest node functionality from the selected port or ports.

**Syntax** `switchport atmf-guestlink [class <GUEST-CLASS>] [ip <A.B.C.D> | ipv6 <X:X::X:X>]`

`no switchport atmf-guestlink`

| Parameter     | Description                                                   |
|---------------|---------------------------------------------------------------|
| class         | Set a Guest-class                                             |
| <GUEST-CLASS> | The name of the guest class.                                  |
| ip            | Specifies that the address following will have an IPv4 format |
| <A.B.C.D>     | The Guest-node's IP address in IPv4 format.                   |
| ipv6          | Specifies that the address following will have an IPv6 format |
| <X:X::X:X>    | The Guest-node's IP address in IPv6 format.                   |

**Default** No guest links are configured.

**Mode** Interface

**Example 1** To configure switch port 1.0.44 to be a guest link, that will connect to a guest node having a guest-class of **camera** and an IPv4 address of **192.168.3.3**, use the following commands:

```
node1# configure terminal
node1(config)# int port1.0.44
node1(config-if)# switchport atmf-guestlink class camera ip
192.168.3.3
node1(config-if)# end
```

**Example 2** To configure switchport 1.0.41 to be a guest link, that will connect to a guest node having a guest-class of **phone** and an IPv6 address of **2001:db8:21e:10d::5**, use the following commands:

```
node1# configure terminal
node1(config)# int port1.0.41
node1(config-if)# switchport atmf-guestlink class phone ipv6
2000:db8:21e:10d::5
node1(config-if)# end
```

**Example 3** To configure switch port 1.0.41 to be a guest link, using the default model type and learning method address, use the following commands:

```
node1# configure terminal
node1(config)# int port1.0.41
node1(config-if)# switchport atmf-guestlink
node1(config-if)# end
```

**Example 4** To configure switch ports 1.0.52 to 1.0.54 to be guest links, for the guest class **camera**, use the following commands:

```
node1# configure terminal
node1(config)# int port1.0.41-port1.0.44
node1(config-if)# switchport atmf-guestlink class camera
node1(config-if)# end
```

**Example 5** To remove the guest-link functionality from switchport 1.0.41, use the following commands:

```
node1# configure terminal
node1(config)# int port1.0.41
node1(config-if)# no switchport atmf-guestlink
node1(config-if)# end
```

**Related Commands**

- [atmf guest-class](#)
- [discovery](#)
- [http-enable](#)
- [username](#)
- [modeltype](#)
- [show atmf links guest](#)
- [show atmf guests](#)

# switchport atmf-link

**Overview** This command enables you to configure a port or aggregator to be an AMF up/down link. Running this command will automatically place the port or aggregator into trunk mode.

Use the **no** variant of this command to remove any AMF-link that may exist for the selected port or aggregated link.

**Syntax** `switchport atmf-link`  
`no switchport atmf-link`

**Mode** Interface Configuration for a switchport, a static aggregator or a dynamic channel group.

**Usage** Up/down links and virtual links interconnect domains in a vertical hierarchy, with the highest domain being the core domain. In effect, they form a tree of interconnected AMF domains. This tree must be loop-free. Therefore, you must configure your links so that no rings are formed only from up/down links and/or virtual links.

Within each domain, cross-links between AMF nodes define those nodes as siblings within the same domain. You can form rings by combining cross-links with up/down links and/or virtual links, as long as each AMF domain links upwards to only a single parent domain. Each domain may link downwards to multiple child domains.

For AMF links, we recommend not using VCStack ports that are configured as network ports. During AMF recovery, these ports revert to their default state of being VCStack ports, so AMF cannot use them for auto-recovery. We recommend using standard network ports instead of VCStack ports for AMF links, so you can take advantage of AMF recovery.

**Example** To make a switchport 1.0.1 an AMF up/down link, use the following commands:

```
Node_1# configure terminal
Node_1(config)# interface port1.0.1
Node_1(config-if)# switchport atmf-link
```

# type atmf node

**Overview** This command configures a trigger to be activated at an AMF node join event or leave event.

**Syntax** `type atmf node {join|leave}`

| Parameter | Description           |
|-----------|-----------------------|
| join      | AMF node join event.  |
| leave     | AMF node leave event. |

**Mode** Trigger Configuration

**CAUTION:** Only configure this trigger on one device because it is a network wide event.

**Example 1** To configure trigger 5 to activate at an AMF node leave event, use the following commands. In this example the command is entered on node-1:

```
node1(config)# trigger 5
node1(config-trigger) type atmf node leave
```

**Example 2** The following commands will configure trigger 5 to activate if an AMF node join event occurs on any node within the working set:

```
node1# atmf working-set group all
```

This command returns the following display:

```
=====
node1, node2, node3:
=====

Working set join
```

Note that the running the above command changes the prompt from the name of the local node, to the name of the AMF-Network followed, in square brackets, by the number of member nodes in the working set.

```
AMF-Net[3]# conf t
AMF-Net[3](config)# trigger 5
AMF-Net[3](config-trigger)# type atmf node leave
AMF-Net[3](config-trigger)# description "E-mail on AMF Exit"
AMF-Net[3](config-trigger)# active
```

Enter the name of the script to run at the trigger event.

```
AMF-Net[3](config-trigger)# script 1 email_me.scp
AMF-Net[3](config-trigger)# end
```

### Display the trigger configurations

AMF-Net[3]# show trigger

This command returns the following display:

```
=====
node1:
=====

TR# Type & Details Description Ac Te Tr Repeat #Scr Days/Date

001 Periodic (2 min) Periodic Status Chk Y N Y Continuous 1 smtwtfS
005 ATMF node (leave) E-mail on ATMF Exit Y N Y Continuous 1 smtwtfS

=====
Node2, Node3,
=====

TR# Type & Details Description Ac Te Tr Repeat #Scr Days/Date

005 ATMF node (leave) E-mail on ATMF Exit Y N Y Continuous 1 smtwtfS

```

### Display the triggers configured on each of the nodes in the AMF Network.

AMF-Net[3]# show running-config trigger

This command returns the following display:

```
=====
Node1:
=====

trigger 1
 type periodic 2
 script 1 atmf.scp
trigger 5
 type atmf node leave
 description "E-mail on ATMF Exit"
 script 1 email_me.scp
!

=====
Node2, Node3:
=====

trigger 5
 type atmf node leave
 description "E-mail on ATMF Exit"
 script 1 email_me.scp
!
```

**Related  
Commands** [show trigger](#)

# undebbug atmf

**Overview** This command is an alias for the **no** variant of the [debug atmf](#) command.



# username

**Overview** This command enables you to assign a **username** to a guest class. Guests may require a username and possibly also a password. In its non-encrypted form the password must be between 1 and 32 characters and will allow spaces. In its encrypted form the password must be between 1 to 64 characters and will allow any character

**Syntax** `username <NAME> password [8] <USERPASS>`  
`no username`

| Parameter  | Description                                                                                                                                                                                          |
|------------|------------------------------------------------------------------------------------------------------------------------------------------------------------------------------------------------------|
| username   | Indicates that a user name is to follow                                                                                                                                                              |
| <NAME>     | User name of the guest node                                                                                                                                                                          |
| password   | Indicates that a password (or specifier) is to follow.                                                                                                                                               |
| 8          | Specifier indicating that the following password is encrypted. It's primary purpose is to differentiate between the configuration input and the CLI input. You should not specify this for CLI input |
| <USERPASS> | The password to be entered for the guest node.                                                                                                                                                       |

**Default** No usernames configured

**Mode** AMF Guest Configuration Mode

**Example 1** To assign the user name **reception** and the password of **secret** to an AMF guest node that has the guest class of **phone1** use the following commands:

```
node1# conf t
node1(config)# amf guest-class phone1
node1(config-atmf-guest)# username reception password secret
node1(config-atmf-guest)# end
```

**Example 2** To remove a guest node username and password for the user guest class **phone1**, use the following commands:

```
node1# conf t
node1(config)# atmf guest-class phone1
node1(config-atmf-guest)# no username
node1(config-atmf-guest)# end
```

**Related Commands** [show atmf links detail](#)  
[atmf guest-class](#)  
[switchport atmf-guestlink](#)

show atmf links guest

show atmf nodes

# 51

# Dynamic Host Configuration Protocol (DHCP) Commands

## Introduction

**Overview** This chapter provides an alphabetical reference for commands used to configure DHCP.

Note that the DHCP client does not support tunnel interfaces.

For more information, see the [DHCP Feature Overview and Configuration Guide](#), which is available at the above link on alliedtelesis.com.

For information on filtering and saving command output, see the [“Getting Started with AlliedWare Plus” Feature Overview and Configuration Guide](#). This guide is available at the above link on alliedtelesis.com.

- Command List**
- [“bootfile”](#) on page 2333
  - [“clear ip dhcp binding”](#) on page 2334
  - [“default-router”](#) on page 2335
  - [“dns-server”](#) on page 2336
  - [“domain-name”](#) on page 2337
  - [“host \(DHCP\)”](#) on page 2338
  - [“ip address dhcp”](#) on page 2339
  - [“ip dhcp bootp ignore”](#) on page 2341
  - [“ip dhcp leasequery enable”](#) on page 2342
  - [“ip dhcp option”](#) on page 2343
  - [“ip dhcp pool”](#) on page 2345
  - [“ip dhcp-client default-route distance”](#) on page 2346
  - [“ip dhcp-relay agent-option”](#) on page 2348
  - [“ip dhcp-relay agent-option checking”](#) on page 2350
  - [“ip dhcp-relay agent-option remote-id”](#) on page 2352

- [“ip dhcp-relay information policy”](#) on page 2354
- [“ip dhcp-relay maxhops”](#) on page 2356
- [“ip dhcp-relay max-message-length”](#) on page 2357
- [“ip dhcp-relay server-address”](#) on page 2359
- [“lease”](#) on page 2361
- [“network \(DHCP\)”](#) on page 2363
- [“next-server”](#) on page 2364
- [“option”](#) on page 2365
- [“probe enable”](#) on page 2367
- [“probe packets”](#) on page 2368
- [“probe timeout”](#) on page 2369
- [“probe type”](#) on page 2370
- [“range”](#) on page 2371
- [“route”](#) on page 2372
- [“service dhcp-relay”](#) on page 2373
- [“service dhcp-server”](#) on page 2374
- [“show counter dhcp-client”](#) on page 2375
- [“show counter dhcp-relay”](#) on page 2376
- [“show counter dhcp-server”](#) on page 2380
- [“show dhcp lease”](#) on page 2382
- [“show ip dhcp binding”](#) on page 2384
- [“show ip dhcp pool”](#) on page 2386
- [“show ip dhcp-relay”](#) on page 2390
- [“show ip dhcp server statistics”](#) on page 2392
- [“show ip dhcp server summary”](#) on page 2394
- [“subnet-mask”](#) on page 2395

# bootfile

**Overview** This command sets the boot filename for a DHCP server pool. This is the name of the boot file that the client should use in its bootstrap process. It may need to include a path.

The **no** variant of this command removes the boot filename from a DHCP server pool.

**Syntax** bootfile <filename>  
no bootfile

| Parameter  | Description         |
|------------|---------------------|
| <filename> | The boot file name. |

**Mode** DHCP Configuration

**Example** To configure the boot filename for a pool P2, use the command:

```
awplus# configure terminal
awplus(config)# ip dhcp pool P2
awplus(dhcp-config)# bootfile boot/main_boot.bt
```

# clear ip dhcp binding

**Overview** This command clears either a specific lease binding or the lease bindings specified by the command or DHCP server. The command will only take effect on dynamically allocated bindings, not statically configured bindings.

**Syntax** `clear ip dhcp binding {ip <ip-address>|mac <mac-address>|all|pool <pool-name>|range <low-ip-address> <high-ip-address>}`

| Parameter                                                        | Description                                                                                                                                                                        |
|------------------------------------------------------------------|------------------------------------------------------------------------------------------------------------------------------------------------------------------------------------|
| <code>ip &lt;ip-address&gt;</code>                               | IPv4 address of the DHCP client, in dotted decimal notation in the format A.B.C.D.                                                                                                 |
| <code>mac &lt;mac-address&gt;</code>                             | MAC address of the DHCP client, in hexadecimal notation in the format HHHH.HHHH.HHHH.                                                                                              |
| <code>all</code>                                                 | All DHCP bindings.                                                                                                                                                                 |
| <code>pool &lt;pool-name&gt;</code>                              | Description used to identify DHCP server address pool. Valid characters are any printable character. If the name contains spaces then you must enclose these in "quotation marks". |
| <code>range&lt;low-ip-address&gt; &lt;high-ip-address&gt;</code> | IPv4 address range for DHCP clients, in dotted decimal notation. The first IP address is the low end of the range, the second IP address is the high end of the range.             |

**Mode** User Exec and Privileged Exec

**Usage** A specific binding may be deleted by **ip** address or **mac** address, or several bindings may be deleted at once using **all**, **pool** or **range**.

Note that if you specify to clear the **ip** or **mac** address of what is actually a static DHCP binding, an error message is displayed. If **all**, **pool** or **range** are specified and one or more static DHCP bindings exist within those addresses, any dynamic entries within those addresses are cleared but any static entries are not cleared.

**Examples** To clear the specific IP address binding 192.168.1.1, use the command:

```
awplus# clear ip dhcp binding ip 192.168.1.1
```

To clear all dynamic DHCP entries, use the command:

```
awplus# clear ip dhcp binding all
```

**Related Commands** [show ip dhcp binding](#)

# default-router

**Overview** This command adds a default router to the DHCP address pool you are configuring. You can use this command multiple times to create a list of default routers on the client's subnet. This sets the router details using the pre-defined option 3. Note that if you add a user-defined option 3 using the **option** command, then you will override any settings created with this command.

The **no** variant of this command removes either the specified default router, or all default routers from the DHCP pool.

**Syntax** `default-router <ip-address>`  
`no default-router [<ip-address>]`

| Parameter                       | Description                                                     |
|---------------------------------|-----------------------------------------------------------------|
| <code>&lt;ip-address&gt;</code> | IPv4 address of the default router, in dotted decimal notation. |

**Mode** DHCP Configuration

**Examples** To add a router with an IP address 192.168.1.2 to the DHCP pool named P2, use the following commands:

```
awplus# configure terminal
awplus(config)# ip dhcp pool P2
awplus(dhcp-config)# default-router 192.168.1.2
```

To remove a router with an IP address 192.168.1.2 to the DHCP pool named P2, use the following commands:

```
awplus# configure terminal
awplus(config)# ip dhcp pool P2
awplus(dhcp-config)# no default-router 192.168.1.2
```

To remove all routers from the DHCP pool named P2, use the following commands:

```
awplus# configure terminal
awplus(config)# ip dhcp pool P2
awplus(dhcp-config)# no default-router
```

# dns-server

**Overview** This command adds a Domain Name System (DNS) server to the DHCP address pool you are configuring. You can use this command multiple times to create a list of DNS name servers available to the client. This sets the DNS server details using the pre-defined option 6.

Note that if you add a user-defined option 6 using the [option](#) command, then you will override any settings created with this command.

The **no** variant of this command removes either the specified DNS server, or all DNS servers from the DHCP pool.

**Syntax** `dns-server <ip-address>`  
`no dns-server [<ip-address>]`

| Parameter                       | Description                                                 |
|---------------------------------|-------------------------------------------------------------|
| <code>&lt;ip-address&gt;</code> | IPv4 address of the DNS server, in dotted decimal notation. |

**Mode** DHCP Configuration

**Examples** To add the DNS server with the assigned IP address 192.168.1.1 to the DHCP pool named P1, use the following commands:

```
awplus# configure terminal
awplus(config)# ip dhcp pool P2
awplus(dhcp-config)# dns-server 192.168.1.1
```

To remove the DNS server with the assigned IP address 192.168.1.1 from the DHCP pool named P1, use the following commands:

```
awplus# configure terminal
awplus(config)# ip dhcp pool P2
awplus(dhcp-config)# no dns-server 192.168.1.1
```

To remove all DNS servers from the DHCP pool named P1, use the following commands:

```
awplus# configure terminal
awplus(config)# ip dhcp pool P2
awplus(dhcp-config)# no dns-server
```

**Related Commands**

- [default-router](#)
- [option](#)
- [service dhcp-server](#)
- [show ip dhcp pool](#)
- [subnet-mask](#)



# domain-name

**Overview** This command adds a domain name to the DHCP address pool you are configuring. Use this command to specify the domain name that a client should use when resolving host names using the Domain Name System. This sets the domain name details using the pre-defined option 15.

Note that if you add a user-defined option 15 using the [option](#) command, then you will override any settings created with this command.

The **no** variant of this command removes the domain name from the address pool.

**Syntax** `domain-name <domain-name>`  
`no domain-name`

| Parameter                        | Description                                                                                                                                                                |
|----------------------------------|----------------------------------------------------------------------------------------------------------------------------------------------------------------------------|
| <code>&lt;domain-name&gt;</code> | The domain name you wish to assign the DHCP pool. Valid characters are any printable character. If the name contains spaces then you must enclose it in "quotation marks". |

**Mode** DHCP Configuration

**Examples** To add the domain name `Nerv_Office` to DHCP pool `P2`, use the commands:

```
awplus# configure terminal
awplus(config)# ip dhcp pool P2
awplus(dhcp-config)# domain-name Nerv_Office
```

To remove the domain name `Nerv_Office` from DHCP pool `P2`, use the commands:

```
awplus# configure terminal
awplus(config)# ip dhcp pool P2
awplus(dhcp-config)# no domain-name Nerv_Office
```

**Related Commands**

- [default-router](#)
- [dns-server](#)
- [option](#)
- [service dhcp-server](#)
- [show ip dhcp pool](#)
- [subnet-mask](#)

# host (DHCP)

**Overview** This command adds a static host address to the DHCP address pool you are configuring. The client with the matching MAC address is permanently assigned this IP address. No other clients can request it.

The **no** variant of this command removes the specified host address from the DHCP pool. Use the **no host all** command to remove all static host addresses from the DHCP pool.

**Syntax** `host <ip-address> <mac-address>`  
`no host <ip-address>`  
`no host all`

| Parameter                        | Description                                                                          |
|----------------------------------|--------------------------------------------------------------------------------------|
| <code>&lt;ip-address&gt;</code>  | IPv4 address of the DHCP client, in dotted decimal notation in the format A.B.C.D    |
| <code>&lt;mac-address&gt;</code> | MAC address of the DHCP client, in hexadecimal notation in the format HHHH.HHHH.HHHH |

**Mode** DHCP Configuration

**Usage** Note that a network/mask must be configured using a **network** command before issuing a **host** command. Also note that a host address must match a network to add a static host address.

**Examples** To add the host at 192.168.1.5 with the MAC address 000a.451d.6e34 to DHCP pool 1, use the commands:

```
awplus# configure terminal
awplus(config)# ip dhcp pool 1
awplus(dhcp-config)# network 192.168.1.0/24
awplus(dhcp-config)# host 192.168.1.5 000a.451d.6e34
```

To remove the host at 192.168.1.5 with the MAC address 000a.451d.6e34 from DHCP pool 1, use the commands:

```
awplus# configure terminal
awplus(config)# ip dhcp pool 1
awplus(dhcp-config)# no host 192.168.1.5 000a.451d.6e34
```

**Related Commands** [lease](#)  
[range](#)  
[show ip dhcp pool](#)

# ip address dhcp

**Overview** This command activates the DHCP client on the interface you are configuring. This allows the interface to use the DHCP client to obtain its IP configuration details from a DHCP server on its connected network.

The **client-id** and **hostname** parameters are identifiers that you may want to set in order to interoperate with your existing DHCP infrastructure. If neither option is needed, then the DHCP server uses the MAC address field of the request to identify the host.

The DHCP client supports the following IP configuration options:

- Option 1 - the subnet mask for your device.
- Option 3 - a list of default routers.
- Option 6 - a list of DNS servers. This list appends the DNS servers set on your device with the [ip name-server](#) command.
- Option 15 - a domain name used to resolve host names. This option replaces the domain name set with the [ip domain-name](#) command. Your device ignores this domain name if it has a domain list set using the [ip domain-list](#) command.
- Option 51 - lease expiration time.

The **no** variant of this command stops the interface from obtaining IP configuration details from a DHCP server.

**Syntax** `ip address dhcp [client-id <interface>] [hostname <hostname>]`  
`no ip address dhcp`

| Parameter   | Description                                                                                                                                                                                                                            |
|-------------|----------------------------------------------------------------------------------------------------------------------------------------------------------------------------------------------------------------------------------------|
| <interface> | The name of the interface you are activating the DHCP client on. If you specify this, then the MAC address associated with the specified interface is sent to the DHCP server in the optional identifier field.<br>Default: no default |
| <hostname>  | The hostname for the DHCP client on this interface. Typically this name is provided by the ISP.<br>Default: no default                                                                                                                 |

**Mode** Interface Configuration for a VLAN interface or a PPP interface.

**Examples** To set the interface `vlan10` to use DHCP to obtain an IP address, use the commands:

```
awplus# configure terminal
awplus(config)# interface vlan10
awplus(config-if)# ip address dhcp
```

To stop the interface vlan10 from using DHCP to obtain its IP address, use the commands:

```
awplus# configure terminal
awplus(config)# interface vlan10
awplus(config-if)# no ip address dhcp
```

**Related Commands**

- [ip address \(IP Addressing and Protocol\)](#)
- [show ip interface](#)
- [show running-config](#)

# ip dhcp bootp ignore

**Overview** This command configures the DHCP server to ignore any BOOTP requests it receives. The DHCP server accepts BOOTP requests by default.

The **no** variant of this command configures the DHCP server to accept BOOTP requests. This is the default setting.

**Syntax** `ip dhcp bootp ignore`  
`no ip dhcp bootp ignore`

**Mode** Global Configuration

**Examples** To configure the DHCP server to ignore BOOTP requests, use the commands:

```
awplus# configure terminal
awplus(config)# ip dhcp bootp ignore
```

To configure the DHCP server to respond to BOOTP requests, use the commands:

```
awplus# configure terminal
awplus(config)# no ip dhcp bootp ignore
```

**Related Commands** [show ip dhcp server summary](#)

# ip dhcp leasequery enable

**Overview** Use this command to enable the DHCP server to respond to DHCPLEASEQUERY packets. Enabling the DHCP leasequery feature allows a DHCP Relay Agent to obtain IP address information directly from the DHCP server using DHCPLEASEQUERY messages.

Use the **no** variant of this command to disable the support of DHCPLEASEQUERY packets.

For more information, see the [DHCP Feature Overview and Configuration Guide](#).

**Syntax** ip dhcp leasequery enable  
no ip dhcp leasequery enable

**Default** DHCP leasequery support is disabled by default.

**Mode** Global Configuration

**Examples** To enable DHCP leasequery support, use the commands:

```
awplus# configure terminal
awplus(config)# ip dhcp leasequery enable
```

To disable DHCP leasequery support, use the commands:

```
awplus# configure terminal
awplus(config)# no ip dhcp leasequery enable
```

**Related Commands** [show counter dhcp-server](#)  
[show ip dhcp server statistics](#)  
[show ip dhcp server summary](#)

# ip dhcp option

**Overview** This command creates a user-defined DHCP option. Options with the same number as one of the pre-defined options override the standard option definition. The pre-defined options use the option numbers 1, 3, 6, 15, and 51.

You can use this option when configuring a DHCP pool, by using the [option](#) command.

The **no** variant of this command removes either the specified user-defined option, or removes all user-defined options. This also automatically removes the user-defined options from the associated DHCP address pools.

**Syntax** `ip dhcp option <1-254> [name <option-name>] [<option-type>]`  
`no ip dhcp option [<1-254>|<option-name>]`

| Parameter     | Description                                                                                                                                                                                                                                                                                                                                                                                                                                                                                                                                                                                                                                                                                                                                                                                                                                                                                                              |       |                      |     |                                                                                                                                                                                             |    |                                                                                                                                                                                               |         |                                |      |                                                                                                                                                                                           |
|---------------|--------------------------------------------------------------------------------------------------------------------------------------------------------------------------------------------------------------------------------------------------------------------------------------------------------------------------------------------------------------------------------------------------------------------------------------------------------------------------------------------------------------------------------------------------------------------------------------------------------------------------------------------------------------------------------------------------------------------------------------------------------------------------------------------------------------------------------------------------------------------------------------------------------------------------|-------|----------------------|-----|---------------------------------------------------------------------------------------------------------------------------------------------------------------------------------------------|----|-----------------------------------------------------------------------------------------------------------------------------------------------------------------------------------------------|---------|--------------------------------|------|-------------------------------------------------------------------------------------------------------------------------------------------------------------------------------------------|
| <1-254>       | The option number of the option. Options with the same number as one of the standard options overrides the standard option definition.                                                                                                                                                                                                                                                                                                                                                                                                                                                                                                                                                                                                                                                                                                                                                                                   |       |                      |     |                                                                                                                                                                                             |    |                                                                                                                                                                                               |         |                                |      |                                                                                                                                                                                           |
| <option-name> | Option name used to identify the option. You cannot use a number as the option name. Valid characters are any printable character. If the name contains spaces then you must enclose it in "quotation marks".<br>Default: no default                                                                                                                                                                                                                                                                                                                                                                                                                                                                                                                                                                                                                                                                                     |       |                      |     |                                                                                                                                                                                             |    |                                                                                                                                                                                               |         |                                |      |                                                                                                                                                                                           |
| <option-type> | The option value. You must specify a value that is appropriate to the option type: <table border="1"><tbody><tr><td>ascii</td><td>An ASCII text string</td></tr><tr><td>hex</td><td>A hexadecimal string. Valid characters are the numbers 0–9 and letters a–f. Embedded spaces are not valid. The string must be an even number of characters, from 2 and 256 characters long.</td></tr><tr><td>ip</td><td>An IPv4 address or mask that has the dotted decimal A.B.C.D notation. To create a list of IP addresses, you must add each IP address individually by using the option command multiple times.</td></tr><tr><td>integer</td><td>A number from 0 to 4294967295.</td></tr><tr><td>flag</td><td>A value that either sets (to 1) or unsets (to 0) a flag: <b>true</b>, <b>on</b>, or <b>enabled</b> will set the flag. <b>false</b>, <b>off</b> or <b>disabled</b> will unset the flag.</td></tr></tbody></table> | ascii | An ASCII text string | hex | A hexadecimal string. Valid characters are the numbers 0–9 and letters a–f. Embedded spaces are not valid. The string must be an even number of characters, from 2 and 256 characters long. | ip | An IPv4 address or mask that has the dotted decimal A.B.C.D notation. To create a list of IP addresses, you must add each IP address individually by using the option command multiple times. | integer | A number from 0 to 4294967295. | flag | A value that either sets (to 1) or unsets (to 0) a flag: <b>true</b> , <b>on</b> , or <b>enabled</b> will set the flag. <b>false</b> , <b>off</b> or <b>disabled</b> will unset the flag. |
| ascii         | An ASCII text string                                                                                                                                                                                                                                                                                                                                                                                                                                                                                                                                                                                                                                                                                                                                                                                                                                                                                                     |       |                      |     |                                                                                                                                                                                             |    |                                                                                                                                                                                               |         |                                |      |                                                                                                                                                                                           |
| hex           | A hexadecimal string. Valid characters are the numbers 0–9 and letters a–f. Embedded spaces are not valid. The string must be an even number of characters, from 2 and 256 characters long.                                                                                                                                                                                                                                                                                                                                                                                                                                                                                                                                                                                                                                                                                                                              |       |                      |     |                                                                                                                                                                                             |    |                                                                                                                                                                                               |         |                                |      |                                                                                                                                                                                           |
| ip            | An IPv4 address or mask that has the dotted decimal A.B.C.D notation. To create a list of IP addresses, you must add each IP address individually by using the option command multiple times.                                                                                                                                                                                                                                                                                                                                                                                                                                                                                                                                                                                                                                                                                                                            |       |                      |     |                                                                                                                                                                                             |    |                                                                                                                                                                                               |         |                                |      |                                                                                                                                                                                           |
| integer       | A number from 0 to 4294967295.                                                                                                                                                                                                                                                                                                                                                                                                                                                                                                                                                                                                                                                                                                                                                                                                                                                                                           |       |                      |     |                                                                                                                                                                                             |    |                                                                                                                                                                                               |         |                                |      |                                                                                                                                                                                           |
| flag          | A value that either sets (to 1) or unsets (to 0) a flag: <b>true</b> , <b>on</b> , or <b>enabled</b> will set the flag. <b>false</b> , <b>off</b> or <b>disabled</b> will unset the flag.                                                                                                                                                                                                                                                                                                                                                                                                                                                                                                                                                                                                                                                                                                                                |       |                      |     |                                                                                                                                                                                             |    |                                                                                                                                                                                               |         |                                |      |                                                                                                                                                                                           |

**Mode** Global Configuration

**Examples** To define a user-defined ASCII string option as option 66, without a name, use the command:

```
awplus# configure terminal
awplus(config)# ip dhcp option 66 ascii
```

To define a user-defined hexadecimal string option as option 46, with the name "tcpip-node-type", use the commands:

```
awplus# configure terminal
awplus(config)# ip dhcp option 46 name tcpip-node-type hex
```

To define a user-defined IP address option as option 175, with the name special-address, use the commands:

```
awplus# configure terminal
awplus(config)# ip dhcp option 175 name special-address ip
```

To remove the specific user-defined option with the option number 12, use the commands:

```
awplus# configure terminal
awplus(config)# no ip dhcp option 12
```

To remove the specific user-defined option with the option name perform-router-discovery, use the commands:

```
awplus# configure terminal
awplus(config)# no ip dhcp option perform-router-discovery
```

To remove all user-defined option definitions, use the commands:

```
awplus# configure terminal
awplus(config)# no ip dhcp option
```

**Related  
Commands**

[default-router](#)  
[dns-server](#)  
[domain-name](#)  
[option](#)  
[service dhcp-server](#)  
[show ip dhcp server summary](#)  
[subnet-mask](#)



# ip dhcp pool

**Overview** This command will enter the configuration mode for the pool name specified. If the name specified is not associated with an existing pool, the device will create a new pool with this name, then enter the configuration mode for the new pool.

Once you have entered the DHCP configuration mode, all commands executed before the next **exit** command will apply to this pool.

You can create multiple DHCP pools on devices with multiple interfaces. This allows the device to act as a DHCP server on multiple interfaces to distribute different information to clients on the different networks.

The **no** variant of this command deletes the specific DHCP pool.

**Syntax** `ip dhcp pool <pool-name>`  
`no ip dhcp pool <pool-name>`

| Parameter                      | Description                                                                                                                                                           |
|--------------------------------|-----------------------------------------------------------------------------------------------------------------------------------------------------------------------|
| <code>&lt;pool-name&gt;</code> | Description used to identify this DHCP pool. Valid characters are any printable character. If the name contains spaces then you must enclose it in "quotation marks". |

**Mode** Global Configuration

**Example** To create the DHCP pool named P2 and enter DHCP Configuration mode, use the commands:

```
awplus# configure terminal
awplus(config)# ip dhcp pool P2
awplus(dhcp-config)#
```

To delete the DHCP pool named P2, use the commands:

```
awplus# configure terminal
awplus(config)# no ip dhcp pool P2
```

**Related Commands** [service dhcp-server](#)

# ip dhcp-client default-route distance

**Overview** Use this command to specify an alternative Administrative Distance (AD) for the current default route (from DHCP) for an interface.

Use the **no** variant of this command to set the AD back to the default of 1.

**Syntax** `ip dhcp-client default-route distance [<1-255>]`  
`no ip dhcp-client default-route distance`

| Parameter | Description                                               |
|-----------|-----------------------------------------------------------|
| <1-255>   | Administrative Distance (AD) from the range 1 though 255. |

**Default** 1

**Mode** Interface Configuration

**Usage** DHCP client interfaces can automatically add a default route with an AD of 1 into the IP Routing Information Base (RIB).

Any pre-existing default route(s) via alternative interfaces (configured with a higher AD) will no longer be selected as the preferred forwarding path for traffic when the DHCP based default route is added to the IP routing table.

This can be problematic if the DHCP client is operating via an interface that is only intended to be used for back-up interface redundancy purposes, such as a VLAN containing a single switchport, or a 4G cellular interface on an AR-Series Firewall.

Use this command to set the AD of the default route (via a specific DHCP client interface) to a non-default (higher cost) value, ensuring any pre-existing default route(s) via any other interface(s) continue to be selected as the preferred forwarding path for network traffic.

When the command is used, the static default route is deleted from the RIB, the distance value of the route is modified to the configured distance value, then it is reinstalled into the RIB.

**Examples** To set the AD for the default route added by DHCP via cellular interface wwan0 to 150, use the commands:

```
awplus# configure terminal
awplus(config)# interface wwan0
awplus(config-if)# ip dhcp-client default-route distance 150
```

To set the AD for the default route back to the default value of 1, use the commands:

```
awplus# configure terminal
awplus(config)# interface wwan0
awplus(config-if)# no ip dhcp-client default-route distance
```

**Related  
Commands** [show ip route](#)  
[show ip route database](#)

**Command  
changes** Version 5.4.7-0.2 Command added.

# ip dhcp-relay agent-option

**Overview** This command enables the DHCP Relay Agent to insert the DHCP Relay Agent Information Option (Option 82) into the client-request packets that it relays to its DHCP server. This allows the DHCP Relay Agent to pass on information to the server about the network location of the client device. The DHCP Relay Agent strips the DHCP Relay Agent Option 82 field out of the DHCP server's response, so that the DHCP client never sees this field.

When the DHCP Relay Agent appends its DHCP Relay Agent Option 82 data into the packet, it first overwrites any pad options present; then if necessary, it increases the packet length to accommodate the DHCP Relay Agent Option 82 data.

The **no** variant of this command stops the DHCP Relay Agent from appending the Option 82 field onto DHCP requests before forwarding it to the server.

For DHCP Relay Agent and DHCP Relay Agent Option 82 introductory information, see the [DHCP Feature Overview and Configuration Guide](#).

**NOTE:** *The DHCP-relay service might alter the content of the DHCP Relay Agent Option 82 field, if the commands [ip dhcp-relay agent-option](#) and [ip dhcp-relay information policy](#) have been configured.*

**Syntax**

```
ip dhcp-relay agent-option
no ip dhcp-relay agent-option
```

**Default** DHCP Relay Agent Information Option (Option 82) insertion is disabled by default.

**Mode** Interface Configuration for a VLAN interface or a PPP interface.

**Usage** Use this command to alter the DHCP Relay Agent Option 82 setting when your device is the first hop for the DHCP client. To limit the maximum length of the packet, use the [ip dhcp-relay max-message-length](#) command.

**Examples** To make the DHCP Relay Agent listening on `vlan15` append the DHCP Relay Agent Option 82 field, use the commands:

```
awplus# configure terminal
awplus(config)# interface vlan15
awplus(config-if)# ip dhcp-relay agent-option
```

To stop the DHCP Relay Agent from appending the DHCP Relay Agent Option 82 field on `vlan15`, use the commands:

```
awplus# configure terminal
awplus(config)# interface vlan15
awplus(config-if)# no ip dhcp-relay agent-option
```

To make the relay agent listening on PPP interface `ppp0` append the DHCP Relay Agent Option 82 field, use the commands:

```
awplus# configure terminal
awplus(config)# interface ppp0
awplus(config-if)# ip dhcp-relay agent-option
```

To stop the relay agent from appending the DHCP Relay Agent Option 82 field on PPP interface `ppp0`, use the commands:

```
awplus# configure terminal
awplus(config)# interface ppp0
awplus(config-if)# no ip dhcp-relay agent-option
```

**Related Commands**

- [ip dhcp-relay agent-option remote-id](#)
- [ip dhcp-relay information policy](#)
- [ip dhcp-relay max-message-length](#)
- [service dhcp-relay](#)

# ip dhcp-relay agent-option checking

**Overview** This command enables the DHCP Relay Agent to check DHCP Relay Agent Information Option (Option 82) information in response packets returned from DHCP servers. If the information does not match the information it has for its own client (downstream) interface then the DHCP Relay Agent drops the packet. Note that [ip dhcp-relay agent-option](#) must be configured.

The DHCP Relay Agent Option 82 field is included in relayed client DHCP packets if:

- DHCP Relay Agent Option 82 is enabled ([ip dhcp-relay agent-option](#)), and
- DHCP Relay Agent is enabled on the device ([service dhcp-relay](#))

For DHCP Relay Agent and DHCP Relay Agent Option 82 introductory information, see the [DHCP Feature Overview and Configuration Guide](#).

**Syntax** `ip dhcp-relay agent-option checking`  
`no ip dhcp-relay agent-option checking`

**Mode** Interface Configuration for a VLAN interface or a PPP interface.

**Examples** To make the DHCP Relay Agent listening on vlan10 check the DHCP Relay Agent Information Option (Option 82) field, use the commands:

```
awplus# configure terminal
awplus(config)# interface vlan10
awplus(config-if)# ip dhcp-relay agent-option
awplus(config-if)# ip dhcp-relay agent-option checking
```

To stop the DHCP Relay Agent on vlan10 from checking the DHCP Relay Agent Information Option (Option 82) field, use the commands:

```
awplus# configure terminal
awplus(config)# interface vlan10
awplus(config-if)# no ip dhcp-relay agent-option checking
```

To make the relay agent listening on PPP interface ppp0 check the DHCP Relay Agent Information Option (Option 82) field, use the commands:

```
awplus# configure terminal
awplus(config)# interface ppp0
awplus(config-if)# ip dhcp-relay agent-option
awplus(config-if)# ip dhcp-relay agent-option checking
```

To stop the relay agent from checking the DHCP Relay Agent Information Option (Option 82) field on PPP interface ppp0, use the commands:

```
awplus# configure terminal
awplus(config)# interface ppp0
awplus(config-if)# no ip dhcp-relay agent-option checking
```

**Related  
Commands** `ip dhcp-relay agent-option`  
`ip dhcp-relay agent-option remote-id`  
`ip dhcp-relay information policy`  
`service dhcp-relay`

# ip dhcp-relay agent-option remote-id

**Overview** Use this command to specify the Remote ID sub-option of the DHCP Relay Agent Option 82 field the DHCP Relay Agent inserts into clients' request packets. The Remote ID identifies the device that is inserting the DHCP Relay Agent Option 82 information. If a Remote ID is not specified, the Remote ID sub-option is set to the device's MAC address.

Use the **no** variant of this command to return the Remote ID for an interface.

For DHCP Relay Agent and DHCP Relay Agent Option 82 introductory information, see the [DHCP Feature Overview and Configuration Guide](#).

**Syntax** `ip dhcp-relay agent-option remote-id <remote-id>`  
`no ip dhcp-relay agent-option remote-id`

| Parameter                      | Description                                                                                                                                                      |
|--------------------------------|------------------------------------------------------------------------------------------------------------------------------------------------------------------|
| <code>&lt;remote-id&gt;</code> | An alphanumeric (ASCII) string, 1 to 63 characters in length. Additional characters allowed are hyphen (-), underscore (_) and hash (#). Spaces are not allowed. |

**Default** The Remote ID is set to the device's MAC address by default.

**Mode** Interface Configuration for a VLAN interface or a PPP interface.

**Usage** The Remote ID sub-option is included in the DHCP Relay Agent Option 82 field of relayed client DHCP packets if:

- DHCP Relay Agent Option 82 is enabled ([ip dhcp-relay agent-option](#)), and
- DHCP Relay Agent is enabled on the device ([service dhcp-relay](#))

**Examples** To set the Remote ID to `myid` for client DHCP packets received on `vlan1`, use the commands:

```
awplus# configure terminal
awplus(config)# interface vlan1
awplus(config-if)# ip dhcp-relay agent-option remote-id myid
```

To remove the Remote ID specified for `vlan1`, use the commands:

```
awplus# configure terminal
awplus(config)# interface vlan1
awplus(config-if)# no ip dhcp-relay agent-option remote-id
```



To set the Remote ID to `myid` for client DHCP packets received on PPP interface `ppp0`, use the commands:

```
awplus# configure terminal
awplus(config)# interface ppp0 timeslots all
awplus(config-if)# ip dhcp-relay agent-option remote-id myid
```

To remove the Remote ID specified for PPP interface `ppp0`, use the commands:

```
awplus# configure terminal
awplus(config)# interface ppp0 timeslots all
awplus(config-if)# no ip dhcp-relay agent-option remote-id
```

**Related Commands**

- [ip dhcp-relay agent-option](#)
- [ip dhcp-relay agent-option checking](#)
- [show ip dhcp-relay](#)

# ip dhcp-relay information policy

**Overview** This command sets the policy for how the DHCP relay deals with packets arriving from the client that contain DHCP Relay Agent Option 82 information.

If the command **ip dhcp-relay agent-option** has not been configured, then this command has no effect at all - no alteration is made to Option 82 information in packets arriving from the client side.

However, if the command **ip dhcp-relay agent-option** has been configured, this command modifies how the DHCP relay service deals with cases where the packet arriving from the client side already contains DHCP Relay Agent Option 82 information.

This command sets the action that the DHCP relay should take when a received DHCP client request contains DHCP Relay Agent Option 82 information.

By default, the DHCP Relay Agent replaces any existing DHCP Relay Agent Option 82 field with its own DHCP Relay Agent field. This is equivalent to the functionality of the **replace** parameter.

The **no** variant of this command returns the policy to the default behavior - i.e. replacing the existing DHCP Relay Agent Option 82 field.

For DHCP Relay Agent and DHCP Relay Agent Option 82 introductory information, see the [DHCP Feature Overview and Configuration Guide](#).

**NOTE:** The DHCP-relay service might alter the content of the DHCP Relay Agent Option 82 field, if the commands [ip dhcp-relay agent-option](#) and [ip dhcp-relay information policy](#) have been configured.

**Syntax**

```
ip dhcp-relay information policy {append|drop|keep|replace}
no ip dhcp-relay information policy
```

| Parameter | Description                                                                                                                                                    |
|-----------|----------------------------------------------------------------------------------------------------------------------------------------------------------------|
| append    | The DHCP Relay Agent appends the DHCP Relay Agent Option 82 field of the packet with its own DHCP Relay Agent Option 82 details.                               |
| drop      | The DHCP Relay Agent discards the packet.                                                                                                                      |
| keep      | The DHCP Relay Agent forwards the packet without altering the DHCP Relay Agent Option 82 field.                                                                |
| replace   | The DHCP Relay Agent replaces the existing DHCP Relay Agent details in the DHCP Relay Agent Option 82 field with its own details before forwarding the packet. |

**Mode** Interface Configuration for a VLAN interface or a PPP interface.

**Examples** To make the DHCP Relay Agent listening on `vlan15` drop any client requests that already contain DHCP Relay Agent Option 82 information, use the commands:

```
awplus# configure terminal
awplus(config)# interface vlan15
awplus(config-if)# ip dhcp-relay information policy drop
```

To reset the DHCP relay information policy to the default policy for interface `vlan15`, use the commands:

```
awplus# configure terminal
awplus(config)# interface vlan15
awplus(config-if)# no ip dhcp-relay information policy
```

**Related Commands**

- [ip dhcp-relay agent-option](#)
- [ip dhcp-relay agent-option checking](#)
- [service dhcp-server](#)

# ip dhcp-relay maxhops

**Overview** This command sets the hop count threshold for discarding BOOTP messages. When the hops field in a BOOTP message exceeds the threshold, the DHCP Relay Agent discards the BOOTP message. The hop count threshold is set to 10 hops by default.

Use the **no** variant of this command to reset the hop count to the default.

For DHCP Relay Agent and DHCP Relay Agent Option 82 introductory information, see the [DHCP Feature Overview and Configuration Guide](#).

**Syntax** `ip dhcp-relay maxhops <1-255>`  
`no ip dhcp-relay maxhops`

| Parameter | Description                  |
|-----------|------------------------------|
| <1-255>   | The maximum hop count value. |

**Default** The default hop count threshold is 10 hops.

**Mode** Interface Configuration for a VLAN interface or a PPP interface.

**Example** To set the maximum number of hops to 5 for packets received on interface `vlan15`, use the commands:

```
awplus# configure terminal
awplus(config)# interface vlan15
awplus(config-if)# ip dhcp-relay maxhops 5
```

**Related Commands** [service dhcp-relay](#)

# ip dhcp-relay max-message-length

**Overview** This command applies when the device is acting as a DHCP Relay Agent and DHCP Relay Agent Option 82 insertion is enabled. It sets the maximum DHCP message length (in bytes) for the DHCP packet with its DHCP Relay Agent Option 82 data inserted. From this value it calculates the maximum packet size that it will accept at its input. Packets that arrive greater than this value will be dropped.

The **no** variant of this command sets the maximum message length to its default of 1400 bytes.

For DHCP Relay Agent and DHCP Relay Agent Option 82 introductory information, see the [DHCP Feature Overview and Configuration Guide](#).

**Syntax** `ip dhcp-relay max-message-length <548-1472>`  
`no ip dhcp-relay max-message-length`

| Parameter  | Description                                                                                                 |
|------------|-------------------------------------------------------------------------------------------------------------|
| <548-1472> | The maximum DHCP message length (this is the message header plus the inserted DHCP option fields in bytes). |

**Default** The default is 1400 bytes.

**Mode** Interface Configuration for a VLAN interface or a PPP interface.

**Usage** When a DHCP Relay Agent (that has DHCP Relay Agent Option 82 insertion enabled) receives a request packet from a DHCP client, it will append the DHCP Relay Agent Option 82 component data, and forward the packet to the DHCP server. The DHCP client will sometimes issue packets containing pad option fields that can be overwritten with Option 82 data.

Where there are insufficient pad option fields to contain all the DHCP Relay Agent Option 82 data, the DHCP Relay Agent will increase the packet size to accommodate the DHCP Relay Agent Option 82 data. If the new (increased) packet size exceeds that defined by the **maximum-message-length** parameter, then the DHCP Relay Agent will drop the packet.

**NOTE:** Before setting this command, you must first run the `ip dhcp-relay agent-option` command. This will allow the DHCP Relay Agent Option 82 fields to be appended.

**Example** To set the maximum DHCP message length to 1200 bytes for packets arriving in interface `vlan7`, use the commands:

```
awplus# configure terminal
awplus(config)# interface vlan7
awplus(config-if)# ip dhcp-relay max-message-length 1200
```

To reset the maximum DHCP message length to the default of 1400 bytes for packets arriving in interface `vlan7`, use the commands:

```
awplus# configure terminal
awplus(config)# interface vlan7
awplus(config-if)# no ip dhcp-relay max-message-length
```

**Related  
Commands** [service dhcp-relay](#)

# ip dhcp-relay server-address

**Overview** This command adds a DHCP server for the DHCP Relay Agent to forward client DHCP packets to on a particular interface. You can add up to five DHCP servers on each device interface that the DHCP Relay Agent is listening on.

The **no** variant of this command deletes the specified DHCP server from the list of servers available to the DHCP relay agent.

The **no ip dhcp-relay** command removes all DHCP relay settings from the interface.

For DHCP Relay Agent and DHCP Relay Agent Option 82 introductory information, see the [DHCP Feature Overview and Configuration Guide](#).

**Syntax**

```
ip dhcp-relay server-address {<ipv4-address>|<ipv6-address>
<server-interface>}

no ip dhcp-relay server-address {<ipv4-address>|<ipv6-address>
<server-interface>}

no ip dhcp-relay
```

| Parameter          | Description                                                                                                                                                               |
|--------------------|---------------------------------------------------------------------------------------------------------------------------------------------------------------------------|
| <ipv4-address>     | Specify the IPv4 address of the DHCP server for DHCP Relay Agent to forward client DHCP packets to, in dotted decimal notation. The IPv4 address uses the format A.B.C.D. |
| <ipv6-address>     | Specify the IPv6 address of the DHCPv6 server for DHCPv6 Relay Agent to forward client DHCP packets to, in hexadecimal notation.                                          |
| <server-interface> | Specify the interface name of the DHCPv6 server. It is only required for a DHCPv6 server with an IPv6 address.                                                            |

**Mode** Interface Configuration for a VLAN interface or a PPP interface.

**Usage** For a DHCP server with an IPv6 address you must specify the interface for the DHCP server. See examples below for configuration differences between IPv4 and IPv6 DHCP relay servers.

See also the [service dhcp-relay](#) command to enable the DHCP Relay Agent on your device. The [ip dhcp-relay server-address](#) command defines a relay destination on an interface on the device, needed by the DHCP Relay Agent to relay DHCP client packets to a DHCP server.

**Examples** To enable the DHCP Relay Agent to relay DHCP packets on interface `vlan2` to the DHCP server with the IPv4 address `192.0.2.200`, use the commands:

```
awplus# configure terminal
awplus(config)# service dhcp-relay
awplus(config)# interface vlan2
awplus(config-if)# ip dhcp-relay server-address 192.0.2.200
```

To remove the DHCP server with the IPv4 address `192.0.2.200` from the list of servers available to the DHCP Relay Agent on interface `vlan2`, use the commands:

```
awplus# configure terminal
awplus(config)# interface vlan2
awplus(config-if)# no ip dhcp-relay server-address 192.0.2.200
```

To enable the DHCP Relay Agent on your device to relay DHCP packets on interface `vlan10` to the DHCP server with the IPv6 address `2001:0db8:010d::1` on interface `vlan20`, use the commands:

```
awplus# configure terminal
awplus(config)# service dhcp-relay
awplus(config)# interface vlan10
awplus(config-if)# ip dhcp-relay server-address
2001:0db8:010d::1 vlan20
```

To remove the DHCP server with the IPv6 address `2001:0db8:010d::1` on interface `vlan20` from the list of servers available to the DHCP Relay Agent on interface `vlan10`, use the commands:

```
awplus# configure terminal
awplus(config)# interface vlan10
awplus(config-if)# no ip dhcp-relay server-address
2001:0db8:010d::1 vlan20
```

To disable DHCP relay on `vlan10`, use the commands:

```
awplus# configure terminal
awplus(config)# interface vlan10
awplus(config-if)# no ip dhcp-relay
```

**Related  
Commands** [service dhcp-relay](#)



# lease

**Overview** This command sets the expiration time for a leased address for the DHCP address pool you are configuring. The time set by the days, hours, minutes and seconds is cumulative. The minimum total lease time that can be configured is 20 seconds. The maximum total lease time that can be configured is 120 days.

Note that if you add a user-defined option 51 using the `option` command, then you will override any settings created with this command. Option 51 specifies a lease time of 1 day.

Use the **infinite** parameter to set the lease expiry time to infinite (leases never expire).

Use the **no** variant of this command to return the lease expiration time back to the default of one day.

**Syntax** `lease <days> <hours> <minutes> [<seconds>]`  
`lease infinite`  
`no lease`

| Parameter                    | Description                                                                                    |
|------------------------------|------------------------------------------------------------------------------------------------|
| <code>&lt;days&gt;</code>    | The number of days, from 0 to 120, that the lease expiry time is configured for.<br>Default: 1 |
| <code>&lt;hours&gt;</code>   | The number of hours, from 0 to 24, that the lease expiry time is configured for.<br>Default: 0 |
| <code>&lt;minutes&gt;</code> | The number of minutes, from 0 to 60, the lease expiry time is configured for.<br>Default: 0    |
| <code>&lt;seconds&gt;</code> | The number of seconds, from 0 to 60, the lease expiry time is configured for.                  |
| <code>infinite</code>        | The lease never expires.                                                                       |

**Default** The default lease time is 1 day.

**Mode** DHCP Configuration

**Examples** To set the lease expiration time for address pool P2 to 35 minutes, use the commands:

```
awplus# configure terminal
awplus(config)# ip dhcp pool P2
awplus(dhcp-config)# lease 0 0 35
```

To set the lease expiration time for the address pool `Nerv_Office` to 1 day, 5 hours, and 30 minutes, use the commands:

```
awplus# configure terminal
awplus(config)# ip dhcp pool Nerv_Office
awplus(dhcp-config)# lease 1 5 30
```

To set the lease expiration time for the address pool `P3` to 20 seconds, use the commands:

```
awplus# configure terminal
awplus(config)# ip dhcp pool P3
awplus(dhcp-config)# lease 0 0 0 20
```

To set the lease expiration time for the pool to never expire, use the command:

```
awplus(dhcp-config)# lease infinite
```

To return the lease expiration time to the default of one day, use the command:

```
awplus(dhcp-config)# no lease
```

**Related  
Commands** [option](#)  
[service dhcp-server](#)

# network (DHCP)

**Overview** This command sets the network (subnet) that the DHCP address pool applies to. The **no** variant of this command removes the network (subnet) from the DHCP address pool.

**Syntax** network  
{<ip-subnet-address/prefix-length>|<ip-subnet-address/mask>}  
no network

| Parameter                         | Description                                                                                                |
|-----------------------------------|------------------------------------------------------------------------------------------------------------|
| <ip-subnet-address/prefix-length> | The IPv4 subnet address in dotted decimal notation followed by the prefix length in slash notation.        |
| <ip-subnet-address/mask>          | The IPv4 subnet address in dotted decimal notation followed by the subnet mask in dotted decimal notation. |

**Mode** DHCP Configuration

**Usage** This command will fail if it would make existing ranges invalid. For example, if they do not lie within the new network you are configuring. The **no** variant of this command will fail if ranges still exist in the pool. You must remove all ranges in the pool before issuing a **no network** command to remove a network from the pool.

**Examples** To configure a network for the address pool P2, where the subnet is 192.0.2.5 and the mask is 255.255.255.0, use the commands:

```
awplus# configure terminal
awplus(config)# ip dhcp pool P2
awplus(dhcp-config)# network 192.0.2.5/24
```

or you can use dotted decimal notation instead of slash notation for the subnet-mask:

```
awplus# configure terminal
awplus(config)# ip dhcp pool P2
awplus(dhcp-config)# network 192.0.2.5 255.255.255.0
```

**Related Commands** [service dhcp-server](#)  
[subnet-mask](#)

## next-server

**Overview** This command sets the next server address for a DHCP server pool. It is the address of the next server that the client should use in its bootstrap process.

The **no** variant of this command removes the next server address from the DHCP address pool.

**Syntax** `next-server <ip-address>`  
`no next-server`

| Parameter                       | Description                                                |
|---------------------------------|------------------------------------------------------------|
| <code>&lt;ip-address&gt;</code> | The server IP address, entered in dotted decimal notation. |

**Mode** DHCP Configuration

**Example** To set the next-server address for the address pool P2, use the commands:

```
awplus# configure terminal
awplus(config)# ip dhcp pool P2
awplus(dhcp-config)# next-server 192.0.2.2
```

# option

**Overview** This command adds a user-defined option to the DHCP address pool you are configuring. For the **hex**, **integer**, and **flag** option types, if the option already exists, the new option overwrites the existing option's value. Options with an **ip** type can hold a list of IP addresses or masks (i.e. entries that have the A.B.C.D address format), so if the option already exists in the pool, then the new IP address is added to the list of existing IP addresses.

Options with the same number as one of the pre-defined options override the standard option definition. The pre-defined options use the option numbers 1, 3, 6, 15, and 51.

The **no** variant of this command removes the specified user-defined option from the DHCP pool, or all user-defined options from the DHCP pool.

**Syntax** `option [<1-254>|<option-name>] <option-value>`  
`no option [<1-254>|<option-value>]`

| Parameter      | Description                                                                                                                                                                                                                                                                                                                                                                                                                                                                                                                                                                                                                                                                                                                                                                                                                       |     |                                                                                                                                                                                             |    |                                                                                                                                                                                            |         |                                |      |                                                                                                      |
|----------------|-----------------------------------------------------------------------------------------------------------------------------------------------------------------------------------------------------------------------------------------------------------------------------------------------------------------------------------------------------------------------------------------------------------------------------------------------------------------------------------------------------------------------------------------------------------------------------------------------------------------------------------------------------------------------------------------------------------------------------------------------------------------------------------------------------------------------------------|-----|---------------------------------------------------------------------------------------------------------------------------------------------------------------------------------------------|----|--------------------------------------------------------------------------------------------------------------------------------------------------------------------------------------------|---------|--------------------------------|------|------------------------------------------------------------------------------------------------------|
| <1-254>        | The option number of the option. Options with the same number as one of the standard options overrides the standard option definition.                                                                                                                                                                                                                                                                                                                                                                                                                                                                                                                                                                                                                                                                                            |     |                                                                                                                                                                                             |    |                                                                                                                                                                                            |         |                                |      |                                                                                                      |
| <option-name>  | Option name associated with the option.                                                                                                                                                                                                                                                                                                                                                                                                                                                                                                                                                                                                                                                                                                                                                                                           |     |                                                                                                                                                                                             |    |                                                                                                                                                                                            |         |                                |      |                                                                                                      |
| <option-value> | The option value. You must specify a value that is appropriate to the option type: <table border="1" data-bbox="710 1261 1423 1751"> <tbody> <tr> <td>hex</td> <td>A hexadecimal string. Valid characters are the numbers 0–9 and letters a–f. Embedded spaces are not valid. The string must be an even number of characters, from 2 and 256 characters long.</td> </tr> <tr> <td>ip</td> <td>An IPv4 address or mask that has the dotted decimal A.B.C.D notation. To create a list of IP addresses, you must add each IP address individually using the option command multiple times.</td> </tr> <tr> <td>integer</td> <td>A number from 0 to 4294967295.</td> </tr> <tr> <td>flag</td> <td>A value of either true, on, or enabled to set the flag, or false, off or disabled to unset the flag.</td> </tr> </tbody> </table> | hex | A hexadecimal string. Valid characters are the numbers 0–9 and letters a–f. Embedded spaces are not valid. The string must be an even number of characters, from 2 and 256 characters long. | ip | An IPv4 address or mask that has the dotted decimal A.B.C.D notation. To create a list of IP addresses, you must add each IP address individually using the option command multiple times. | integer | A number from 0 to 4294967295. | flag | A value of either true, on, or enabled to set the flag, or false, off or disabled to unset the flag. |
| hex            | A hexadecimal string. Valid characters are the numbers 0–9 and letters a–f. Embedded spaces are not valid. The string must be an even number of characters, from 2 and 256 characters long.                                                                                                                                                                                                                                                                                                                                                                                                                                                                                                                                                                                                                                       |     |                                                                                                                                                                                             |    |                                                                                                                                                                                            |         |                                |      |                                                                                                      |
| ip             | An IPv4 address or mask that has the dotted decimal A.B.C.D notation. To create a list of IP addresses, you must add each IP address individually using the option command multiple times.                                                                                                                                                                                                                                                                                                                                                                                                                                                                                                                                                                                                                                        |     |                                                                                                                                                                                             |    |                                                                                                                                                                                            |         |                                |      |                                                                                                      |
| integer        | A number from 0 to 4294967295.                                                                                                                                                                                                                                                                                                                                                                                                                                                                                                                                                                                                                                                                                                                                                                                                    |     |                                                                                                                                                                                             |    |                                                                                                                                                                                            |         |                                |      |                                                                                                      |
| flag           | A value of either true, on, or enabled to set the flag, or false, off or disabled to unset the flag.                                                                                                                                                                                                                                                                                                                                                                                                                                                                                                                                                                                                                                                                                                                              |     |                                                                                                                                                                                             |    |                                                                                                                                                                                            |         |                                |      |                                                                                                      |

**Mode** DHCP Configuration

**Examples** To add the ASCII-type option named `tftp-server-name` to the pool P2 and give the option the value `server1`, use the commands:

```
awplus# configure terminal
awplus(config)# ip dhcp pool P2
awplus(dhcp-config)# option tftp-server-name server1
```

To add the hex-type option named `tcpip-node-type` to the pool P2 and give the option the value `08af`, use the commands:

```
awplus# configure terminal
awplus(config)# ip dhcp pool P2
awplus(dhcp-config)# option tcpip-node-type 08af
```

To add multiple IP addresses for the ip-type option 175, use the command:

```
awplus(dhcp-config)# option 175 192.0.2.6
awplus(dhcp-config)# option 175 192.0.2.12
awplus(dhcp-config)# option 175 192.0.2.33
```

To add the option 179 to a pool, and give the option the value `123456`, use the command:

```
awplus(dhcp-config)# option 179 123456
```

To add a user-defined flag option with the name `perform-router-discovery`, use the command:

```
awplus(dhcp-config)# option perform-router-discovery yes
```

To clear all user-defined options from a DHCP address pool, use the command:

```
awplus(dhcp-config)# no option
```

To clear a user-defined option, named `tftp-server-name`, use the command:

```
awplus(dhcp-config)# no option tftp-server-name
```

**Related  
Commands**

[dns-server](#)  
[ip dhcp option](#)  
[lease](#)  
[service dhcp-server](#)  
[show ip dhcp pool](#)

# probe enable

**Overview** Use this command to enable lease probing for a DHCP pool. Probing is used by the DHCP server to check if an IP address it wants to lease to a client is already being used by another host.

The **no** variant of this command disables probing for a DHCP pool.

**Syntax** probe enable  
no probe enable

**Default** Probing is enabled by default.

**Mode** DHCP Pool Configuration

**Examples** To enable probing for pool P2, use the commands:

```
awplus# configure terminal
awplus(config)# ip dhcp pool P2
awplus(dhcp-config)# probe enable
```

To disable probing for pool P2, use the commands:

```
awplus# configure terminal
awplus(config)# ip dhcp pool P2
awplus(dhcp-config)# no probe enable
```

**Related Commands**

- [ip dhcp pool](#)
- [probe packets](#)
- [probe timeout](#)
- [probe type](#)
- [show ip dhcp pool](#)

# probe packets

**Overview** Use this command to specify the number of packets sent for each lease probe. Lease probing is configured on a per-DHCP pool basis. When set to 0 probing is effectively disabled.

The **no** variant of this command sets the number of probe packets sent to the default of 5.

**Syntax** `probe packets <0-10>`  
`no probe packets`

| Parameter | Description                       |
|-----------|-----------------------------------|
| <0-10>    | The number of probe packets sent. |

**Default** The default is 5.

**Mode** DHCP Pool Configuration

**Examples** To set the number of probe packets to 2 for pool P2, use the commands:

```
awplus# configure terminal
awplus(config)# ip dhcp pool P2
awplus(dhcp-config)# probe packets 2
```

To set the number of probe packets to the default 5 for pool P2, use the commands:

```
awplus# configure terminal
awplus(config)# ip dhcp pool P2
awplus(dhcp-config)# no probe packets
```

**Related Commands** [probe enable](#)  
[probe timeout](#)  
[probe type](#)  
[show ip dhcp pool](#)



# probe timeout

**Overview** Use this command to set the timeout value in milliseconds that the server waits for a response after each probe packet is sent. Lease probing is configured on a per-DHCP pool basis.

The **no** variant of this command sets the probe timeout value to the default setting, 200 milliseconds.

**Syntax** `probe timeout <50-5000>`  
`no probe timeout`

| Parameter                    | Description                       |
|------------------------------|-----------------------------------|
| <code>&lt;50-5000&gt;</code> | Timeout interval in milliseconds. |

**Default** The default timeout interval is 200 milliseconds.

**Mode** DHCP Pool Configuration

**Examples** To set the probe timeout value to 500 milliseconds for pool P2, use the commands:

```
awplus# configure terminal
awplus(config)# ip dhcp pool P2
awplus(dhcp-config)# probe timeout 500
```

To set the probe timeout value for pool P2 to the default, 200 milliseconds, use the commands:

```
awplus# configure terminal
awplus(config)# ip dhcp pool P2
awplus(dhcp-config)# no probe timeout
```

**Related Commands** [probe enable](#)  
[probe packets](#)  
[probe type](#)  
[show ip dhcp pool](#)

# probe type

**Overview** Use this command to set the probe type for a DHCP pool. The probe type specifies how the DHCP server checks whether an IP address is being used by other hosts, referred to as lease probing. If **arp** is specified, the server sends an ARP request to determine if an address is in use. If **ping** is specified, the server will send an ICMP Echo Request (ping).

The **no** variant of this command sets the probe type to the default setting, ping.

**Syntax** `probe type {arp|ping}`  
`no probe type`

| Parameter | Description       |
|-----------|-------------------|
| arp       | Probe using ARP.  |
| ping      | Probe using ping. |

**Default** The default probe type is ping.

**Mode** DHCP Pool Configuration

**Examples** To set the probe type to `arp` for the pool `P2`, use the commands:

```
awplus# configure terminal
awplus(config)# ip dhcp pool P2
awplus(dhcp-config)# probe type arp
```

To set the probe type for the pool `P2` to the default, `ping`, use the commands:

```
awplus# configure terminal
awplus(config)# ip dhcp pool P2
awplus(dhcp-config)# no probe type
```

**Related Commands**

- [ip dhcp pool](#)
- [probe enable](#)
- [probe packets](#)
- [probe timeout](#)
- [show ip dhcp pool](#)

# range

**Overview** This command adds an address range to the DHCP address pool you are configuring. The DHCP server responds to client requests received from the pool's network. It assigns an IP addresses within the specified range. The IP address range must lie within the network. You can add multiple address ranges and individual IP addresses for a DHCP pool by using this command multiple times.

The **no** variant of this command removes an address range from the DHCP pool. Use the **no range all** command to remove all address ranges from the DHCP pool.

**Syntax**

```
range <ip-address> [<ip-address>]
no range <ip-address> [<ip-address>]
no range all
```

| Parameter    | Description                                                                                                                                                                                                                                |
|--------------|--------------------------------------------------------------------------------------------------------------------------------------------------------------------------------------------------------------------------------------------|
| <ip-address> | IPv4 address range for DHCP clients, in dotted decimal notation. The first IP address is the low end of the range, the second IP address is the high end. Specify only one IP address to add an individual IP address to the address pool. |

**Mode** DHCP Configuration

**Examples** To add an address range of 192.0.2.5 to 192.0.2.16 to the pool Nerv\_Office, use the command:

```
awplus# configure terminal
awplus(config)# ip dhcp pool Nerv_Office
awplus(dhcp-config)# range 192.0.2.5 192.0.2.16
```

To add the individual IP address 192.0.2.2 to a pool, use the command:

```
awplus(dhcp-config)# range 192.0.2.2
```

To remove all address ranges from a pool, use the command:

```
awplus(dhcp-config)# no range all
```

**Related Commands**

- [ip dhcp pool](#)
- [service dhcp-server](#)
- [show ip dhcp pool](#)

# route

**Overview** This command allows the DHCP server to provide static routes to clients.

**Syntax** `route A.B.C.D/M A.B.C.D {both|opt249|rfc3442}`

| Parameter | Description                            |
|-----------|----------------------------------------|
| A.B.C.D/M | Subnet for the route                   |
| A.B.C.D   | Next hop for the route                 |
| both      | opt249 and rft3442                     |
| opt249    | Classless static route option for DHCP |
| rfc3442   | Classless static route option for DHCP |

**Mode** DHCP Configuration

**Examples** To distribute static routes for route 0.0.0.0/0 whose next hop is 192.16.1.1 to clients using both opt249 and rfc3442, use the command:

```
awplus# configure terminal
awplus(config)# ip dhcp pool public
awplus(dhcp-config)# route 0.0.0.0/0 192.16.1.1 both
```

**Related Commands** [ip dhcp pool](#)

# service dhcp-relay

**Overview** This command enables the DHCP Relay Agent on the device. However, on a given IP interface, no DHCP forwarding takes place until at least one DHCP server is specified to forward/relay all clients' DHCP packets to.

The **no** variant of this command disables the DHCP Relay Agent on the device for all interfaces.

**Syntax** `service dhcp-relay`  
`no service dhcp-relay`

**Mode** Global Configuration

**Usage** A maximum number of 400 DHCP Relay Agents (one per interface) can be configured on the device. Once this limit has been reached, any further attempts to configure DHCP Relay Agents will not be successful.

**Default** The DHCP-relay service is enabled by default.

**Examples** To enable the DHCP relay global function, use the commands:

```
awplus# configure terminal
awplus(config)# service dhcp-relay
```

To disable the DHCP relay global function, use the commands:

```
awplus# configure terminal
awplus(config)# no service dhcp-relay
```

**Related Commands**

- [ip dhcp-relay agent-option](#)
- [ip dhcp-relay agent-option checking](#)
- [ip dhcp-relay information policy](#)
- [ip dhcp-relay maxhops](#)
- [ip dhcp-relay server-address](#)

# service dhcp-server

**Overview** This command enables the DHCP server on your device. The server then listens for DHCP requests on all IP interfaces. It will not run if there are no IP interfaces configured.

The **no** variant of this command disables the DHCP server.

**Syntax** `service dhcp-server`  
`no service dhcp-server`

**Mode** Global Configuration

**Example** To enable the DHCP server, use the commands:

```
awplus# configure terminal
awplus(config)# service dhcp-server
```

**Related Commands** [ip dhcp pool](#)  
[show ip dhcp server summary](#)  
[subnet-mask](#)

# show counter dhcp-client

**Overview** This command shows counters for the DHCP client on your device.  
For information on filtering and saving command output, see the [“Getting Started with AlliedWare Plus” Feature Overview and Configuration Guide](#).

**Syntax** `show counter dhcp-client`

**Mode** User Exec and Privileged Exec

**Example** To display the message counters for the DHCP client on your device, use the command:

```
awplus# show counter dhcp-client
```

**Output** Figure 51-1: Example output from the **show counter dhcp-client** command

```
show counter dhcp-client
DHCPDISCOVER out 10
DHCPREQUEST out 34
DHCPCDECLINE out 4
DHCPRELEASE out 0
DHCPPOFFER in 22
DHCPACK in 18
DHCPNAK in 0
```

**Table 1:** Parameters in the output of the **show counter dhcp-client** command

| Parameter        | Description                                                                  |
|------------------|------------------------------------------------------------------------------|
| DHCPDISCOVER out | The number of DHCP Discover messages sent by the client.                     |
| DHCPREQUEST out  | The number of DHCP Request messages sent by the client.                      |
| DHCPCDECLINE out | The number of DHCP Decline messages sent by the client.                      |
| DHCPRELEASE out  | The number of DHCP Release messages sent by the client.                      |
| DHCPPOFFER in    | The number of DHCP Offer messages received by the client.                    |
| DHCPACK in       | The number of DHCP Acknowledgement messages received by the client.          |
| DHCPNAK in       | The number of DHCP Negative Acknowledgement messages received by the client. |

**Related Commands** [ip address dhcp](#)

# show counter dhcp-relay

**Overview** This command shows counters for the DHCP Relay Agent on your device.

For information on filtering and saving command output, see the [“Getting Started with AlliedWare Plus” Feature Overview and Configuration Guide](#).

**Syntax** show counter dhcp-relay

**Syntax (VRF-lite)** show counter dhcp-relay [vrf <vrf-name>|global]

| Parameter  | Description                                    |
|------------|------------------------------------------------|
| vrf        | Display the output for a VRF instance          |
| <vrf-name> | The name of the specific VRF instance.         |
| global     | Display the output for the Global VRF instance |

**Mode** User Exec and Privileged Exec

**Examples** To display counters for the DHCP Relay Agent on your device, use the following command:

```
awplus# show counter dhcp-relay
```

**Output** Figure 51-2: Example output from the **show counter dhcp-relay** command

```
awplus#show counter dhcp-relay

DHCP relay counters
Requests In 4
Replies In 4
Relayed To Server 4
Relayed To Client 4
Out To Server Failed 0
Out To Client Failed 0
Invalid hlen 0
Bogus giaddr 0
Corrupt Agent Option 0
Missing Agent Option 0
Bad Circuit ID 0
Missing Circuit ID 0
Bad Remote ID 0
Missing Remote ID 0
Option Insert Failed 0
DHCPv6 Requests In 0
DHCPv6 Replies In 0
DHCPv6 Relayed to Server 0
DHCPv6 Relayed to Client 0
```



**Output (VRF-lite)** Figure 51-3: Example output from the **show counter dhcp-relay** command for VRF instance red

```
DHCP relay counters

[VRF red]
Requests In 4
Replies In 4
Relayed To Server 4
Relayed To Client 4
Out To Server Failed 0
Out To Client Failed 0
Invalid hlen 0
Bogus giaddr 0
Corrupt Agent Option 0
Missing Agent Option 0
Bad Circuit ID 0
Missing Circuit ID 0
Option Insert Failed 0
```

| Parameter            | Description                                                                                                                                                                                                                                                                                                                                                                                                                                                                        |
|----------------------|------------------------------------------------------------------------------------------------------------------------------------------------------------------------------------------------------------------------------------------------------------------------------------------------------------------------------------------------------------------------------------------------------------------------------------------------------------------------------------|
| Requests In          | The number of DHCP Request messages received from clients.                                                                                                                                                                                                                                                                                                                                                                                                                         |
| Replies In           | The number of DHCP Reply messages received from servers.                                                                                                                                                                                                                                                                                                                                                                                                                           |
| Relayed To Server    | The number of DHCP Request messages relayed to servers.                                                                                                                                                                                                                                                                                                                                                                                                                            |
| Relayed To Client    | The number of DHCP Reply messages relayed to clients.                                                                                                                                                                                                                                                                                                                                                                                                                              |
| Out To Server Failed | The number of failures when attempting to send request messages to servers. This is an internal debugging counter.                                                                                                                                                                                                                                                                                                                                                                 |
| Out To Client Failed | The number of failures when attempting to send reply messages to clients. This is an internal debugging counter.                                                                                                                                                                                                                                                                                                                                                                   |
| Invalid hlen         | The number of incoming messages dropped due to an invalid hlen field.                                                                                                                                                                                                                                                                                                                                                                                                              |
| Bogus giaddr         | The number of incoming DHCP Reply messages dropped due to the bogus giaddr field.                                                                                                                                                                                                                                                                                                                                                                                                  |
| Corrupt Agent Option | The number of incoming DHCP Reply messages dropped due to a corrupt relay agent information option field. Note that Agent Option counters only increment on errors occurring if the <code>ip dhcp-relay agent-option</code> command is configured for an interface. Messages generating the errors are only dropped if the <code>ip dhcp-relay agent-option checking</code> command is configured on the interface as well as the <code>ip dhcp-relay agent-option</code> command. |

| Parameter            | Description                                                                                                                                                                                                                                                                                                                                                                                                                                                                        |
|----------------------|------------------------------------------------------------------------------------------------------------------------------------------------------------------------------------------------------------------------------------------------------------------------------------------------------------------------------------------------------------------------------------------------------------------------------------------------------------------------------------|
| Missing Agent Option | The number of incoming DHCP Reply messages dropped due to a missing relay agent information option field. Note that Agent Option counters only increment on errors occurring if the <code>ip dhcp-relay agent-option</code> command is configured for an interface. Messages generating the errors are only dropped if the <code>ip dhcp-relay agent-option checking</code> command is configured on the interface as well as the <code>ip dhcp-relay agent-option</code> command. |
| Bad Circuit ID       | The number of incoming DHCP Reply messages dropped due to a bad circuit ID. Note that Agent Option counters only increment on errors occurring if the <code>ip dhcp-relay agent-option</code> command is configured for an interface. Messages generating the errors are only dropped if the <code>ip dhcp-relay agent-option checking</code> command is configured on the interface as well as the <code>ip dhcp-relay agent-option</code> command.                               |
| Missing Circuit ID   | The number of incoming DHCP Reply messages dropped due to a missing circuit ID. Note that Agent Option counters only increment on errors occurring if the <code>ip dhcp-relay agent-option</code> command is configured for an interface. Messages generating the errors are only dropped if the <code>ip dhcp-relay agent-option checking</code> command is configured on the interface as well as the <code>ip dhcp-relay agent-option</code> command.                           |
| Bad Remote ID        | The number of incoming DHCP Reply messages dropped due to a bad remote ID. Note that Agent Option counters only increment on errors occurring if the <code>ip dhcp-relay agent-option</code> command is configured for an interface. Messages generating the errors are only dropped if the <code>ip dhcp-relay agent-option checking</code> command is configured on the interface as well as the <code>ip dhcp-relay agent-option</code> command.                                |
| Missing Remote ID    | The number of incoming DHCP Reply messages dropped due to a missing remote ID. Note that Agent Option counters only increment on errors occurring if the <code>ip dhcp-relay agent-option</code> command is configured for an interface. Messages generating the errors are only dropped if the <code>ip dhcp-relay agent-option checking</code> command is configured on the interface as well as the <code>ip dhcp-relay agent-option</code> command.                            |

| Parameter                                                                                                 | Description                                                                                                                                                                                                                                                                                                                                                                                                                                                                                                                                                                                                 |
|-----------------------------------------------------------------------------------------------------------|-------------------------------------------------------------------------------------------------------------------------------------------------------------------------------------------------------------------------------------------------------------------------------------------------------------------------------------------------------------------------------------------------------------------------------------------------------------------------------------------------------------------------------------------------------------------------------------------------------------|
| Option Insert Failed                                                                                      | <p>The number of incoming DHCP Request messages dropped due to an error adding the DHCP Relay Agent information (option-82). This counter increments when:</p> <ul style="list-style-type: none"> <li>the DHCP Relay Agent is set to drop packets with the DHCP Relay Agent Option 82 field already filled by another DHCP Relay Agent. This policy is set with the <code>ip dhcp-relay information policy</code> command.</li> <li>there is a packet error that stops the DHCP Relay Agent from being able to append the packet with its DHCP Relay Agent Information Option (Option 82) field.</li> </ul> |
| <p>Note that the following parameters are only used on the Global VRF instance when DHCPv6 is running</p> |                                                                                                                                                                                                                                                                                                                                                                                                                                                                                                                                                                                                             |
| DHCPv6 Requests In                                                                                        | The number of incoming DHCPv6 Request messages.                                                                                                                                                                                                                                                                                                                                                                                                                                                                                                                                                             |
| DHCPv6 Replies In                                                                                         | The number of incoming DHCPv6 Reply messages.                                                                                                                                                                                                                                                                                                                                                                                                                                                                                                                                                               |
| DHCPv6 Relayed to Server                                                                                  | The number of DHCPv6 messages relayed to the server.                                                                                                                                                                                                                                                                                                                                                                                                                                                                                                                                                        |
| DHCPv6 Relayed to Client                                                                                  | The number of DHCPv6 messages relayed to the client.                                                                                                                                                                                                                                                                                                                                                                                                                                                                                                                                                        |

# show counter dhcp-server

**Overview** This command shows counters for the DHCP server on your device.  
For information on filtering and saving command output, see the [“Getting Started with AlliedWare Plus” Feature Overview and Configuration Guide](#).

**Syntax** `show counter dhcp-server`

**Mode** User Exec and Privileged Exec

**Example** To display counters for the DHCP server on your device, use the command:

```
awplus# show counter dhcp-server
```

**Output** Figure 51-4: Example output from the **show counter dhcp-server** command

|                      |       |    |
|----------------------|-------|----|
| DHCP server counters |       |    |
| DHCPDISCOVER in      | ..... | 20 |
| DHCPREQUEST in       | ..... | 12 |
| DHCPDECLINE in       | ..... | 1  |
| DHCPRELEASE in       | ..... | 0  |
| DHCPINFORM in        | ..... | 0  |
| DHCPOFFER out        | ..... | 8  |
| DHCPACK out          | ..... | 4  |
| DHCPNAK out          | ..... | 0  |
| BOOTREQUEST in       | ..... | 0  |
| BOOTREPLY out        | ..... | 0  |

**Table 2:** Parameters in the output of the **show counter dhcp-server** command

| Parameter       | Description                                                     |
|-----------------|-----------------------------------------------------------------|
| DHCPDISCOVER in | The number of Discover messages received by the DHCP server.    |
| DHCPREQUEST in  | The number of Request messages received by the DHCP server.     |
| DHCPDECLINE in  | The number of Decline messages received by the DHCP server.     |
| DHCPRELEASE in  | The number of Release messages received by the DHCP server.     |
| DHCPINFORM in   | The number of Inform messages received by the DHCP server.      |
| DHCPOFFER out   | The number of Offer messages sent by the DHCP server.           |
| DHCPACK out     | The number of Acknowledgement messages sent by the DHCP server. |

**Table 2:** Parameters in the output of the **show counter dhcp-server** command

| Parameter      | Description                                                                                                                                                                                                                                                                                                                     |
|----------------|---------------------------------------------------------------------------------------------------------------------------------------------------------------------------------------------------------------------------------------------------------------------------------------------------------------------------------|
| DHCNPAK out    | The number of Negative Acknowledgement messages sent by the DHCP server. The server sends these after receiving a request that it cannot fulfil because either there are no available IP addresses in the related address pool, or the request has come from a client that doesn't fit the network setting for an address pool. |
| BOOTREQUEST in | The number of bootp messages received by the DHCP server from bootp clients.                                                                                                                                                                                                                                                    |
| BOOTREPLY out  | The number of bootp messages sent by the DHCP server to bootp clients.                                                                                                                                                                                                                                                          |

**Related  
Commands**

[service dhcp-server](#)  
[show ip dhcp binding](#)  
[show ip dhcp server statistics](#)  
[show ip dhcp pool](#)

# show dhcp lease

**Overview** This command shows details about the leases that the DHCP client has acquired from a DHCP server for interfaces on the device.

For information on filtering and saving command output, see “Controlling “show” Command Output” in the “Getting Started with AlliedWare\_Plus” Feature Overview and Configuration Guide.

**Syntax** `show dhcp lease [<interface>]`

| Parameter                      | Description                                       |
|--------------------------------|---------------------------------------------------|
| <code>&lt;interface&gt;</code> | Interface name to display DHCP lease details for. |

**Mode** User Exec and Privileged Exec

**Example** To show the current lease expiry times for all interfaces, use the command:

```
awplus# show dhcp lease
```

To show the current lease for vlan1, use the command:

```
awplus# show dhcp lease vlan1
```

**Output** Figure 51-5: Example output from the **show dhcp lease** command

```
Interface vlan1

IP Address: 192.168.22.4
Expires: 13 Mar 2017 20:10:19
Renew: 13 Mar 2017 18:37:06
Rebind: 13 Mar 2017 19:49:29
Server:
Options:
 subnet-mask 255.255.255.0
 routers 19.18.2.100,12.16.2.17
 dhcp-lease-time 3600
 dhcp-message-type 5
 domain-name-servers 192.168.100.50,19.88.200.33
 dhcp-server-identifier 192.168.22.1
 domain-name alliedtelesis.com

Interface vlan2

IP Address: 100.8.16.4
Expires: 13 Mar 2017 20:15:39
Renew: 13 Mar 2017 18:42:25
Rebind: 13 Mar 2017 19:54:46
Server:
Options:
 subnet-mask 255.255.0.0
 routers 10.58.1.51
 dhcp-lease-time 1000
 dhcp-message-type 5
 dhcp-server-identifier 100.8.16.1
```

**Related Commands** [ip address dhcp](#)

# show ip dhcp binding

**Overview** This command shows the lease bindings that the DHCP server has allocated clients.

For information on filtering and saving command output, see the [“Getting Started with AlliedWare Plus” Feature Overview and Configuration Guide](#).

**Syntax** `show ip dhcp binding [<ip-address>|<address-pool>]`

| Parameter                         | Description                                                                                                                        |
|-----------------------------------|------------------------------------------------------------------------------------------------------------------------------------|
| <code>&lt;ip-address&gt;</code>   | IPv4 address of a leased IP address, in dotted decimal notation. This displays the lease information for the specified IP address. |
| <code>&lt;address-pool&gt;</code> | Name of an address pool. This displays the lease information for all clients within the address pool.                              |

**Mode** User Exec and Privileged Exec

**Examples** To display all leases for every client in all address pools, use the command:

```
awplus# show ip dhcp binding
```

To display the details for the leased IP address 172.16.2.16, use the command:

```
awplus# show ip dhcp binding 172.16.2.16
```

To display the leases from the address pool MyPool, use the command:

```
awplus# show ip dhcp binding MyPool
```

**Output** Figure 51-6: Example output from the **show ip dhcp binding** command

```
Pool 30_2_network Network 172.16.2.0/24
DHCP Client Entries
IP Address ClientId Type Expiry

172.16.2.100 0050.fc82.9ede Dynamic 21 Sep 2007 19:02:58
172.16.2.101 000e.a6ae.7c14 Static Infinite
172.16.2.102 000e.a6ae.7c4c Static Infinite
172.16.2.103 000e.a69a.ac91 Static Infinite
172.16.2.104 00e0.189d.5e41 Static Infinite
172.16.2.150 00e0.2b04.5800 Static Infinite
172.16.2.167 4444.4400.35c3 Dynamic 21 Sep 2007 14:58:41
```



**Related  
Commands**

- clear ip dhcp binding
- ip dhcp pool
- lease
- range
- service dhcp-server
- show ip dhcp pool

# show ip dhcp pool

**Overview** This command displays the configuration details and system usage of the DHCP address pools configured on the device.

For information on filtering and saving command output, see the [“Getting Started with AlliedWare Plus” Feature Overview and Configuration Guide](#).

**Syntax** `show ip dhcp pool [<address-pool>]`

| Parameter      | Description                                                                                          |
|----------------|------------------------------------------------------------------------------------------------------|
| <address-pool> | Name of a specific address pool. This displays the configuration of the specified address pool only. |

**Mode** User Exec and Privileged Exec

**Example** `awplus# show ip dhcp pool`

**Output** Figure 51-7: Example output from the **show ip dhcp pool** command

```
Pool p1 :
 network: 192.168.1.0/24
 address ranges:
 addr: 192.168.1.10 to 192.168.1.18
 static host addresses:
 addr: 192.168.1.12 MAC addr: 1111.2222.3333
 lease <days:hours:minutes:seconds> <1:0:0:0>
 subnet mask: 255.255.255.0 (pool's network mask)
 Probe: Default Values
 Status: Enabled [Enabled]
 Type: ARP [Ping]
 Packets: 2 [5]
 Timeout: 200 msec [200]
 Dynamic addresses:
 Total: 8
 Leased: 2
 Utilization: 25.0 %
 Static host addresses:
 Total: 1
 Leased: 1
```

**Output** Figure 51-8: Example output from the **show ip dhcp pool** command with IP address 192.168.1.12 assigned to a VLAN interface on the device:

```
Pool p1 :
network: 192.168.1.0/24
address ranges:
 addr: 192.168.1.10 to 192.168.1.18
 (interface addr 192.168.1.12 excluded)
 (static host addr 192.168.1.12 excluded)
static host addresses:
 addr: 192.168.1.12 MAC addr: 1111.2222.3333
 (= interface addr, so excluded)
lease <days:hours:minutes:seconds> <1:0:0:0>
subnet mask: 255.255.255.0 (pool's network mask)
Probe: Default Values
Status: Enabled [Enabled]
Type: ARP [Ping]
Packets: 2 [5]
Timeout: 200 msec [200]
Dynamic addresses:
Total: 8
Leased: 2
Utilization: 25.0 %
Static host addresses:
Total: 1
Leased: 1
```

**Table 3:** Parameters in the output of the **show ip dhcp pool** command

| Parameter             | Description                                                                                                                                                                                                                                                                                                                                                                                           |
|-----------------------|-------------------------------------------------------------------------------------------------------------------------------------------------------------------------------------------------------------------------------------------------------------------------------------------------------------------------------------------------------------------------------------------------------|
| Pool                  | Name of the pool.                                                                                                                                                                                                                                                                                                                                                                                     |
| network               | Subnet and mask length of the pool.                                                                                                                                                                                                                                                                                                                                                                   |
| address ranges        | Individual IP addresses and address ranges configured for the pool. The DHCP server can offer clients an IP address from within the specified ranges only.<br>Any of these addresses that match an interface address on the device, or a static host address configured in the pool, will be automatically excluded from the range, and a message to this effect will appear beneath the range entry. |
| static host addresses | The static host addresses configured on the pool. Each IP address is permanently assigned to the client with the matching MAC address.<br>Any of these addresses that match an interface address on the device will be automatically excluded, and a message to this effect will appear beneath the static host entry.                                                                                |

**Table 3:** Parameters in the output of the **show ip dhcp pool** command (cont.)

| Parameter                          | Description                                                                                                                          |
|------------------------------------|--------------------------------------------------------------------------------------------------------------------------------------|
| lease<br><days:hours:minutes>      | The lease duration for address allocated by this pool.                                                                               |
| domain                             | The domain name sent by the pool to clients. This is the domain name that the client should use when resolving host names using DNS. |
| subnet mask                        | The subnet mask sent by the pool to clients.                                                                                         |
| Probe - Status                     | Whether lease probing is enabled or disabled.                                                                                        |
| Probe - Type                       | The lease probe type configured. Either ping or ARP.                                                                                 |
| Probe - Packets                    | The number of packets sent for each lease probe in the range 0 to 10.                                                                |
| Probe - Timeout                    | The timeout value in milliseconds to wait for a response after each probe packet is sent. In the range 50 to 5000.                   |
| dns servers                        | The DNS server addresses sent to by the pool to clients.                                                                             |
| default-router(s)                  | The default router addresses sent by the pool to clients.                                                                            |
| user-defined options               | The list of user-defined options sent by the pool to clients.                                                                        |
| Dynamic addresses-<br>Total        | The total number of IP addresses that have been configured in the pool for dynamic allocation to DHCP clients.                       |
| Dynamic addresses-<br>Leased       | The number of IP addresses in the pool that have been dynamically allocated (leased) to DHCP clients.                                |
| Dynamic addresses -<br>Utilization | The percentage of IP addresses in the pool that are currently dynamically allocated to clients.                                      |
| Static host addresses-<br>Total    | The number of static IP addresses configured in the pool for specific DHCP client hosts.                                             |
| Static host addresses<br>- Leased  | The number of static IP addresses assigned to specific DHCP client hosts.                                                            |

**Related  
Commands**

- ip dhcp pool
- probe enable
- probe packets
- probe timeout
- probe type
- range
- service dhcp-server
- subnet-mask

# show ip dhcp-relay

**Overview** This command shows the configuration of the DHCP Relay Agent on each interface.

For information on filtering and saving command output, see the [“Getting Started with AlliedWare Plus” Feature Overview and Configuration Guide](#).

**Syntax** `show ip dhcp-relay [interface <interface-name>]`

**Syntax (VRF-lite)** `show ip dhcp-relay [vrf <name>|global] [interface <interface-name>]`

| Parameter        | Description                                                                                          |
|------------------|------------------------------------------------------------------------------------------------------|
| <interface-name> | Name of a specific interface. This displays the DHCP configuration for the specified interface only. |
| vrf              | Apply this command to a VRF instance.                                                                |
| <vrf-name>       | The name of the VRF instance.                                                                        |
| global           | The Global VRF instance.                                                                             |

**Mode** User Exec and Privileged Exec

**Example** To display the DHCP Relay Agent’s configuration on the interface `vlan100`, use the command:

```
awplus# show ip dhcp-relay interface vlan100
```

**Output** Figure 51-9: Example output from the **show ip dhcp-relay** command

```
DHCP Relay Service is enabled

vlan100 is up, line protocol is up
Maximum hop count is 10
Insertion of Relay Agent Option is disabled
Checking of Relay Agent Option is disabled
The Remote Id string for Relay Agent Option is 0000.cd28.074c
Relay information policy is to append new relay agent
information
List of servers : 192.168.1.200
```

**Output (VRF-lite)** Figure 51-10: Example output from the **show ip dhcp-relay** command applied for VRF instance red

```
DHCP Relay Service is enabled

[VRF: red]
vlan2 is up, line protocol is up
Maximum hop count is 10
Maximum DHCP message length is 1400
Insertion of Relay Agent Option is enabled
Checking of Relay Agent Option is disabled
The Remote Id string for Relay Agent Option is 0000.cd28.074c
Relay Information policy is to replace existing relay agent
information
List of servers : 192.168.1.3
```

**Related Commands**

- [ip dhcp-relay agent-option](#)
- [ip dhcp-relay agent-option checking](#)
- [ip dhcp-relay information policy](#)
- [ip dhcp-relay maxhops](#)
- [ip dhcp-relay server-address](#)

**Command changes** Version 5.4.6-2.1: VRF-lite support added.

# show ip dhcp server statistics

**Overview** This command shows statistics related to the DHCP server.

You can display the server counters using the [show counter dhcp-server](#) command as well as with this command.

For information on filtering and saving command output, see the [“Getting Started with AlliedWare Plus” Feature Overview and Configuration Guide](#).

**Syntax** show ip dhcp server statistics

**Mode** User Exec and Privileged Exec

**Example** To display the server statistics, use the command:

```
awplus# show ip dhcp server statistics
```

**Output** Figure 51-11: Example output from the **show ip dhcp server statistics** command

```
DHCP server counters
DHCPDISCOVER in 20
DHCPREQUEST in 12
DHCPDECLINE in 1
DHCPRELEASE in 0
DHCPINFORM in 0
DHCPOFFER out 8
DHCPACK out 4
DHCPNAK out 0
BOOTREQUEST in 0
BOOTREPLY out 0
DHCPLEASEQUERY in 0
DHCPLEASEUNKNOWN out 0
DHCPLEASEACTIVE out 0
DHCPLEASEUNASSIGNED out 0
```

**Table 4:** Parameters in the output of the **show ip dhcp server statistics** command

| Parameter       | Description                                                  |
|-----------------|--------------------------------------------------------------|
| DHCPDISCOVER in | The number of Discover messages received by the DHCP server. |
| DHCPREQUEST in  | The number of Request messages received by the DHCP server.  |
| DHCPDECLINE in  | The number of Decline messages received by the DHCP server.  |



**Table 4:** Parameters in the output of the **show ip dhcp server statistics** command (cont.)

| Parameter               | Description                                                                                                                                                                                                                                                                                                                     |
|-------------------------|---------------------------------------------------------------------------------------------------------------------------------------------------------------------------------------------------------------------------------------------------------------------------------------------------------------------------------|
| DHCPRELEASE in          | The number of Release messages received by the DHCP server.                                                                                                                                                                                                                                                                     |
| DHCPINFORM in           | The number of Inform messages received by the DHCP server.                                                                                                                                                                                                                                                                      |
| DHCPOFFER out           | The number of Offer messages sent by the DHCP server.                                                                                                                                                                                                                                                                           |
| DHCPACK out             | The number of Acknowledgement messages sent by the DHCP server.                                                                                                                                                                                                                                                                 |
| DHCPNAK out             | The number of Negative Acknowledgement messages sent by the DHCP server. The server sends these after receiving a request that it cannot fulfil because either there are no available IP addresses in the related address pool, or the request has come from a client that doesn't fit the network setting for an address pool. |
| BOOTREQUEST in          | The number of bootp messages received by the DHCP server from bootp clients.                                                                                                                                                                                                                                                    |
| BOOTREPLY out           | The number of bootp messages sent by the DHCP server to bootp clients.                                                                                                                                                                                                                                                          |
| DHCPLEASEQUERY in       | The number of Lease Query messages received by the DHCP server from DHCP Relay Agents.                                                                                                                                                                                                                                          |
| DHCPLEASEUNKNOWN out    | The number of Lease Unknown messages sent by the DHCP server to DHCP Relay Agents.                                                                                                                                                                                                                                              |
| DHCPLEASEACTIVE out     | The number of Lease Active messages sent by the DHCP server to DHCP Relay Agents.                                                                                                                                                                                                                                               |
| DHCPLEASEUNASSIGNED out | The number of Lease Unassigned messages sent by the DHCP server to DHCP Relay Agents.                                                                                                                                                                                                                                           |

**Related Commands**

- [show counter dhcp-server](#)
- [service dhcp-server](#)
- [show ip dhcp binding](#)
- [show ip dhcp pool](#)

# show ip dhcp server summary

**Overview** This command shows the current configuration of the DHCP server. This includes:

- whether the DHCP server is enabled
- whether the DHCP server is configured to ignore BOOTP requests
- whether the DHCP server is configured to support DHCP lease queries
- the details of any user-defined options
- a list of the names of all DHCP address pools currently configured

This show command does not include any configuration details of the address pools. You can display these using the [show ip dhcp pool](#) command.

For information on filtering and saving command output, see the [“Getting Started with AlliedWare Plus” Feature Overview and Configuration Guide](#).

**Syntax** `show ip dhcp server summary`

**Mode** User Exec and Privileged Exec

**Example** To display the current configuration of the DHCP server, use the command:

```
awplus# show ip dhcp server summary
```

**Output** Figure 51-12: Example output from the **show ip dhcp server summary** command

```
DHCP Server service is disabled
BOOTP ignore is disabled
DHCP leasequery support is disabled
Pool list: p2
```

**Related Commands**

- [ip dhcp leasequery enable](#)
- [ip dhcp pool](#)
- [service dhcp-server](#)

# subnet-mask

**Overview** This command sets the subnet mask option for a DHCP address pool you are configuring. Use this command to specify the client's subnet mask as defined in RFC 950. This sets the subnet details using the pre-defined option 1. Note that if you create a user-defined option 1 using the [option](#) command, then you will override any settings created with this command. If you do not specify a subnet mask using this command, then the pool's network mask (specified using the [next-server](#) command) is applied.

The **no** variant of this command removes a subnet mask option from a DHCP pool. The pool reverts to using the pool's network mask.

**Syntax** `subnet-mask <mask>`  
`no subnet-mask`

| Parameter                 | Description                                         |
|---------------------------|-----------------------------------------------------|
| <code>&lt;mask&gt;</code> | Valid IPv4 subnet mask, in dotted decimal notation. |

**Mode** DHCP Configuration

**Examples** To set the subnet mask option to 255.255.255.0 for DHCP pool P2, use the commands:

```
awplus# configure terminal
awplus(config)# ip dhcp pool P2
awplus(dhcp-config)# subnet-mask 255.255.255.0
```

To remove the subnet mask option from DHCP pool P2, use the commands:

```
awplus# configure terminal
awplus(config)# ip dhcp pool P2
awplus(dhcp-config)# no subnet-mask
```

**Related Commands**

- [default-router](#)
- [dns-server](#)
- [domain-name](#)
- [next-server](#)
- [option](#)
- [service dhcp-server](#)
- [show ip dhcp pool](#)

# 52

# DHCP for IPv6 (DHCPv6) Commands

## Introduction

**Overview** This chapter provides an alphabetical reference for commands used to configure DHCPv6. For more information, see the [DHCPv6 Feature Overview and Configuration Guide](#).

DHCPv6 is a network protocol used to configure IPv6 hosts with IPv6 addresses and IPv6 prefixes for an IPv6 network. DHCPv6 is used instead of SLAAC (Stateless Address Autoconfiguration) at sites where centralized management of IPv6 hosts is needed. IPv6 routers require automatic configuration of IPv6 addresses and IPv6 prefixes.

DHCPv6 Prefix Delegation provides automatic configuration of IPv6 addresses and IPv6 prefixes.

Note that DHCPv6 client does not support tunnel interface.

For information on filtering and saving command output, see the [“Getting Started with AlliedWare Plus” Feature Overview and Configuration Guide](#).

**NOTE:** The IPv6 addresses shown use the address space 2001:0db8::/32, defined in RFC 3849 for documentation purposes. These addresses should not be used for practical networks (other than for testing purposes) nor should they appear on any public network.

- Command List**
- [“address prefix”](#) on page 2398
  - [“address range”](#) on page 2400
  - [“clear counter ipv6 dhcp-client”](#) on page 2402
  - [“clear counter ipv6 dhcp-server”](#) on page 2403
  - [“clear ipv6 dhcp binding”](#) on page 2404
  - [“clear ipv6 dhcp client”](#) on page 2406
  - [“dns-server \(DHCPv6\)”](#) on page 2407
  - [“domain-name \(DHCPv6\)”](#) on page 2409

- [“ipv6 address \(DHCPv6 PD\)”](#) on page 2410
- [“ipv6 address dhcp”](#) on page 2413
- [“ipv6 dhcp client pd”](#) on page 2415
- [“ipv6 dhcp option”](#) on page 2417
- [“ipv6 dhcp pool”](#) on page 2419
- [“ipv6 dhcp server”](#) on page 2421
- [“ipv6 local pool”](#) on page 2422
- [“ipv6 nd prefix \(DHCPv6\)”](#) on page 2424
- [“link-address”](#) on page 2426
- [“option \(DHCPv6\)”](#) on page 2428
- [“prefix-delegation pool”](#) on page 2430
- [“show counter ipv6 dhcp-client”](#) on page 2432
- [“show counter ipv6 dhcp-server”](#) on page 2434
- [“show ipv6 dhcp”](#) on page 2436
- [“show ipv6 dhcp binding”](#) on page 2437
- [“show ipv6 dhcp interface”](#) on page 2440
- [“show ipv6 dhcp pool”](#) on page 2442
- [“sntp-address”](#) on page 2444

# address prefix

**Overview** Use this command in DHCPv6 Configuration mode to specify an address prefix for address assignment with DHCPv6 server pool configuration.

Use the **no** variant of this command to remove the address prefix from the DHCPv6 server pool.

**Syntax** address prefix <ipv6-prefix/prefix-length> [lifetime {<valid-time>|infinite} {<preferred-time>|infinite}]  
no address prefix <ipv6-prefix/prefix-length>

| Parameter                   | Description                                                                                                                                                                                                                                                                                                                                                                                                 |
|-----------------------------|-------------------------------------------------------------------------------------------------------------------------------------------------------------------------------------------------------------------------------------------------------------------------------------------------------------------------------------------------------------------------------------------------------------|
| <ipv6-prefix/prefix-length> | Specify an IPv6 prefix and prefix length. The prefix length indicates the length of the IPv6 prefix assigned to the pool. The IPv6 address uses the format X::X:X/Prefix-Length. The prefix-length is usually set between 0 and 64.                                                                                                                                                                         |
| lifetime                    | Specify a time period for the hosts to remember router advertisements (RAs). If you specify the optional lifetime parameter with this command then you must also specify a <i>valid-time</i> and a <i>preferred-time</i> value. See the Usage notes below this parameter table for a description of preferred and valid lifetimes and how these determine deprecated or invalid IPv6 addresses upon expiry. |
| <valid-time>                | Specify a valid lifetime in seconds in the range <5-315360000>. The default valid lifetime is 2592000 seconds.                                                                                                                                                                                                                                                                                              |
| infinite                    | Specify an infinite valid lifetime or an infinite preferred lifetime, or both, when using this keyword.                                                                                                                                                                                                                                                                                                     |
| <preferred-time>            | Specify a preferred lifetime in seconds in the range <5-315360000>. The default preferred lifetime is 604800 seconds.                                                                                                                                                                                                                                                                                       |

**Mode** DHCPv6 Configuration

**Default** The default valid lifetime is 2592000 seconds and the default preferred lifetime is 604800 seconds.

**Usage** This command creates a pool of prefixes from which addresses are assigned to clients on request, and allocates a network prefix from which the DHCPv6 Server leases addresses. This command is an alternative to using a range set using the [address range](#) command.

The DHCPv6 Server selects an IPv6 address from the range available allocated by the IPv6 prefix, randomly generating the suffix of the IPv6 address, with the specified preferred and valid lifetime leases. Leased IPv6 address are found in the

DHCPv6 Server REPLY packet, which is located within the IANA (Identity Association for Non-temporary Addresses) IA address field in the **REPLY** message.

Preferred IPv6 addresses or prefixes are available to interfaces for unrestricted use and are deprecated when the preferred timer expires.

Deprecated IPv6 addresses and prefixes are available for use and are discouraged but not forbidden. A deprecated address or prefix should not be used as a source address or prefix, but packets sent from deprecated addresses or prefixes are delivered as expected.

An IPv6 address or prefix becomes invalid and is not available to an interface when the valid lifetime timer expires. Invalid addresses or prefixes should not appear as the source or destination for a packet.

**Examples** To add IPv6 address prefix 2001:0db8:1::/48 for DHCPv6 server pool configuration, use the following commands:

```
awplus# configure terminal
awplus(config)# ipv6 dhcp pool pool1
awplus(config-dhcp6)# address prefix 2001:0db8:1::/48
```

To remove a configured IPv6 address prefix for DHCPv6 server pool configuration, use the following commands:

```
awplus# configure terminal
awplus(config)# ipv6 dhcp pool pool1
awplus(config-dhcp6)# no address prefix 2001:0db8:1::/48
```

**Related  
Commands** [address range](#)  
[ipv6 dhcp pool](#)

**Validation  
Commands** [show ipv6 dhcp binding](#)  
[show ipv6 dhcp pool](#)

# address range

**Overview** Use this command in DHCPv6 Configuration mode to specify an address range for address assignment with DHCPv6 server pool configuration.

Use the **no** variant of this command to remove an address range from the DHCPv6 server pool.

**Syntax** `address range <first-ipv6-address>  
<last-ipv6-address>[lifetime {<valid-time>|infinite}  
{<preferred-time>|infinite}]`  
`no address range <first-ipv6-address> <last-ipv6-address>`

| Parameter                               | Description                                                                                                                                                                                                                                                                                                                                                                              |
|-----------------------------------------|------------------------------------------------------------------------------------------------------------------------------------------------------------------------------------------------------------------------------------------------------------------------------------------------------------------------------------------------------------------------------------------|
| <code>&lt;first-ipv6-address&gt;</code> | Specify the first IPv6 address of the IPv6 address range, in hexadecimal notation in the format X:X:X:X.                                                                                                                                                                                                                                                                                 |
| <code>&lt;last-ipv6-address&gt;</code>  | Specify the last IPv6 address of the IPv6 address range, in hexadecimal notation in the format X:X:X:X.                                                                                                                                                                                                                                                                                  |
| <code>lifetime</code>                   | Optional. Specify a time period for the hosts to remember router advertisements (RAs).<br>If you specify this parameter then you must also specify a <i>valid-time</i> and a <i>preferred-time</i> value.<br>See the Usage notes below this parameter table for a description of preferred and valid lifetimes and how these determine deprecated or invalid IPv6 addresses upon expiry. |
| <code>&lt;valid-time&gt;</code>         | Specify a valid lifetime in seconds in the range <5-31536000>.<br>The default valid lifetime is 2592000 seconds.                                                                                                                                                                                                                                                                         |
| <code>infinite</code>                   | Specify an infinite valid lifetime or an infinite preferred lifetime, or both, when using this keyword.                                                                                                                                                                                                                                                                                  |
| <code>&lt;preferred-time&gt;</code>     | Specify a preferred lifetime in seconds in the range <5-31536000>.<br>The default preferred lifetime is 604800 seconds.                                                                                                                                                                                                                                                                  |

**Default** The default valid lifetime is 2592000 seconds and the default preferred lifetime is 604800 seconds.

**Mode** DHCPv6 Configuration

**Usage** Preferred IPv6 addresses or prefixes are available to interfaces for unrestricted use and are deprecated when the preferred timer expires.

Deprecated IPv6 addresses and prefixes are available for use and are discouraged but not forbidden. A deprecated address or prefix should not be used as a source address or prefix, but packets sent from deprecated addresses or prefixes are delivered as expected.



An IPv6 address or prefix becomes invalid and is not available to an interface when the valid lifetime timer expires. Invalid addresses or prefixes should not appear as the source or destination for a packet.

**Examples** To add the IPv6 address range 2001:0db8:1::1 to 2001:0db8:1fff::1 for DHCPv6 server pool configuration, use the following commands:

```
awplus# configure terminal
awplus(config)# ipv6 dhcp pool pool1
awplus(config-dhcp6)# address range 2001:0db8:1::1
2001:0db8:1fff::1
```

To remove a configured IPv6 address range for DHCPv6 server pool configuration, use the following commands:

```
awplus# configure terminal
awplus(config)# ipv6 dhcp pool pool1
awplus(config-dhcp6)# no address range
```

**Related  
Commands** [address prefix](#)  
[ipv6 dhcp pool](#)

**Validation  
Commands** [show ipv6 dhcp binding](#)  
[show ipv6 dhcp pool](#)

# clear counter ipv6 dhcp-client

**Overview** Use this command in Privileged Exec mode to clear DHCPv6 client counters.

**Syntax** `clear counter ipv6 dhcp-client`

**Mode** Privileged Exec

**Example** To clear DHCPv6 client counters, use the following command:

```
awplus# clear counter ipv6 dhcp-client
```

**Related  
Commands** [show counter ipv6 dhcp-client](#)

# clear counter ipv6 dhcp-server

**Overview** Use this command in Privileged Exec mode to clear DHCPv6 server counters.

**Syntax** `clear counter ipv6 dhcp-server`

**Mode** Privileged Exec

**Example** To clear DHCPv6 server counters, use the following command:

```
awplus# clear counter ipv6 dhcp-server
```

**Related  
Commands** [show counter ipv6 dhcp-server](#)

# clear ipv6 dhcp binding

**Overview** Use this command in Privileged Exec mode to clear either a specific lease binding or the lease bindings as specified by the command parameters. The command will only take effect on dynamically allocated bindings, not statically configured bindings. This command clears binding entries on the DHCPv6 server binding table.

**Syntax** `clear ipv6 dhcp binding {ipv6 <prefix>|duid <DUID>|all|pool <name>}`

| Parameter                        | Description                                                                                                                                                                          |
|----------------------------------|--------------------------------------------------------------------------------------------------------------------------------------------------------------------------------------|
| <code>ipv6 &lt;prefix&gt;</code> | Optional. Specify the IPv6 prefix of the DHCPv6 client, in hexadecimal notation in the format X:X::X:X.                                                                              |
| <code>duid &lt;DUID&gt;</code>   | Specify the DUID (DHCPv6 unique ID) of the DHCPv6 client.                                                                                                                            |
| <code>all</code>                 | All DHCPv6 bindings.                                                                                                                                                                 |
| <code>pool &lt;name&gt;</code>   | Description used to identify DHCPv6 server address pool. Valid characters are any printable character. If the name contains spaces then you must enclose these in "quotation marks". |

**Mode** Privileged Exec

**Usage** A specific binding may be deleted by **ipv6** address or **duid** address, or several bindings may be deleted at once using **all** or **pool**.

Note that if you specify to clear the **ipv6** or **duid** address of what is actually a static DHCPv6 binding, an error message is displayed. If **all** or **pool** are specified and one or more static DHCPv6 bindings exist within those addresses, any dynamic entries within those addresses are cleared but any static entries are not cleared.

The `clear ipv6 dhcp binding` command is used as a server function. A binding table entry on the DHCPv6 server is automatically:

- Created whenever a prefix is delegated to a client from the configuration pool.
- Updated when the client renews, rebinds, or confirms the prefix delegation.
- Deleted when the client releases all the prefixes in the binding, all prefix lifetimes have expired, or when a user runs the `clear ipv6 dhcp binding` command.

If the **clear ipv6 dhcp binding** command is used with the optional IPv6 address parameter, only the binding for the specified client is deleted. If the **clear ipv6 dhcp binding** command is used without the optional IPv6 address parameter, then all automatic client bindings are deleted from the DHCPv6 bindings table.

**Example** To clear all dynamic DHCPv6 server binding entries, use the command:

```
awplus# clear ipv6 dhcp binding all
```

**Output** Figure 52-1: Example output from the **clear ipv6 dhcp binding all** command

```
awplus#clear ipv6 dhcp binding all
% Deleted 1 entries
```

**Related  
Commands** [show ipv6 dhcp binding](#)

# clear ipv6 dhcp client

**Overview** Use this command in Privileged Exec mode to restart a DHCPv6 client on an interface.

**Syntax** `clear ipv6 dhcp client <interface>`

| Parameter                      | Description                                               |
|--------------------------------|-----------------------------------------------------------|
| <code>&lt;interface&gt;</code> | Specify the interface name to restart a DHCPv6 client on. |

**Mode** Privileged Exec

**Example** To restart a DHCPv6 client on interface vlan1, use the following command:

```
awplus# clear ipv6 dhcp client vlan1
```

**Related Commands** [show ipv6 dhcp binding](#)

# dns-server (DHCPv6)

**Overview** Use this command to add a Domain Name System (DNS) server to the DHCPv6 address pool you are configuring. You can use this command multiple times to create a list of DNS name servers available to the client. This sets the DNS server details using the pre-defined option 6. Note that if you add a user-defined option 6 using the [option \(DHCPv6\)](#) command, then you will override any settings created with this command.

Use the **no** variant of this command to remove either the specified DNS server or all DNS servers from the DHCPv6 pool.

**Syntax** `dns-server <ipv6-address>`  
`no dns-server [<ipv6-address>]`

| Parameter                         | Description                                                                                                                                                                                                                                                                                                           |
|-----------------------------------|-----------------------------------------------------------------------------------------------------------------------------------------------------------------------------------------------------------------------------------------------------------------------------------------------------------------------|
| <code>&lt;ipv6-address&gt;</code> | Specify an IPv6 address of the DNS server, in hexadecimal notation in the format <code>X:X::X:X</code> . This parameter is required when adding a DNS server to the DHCPv6 address pool. All DNS servers are removed from the DHCPv6 pool if you enter the <code>no dns-server</code> command without this parameter. |

**Mode** DHCPv6 Configuration

**Examples** To add the DNS server with the assigned IPv6 address `2001:0db8:3000:3000::32` to the DHCPv6 server pool named `P2`, use the following commands:

```
awplus# configure terminal
awplus(config)# ipv6 dhcp pool P2
awplus(dhcpv6-config)# dns-server 2001:0db8:3000:3000::32
```

To remove the DNS server with the assigned IPv6 address `2001:0db8:3000:3000::32` from the DHCPv6 server pool named `P2`, use the following commands:

```
awplus# configure terminal
awplus(config)# ipv6 dhcp pool P2
awplus(dhcpv6-config)# no dns-server 2001:0db8:3000:3000::32
```

To remove all DNS servers from the DHCPv6 server pool named `P2`, use the following commands:

```
awplus# configure terminal
awplus(config)# ipv6 dhcp pool P2
awplus(dhcpv6-config)# no dns-server
```

**Related  
Commands**    `ipv6 dhcp pool`  
                  `option (DHCPv6)`  
                  `show ipv6 dhcp pool`



# domain-name (DHCPv6)

**Overview** Use this command in DHCPv6 Configuration mode to add a domain name to the DHCPv6 server address pool you are configuring.

Use the **no** variant of this command to remove a domain name from the address pool.

**Syntax** `domain-name <domain-name>`  
`no domain-name`

| Parameter                        | Description                                                                                                                                                                                      |
|----------------------------------|--------------------------------------------------------------------------------------------------------------------------------------------------------------------------------------------------|
| <code>&lt;domain-name&gt;</code> | Specify the domain name you wish to assign the DHCPv6 server address pool. Valid characters are printable characters. If the name contains spaces then you must enclose it in "quotation marks". |

**Mode** DHCPv6 Configuration

**Usage** This command specifies the domain name that a client should use when resolving host names using the Domain Name System, and sets the domain name details using the pre- defined option 15. Note that if you add a user-defined option 15 using the [option \(DHCPv6\)](#) command, then you will override any settings created with this command.

**Examples** To add the domain name `Engineering` to DHCPv6 server pool `P2`, use the commands:

```
awplus# configure terminal
awplus(config)# ipv6 dhcp pool P2
awplus(dhcpv6-config)# domain-name Engineering
```

To remove the domain name `Engineering` from DHCPv6 server pool `P2`, use the commands:

```
awplus# configure terminal
awplus(config)# ipv6 dhcp pool P2
awplus(dhcpv6-config)# no domain-name Engineering
```

**Related Commands** [dns-server \(DHCPv6\)](#)  
[option \(DHCPv6\)](#)  
[show ipv6 dhcp pool](#)

# ipv6 address (DHCPv6 PD)

**Overview** Use this command in Interface Configuration mode for a VLAN interface to append an IPv6 address suffix to the IPv6 prefix provided by a DHCPv6 Prefix Delegation (PD) server.

Use the **no** variant of this command to remove the IPv6 address assigned and disable IPv6. Note that if no global addresses are left after removing the IPv6 address then IPv6 is disabled.

**Syntax** `ipv6 address [<ipv6-prefix-name>] <ipv6-addr/prefix-length> [eui64]`  
`no ipv6 address [<ipv6-prefix-name>] <ipv6-addr/prefix-length> [eui64]`

| Parameter                                    | Description                                                                                                                                                                                     |
|----------------------------------------------|-------------------------------------------------------------------------------------------------------------------------------------------------------------------------------------------------|
| <code>&lt;ipv6-prefix-name&gt;</code>        | The IPv6 prefix name advertised on the router advertisement message sent from the device. The IPv6 prefix name is delegated from the DHCPv6 Server configured for DHCPv6 Prefix-Delegation.     |
| <code>&lt;ipv6-addr/prefix-length&gt;</code> | Specifies the IPv6 address to be set, for example <code>::1/64</code> . The IPv6 address uses the format <code>X::X:X/Prefix-Length</code> . The prefix-length is usually set between 0 and 64. |
| <code>[eui64]</code>                         | EUI-64 is a method of automatically deriving the lower 64 bits of an IPv6 address, based on the switch's MAC address.                                                                           |

**Mode** Interface Configuration for a VLAN interface or Interface Configuration for a PPP interface.

**Usage** When specifying the **eui64** parameter, the interface identifier of the IPv6 address is derived from the MAC address of the device.

For more information about EUI64, see the [IPv6 Feature Overview and Configuration Guide](#).

**Examples** To configure a PD prefix named `prefix1` on interface `vlan1` and then add an IPv6 address, use the following commands:

```
awplus# configure terminal
awplus(config)# interface vlan1
awplus(config-if)# ipv6 enable
awplus(config-if)# ipv6 dhcp client pd prefix1
awplus(config-if)# ipv6 address prefix1::1/64
```

In this example, the prefix will be assigned from the pool on the PD client. The host portion or suffix will be `::1` for the last 64 bits.

To configure a PD prefix named `prefix1` on interface `vlan1` and then add an IPv6 address using EUI-64 identifiers, use the following commands:

```
awplus# configure terminal
awplus(config)# interface vlan1
awplus(config-if)# ipv6 enable
awplus(config-if)# ipv6 dhcp client pd prefix1
awplus(config-if)# ipv6 address prefix1/64 eui64
```

In this example, the prefix will be assigned from the pool on the PD client. The host portion or suffix is created from the EUI-64 identifier of the interface for the last 64 bits.

To assign the IPv6 address `2001:0db8::a2/48` to the VLAN interface `vlan2`, use the following commands:

```
awplus# configure terminal
awplus(config)# interface vlan2
awplus(config-if)# ipv6 address 2001:0db8::a2/48
```

To remove the IPv6 address `2001:0db8::a2/48` from the VLAN interface `vlan2`, use the following commands:

```
awplus# configure terminal
awplus(config)# interface vlan2
awplus(config-if)# no ipv6 address 2001:0db8::a2/48
```

To assign the IPv6 address to the PPP interface `ppp0`, use the following commands:

```
awplus# configure terminal
awplus(config)# interface ppp0
awplus(config-fr-subif)# ipv6 address 2001:0db8::a2/64
```

To remove the IPv6 address `2001:0db8::a2/64` from the PPP interface `ppp0`, use the following commands:

```
awplus# configure terminal
awplus(config)# interface ppp0
awplus(config-if)# no ipv6 address 2001:0db8::a2/64
```

To assign the **eui64** derived address in the prefix `2001:db8::/64` to VLAN interface `vlan2`, use the following commands:

```
awplus# configure terminal
awplus(config)# interface vlan2
awplus(config-if)# ipv6 address 2001:0db8::/64 eui64
```

To remove the **eui64** derived address in the prefix `2001:db8::/32` from VLAN interface `vlan2`, use the following commands:

```
awplus# configure terminal
awplus(config)# interface vlan2
awplus(config)# interface vlan2
awplus(config-if)# no ipv6 address 2001:0db8::/64 eui64
```

**Validation  
Commands**

```
show running-config
show ipv6 dhcp binding
show ipv6 interface brief
show ipv6 route
```

**Related  
Commands**

```
ipv6 dhcp client pd
ipv6 dhcp pool
ipv6 local pool
ipv6 nd prefix (DHCPv6)
prefix-delegation pool
```

# ipv6 address dhcp

**Overview** Use this command to activate the DHCPv6 client on the interface that you are configuring. This allows the interface to use the DHCPv6 client to obtain its IPv6 configuration details from a DHCPv6 server on its connected network.

The command also enables IPv6 on the interface, which creates an EUI-64 link-local address as well as enabling RA processing and SLAAC.

Use the **no** variant of this command to stop the interface from obtaining IPv6 configuration details from a DHCPv6 server.

The DHCPv6 client supports the following IP configuration options:

- Option 1 - the subnet mask for your device.
- Option 3 - a list of default routers.
- Option 6 - a list of DNS servers. This list appends the DNS servers set on your device with the [dns-server \(DHCPv6\)](#) command.
- Option 15 - a domain name used to resolve host names. This option replaces any domain name that you have set with the [domain-name \(DHCPv6\)](#) command.
- Option 51 - lease expiration time.

**Syntax** `ipv6 address dhcp [default-route-to-server]`  
`no ipv6 address dhcp`

**Mode** Interface Configuration for a VLAN interface, a local loopback interface, or a PPP interface.

**Usage** Use the **default-route-to-server** option to allow the automatic configuration of a default route to the DHCPv6 server. Note that this option is not enabled by default when you enable the DHCP client on an interface.

**Examples** To set the interface `vlan10` to use DHCPv6 to obtain an IPv6 address, use the commands:

```
awplus# configure terminal
awplus(config)# interface vlan10
awplus(config-if)# ipv6 enable
awplus(config-if)# ipv6 address dhcp
```

To stop the interface `vlan10` from using DHCPv6 to obtain its IPv6 address, use the commands:

```
awplus# configure terminal
awplus(config)# interface vlan10
awplus(config-if)# no ipv6 address dhcp
```

To set the PPP interface ppp0 to use DHCPv6 to obtain an IPv6 address, use the commands:

```
awplus# configure terminal
awplus(config)# interface ppp0
awplus(config-if)# ipv6 address dhcp
```

To stop the PPP interface ppp0 from using DHCPv6 to obtain its IPv6 address, use the commands:

```
awplus# configure terminal
awplus(config)# interface ppp0
awplus(config-if)# no ipv6 address dhcp
```

**Related  
Commands**

[clear ipv6 dhcp client](#)  
[ipv6 address](#)  
[ipv6 address \(DHCPv6 PD\)](#)  
[show ipv6 dhcp interface](#)  
[show running-config](#)

# ipv6 dhcp client pd

**Overview** Use this command in Interface Configuration mode to enable the DHCPv6 client process and enable requests for prefix delegation through the interface that you are configuring.

Use the **no** variant of this command to disable requests for prefix delegation. This is the default setting.

For further information about DHCPv6 Prefix Delegation, which is used to automate the process of assigning prefixes, see the [DHCPv6 Feature Overview and Configuration Guide](#).

**Syntax** `ipv6 dhcp client pd <prefix-name> <default-route-to-server>`  
`no ipv6 dhcp client pd`

| Parameter                                    | Description                                                                                                                                                   |
|----------------------------------------------|---------------------------------------------------------------------------------------------------------------------------------------------------------------|
| <code>&lt;prefix-name&gt;</code>             | Specify an IPv6 general prefix name. Valid characters are any printable character. If the name contains spaces then you must enclose it in "quotation marks". |
| <code>&lt;default-route-to-server&gt;</code> | Specify the default route to the DHCP server                                                                                                                  |

**Mode** Interface Configuration

**Default** Prefix delegation is disabled by default on an interface.

**Usage** Entering the **ipv6 dhcp client pd** command starts the DHCPv6 client process if not already running, and enables requests for prefix delegation through the interface on which the command is configured.

When prefix delegation is enabled and a prefix is acquired, the prefix is stored in the IPv6 prefix pool with an internal name defined by the required `<prefix-name>` placeholder parameter. The [ipv6 address](#) command can then refer to the prefixes stored in the IPv6 prefix pool.

**Examples** To enable prefix delegation with the prefix name `prefix-name` on the VLAN interface `vlan2`, use the following commands:

```
awplus# configure terminal
awplus(config)# interface vlan2
awplus(config-if)# ipv6 enable
awplus(config-if)# ipv6 dhcp client pd my-prefix-name
```

To disable prefix delegation on the VLAN interface vlan2, use the following commands:

```
awplus# configure terminal
awplus(config)# interface vlan2
awplus(config-if)# no ipv6 dhcp client pd
```

**Related  
Commands**

- ipv6 enable
- clear ipv6 dhcp client
- ipv6 address (DHCPv6 PD)
- ipv6 nd prefix (DHCPv6)
- show ipv6 dhcp binding
- show ipv6 dhcp interface



# ipv6 dhcp option

**Overview** Use this command in Global Configuration mode to create a user-defined DHCPv6 option. You can then use this option when configuring a DHCPv6 server address pool, by using the [option \(DHCPv6\)](#) command.

Options with the same number as one of the pre-defined options override the standard option definition. The pre-defined options use the option numbers 1, 3, 6, 15, and 51.

Use the **no** variant of this command to remove either the specified user-defined option. This also removes user-defined options from the associated DHCPv6 server address pools.

**Syntax** `ipv6 dhcp option <1-254> [name <option-name>] [<option-type>]`  
`no ipv6 dhcp option <1-254>|<option-name>`

| Parameter     | Description                                                                                                                                                                                                                                                                                                                                                                                                                                                                                                                                                                                                                                                                                                                                                                                                                                                                                                                                                              |       |                      |     |                                                                                                                                                                                             |      |                                                                                                                                                                                                                                              |         |                                |      |                                                                                                                                                                                           |
|---------------|--------------------------------------------------------------------------------------------------------------------------------------------------------------------------------------------------------------------------------------------------------------------------------------------------------------------------------------------------------------------------------------------------------------------------------------------------------------------------------------------------------------------------------------------------------------------------------------------------------------------------------------------------------------------------------------------------------------------------------------------------------------------------------------------------------------------------------------------------------------------------------------------------------------------------------------------------------------------------|-------|----------------------|-----|---------------------------------------------------------------------------------------------------------------------------------------------------------------------------------------------|------|----------------------------------------------------------------------------------------------------------------------------------------------------------------------------------------------------------------------------------------------|---------|--------------------------------|------|-------------------------------------------------------------------------------------------------------------------------------------------------------------------------------------------|
| <1-254>       | The option number of the option. Options with the same number as one of the standard options overrides the standard option definition.                                                                                                                                                                                                                                                                                                                                                                                                                                                                                                                                                                                                                                                                                                                                                                                                                                   |       |                      |     |                                                                                                                                                                                             |      |                                                                                                                                                                                                                                              |         |                                |      |                                                                                                                                                                                           |
| <option-name> | Option name used to identify the option. You cannot use a number as the option name. Valid characters are any printable character. If the name contains spaces then you must enclose it in "quotation marks".<br>Default: no default                                                                                                                                                                                                                                                                                                                                                                                                                                                                                                                                                                                                                                                                                                                                     |       |                      |     |                                                                                                                                                                                             |      |                                                                                                                                                                                                                                              |         |                                |      |                                                                                                                                                                                           |
| <option-type> | The option value. You must specify a value that is appropriate to the option type: <table border="1"><tbody><tr><td>ascii</td><td>An ASCII text string</td></tr><tr><td>hex</td><td>A hexadecimal string. Valid characters are the numbers 0–9 and letters a–f. Embedded spaces are not valid. The string must be an even number of characters, from 2 and 256 characters long.</td></tr><tr><td>ipv6</td><td>An IPv6 address or prefix that has hexadecimal notation in the format <code>HHHH : HHHH : : HHHH : HHHH</code>. To create a list of IPv6 addresses, you must add each IPv6 address individually by using the option command multiple times.</td></tr><tr><td>integer</td><td>A number from 0 to 4294967295.</td></tr><tr><td>flag</td><td>A value that either sets (to 1) or unsets (to 0) a flag: <b>true</b>, <b>on</b>, or <b>enabled</b> will set the flag. <b>false</b>, <b>off</b> or <b>disabled</b> will unset the flag.</td></tr></tbody></table> | ascii | An ASCII text string | hex | A hexadecimal string. Valid characters are the numbers 0–9 and letters a–f. Embedded spaces are not valid. The string must be an even number of characters, from 2 and 256 characters long. | ipv6 | An IPv6 address or prefix that has hexadecimal notation in the format <code>HHHH : HHHH : : HHHH : HHHH</code> . To create a list of IPv6 addresses, you must add each IPv6 address individually by using the option command multiple times. | integer | A number from 0 to 4294967295. | flag | A value that either sets (to 1) or unsets (to 0) a flag: <b>true</b> , <b>on</b> , or <b>enabled</b> will set the flag. <b>false</b> , <b>off</b> or <b>disabled</b> will unset the flag. |
| ascii         | An ASCII text string                                                                                                                                                                                                                                                                                                                                                                                                                                                                                                                                                                                                                                                                                                                                                                                                                                                                                                                                                     |       |                      |     |                                                                                                                                                                                             |      |                                                                                                                                                                                                                                              |         |                                |      |                                                                                                                                                                                           |
| hex           | A hexadecimal string. Valid characters are the numbers 0–9 and letters a–f. Embedded spaces are not valid. The string must be an even number of characters, from 2 and 256 characters long.                                                                                                                                                                                                                                                                                                                                                                                                                                                                                                                                                                                                                                                                                                                                                                              |       |                      |     |                                                                                                                                                                                             |      |                                                                                                                                                                                                                                              |         |                                |      |                                                                                                                                                                                           |
| ipv6          | An IPv6 address or prefix that has hexadecimal notation in the format <code>HHHH : HHHH : : HHHH : HHHH</code> . To create a list of IPv6 addresses, you must add each IPv6 address individually by using the option command multiple times.                                                                                                                                                                                                                                                                                                                                                                                                                                                                                                                                                                                                                                                                                                                             |       |                      |     |                                                                                                                                                                                             |      |                                                                                                                                                                                                                                              |         |                                |      |                                                                                                                                                                                           |
| integer       | A number from 0 to 4294967295.                                                                                                                                                                                                                                                                                                                                                                                                                                                                                                                                                                                                                                                                                                                                                                                                                                                                                                                                           |       |                      |     |                                                                                                                                                                                             |      |                                                                                                                                                                                                                                              |         |                                |      |                                                                                                                                                                                           |
| flag          | A value that either sets (to 1) or unsets (to 0) a flag: <b>true</b> , <b>on</b> , or <b>enabled</b> will set the flag. <b>false</b> , <b>off</b> or <b>disabled</b> will unset the flag.                                                                                                                                                                                                                                                                                                                                                                                                                                                                                                                                                                                                                                                                                                                                                                                |       |                      |     |                                                                                                                                                                                             |      |                                                                                                                                                                                                                                              |         |                                |      |                                                                                                                                                                                           |

**Mode** Global Configuration

**Examples** To define a user-defined ASCII string option as option 66, without a name, use the following commands:

```
awplus# configure terminal
awplus(config)# ipv6 dhcp option 66 ascii
```

To define a user-defined hexadecimal string option as option 46, with the name "tcpip-node-type", use the following commands:

```
awplus# configure terminal
awplus(config)# ipv6 dhcp option 46 name tcpip-node-type hex
```

To define a user-defined IP address option as option 175, with the name special-address, use the following commands:

```
awplus# configure terminal
awplus(config)# ipv6 dhcp option 175 name special-address ip
```

To remove the specific user-defined option with the option number 12, use the following commands:

```
awplus# configure terminal
awplus(config)# no ipv6 dhcp option 12
```

To remove the specific user-defined option with the option name perform-router-discovery, use the following commands:

```
awplus# configure terminal
awplus(config)# no ipv6 dhcp option perform-router-discovery
```

**Related Commands**

- [dns-server \(DHCPv6\)](#)
- [domain-name \(DHCPv6\)](#)
- [option \(DHCPv6\)](#)
- [show ipv6 dhcp](#)

# ipv6 dhcp pool

**Overview** Use this command in Global Configuration mode to enter the DHCPv6 Configuration mode for the DHCPv6 server pool name as specified in the required command parameter. If the name specified is not associated with an existing pool, the device will create a new pool with this name, then enter the configuration mode for the new pool.

Once you have entered the DHCPv6 configuration mode, all commands executed before the next **exit** command will apply to this pool.

You can create multiple DHCPv6 server pools on devices with multiple interfaces. This allows the device to act as a DHCPv6 server on multiple interfaces to distribute different information to clients on the different networks.

Use the **no** variant of this command to delete the specific DHCPv6 pool.

**Syntax** `ipv6 dhcp pool <DHCPv6-poolname>`  
`no ipv6 dhcp pool <DHCPv6-poolname>`

| Parameter                            | Description                                                                                                                                                                    |
|--------------------------------------|--------------------------------------------------------------------------------------------------------------------------------------------------------------------------------|
| <code>&lt;DHCPv6-poolname&gt;</code> | Description used to identify this DHCPv6 server pool. Valid characters are any printable character. If the name contains spaces then you must enclose it in "quotation marks". |

**Mode** Global Configuration

**Usage** All DHCPv6 prefix pool names must be unique. IPv6 prefix pools have a similar function to IPv4 address pools. Contrary to IPv4, a block of IPv6 addresses (an IPv6 address prefix) are assigned and not single IPv6 addresses. IPv6 prefix pools are not allowed to overlap.

Once a pool is configured, it cannot be changed. To change the configuration, you must remove then recreate a IPv6 prefix pool. All IPv6 prefixes already allocated are also freed.

**Examples** To create the DHCPv6 pool named P2 and enter DHCPv6 configuration mode, use the following commands:

```
awplus# configure terminal
awplus(config)# ipv6 dhcp pool P2
awplus(config-dhcp6)#
```

To delete the DHCPv6 pool named P2, use the following commands:

```
awplus# configure terminal
awplus(config)# no ipv6 dhcp pool P2
```

**Related  
Commands**

- ipv6 local pool
- option (DHCPv6)
- prefix-delegation pool
- show ipv6 dhcp binding
- show ipv6 dhcp pool

# ipv6 dhcp server

**Overview** Use this command in Interface Configuration mode to enable DHCPv6 server for the current IPv6 configured interface to use the specified DHCPv6 server pool name.

The DHCPv6 server service listens for DHCPv6 requests on the IPv6 configured interface. The DHCPv6 server service does not run on interfaces without IPv6 configured on them.

Use the **no** variant of this command to disable the DHCPv6 server.

**Syntax** `ipv6 dhcp-server [<DHCPv6-poolname>]`  
`no ipv6 dhcp-server`

| Parameter         | Description                                                                                                                                                                                                             |
|-------------------|-------------------------------------------------------------------------------------------------------------------------------------------------------------------------------------------------------------------------|
| <DHCPv6-poolname> | Specify a named DHCPv6 server pool as defined with the <a href="#">ipv6 dhcp pool</a> command. Valid characters are any printable character. If the name contains spaces then you must enclose it in "quotation marks". |

**Mode** Interface Configuration

**Usage** The **ipv6 dhcp server** command enables the DHCPv6 service on a specified interface using the pool for prefix delegation and configuration through the specified interface.

Note that DHCPv6 client, DHCPv6 server and DHCPv6 relay are mutually exclusive on an interface. When one of the DHCPv6 functions is enabled on an interface then another DHCPv6 function cannot be enabled on the same interface.

**Examples** To enable the DHCPv6 server service and use the DHCPv6 pool named P2 on VLAN interface vlan2, use the following commands:

```
awplus# configure terminal
awplus(config)# interface vlan2
awplus(config-if)# ipv6 dhcp server P2
```

To disable the DHCPv6 server on VLAN interface vlan2, use the following commands:

```
awplus# configure terminal
awplus(config)# interface vlan2
awplus(config-if)# no ipv6 dhcp server
```

**Related Commands** [ipv6 dhcp pool](#)  
[show ipv6 dhcp binding](#)  
[show ipv6 dhcp pool](#)

# ipv6 local pool

**Overview** Use this command in Global Configuration mode to configure a local DHCPv6 server prefix delegation pool specifying a poolname and a prefix/prefix length. You can optionally exclude the locally assigned prefix from the pool with the **exclude-local-prefix** keyword.

Use the **no** variant of this command to remove a local DHCPv6 server prefix delegation pool specifying the poolname.

**Syntax** `ipv6 local pool <DHCPv6-poolname> <delegated-prefix-name>  
<ipv6-prefix/prefix-length> <assigned-length>  
[exclude-local-prefix]`  
`no ipv6 local pool`

| Parameter                                      | Description                                                                                                                                                                                                                                                                                          |
|------------------------------------------------|------------------------------------------------------------------------------------------------------------------------------------------------------------------------------------------------------------------------------------------------------------------------------------------------------|
| <code>&lt;DHCPv6-poolname&gt;</code>           | Description used to identify this DHCPv6 server pool. Valid characters are any printable character. If the name contains spaces then you must enclose it in "quotation marks".                                                                                                                       |
| <code>&lt;delegated-prefix-name&gt;</code>     | Description used to identify the delegated prefix name from the parent PD (Prefix Delegation) server. If the name contains spaces then you must enclose it in "quotation marks".                                                                                                                     |
| <code>&lt;ipv6-prefix/prefix-length&gt;</code> | Specify an IPv6 prefix and prefix length. The prefix length indicates the length of the IPv6 prefix assigned to the pool.<br>The IPv6 address uses the format X::X:X/Prefix-Length. The prefix-length is usually set between 0 and 64.                                                               |
| <code>&lt;assigned-length&gt;</code>           | Specify an IPv6 prefix length assigned to the user from the pool in the range <1-128>. Note that the value of the <i>assigned-length</i> parameter entered cannot be less than or equal to the <i>prefix-length</i> parameter value entered. An assigned length must be longer than a prefix length. |
| <code>exclude-local-prefix</code>              | Specify this keyword to exclude the locally assigned prefix from the pool.                                                                                                                                                                                                                           |

**Default** No DHCPv6 server prefix delegation pool is configured by default.

**Mode** Global Configuration

**Usage** All IPv6 prefix pool names must be unique. IPv6 prefix pools have a similar function to IPv4 address pools. Contrary to IPv4, a block of IPv6 addresses (an IPv6 address prefix) are assigned and not single IPv6 addresses. IPv6 prefix pools are not allowed to overlap.

Once a pool is configured, it cannot be changed. To change the configuration, you must remove then recreate a IPv6 prefix pool. All IPv6 prefixes already allocated are also freed.

**Examples** To create a local DHCPv6 local pool named P2 with the IPv6 prefix and prefix length 2001:0db8::/32 with an assigned length of 64, use the following commands:

```
awplus# configure terminal
awplus(config)# ipv6 local pool P2 2001:0db8::/32 64
```

To remove a configured DHCPv6 local pool, use the following commands:

```
awplus# configure terminal
awplus(config)# no ipv6 local pool
```

**Related Commands** [ipv6 dhcp pool](#)  
[show ipv6 dhcp pool](#)

# ipv6 nd prefix (DHCPv6)

**Overview** Use this command to specify IPv6 RA (Router Advertisement) prefix information generated from the DHCPv6 server for DHCPv6 prefix-delegation for a VLAN.

Use the **no** variant of this command to remove IPv6 RA prefix information from the DHCPv6 Server for DHCPv6 Prefix-Delegation for the interface. Use the **all** parameter with the **no** variant of this command to remove all prefix names and all prefixes for an interface.

**Syntax**

```
ipv6 nd prefix <ipv6-prefix-name>
<ipv6-prefix/length>{<valid-lifetime>|infinite}
{<preferred-lifetime>|infinite} {off-link|no-autoconfig}
no ipv6 nd prefix {<ipv6-prefix-name>|<ipv6-prefix/length>|all}
```

| Parameter                         | Description                                                                                                                                                                                                                                                                                                                                                                                                                            |
|-----------------------------------|----------------------------------------------------------------------------------------------------------------------------------------------------------------------------------------------------------------------------------------------------------------------------------------------------------------------------------------------------------------------------------------------------------------------------------------|
| <i>&lt;ipv6-prefix-name&gt;</i>   | The IPv6 prefix name advertised on the router advertisement message sent from the device.<br>The IPv6 prefix name is delegated from the DHCPv6 Server configured for DHCPv6 Prefix-Delegation.                                                                                                                                                                                                                                         |
| <i>&lt;ipv6-prefix/length&gt;</i> | The IPv6 prefix and prefix length advertised on the router advertisement message sent from the device.<br>The IPv6 address prefix uses the format X:X::/prefix-length. The prefix-length is usually set between 0 and 64.                                                                                                                                                                                                              |
| <i>&lt;valid-lifetime&gt;</i>     | The the period during which the specified IPv6 address prefix is valid. This can be set to a value between 5 and 315360000 seconds. Note that this period should be set to a value greater than that set for the prefix preferred-lifetime. See the Usage notes after this parameter table for a description of valid lifetime and how it determines invalid IPv6 addresses upon expiry.                                               |
| infinite                          | Specifying this keyword instead of entering a value for the <i>&lt;valid-lifetime&gt;</i> parameter applies an infinite valid lifetime.                                                                                                                                                                                                                                                                                                |
| <i>&lt;preferred-lifetime&gt;</i> | Specifies the IPv6 prefix preferred lifetime. This is the period during which the IPv6 address prefix is considered current. Set this to a value between 0 and 315360000 seconds. Note that this period should be set to a value less than that set for the prefix valid-lifetime. See the Usage notes after this parameter table for a description of preferred lifetime and how it determines deprecated IPv6 addresses upon expiry. |
| infinite                          | Specifying this keyword instead of entering a value for the <i>&lt;preferred-lifetime&gt;</i> parameter applies an infinite valid lifetime.                                                                                                                                                                                                                                                                                            |
| off-link                          | Specify the IPv6 prefix off-link flag.                                                                                                                                                                                                                                                                                                                                                                                                 |
| no-autoconfig                     | Specify the IPv6 prefix no autoconfiguration flag. Setting this flag indicates that the prefix is not to be used for autoconfiguration.                                                                                                                                                                                                                                                                                                |
| all                               | Specify all prefix names and all prefixes are removed when used with the no variant of this command.                                                                                                                                                                                                                                                                                                                                   |



**Mode** Interface Configuration for a VLAN interface or a PPP interface.

**Usage** This command specifies the IPv6 prefix flags that are advertised by the router advertisement message.

Preferred IPv6 addresses or prefixes are available to interfaces for unrestricted use and are deprecated when the preferred timer expires.

Deprecated IPv6 addresses and prefixes are available for use and are discouraged but not forbidden. A deprecated address or prefix should not be used as a source address or prefix, but packets sent from deprecated addresses or prefixes are delivered as expected.

An IPv6 address or prefix becomes invalid and is not available to an interface when the valid lifetime timer expires. Invalid addresses or prefixes should not appear as the source or destination for a packet.

**Examples** The following example configures the device to issue RAs (Router Advertisements) on the VLAN interface `vlan4`, and advertises the DHCPv6 prefix name `prefix1` and the IPv6 address prefix of `2001:0db8::/32`.

```
awplus# configure terminal
awplus(config)# interface vlan2
awplus(config-if)# ipv6 enable
awplus(config-if)# ipv6 dhcp client pd prefix1
awplus(config-if)# ipv6 nd prefix prefix1 2001:0db8::/32
```

The following example resets router advertisements on the VLAN interface `vlan4`, so the address prefix of `2001:0db8::/32` is not advertised from the device.

```
awplus# configure terminal
awplus(config)# interface vlan4
awplus(config-if)# no ipv6 nd prefix 2001:0db8::/32
```

The following example removes all prefix names and prefixes from VLAN interface `vlan4`:

```
awplus# configure terminal
awplus(config)# interface vlan4
awplus(config-if)# no ipv6 nd prefix all
```

**Related Commands**

- [ipv6 address \(DHCPv6 PD\)](#)
- [ipv6 dhcp client pd](#)
- [ipv6 dhcp pool](#)
- [ipv6 local pool](#)
- [prefix-delegation pool](#)
- [show ipv6 dhcp binding](#)

# link-address

**Overview** Use this command in DHCPv6 Configuration mode to specify a link-address prefix within a DHCPv6 Server pool.

Note that you can only configure one link address per DHCPv6 pool. Configuring another link address in the same DHCPv6 pool overwrites the previously configured link address.

Use the **no** variant of this command to remove the link-address prefix from the DHCPv6 Server pool.

**Syntax** `link-address <ipv6-prefix/prefix-length>`  
`no link-address`

| Parameter                                      | Description                                                                                                                                                                                                                         |
|------------------------------------------------|-------------------------------------------------------------------------------------------------------------------------------------------------------------------------------------------------------------------------------------|
| <code>&lt;ipv6-prefix/prefix-length&gt;</code> | Specify an IPv6 prefix and prefix length. The prefix length indicates the length of the IPv6 prefix assigned to the pool. The IPv6 address uses the format X:X::X/Prefix-Length. The prefix-length is usually set between 0 and 64. |

**Default** No DHCPv6 Server pool configuration link address prefix is configured by default.

**Mode** DHCPv6 Configuration

**Usage** Link addresses are configured in DHCPv6 Server address pools when there are remote clients that communicate via intermediate relay(s).

RELAY-FORW and RELAY-REPL relay packets contain the requesting link address source.

This command is used to match incoming requests from PD (Prefix Delegation) clients (received via an intermediate relay) to a configured delegation pool.

When an address on the incoming interface of the DHCPv6 server or a link address set in the incoming delegation request packet from the prefix delegation client matches the link-address prefix configured in the delegation pool, the DHCPv6 server is able to match and use the appropriate delegation pool for relayed delegation request messages.

If there is no match between incoming delegation request packets from the prefix delegation client and the link-address prefix configured in the delegation pool, the DHCPv6 Server does not delegate an IPv6 prefix to the requesting device.

The link address should be set to the network prefix where the prefix delegation client resides. The prefix delegation server will also need a forwarding path (IPv6 route) back to the network prefix where the prefix delegation client resides.

For more information, see the [DHCPv6 Feature Overview and Configuration Guide](#).

**Examples** To configure the IPv6 prefix and prefix length 2001:0db8:1::/48 as the link address for pool P2, use the following commands:

```
awplus# configure terminal
awplus(config)# ipv6 dhcp pool P2
awplus(config-dhcp6)# address prefix 2001:0db8:2::/48
awplus(config-dhcp6)# link-address 2001:0db8:1::/48
```

To remove the link address, use the commands:

```
awplus# configure terminal
awplus(config)# ipv6 dhcp pool P2
awplus(config-dhcp6)# no link-address
```

**Related  
Commands** [ipv6 dhcp pool](#)  
[show ipv6 dhcp pool](#)

# option (DHCPv6)

**Overview** Use this command in DHCPv6 Configuration mode to add a user-defined option to the DHCPv6 prefix pool you are configuring. For the **hex**, **integer**, and **flag** option types, if the option already exists, the new option overwrites the existing option's value.

Use the **no** variant of this command to remove the specified user-defined option from the DHCPv6 server pool, or to remove all user-defined options from the DHCPv6 server pool.

**Syntax** `option [<1-254>|<option-name>] <option-value>`  
`no option [<1-254>|<option-value>]`

| Parameter      | Description                                                                                                                            |                                                                                                                                                                                             |
|----------------|----------------------------------------------------------------------------------------------------------------------------------------|---------------------------------------------------------------------------------------------------------------------------------------------------------------------------------------------|
| <1-254>        | The option number of the option. Options with the same number as one of the standard options overrides the standard option definition. |                                                                                                                                                                                             |
| <option-name>  | Option name associated with the option.                                                                                                |                                                                                                                                                                                             |
| <option-value> | The option value. You must specify a value that is appropriate to the option type:                                                     |                                                                                                                                                                                             |
|                | hex                                                                                                                                    | A hexadecimal string. Valid characters are the numbers 0–9 and letters a–f. Embedded spaces are not valid. The string must be an even number of characters, from 2 and 256 characters long. |
|                | ipv6                                                                                                                                   | An IPv6 prefix that has the hexadecimal X:X::X:X notation. To create a list of IPv6 prefixes, you must add each IPv6 prefix individually using this command multiple times.                 |
|                | integer                                                                                                                                | A number from 0 to 4294967295.                                                                                                                                                              |
|                | flag                                                                                                                                   | A value of either true, on, or enabled to set the flag, or false, off or disabled to unset the flag.                                                                                        |

**Mode** DHCPv6 Configuration

**Usage** You must define a DHCPv6 option using the `ipv6 dhcp option` command before using the `option (DHCPv6)` command.

Note that options with an **ipv6** type can hold a list of IPv6 prefix (i.e. entries that have the X:X::X:X address format), so if the option already exists in the pool, then the new IP address is added to the list of existing IPv6 prefixes. Also note options with the same number as one of the pre-defined options override the standard option definition. The pre-defined options use the option numbers 1, 3, 6, 15, and 51.

**Examples** To add the IPv6 type option named `sntp-server-addr` to the pool P2 and give the option the value `ipv6`, use the following commands:

```
awplus# configure terminal
awplus(config)# ipv6 dhcp option 22 name sntp_server_addr ipv6
awplus(config)# ipv6 dhcp pool P2
awplus(config-dhcp6)# option sntp_server_addr ipv6
```

To add the ASCII-type option named `tftp-server-name` to the pool P2 and give the option the value `server1`, use the following commands:

```
awplus# configure terminal
awplus(config)# ipv6 dhcp pool P2
awplus(config-dhcp6)# option tftp-server-name server1
```

To add the hex-type option named `tcpip-node-type` to the pool P2 and give the option the value `08af`, use the following commands:

```
awplus# configure terminal
awplus(config)# ipv6 dhcp pool P2
awplus(config-dhcp6)# option tcpip-node-type 08af
```

To add multiple IP addresses for the ip-type option 175, use the following commands:

```
awplus(config-dhcp6)# option 175 2001:0db8:3001::/64
awplus(config-dhcp6)# option 175 2001:0db8:3002::/64
awplus(config-dhcp6)# option 175 2001:0db8:3003::/64
```

To add the option 179 to a pool, and give the option the value `123456`, use the following command:

```
awplus(config-dhcp6)# option 179 123456
```

To add a user-defined flag option with the name `perform-router-discovery`, use the following command:

```
awplus(config-dhcp6)# option perform-router-discovery yes
```

To clear all user-defined options from a DHCP address pool, use the following command:

```
awplus(config-dhcp6)# no option
```

To clear a user-defined option, named `tftp-server-name`, use the following command:

```
awplus(config-dhcp6)# no option tftp-server-name
```

**Related  
Commands**

- [dns-server \(DHCPv6\)](#)
- [ipv6 dhcp option](#)
- [ipv6 dhcp pool](#)
- [show ipv6 dhcp pool](#)

# prefix-delegation pool

**Overview** Use this command in DHCPv6 Configuration mode to add a DHCPv6 server prefix-delegation pool entry to the current DHCPv6 pool configuration. You must define a DHCPv6 server prefix-delegation pool using the `ipv6 dhcp pool` command before using this command.

Use the **no** variant of this command to remove a DHCPv6 server prefix-delegation pool from the current DHCPv6 pool configuration.

**Syntax** `prefix-delegation pool <DHCPv6-poolname> [lifetime {<valid-time>|infinite} {<preferred-time>|infinite}]`  
`no prefix-delegation pool <DHCPv6-poolname>`

| Parameter                            | Description                                                                                                                                                                                                                                                                                                                                                                           |
|--------------------------------------|---------------------------------------------------------------------------------------------------------------------------------------------------------------------------------------------------------------------------------------------------------------------------------------------------------------------------------------------------------------------------------------|
| <code>&lt;DHCPv6-poolname&gt;</code> | Description used to identify this DHCPv6 server pool. Valid characters are any printable character. If the name contains spaces then you must enclose it in "quotation marks".                                                                                                                                                                                                        |
| <code>lifetime</code>                | Optional. Specify a time period for the hosts to remember router advertisements (RAs). If you specify this parameter then you must also specify a <i>valid-time</i> and a <i>preferred-time</i> value.<br>See the Usage notes below this parameter table for a description of preferred and valid lifetimes and how these determine deprecated or invalid IPv6 addresses upon expiry. |
| <code>&lt;valid-time&gt;</code>      | Specify a valid lifetime in seconds in the range <code>&lt;5-315360000&gt;</code> .                                                                                                                                                                                                                                                                                                   |
| <code>infinite</code>                | Specify an infinite valid lifetime or an infinite preferred lifetime, or both, when using this keyword.                                                                                                                                                                                                                                                                               |
| <code>&lt;preferred-time&gt;</code>  | Specify a valid lifetime in seconds in the range <code>&lt;5-315360000&gt;</code> .                                                                                                                                                                                                                                                                                                   |

**Default** No IPv6 local prefix pool is specified by default.

**Mode** DHCPv6 Configuration

**Usage** The DHCPv6 server assigns prefixes dynamically from an IPv6 local prefix pool, which is configured using the `ipv6 local pool` command and is associated with a DHCPv6 configuration pool using this command. When the server receives a prefix request from a client, it attempts to obtain unassigned prefixes from the pool. After the client releases the previously assigned prefixes, the server returns the prefixes to the pool for reassignment.

Preferred IPv6 addresses or prefixes are available to interfaces for unrestricted use and are deprecated when the preferred timer expires.

Deprecated IPv6 addresses and prefixes are available for use and are discouraged but not forbidden. A deprecated address or prefix should not be used as a source

address or prefix, but packets sent from deprecated addresses or prefixes are delivered as expected.

An IPv6 address or prefix becomes invalid and is not available to an interface when the valid lifetime timer expires. Invalid addresses or prefixes should not appear as the source or destination for a packet.

**Example** This example adds DHCPv6 Prefix Delegation pool pd\_pool1 to DHCPv6 pool pool1:

```
awplus# configure terminal
awplus(config)# ipv6 local pool pd_pool1 2001:0db8::/48 56
awplus(config)# ipv6 dhcp pool pool1
awplus(config-dhcp6)# prefix-delegation pool pd_pool1
```

**Related  
Commands**

- ipv6 dhcp pool
- ipv6 local pool
- show ipv6 dhcp pool

# show counter ipv6 dhcp-client

**Overview** Use this command in User Exec or Privilege Exec mode to show DHCPv6 client counter information. See [show counter ipv6 dhcp-server](#) for DHCPv6 server information.

For information on filtering and saving command output, see the [“Getting Started with AlliedWare Plus” Feature Overview and Configuration Guide](#).

**Syntax** `show counter ipv6 dhcp-client`

**Mode** User Exec and Privileged Exec

**Example** To display the DHCPv6 client counter information, use the command:

```
awplus# show counter ipv6 dhcp-client
```

**Output** Figure 52-2: Example output from the **show counter ipv6 dhcp-client** command

```
awplus#show counter ipv6 dhcp-client
SOLICIT out 20
ADVERTISE in 12
REQUEST out 1
CONFIRM out 0
RENEW out 0
REBIND out 0
REPLY in 0
RELEASE out 0
DECLINE out 0
INFORMATION-REQUEST out 0
```

**Table 1:** Parameters in the output of the **show counter ipv6 dhcp-client** command

| Parameter    | Description                                                             |
|--------------|-------------------------------------------------------------------------|
| SOLICIT out  | Displays the count of SOLICIT messages sent by the DHCPv6 client.       |
| ADVERTISE in | Displays the count of ADVERTISE messages received by the DHCPv6 client. |
| REQUEST out  | Displays the count of REQUEST messages sent by the DHCPv6 client.       |
| CONFIRM out  | Displays the count of CONFIRM messages sent by the DHCPv6 client.       |
| RENEW out    | Displays the count of RENEW messages sent by the DHCPv6 client.         |



**Table 1:** Parameters in the output of the **show counter ipv6 dhcp-client** command (cont.)

| Parameter               | Description                                                                   |
|-------------------------|-------------------------------------------------------------------------------|
| REBIND out              | Displays the count of REBIND messages sent by the DHCPv6 client.              |
| REPLY in                | Displays the count of REPLY messages received by the DHCPv6 client.           |
| RELEASE out             | Displays the count of RELEASE messages sent by the DHCPv6 client.             |
| DECLINE out             | Displays the count of DECLINE messages sent by the DHCPv6 client.             |
| INFORMATION-REQUEST out | Displays the count of INFORMATION-REQUEST messages sent by the DHCPv6 client. |

**Related Commands** [show counter ipv6 dhcp-server](#)

# show counter ipv6 dhcp-server

**Overview** Use this command in User Exec or Privileged Exec mode to show DHCPv6 server counter information. See [show counter ipv6 dhcp-client](#) for DHCPv6 client information.

For information on filtering and saving command output, see the [“Getting Started with AlliedWare Plus” Feature Overview and Configuration Guide](#).

**Syntax** `show counter ipv6 dhcp-server`

**Mode** User Exec and Privileged Exec

**Example** To display the DHCPv6 server counter information, use the command:

```
awplus# show counter ipv6 dhcp-server
```

**Output** Figure 52-3: Example output from the **show counter ipv6 dhcp-server** command

```
awplus#show counter ipv6 dhcp-server
SOLICIT in 20
ADVERTISE out 12
REQUEST in 1
CONFIRM in 0
RENEW in 0
REBIND in 0
REPLY out 0
RELEASE in 0
DECLINE in 0
INFORMATION-REQUEST in 0
```

**Table 2:** Parameters in the output of the **show counter ipv6 dhcp-server** command

| Parameter     | Description                                                           |
|---------------|-----------------------------------------------------------------------|
| SOLICIT in    | Displays the count of SOLICIT messages received by the DHCPv6 server. |
| ADVERTISE out | Displays the count of ADVERTISE messages sent by the DHCPv6 server.   |
| REQUEST in    | Displays the count of REQUEST messages received by the DHCPv6 server. |
| CONFIRM in    | Displays the count of CONFIRM messages received by the DHCPv6 server. |
| RENEW in      | Displays the count of RENEW messages received by the DHCPv6 server.   |

**Table 2:** Parameters in the output of the **show counter ipv6 dhcp-server** command (cont.)

| Parameter              | Description                                                                      |
|------------------------|----------------------------------------------------------------------------------|
| REBIND in              | Displays the count of REBIND messages received by the DHCPv6 server.             |
| REPLY out              | Displays the count of REPLY messages sent by the DHCPv6 server.                  |
| RELEASE in             | Displays the count of RELEASE messages received by the DHCPv6 server.            |
| DECLINE in             | Displays the count of DECLINE messages received by the DHCPv6 server.            |
| INFORMATION-REQUEST in | Displays the count of INFORMATION-REQUEST messages received by the DHCPv6 server |

**Related Commands** [show counter ipv6 dhcp-client](#)

# show ipv6 dhcp

**Overview** Use this command in User Exec or Privileged Exec mode to show the DHCPv6 unique identifier (DUID) configured on your device.

For information on filtering and saving command output, see the [“Getting Started with AlliedWare Plus” Feature Overview and Configuration Guide](#).

**Syntax** `show ipv6 dhcp`

**Mode** User Exec and Privileged Exec

**Usage** The DUID is based on the link-layer address for both DHCPv6 client and DHCPv6 server identifiers. The device uses the MAC address from the lowest interface number for the DUID.

The DUID is used by a DHCPv6 client to obtain an IPv6 address from a DHCPv6 server. A DHCPv6 server compares the DUID with its database of DUIDs and sends configuration data for an IPv6 address plus the preferred and valid lease time values to a DHCPv6 client.

**Example** To display the DUID configured on your device, use the command:

```
awplus# show ipv6 dhcp
```

**Output** Figure 52-4: Example output from the **show ipv6 dhcp** command

```
awplus#show ipv6 dhcp
DHCPv6 Server DUID: 0001000117ab6876001577f7ba23
```

**Related Commands** [ipv6 address dhcp](#)

# show ipv6 dhcp binding

**Overview** Use this command in User Exec or Privileged Exec mode to show the IPv6 address entries that the DHCPv6 server leases to DHCPv6 clients. Note that applying this command with the optional *summary* keyword parameter displays the number of addresses per pool, but not the address or prefix entries per pool.

For information on filtering and saving command output, see the [“Getting Started with AlliedWare Plus” Feature Overview and Configuration Guide](#).

**Syntax** `show ipv6 dhcp binding [summary]`

| Parameter            | Description                                                                                                                                                                                                |
|----------------------|------------------------------------------------------------------------------------------------------------------------------------------------------------------------------------------------------------|
| <code>summary</code> | Optional. Specify the <b>summary</b> keyword to display summarized information for DHCPv6 server leases to client nodes, displaying the number of address entries per pool, not the addresses or prefixes. |

**Mode** User Exec and Privileged Exec

**Example 1** To display the total DHCPv6 leasing address entries for all pools, use the command:

```
awplus# show ipv6 dhcp binding summary
```

**Output** Figure 52-5: Example output from the **show ipv6 dhcp binding summary** command

```
awplus# show ipv6 dhcp binding summary
Pool Name Number of Leased Addresses

ia-na1 3
ia-pd1 5
Total in all Pools: 8
```

**Table 3:** Parameters in the output of the **show ipv6 dhcp binding summary** command

| Parameter                  | Description                                                        |
|----------------------------|--------------------------------------------------------------------|
| Pool Name                  | Displays a list of all the pool names.                             |
| Number of Leased Addresses | Displays the number of leased address entries for the pool.        |
| Total in all Pools         | Displays the total number of leased address entries for all pools. |

**Example 2** To display addresses, prefixes, and lifetimes for all DHCPv6 leasing entries by pool, enter:

```
awplus# show ipv6 dhcp binding
```

**Output** Figure 52-6: Example output from the **show ipv6 dhcp binding** command

```
awplus#show ipv6 dhcp binding
Pool ia-na1
 Address 2002:0:3c0::1
 client IAID 77f7ba23, DUID 0001000117c4bbb4001577f7ba23
 preferred lifetime 604800, valid lifetime 2592000
 starts at 20 Aug 2012 18:38:29
 expires at 19 Sep 2012 18:38:29
Pool ia-pd1
 Prefix 2002:0:3c0::/42
 client IAID 77f7ba23, DUID 0001000117c4bbb4001577f7ba23
 preferred lifetime 604800, valid lifetime 2592000
 starts at 20 Aug 2012 18:38:29
 expires at 19 Sep 2012 18:38:29
```

**Table 4:** Parameters in the output of the **showipv6 dhcp binding** command

| Parameter          | Description                                                                                                                                                                                                                                                                                                                                                                                                                                                                                  |
|--------------------|----------------------------------------------------------------------------------------------------------------------------------------------------------------------------------------------------------------------------------------------------------------------------------------------------------------------------------------------------------------------------------------------------------------------------------------------------------------------------------------------|
| Address            | Address delegated to the indicated IAID and DUID. See the IAID and DUID descriptions below for further information.                                                                                                                                                                                                                                                                                                                                                                          |
| Prefix             | Prefix delegated to the indicated IAID and DUID. See the IAID and DUID descriptions below for further information.                                                                                                                                                                                                                                                                                                                                                                           |
| DUID               | DHCPv6 unique identifier (DUID) (see RFC 3315). Each DHCPv6 client has as DUID. DHCPv6 servers use DUIDs to identify clients for the association of IAs (Identity Associations) with DHCPv6 clients. DHCPv6 clients use DUIDs to identify a DHCPv6 server.                                                                                                                                                                                                                                   |
| IAID               | Identify Association Identifier (IAID) (see RFC 3315). IAIDs are identifiers for IAs (Identity Associations), where an IA is a collection of IPv6 addresses assigned to a DHCPv6 client. Each IA has an associated IAD. Each DHCPv6 client may have more than one IA assigned to it. Each IA holds one type of address.                                                                                                                                                                      |
| preferred lifetime | The preferred lifetime setting in seconds for the specified IAID and DUID. Preferred IPv6 addresses or prefixes are available to interfaces for unrestricted use and are deprecated when the preferred timer expires. Deprecated IPv6 addresses and prefixes are available for use and are discouraged but not forbidden. A deprecated address or prefix should not be used as a source address or prefix, but packets sent from deprecated addresses or prefixes are delivered as expected. |
| valid lifetime     | The valid lifetime setting in seconds for the specified IAID and DUID. An IPv6 address or prefix becomes invalid and is not available to an interface when the valid lifetime timer expires. Invalid addresses or prefixes should not appear as the source or destination for a packet.                                                                                                                                                                                                      |

**Table 4:** Parameters in the output of the **showipv6 dhcp binding** command

| Parameter  | Description                                            |
|------------|--------------------------------------------------------|
| starts at  | The date and time at which the valid lifetime expires. |
| expires at | The date and time at which the valid lifetime expires. |

**Related  
Commands**

[clear ipv6 dhcp binding](#)  
[ipv6 dhcp pool](#)  
[show ipv6 dhcp pool](#)

# show ipv6 dhcp interface

**Overview** Use this command in User Exec or Privileged Exec mode to display DHCPv6 information for a specified interface, or all interfaces when entered without the interface parameter.

For information on filtering and saving command output, see the [“Getting Started with AlliedWare Plus” Feature Overview and Configuration Guide](#).

**Syntax** `show ipv6 dhcp interface [<interface-name>]`

| Parameter                           | Description                                                                                                                                                                          |
|-------------------------------------|--------------------------------------------------------------------------------------------------------------------------------------------------------------------------------------|
| <code>&lt;interface-name&gt;</code> | Optional. Specify the name of the interface to show DHCPv6 information about. Omit this optional parameter to display DHCPv6 information for all interfaces DHCPv6 is configured on. |

**Mode** User Exec and Privileged Exec

**Example** To display DHCPv6 information for all interfaces DHCPv6 is configured on, use the command:

```
awplus# show ipv6 dhcp interface
```

**Output** Figure 52-7: Example output from the **show ipv6 dhcp interface** command

```
awplus# show ipv6 dhcp interface
vlan1 is in client mode
Address 1001::3c0:1
 preferred lifetime 9000, valid lifetime 5000
 starts at 20 Jan 2012 09:21:35
 expires at 20 Jan 2012 10:25:32
```

**Example 2** To display DHCPv6 information for interface vlan2, use the command:

```
awplus# show ipv6 dhcp interface vlan2
```

**Output** Figure 52-8: Example output from the **show ipv6 dhcp interface vlan2** command

```
awplus# show ipv6 dhcp interface vlan2
vlan2 is in client (Prefix-Delegation) mode
Prefix name pd1
 prefix 2002:0:3c0::/42
 preferred lifetime 604800, valid lifetime 2592000
 starts at 20 Aug 2012 09:21:33
 expires at 19 Sep 2012 09:21:33
```



**Table 5:** Parameters in the output of the **show counter dhcp-client** command

| Parameter                                                 | Description                                                                                                                    |
|-----------------------------------------------------------|--------------------------------------------------------------------------------------------------------------------------------|
| <interface> is in server/client/ (Prefix-Delegation) mode | Displays whether the specified interface is in server or client mode and whether prefix-delegation is applied to an interface. |
| Address                                                   | Displays the address of the DHCPv6 server on the interface.                                                                    |
| Prefix name                                               | Displays the IPv6 general prefix pool name, where prefixes are stored for the interface.                                       |
| Using pool                                                | Displays the name of the pool used by the interface.                                                                           |
| Preference                                                | Displays the preference value for the DHCPv6 server.                                                                           |

**Related Commands** [ipv6 dhcp client pd](#)

# show ipv6 dhcp pool

**Overview** Use this command in User Exec or Privileged Exec mode to display the configuration details and system usage of the DHCPv6 address pools configured on the device.

For information on filtering and saving command output, see the [“Getting Started with AlliedWare Plus” Feature Overview and Configuration Guide](#).

**Syntax** `show ipv6 dhcp pool [<DHCPv6-address-pool-name>]`

| Parameter                  | Description                                                                                                        |
|----------------------------|--------------------------------------------------------------------------------------------------------------------|
| <DHCPv6-address-pool-name> | Name of a specific DHCPv6 address pool. This displays the configuration of the specified DHCPv6 address pool only. |

**Mode** User Exec and Privileged Exec

**Example** `awplus# show ipv6 dhcp pool`

**Output** Figure 52-9: Example output from the **show ipv6 dhcp pool** command

```
awplus# show ipv6 dhcp pool
DHCPv6 Pool: ia-na
Address Prefix : 1001::/64
 Lifetime: 2592000(valid), 604800(preferred)
DNS Server: 2001::1
DNS Server: 2001::2
Domain Name: example.com
Domain Name: example.co.jp
SNTP Server: 2001::5
SNTP Server: 2001::6
Option Code : 150
 Value: [ASCII] test-test
DHCPv6 Pool: ia-pd
PD Pool Name: pd1
Prefix : 2002::/38-42
Lifetime : 2592000(valid), 604800(preferred)
```

**Table 6:** Parameters in the output of the **show ipv6dhcp pool** command

| Parameter      | Description                        |
|----------------|------------------------------------|
| DHCPv6 Pool    | Name of the DHCPv6 pool.           |
| Address Prefix | Address prefix to the DHCPv6 pool. |

**Table 6:** Parameters in the output of the **show ipv6dhcp pool** command (cont.)

| Parameter           | Description                                                                                                                                                                                                                                                                                                                                                                                                                                                                                                                                                                                                                                                                          |
|---------------------|--------------------------------------------------------------------------------------------------------------------------------------------------------------------------------------------------------------------------------------------------------------------------------------------------------------------------------------------------------------------------------------------------------------------------------------------------------------------------------------------------------------------------------------------------------------------------------------------------------------------------------------------------------------------------------------|
| Address<br>Lifetime | Valid and preferred lifetimes to the DHCPv6 pool. Preferred IPv6 addresses or prefixes are available to interfaces for unrestricted use and are deprecated when the preferred timer expires. Deprecated IPv6 addresses and prefixes are available for use and are discouraged but not forbidden. A deprecated address or prefix should not be used as a source address or prefix, but packets sent from deprecated addresses or prefixes are delivered as expected. An IPv6 address or prefix becomes invalid and is not available to an interface when the valid lifetime timer expires. Invalid addresses or prefixes should not appear as the source or destination for a packet. |
| DNS Server          | IPv6 address of the DNS Server                                                                                                                                                                                                                                                                                                                                                                                                                                                                                                                                                                                                                                                       |
| Domain name         | URL for the domain name.                                                                                                                                                                                                                                                                                                                                                                                                                                                                                                                                                                                                                                                             |
| SNTP Server         | IPv6 address of the SNTP (Simple Network Time Protocol) Server.                                                                                                                                                                                                                                                                                                                                                                                                                                                                                                                                                                                                                      |
| Option Code         | DHCP Option code (see RFC 2132).                                                                                                                                                                                                                                                                                                                                                                                                                                                                                                                                                                                                                                                     |
| Option Value        | DHCP Option value type (see RFC 2132).                                                                                                                                                                                                                                                                                                                                                                                                                                                                                                                                                                                                                                               |

**Related  
Commands** [ipv6 dhcp pool](#)

# sntp-address

**Overview** Use this command in DHCPv6 Configuration mode to add an SNTP Server IPv6 address to a DHCPv6 Server pool.

Use the **no** variant of this command to remove an SNTP Server IPv6 address from a DHCPv6 Server pool.

**Syntax** `sntp-address <ipv6-address>`  
`no sntp-address <ipv6-address>`

| Parameter                         | Description                                                                                        |
|-----------------------------------|----------------------------------------------------------------------------------------------------|
| <code>&lt;ipv6-address&gt;</code> | Specify an SNTP Server IPv6 address, in hexadecimal notation in the format <code>X:X::X:X</code> . |

**Mode** DHCPv6 Configuration

**Examples** The following example adds an SNTP Server IPv6 address of 2001:0db8::/32 to the DHCPv6 pool named P2:

```
awplus# configure terminal
awplus(config)# ipv6 dhcp pool P2
awplus(config-dhcp6)# sntp-address 2001:0db8::/32
```

The following example removes an SNTP Server IPv6 address of 2001:0db8::/32 to the DHCPv6 pool named P2:

```
awplus# configure terminal
awplus(config)# ipv6 dhcp pool P2
awplus(config-dhcp6)# no sntp-address 2001:0db8::/32
```

**Related Commands**

- [dns-server \(DHCPv6\)](#)
- [domain-name \(DHCPv6\)](#)
- [option \(DHCPv6\)](#)
- [show ipv6 dhcp pool](#)

# 53

# NTP Commands

## Introduction

**Overview** This chapter provides an alphabetical reference for commands used to configure the Network Time Protocol (NTP). For more information, see the [NTP Feature Overview and Configuration Guide](#).

The device can act as an NTP client to receive time from one or more NTP servers, and as an NTP server.

For information on filtering and saving command output, see the [“Getting Started with AlliedWare\\_Plus” Feature Overview and Configuration Guide](#).

- Command List**
- [“ntp authenticate”](#) on page 2446
  - [“ntp authentication-key”](#) on page 2447
  - [“ntp broadcastdelay”](#) on page 2448
  - [“ntp discard”](#) on page 2449
  - [“ntp master”](#) on page 2450
  - [“ntp peer”](#) on page 2451
  - [“ntp restrict”](#) on page 2453
  - [“ntp server”](#) on page 2455
  - [“ntp source”](#) on page 2457
  - [“ntp trusted-key \(deprecated\)”](#) on page 2459
  - [“show counter ntp \(deprecated\)”](#) on page 2460
  - [“show ntp associations”](#) on page 2461
  - [“show ntp counters”](#) on page 2463
  - [“show ntp counters associations”](#) on page 2465
  - [“show ntp status”](#) on page 2467

# ntp authenticate

**Overview** This command enables NTP authentication. This allows NTP to authenticate the associations with other systems for security purposes.

The **no** variant of this command disables NTP authentication.

**Syntax** ntp authenticate  
no ntp authenticate

**Mode** Global Configuration

**Examples** To enable NTP authentication, use the commands:

```
awplus# configure terminal
awplus(config)# ntp authenticate
```

To disable NTP authentication, use the commands:

```
awplus# configure terminal
awplus(config)# no ntp authenticate
```

# ntp authentication-key

**Overview** This command defines each of the authentication keys. Each key has a key number, a type (MD5 or SHA1), and a value.

The **no** variant of this disables the authentication key.

**Syntax** `ntp authentication-key <keynumber> {md5|sha1} <key> [trusted]`  
`no ntp authentication-key <keynumber>`

| Parameter   | Description                                                                                                                          |
|-------------|--------------------------------------------------------------------------------------------------------------------------------------|
| <keynumber> | <1-4294967295> An identification number for the key.                                                                                 |
| md5         | Define an MD5 key.                                                                                                                   |
| sha1        | Define an SHA1 key.                                                                                                                  |
| <key>       | The authentication key. For SHA1, this is a 20 hexadecimal character string. For MD5, this is a string of up to 31 ASCII characters. |
| trusted     | Add this key to the list of authentication keys that this server trusts.                                                             |

**Mode** Global Configuration

**Examples** To define an MD5 authentication key number 134343 and a key value "mystring", use the commands:

```
awplus# configure terminal
awplus(config)# ntp authentication-key 134343 md5 mystring
```

To disable the authentication key number 134343 with the key value "mystring", use the commands:

```
awplus# configure terminal
awplus(config)# no ntp authentication-key 134343 md5 mystring
```

# ntp broadcastdelay

**Overview** Use this command to set the estimated round-trip delay for broadcast packets. Use the **no** variant of this command to reset the round-trip delay for broadcast packets to the default offset of 0 microseconds.

**Syntax** `ntp broadcastdelay <delay>`  
`no ntp broadcastdelay`

| Parameter                  | Description                                                        |
|----------------------------|--------------------------------------------------------------------|
| <code>&lt;delay&gt;</code> | <code>&lt;1-999999&gt;</code> The broadcast delay in microseconds. |

**Default** 0 microsecond offset, which can only be applied with the **no** variant of this command.

**Mode** Global Configuration

**Examples** To set the estimated round-trip delay to 23464 microseconds for broadcast packets, use these commands:

```
awplus# configure terminal
awplus(config)# ntp broadcastdelay 23464
```

To reset the estimated round-trip delay for broadcast packets to the default setting (0 microseconds), use these commands:

```
awplus# configure terminal
awplus(config)# no ntp broadcastdelay
```



# ntp discard

**Overview** Use this command to limit the time between NTP packets on the host or hosts specified by the command [ntp restrict](#). Packets that arrive at greater frequency than the limits are dropped or sent a kiss-of-death response.

Use the **no** variant of this command to return the limits to their default values.

**Syntax**

```
ntp discard minimum <1-60>
ntp discard average <1-16>
no ntp discard minimum
no ntp discard average
```

| Parameter      | Description                                                                                                                                                                                           |
|----------------|-------------------------------------------------------------------------------------------------------------------------------------------------------------------------------------------------------|
| minimum <1-60> | The minimum time between NTP packets, in seconds.                                                                                                                                                     |
| average <1-16> | A value that determines the minimum average time between NTP packets. The number of seconds is 2 to the power of the specified value (e.g. if you specify 4, the minimum average time is 16 seconds). |

**Default** Minimum: 2  
Average: 3 (8 seconds)

**Mode** Global Configuration

**Example** To drop NTP packets from the 192.168.1.0/16 subnet if they arrive more frequently than every 5 seconds, and also send kiss-of-death messages, use the commands:

```
awplus# configure terminal
awplus(config)# ntp discard minimum 5
awplus(config)# ntp restrict 192.168.1.0/16 limited kod
```

To silently drop all NTP packets if they arrive more frequently than once every 4 seconds on average (2 to the power of 2), use the commands:

```
awplus# configure terminal
awplus(config)# ntp discard average 2
awplus(config)# ntp restrict default-v4 limited
awplus(config)# ntp restrict default-v6 limited
```

**Related Commands** [ntp restrict](#)

# ntp master

**Overview** Use this command to make the device to be an authoritative NTP server, even if the system is not synchronized to an outside time source.

Use the **no** variant of this command to stop the device being the designated NTP server.

**Syntax** `ntp master [<stratum>]`  
`no ntp master`

| Parameter | Description                                                                                                                                    |
|-----------|------------------------------------------------------------------------------------------------------------------------------------------------|
| <stratum> | <1-15> The stratum number defines the configured level that is set for this master within the NTP hierarchy. The default stratum number is 12. |

**Mode** Global Configuration

**Usage** The stratum levels define the distance from the reference clock and exist to prevent cycles in the hierarchy. Stratum 1 is used to indicate time servers, which are more accurate than Stratum 2 servers. For more information on the Network Time Protocol go to: [www.ntp.org](http://www.ntp.org)

**Examples** To stop the device from being the designated NTP server, use the commands:

```
awplus# configure terminal
awplus(config)# no ntp master
```

To make the device the designated NTP server with stratum number 2, use the commands:

```
awplus# configure terminal
awplus(config)# ntp master 2
```

# ntp peer

**Overview** Use this command to configure an NTP peer association. An NTP association is a peer association if this system is willing to either synchronize to the other system, or allow the other system to synchronize to it.

Use the **no** variant of this command to remove the configured NTP peer association.

**Syntax**

```
ntp peer {<peeraddress>|<peername>}
ntp peer {<peeraddress>|<peername>} [prefer] [key <key>]
[version <version>]
no ntp peer {<peeraddress>|<peername>}
```

| Parameter         | Description                                                                                                                       |
|-------------------|-----------------------------------------------------------------------------------------------------------------------------------|
| <peeraddress>     | Specify the IP address of the peer, entered in the form A.B.C.D for an IPv4 address, or in the form X:X::X:X for an IPv6 address. |
| <peername>        | Specify the peer hostname. The peer hostname can resolve to an IPv4 and an IPv6 address.                                          |
| prefer            | Prefer this peer when possible.                                                                                                   |
| key <key>         | <1-4294967295><br>Configure the peer authentication key.                                                                          |
| version <version> | <1-4><br>Configure for this NTP version.                                                                                          |

**Mode** Global Configuration

**Examples** See the following commands for options to configure NTP peer association, key and NTP version for the peer with an IPv4 address of 192.0.2.23:

```
awplus# configure terminal
awplus(config)# ntp peer 192.0.2.23
awplus(config)# ntp peer 192.0.2.23 prefer
awplus(config)# ntp peer 192.0.2.23 prefer version 4
awplus(config)# ntp peer 192.0.2.23 prefer version 4 key 1234
awplus(config)# ntp peer 192.0.2.23 version 4 key 1234
awplus(config)# ntp peer 192.0.2.23 version 4
awplus(config)# ntp peer 192.0.2.23 key 1234
```

To remove an NTP peer association for this peer with an IPv4 address of 192.0.2.23, use the following commands:

```
awplus# configure terminal
awplus(config)# no ntp peer 192.0.2.23
```

See the following commands for options to configure NTP peer association, key and NTP version for the peer with an IPv6 address of 2001:0db8:010d::1:

```
awplus# configure terminal
awplus(config)# ntp peer 2001:0db8:010d::1
awplus(config)# ntp peer 2001:0db8:010d::1 prefer
awplus(config)# ntp peer 2001:0db8:010d::1 prefer version 4
awplus(config)# ntp peer 2001:0db8:010d::1 prefer version 4 key
1234
awplus(config)# ntp peer 2001:0db8:010d::1 version 4 key 1234
awplus(config)# ntp peer 2001:0db8:010d::1 version 4
awplus(config)# ntp peer 2001:0db8:010d::1 key 1234
```

To remove an NTP peer association for this peer with an IPv6 address of 2001:0db8:010d::1, use the following commands:

```
awplus# configure terminal
awplus(config)# no ntp peer 2001:0db8:010d::1
```

**Related  
Commands**   [ntp server](#)  
                  [ntp source](#)

# ntp restrict

**Overview** Use this command to restrict NTP functionality for one or more hosts.

You can drop NTP packets from specified hosts, apply frequency limits to NTP packets from specified hosts, or restrict the level of functionality for specified hosts. For more details, see [The NTP Public\\_Services\\_Project\\_website](#).

Use the **no** variant of this command to remove a restriction from one or more hosts.

**Syntax**

```
ntp restrict
{default-v4|default-v6|<host-address>|<host-subnet>} ignore

ntp restrict
{default-v4|default-v6|<host-address>|<host-subnet>}
[limited [kod]] {nomodify|noquery|nopeer|noserve|notrust}

no ntp restrict
{default-v4|default-v6|<host-address>|<host-subnet>}
```

| Parameter      | Description                                                                                                                                                                                                                                                  |
|----------------|--------------------------------------------------------------------------------------------------------------------------------------------------------------------------------------------------------------------------------------------------------------|
| default-v4     | Apply this restriction to all IPv4 hosts.                                                                                                                                                                                                                    |
| default-v6     | Apply this restriction to all IPv6 hosts.                                                                                                                                                                                                                    |
| <host-address> | Apply this restriction to the specified IPv4 or IPv6 host.<br>Enter an IPv4 address in the format A.B.C.D.<br>Enter an IPv6 address in the format X::X:X.                                                                                                    |
| <host-subnet>  | Apply this restriction to the specified IPv4 subnet or IPv6 prefix.<br>Enter an IPv4 subnet in the format A.B.C.D/M.<br>Enter an IPv6 prefix in the format X::X:X/X.                                                                                         |
| ignore         | Block all NTP connections, including time polls, from matching hosts.                                                                                                                                                                                        |
| limited        | Apply frequency limits to matching hosts. To specify the frequency limits, use the command <a href="#">ntp discard</a> .                                                                                                                                     |
| kod            | Send kiss-of-death packets when the rate limit is exceeded. If you do not specify this, NTP packets are dropped without further processing when the rate limit is exceeded.                                                                                  |
| nomodify       | Prevent matching hosts from modifying the NTP configuration, even if they have a trusted key.                                                                                                                                                                |
| noquery        | Prevent matching hosts from querying this device's NTP status. This option does not block time queries. We recommend using this option on publicly-accessible systems, because it blocks ntpq and ntpdc queries, which can be used in amplification attacks. |
| nopeer         | Prevent matching hosts from becoming NTP peers of this device.                                                                                                                                                                                               |

| Parameter | Description                                                                                                                                                        |
|-----------|--------------------------------------------------------------------------------------------------------------------------------------------------------------------|
| noserve   | Do not serve the time to matching hosts.                                                                                                                           |
| notrust   | Require that matching hosts authenticate NTP sessions with this device. If you use this option, the device will drop all unsigned NTP packets from matching hosts. |

**Default** None. By default, there are no restrictions configured.

**Mode** Global Configuration

**Example** To prevent all hosts from using NTP except for the host 192.0.2.1 and the subnet 192.168.1.0/16, use the commands:

```
awplus# configure terminal
awplus(config)# ntp restrict default-v4 ignore
awplus(config)# ntp restrict default-v6 ignore
awplus(config)# ntp restrict 192.0.2.1
awplus(config)# ntp restrict 192.168.1.0/16
```

To force the host 192.0.2.1 and the subnet 192.168.1.0/16 to authenticate NTP sessions with this device, use the commands:

```
awplus# configure terminal
awplus(config)# ntp restrict 192.0.2.1 notrust
awplus(config)# ntp restrict 192.168.1.0/16 notrust
```

To drop NTP packets from the 192.168.1.0/16 subnet if they arrive more frequently than every 5 seconds, and also send kiss-of-death messages, use the commands:

```
awplus# configure terminal
awplus(config)# ntp discard minimum 5
awplus(config)# ntp restrict 192.168.1.0/16 limited kod
```

**Related  
Commands** [ntp discard](#)

# ntp server

**Overview** Use this command to configure an NTP server. This means that this system will synchronize to the other system, and not vice versa.

Use the **no** variant of this command to remove the configured NTP server.

**Syntax**

```
ntp server {<serveraddress>|<servername>}
ntp server {<serveraddress>|<servername>} [prefer] [key <key>]
[version <version>]
no ntp server {<serveraddress>|<servername>}
```

| Parameter         | Description                                                                                                                       |
|-------------------|-----------------------------------------------------------------------------------------------------------------------------------|
| <serveraddress>   | Specify the IP address of the peer, entered in the form A.B.C.D for an IPv4 address, or in the form X:X::X.X for an IPv6 address. |
| <servername>      | Specify the server hostname. The server hostname can resolve to an IPv4 and an IPv6 address.                                      |
| prefer            | Prefer this server when possible.                                                                                                 |
| key <key>         | <1-4294967295><br>Configure the server authentication key.                                                                        |
| version <version> | <1-4><br>Configure for this NTP version.                                                                                          |

**Mode** Global Configuration

**Examples** See the following commands for options to configure an NTP server association, key and NTP version for the server with an IPv4 address of 192.0.1.23:

```
awplus# configure terminal
awplus(config)# ntp server 192.0.1.23
awplus(config)# ntp server 192.0.1.23 prefer
awplus(config)# ntp server 192.0.1.23 prefer version 4
awplus(config)# ntp server 192.0.1.23 prefer version 4 key 1234
awplus(config)# ntp server 192.0.1.23 version 4 key 1234
awplus(config)# ntp server 192.0.1.23 version 4
awplus(config)# ntp server 192.0.1.23 key 1234
```

To remove an NTP peer association for this peer with an IPv4 address of 192.0.1.23, use the commands:

```
awplus# configure terminal
awplus(config)# no ntp server 192.0.1.23
```

See the following commands for options to configure an NTP server association, key and NTP version for the server with an IPv6 address of 2001:0db8:010e::2:

```
awplus# configure terminal
awplus(config)# ntp server 2001:0db8:010e::2
awplus(config)# ntp server 2001:0db8:010e::2 prefer
awplus(config)# ntp server 2001:0db8:010e::2 prefer version 4
awplus(config)# ntp server 2001:0db8:010e::2 prefer version 4
key 1234
awplus(config)# ntp server 2001:0db8:010e::2 version 4 key 1234
awplus(config)# ntp server 2001:0db8:010e::2 version 4
awplus(config)# ntp server 2001:0db8:010e::2 key 1234
```

To remove an NTP peer association for this peer with an IPv6 address of 2001:0db8:010e::2, use the commands:

```
awplus# configure terminal
awplus(config)# no ntp server 2001:0db8:010e::2
```

**Related  
Commands**    [ntp peer](#)  
                  [ntp source](#)



# ntp source

**Overview** Use this command to configure an IPv4 or an IPv6 address for the NTP source interface. This command defines the socket used for NTP messages, and only applies to NTP client behavior.

Note that you cannot use this command when using AMF (Allied Telesis Management Framework) or VCStack.

Use the **no** variant of this command to remove the configured IPv4 or IPv6 address from the NTP source interface.

**Syntax** `ntp source <source-address>`  
`no ntp source`

| Parameter                           | Description                                                                                                                                       |
|-------------------------------------|---------------------------------------------------------------------------------------------------------------------------------------------------|
| <code>&lt;source-address&gt;</code> | Specify the IP address of the NTP source interface, entered in the form A.B.C.D for an IPv4 address, or in the form X:X::X.X for an IPv6 address. |

**Default** An IP address is selected based on the most appropriate egress interface used to reach the NTP peer if a configured NTP client source IP address is unavailable or invalid.

**Mode** Global Configuration

**Usage** Adding an IPv4 or an IPv6 address allows you to select which source interface NTP uses for peering. The IPv4 or IPv6 address configured using this command is matched to the interface.

When selecting a source IP address to use for NTP messages to the peer, if the configured NTP client source IP address is unavailable then default behavior will apply, and an alternative source IP address is automatically selected. This IP address is based on the most appropriate egress interface used to reach the NTP peer. The configured NTP client source IP may be unavailable if the interface is down, or an invalid IP address is configured that does not reside on the device.

Note that this command only applies to NTP client behavior. The egress interface that the NTP messages use to reach the NTP server is determined by the `ntp peer` and `ntp server` commands.

Note that you cannot use this command when using AMF (Allied Telesis Management Framework).

**Examples** To configure the NTP source interface with the IPv4 address 192.0.2.23, enter the commands:

```
awplus# configure terminal
awplus(config)# ntp source 192.0.2.23
```

To configure the NTP source interface with the IPv6 address 2001:0db8:010e::2, enter the commands:

```
awplus# configure terminal
awplus(config)# ntp source 2001:0db8:010e::2
```

To remove a configured address for the NTP source interface, use the following commands:

```
awplus# configure terminal
awplus(config)# no ntp source
```

**Related  
Commands**    [ntp peer](#)  
                  [ntp server](#)

# ntp trusted-key (deprecated)

**Overview** This command has been deprecated in Software Version 5.4.6-1.1. Please use the **trusted** parameter of the command [ntp authentication-key](#) instead.

# show counter ntp (deprecated)

**Overview** From version 5.4.6-1.x onwards, this command has been replaced by the command [show ntp counters](#).

# show ntp associations

**Overview** Use this command to display the status of NTP associations.

**Syntax** show ntp associations

**Mode** User Exec and Privileged Exec

**Example** See the sample output of the **show ntp associations** command displaying the status of NTP associations.

**Table 1:** Example output from the **show ntp associations** command

```
awplus#show ntp associations
 remote refid st t when poll reach delay offset jitter
=====
*server1.example.com
 .GPS. 1 u - 256 377 15.126 1.103 0.454
-server2.example2.com
 192.0.2.2 2 u 173 256 377 28.172 -4.599 0.219
 192.0.2.1 .INIT. 16 s - 1024 0 0.000 0.000 0.000
+server3.example3.com
 .GPS. 1 u 205 256 377 27.144 0.775 0.193
* system peer, # backup, + candidate, - outlier, x false ticker
```

**Table 2:** Parameters in the output from the **show ntp associations** command

| Parameter      | Description                                                                                                                                                                                    |
|----------------|------------------------------------------------------------------------------------------------------------------------------------------------------------------------------------------------|
| * system peer  | The peer that NTP uses to calculate variables like the offset and root dispersion of this AlliedWare Plus device. NTP passes these variables to the clients using this AlliedWare Plus device. |
| # backup       | Peers that are usable, but are not among the first six peers sorted by synchronization distance. These peers may not be used.                                                                  |
| + candidate    | Peers that the NTP algorithm has determined can be used, along with the system peer, to discipline the clock (i.e. to set the time on the AlliedWare Plus device).                             |
| - outlier      | Peers that are not used because their time is significantly different from the other peers.                                                                                                    |
| x false ticker | Peers that are not used because they are not consider trustworthy.                                                                                                                             |
| space          | Peers that are not used because they are, for example, unreachable.                                                                                                                            |
| remote         | The peer IP address                                                                                                                                                                            |

**Table 2:** Parameters in the output from the **show ntp associations** command

| Parameter | Description                                                                                                                                                                                                                                                                            |
|-----------|----------------------------------------------------------------------------------------------------------------------------------------------------------------------------------------------------------------------------------------------------------------------------------------|
| refid     | The IP address of the reference clock, or an abbreviation indicating the type of clock (e.g. GPS indicates that the server uses GPS for the reference clock). INIT indicates that the reference clock is initialising, so it is not operational.                                       |
| st        | The stratum, which is the number of hops between the server and the accurate time source such as an atomic clock.                                                                                                                                                                      |
| t         | Type, one of:<br>u: unicast or manycast client<br>b: broadcast or multicast client<br>l: local reference clock<br>s: symmetric peer<br>A: manycast server<br>B: broadcast server<br>M: multicast server                                                                                |
| when      | When last polled (seconds ago, h hours ago, or d days ago).                                                                                                                                                                                                                            |
| poll      | Time between NTP requests from the device to the server.                                                                                                                                                                                                                               |
| reach     | An indication of whether or not the NTP server is responding to requests. 0 indicates there has never been a successful poll; 1 indicates that the last poll was successful; 3 indicates that the last two polls were successful; 377 indicates that the last 8 polls were successful. |
| delay     | The round trip communication delay to the remote peer or server, in milliseconds.                                                                                                                                                                                                      |
| offset    | The mean offset (phase) in the times reported between this local host and the remote peer or server (root mean square, milliseconds).                                                                                                                                                  |
| jitter    | The mean deviation in the time reported for that remote peer or server (the root mean square of difference of multiple time samples, in milliseconds).                                                                                                                                 |

# show ntp counters

**Overview** This command displays packet counters for NTP.

**Syntax** show ntp counters

**Mode** User Exec and Privileged Exec

**Example** To display counters for NTP use the command:

```
awplus# show ntp counters
```

Figure 53-1: Example output from **show ntp counters**

|                        |      |
|------------------------|------|
| uptime:                | 7212 |
| sysstats reset:        | 7212 |
| packets received:      | 307  |
| current version:       | 237  |
| older version:         | 69   |
| bad length or format:  | 0    |
| authentication failed: | 0    |
| declined:              | 0    |
| restricted:            | 0    |
| rate limited:          | 0    |
| KoD responses:         | 0    |
| processed for time:    | 306  |

Table 53-1: Parameters in the output from **show ntp counters**

| Parameter            | Description                                                                                                                                                      |
|----------------------|------------------------------------------------------------------------------------------------------------------------------------------------------------------|
| uptime               | How long NTP has been running since it was last restarted, in seconds.                                                                                           |
| sysstats reset       | How long since <a href="#">show ntp status</a> information was last reset, in seconds.                                                                           |
| packets received     | Total number of NTP client and server packets received by the device.                                                                                            |
| current version      | The number of version 4 NTP packets received.                                                                                                                    |
| older version        | The number of NTP packets received that are from an older version, down to version 1, of NTP. NTP is compatible with these versions and processes these packets. |
| bad length or format | The number of NTP packets received that do not conform to the standard packet length. NTP drops these packets.                                                   |

Table 53-1: Parameters in the output from **show ntp counters** (cont.)

| Parameter             | Description                                                                                                                                                                                                |
|-----------------------|------------------------------------------------------------------------------------------------------------------------------------------------------------------------------------------------------------|
| authentication failed | The number of NTP packets received that failed authentication. NTP drops these packets. Packets can only fail authentication if NTP authentication is enabled with the <b>ntp authenticate</b> command.    |
| declined              | The number of packets that were declined for any reason.                                                                                                                                                   |
| restricted            | The number of NTP packets received that do not match any restrict statements in the NTP restrictions. NTP drops these packets. See the command <a href="#">ntp restrict</a> for more information.          |
| rate limited          | The number of packets dropped because the packet rate exceeded its limits. See the command <a href="#">ntp discard</a> for more information.                                                               |
| KoD responses         | The number of kiss-of-death packets NTP has sent. See the command <a href="#">ntp restrict</a> for more information.                                                                                       |
| processed for time    | The number of packets processed by NTP. NTP processes a packet once it has determined that the packet is valid by checking factors such as the packet's authentication, format, access rights and version. |



# show ntp counters associations

**Overview** Use this command to display NTP packet counters for individual servers and peers.

**Syntax** show ntp counters associations

**Mode** User Exec/Privileged Exec

**Examples** To display packet counters for each NTP server and peer that is associated with this device, use the command:

```
awplus# show ntp counters associations
```

**Output** Figure 53-2: Example output from **show ntp counters associations**

```
awplus#show ntp counters associations
Peer time-server.example.com
sent: 123
received: 122
auth-failed: 0
bogus-origin: 0
duplicate: 0
bad-header: 0
kod-received: 0
```

Table 53-2: Parameters in the output from **show ntp counters associations**

| Parameter    | Description                                                                                                                                                                                            |
|--------------|--------------------------------------------------------------------------------------------------------------------------------------------------------------------------------------------------------|
| Peer         | An NTP peer or server that the device is associated with.                                                                                                                                              |
| sent         | The number of NTP packets that this device sent to the peer.                                                                                                                                           |
| received     | The number of NTP packets that this device received from the peer.                                                                                                                                     |
| auth-failed  | The number of NTP packets received that failed authentication. NTP drops these packets. Packets can only fail authentication if NTP authentication is enabled with the <b>ntp authenticate</b> command |
| bogus-origin | The number of packets received that have unexpected timestamps. Such packets are not part of the current request/reply round and may be faked.                                                         |
| duplicate    | The number of duplicate packets received. Such packets are at best old duplicates and at worst a replay by a hacker. Duplicates can happen in symmetric modes if the poll intervals are uneven.        |

Table 53-2: Parameters in the output from **show ntp counters associations**

| Parameter    | Description                                                                                                                                                                                                                                |
|--------------|--------------------------------------------------------------------------------------------------------------------------------------------------------------------------------------------------------------------------------------------|
| bad-header   | The number of packets where one or more header fields are invalid.                                                                                                                                                                         |
| kod-received | The number of Kiss of Death packets received from the peer. KoD packets indicate that this device is sending NTP packets more often than the peer will accept them. If you receive KoD packets, you should stop using this server or peer. |

**Related  
Commands** [ntp discard](#)  
[ntp restrict](#)

# show ntp status

**Overview** Use this command to display the status of the Network Time Protocol (NTP).

**Syntax** show ntp status

**Mode** User Exec and Privileged Exec

**Example** To see information about NTP status, use the command:

```
awplus# show ntp status
```

For information about the output displayed by this command, see [ntp.org](http://ntp.org).

Figure 53-3: Example output from the **show ntp status** command

```
awplus#show ntp status
associd=0 status=061b leap_none, sync_ntp, 1 event, leap_event,
system peer: 10.37.211.97:123
system peer mode: client
leap indicator: 00
stratum: 4
log2 precision: -19
root delay: 24.234
root dispersion: 113.912
reference ID: 10.37.211.97
reference time: daad77a3.846d4632 Mon, Apr 4 2016 23:30:43.517
system jitter: 3.603336
clock jitter: 3.292
clock wander: 0.601
broadcast delay: 0.000
symm. auth. delay: 0.000
```

# 54

# SNMP Commands

## Introduction

**Overview** This chapter provides an alphabetical reference for commands used to configure SNMP. For more information, see:

- the [Support for Allied Telesis Enterprise\\_MIBs in AlliedWare Plus](#), for information about which MIB objects are supported.
- the [SNMP Feature Overview and Configuration\\_Guide](#).

For information on filtering and saving command output, see the [“Getting Started with AlliedWare Plus” Feature Overview and Configuration Guide](#).

- Command List**
- [“debug snmp”](#) on page 2470
  - [“show counter snmp-server”](#) on page 2471
  - [“show debugging snmp”](#) on page 2475
  - [“show running-config snmp”](#) on page 2476
  - [“show snmp-server”](#) on page 2477
  - [“show snmp-server community”](#) on page 2478
  - [“show snmp-server group”](#) on page 2479
  - [“show snmp-server user”](#) on page 2480
  - [“show snmp-server view”](#) on page 2481
  - [“snmp trap link-status”](#) on page 2482
  - [“snmp trap link-status suppress”](#) on page 2484
  - [“snmp-server”](#) on page 2486
  - [“snmp-server community”](#) on page 2488
  - [“snmp-server contact”](#) on page 2489
  - [“snmp-server enable trap”](#) on page 2490
  - [“snmp-server engineID local”](#) on page 2492

- [“snmp-server engineID local reset”](#) on page 2494
- [“snmp-server group”](#) on page 2495
- [“snmp-server host”](#) on page 2497
- [“snmp-server legacy-ifadminstatus”](#) on page 2499
- [“snmp-server location”](#) on page 2500
- [“snmp-server source-interface”](#) on page 2501
- [“snmp-server startup-trap-delay”](#) on page 2502
- [“snmp-server user”](#) on page 2503
- [“snmp-server view”](#) on page 2506
- [“undebbug snmp”](#) on page 2507

# debug snmp

**Overview** This command enables SNMP debugging.

The **no** variant of this command disables SNMP debugging.

**Syntax**

```
debug snmp
[all|detail|error-string|process|receive|send|xdump]

no debug snmp
[all|detail|error-string|process|receive|send|xdump]
```

| Parameter    | Description                                                                               |
|--------------|-------------------------------------------------------------------------------------------|
| all          | Enable or disable the display of all SNMP debugging information.                          |
| detail       | Enable or disable the display of detailed SNMP debugging information.                     |
| error-string | Enable or disable the display of debugging information for SNMP error strings.            |
| process      | Enable or disable the display of debugging information for processed SNMP packets.        |
| receive      | Enable or disable the display of debugging information for received SNMP packets.         |
| send         | Enable or disable the display of debugging information for sent SNMP packets.             |
| xdump        | Enable or disable the display of hexadecimal dump debugging information for SNMP packets. |

**Mode** Privileged Exec and Global Configuration

**Example** To start SNMP debugging, use the command:

```
awplus# debug snmp
```

To start SNMP debugging, showing detailed SNMP debugging information, use the command:

```
awplus# debug snmp detail
```

To start SNMP debugging, showing all SNMP debugging information, use the command:

```
awplus# debug snmp all
```

**Related Commands**

- [show debugging snmp](#)
- [terminal monitor](#)
- [undebug snmp](#)

# show counter snmp-server

**Overview** This command displays counters for SNMP messages received by the SNMP agent.

**Syntax** show counter snmp-server

**Mode** User Exec and Privileged Exec

**Example** To display the counters for the SNMP agent, use the command:

```
awplus# show counter snmp-server
```

**Output** Figure 54-1: Example output from the **show counter snmp-server** command

```
SNMP-SERVER counters
inPkts 11
inBadVersions 0
inBadCommunityNames 0
inBadCommunityUses 0
inASNParseErrs 0
inTooBigs 0
inNoSuchNames 0
inBadValues 0
inReadOnlys 0
inGenErrs 0
inTotalReqVars 9
inTotalSetVars 0
inGetRequests 2
inGetNexts 9
inSetRequests 0
inGetResponses 0
inTraps 0
outPkts 11
outTooBigs 0
outNoSuchNames 2
outBadValues 0
outGenErrs 0
outGetRequests 0
outGetNexts 0
outSetRequests 0
outGetResponses 11
outTraps 0
UnsupportedSecLevels 0
NotInTimeWindows 0
UnknownUserNames 0
UnknownEngineIDs 0
WrongDigest 0
DecryptionErrors 0
UnknownSecModels 0
InvalidMsgs 0
UnknownPDUHandlers 0
```

**Table 1:** Parameters in the output of the **show counter snmp-server** command

| Parameter           | Meaning                                                                                                                                                                                                                                                                                           |
|---------------------|---------------------------------------------------------------------------------------------------------------------------------------------------------------------------------------------------------------------------------------------------------------------------------------------------|
| inPkts              | The total number of SNMP messages received by the SNMP agent.                                                                                                                                                                                                                                     |
| inBadVersions       | The number of messages received by the SNMP agent for an unsupported SNMP version. It drops these messages. The SNMP agent on your device supports versions 1, 2C, and 3.                                                                                                                         |
| inBadCommunityNames | The number of messages received by the SNMP agent with an unrecognized SNMP community name. It drops these messages.                                                                                                                                                                              |
| inBadCommunityUses  | The number of messages received by the SNMP agent where the requested SNMP operation is not permitted from SNMP managers using the SNMP community named in the message.                                                                                                                           |
| inASNParseErrs      | The number of ASN.1 or BER errors that the SNMP agent has encountered when decoding received SNMP Messages.                                                                                                                                                                                       |
| inTooBig            | The number of SNMP PDUs received by the SNMP agent where the value of the error-status field is 'tooBig'. This is sent by an SNMP manager to indicate that an exception occurred when processing a request from the agent.                                                                        |
| inNoSuchNames       | The number of SNMP PDUs received by the SNMP agent where the value of the error-status field is 'noSuchName'. This is sent by an SNMP manager to indicate that an exception occurred when processing a request from the agent.                                                                    |
| inBadValues         | The number of SNMP PDUs received by the SNMP agent where the value of the error-status field is 'badValue'. This is sent by an SNMP manager to indicate that an exception occurred when processing a request from the agent.                                                                      |
| inReadOnly          | The number of valid SNMP PDUs received by the SNMP agent where the value of the error-status field is 'readOnly'. The SNMP manager should not generate a PDU which contains the value 'readOnly' in the error-status field. This indicates that there is an incorrect implementation of the SNMP. |
| inGenErrs           | The number of SNMP PDUs received by the SNMP agent where the value of the error-status field is 'genErr'.                                                                                                                                                                                         |



**Table 1:** Parameters in the output of the **show counter snmp-server** command

| Parameter      | Meaning                                                                                                                                                                                                                              |
|----------------|--------------------------------------------------------------------------------------------------------------------------------------------------------------------------------------------------------------------------------------|
| inTotalReqVars | The number of MIB objects that the SNMP agent has successfully retrieved after receiving valid SNMP Get-Request and Get-Next PDUs.                                                                                                   |
| inTotalSetVars | The number of MIB objects that the SNMP agent has successfully altered after receiving valid SNMP Set-Request PDUs.                                                                                                                  |
| inGetRequests  | The number of SNMP Get-Request PDUs that the SNMP agent has accepted and processed.                                                                                                                                                  |
| inGetNexts     | The number of SNMP Get-Next PDUs that the SNMP agent has accepted and processed.                                                                                                                                                     |
| inSetRequests  | The number of SNMP Set-Request PDUs that the SNMP agent has accepted and processed.                                                                                                                                                  |
| inGetResponses | The number of SNMP Get-Response PDUs that the SNMP agent has accepted and processed.                                                                                                                                                 |
| inTraps        | The number of SNMP Trap PDUs that the SNMP agent has accepted and processed.                                                                                                                                                         |
| outPkts        | The number of SNMP Messages that the SNMP agent has sent.                                                                                                                                                                            |
| outTooBig      | The number of SNMP PDUs that the SNMP agent has generated with the value 'tooBig' in the error-status field. This is sent to the SNMP manager to indicate that an exception occurred when processing a request from the manager.     |
| outNoSuchNames | The number of SNMP PDUs that the SNMP agent has generated with the value 'noSuchName' in the error-status field. This is sent to the SNMP manager to indicate that an exception occurred when processing a request from the manager. |
| outBadValues   | The number of SNMP PDUs that the SNMP agent has generated with the value 'badValue' in the error-status field. This is sent to the SNMP manager to indicate that an exception occurred when processing a request from the manager.   |
| outGenErrs     | The number of SNMP PDUs that the SNMP agent has generated with the value 'genErr' in the error-status field. This is sent to the SNMP manager to indicate that an exception occurred when processing a request from the manager.     |
| outGetRequests | The number of SNMP Get-Request PDUs that the SNMP agent has generated.                                                                                                                                                               |

**Table 1:** Parameters in the output of the **show counter snmp-server** command

| Parameter                 | Meaning                                                                                                                                           |
|---------------------------|---------------------------------------------------------------------------------------------------------------------------------------------------|
| outGetNexts               | The number of SNMP Get-Next PDUs that the SNMP agent has generated.                                                                               |
| outSetRequests            | The number of SNMP Set-Request PDUs that the SNMP agent has generated.                                                                            |
| outGetResponses           | The number of SNMP Get-Response PDUs that the SNMP agent has generated.                                                                           |
| outTraps                  | The number of SNMP Trap PDUs that the SNMP agent has generated.                                                                                   |
| UnsupportedSecurityLevels | The number of received packets that the SNMP agent has dropped because they requested a securityLevel unknown or not available to the SNMP agent. |
| NotInTimeWindows          | The number of received packets that the SNMP agent has dropped because they appeared outside of the authoritative SNMP agent's window.            |
| UnknownUserNames          | The number of received packets that the SNMP agent has dropped because they referenced an unknown user.                                           |
| UnknownEngineIDs          | The number of received packets that the SNMP agent has dropped because they referenced an unknown snmpEngineID.                                   |
| WrongDigest               | The number of received packets that the SNMP agent has dropped because they didn't contain the expected digest value.                             |
| DecryptionErrors          | The number of received packets that the SNMP agent has dropped because they could not be decrypted.                                               |
| UnknownSecModels          | The number of messages received that contain a security model that is not supported by the server. Valid for SNMPv3 messages only.                |
| InvalidMsgs               | The number of messages received where the security model is supported but the authentication fails. Valid for SNMPv3 messages only.               |
| UnknownPDUHandlers        | The number of times the SNMP handler has failed to process a PDU. This is a system debugging counter.                                             |

**Related Commands** [show snmp-server](#)

# show debugging snmp

**Overview** This command displays whether SNMP debugging is enabled or disabled.

**Syntax** `show debugging snmp`

**Mode** User Exec and Privileged Exec

**Example** To display the status of SNMP debugging, use the command:

```
awplus# show debugging snmp
```

**Output** Figure 54-2: Example output from the **show debugging snmp** command

```
Sntp (SMUX) debugging status:
Sntp debugging is on
```

**Related  
Commands** [debug snmp](#)

# show running-config snmp

**Overview** This command displays the current configuration of SNMP on your device.

**Syntax** `show running-config snmp`

**Mode** Privileged Exec

**Example** To display the current configuration of SNMP on your device, use the command:

```
awplus# show running-config snmp
```

**Output** Figure 54-3: Example output from the **show running-config snmp** command

```
snmp-server contact AlliedTelesis
snmp-server location Philippines
snmp-server group grou1 auth read view1 write view1 notify view1
snmp-server view view1 1 included
snmp-server community public
snmp-server user user1 group1 auth md5 password priv des
password
```

**Related  
Commands** [show snmp-server](#)

# show snmp-server

**Overview** This command displays the status and current configuration of the SNMP server.

**Syntax** `show snmp-server`

**Mode** Privileged Exec

**Example** To display the status of the SNMP server, use the command:

```
awplus# show snmp-server
```

**Output** Figure 54-4: Example output from the **show snmp-server** command

```
SNMP Server Enabled
IP Protocol IPv4
SNMPv3 Engine ID (configured name) ... Not set
SNMPv3 Engine ID (actual) 0x80001f888021338e4747b8e607
```

- Related Commands**
- [debug snmp](#)
  - [show counter snmp-server](#)
  - [snmp-server](#)
  - [snmp-server engineID local](#)
  - [snmp-server engineID local reset](#)

# show snmp-server community

**Overview** This command displays the SNMP server communities configured on the device. SNMP communities are specific to v1 and v2c.

**Syntax** `show snmp-server community`

**Mode** Privileged Exec

**Example** To display the SNMP server communities, use the command:

```
awplus# show snmp-server community
```

**Output** Figure 54-5: Example output from the **show snmp-server community** command

```
SNMP community information:
Community Name public
Access Read-only
View none
```

**Related Commands** [show snmp-server](#)  
[snmp-server community](#)

# show snmp-server group

**Overview** This command displays information about SNMP server groups. This command is used with SNMP version 3 only.

**Syntax** `show snmp-server group`

**Mode** Privileged Exec

**Example** To display the SNMP groups configured on the device, use the command:

```
awplus# show snmp-server group
```

**Output** Figure 54-6: Example output from the **show snmp-server group** command

```
SNMP group information:
 Group name guireadgroup
 Security Level priv
 Read View guiview
 Write View none
 Notify View none

 Group name guiwritegroup
 Security Level priv
 Read View none
 Write View guiview
 Notify View none
```

**Related Commands** [show snmp-server](#)  
[snmp-server group](#)

# show snmp-server user

**Overview** This command displays the SNMP server users and is used with SNMP version 3 only.

**Syntax** `show snmp-server user`

**Mode** Privileged Exec

**Example** To display the SNMP server users configured on the device, use the command:

```
awplus# show snmp-server user
```

**Output** Figure 54-7: Example output from the **show snmp-server user** command

| Name   | Group name   | Auth | Privacy |
|--------|--------------|------|---------|
| freddy | guireadgroup | none | none    |

**Related Commands** [show snmp-server](#)  
[snmp-server user](#)



# show snmp-server view

**Overview** This command displays the SNMP server views and is used with SNMP version 3 only.

**Syntax** `show snmp-server view`

**Mode** Privileged Exec

**Example** To display the SNMP server views configured on the device, use the command:

```
awplus# show snmp-server view
```

**Output** Figure 54-8: Example output from the **show snmp-server view** command

```
SNMP view information:
View Name view1
OID 1
Type included
```

**Related Commands** [show snmp-server](#)  
[snmp-server view](#)

# snmp trap link-status

**Overview** Use this command to enable SNMP to send link status notifications (traps) for the interfaces when an interface goes up (linkUp) or down (linkDown).

Use the **no** variant of this command to disable the sending of link status notifications.

**Syntax** `snmp trap link-status [enterprise]`  
`no snmp trap link-status`

| Parameter  | Description                                          |
|------------|------------------------------------------------------|
| enterprise | Send an Allied Telesis enterprise type of link trap. |

**Default** By default, link status notifications are disabled.

**Mode** Interface Configuration

**Usage** The link status notifications can be enabled for the following interface types:

- switch port (e.g. port 1.0.1)
- VLAN (e.g. vlan2)
- Ethernet (e.g. eth1)
- static and dynamic link aggregation (e.g. sa2, po2)

To specify where notifications are sent, use the [snmp-server host](#) command. To configure the device globally to send other notifications, use the [snmp-server enable trap](#) command.

**Examples** To enable SNMP to send link status notifications for ports 1.0.2 to 1.0.6, use following commands:

```
awplus# configure terminal
awplus(config)# interface port1.0.2-1.0.6
awplus(config-if)# snmp trap link-status
```

To enable SNMP to send an Allied Telesis enterprise type of link status notification for port1.0.1, use following commands:

```
awplus# configure terminal
awplus(config)# interface 1.0.1
awplus(config-if)# snmp trap link-status enterprise
```

To disable the sending of link status notifications for port 1.0.2, use following commands:

```
awplus# configure terminal
awplus(config)# interface port1.0.2
awplus(config-if)# no snmp trap link-status
```

**Related  
Commands**

[show interface](#)  
[snmp trap link-status suppress](#)  
[snmp-server enable trap](#)  
[snmp-server host](#)

# snmp trap link-status suppress

**Overview** Use this command to enable the suppression of link status notifications (traps) for the interfaces beyond the specified threshold, in the specified interval.

Use the **no** variant of this command to disable the suppression of link status notifications for the ports.

**Syntax** `snmp trap link-status suppress {time {<1-60>|default}|threshold {<1-20>|default}}`

`no snmp trap link-status suppress`

| Parameter | Description                                                                                                                                                                                       |
|-----------|---------------------------------------------------------------------------------------------------------------------------------------------------------------------------------------------------|
| time      | Set the suppression timer for link status notifications.                                                                                                                                          |
| <1-60>    | The suppress time in seconds.                                                                                                                                                                     |
| default   | The default suppress time in seconds (60).                                                                                                                                                        |
| threshold | Set the suppression threshold for link status notifications. This is the number of link status notifications after which to suppress further notifications within the suppression timer interval. |
| <1-20>    | The number of link status notifications.                                                                                                                                                          |
| default   | The default number of link status notifications (20).                                                                                                                                             |

**Default** By default, if link status notifications are enabled (they are enabled by default), the suppression of link status notifications is enabled: notifications that exceed the notification threshold (default 20) within the notification timer interval (default 60 seconds) are not sent.

**Mode** Interface Configuration

**Usage** An unstable network can generate many link status notifications. When notification suppression is enabled, a suppression timer is started when the first link status notification of a particular type (linkUp or linkDown) is sent for an interface. If the threshold number of notifications of this type is sent before the timer reaches the suppress time, any further notifications of this type generated for the interface during the interval are not sent. At the end of the interval, the sending of link status notifications resumes, until the threshold is reached in the next interval.

**Examples** To enable the suppression of link status notifications for ports 1.0.2 to 1.0.6 after 10 notifications have been sent in 40 seconds, use following commands:

```
awplus# configure terminal
awplus(config)# interface port1.0.2-1.0.6
awplus(config-if)# snmp trap link-status suppress time 40
threshold 10
```

To disable the suppression link status notifications for port 1.0.2, use following commands:

```
awplus# configure terminal
awplus(config)# interface port1.0.2
awplus(config-if)# no snmp trap link-status suppress
```

**Related  
Commands**    [show interface](#)  
                  [snmp trap link-status](#)

# snmp-server

**Overview** Use this command to enable the SNMP agent (server) on the device. The SNMP agent receives and processes SNMP packets sent to the device, and generates notifications (traps) that have been enabled by the [snmp-server enable trap](#) command.

Use the **no** variant of this command to disable the SNMP agent on the device. When SNMP is disabled, SNMP packets received by the device are discarded, and no notifications are generated. This does not remove any existing SNMP configuration.

**Syntax** `snmp-server [ip|ipv6]`  
`no snmp-server [ip|ipv6]`

| Parameter | Description                                |
|-----------|--------------------------------------------|
| ip        | Enable or disable the SNMP agent for IPv4. |
| ipv6      | Enable or disable the SNMP agent for IPv6. |

**Default** By default, the SNMP agent is enabled for both IPv4 and IPv6. If neither the **ip** parameter nor the **ipv6** parameter is specified for this command, then SNMP is enabled or disabled for both IPv4 and IPv6.

**Mode** Global Configuration

**Examples** To enable SNMP on the device for both IPv4 and IPv6, use the commands:

```
awplus# configure terminal
awplus(config)# snmp-server
```

To enable the SNMP agent for IPv4 on the device, use the commands:

```
awplus# configure terminal
awplus(config)# snmp-server ip
```

To disable the SNMP agent for both IPv4 and IPv6 on the device, use the commands:

```
awplus# configure terminal
awplus(config)# no snmp-server
```

To disable the SNMP agent for IPv4, use the commands:

```
awplus(config)# no snmp-server ipv4
```

**Related  
Commands**

show snmp-server  
show snmp-server community  
show snmp-server user  
snmp-server community  
snmp-server contact  
snmp-server enable trap  
snmp-server engineID local  
snmp-server group  
snmp-server host  
snmp-server location  
snmp-server view

# snmp-server community

**Overview** This command creates an SNMP community, optionally setting the access mode for the community. The default access mode is read only. If view is not specified, the community allows access to all the MIB objects. The SNMP communities are only valid for SNMPv1 and v2c and provide very limited security. Communities should not be used when operating SNMPv3.

The **no** variant of this command removes an SNMP community. The specified community must already exist on the device.

**Syntax** `snmp-server community <community-name> {view <view-name>|ro|rw}`  
`no snmp-server community <community-name> [{view <view-name>}]`

| Parameter        | Description                                                                                        |
|------------------|----------------------------------------------------------------------------------------------------|
| <community-name> | Community name. The community name is a case sensitive string of up to 20 characters.              |
| view             | Configure SNMP view. If view is not specified, the community allows access to all the MIB objects. |
| <view-name>      | View name. The view name is a string up to 20 characters long and is case sensitive.               |
| ro               | Read-only community.                                                                               |
| rw               | Read-write community.                                                                              |

**Mode** Global Configuration

**Example** The following command creates an SNMP community called “public” with read only access to all MIB variables from any management station.

```
awplus# configure terminal
awplus(config)# snmp-server community public ro
```

The following command removes an SNMP community called “public”

```
awplus# configure terminal
awplus(config)# no snmp-server community public
```

**Related Commands** [show snmp-server](#)  
[show snmp-server community](#)  
[snmp-server view](#)



# snmp-server contact

**Overview** This command sets the contact information for the system. The contact name is:

- displayed in the output of the [show system](#) command
- stored in the MIB object sysContact

The **no** variant of this command removes the contact information from the system.

**Syntax** `snmp-server contact <contact-info>`  
`no snmp-server contact`

| Parameter                         | Description                                                                                                                     |
|-----------------------------------|---------------------------------------------------------------------------------------------------------------------------------|
| <code>&lt;contact-info&gt;</code> | The contact information for the system, from 0 to 255 characters long. Valid characters are any printable character and spaces. |

**Mode** Global Configuration

**Example** To set the system contact information to "support@alliedtelesis.co.nz", use the command:

```
awplus# configure terminal
awplus(config)# snmp-server contact
support@alliedtelesis.co.nz
```

**Related Commands** [show system](#)  
[snmp-server location](#)  
[snmp-server group](#)

# snmp-server enable trap

**Overview** Use this command to enable the switch to transmit the specified notifications (traps).

Note that the Environmental Monitoring traps defined in the AT-ENVMONv2-MIB are enabled by default.

Use the **no** variant of this command to disable the transmission of the specified notifications.

**Syntax** `snmp-server enable trap <trap-list>`  
`no snmp-server enable trap <trap-list>`

The traps you can enable are shown in the parameter table below.

| Parameter    | Description                             |
|--------------|-----------------------------------------|
| atmf         | AMF traps.                              |
| atmflink     | AMF Link traps.                         |
| atmfnode     | AMF Node traps.                         |
| atmfrr       | AMF Reboot Rolling traps.               |
| auth         | Authentication failure.                 |
| bgp          | BGP traps.                              |
| mstp         | MSTP traps.                             |
| nsm          | NSM traps.                              |
| ospf         | OSPF traps.                             |
| pim          | PIM traps.                              |
| thrash-limit | MAC address Thrash Limiting traps.      |
| vrrp         | Virtual Router Redundancy (VRRP) traps. |

**Default** By default, no notifications are generated.

**Mode** Global Configuration

**Usage** This command cannot be used to enable link status notifications globally. To enable link status notifications for particular interfaces, use the [snmp trap link-status](#) command.

To specify where notifications are sent, use the [snmp-server host](#) command.

Note that more than one trap can be configured with one command entry, and also note this command applied to notifications send by SNMP version 3.

**Examples** To enable the device to send a notification if an AMF node changes its status, use the following commands:

```
awplus# configure terminal
awplus(config)# snmp-server enable trap atmfnode
```

To enable the device to send MAC address Thrash Limiting traps, use the following commands:

```
awplus# configure terminal
awplus(config)# snmp-server enable trap thrash-limit
```

To disable the device from sending MAC address Thrash Limiting traps, use the following commands:

```
awplus# configure terminal
awplus(config)# no snmp-server enable trap thrash-limit
```

To enable the device to send OSPF and VRRP-related traps, use the following commands:

```
awplus# configure terminal
awplus(config)# snmp-server enable trap ospf vrrp
```

To disable OSPF traps being sent out by the device, use the following commands:

```
awplus# configure terminal
awplus(config)# no snmp-server enable trap ospf
```

**Related  
Commands** [show snmp-server](#)  
[snmp trap link-status](#)  
[snmp-server host](#)

# snmp-server engineID local

**Overview** Use this command to configure the SNMPv3 engine ID. The SNMPv3 engine ID is used to uniquely identify the SNMPv3 agent on a device when communicating with SNMP management clients. Once an SNMPv3 engine ID is assigned, this engine ID is permanently associated with the device until you change it.

Use the **no** variant of this command to set the user defined SNMPv3 engine ID to a system generated pseudo-random value by resetting the SNMPv3 engine. The **no snmp-server engineID local** command has the same effect as the **snmp-server engineID local default** command.

Note that the [snmp-server engineID local reset](#) command is used to force the system to generate a new engine ID when the current engine ID is also system generated.

**Syntax** `snmp-server engineID local {<engine-id>|default}`  
`no snmp-server engineID local`

| Parameter                      | Description                                                                                                                                                                                                                                                                                      |
|--------------------------------|--------------------------------------------------------------------------------------------------------------------------------------------------------------------------------------------------------------------------------------------------------------------------------------------------|
| <code>&lt;engine-id&gt;</code> | Specify SNMPv3 Engine ID value, a string of up to 27 characters.                                                                                                                                                                                                                                 |
| <code>default</code>           | Set SNMPv3 engine ID to a system generated value by resetting the SNMPv3 engine, provided the current engine ID is user defined. If the current engine ID is system generated, use the <a href="#">snmp-server engineID local reset</a> command to force the system to generate a new engine ID. |

**Mode** Global Configuration

**Usage** All devices must have a unique engine ID which is permanently set unless it is configured by the user.

**Example** To set the SNMPv3 engine ID to 800000cf030000cd123456, use the following commands:

```
awplus# configure terminal
awplus(config)# snmp-server engineID local
800000cf030000cd123456
```

To set a user defined SNMPv3 engine ID back to a system generated value, use the following commands:

```
awplus# configure terminal
awplus(config)# no snmp-server engineID local
```

**Output** The following example shows the engine ID values after configuration:

```
awplus(config)#snmp-server engineid local asdgdh231234d
awplus(config)#exit
awplus#show snmp-server

SNMP Server Enabled
IP Protocol IPv4
SNMPv3 Engine ID (configured name) ... asdgdh231234d
SNMPv3 Engine ID (actual) 0x80001f888029af52e149198483

awplus(config)#no snmp-server engineid local
awplus(config)#exit
awplus#show snmp-server

SNMP Server Enabled
IP Protocol IPv4
SNMPv3 Engine ID (configured name) ... Not set
SNMPv3 Engine ID (actual) 0x80001f888029af52e149198483
```

**Related Commands**

- [show snmp-server](#)
- [snmp-server engineID local reset](#)
- [snmp-server group](#)

# snmp-server engineID local reset

**Overview** Use this command to force the device to generate a new pseudo-random SNMPv3 engine ID by resetting the SNMPv3 engine. If the current engine ID is user defined, use the [snmp-server engineID local](#) command to set SNMPv3 engine ID to a system generated value.

**Syntax** `snmp-server engineID local reset`

**Mode** Global Configuration

**Example** To force the SNMPv3 engine ID to be reset to a system generated value, use the commands:

```
awplus# configure terminal
awplus(config)# snmp-server engineID local reset
```

**Related Commands** [snmp-server engineID local](#)  
[show snmp-server](#)

# snmp-server group

**Overview** This command is used with SNMP version 3 only, and adds an SNMP group, optionally setting the security level and view access modes for the group. The security and access views defined for the group represent the minimum required of its users in order to gain access.

The **no** variant of this command deletes an SNMP group, and is used with SNMPv3 only. The group with the specified authentication/encryption parameters must already exist.

**Syntax** `snmp-server group <groupname> {auth|noauth|priv} [read <readname>|write <writename>|notify <notifyname>]`  
`no snmp-server group <groupname> {auth|noauth|priv}`

| Parameter    | Description                                                                                 |
|--------------|---------------------------------------------------------------------------------------------|
| <groupname>  | Group name. The group name is a string up to 20 characters long and is case sensitive.      |
| auth         | Authentication.                                                                             |
| noauth       | No authentication and no encryption.                                                        |
| priv         | Authentication and encryption.                                                              |
| read         | Configure read view.                                                                        |
| <readname>   | Read view name.                                                                             |
| write        | Configure write view.                                                                       |
| <writename>  | Write view name. The view name is a string up to 20 characters long and is case sensitive.  |
| notify       | Configure notify view.                                                                      |
| <notifyname> | Notify view name. The view name is a string up to 20 characters long and is case sensitive. |

**Mode** Global Configuration

**Examples** To add SNMP group, for ordinary users, use the following commands:

```
awplus# configure terminal
awplus(config)# snmp-server group usergroup noauth read
useraccess write useraccess
```

To delete SNMP group `usergroup`, use the following commands

```
awplus# configure terminal
awplus(config)# no snmp-server group usergroup noauth
```

**Related  
Commands**

- snmp-server
- show snmp-server
- show snmp-server group
- show snmp-server user



# snmp-server host

**Overview** This command specifies an SNMP trap host destination to which Trap or Inform messages generated by the device are sent.

For SNMP version 1 and 2c you must specify the community name parameter. For SNMP version 3, specify the authentication/encryption parameters and the user name. If the version is not specified, the default is SNMP version 1. Inform messages can be sent instead of traps for SNMP version 2c and 3.

Use the **no** variant of this command to remove an SNMP trap host. The trap host must already exist.

The trap host is uniquely identified by:

- host IP address (IPv4 or IPv6),
- inform or trap messages,
- community name (SNMPv1 or SNMP v2c) or the authentication/encryption parameters and user name (SNMP v3).

**Syntax**

```
snmp-server host {<ipv4-address>|<ipv6-address>} [traps]
[version 1] <community-name>]

snmp-server host {<ipv4-address>|<ipv6-address>}
[informs|traps] version 2c <community-name>

snmp-server host {<ipv4-address>|<ipv6-address>}
[informs|traps] version 3 {auth|noauth|priv} <user-name>

no snmp-server host {<ipv4-address>|<ipv6-address>} [traps]
[version 1] <community-name>

no snmp-server host {<ipv4-address>|<ipv6-address>}
[informs|traps] version 2c <community-name>

no snmp-server host {<ipv4-address>|<ipv6-address>}
[informs|traps] version 3 {auth|noauth|priv} <user-name>
```

| Parameter      | Description                                                                            |
|----------------|----------------------------------------------------------------------------------------|
| <ipv4-address> | IPv4 trap host address in the format A . B . C . D, for example, 192.0.2.2.            |
| <ipv6-address> | IPv6 trap host address in the format x : x : : x : x for example, 2001:db8::8a2e:7334. |
| informs        | Send Inform messages to this host.                                                     |
| traps          | Send Trap messages to this host (default).                                             |
| version        | SNMP version to use for notification messages. Default: version 1.                     |
| 1              | Use SNMPv1 (default).                                                                  |
| 2c             | Use SNMPv2c.                                                                           |
| 3              | Use SNMPv3.                                                                            |

| Parameter        | Description                           |
|------------------|---------------------------------------|
| auth             | Authentication.                       |
| noauth           | No authentication.                    |
| priv             | Encryption.                           |
| <community-name> | The SNMPv1 or SNMPv2c community name. |
| <user-name>      | SNMPv3 user name.                     |

**Mode** Global Configuration

**Examples** To configure the device to send generated traps to the IPv4 host destination 192.0.2.5 with the SNMPv2c community name public, use the following command:

```
awplus# configure terminal
awplus(config)# snmp-server host version 2c public192.0.2.5
```

To configure the device to send generated traps to the IPv6 host destination 2001:db8::8a2e:7334 with the SNMPv2c community name private, use the following command:

```
awplus# configure terminal
awplus(config)# snmp-server host version 2c
private2001:db8::8a2e:7334
```

To remove a configured trap host of 192.0.2.5 with the SNMPv2c community name public, use the following command:

```
awplus# configure terminal
awplus(config)# no snmp-server host version 2c public192.0.2.5
```

**Related Commands**

- [snmp trap link-status](#)
- [snmp-server enable trap](#)
- [snmp-server view](#)

# snmp-server legacy-ifadminstatus

**Overview** Use this command to set the ifAdminStatus to reflect the operational state of the interface, rather than the administrative state.

The **no** variant of this command sets the ifAdminStatus to reflect the administrative state of the interface.

**Syntax** `snmp-server legacy-ifadminstatus`  
`no snmp-server legacy-ifadminstatus`

**Default** Legacy ifAdminStatus is turned off by default, so by default the SNMP ifAdminStatus reflects the administrative state of the interface.

**Mode** Global Configuration

**Usage** Note that if you enable Legacy ifAdminStatus, the ifAdminStatus will report a link's status as Down when the link has been blocked by a process such as loop protection.

**Example** To turn on Legacy ifAdminStatus, use the command:

```
awplus#snmp-server legacy-ifadminstatus
```

**Related Commands** [show interface](#)

# snmp-server location

**Overview** This command sets the location of the system. The location is:

- displayed in the output of the [show system](#) command
- stored in the MIB object sysLocation

The **no** variant of this command removes the configured location from the system.

**Syntax** `snmp-server location <location-name>`  
`no snmp-server location`

| Parameter                          | Description                                                                                                         |
|------------------------------------|---------------------------------------------------------------------------------------------------------------------|
| <code>&lt;location-name&gt;</code> | The location of the system, from 0 to 255 characters long. Valid characters are any printable character and spaces. |

**Mode** Global Configuration

**Example** To set the location to “server room 523”, use the following commands:

```
awplus# configure terminal
awplus(config)# snmp-server location server room 523
```

**Related Commands** [show snmp-server](#)  
[show system](#)  
[snmp-server contact](#)

# snmp-server source-interface

**Overview** Use this command to specify the originating interface for SNMP traps or informs. An interface specified by this command must already have an IP address assigned to it.

Use the **no** variant of this command to reset the interface to its default value (the originating egress interface).

**Syntax** `snmp-server source-interface {traps|informs} <interface-name>`  
`no snmp-server source-interface {traps|informs}`

| Parameter        | Description                                                |
|------------------|------------------------------------------------------------|
| traps            | SNMP traps.                                                |
| informs          | SNMP informs.                                              |
| <interface-name> | Interface name (must already have an IP address assigned). |

**Default** By default, the source interface is the originating egress interface of the traps and informs messages.

**Mode** Global Configuration

**Usage** An SNMP trap or inform message that is sent from an SNMP server carries the notification IP address of its originating interface. Use this command to assign this interface.

**Example** The following commands set VLAN20 to be the interface whose IP address is used as the originating address in SNMP informs packets.

```
awplus# configure terminal
awplus(config)# snmp-server source-interface informs vlan20
```

The following commands reset the originating source interface for SNMP trap messages to be the default interface (the originating egress interface):

```
awplus# configure terminal
awplus(config)# no snmp-server source-interface traps
```

**Validation Commands** `show running-config`

# snmp-server startup-trap-delay

**Overview** Use this command to set the time in seconds after following completion of the device startup sequence before the device sends any SNMP traps (or SNMP notifications).

Use the no variant of this command to restore the default startup delay of 30 seconds.

**Syntax** `snmp-server startup-trap-delay <delay-time>`  
`no snmp-server startup-trap-delay`

| Parameter                       | Description                                                                   |
|---------------------------------|-------------------------------------------------------------------------------|
| <code>&lt;delay-time&gt;</code> | Specify an SNMP trap delay time in seconds in the range of 30 to 600 seconds. |

**Default** The SNMP server trap delay time is 30 seconds. The no variant restores the default.

**Mode** Global Configuration

**Example** To delay the device sending SNMP traps until 60 seconds after device startup, use the following commands:

```
awplus# configure terminal
awplus(config)# snmp-server startup-trap-delay 60
```

To restore the sending of SNMP traps to the default of 30 seconds after device startup, use the following commands:

```
awplus# configure terminal
awplus(config)# no snmp-server startup-trap-delay
```

**Validation Commands** `show snmp-server`

# snmp-server user

**Overview** Use this command to create or move users as members of specified groups. This command is used with SNMPv3 only.

The **no** variant of this command removes an SNMPv3 user. The specified user must already exist.

**Syntax** `snmp-server user <username> <groupname> [encrypted] [auth {md5|sha} <auth-password>] [priv {des|aes} <privacy-password>]`  
`no snmp-server user <username>`

| Parameter          | Description                                                                                         |
|--------------------|-----------------------------------------------------------------------------------------------------|
| <username>         | User name. The user name is a string up to 20 characters long and is case sensitive.                |
| <groupname>        | Group name. The group name is a string up to 20 characters long and is case sensitive.              |
| encrypted          | Use the encrypted parameter when you want to enter encrypted passwords.                             |
| auth               | Authentication protocol.                                                                            |
| md5                | MD5 Message Digest Algorithms.                                                                      |
| sha                | SHA Secure Hash Algorithm.                                                                          |
| <auth-password>    | Authentication password. The password is a string of 8 to 20 characters long and is case sensitive. |
| priv               | Privacy protocol.                                                                                   |
| des                | DES Data Encryption Standard.                                                                       |
| aes                | AES Advanced Encryption Standards.                                                                  |
| <privacy-password> | Privacy password. The password is a string of 8 to 20 characters long and is case sensitive.        |

**Mode** Global Configuration

**Usage** Additionally this command provides the option of selecting an authentication protocol and (where appropriate) an associated password. Similarly, options are offered for selecting a privacy protocol and password.

- Note that each SNMP user must be configured on both the manager and agent entities. Where passwords are used, these passwords must be the same for both entities.
- Use the **encrypted** parameter when you want to enter already encrypted passwords in encrypted form as displayed in the running and startup configs stored on the device. For example, you may need to move a user from one group to another group and keep the same passwords for the user instead of removing the user to apply new passwords.

- User passwords are entered using plaintext without the **encrypted** parameter and are encrypted according to the authentication and privacy protocols selected.
- User passwords are viewed as encrypted passwords in running and startup configs shown from **show running-config** and **show startup-config** commands respectively. Copy and paste encrypted passwords from running-configs or startup-configs to avoid entry errors.

**Examples** To add SNMP user `authuser` as a member of group `usergroup`, with authentication protocol `md5`, authentication password `Authpass`, privacy protocol `des` and privacy password `Privpass`, use the following commands

```
awplus# configure terminal
awplus(config)# snmp-server user authuser usergroup auth md5
Authpass priv des Privpass
```

Validate the user is assigned to the group using the **show snmp-server user** command:

```
awplus#show snmp-server user
Name Group name Auth Privacy
----- -
authuser usergroup md5 des
```

To enter existing SNMP user `authuser` with existing passwords as a member of group `newusergroup` with authentication protocol `md5` plus the encrypted authentication password `0x1c74b9c22118291b0ce0cd883f8dab6b74`, privacy protocol `des` plus the encrypted privacy password `0x0e0133db5453ebd03822b004eeacb6608f`, use the following commands

```
awplus# configure terminal
awplus(config)# snmp-server user authuser newusergroup
encrypted auth md5 0x1c74b9c22118291b0ce0cd883f8dab6b74 priv
des 0x0e0133db5453ebd03822b004eeacb6608f
```

**NOTE:** Copy and paste the encrypted passwords from the **running-config** or the **startup-config** displayed, using the **show running-config** and **show startup-config** commands respectively, into the command line to avoid key stroke errors issuing this command.

Validate the user has been moved from the first group using the **show snmp-server user** command:

```
awplus#show snmp-server user
Name Group name Auth Privacy
----- -
authuser newusergroup md5 des
```

To delete SNMP user `authuser`, use the following commands:

```
awplus# configure terminal
awplus(config)# no snmp-server user authuser
```



**Related  
Commands** [show snmp-server user](#)  
[snmp-server view](#)

# snmp-server view

**Overview** Use this command to create an SNMP view that specifies a sub-tree of the MIB. Further sub-trees can then be added by specifying a new OID to an existing view. Views can be used in SNMP communities or groups to control the remote manager's access.

**NOTE:** The object identifier must be specified in a sequence of integers separated by decimal points.

The **no** variant of this command removes the specified view on the device. The view must already exist.

**Syntax** `snmp-server view <view-name> <mib-name> {included|excluded}`  
`no snmp-server view <view-name>`

| Parameter   | Description                                                                                         |
|-------------|-----------------------------------------------------------------------------------------------------|
| <view-name> | SNMP server view name.<br>The view name is a string up to 20 characters long and is case sensitive. |
| <mib-name>  | Object identifier of the MIB.                                                                       |
| included    | Include this OID in the view.                                                                       |
| excluded    | Exclude this OID in the view.                                                                       |

**Mode** Global Configuration

**Examples** The following command creates a view called "loc" that includes the system location MIB sub-tree.

```
awplus(config)# snmp-server view loc 1.3.6.1.2.1.1.6.0 included
```

To remove the view "loc" use the following command

```
awplus(config)# no snmp-server view loc
```

**Related Commands** [show snmp-server view](#)  
[snmp-server community](#)

# undebbug snmp

**Overview** This command applies the functionality of the no `debug snmp` command.

# 55

# SMTP Commands

## Introduction

**Overview** This chapter provides an alphabetical reference for commands used to configure SMTP.

For information on filtering and saving command output, see the [“Getting Started with AlliedWare Plus” Feature Overview and Configuration Guide](#).

- Command List**
- [“debug mail”](#) on page 2509
  - [“delete mail”](#) on page 2510
  - [“mail”](#) on page 2511
  - [“show counter mail”](#) on page 2512
  - [“show mail”](#) on page 2513
  - [“undebg mail”](#) on page 2514

# debug mail

**Overview** This command turns on debugging for sending emails.  
The **no** variant of this command turns off debugging for sending emails.

**Syntax** debug mail  
no debug mail

**Mode** Privileged Exec

**Examples** To turn on debugging for sending emails, use the command:

```
awplus# debug mail
```

To turn off debugging for sending emails, use the command:

```
awplus# no debug mail
```

**Related  
Commands** delete mail  
mail  
show mail  
show counter mail  
undebug mail

# delete mail

**Overview** This command deletes mail from the queue.

**Syntax** delete mail [mail-id <mail-id>|all]

| Parameter | Description                                                                                                        |
|-----------|--------------------------------------------------------------------------------------------------------------------|
| mail-id   | Deletes a single mail from the mail queue.                                                                         |
|           | <mail-id> An unique mail ID number. Use the <a href="#">show mail</a> command to display this for an item of mail. |
| all       | Delete all the mail in the queue.                                                                                  |

**Mode** Privileged Exec

**Examples** To delete a unique mail item 20060912142356.1234 from the queue, use the command:

```
awplus# delete mail 20060912142356.1234
```

To delete all mail from the queue, use the command:

```
awplus# delete mail all
```

**Related Commands** [debug mail](#)  
[mail](#)  
[show mail](#)

# mail

**Overview** This command sends an email using the SMTP protocol. If you specify a file the text inside the file is sent in the message body.

If you do not specify the **to**, **file**, or **subject** parameters, the CLI prompts you for the missing information.

**Syntax** `mail [{to <to>|subject <subject>|file <filename>}]`

| Parameter | Description                                                                                                                                    |
|-----------|------------------------------------------------------------------------------------------------------------------------------------------------|
| to        | The email recipient.<br><hr/> <code>&lt;to&gt;</code> Email address.                                                                           |
| subject   | Description of the subject of this email. Use quote marks when the subject text contains spaces.<br><hr/> <code>&lt;subject&gt;</code> String. |
| file      | File to insert as text into the message body.<br><hr/> <code>&lt;filename&gt;</code> String.                                                   |

**Mode** Privileged Exec

**Example** To send an email to `rei@nerv.com` with the subject `dummy plug configuration`, and with the message body inserted from the file `plug.conf` use the command:

```
awplus# mail rei@nerv.com subject dummy plug configuration
filename plug.conf
```

**Related Commands**

- [debug mail](#)
- [delete mail](#)
- [show mail](#)
- [show counter mail](#)

# show counter mail

**Overview** This command displays the mail counters.

**Syntax** `show counter mail`

**Mode** User Exec and Privileged Exec

**Output** Figure 55-1: Example output from the **show counter mail** command

```
Mail Client (SMTP) counters
Mails Sent 0
Mails Sent Fails 1
```

**Table 1:** Parameters in the output of the **show counter mail** command

| Parameter        | Description                                                                   |
|------------------|-------------------------------------------------------------------------------|
| Mails Sent       | The number of emails sent successfully since the last device restart.         |
| Mails Sent Fails | The number of emails the device failed to send since the last device restart. |

**Example** To show the emails in the queue use the command:

```
awplus# show counter mail
```

- Related Commands**
- [debug mail](#)
  - [delete mail](#)
  - [mail](#)
  - [show mail](#)



# show mail

**Overview** This command displays the emails in the queue.

**Syntax** `show mail`

**Mode** Privileged Exec

**Example** To display the emails in the queue use the command:

```
awplus# show mail
```

**Related  
Commands** [delete mail](#)  
[mail](#)

[show counter mail](#)

# undebug mail

**Overview** This command applies the functionality of the no [debug mail](#) command.

# 56

# Secure Shell (SSH) Commands

## Introduction

**Overview** This chapter provides an alphabetical reference for commands used to configure Secure Shell (SSH). For more information, see the [SSH Feature Overview and Configuration Guide](#).

- Command List**
- “[banner login \(SSH\)](#)” on page 2517
  - “[clear ssh](#)” on page 2518
  - “[crypto key destroy hostkey](#)” on page 2519
  - “[crypto key destroy userkey](#)” on page 2520
  - “[crypto key generate hostkey](#)” on page 2521
  - “[crypto key generate userkey](#)” on page 2523
  - “[crypto key pubkey-chain knownhosts](#)” on page 2524
  - “[crypto key pubkey-chain userkey](#)” on page 2526
  - “[debug ssh client](#)” on page 2528
  - “[debug ssh server](#)” on page 2529
  - “[service ssh](#)” on page 2530
  - “[show banner login](#)” on page 2532
  - “[show crypto key hostkey](#)” on page 2533
  - “[show crypto key pubkey-chain knownhosts](#)” on page 2535
  - “[show crypto key pubkey-chain userkey](#)” on page 2537
  - “[show crypto key userkey](#)” on page 2538
  - “[show running-config ssh](#)” on page 2539
  - “[show ssh](#)” on page 2541
  - “[show ssh client](#)” on page 2543

- [“show ssh server”](#) on page 2544
- [“show ssh server allow-users”](#) on page 2546
- [“show ssh server deny-users”](#) on page 2547
- [“ssh”](#) on page 2548
- [“ssh client”](#) on page 2550
- [“ssh server”](#) on page 2552
- [“ssh server allow-users”](#) on page 2554
- [“ssh server authentication”](#) on page 2556
- [“ssh server deny-users”](#) on page 2558
- [“ssh server max-auth-tries”](#) on page 2560
- [“ssh server resolve-host”](#) on page 2561
- [“ssh server scp”](#) on page 2562
- [“ssh server sftp”](#) on page 2563
- [“undebg ssh client”](#) on page 2564
- [“undebg ssh server”](#) on page 2565

# banner login (SSH)

**Overview** This command configures a login banner on the SSH server. This displays a message on the remote terminal of the SSH client before the login prompt. SSH client version 1 does not support this banner.

To add a banner, first enter the command **banner login**, and hit [Enter]. Write your message. You can use any character and spaces. Use Ctrl+D at the end of your message to save the text and re-enter the normal command line mode.

The banner message is preserved if the device restarts.

The **no** variant of this command deletes the login banner from the device.

**Syntax** banner login  
no banner login

**Default** No banner is defined by default.

**Mode** Global Configuration

**Examples** To set a login banner message, use the commands:

```
awplus# configure terminal
awplus(config)# banner login
```

The screen will prompt you to enter the message:

Type CNTL/D to finish.

... banner message comes here ...

Enter the message. Use Ctrl+D to finish, like this:

```
^D
awplus(config)#
```

To remove the login banner message, use the commands:

```
awplus# configure terminal
awplus(config)# no banner login
```

**Related Commands** [show banner login](#)

# clear ssh

**Overview** This command deletes Secure Shell sessions currently active on the device. This includes both incoming and outgoing sessions. The deleted sessions are closed. You can only delete an SSH session if you are a system manager or the user who initiated the session. If **all** is specified then all active SSH sessions are deleted.

**Syntax** `clear ssh {<1-65535>|all}`

| Parameters | Description                                                                |
|------------|----------------------------------------------------------------------------|
| <1-65535>  | Specify a session ID in the range 1 to 65535 to delete a specific session. |
| all        | Delete all SSH sessions.                                                   |

**Mode** Privileged Exec

**Examples** To stop the current SSH session 123, use the command:

```
awplus# clear ssh 123
```

To stop all SSH sessions active on the device, use the command:

```
awplus# clear ssh all
```

**Related  
Commands** [service ssh](#)  
[ssh](#)

# crypto key destroy hostkey

**Overview** This command deletes the existing public and private keys of the SSH server.

When you enable the SSH server, the server automatically generates an SSHv2 host key pair (public and private keys), using RSA with 1024-bit key generation. If you need a key with different parameters than this, you can use the [crypto key generate hostkey](#) command to generate that key before you enable the SSH server.

**Syntax** `crypto key destroy hostkey {dsa|ecdsa|rsa|rsa1}`

| Parameters | Description                                                                                |
|------------|--------------------------------------------------------------------------------------------|
| dsa        | Deletes the existing DSA public and private keys.                                          |
| ecdsa      | Deletes the existing ECDSA public and private keys.                                        |
| rsa        | Deletes the existing RSA public and private keys configured for SSH version 2 connections. |
| rsa1       | Deletes the existing RSA public and private keys configured for SSH version 1 connections. |

**Mode** Global Configuration

**Example** To destroy the RSA host key used for SSH version 2 connections, use the commands:

```
awplus# configure terminal
awplus(config)# crypto key destroy hostkey rsa
```

**Related Commands** [crypto key generate hostkey](#)  
[service ssh](#)

# crypto key destroy userkey

**Overview** This command destroys the existing public and private keys of an SSH user configured on the device.

**Syntax** `crypto key destroy userkey <username> {dsa|rsa|rsa1}`

| Parameters                    | Description                                                                                                                                                                            |
|-------------------------------|----------------------------------------------------------------------------------------------------------------------------------------------------------------------------------------|
| <code>&lt;username&gt;</code> | Name of the user whose userkey you are destroying. The username must begin with a letter. Valid characters are all numbers, letters, and the underscore, hyphen and full stop symbols. |
| <code>dsa</code>              | Deletes the existing DSA userkey.                                                                                                                                                      |
| <code>rsa</code>              | Deletes the existing RSA userkey configured for SSH version 2 connections.                                                                                                             |
| <code>rsa1</code>             | Deletes the existing RSA userkey for SSH version 1 connections.                                                                                                                        |

**Mode** Global Configuration

**Example** To destroy the RSA user key for the SSH user `remoteuser`, use the commands:

```
awplus# configure terminal
awplus(config)# crypto key destroy userkey remoteuser rsa
```

**Related Commands**

- [crypto key generate hostkey](#)
- [show ssh](#)
- [show crypto key hostkey](#)



# crypto key generate hostkey

**Overview** This command generates public and private keys for the SSH server.

When you enable the SSH server, the server automatically generates an SSHv2 host key pair (public and private keys), using RSA with 1024-bit key generation.

If you need a key with different parameters than this, you can use this command to generate that key before you enable the SSH server. If a host key exists with the same cryptography algorithm, this command replaces the old host key with the new key.

This command is not saved in the device configuration. However, the device saves the keys generated by this command in the non-volatile memory.

**Syntax** `crypto key generate hostkey {dsa} [<768-1024>]`  
`crypto key generate hostkey {rsa|rsa1} [<768-32768>]`  
`crypto key generate hostkey {ecdsa} [<256|384>]`

| Parameters  | Description                                                                               |
|-------------|-------------------------------------------------------------------------------------------|
| dsa         | Creates a DSA hostkey. Both SSH version 1 and 2 connections can use the DSA hostkey.      |
| rsa         | Creates an RSA hostkey for SSH version 2 connections.                                     |
| rsa1        | Creates an RSA hostkey for SSH version 1 connections.                                     |
| ecdsa       | Creates an ECDSA hostkey. Both SSH version 1 and 2 connections can use the ECDSA hostkey. |
| <768-32768> | The length in bits of the generated key. The default is 1024 bits.                        |
| <256 384>   | The ECDSA key size in bits. The default is 256, but it can be set to 384.                 |

**Default** The default key length for RSA and DSA is 1024 bits.

The default key size for ECDSA is 256 bits.

**Mode** Global Configuration

**Examples** To generate an RSA host key for SSH version 2 connections that is 2048 bits in length, use the commands:

```
awplus# configure terminal
awplus(config)# crypto key generate hostkey rsa 2048
```

To generate a DSA host key, use the commands:

```
awplus# configure terminal
awplus(config)# crypto key generate dsa
```

To generate an ECDSA host key with an elliptic curve size of 384 bits, use the commands:

```
awplus# configure terminal
awplus(config)# crypto key generate ecdsa 384
```

**Related  
Commands**

[crypto key destroy hostkey](#)  
[service ssh](#)  
[show crypto key hostkey](#)

# crypto key generate userkey

**Overview** This command generates public and private keys for an SSH user using either an RSA or DSA cryptography algorithm. To use public key authentication, copy the public key of the user onto the remote SSH server.

This command is not saved in the device configuration. However, the device saves the keys generated by this command in the non-volatile memory.

**Syntax** `crypto key generate userkey <username> {dsa} [<768-1024>]`  
`crypto key generate userkey <username> {rsa|rsa1} [<768-32768>]`  
`crypto key generate userkey <username> {ecdsa} [<256|384>]`

| Parameters  | Description                                                                                                                                                                              |
|-------------|------------------------------------------------------------------------------------------------------------------------------------------------------------------------------------------|
| <username>  | Name of the user that the user key is generated for. The username must begin with a letter. Valid characters are all numbers, letters, and the underscore, hyphen and full stop symbols. |
| dsa         | Creates a DSA userkey. Both SSH version 1 and 2 connections can use a key created with this command.                                                                                     |
| rsa         | Creates an RSA userkey for SSH version 2 connections.                                                                                                                                    |
| rsa1        | Creates an RSA userkey for SSH version 1 connections.                                                                                                                                    |
| ecdsa       | Creates an ECDSA hostkey. Both SSH version 1 and 2 connections can use the ECDSA hostkey.                                                                                                |
| <768-32768> | The length in bits of the generated key. The default is 1024 bits.                                                                                                                       |
| <256 384>   | The ECDSA key size in bits. The default is 256, but it can be set to 384.                                                                                                                |

**Mode** Global Configuration

**Examples** To generate a 2048-bits RSA user key for SSH version 2 connections for the user "bob", use the commands:

```
awplus# configure terminal
awplus(config)# crypto key generate userkey bob rsa 2048
```

To generate a DSA user key for the user "lapo", use the commands:

```
awplus# configure terminal
awplus(config)# crypto key generate userkey lapo dsa
```

**Related Commands** [crypto key pubkey-chain userkey](#)  
[show crypto key userkey](#)

# crypto key pubkey-chain knownhosts

**Overview** This command adds a public key of the specified SSH server to the known host database on your device. The SSH client on your device uses this public key to verify the remote SSH server.

The key is retrieved from the server. Before adding a key to this database, check that the key sent to you is correct.

If the server's key changes, or if your SSH client does not have the public key of the remote SSH server, then your SSH client will inform you that the public key of the server is unknown or altered.

The **no** variant of this command deletes the public key of the specified SSH server from the known host database on your device.

**Syntax** `crypto key pubkey-chain knownhosts [ip|ipv6] <hostname> [rsa|dsa|rsa1]`  
`no crypto key pubkey-chain knownhosts <1-65535>`

**Syntax (VRF-lite)** `crypto key pubkey-chain knownhosts [vrf <vrf-name>] [ip|ipv6] <hostname> [rsa|dsa|rsa1]`  
`no crypto key pubkey-chain knownhosts [vrf <vrf-name>] <1-65535>`

| Parameter  | Description                                                                                                                                |
|------------|--------------------------------------------------------------------------------------------------------------------------------------------|
| vrf        | Apply this command to the specified VRF instance.                                                                                          |
| <vrf-name> | The VRF instance name                                                                                                                      |
| ip         | Keyword used prior to specifying an IPv4 address                                                                                           |
| ipv6       | Keyword used prior to specifying an IPv6 address                                                                                           |
| <hostname> | IPv4/IPv6 address or hostname of a remote server in the format a.b.c.d for an IPv4 address, or in the format x:x::x:x for an IPv6 address. |
| rsa        | Specify the RSA public key of the server to be added to the known host database.                                                           |
| dsa        | Specify the DSA public key of the server to be added to the known host database.                                                           |
| rsa1       | Specify the SSHv1 public key of the server to be added to the know host database.                                                          |
| <1-65535>  | Specify a key identifier when removing a key using the <b>no</b> parameter.                                                                |

**Default** If no cryptography algorithm is specified, then **rsa** is used as the default cryptography algorithm.

**Mode** Privilege Exec

**Usage** This command adds a public key of the specified SSH server to the known host database on the device. The key is retrieved from the server. The remote SSH server is verified by using this public key. The user is requested to check the key is correct before adding it to the database.

If the remote server's host key is changed, or if the device does not have the public key of the remote server, then SSH clients will inform the user that the public key of the server is altered or unknown.

**Examples** To add the RSA host key of the remote SSH host IPv4 address 192.0.2.11 to the known host database, use the command:

```
awplus# crypto key pubkey-chain knownhosts 192.0.2.11
```

To delete the second entry in the known host database, use the command:

```
awplus# no crypto key pubkey-chain knownhosts 2
```

**Examples (VRF-lite)** To add the RSA host key of the remote SSH host IPv4 address 192.0.2.11 in VRF red to the known host database, use the command:

```
awplus# crypto key pubkey-chain knownhosts vrf red 192.0.2.11
```

To delete the second entry in the known host database in VRF red, use the command:

```
awplus# no crypto key pubkey-chain knownhosts vrf red 2
```

**Validation Commands** [show crypto key pubkey-chain knownhosts](#)

**Command changes** Version 5.4.6-2.1: VRF-lite support added.

# crypto key pubkey-chain userkey

**Overview** This command adds a public key for an SSH user on the SSH server. This allows the SSH server to support public key authentication for the SSH user. When configured, the SSH user can access the SSH server without providing a password from the remote host.

The **no** variant of this command removes a public key for the specified SSH user that has been added to the public key chain. When a SSH user's public key is removed, the SSH user can no longer login using public key authentication.

**Syntax** `crypto key pubkey-chain userkey <username> [<filename>]`  
`no crypto key pubkey-chain userkey <username> <1-65535>`

| Parameters | Description                                                                                                                                                                                                              |
|------------|--------------------------------------------------------------------------------------------------------------------------------------------------------------------------------------------------------------------------|
| <username> | Name of the user that the SSH server associates the key with. The username must begin with a letter. Valid characters are all numbers, letters, and the underscore, hyphen and full stop symbols.<br>Default: no default |
| <filename> | Filename of a key saved in flash. Valid characters are any printable character. You can add a key as a hexadecimal string directly into the terminal if you do not specify a filename.                                   |
| <1-65535>  | The key ID number of the user's key. Specify the key ID to delete a key.                                                                                                                                                 |

**Mode** Global Configuration

**Usage** You should import the public key file from the client node. The device can read the data from a file on the flash or user terminal.

Or you can add a key as text into the terminal. To add a key as text into the terminal, first enter the command **crypto key pubkey-chain userkey <username>**, and hit [Enter]. Enter the key as text. Note that the key you enter as text must be a valid SSH RSA key, not random ASCII text. Use [Ctrl]+D after entering it to save the text and re-enter the normal command line mode.

Note you can generate a valid SSH RSA key on the device first using the **crypto key generate host rsa** command. View the SSH RSA key generated on the device using the **show crypto hostkey rsa** command. Copy and paste the displayed SSH RSA key after entering the **crypto key pubkey-chain userkey <username>** command. Use [Ctrl]+D after entering it to save it.

**Examples** To generate a valid SSH RSA key on the device and add the key, use the following commands:

```
awplus# configure terminal
awplus(config)# crypto key generate host rsa
awplus(config)# exit

awplus# show crypto key hostkey
rsaAAAAB3NzaC1yc2EAAAABIwAAAIEAr1s7SokW5aW2fcOw1TStpb9J20bWluhnUC768EoWhyPW6FZ2t5360O5M29EpKBmGq1kQaz5V0mU9IQe66+5YyD4UxOKSDtTI+7jtjDcoGWHb2u4sFwRpXwJZcgYrXW16+6NvNbk+h+c/pqGDijj4SvfZZfeITzvvyZW4/I4pbN8=

awplus# configure terminal
awplus(config)# crypto key pubkey-chain userkey joeType CNTRL/D
to
finish:AAAAB3NzaC1yc2EAAAABIwAAAIEAr1s7SokW5aW2fcOw1TStpb9J20bWluhnUC768EoWhyPW6FZ2t5360O5M29EpKBmGq1kQaz5V0mU9IQe66+5YyD4UxOKSDtTI+7jtjDcoGWHb2u4sFwRpXwJZcgYrXW16+6NvNbk+h+c/pqGDijj4SvfZZfeITzvvyZW4/I4pbN8=control-D

awplus(config)#
```

To add a public key for the user `graydon` from the file `key.pub`, use the commands:

```
awplus# configure terminal
awplus(config)# crypto key pubkey-chain userkey graydon key.pub
```

To add a public key for the user `tamara` from the terminal, use the commands:

```
awplus# configure terminal
awplus(config)# crypto key pubkey-chain userkey tamara
```

and enter the key. Use Ctrl+D to finish.

To remove the first key entry from the public key chain of the user `john`, use the commands:

```
awplus# configure terminal
awplus(config)# no crypto key pubkey-chain userkey john 1
```

**Related Commands** [show crypto key pubkey-chain userkey](#)

# debug ssh client

**Overview** This command enables the SSH client debugging facility. When enabled, any SSH, SCP and SFTP client sessions send diagnostic messages to the login terminal.

The **no** variant of this command disables the SSH client debugging facility. This stops the SSH client from generating diagnostic debugging message.

**Syntax** `debug ssh client [brief|full]`  
`no debug ssh client`

| Parameter | Description               |
|-----------|---------------------------|
| brief     | Enables brief debug mode. |
| full      | Enables full debug mode.  |

**Default** SSH client debugging is disabled by default.

**Mode** Privileged Exec and Global Configuration

**Examples** To start SSH client debugging, use the command:

```
awplus# debug ssh client
```

To start SSH client debugging with extended output, use the command:

```
awplus# debug ssh client full
```

To disable SSH client debugging, use the command:

```
awplus# no debug ssh client
```

**Related Commands** [debug ssh server](#)  
[show ssh client](#)  
[undebug ssh client](#)



# debug ssh server

**Overview** This command enables the SSH server debugging facility. When enabled, the SSH server sends diagnostic messages to the system log. To display the debugging messages on the terminal, use the **terminal monitor** command.

The **no** variant of this command disables the SSH server debugging facility. This stops the SSH server from generating diagnostic debugging messages.

**Syntax** `debug ssh server [brief|full]`  
`no debug ssh server`

| Parameter | Description               |
|-----------|---------------------------|
| brief     | Enables brief debug mode. |
| full      | Enables full debug mode.  |

**Default** SSH server debugging is disabled by default.

**Mode** Privileged Exec and Global Configuration

**Examples** To start SSH server debugging, use the command:

```
awplus# debug ssh server
```

To start SSH server debugging with extended output, use the command:

```
awplus# debug ssh server full
```

To disable SSH server debugging, use the command:

```
awplus# no debug ssh server
```

**Related Commands** [debug ssh client](#)  
[show ssh server](#)  
[undebug ssh server](#)

# service ssh

**Overview** This command enables the Secure Shell server on the device. Once enabled, connections coming from SSH clients are accepted.

When you enable the SSH server, the server automatically generates an SSHv2 host key pair (public and private keys), using RSA with 1024-bit key generation. If you need a key with different parameters than this, you can use the [crypto key generate hostkey](#) command to generate that key before you enable the SSH server.

The **no** variant of this command disables the Secure Shell server. When the Secure Shell server is disabled, connections from SSH, SCP, and SFTP clients are not accepted. This command does not affect existing SSH sessions. To terminate existing sessions, use the [clear ssh](#) command.

**Syntax** `service ssh [ip|ipv6]`  
`no service ssh [ip|ipv6]`

**Default** The Secure Shell server is disabled by default. Both IPv4 and IPv6 Secure Shell server are enabled when you issue **service ssh** without specifying the optional **ip** or **ipv6** parameters.

**Mode** Global Configuration

**Examples** To enable both the IPv4 and the IPv6 Secure Shell server, use the commands:

```
awplus# configure terminal
awplus(config)# service ssh
```

To enable the IPv4 Secure Shell server only, use the commands:

```
awplus# configure terminal
awplus(config)# service ssh ip
```

To enable the IPv6 Secure Shell server only, use the commands:

```
awplus# configure terminal
awplus(config)# service ssh ipv6
```

To disable both the IPv4 and the IPv6 Secure Shell server, use the commands:

```
awplus# configure terminal
awplus(config)# no service ssh
```

To disable the IPv4 Secure Shell server only, use the commands:

```
awplus# configure terminal
awplus(config)# no service ssh ip
```

To disable the IPv6 Secure Shell server only, use the commands:

```
awplus# configure terminal
awplus(config)# no service ssh ipv6
```

**Related  
Commands**

- crypto key generate hostkey
- show running-config ssh
- show ssh server
- ssh server allow-users
- ssh server deny-users

# show banner login

**Overview** This command displays the banner message configured on the device. The banner message is displayed to the remote user before user authentication starts.

**Syntax** `show banner login`

**Mode** User Exec, Privileged Exec, Global Configuration, Interface Configuration, Line Configuration

**Example** To display the current login banner message, use the command:

```
awplus# show banner login
```

**Related Commands** [banner login \(SSH\)](#)

# show crypto key hostkey

**Overview** This command displays the public keys generated on the device for the SSH server.

When you enable the SSH server, the server automatically generates an SSHv2 host key pair (public and private keys), using RSA with 1024-bit key generation. If you need a key with different parameters than this, you can use the [crypto key generate hostkey](#) command to generate that key before you enable the SSH server.

The private key remains on the device secretly. The public key is copied to SSH clients to identify the server. This command displays the public key.

**Syntax** `show crypto key hostkey [dsa|ecdsa|rsa|rsa1]`

| Parameter | Description                                                                                              |
|-----------|----------------------------------------------------------------------------------------------------------|
| dsa       | Displays the DSA algorithm public key. Both SSH version 1 and 2 connections can use the DSA hostkey      |
| ecdsa     | Displays the ECDSA algorithm public key. Both SSH version 1 and 2 connections can use the ECDSA hostkey. |
| rsa       | Displays the RSA algorithm public key for SSH version 2 connections.                                     |
| rsa1      | Displays the RSA algorithm public key for SSH version 1 connections.                                     |

**Mode** User Exec, Privileged Exec and Global Configuration

**Examples** To show the public keys generated on the device for SSH server, use the command:

```
awplus# show crypto key hostkey
```

To display the RSA public key of the SSH server, use the command:

```
awplus# show crypto key hostkey rsa
```

**Output** Figure 56-1: Example output from the **show crypto key hostkey** command

| Type | Bits | Fingerprint                                     |
|------|------|-------------------------------------------------|
| rsa  | 2058 | 4e:7d:1d:00:75:79:c5:cb:c8:58:2e:f9:29:9c:1f:48 |
| dsa  | 1024 | fa:72:3d:78:35:14:cb:9a:1d:ca:1c:83:2c:7d:08:43 |
| rsa1 | 1024 | e2:1c:c8:8b:d8:6e:19:c8:f4:ec:00:a2:71:4e:85:8b |

**Table 1:** Parameters in output of the **show crypto key hostkey** command

| Parameter   | Description                         |
|-------------|-------------------------------------|
| Type        | Algorithm used to generate the key. |
| Bits        | Length in bits of the key.          |
| Fingerprint | Checksum value for the public key.  |

**Related Commands** [crypto key destroy hostkey](#)  
[crypto key generate hostkey](#)

# show crypto key pubkey-chain knownhosts

**Overview** This command displays the list of public keys maintained in the known host database on the device.

**Syntax** `show crypto key pubkey-chain knownhosts [<1-65535>]`

**Syntax (VRF-lite)** `show crypto key pubkey-chain knownhosts [vrf <vrf-name>|global] [<1-65535>]`

| Parameter  | Description                                                                                |
|------------|--------------------------------------------------------------------------------------------|
| global     | When VRF-lite is configured, apply the command to the global routing and forwarding table. |
| vrf        | Apply the command to the specified VRF instance.                                           |
| <vrf-name> | The name of the VRF instance.                                                              |
| <1-65535>  | Key identifier for a specific key. Displays the public key of the entry if specified.      |

**Default** Display all keys.

**Mode** User Exec, Privileged Exec and Global Configuration

When VRF-lite is configured:

- If **vrf** is specified, this command displays the known host database from the specified VRF instance.
- If **global** is specified, this command displays the known host database from the global routing environment.
- If neither **vrf** nor **global** is specified, this command displays the known host database from the global routing environment and each configured VRF.

For more information about VRF, see the [VRF Lite Feature Overview and Configuration Guide](#).

**Examples** To display public keys of known SSH servers, use the command:

```
awplus# show crypto key pubkey-chain knownhosts
```

To display the key data of the first entry in the known host data, use the command:

```
awplus# show crypto key pubkey-chain knownhosts 1
```

**Output** Figure 56-2: Example output from the **show crypto key public-chain knownhosts** command

| No | Hostname                                 | Type | Fingerprint                                     |
|----|------------------------------------------|------|-------------------------------------------------|
| 1  | 172.16.23.1                              | rsa  | c8:33:b1:fe:6f:d3:8c:81:4e:f7:2a:aa:a5:be:df:18 |
| 2  | 172.16.23.10                             | rsa  | c4:79:86:65:ee:a0:1d:a5:6a:e8:fd:1d:d3:4e:37:bd |
| 3  | 5ffe:1053:ac21:ff00:0101:bcd:f:ffff:0001 | rsa1 | af:4e:b4:a2:26:24:6d:65:20:32:d9:6f:32:06:ba:57 |

**Table 2:** Parameters in the output of the **show crypto key public-chain knownhosts** command

| Parameter   | Description                             |
|-------------|-----------------------------------------|
| No          | Number ID of the key.                   |
| Hostname    | Host name of the known SSH server.      |
| Type        | The algorithm used to generate the key. |
| Fingerprint | Checksum value for the public key.      |

**Related Commands** [crypto key pubkey-chain knownhosts](#)

**Command changes** Version 5.4.6-2.1: VRF-lite support added.



# show crypto key pubkey-chain userkey

**Overview** This command displays the public keys registered with the SSH server for SSH users. These keys allow remote users to access the device using public key authentication. By using public key authentication, users can access the SSH server without providing password.

**Syntax** `show crypto key pubkey-chain userkey <username> [<1-65535>]`

| Parameter  | Description                                                                                                                                                                                          |
|------------|------------------------------------------------------------------------------------------------------------------------------------------------------------------------------------------------------|
| <username> | User name of the remote SSH user whose keys you wish to display. The username must begin with a letter. Valid characters are all numbers, letters, and the underscore, hyphen and full stop symbols. |
| <1-65535>  | Key identifier for a specific key.                                                                                                                                                                   |

**Default** Display all keys.

**Mode** User Exec, Privileged Exec and Global Configuration

**Example** To display the public keys for the user `manager` that are registered with the SSH server, use the command:

```
awplus# show crypto key pubkey-chain userkey manager
```

**Output** Figure 56-3: Example output from the **show crypto key public-chain userkey** command

| No | Type | Bits | Fingerprint                                     |
|----|------|------|-------------------------------------------------|
| 1  | dsa  | 1024 | 2b:cc:df:a8:f8:2e:8f:a4:a5:4f:32:ea:67:29:78:fd |
| 2  | rsa  | 2048 | 6a:ba:22:84:c1:26:42:57:2c:d7:85:c8:06:32:49:0e |

**Table 3:** Parameters in the output of the **show crypto key userkey** command

| Parameter   | Description                             |
|-------------|-----------------------------------------|
| No          | Number ID of the key.                   |
| Type        | The algorithm used to generate the key. |
| Bits        | Length in bits of the key.              |
| Fingerprint | Checksum value for the key.             |

**Related Commands** [crypto key pubkey-chain userkey](#)

# show crypto key userkey

**Overview** This command displays the public keys created on this device for the specified SSH user.

**Syntax** `show crypto key userkey <username> [dsa|rsa|rsa1]`

| Parameter  | Description                                                                                                                                                                                         |
|------------|-----------------------------------------------------------------------------------------------------------------------------------------------------------------------------------------------------|
| <username> | User name of the local SSH user whose keys you wish to display. The username must begin with a letter. Valid characters are all numbers, letters, and the underscore, hyphen and full stop symbols. |
| dsa        | Displays the DSA public key.                                                                                                                                                                        |
| rsa        | Displays the RSA public key used for SSH version 2 connections.                                                                                                                                     |
| rsa1       | Displays the RSA key used for SSH version 1 connections.                                                                                                                                            |

**Mode** User Exec, Privileged Exec and Global Configuration

**Examples** To show the public key generated for the user, use the command:

```
awplus# show crypto key userkey manager
```

To store the RSA public key generated for the user manager to the file "user.pub", use the command:

```
awplus# show crypto key userkey manager rsa > manager-rsa.pub
```

**Output** Figure 56-4: Example output from the **show crypto key userkey** command

| Type | Bits | Fingerprint                                     |
|------|------|-------------------------------------------------|
| rsa  | 2048 | e8:d6:1b:c0:f4:b6:e6:7d:02:2e:a9:d4:a1:ca:3b:11 |
| rsa1 | 1024 | 12:25:60:95:64:08:8e:a1:8c:3c:45:1b:44:b9:33:9b |

**Table 4:** Parameters in the output of the **show crypto key userkey** command

| Parameter   | Description                             |
|-------------|-----------------------------------------|
| Type        | The algorithm used to generate the key. |
| Bits        | Length in bits of the key.              |
| Fingerprint | Checksum value for the key.             |

**Related Commands** [crypto key generate userkey](#)

# show running-config ssh

**Overview** This command displays the current running configuration of Secure Shell (SSH).

**Syntax** `show running-config ssh`

**Mode** Privileged Exec and Global Configuration

**Example** To display the current configuration of SSH, use the command:

```
awplus# show running-config ssh
```

**Output** Figure 56-5: Example output from the **show running-config ssh** command

```
!
ssh server session-timeout 600
ssh server login-timeout 30
ssh server allow-users manager 192.168.1.*
ssh server allow-users john
ssh server deny-user john*.a-company.com
ssh server
```

**Table 5:** Parameters in the output of the **show running-config ssh** command

| Parameter                                           | Description                                                                 |
|-----------------------------------------------------|-----------------------------------------------------------------------------|
| <code>ssh server</code>                             | SSH server is enabled.                                                      |
| <code>ssh server v2</code>                          | SSH server is enabled and only support SSHv2.                               |
| <code>ssh server&lt;port&gt;</code>                 | SSH server is enabled and listening on the specified TCP port.              |
| <code>no ssh server scp</code>                      | SCP service is disabled.                                                    |
| <code>no ssh server sftp</code>                     | SFTP service is disabled.                                                   |
| <code>ssh server session-timeout</code>             | Configure the server session timeout.                                       |
| <code>ssh server login-timeout</code>               | Configure the server login timeout.                                         |
| <code>ssh server max-startups</code>                | Configure the maximum number of concurrent sessions waiting authentication. |
| <code>no ssh server authentication password</code>  | Password authentication is disabled.                                        |
| <code>no ssh server authentication publickey</code> | Public key authentication is disabled.                                      |

**Table 5:** Parameters in the output of the **show running-config ssh** command

| Parameter              | Description                                    |
|------------------------|------------------------------------------------|
| ssh server allow-users | Add the user (and hostname) to the allow list. |
| ssh server deny-users  | Add the user (and hostname) to the deny list.  |

**Related  
Commands** [service ssh](#)  
[show ssh server](#)

# show ssh

**Overview** This command displays the active SSH sessions on the device, both incoming and outgoing.

**Syntax** `show ssh`

**Mode** User Exec, Privileged Exec and Global Configuration

**Example** To display the current SSH sessions on the device, use the command:

```
awplus# show ssh
```

**Output** Figure 56-6: Example output from the **show ssh** command

```
Secure Shell Sessions:
ID Type Mode Peer Host Username State Filename

414 ssh server 172.16.23.1 root open
456 ssh client 172.16.23.10 manager user-auth
459 scp client 172.16.23.12 root download 550dev_.awd
463 ssh client 5ffe:33fe:5632:ffbb:bc35:ddee:0101:ac51
 manager user-auth
```

**Table 6:** Parameters in the output of the **show ssh** command

| Parameter | Description                                                                                              |
|-----------|----------------------------------------------------------------------------------------------------------|
| ID        | Unique identifier for each SSH session.                                                                  |
| Type      | Session type; either SSH, SCP, or SFTP.                                                                  |
| Mode      | Whether the device is acting as an SSH client (client) or SSH server (server) for the specified session. |
| Peer Host | The hostname or IP address of the remote server or client.                                               |
| Username  | Login user name of the server.                                                                           |

**Table 6:** Parameters in the output of the **show ssh** command (cont.)

| Parameter | Description                                                           |                                                 |
|-----------|-----------------------------------------------------------------------|-------------------------------------------------|
| State     | The current state of the SSH session. One of:                         |                                                 |
|           | connecting                                                            | The device is looking for a remote server.      |
|           | connected                                                             | The device is connected to the remote server.   |
|           | accepted                                                              | The device has accepted a new session.          |
|           | host-auth                                                             | host-to-host authentication is in progress.     |
|           | user-auth                                                             | User authentication is in progress.             |
|           | authenticated                                                         | User authentication is complete.                |
|           | open                                                                  | The session is in progress.                     |
|           | download                                                              | The user is downloading a file from the device. |
|           | upload                                                                | The user is uploading a file from the device.   |
|           | closing                                                               | The user is terminating the session.            |
|           | closed                                                                | The session is closed.                          |
| Filename  | Local filename of the file that the user is downloading or uploading. |                                                 |

**Related Commands** [clear ssh](#)

# show ssh client

**Overview** This command displays the current configuration of the Secure Shell client.

**Syntax** `show ssh client`

**Mode** User Exec, Privileged Exec and Global Configuration

**Example** To display the current configuration for SSH clients on the login shell, use the command:

```
awplus# show ssh client
```

**Output** Figure 56-7: Example output from the **show ssh client** command

```
Secure Shell Client Configuration

Port : 22
Version : 2,1
Connect Timeout : 30 seconds
Session Timeout : 0 (off)
Debug : NONE
```

**Table 7:** Parameters in the output of the **show ssh client** command

| Parameter       | Description                                                                                                                                                 |
|-----------------|-------------------------------------------------------------------------------------------------------------------------------------------------------------|
| Port            | SSH server TCP port where the SSH client connects to. The default is port 22.                                                                               |
| Version         | SSH server version; either "1", "2" or "2,1".                                                                                                               |
| Connect Timeout | Time in seconds that the SSH client waits for an SSH session to establish. If the value is 0, the connection is terminated when it reaches the TCP timeout. |
| Debug           | Whether debugging is active on the client.                                                                                                                  |

**Related Commands** [show ssh server](#)

# show ssh server

**Overview** This command displays the current configuration of the Secure Shell server.

Note that changes to the SSH configuration affects only new SSH sessions coming from remote hosts, and does not affect existing sessions.

**Syntax** `show ssh server`

**Mode** User Exec, Privileged Exec and Global Configuration

**Example** To display the current configuration of the Secure Shell server, use the command:

```
awplus# show ssh server
```

**Output** Figure 56-8: Example output from the **show ssh server** command

```
Secure Shell Server Configuration

SSH Server : Enabled
Port : 22
Version : 2
Services : scp, sftp
User Authentication : publickey, password
Resolve Hosts : Disabled
Session Timeout : 0 (Off)
Login Timeout : 60 seconds
Maximum Authentication Tries : 6
Maximum Startups : 10
Debug : NONE
```

**Table 8:** Parameters in the output of the **show ssh server** command

| Parameter      | Description                                                                                                                                                    |
|----------------|----------------------------------------------------------------------------------------------------------------------------------------------------------------|
| SSH Server     | Whether the Secure Shell server is enabled or disabled.                                                                                                        |
| Port           | TCP port where the Secure Shell server listens for connections. The default is port 22.                                                                        |
| Version        | SSH server version; either "1", "2" or "2,1".                                                                                                                  |
| Services       | List of the available Secure Shell service; one or more of SHELL, SCP or SFTP.                                                                                 |
| Authentication | List of available authentication methods.                                                                                                                      |
| Login Timeout  | Time (in seconds) that the SSH server will wait the SSH session to establish. If the value is 0, the client login will be terminated when TCP timeout reaches. |



**Table 8:** Parameters in the output of the **show ssh server** command (cont.)

| Parameter        | Description                                                                                                                                                                          |
|------------------|--------------------------------------------------------------------------------------------------------------------------------------------------------------------------------------|
| Idle Timeout     | Time (in seconds) that the SSH server will wait to receive data from the SSH client. The server disconnects if this timer limit is reached. If set at 0, the idle timer remains off. |
| Maximum Startups | The maximum number of concurrent connections that are waiting authentication. The default is 10.                                                                                     |
| Debug            | Whether debugging is active on the server.                                                                                                                                           |

**Related  
Commands** [show ssh](#)  
[show ssh client](#)

# show ssh server allow-users

**Overview** This command displays the user entries in the allow list of the SSH server.

**Syntax** `show ssh server allow-users`

**Mode** User Exec, Privileged Exec and Global Configuration

**Example** To display the user entries in the allow list of the SSH server, use the command:

```
awplus# show ssh server allow-users
```

**Output** Figure 56-9: Example output from the **show ssh server allow-users** command

| Username | Remote Hostname (pattern) |
|----------|---------------------------|
| awplus   | 192.168.*                 |
| john     |                           |
| manager  | *.alliedtelesis.com       |

**Table 9:** Parameters in the output of the **show ssh server allow-users** command

| Parameter                 | Description                                                                                                                                                                               |
|---------------------------|-------------------------------------------------------------------------------------------------------------------------------------------------------------------------------------------|
| Username                  | User name that is allowed to access the SSH server.                                                                                                                                       |
| Remote Hostname (pattern) | IP address or hostname pattern of the remote client. The user is allowed requests from a host that matches this pattern. If no hostname is specified, the user is allowed from all hosts. |

**Related Commands** [ssh server allow-users](#)  
[ssh server deny-users](#)

# show ssh server deny-users

**Overview** This command displays the user entries in the deny list of the SSH server. The user in the deny list is rejected to access the SSH server. If a user is not included in the access list of the SSH server, the user is also rejected.

**Syntax** `show ssh server deny-users`

**Mode** User Exec, Privileged Exec and Global Configuration

**Example** To display the user entries in the deny list of the SSH server, use the command:

```
awplus# show ssh server deny-users
```

**Output** Figure 56-10: Example output from the **show ssh server deny-users** command

| Username | Remote Hostname (pattern) |
|----------|---------------------------|
| john     | *.b-company.com           |
| manager  | 192.168.2.*               |

**Table 10:** Parameters in the output of the **show ssh server deny-user** command

| Parameter                 | Description                                                                                                                                                                             |
|---------------------------|-----------------------------------------------------------------------------------------------------------------------------------------------------------------------------------------|
| Username                  | The user that this rule applies to.                                                                                                                                                     |
| Remote Hostname (pattern) | IP address or hostname pattern of the remote client. The user is denied requests from a host that matches this pattern. If no hostname is specified, the user is denied from all hosts. |

**Related Commands** [ssh server allow-users](#)  
[ssh server deny-users](#)

# ssh

**Overview** This command initiates a Secure Shell connection to a remote SSH server.

If the server requests a password for the user login, the user needs to type in the correct password on "Password:" prompt.

SSH client identifies the remote SSH server by its public key registered on the client device. If the server identification is changed, server verification fails. If the public key of the server has been changed, the public key of the server must be explicitly added to the known host database.

**NOTE:** Note that a hostname specified with SSH cannot begin with a hyphen (-) character.

**Syntax** `ssh [ip|ipv6][[user <username>]|[port <1-65535>]|[version {1|2}]] <hostname> [<line>]`

**Syntax (VRF-lite)** `ssh [vrf <vrf-name>] [ip|ipv6][[user <username>]|[port <1-65535>]|[version {1|2}]] <hostname> [<line>]`

| Parameter  | Description                                                                                                                                                                                                                                                                                                               |
|------------|---------------------------------------------------------------------------------------------------------------------------------------------------------------------------------------------------------------------------------------------------------------------------------------------------------------------------|
| vrf        | Apply the command to the specified VRF instance.                                                                                                                                                                                                                                                                          |
| <vrf-name> | The name of the VRF instance.                                                                                                                                                                                                                                                                                             |
| ip         | Specify IPv4 SSH.                                                                                                                                                                                                                                                                                                         |
| ipv6       | Specify IPv6 SSH.                                                                                                                                                                                                                                                                                                         |
| user       | Login user. If user is specified, the username is used for login to the remote SSH server when user authentication is required. Otherwise the current user name is used.<br><br><username> User name to login on the remote server.                                                                                       |
| port       | SSH server port. If port is specified, the SSH client connects to the remote SSH server with the specified TCP port. Other- wise, the client port configured by "ssh client" command or the default TCP port (22) is used.<br><br><1-65535> TCP port.                                                                     |
| version    | SSH client version. If version is specified, the SSH client supports only the specified SSH version. By default, SSH client uses SSHv2 first. If the server does not support SSHv2, it will try SSHv1. The default version can be configured by "ssh client" command.<br><br>1 Use SSH version 1.<br>2 Use SSH version 2. |

| Parameter                     | Description                                                                                                                                                                                                                                  |
|-------------------------------|----------------------------------------------------------------------------------------------------------------------------------------------------------------------------------------------------------------------------------------------|
| <code>&lt;hostname&gt;</code> | IPv4/IPv6 address or hostname of a remote server. The address is in the format A.B.C.D for an IPv4 address, or in the format X:X::X:X for an IPv6 address. Note that a hostname specified with SSH cannot begin with a hyphen (-) character. |
| <code>&lt;line&gt;</code>     | A command to execute on the remote server. If a command is specified, the command is executed on the remote SSH server and the session is disconnected when the remote command finishes.                                                     |

**Mode** User Exec and Privileged Exec

**Examples** To login to the remote SSH server at 192.0.2.5, use the command:

```
awplus# ssh ip 192.0.2.5
```

To login to the remote SSH server at 192.0.2.5 as user "manager", use the command:

```
awplus# ssh ip user manager 192.0.2.5
```

To login to the remote SSH server at 192.0.2.5 that is listening TCP port 2000, use the command:

```
awplus# ssh port 2000 192.0.2.5
```

To login to the remote SSH server with example\_host using IPv6 session, use the command:

```
awplus# ssh ipv6 example_host
```

To run the **cmd** command on the remote SSH server at 192.0.2.5, use the command:

```
awplus# ssh ip 192.0.2.5 cmd
```

**Example (VRF-lite)** To login to the remote SSH server at 192.168.1.1 on VRF "red", use the command:

```
awplus# ssh vrf red 192.168.1.1
```

**Related Commands**

- [crypto key generate userkey](#)
- [crypto key pubkey-chain knownhosts](#)
- [debug ssh client](#)
- [ssh client](#)

**Command changes** Version 5.4.6-2.1: VRF-lite support added.

# ssh client

**Overview** This command modifies the default configuration parameters of the Secure Shell (SSH) client. The configuration is used for any SSH client on the device to connect to remote SSH servers. Any parameters specified on SSH client explicitly override the default configuration parameters.

The change affects the current user shell only. When the user exits the login session, the configuration does not persist. This command does not affect existing SSH sessions.

The **no** variant of this command resets configuration parameters of the Secure Shell (SSH) client changed by the `ssh client` command, and restores the defaults.

This command does not affect the existing SSH sessions.

**Syntax**

```
ssh client {port <1-65535>|version {1|2}|session-timeout <0-3600>|connect-timeout <1-600>}
no ssh client {port|version|session-timeout|connect-timeout}
```

| Parameter       | Description                                                                                                                                                                                                                                                                                                                                                     |
|-----------------|-----------------------------------------------------------------------------------------------------------------------------------------------------------------------------------------------------------------------------------------------------------------------------------------------------------------------------------------------------------------|
| port            | The default TCP port of the remote SSH server. If an SSH client specifies an explicit port of the server, it overrides the default TCP port.<br>Default: 22                                                                                                                                                                                                     |
|                 | <1-65535> TCP port number.                                                                                                                                                                                                                                                                                                                                      |
| version         | The SSH version used by the client for SSH sessions. The SSH client supports both version 2 and version 1<br>Default: version 2<br>Note: SSH version 2 is the default SSH version. SSH client supports SSH version 1 if SSH version 2 is not configured using a ssh version command.                                                                            |
|                 | 1 SSH clients on the device supports SSH version 1 only.                                                                                                                                                                                                                                                                                                        |
|                 | 2 SSH clients on the device supports SSH version 2 only                                                                                                                                                                                                                                                                                                         |
| session-timeout | The global session timeout for SSH sessions. If the session timer lapses since the last time an SSH client received data from the remote server, the session is terminated. If the value is 0, then the client does not terminate the session. Instead, the connection is terminated when it reaches the TCP timeout.<br>Default: 0 (session timer remains off) |
|                 | <0-3600> Timeout in seconds.                                                                                                                                                                                                                                                                                                                                    |

| Parameter       | Description                                                                                                                                                                                            |
|-----------------|--------------------------------------------------------------------------------------------------------------------------------------------------------------------------------------------------------|
| connect-timeout | The maximum time period that an SSH session can take to become established. The SSH client terminates the SSH session if this timeout expires and the session is still not established.<br>Default: 30 |
|                 | <1-600> Timeout in seconds.                                                                                                                                                                            |

**Mode** Privileged Exec

**Examples** To configure the default TCP port for SSH clients to 2200, and the session timer to 10 minutes, use the command:

```
awplus# ssh client port 2200 session-timeout 600
```

To configure the connect timeout of SSH client to 10 seconds, use the command:

```
awplus# ssh client connect-timeout 10
```

To restore the connect timeout to its default, use the command:

```
awplus# no ssh client connect-timeout
```

**Related Commands** [show ssh client](#)  
[ssh](#)

# ssh server

**Overview** This command modifies the configuration of the SSH server. Changing these parameters affects new SSH sessions connecting to the device.

The **no** variant of this command restores the configuration of a specified parameter to its default. The change affects the SSH server immediately if the server is running. Otherwise, the configuration is used when the server starts.

To enable the SSH server, use the [service ssh](#) command.

**Syntax**

```
ssh server {[v1v2|v2only]|<1-65535>}
ssh server {[session-timeout <0-3600>} [login-timeout <1-600>]
[max-startups <1-128>]}
no ssh server {[session-timeout] [login-timeout]
[max-startups]}
```

| Parameter       | Description                                                                                                                                                                                                                                                                                                                    |
|-----------------|--------------------------------------------------------------------------------------------------------------------------------------------------------------------------------------------------------------------------------------------------------------------------------------------------------------------------------|
| v1v2            | Supports both SSHv2 and SSHv1 client connections.<br>Default: v1v2                                                                                                                                                                                                                                                             |
| v2only          | Supports SSHv2 client connections only.                                                                                                                                                                                                                                                                                        |
| <1-65535>       | The TCP port number that the server listens to for incoming SSH sessions.<br>Default: 22                                                                                                                                                                                                                                       |
| session-timeout | There is a maximum time period that the server waits before deciding that a session is inactive and should be terminated. The server considers the session inactive when it has not received any data from the client, and when the client does not respond to keep alive messages.<br>Default: 0 (session timer remains off). |
|                 | <0-3600> Timeout in seconds.                                                                                                                                                                                                                                                                                                   |
| login-timeout   | The maximum time period the server waits before disconnecting an unauthenticated client.<br>Default: 60                                                                                                                                                                                                                        |
|                 | <1-600> Timeout in seconds.                                                                                                                                                                                                                                                                                                    |
| max-startups    | The maximum number of concurrent unauthenticated connections the server accepts. When the number of SSH connections awaiting authentication reaches the limit, the server drops any additional connections until authentication succeeds or the login timer expires for a connection.<br>Default: 10                           |
|                 | <1-128> Number of sessions.                                                                                                                                                                                                                                                                                                    |

**Mode** Global Configuration



**Examples** To configure the session timer of SSH server to 10 minutes (600 seconds), use the commands:

```
awplus# configure terminal
awplus(config)# ssh server login-timeout 600
```

To configure the login timeout of SSH server to 30 seconds, use the commands:

```
awplus# configure terminal
awplus(config)# ssh server login-timeout 30
```

To limit the number of SSH client connections waiting authentication from SSH server to 3, use the commands:

```
awplus# configure terminal
awplus(config)# ssh server max-startups
```

To set max-startups parameters of SSH server to the default configuration, use the commands:

```
awplus# configure terminal
awplus(config)# no ssh server max-startups
```

To support the Secure Shell server with TCP port 2200, use the commands:

```
awplus# configure terminal
awplus(config)# ssh server 2200
```

To force the Secure Shell server to support SSHv2 only, use the commands:

```
awplus# configure terminal
awplus(config)# ssh server v2only
```

To support both SSHv2 and SSHv1, use the commands:

```
awplus# configure terminal
awplus(config)# ssh server v1v2
```

**Related  
Commands** [show ssh server](#)  
[ssh client](#)

# ssh server allow-users

**Overview** This command adds a username pattern to the allow list of the SSH server. If the user of an incoming SSH session matches the pattern, the session is accepted.

When there are no registered users in the server's database of allowed users, the SSH server does not accept SSH sessions even when enabled.

SSH server also maintains the deny list. The server checks the user in the deny list first. If a user is listed in the deny list, then the user access is denied even if the user is listed in the allow list.

The **no** variant of this command deletes a username pattern from the allow list of the SSH server. To delete an entry from the allow list, the username and hostname pattern should match exactly with the existing entry.

**Syntax** `ssh server allow-users <username-pattern> [<hostname-pattern>]`  
`no ssh server allow-users <username-pattern>`  
 `[<hostname-pattern>]`

| Parameter                             | Description                                                                                                                                                                                                              |
|---------------------------------------|--------------------------------------------------------------------------------------------------------------------------------------------------------------------------------------------------------------------------|
| <code>&lt;username-pattern&gt;</code> | The username pattern that users can match to. An asterisk acts as a wildcard character that matches any string of characters.                                                                                            |
| <code>&lt;hostname-pattern&gt;</code> | The host name pattern that hosts can match to. If specified, the server allows the user to connect only from hosts matching the pattern. An asterisk acts as a wildcard character that matches any string of characters. |

**Mode** Global Configuration

**Examples** To allow the user `john` to create an SSH session from any host, use the commands:

```
awplus# configure terminal
awplus(config)# ssh server allow-users john
```

To allow the user `john` to create an SSH session from a range of IP address (from 192.168.1.1 to 192.168.1.255), use the commands:

```
awplus# configure terminal
awplus(config)# ssh server allow-users john 192.168.1.*
```

To allow the user `john` to create a SSH session from `a-company.com` domain, use the commands:

```
awplus# configure terminal
awplus(config)# ssh server allow-users john *.a-company.com
```

To delete the existing user entry `john 192.168.1.*` in the allow list, use the commands:

```
awplus# configure terminal
```

```
awplus(config)# no ssh server allow-users john 192.168.1.*
```

**Related  
Commands**

[show running-config ssh](#)

[show ssh server allow-users](#)

[ssh server deny-users](#)

# ssh server authentication

**Overview** This command enables RSA public-key or password user authentication for SSH Server. Apply the **password** keyword with the **ssh server authentication** command to enable password authentication for users. Apply the **publickey** keyword with the **ssh server authentication** command to enable RSA public-key authentication for users.

Use the **no** variant of this command to disable RSA public-key or password user authentication for SSH Server. Apply the **password** keyword with the **no ssh authentication** command to disable password authentication for users. Apply the required **publickey** keyword with the **no ssh authentication** command to disable RSA public-key authentication for users.

**Syntax** `ssh server authentication {password|publickey}`  
`no ssh server authentication {password|publickey}`

| Parameter              | Description                                             |
|------------------------|---------------------------------------------------------|
| <code>password</code>  | Specifies user password authentication for SSH server.  |
| <code>publickey</code> | Specifies user publickey authentication for SSH server. |

**Default** Both RSA public-key authentication and password authentication are enabled by default.

**Mode** Global Configuration

**Usage** For password authentication to authenticate a user, password authentication for a user must be registered in the local user database or on an external RADIUS server, before using the **ssh server authentication password** command.

For RSA public-key authentication to authenticate a user, a public key must be added for the user, before using the **ssh server authentication publickey** command.

**Examples** To enable `password` authentication for users connecting through SSH, use the commands:

```
awplus# configure terminal
awplus(config)# ssh server authentication password
```

To enable `publickey` authentication for users connecting through SSH, use the commands:

```
awplus# configure terminal
awplus(config)# ssh server authentication publickey
```

To disable `password` authentication for users connecting through SSH, use the commands:

```
awplus# configure terminal
awplus(config)# no ssh server authentication password
```

To disable `publickey` authentication for users connecting through SSH, use the commands:

```
awplus# configure terminal
awplus(config)# no ssh server authentication publickey
```

**Related  
Commands**

[crypto key pubkey-chain userkey](#)  
[service ssh](#)  
[show ssh server](#)

# ssh server deny-users

**Overview** This command adds a username pattern to the deny list of the SSH server. If the user of an incoming SSH session matches the pattern, the session is rejected.

SSH server also maintains the allow list. The server checks the user in the deny list first. If a user is listed in the deny list, then the user access is denied even if the user is listed in the allow list.

If a hostname pattern is specified, the user is denied from the hosts matching the pattern.

The **no** variant of this command deletes a username pattern from the deny list of the SSH server. To delete an entry from the deny list, the username and hostname pattern should match exactly with the existing entry.

**Syntax** `ssh server deny-users <username-pattern> [<hostname-pattern>]`  
`no ssh server deny-users <username-pattern>`  
 `[<hostname-pattern>]`

| Parameter                             | Description                                                                                                                                                                                                                                                                 |
|---------------------------------------|-----------------------------------------------------------------------------------------------------------------------------------------------------------------------------------------------------------------------------------------------------------------------------|
| <code>&lt;username-pattern&gt;</code> | The username pattern that users can match to. The username must begin with a letter. Valid characters are all numbers, letters, and the underscore, hyphen, full stop and asterisk symbols. An asterisk acts as a wildcard character that matches any string of characters. |
| <code>&lt;hostname-pattern&gt;</code> | The host name pattern that hosts can match to. If specified, the server denies the user only when they connect from hosts matching the pattern. An asterisk acts as a wildcard character that matches any string of characters.                                             |

**Mode** Global Configuration

**Examples** To deny the user john to access SSH login from any host, use the commands:

```
awplus# configure terminal
awplus(config)# ssh server deny-users john
```

To deny the user john to access SSH login from a range of IP address (from 192.168.2.1 to 192.168.2.255), use the commands:

```
awplus# configure terminal
awplus(config)# ssh server deny-users john 192.168.2.*
```

To deny the user john to access SSH login from b-company.com domain, use the commands:

```
awplus# configure terminal
awplus(config)# ssh server deny-users john*.b-company.com
```

To delete the existing user entry `john 192.168.2.*` in the deny list, use the commands:

```
awplus# configure terminal
```

```
awplus(config)# no ssh server deny-users john 192.168.2.*
```

**Related  
Commands**

[show running-config ssh](#)

[show ssh server deny-users](#)

[ssh server allow-users](#)

# ssh server max-auth-tries

**Overview** Use this command to specify the maximum number of SSH authentication attempts that the device will allow.

Use the **no** variant of this command to return the maximum number of attempts to its default value of 6.

**Syntax** `ssh server max-auth-tries <1-32>`  
`no ssh server max-auth-tries`

| Parameter | Description                                                          |
|-----------|----------------------------------------------------------------------|
| <1-32>    | Maximum number of SSH authentication attempts the device will allow. |

**Default** 6 attempts

**Mode** Global Configuration

**Usage** By default, users must wait one second after a failed login attempt before trying again. You can increase this gap by using the command [aaa login fail-delay](#).

**Example** To set the maximum number of SSH authentication attempts to 3, use the commands:

```
awplus# configure terminal
awplus(config)# ssh server max-auth-tries 3
```

**Related Commands** [show ssh server](#)



# ssh server resolve-host

**Overview** This command enables resolving an IP address from a host name using a DNS server for client host authentication.

The **no** variant of this command disables this feature.

**Syntax** `ssh server resolve-hosts`  
`no ssh server resolve-hosts`

**Default** This feature is disabled by default.

**Mode** Global Configuration

**Usage** Your device has a DNS Client that is enabled automatically when you add a DNS server to your device. Use the [ip name-server](#) command to add a DNS server to the list of servers that the device queries.

**Example** To resolve a host name using a DNS server, use the commands:

```
awplus# configure terminal
awplus(config)# ssh server resolve-hosts
```

**Related Commands**

- [ip name-server](#)
- [show ssh server](#)
- [ssh server allow-users](#)
- [ssh server deny-users](#)

# ssh server scp

**Overview** This command enables the Secure Copy (SCP) service on the SSH server. Once enabled, the server accepts SCP requests from remote clients.

You must enable the SSH server as well as this service before the device accepts SCP connections. The SCP service is enabled by default as soon as the SSH server is enabled.

The **no** variant of this command disables the SCP service on the SSH server. Once disabled, SCP requests from remote clients are rejected.

**Syntax** `ssh server scp`  
`no ssh server scp`

**Mode** Global Configuration

**Examples** To enable the SCP service, use the commands:

```
awplus# configure terminal
awplus(config)# ssh server scp
```

To disable the SCP service, use the commands:

```
awplus# configure terminal
awplus(config)# no ssh server scp
```

**Related  
Commands** [show running-config ssh](#)  
[show ssh server](#)

# ssh server sftp

**Overview** This command enables the Secure FTP (SFTP) service on the SSH server. Once enabled, the server accepts SFTP requests from remote clients.

You must enable the SSH server as well as this service before the device accepts SFTP connections. The SFTP service is enabled by default as soon as the SSH server is enabled. If the SSH server is disabled, SFTP service is unavailable.

The **no** variant of this command disables SFTP service on the SSH server. Once disabled, SFTP requests from remote clients are rejected.

**Syntax** `ssh server sftp`  
`no ssh server sftp`

**Mode** Global Configuration

**Examples** To enable the SFTP service, use the commands:

```
awplus# configure terminal
awplus(config)# ssh server sftp
```

To disable the SFTP service, use the commands:

```
awplus# configure terminal
awplus(config)# no ssh server sftp
```

**Related Commands** [show running-config ssh](#)  
[show ssh server](#)

# undebug ssh client

**Overview** This command applies the functionality of the **no debug ssh client** command.

# undebug ssh server

**Overview** This command applies the functionality of the **no debug ssh server** command.

# 57

# Trigger Commands

## Introduction

**Overview** This chapter provides an alphabetical reference for commands used to configure Triggers. For more information, see the [Triggers Feature Overview and Configuration Guide](#).

For information on filtering and saving command output, see the [“Getting Started with AlliedWare Plus” Feature Overview and Configuration Guide](#).

- Command List**
- [“active \(trigger\)”](#) on page 2568
  - [“day”](#) on page 2569
  - [“debug trigger”](#) on page 2571
  - [“description \(trigger\)”](#) on page 2572
  - [“repeat”](#) on page 2573
  - [“script”](#) on page 2574
  - [“show debugging trigger”](#) on page 2576
  - [“show running-config trigger”](#) on page 2577
  - [“show trigger”](#) on page 2578
  - [“test”](#) on page 2583
  - [“time \(trigger\)”](#) on page 2584
  - [“trap”](#) on page 2586
  - [“trigger”](#) on page 2587
  - [“trigger activate”](#) on page 2588
  - [“type atmf node”](#) on page 2589
  - [“type card”](#) on page 2592
  - [“type cpu”](#) on page 2593
  - [“type interface”](#) on page 2594

- [“type memory”](#) on page 2595
- [“type periodic”](#) on page 2596
- [“type ping-poll”](#) on page 2597
- [“type reboot”](#) on page 2598
- [“type time”](#) on page 2599
- [“type usb”](#) on page 2600
- [“undebbug trigger”](#) on page 2601

# active (trigger)

**Overview** This command enables a trigger. This allows the trigger to activate when its trigger conditions are met.

The **no** variant of this command disables a trigger. While in this state the trigger cannot activate when its trigger conditions are met.

**Syntax** active  
no active

**Mode** Trigger Configuration

**Usage** Configure a trigger first before you use this command to activate it.  
For information about configuring a trigger, see the [Triggers Feature Overview and Configuration Guide](#).

**Examples** To enable trigger 172, so that it can activate when its trigger conditions are met, use the commands:

```
awplus# configure terminal
awplus(config)# trigger 172
awplus(config-trigger)# active
```

To disable trigger 182, preventing it from activating when its trigger conditions are met, use the commands:

```
awplus# configure terminal
awplus(config)# trigger 182
awplus(config-trigger)# no active
```

**Related Commands** [show trigger](#)  
[trigger](#)



# day

**Overview** This command specifies the days or date that the trigger can activate on. You can specify one of:

- A specific date
- A specific day of the week
- A list of days of the week
- every day

By default, the trigger can activate on any day.

**Syntax** `day every-day`  
`day <1-31> <month> <2000-2035>`  
`day <weekday>`

| Parameter                      | Description                                                                                                                                                                                                                 |
|--------------------------------|-----------------------------------------------------------------------------------------------------------------------------------------------------------------------------------------------------------------------------|
| <code>every-day</code>         | Sets the trigger so that it can activate on any day.                                                                                                                                                                        |
| <code>&lt;1-31&gt;</code>      | Day of the month the trigger is permitted to activate on.                                                                                                                                                                   |
| <code>&lt;month&gt;</code>     | Sets the month that the trigger is permitted to activate on. Valid keywords are: <b>january, february, march, april, may, june, july, august, september, october, november, and december.</b>                               |
| <code>&lt;2000-2035&gt;</code> | Sets the year that the trigger is permitted to activate in.                                                                                                                                                                 |
| <code>&lt;weekday&gt;</code>   | Sets the days of the week that the trigger can activate on. You can specify one or more week days in a space separated list. Valid keywords are: <b>monday, tuesday, wednesday, thursday, friday, saturday, and sunday.</b> |

**Default** **every-day**, so by default, the trigger can activate on any day.

**Mode** Trigger Configuration

**Usage** For example trigger configurations that use the **day** command, see “Restrict Internet Access” and “Turn off Power to Port LEDs” in the [Triggers Feature Overview and Configuration Guide](#).

**Examples** To permit trigger 55 to activate on the 1 October 2016, use the commands:

```
awplus# configure terminal
awplus(config)# trigger 55
awplus(config-trigger)# day 1 oct 2016
```

To permit trigger 12 to activate on a Mondays, Wednesdays and Fridays, use the commands:

```
awplus# configure terminal
awplus(config)# trigger 12
awplus(config-trigger)# day monday wednesday friday
```

**Related  
Commands** [show trigger](#)  
[trigger](#)

# debug trigger

**Overview** This command enables trigger debugging. This generates detailed messages about how your device is processing the trigger commands and activating the triggers.

The **no** variant of this command disables trigger debugging.

**Syntax** `debug trigger`  
`no debug trigger`

**Mode** Privilege Exec

**Examples** To start trigger debugging, use the command:

```
awplus# debug trigger
```

To stop trigger debugging, use the command:

```
awplus# no trigger
```

**Related Commands** [show debugging trigger](#)  
[show trigger](#)  
[test](#)  
[trigger](#)  
[undebug trigger](#)

# description (trigger)

**Overview** This command adds an optional description to help you identify the trigger. This description is displayed in show command outputs and log messages.

The **no** variant of this command removes a trigger's description. The show command outputs and log messages stop displaying a description for this trigger.

**Syntax** `description <description>`  
`no description`

| Parameter                        | Description                                                                                                                                                       |
|----------------------------------|-------------------------------------------------------------------------------------------------------------------------------------------------------------------|
| <code>&lt;description&gt;</code> | A word or phrase that uniquely identifies this trigger or its purpose. Valid characters are any printable character and spaces, up to a maximum of 40 characters. |

**Mode** Trigger Configuration

**Examples** To give trigger 240 the description `daily status report`, use the commands:

```
awplus# configure terminal
awplus(config)# trigger 240
awplus(config-trigger)# description daily status report
```

To remove the description from trigger 36, use the commands:

```
awplus# configure terminal
awplus(config)# trigger 36
awplus(config-trigger)# no description
```

**Related Commands** [show trigger](#)  
[test](#)  
[trigger](#)

# repeat

**Overview** This command specifies the number of times that a trigger is permitted to activate. This allows you to specify whether you want the trigger to activate:

- only the first time that the trigger conditions are met
- a limited number of times that the trigger conditions are met
- an unlimited number of times

Once the trigger has reached the limit set with this command, the trigger remains in your configuration but cannot be activated. Use the **repeat** command again to reset the trigger so that it is activated when its trigger conditions are met.

By default, triggers can activate an unlimited number of times. To reset a trigger to this default, specify either **yes** or **forever**.

**Syntax** `repeat { forever | no | once | yes | <1-4294967294> }`

| Parameter                         | Description                                          |
|-----------------------------------|------------------------------------------------------|
| <code>yes   forever</code>        | The trigger repeats indefinitely, or until disabled. |
| <code>no   once</code>            | The trigger activates only once.                     |
| <code>&lt;1-4292967294&gt;</code> | The trigger repeats the specified number of times.   |

**Mode** Trigger Configuration

**Examples** To allow trigger 21 to activate only once, use the commands:

```
awplus# configure terminal
awplus(config)# trigger 21
awplus(config-trigger)# repeat no
```

To allow trigger 22 to activate an unlimited number of times whenever its trigger conditions are met, use the commands:

```
awplus# configure terminal
awplus(config)# trigger 22
awplus(config-trigger)# repeat forever
```

To allow trigger 23 to activate only the first 10 times the conditions are met, use the commands:

```
awplus# configure terminal
awplus(config)# trigger 23
awplus(config-trigger)# repeat 10
```

**Related Commands** [show trigger](#)  
[trigger](#)

# script

**Overview** This command specifies one or more scripts that are to be run when the trigger activates. You can add up to five scripts to a single trigger.

The sequence in which the trigger runs the scripts is specified by the number you set before the name of the script file. One script is executed completely before the next script begins.

Scripts may be either ASH shell scripts, indicated by a **.sh** filename extension suffix, or AlliedWare Plus™ scripts, indicated by a **.scp** filename extension suffix. AlliedWare Plus™ scripts only need to be readable.

The **no** variant of this command removes one or more scripts from the trigger's script list. The scripts are identified by either their name, or by specifying their position in the script list. The **all** parameter removes all scripts from the trigger.

**Syntax**

```
script <1-5> {<filename>}
no script {<1-5>|<filename>|all}
```

| Parameter  | Description                                                                                          |
|------------|------------------------------------------------------------------------------------------------------|
| <1-5>      | The position of the script in execution sequence. The trigger runs the lowest numbered script first. |
| <filename> | The path to the script file.                                                                         |

**Mode** Trigger Configuration

**Examples** To configure trigger 71 to run the script `flash:/cpu_trig.sh` in position 3 when the trigger activates, use the commands:

```
awplus# configure terminal
awplus(config)# trigger 71
awplus(config-trigger)# script 3 flash:/cpu_trig.sh
```

To configure trigger 99 to run the scripts **flash:reconfig.scp**, **flash:cpu\_trig.sh** and **flash:email.scp** in positions 2, 3 and 5 when the trigger activates, use the following commands:

```
awplus# configure terminal
awplus(config)# trigger 99
awplus(config-trigger)# script 2 flash:/reconfig.scp 3
flash:/cpu_trig.sh 5 flash:/email.scp
```

To remove the scripts 1, 3 and 4 from trigger 71's script list, use the commands:

```
awplus# configure terminal
awplus(config)# trigger 71
awplus(config-trigger)# no script 1 3 4
```

To remove the script flash:/cpu\_trig.sh from trigger 71's script list, use the commands:

```
awplus# configure terminal
awplus(config)# trigger 71
awplus(config-trigger)# no script flash:/cpu_trig.sh
```

To remove all the scripts from trigger 71's script list, use the commands:

```
awplus# configure terminal
awplus(config)# trigger 71
awplus(config-trigger)# no script all
```

**Related  
Commands** [show trigger](#)  
[trigger](#)

# show debugging trigger

**Overview** This command displays the current status for trigger utility debugging. Use this command to show when trigger debugging has been turned on or off from the [debug trigger](#) command.

**Syntax** `show debugging trigger`

**Mode** User Exec and Privileged Exec

**Example** To display the current configuration of trigger debugging, use the command:

```
awplus# show debugging trigger
```

**Output** Figure 57-1: Example output from the **show debugging trigger** command

```
awplus#debug trigger
awplus#show debugging trigger
Trigger debugging status:
 Trigger debugging is on

awplus#no debug trigger
awplus#show debugging trigger
Trigger debugging status:
 Trigger debugging is off
```

**Related Commands** [debug trigger](#)



# show running-config trigger

**Overview** This command displays the current running configuration of the trigger utility.

**Syntax** `show running-config trigger`

**Mode** Privileged Exec

**Example** To display the current configuration of the trigger utility, use the command:

```
awplus# show running-config trigger
```

Figure 57-2: Example output from the **show running-config trigger** command

```
trigger 1
 type card in

type usb in
 trigger 2

type usb out
!
```

**Related  
Commands** [show trigger](#)

# show trigger

**Overview** This command displays configuration and diagnostic information about the triggers configured on the device. Specify the **show trigger** command without any options to display a summary of the configuration of all triggers.

**Syntax** `show trigger [<1-250>|counter|full]`

| Parameter | Description                                                                           |
|-----------|---------------------------------------------------------------------------------------|
| <1-250>   | Displays detailed information about a specific trigger, identified by its trigger ID. |
| counter   | Displays statistical information about all triggers.                                  |
| full      | Displays detailed information about all triggers.                                     |

**Mode** Privileged Exec

**Example** To get summary information about all triggers, use the following command:

```
awplus# show trigger
```

**Table 1:** Example output from the **show trigger** command

```
awplus#show trigger
TR# Type & Details Name Ac Te Tr Repeat #Scr Days/Date

003 CPU (80% any) Busy CPU Y N Y 5 1 smtwtfS
005 Periodic (30 min) Regular status check Y N N Continuous 1 -mtwtf-
007 Memory (85% up) High mem usage Y N Y 8 1 smtwtfS
011 Time (00:01) Weekend access Y N Y Continuous 1 -----s
013 Reboot Y N Y Continuous 2 smtwtfS
017 Interface (vlan1 ... Change config for... Y N Y Once 1 2-apr-2016
019 Ping-poll (5 up) Connection to svr1 Y N Y Continuous 1 smtwtfS

```

**Table 2:** Parameters in the output of the **show trigger** command

| Parameter      | Description                                                                                        |
|----------------|----------------------------------------------------------------------------------------------------|
| TR#            | Trigger identifier (ID).                                                                           |
| Type & Details | The trigger type, followed by the trigger details in brackets.                                     |
| Name           | Descriptive name of the trigger configured with the <a href="#">description (trigger)</a> command. |
| Ac             | Whether the trigger is active (Y), or inactive (N).                                                |

**Table 2:** Parameters in the output of the **show trigger** command (cont.)

| Parameter | Description                                                                                                                                                                                                         |
|-----------|---------------------------------------------------------------------------------------------------------------------------------------------------------------------------------------------------------------------|
| Te        | Whether the trigger is in test mode (Y) or not (N).                                                                                                                                                                 |
| Tr        | Whether or not the trigger is enabled to send SNMP traps. See the <a href="#">trap</a> command.                                                                                                                     |
| Repeat    | Whether the trigger repeats continuously, and if not, the configured repeat count for the trigger. To see the number of times a trigger has activated, use the <code>show trigger &lt;1-250&gt;</code> command.     |
| #Scr      | Number of scripts associated with the trigger.                                                                                                                                                                      |
| Days/Date | Days or date when the trigger may be activated. For the days options, the days are shown as a seven character string representing Sunday to Saturday. A hyphen indicates days when the trigger cannot be activated. |

To display detailed information about trigger 3, use the command:

```
awplus# show trigger 3
```

**Figure 57-3:** Example output from the **show trigger** command for a specific trigger

```
awplus#show trigger 3
Trigger Configuration Details

Trigger 3
Description display cpu usage when pass 80%
Type and details CPU (80% up)
Days 26-oct-2016
After 00:00:00
Before 23:59:59
Active Yes
Test No
Trap Yes
Repeat 123 (0)
Modified Tue Oct 25 02:26:03 2016
Number of activations 0
Last activation not activated
Number of scripts 1
 1. shocpu.scp
 2. <not configured>
 3. <not configured>
 4. <not configured>
 5. <not configured>

```

To display detailed information about all triggers, use the command:

```
awplus# show trigger full
```

**Table 3:** Example output from the **show trigger full** command

```
awplus#show trigger full
Trigger Configuration Details

Trigger 1
Description <no description>
Type and details USB (in)
Days smtwtfS
After 00:00:00
Before 23:59:59
Active Yes
Test No
Trap Yes
Repeat Continuous
Modified Tue Oct 25 14:43:50 2016
Number of activations 0
Last activation not activated
Number of scripts 0
 1. <not configured>
 2. <not configured>
 3. <not configured>
 4. <not configured>
 5. <not configured>

Trigger 2
Description <no description>
Type and details USB (out)
Days smtwtfS
After 00:00:00
Before 23:59:59
Active Yes
Test No
Trap Yes
Repeat Continuous
Modified Tue Oct 25 14:45:56 2016
Number of activations 0
Last activation not activated
Number of scripts 0
 1. <not configured>
 2. <not configured>
 3. <not configured>
 4. <not configured>
 5. <not configured>
```

**Table 4:** Parameters in the output of the **show trigger full** and **show trigger** commands for a specific trigger

| Parameter   | Description                      |
|-------------|----------------------------------|
| Trigger     | The ID of the trigger.           |
| Description | Descriptive name of the trigger. |

**Table 4:** Parameters in the output of the **show trigger full** and **show trigger** commands for a specific trigger (cont.)

| Parameter             | Description                                                                                                                                                                                                                                   |
|-----------------------|-----------------------------------------------------------------------------------------------------------------------------------------------------------------------------------------------------------------------------------------------|
| Type and details      | The trigger type and its activation conditions.                                                                                                                                                                                               |
| Days                  | The days on which the trigger is permitted to activate.                                                                                                                                                                                       |
| Date                  | The date on which the trigger is permitted to activate. Only displayed if configured, in which case it replaces "Days".                                                                                                                       |
| Active                | Whether or not the trigger is permitted to activate.                                                                                                                                                                                          |
| Test                  | Whether or not the trigger is operating in diagnostic mode.                                                                                                                                                                                   |
| Trap                  | Whether or not the trigger is enabled to send SNMP traps.                                                                                                                                                                                     |
| Repeat                | Whether the trigger repeats an unlimited number of times (Continuous) or for a set number of times. When the trigger can repeat only a set number of times, then the number of times the trigger has been activated is displayed in brackets. |
| Modified              | The date and time of the last time that the trigger was modified.                                                                                                                                                                             |
| Number of activations | Number of times the trigger has been activated since the last restart of the device.                                                                                                                                                          |
| Last activation       | The date and time of the last time that the trigger was activated.                                                                                                                                                                            |
| Number of scripts     | How many scripts are associated with the trigger, followed by the names of the script files in the order in which they run.                                                                                                                   |

To display counter information about all triggers use the command:

```
awplus# show trigger counter
```

**Figure 57-4:** Example output from the **show trigger counter** command

```
awplus#show trigger counter
Trigger Module Counters

Trigger activations 0
Time triggers activated today 0
Periodic triggers activated today 0
Interface triggers activated today 0
Resource triggers activated today 0
Reboottriggers activated today 0
Ping-poll triggers activated today 0

```

**Table 5:** Parameters in the output of the **show trigger counter** command

| Parameter                          | Description                                                                |
|------------------------------------|----------------------------------------------------------------------------|
| Trigger activations                | Number of times a trigger has been activated.                              |
| Time triggers activated today      | Number of times a time trigger has been activated today.                   |
| Periodic triggers activated today  | Number of times a periodic trigger has been activated today.               |
| Interface triggers activated today | Number of times an interface trigger has been activated today.             |
| Resource triggers activated today  | Number of times a CPU or memory resource trigger has been activated today. |
| Ping-poll triggers activated today | Number of times a ping-poll trigger has been activated today.              |

**Related Commands** [trigger](#)

# test

**Overview** This command puts the trigger into a diagnostic mode. In this mode the trigger may activate but when it does it will not run any of the trigger's scripts. A log message will be generated to indicate when the trigger has been activated.

The **no** variant of this command takes the trigger out of diagnostic mode, restoring normal operation. When the trigger activates the scripts associated with the trigger will be run, as normal.

**Syntax** test  
no test

**Mode** Trigger Configuration

**Usage** Configure a trigger first before you use this command to diagnose it. For information about configuring a trigger, see the [Triggers Feature Overview and Configuration Guide](#).

**Examples** To put trigger 5 into diagnostic mode, where no scripts will be run when the trigger activates, use the commands:

```
awplus# configure terminal
awplus(config)# trigger 5
awplus(config-trigger)# test
```

To take trigger 205 out of diagnostic mode, restoring normal operation, use the commands:

```
awplus# configure terminal
awplus(config)# trigger 205
awplus(config-trigger)# no test
```

**Related  
Commands** [show trigger](#)  
[trigger](#)

# time (trigger)

**Overview** This command specifies the time of day when the trigger is permitted to activate. The **after** parameter specifies the start of a time period that extends to midnight during which trigger may activate. By default the value of this parameter is 00:00:00 (am); that is, the trigger may activate at any time. The **before** parameter specifies the end of a time period beginning at midnight during which the trigger may activate. By default the value of this parameter is 23:59:59; that is, the trigger may activate at any time. If the value specified for **before** is later than the value specified for **after**, a time period from “after” to “before” is defined, during which the trigger may activate. This command is not applicable to time triggers (**type time**).

The following figure illustrates how the **before** and **after** parameters operate.

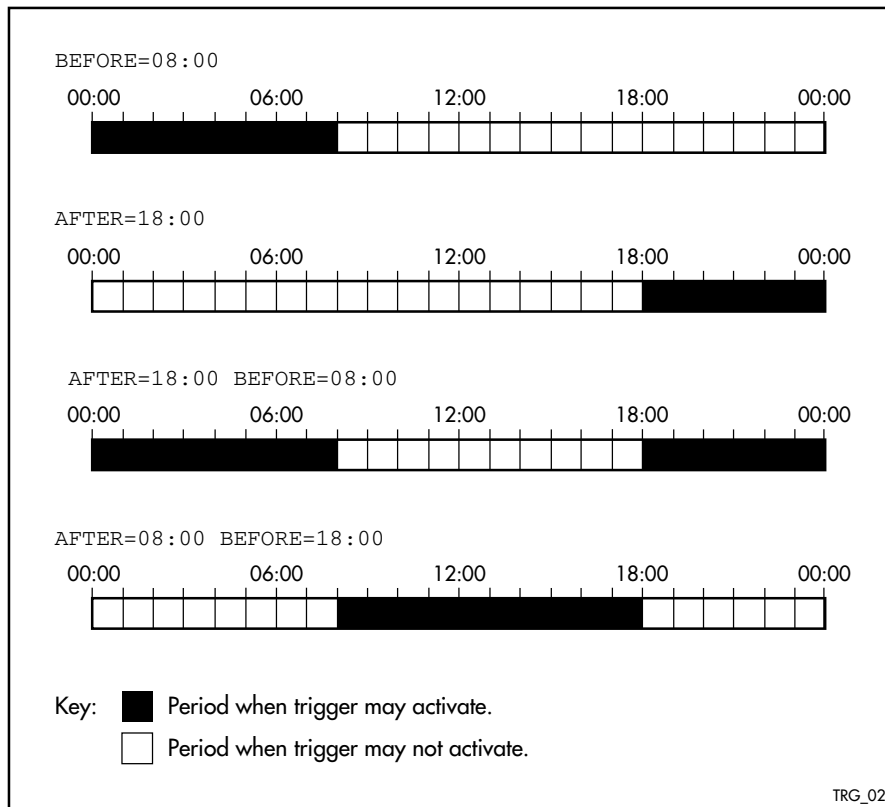

**Syntax** `time {[after <hh:mm:ss>] [before <hh:mm:ss>]}`

| Parameter                           | Description                                                 |
|-------------------------------------|-------------------------------------------------------------|
| <code>after&lt;hh:mm:ss&gt;</code>  | The earliest time of day when the trigger may be activated. |
| <code>before&lt;hh:mm:ss&gt;</code> | The latest time of day when the trigger may be activated.   |

**Mode** Trigger Configuration



**Usage** For example trigger configurations that use the **time (trigger)** command, see “Restrict Internet Access” and “Turn off Power to Port LEDs” in the [Triggers Feature Overview and Configuration Guide](#).

**Examples** To allow trigger 63 to activate between midnight and 10:30am, use the commands:

```
awplus# configure terminal
awplus(config)# trigger 63
awplus(config-trigger)# time before 10:30:00
```

To allow trigger 64 to activate between 3:45pm and midnight, use the commands:

```
awplus# configure terminal
awplus(config)# trigger 64
awplus(config-trigger)# time after 15:45:00
```

To allow trigger 65 to activate between 10:30am and 8:15pm, use the commands:

```
awplus# configure terminal
awplus(config)# trigger 65
awplus(config-trigger)# time after 10:30:00 before 20:15:00
```

**Related  
Commands** [show trigger](#)  
[trigger](#)

# trap

**Overview** This command enables the specified trigger to send SNMP traps.  
Use the **no** variant of this command to disable the sending of SNMP traps from the specified trigger.

**Syntax** trap  
no trap

**Default** SNMP traps are enabled by default for all defined triggers.

**Mode** Trigger Configuration

**Usage** You must configure SNMP before using traps with triggers. For more information, see:

- [Support for Allied Telesis Enterprise\\_MIBs\\_in\\_AlliedWare Plus](#), for information about which MIB objects are supported.
- the [SNMP Feature Overview and Configuration\\_Guide](#).
- the [SNMP Commands](#) chapter.

Since SNMP traps are enabled by default for all defined triggers, a common usage will be for the **no** variant of this command to disable SNMP traps from a specified trap if the trap is only periodic. Refer in particular to AT-TRIGGER-MIB in the [Support for Allied Telesis Enterprise\\_MIBs\\_in AlliedWare Plus](#) for further information about the relevant SNMP MIB.

**Examples** To enable SNMP traps to be sent from trigger 5, use the commands:

```
awplus# configure terminal
awplus(config)# trigger 5
awplus(config-trigger)# trap
```

To disable SNMP traps being sent from trigger 205, use the commands:

```
awplus# configure terminal
awplus(config)# trigger 205
awplus(config-trigger)# no trap
```

**Related  
Commands** [trigger](#)  
[show trigger](#)

# trigger

**Overview** This command is used to access the Trigger Configuration mode for the specified trigger. Once Trigger Configuration mode has been entered the trigger type information can be configured and the trigger scripts and other operational parameters can be specified. At a minimum the trigger type information must be specified before the trigger can become active.

The **no** variant of this command removes a specified trigger and all configuration associated with it.

**Syntax** trigger <1-250>  
no trigger <1-250>

| Parameter | Description   |
|-----------|---------------|
| <1-250>   | A trigger ID. |

**Mode** Global Configuration

**Examples** To enter trigger configuration mode for trigger 12 use the command:

```
awplus# trigger 12
```

To completely remove all configuration associated with trigger 12, use the command:

```
awplus# no trigger 12
```

**Related Commands** [show trigger](#)  
[trigger activate](#)

# trigger activate

**Overview** This command is used to manually activate a specified trigger from the Privileged Exec mode, which has been configured with the **trigger** command from the Global Configuration mode.

**Syntax** `trigger activate <1-250>`

| Parameter | Description   |
|-----------|---------------|
| <1-250>   | A trigger ID. |

**Mode** Privileged Exec

**Usage** This command manually activates a trigger without the normal trigger conditions being met.

The trigger is activated even if it is configured as inactive. The scripts associated with the trigger will be executed even if the trigger is in the diagnostic test mode.

Triggers activated manually do not have their repeat counts decremented or their 'last triggered' time updated, and do not result in updates to the '[type] triggers today' counters.

**Example** To manually activate trigger 12 use the command:

```
awplus# trigger activate 12
```

**Related Commands** [show trigger](#)  
[trigger](#)

# type atmf node

**Overview** This command configures a trigger to be activated at an AMF node join event or leave event.

**Syntax** type atmf node {join|leave}

| Parameter | Description           |
|-----------|-----------------------|
| join      | AMF node join event.  |
| leave     | AMF node leave event. |

**Mode** Trigger Configuration

**CAUTION: Only configure this trigger on one device because it is a network wide event.**

**Example 1** To configure trigger 5 to activate at an AMF node leave event, use the following commands. In this example the command is entered on node-1:

```
node1(config)# trigger 5
node1(config-trigger) type atmf node leave
```

**Example 2** The following commands will configure trigger 5 to activate if an AMF node join event occurs on any node within the working set:

```
node1# atmf working-set group all
```

This command returns the following display:

```
=====
node1, node2, node3:
=====

Working set join
```

Note that the running the above command changes the prompt from the name of the local node, to the name of the AMF-Network followed, in square brackets, by the number of member nodes in the working set.

```
AMF-Net[3]# conf t
AMF-Net[3](config)# trigger 5
AMF-Net[3](config-trigger)# type atmf node leave
AMF-Net[3](config-trigger)# description "E-mail on AMF Exit"
AMF-Net[3](config-trigger)# active
```

Enter the name of the script to run at the trigger event.

```
AMF-Net[3] (config-trigger)# script 1 email_me.scp
AMF-Net[3] (config-trigger)# end
```

Display the trigger configurations

```
AMF-Net[3]# show trigger
```

This command returns the following display:

```
=====
node1:
=====
```

| TR# | Type & Details    | Description         | Ac | Te | Tr | Repeat     | #Scr | Days/Date |
|-----|-------------------|---------------------|----|----|----|------------|------|-----------|
| 001 | Periodic (2 min)  | Periodic Status Chk | Y  | N  | Y  | Continuous | 1    | smtwtfs   |
| 005 | ATMF node (leave) | E-mail on ATMF Exit | Y  | N  | Y  | Continuous | 1    | smtwtfs   |

```

=====
Node2, Node3,
=====
```

| TR# | Type & Details    | Description         | Ac | Te | Tr | Repeat     | #Scr | Days/Date |
|-----|-------------------|---------------------|----|----|----|------------|------|-----------|
| 005 | ATMF node (leave) | E-mail on ATMF Exit | Y  | N  | Y  | Continuous | 1    | smtwtfs   |

```

```

Display the triggers configured on each of the nodes in the AMF Network.

```
AMF-Net[3]# show running-config trigger
```

This command returns the following display:

```
=====
Node1:
=====

trigger 1
 type periodic 2
 script 1 atmf.scp
trigger 5
 type atmf node leave
description "E-mail on ATMF Exit"
 script 1 email_me.scp
!

=====
Node2, Node3:
=====

trigger 5
 type atmf node leave
description "E-mail on ATMF Exit"
 script 1 email_me.scp
!
```

**Related  
Commands** [show trigger](#)

# type card

**Overview** Use this command to configure a trigger that activates on either the removal or the insertion of a Secure Digital (SD) or Secure Digital High Capacity (SDHC) card.

**Syntax** `type card {in|out}`

| Parameter | Description                               |
|-----------|-------------------------------------------|
| in        | Trigger activates on insertion of a card. |
| out       | Trigger activates on removal of a card.   |

**Mode** Trigger Configuration

**Usage** Card triggers cannot execute script files from a card.

For example trigger configurations that use the **type card** command, see “Capture Show Output and Save to an SD Card” in the [Triggers Feature Overview and Configuration Guide](#).

**Examples** To configure `trigger 1` to activate on the insertion of a card, use the commands:

```
awplus# configure terminal
awplus(config)# trigger 1
awplus(config-trigger)# type card in
```

**Related Commands** [trigger](#)  
[show running-config trigger](#)  
[show trigger](#)



# type cpu

**Overview** This command configures a trigger to activate based on CPU usage level. Selecting the **up** option causes the trigger to activate when the CPU usage exceeds the specified usage level. Selecting the **down** option causes the trigger to activate when CPU usage drops below the specified usage level. Selecting **any** causes the trigger to activate in both situations. The default is **any**.

**Syntax** `type cpu <1-100> [up|down|any]`

| Parameter | Description                                                            |
|-----------|------------------------------------------------------------------------|
| <1-100>   | The percentage of CPU usage at which to trigger.                       |
| up        | Activate when CPU usage exceeds the specified level.                   |
| down      | Activate when CPU usage drops below the specified level                |
| any       | Activate when CPU usage passes the specified level in either direction |

**Mode** Trigger Configuration

**Usage** For an example trigger configuration that uses the **type cpu** command, see “Capture Unusual CPU and RAM Activity” in the [Triggers Feature Overview and Configuration Guide](#).

**Examples** To configure trigger 28 to be a CPU trigger that activates when CPU usage exceeds 80% use the following commands:

```
awplus# configure terminal
awplus(config)# trigger 28
awplus(config-trigger)# type cpu 80 up
```

To configure trigger 5 to be a CPU trigger that activates when CPU usage either rises above or drops below 65%, use the following commands:

```
awplus# configure terminal
awplus(config)# trigger 5
awplus(config-trigger)# type cpu 65

or

awplus# configure terminal
awplus(config)# trigger 5
awplus(config-trigger)# type cpu 65 any
```

**Related Commands** [show trigger](#)  
[trigger](#)

# type interface

**Overview** This command configures a trigger to activate based on the link status of an interface. The trigger can be activated when the interface becomes operational by using the **up** option, or when the interface closes by using the **down** option. The trigger can also be configured to activate when either one of these events occurs by using the **any** option.

**Syntax** `type interface <interface> [up|down|any]`

| Parameter   | Description                                                                               |
|-------------|-------------------------------------------------------------------------------------------|
| <interface> | Interface name. This can be the name of a device port, an eth-management port, or a VLAN. |
| up          | Activate when interface becomes operational.                                              |
| down        | Activate when the interface closes.                                                       |
| any         | Activate when any interface link status event occurs.                                     |

**Mode** Trigger Configuration

**Example** To configure trigger 19 to be an interface trigger that activates when port1.0.2 becomes operational, use the following commands:

```
awplus# configure terminal
awplus(config)# trigger 19
awplus(config-trigger)# type interface port1.0.2 up
```

**Related  
Commands** [show trigger](#)  
[trigger](#)

# type memory

**Overview** This command configures a trigger to activate based on RAM usage level. Selecting the **up** option causes the trigger to activate when memory usage exceeds the specified level. Selecting the **down** option causes the trigger to activate when memory usage drops below the specified level. Selecting **any** causes the trigger to activate in both situations. The default is **any**.

**Syntax** `type memory <1-100> [up|down|any]`

| Parameter | Description                                                                |
|-----------|----------------------------------------------------------------------------|
| <1-100>   | The percentage of memory usage at which to trigger.                        |
| up        | Activate when memory usage exceeds the specified level.                    |
| down      | Activate when memory usage drops below the specified level.                |
| any       | Activate when memory usage passes the specified level in either direction. |

**Mode** Trigger Configuration

**Examples** To configure trigger 12 to be a memory trigger that activates when memory usage exceeds 50% use the following commands:

```
awplus# configure terminal
awplus(config)# trigger 12
awplus(config-trigger)# type memory 50 up
```

To configure trigger 40 to be a memory trigger that activates when memory usage either rises above or drops below 65%, use the following commands:

```
awplus# configure terminal
awplus(config)# trigger 40
awplus(config-trigger)# type memory 65
```

or

```
awplus# configure terminal
awplus(config)# trigger 40
awplus(config-trigger)# type memory 65 any
```

**Related Commands** [show trigger](#)  
[trigger](#)

# type periodic

**Overview** This command configures a trigger to be activated at regular intervals. The time period between activations is specified in minutes.

**Syntax** `type periodic <1-1440>`

| Parameter                   | Description                                |
|-----------------------------|--------------------------------------------|
| <code>&lt;1-1440&gt;</code> | The number of minutes between activations. |

**Mode** Trigger Configuration

**Usage** A combined limit of 10 triggers of the type periodic and time can be configured. If you attempt to add more than 10 triggers the following error message is displayed:

```
% Cannot configure more than 10 triggers with the type time or periodic
```

For an example trigger configuration that uses the **type periodic** command, see "See Daily Statistics" in the [Triggers Feature Overview and Configuration Guide](#).

**Example** To configure trigger 44 to activate periodically at 10 minute intervals use the following commands:

```
awplus# configure terminal
awplus(config)# trigger 44
awplus(config-trigger)# type periodic 10
```

**Related Commands** [show trigger](#)  
[trigger](#)

# type ping-poll

**Overview** This command configures a trigger that activates when Ping Polling identifies that a target device's status has changed. This allows you to run a configuration script when a device becomes reachable or unreachable.

**Syntax** `type ping-poll <1-100> {up|down}`

| Parameter | Description                                                                     |
|-----------|---------------------------------------------------------------------------------|
| <1-100>   | The ping poll ID.                                                               |
| up        | The trigger activates when ping polling detects that the target is reachable.   |
| down      | The trigger activates when ping polling detects that the target is unreachable. |

**Mode** Trigger Configuration

**Example** To configure trigger 106 to activate when ping poll 12 detects that its target device is now unreachable, use the following commands:

```
awplus# configure terminal
awplus(config)# trigger 106
awplus(config-trigger)# type ping-poll 12 down
```

**Related Commands** [show trigger](#)  
[trigger](#)

# type reboot

**Overview** This command configures a trigger that activates when your device is rebooted.

**Syntax** type reboot

**Mode** Trigger Configuration

**Example** To configure trigger 32 to activate when your device reboots, use the following commands:

```
awplus# configure terminal
awplus(config)# trigger 32
awplus(config-trigger)# type reboot
```

**Related  
Commands** [show trigger](#)  
[trigger](#)

# type time

**Overview** This command configures a trigger that activates at a specified time of day.

**Syntax** `type time <hh:mm>`

| Parameter                  | Description                       |
|----------------------------|-----------------------------------|
| <code>&lt;hh:mm&gt;</code> | The time to activate the trigger. |

**Mode** Trigger Configuration

**Usage** A combined limit of 10 triggers of the type time and type periodic can be configured. If you attempt to add more than 10 triggers the following error message is displayed:

```
% Cannot configure more than 10 triggers with the type time or
periodic
```

**Example** To configure trigger 86 to activate at 15:53, use the following commands:

```
awplus# configure terminal
awplus(config)# trigger 86
awplus(config-trigger)# type time 15:53
```

**Related  
Commands** [show trigger](#)  
[trigger](#)

# type usb

**Overview** Use this command to configure a trigger that activates on either the removal or the insertion of a USB storage device.

**Syntax** `type usb {in|out}`

| Parameter | Description                                             |
|-----------|---------------------------------------------------------|
| in        | Trigger activates on insertion of a USB storage device. |
| out       | Trigger activates on removal of a USB storage device.   |

**Mode** Trigger Configuration

**Usage** USB triggers cannot execute script files from a USB storage device.

**Examples** To configure trigger 1 to activate on the insertion of a USB storage device, use the commands:

```
awplus# configure terminal
awplus(config)# trigger 1
awplus(config-trigger)# type usb in
```

**Related Commands** [trigger](#)  
[show running-config trigger](#)  
[show trigger](#)



# undebug trigger

**Overview** This command applies the functionality of the **no debug trigger** command.

# 58

# Ping-Polling Commands

## Introduction

**Overview** This chapter provides an alphabetical reference for commands used to configure Ping Polling. For more information, see the [Ping Polling Feature Overview and Configuration Guide](#).

For information on filtering and saving command output, see the [“Getting Started with AlliedWare Plus” Feature Overview and Configuration Guide](#).

Table 58-1: The following table lists the default values when configuring a ping poll

| Default           | Value                                                                       |
|-------------------|-----------------------------------------------------------------------------|
| Critical-interval | 1 second                                                                    |
| Description       | No description                                                              |
| Fail-count        | 5                                                                           |
| Length            | 32 bytes                                                                    |
| Normal-interval   | 30 seconds                                                                  |
| Sample-size       | 5                                                                           |
| Source-ip         | The IP address of the interface from which the ping packets are transmitted |
| Time-out          | 1 second                                                                    |
| Up-count          | 30                                                                          |

- Command List**
- [“active \(ping-polling\)”](#) on page 2604
  - [“clear ping-poll”](#) on page 2605
  - [“critical-interval”](#) on page 2606
  - [“debug ping-poll”](#) on page 2607

- [“description \(ping-polling\)”](#) on page 2608
- [“fail-count”](#) on page 2609
- [“ip \(ping-polling\)”](#) on page 2610
- [“length \(ping-poll data\)”](#) on page 2611
- [“normal-interval”](#) on page 2612
- [“ping-poll”](#) on page 2613
- [“sample-size”](#) on page 2614
- [“show counter ping-poll”](#) on page 2616
- [“show ping-poll”](#) on page 2618
- [“source-ip”](#) on page 2622
- [“timeout \(ping polling\)”](#) on page 2624
- [“up-count”](#) on page 2625
- [“undebug ping-poll”](#) on page 2626

# active (ping-polling)

**Overview** This command enables a ping-poll instance. The polling instance sends ICMP echo requests to the device with the IP address specified by the [ip \(ping-polling\)](#) command.

By default, polling instances are disabled. When a polling instance is enabled, it assumes that the device it is polling is unreachable.

The **no** variant of this command disables a ping-poll instance. The polling instance no longer sends ICMP echo requests to the polled device. This also resets all counters for this polling instance.

**Syntax** active  
no active

**Mode** Ping-Polling Configuration

**Examples** To activate the ping-poll instance 43, use the commands:

```
awplus# configure terminal
awplus(config)# ping-poll 43
awplus(config-ping-poll)# active
```

To disable the ping-poll instance 43 and reset its counters, use the commands:

```
awplus# configure terminal
awplus(config)# ping-poll 43
awplus(config-ping-poll)# no active
```

**Related Commands** [debug ping-poll](#)  
[ip \(ping-polling\)](#)  
[ping-poll](#)  
[show ping-poll](#)

# clear ping-poll

**Overview** This command resets the specified ping poll, or all ping poll instances. This clears the ping counters, and changes the status of polled devices to unreachable. The polling instance changes to the polling frequency specified with the [critical-interval](#) command. The device status changes to reachable once the device responses have reached the [up-count](#).

**Syntax** `clear ping-poll {<1-100>|all}`

| Parameter | Description                                                                                                                                        |
|-----------|----------------------------------------------------------------------------------------------------------------------------------------------------|
| <1-100>   | A ping poll ID number. The specified ping poll instance has its counters cleared, and the status of the device it polls is changed to unreachable. |
| all       | Clears the counters and changes the device status of all polling instances.                                                                        |

**Mode** Privileged Exec

**Examples** To reset the ping poll instance 12, use the command:

```
awplus# clear ping-poll 12
```

To reset all ping poll instances, use the command:

```
awplus# clear ping-poll all
```

**Related Commands** [active \(ping-polling\)](#)  
[ping-poll](#)  
[show ping-poll](#)

# critical-interval

**Overview** This command specifies the time period in seconds between pings when the polling instance has not received a reply to at least one ping, and when the device is unreachable.

This command enables the device to quickly observe changes in state, and should be set to a much lower value than the [normal-interval](#) command.

The **no** variant of this command sets the critical interval to the default of one second.

**Syntax** `critical-interval <1-65536>`  
`no critical-interval`

| Parameter                    | Description                                                                                        |
|------------------------------|----------------------------------------------------------------------------------------------------|
| <code>&lt;1-65536&gt;</code> | Time in seconds between pings, when the device has failed to a ping, or the device is unreachable. |

**Default** The default is 1 second.

**Mode** Ping-Polling Configuration

**Examples** To set the critical interval to 2 seconds for the ping-polling instance 99, use the commands:

```
awplus# configure terminal
awplus(config)# ping-poll 99
awplus(config-ping-poll)# critical-interval 2
```

To reset the critical interval to the default of one second for the ping-polling instance 99, use the commands:

```
awplus# configure terminal
awplus(config)# ping-poll 99
awplus(config-ping-poll)# no critical-interval
```

**Related  
Commands**

[fail-count](#)  
[normal-interval](#)  
[sample-size](#)  
[show ping-poll](#)  
[timeout \(ping polling\)](#)  
[up-count](#)

# debug ping-poll

**Overview** This command enables ping poll debugging for the specified ping-poll instance. This generates detailed messages about ping execution.

The **no** variant of this command disables ping-poll debugging for the specified ping-poll.

**Syntax** `debug ping-poll <1-100>`  
`no debug ping-poll {<1-100>|all}`

| Parameter | Description                       |
|-----------|-----------------------------------|
| <1-100>   | A unique ping poll ID number.     |
| all       | Turn off all ping-poll debugging. |

**Mode** Privileged Exec

**Examples** To enable debugging for ping-poll instance 88, use the command:

```
awplus# debug ping-poll 88
```

To disable all ping poll debugging, use the command:

```
awplus# no debug ping-poll all
```

To disable debugging for ping-poll instance 88, use the command:

```
awplus# no debug ping-poll 88
```

**Related Commands**

- [active \(ping-polling\)](#)
- [clear ping-poll](#)
- [ping-poll](#)
- [show ping-poll](#)
- [undebug ping-poll](#)

## description (ping-polling)

**Overview** This command specifies a string to describe the ping-polling instance. This allows the ping-polling instance to be recognized easily in show commands. Setting this command is optional.

By default ping-poll instances do not have a description.

Use the **no** variant of this command to delete the description set.

**Syntax** `description <description>`  
`no description`

| Parameter                        | Description                                                                                                                   |
|----------------------------------|-------------------------------------------------------------------------------------------------------------------------------|
| <code>&lt;description&gt;</code> | The description of the target. Valid characters are any printable character and spaces. There is no maximum character length. |

**Mode** Ping-Polling Configuration

**Examples** To add the text "Primary Gateway" to describe the ping-poll instance 45, use the commands:

```
awplus# configure terminal
awplus(config)# ping-poll 45
awplus(config-ping-poll)# description Primary Gateway
```

To delete the description set for the ping-poll instance 45, use the commands:

```
awplus# configure terminal
awplus(config)# ping-poll 45
awplus(config-ping-poll)# no description
```

**Related Commands** [ping-poll](#)  
[show ping-poll](#)



# fail-count

**Overview** This command specifies the number of pings that must be unanswered, within the total number of pings specified by the [sample-size](#) command, for the ping-polling instance to consider the device unreachable.

If the number set by the [sample-size](#) command and the **fail-count** commands are the same, then the unanswered pings must be consecutive. If the number set by the [sample-size](#) command is greater than the number set by the **fail-count** command, then a device that does not always reply to pings may be declared unreachable.

The **no** variant of this command resets the fail count to the default.

**Syntax** `fail-count <1-100>`  
`no fail-count`

| Parameter                  | Description                                                                                                                        |
|----------------------------|------------------------------------------------------------------------------------------------------------------------------------|
| <code>&lt;1-100&gt;</code> | The number of pings within the sample size that a reachable device must fail to respond to before it is classified as unreachable. |

**Default** The default is 5.

**Mode** Ping-Polling Configuration

**Examples** To specify the number of pings that must fail within the sample size to determine that a device is unreachable for ping-polling instance 45, use the commands:

```
awplus# configure terminal
awplus(config)# ping-poll 45
awplus(config-ping-poll)# fail-count 5
```

To reset the fail-count to its default of 5 for ping-polling instance 45, use the commands:

```
awplus# configure terminal
awplus(config)# ping-poll 45
awplus(config-ping-poll)# no fail-count
```

**Related  
Commands**

- [critical-interval](#)
- [normal-interval](#)
- [ping-poll](#)
- [sample-size](#)
- [show ping-poll](#)
- [timeout \(ping polling\)](#)
- [up-count](#)

# ip (ping-polling)

**Overview** This command specifies the IPv4 address of the device you are polling.

**Syntax** `ip {<ip-address>|<ipv6-address>}`

| Parameter                         | Description                                        |
|-----------------------------------|----------------------------------------------------|
| <code>&lt;ip-address&gt;</code>   | An IPv4 address in dotted decimal notation A.B.C.D |
| <code>&lt;ipv6-address&gt;</code> | An IPv6 address in hexadecimal notation X:X::X:X   |

**Mode** Ping-Polling Configuration

**Examples** To set ping-poll instance 5 to poll the device with the IP address 192.168.0.1, use the commands:

```
awplus# configure terminal
awplus(config)# ping-poll 5
awplus(config-ping-poll)# ip 192.168.0.1
```

To set ping-poll instance 10 to poll the device with the IPv6 address 2001:db8::, use the commands:

```
awplus# configure terminal
awplus(config)# ping-poll 10
awplus(config-ping-poll)# ip 2001:db8::
```

**Related Commands**

- [ping-poll](#)
- [source-ip](#)
- [show ping-poll](#)

# length (ping-poll data)

**Overview** This command specifies the number of data bytes to include in the data portion of the ping packet. This allows you to set the ping packets to a larger size if you find that larger packet types in your network are not reaching the polled device, while smaller packets are getting through. This encourages the polling instance to change the device's status to unreachable when the network is dropping packets of the size you are interested in.

The **no** variant of this command resets the data bytes to the default of 32 bytes.

**Syntax** length <4-1500>  
no length

| Parameter | Description                                                                 |
|-----------|-----------------------------------------------------------------------------|
| <4-1500>  | The number of data bytes to include in the data portion of the ping packet. |

**Default** The default is 32.

**Mode** Ping-Polling Configuration

**Examples** To specify that ping-poll instance 12 sends ping packet with a data portion of 56 bytes, use the commands:

```
awplus# configure terminal
awplus(config)# ping-poll 12
awplus(config-ping-poll)# length 56
```

To reset the number of data bytes in the ping packet to the default of 32 bytes for ping-poll instance 3, use the commands:

```
awplus# configure terminal
awplus(config)# ping-poll 12
awplus(config-ping-poll)# length
```

**Related Commands** ping-poll  
show ping-poll

# normal-interval

**Overview** This command specifies the time period between pings when the device is reachable.

The **no** variant of this command resets the time period to the default of 30 seconds.

**Syntax** `normal-interval <1-65536>`  
`no normal-interval`

| Parameter                    | Description                                                 |
|------------------------------|-------------------------------------------------------------|
| <code>&lt;1-65536&gt;</code> | Time in seconds between pings when the target is reachable. |

**Default** The default is 30 seconds.

**Mode** Ping-Polling Configuration

**Examples** To specify a time period of 60 seconds between pings when the device is reachable for ping-poll instance 45, use the commands:

```
awplus# configure terminal
awplus(config)# ping-poll 45
awplus(config-ping-poll)# normal-interval 60
```

To reset the interval to the default of 30 seconds for ping-poll instance 45, use the commands:

```
awplus# configure terminal
awplus(config)# ping-poll 45
awplus(config-ping-poll)# no normal-interval
```

**Related Commands**

- [critical-interval](#)
- [fail-count](#)
- [ping-poll](#)
- [sample-size](#)
- [show ping-poll](#)
- [timeout \(ping polling\)](#)
- [up-count](#)

# ping-poll

**Overview** This command enters the ping-poll configuration mode. If a ping-poll exists with the specified number, then this command enters its configuration mode. If no ping-poll exists with the specified number, then this command creates a new ping poll with this ID number.

To configure a ping-poll, create a ping poll using this command, and use the [ip \(ping-polling\)](#) command to specify the device you want the polling instance to poll. It is not necessary to specify any further commands unless you want to change a command's default.

The **no** variant of this command deletes the specified ping poll.

**Syntax** `ping-poll <1-100>`  
`no ping-poll <1-100>`

| Parameter | Description                   |
|-----------|-------------------------------|
| <1-100>   | A unique ping poll ID number. |

**Mode** Global Configuration

**Examples** To create ping-poll instance 3 and enter ping-poll configuration mode, use the commands:

```
awplus# configure terminal
awplus(config)# ping-poll 3
awplus(config-ping-poll)#
```

To delete ping-poll instance 3, use the commands:

```
awplus# configure terminal
awplus(config)# no ping-poll 3
```

**Related Commands**

- [active \(ping-polling\)](#)
- [clear ping-poll](#)
- [debug ping-poll](#)
- [description \(ping-polling\)](#)
- [ip \(ping-polling\)](#)
- [length \(ping-poll data\)](#)
- [show ping-poll](#)
- [source-ip](#)

# sample-size

**Overview** This command sets the total number of pings that the polling instance inspects when determining whether a device is unreachable. If the number of pings specified by the **fail-count** command go unanswered within the inspected sample, then the device is declared unreachable.

If the numbers set in this command and **fail-count** command are the same, the unanswered pings must be consecutive. If the number set by this command is greater than that set with the **fail-count** command, a device that does not always reply to pings may be declared unreachable.

You cannot set this command's value lower than the **fail-count** value.

The polling instance uses the number of pings specified by the **up-count** command to determine when a device is reachable.

The **no** variant of this command resets this command to the default.

**Syntax** `sample-size <1-100>`  
`no sample size`

| Parameter | Description                                             |
|-----------|---------------------------------------------------------|
| <1-100>   | Number of pings that determines critical and up counts. |

**Default** The default is 5.

**Mode** Ping-Polling Configuration

**Examples** To set the sample-size to 50 for ping-poll instance 43, use the commands:

```
awplus# configure terminal
awplus(config)# ping-poll 43
awplus(config-ping-poll)# sample-size 50
```

To reset sample-size to the default of 5 for ping-poll instance 43, use the commands:

```
awplus# configure terminal
awplus(config)# ping-poll 43
awplus(config-ping-poll)# no sample-size
```

**Related  
Commands**

- critical-interval
- fail-count
- normal-interval
- ping-poll
- show ping-poll
- timeout (ping polling)
- up-count

# show counter ping-poll

**Overview** This command displays the counters for ping polling.

**Syntax** show counter ping-poll [*<1-100>*]

| Parameter            | Description                                                                                                                                                                           |
|----------------------|---------------------------------------------------------------------------------------------------------------------------------------------------------------------------------------|
| <i>&lt;1-100&gt;</i> | A unique ping poll ID number. This displays the counters for the specified ping poll only. If you do not specify a ping poll, then this command displays counters for all ping polls. |

**Mode** User Exec and Privileged Exec

**Output** Figure 58-1: Example output from the **show counter ping-poll** command

```
Ping-polling counters
Ping-poll: 1
PingsSent 15
PingsFailedUpState 0
PingsFailedDownState 0
ErrorSendingPing 2
CurrentUpCount 13
CurrentFailCount 0
UpStateEntered 0
DownStateEntered 0

Ping-poll: 2
PingsSent 15
PingsFailedUpState 0
PingsFailedDownState 0
ErrorSendingPing 2
CurrentUpCount 13
CurrentFailCount 0
UpStateEntered 0
DownStateEntered 0

Ping-poll: 5
PingsSent 13
PingsFailedUpState 0
PingsFailedDownState 2
ErrorSendingPing 2
CurrentUpCount 9
CurrentFailCount 0
UpStateEntered 0
DownStateEntered 0
```



**Table 59:** Parameters in output of the **show counter ping-poll** command

| Parameter            | Description                                                                                                                                                  |
|----------------------|--------------------------------------------------------------------------------------------------------------------------------------------------------------|
| Ping-poll            | The ID number of the polling instance.                                                                                                                       |
| PingsSent            | The total number of pings generated by the polling instance.                                                                                                 |
| PingsFailedUpState   | The number of unanswered pings while the target device is in the Up state. This is a cumulative counter for multiple occurrences of the Up state.            |
| PingsFailedDownState | Number of unanswered pings while the target device is in the Down state. This is a cumulative counter for multiple occurrences of the Down state.            |
| ErrorSendingPing     | The number of pings that were not successfully sent to the target device.<br>This error can occur when your device does not have a route to the destination. |
| CurrentUpCount       | The current number of sequential ping replies.                                                                                                               |
| CurrentFailCount     | The number of ping requests that have not received a ping reply in the current sample-size window.                                                           |
| UpStateEntered       | Number of times the target device has entered the Up state.                                                                                                  |
| DownStateEntered     | Number of times the target device has entered the Down state.                                                                                                |

**Example** To display counters for the polling instances, use the command:

```
awplus# show counter ping-poll
```

**Related Commands**

- [debug ping-poll](#)
- [ping-poll](#)
- [show ping-poll](#)

# show ping-poll

**Overview** This command displays the settings and status of ping polls.

**Syntax** `show ping-poll [<1-100>|state {up|down}] [brief]`

| Parameter | Description                                                                                                    |                                                                   |
|-----------|----------------------------------------------------------------------------------------------------------------|-------------------------------------------------------------------|
| <1-100>   | Displays settings and status for the specified polling instance.                                               |                                                                   |
| state     | Displays polling instances based on whether the device they are polling is currently reachable or unreachable. |                                                                   |
|           | up                                                                                                             | Displays polling instance where the device state is reachable.    |
|           | down                                                                                                           | Displays polling instances where the device state is unreachable. |
| brief     | Displays a summary of the state of ping polls, and the devices they are polling.                               |                                                                   |

**Mode** User Exec and Privileged Exec

**Output** Figure 58-2: Example output from the **show ping-poll brief** command

```
Ping Poll Configuration

Id Enabled State Destination

1 Yes Down 192.168.0.1
2 Yes Up 192.168.0.100
```

**Table 60:** Parameters in output of the **show ping-poll brief** command

| Parameter | Meaning                                                                                                                   |
|-----------|---------------------------------------------------------------------------------------------------------------------------|
| Id        | The ID number of the polling instance, set when creating the polling instance with the <a href="#">ping-poll</a> command. |
| Enabled   | Whether the polling instance is enabled or disabled.                                                                      |

**Table 60:** Parameters in output of the **show ping-poll brief** command (cont.)

| Parameter     | Meaning                                                                                                                                  |
|---------------|------------------------------------------------------------------------------------------------------------------------------------------|
| State         | The current status of the device being polled:                                                                                           |
| Up            | The device is reachable.                                                                                                                 |
| Down          | The device is unreachable.                                                                                                               |
| Critical Up   | The device is reachable but recently the polling instance has not received some ping replies, so the polled device may be going down.    |
| Critical Down | The device is unreachable but the polling instance received a reply to the last ping packet, so the polled device may be coming back up. |
| Destination   | The IP address of the polled device, set with the <code>ip (ping-polling)</code> command.                                                |

**Figure 58-3:** Example output from the **show ping-poll** command

```

Ping Poll Configuration

Poll 1:
Description : Primary Gateway
Destination IP address : 192.168.0.1
Status : Down
Enabled : Yes
Source IP address : 192.168.0.10
Critical interval : 1
Normal interval : 30
Fail count : 10
Up count : 5
Sample size : 50
Length : 32
Timeout : 1
Debugging : Enabled

```

```

Poll 2:
Description : Secondary Gateway
Destination IP address : 192.168.0.100
Status : Up
Enabled : Yes
Source IP address : Default
Critical interval : 5
Normal interval : 60
Fail count : 20
Up count : 30
Sample size : 100
Length : 56
Timeout : 2
Debugging : Enabled

```

**Table 61:** Parameters in output of the **show ping-poll** command

| Parameter              | Description                                                                                                                                                                                                           |                                                                                                                                          |
|------------------------|-----------------------------------------------------------------------------------------------------------------------------------------------------------------------------------------------------------------------|------------------------------------------------------------------------------------------------------------------------------------------|
| Description            | Optional description set for the polling instance with the <a href="#">description (ping-polling)</a> command.                                                                                                        |                                                                                                                                          |
| Destination IP address | The IP address of the polled device, set with the <a href="#">ip (ping-polling)</a> command.                                                                                                                          |                                                                                                                                          |
| Status                 | The current status of the device being polled:                                                                                                                                                                        |                                                                                                                                          |
|                        | Up                                                                                                                                                                                                                    | The device is reachable.                                                                                                                 |
|                        | Down                                                                                                                                                                                                                  | The device is unreachable.                                                                                                               |
|                        | Critical Up                                                                                                                                                                                                           | The device is reachable but recently the polling instance has not received some ping replies, so the polled device may be going down.    |
|                        | Critical Down                                                                                                                                                                                                         | The device is unreachable but the polling instance received a reply to the last ping packet, so the polled device may be coming back up. |
| Enabled                | Whether the polling instance is enabled or disabled. The <a href="#">active (ping-polling)</a> and <a href="#">active (ping-polling)</a> commands enable and disable a polling instance.                              |                                                                                                                                          |
| Source IP address      | The source IP address sent in the ping packets. This is set using the <a href="#">source-ip</a> command.                                                                                                              |                                                                                                                                          |
| Critical interval      | The time period in seconds between pings when the polling instance has not received a reply to at least one ping, and when the device is unreachable. This is set with the <a href="#">critical-interval</a> command. |                                                                                                                                          |
| Normal interval        | The time period between pings when the device is reachable. This is set with the <a href="#">normal-interval</a> command.                                                                                             |                                                                                                                                          |

**Table 61:** Parameters in output of the **show ping-poll** command (cont.)

| Parameter   | Description                                                                                                                                                                                                                                                |
|-------------|------------------------------------------------------------------------------------------------------------------------------------------------------------------------------------------------------------------------------------------------------------|
| Fail count  | The number of pings that must be unanswered, within the total number of pings specified by the <a href="#">sample-size</a> command, for the polling instance to consider the device unreachable. This is set using the <a href="#">fail-count</a> command. |
| Up count    | The number of consecutive pings that the polling instance must receive a reply to before classifying the device reachable again. This is set using the <a href="#">up-count</a> command.                                                                   |
| Sample size | The total number of pings that the polling instance inspects when determining whether a device is unreachable. This is set using the <a href="#">sample-size</a> command.                                                                                  |
| Length      | The number of data bytes to include in the data portion of the ping packet. This is set using the <a href="#">length (ping-poll data)</a> command.                                                                                                         |
| Timeout     | The time in seconds that the polling instance waits for a response to a ping packet. This is set using the <a href="#">timeout (ping polling)</a> command.                                                                                                 |
| Debugging   | Indicates whether ping polling debugging is <b>Enabled</b> or <b>Disabled</b> . This is set using the <a href="#">debug ping-poll</a> command.                                                                                                             |

**Examples** To display the ping poll settings and the status of all the polls, use the command:

```
awplus# show ping-poll
```

To display a summary of the ping poll settings, use the command:

```
awplus# show ping-poll brief
```

To display the settings for ping poll 6, use the command:

```
awplus# show ping-poll 6
```

To display a summary of the state of ping poll 6, use the command:

```
awplus# show ping-poll 6 brief
```

To display the settings of ping polls that have reachable devices, use the command:

```
awplus# show ping-poll state up
```

To display a summary of ping polls that have unreachable devices, use the command:

```
awplus# show ping-poll 6 state down brief
```

**Related Commands** [debug ping-poll](#)  
[ping-poll](#)

# source-ip

**Overview** This command specifies the source IP address to use in ping packets.

By default, the polling instance uses the address of the interface through which it transmits the ping packets. It uses the device's local interface IP address when it is set. Otherwise, the IP address of the interface through which it transmits the ping packets is used.

The **no** variant of this command resets the source IP in the packets to the device's local interface IP address.

**Syntax** `source-ip {<ip-address>|<ipv6-address>}`  
`no source-ip`

| Parameter                         | Description                                        |
|-----------------------------------|----------------------------------------------------|
| <code>&lt;ip-address&gt;</code>   | An IPv4 address in dotted decimal notation A.B.C.D |
| <code>&lt;ipv6-address&gt;</code> | An IPv6 address in hexadecimal notation X:X::X:X   |

**Mode** Ping-Polling Configuration

**Examples** To configure the ping-polling instance 43 to use the source IP address 192.168.0.1 in ping packets, use the commands:

```
awplus# configure terminal
awplus(config)# ping-poll 43
awplus(config-ping-poll)# source-ip 192.168.0.1
```

To configure the ping-polling instance 43 to use the source IPv6 address 2001:db8:: in ping packets, use the commands:

```
awplus# configure terminal
awplus(config)# ping-poll 43
awplus(config-ping-poll)# source-ip 2001:db8::
```

To reset the source IP address to the device's local interface IP address for ping-poll instance 43, use the commands:

```
awplus# configure terminal
awplus(config)# ping-poll 43
awplus(config-ping-poll)# no source-ip
```

**Related  
Commands** [description \(ping-polling\)](#)  
[ip \(ping-polling\)](#)  
[length \(ping-poll data\)](#)  
[ping-poll](#)  
[show ping-poll](#)

# timeout (ping polling)

**Overview** This command specifies the time in seconds that the polling instance waits for a response to a ping packet. You may find a higher time-out useful in networks where ping packets have a low priority.

The **no** variant of this command resets the set time out to the default of one second.

**Syntax** `timeout <1-30>`  
`no timeout`

| Parameter | Description                                                                                        |
|-----------|----------------------------------------------------------------------------------------------------|
| <1-30>    | Length of time, in seconds, that the polling instance waits for a response from the polled device. |

**Default** The default is 1 second.

**Mode** Ping-Polling Configuration

**Examples** To specify the timeout as 5 seconds for ping-poll instance 43, use the commands:

```
awplus# configure terminal
awplus(config)# ping-poll 43
awplus(config-ping-poll)# timeout 5
```

To reset the timeout to its default of 1 second for ping-poll instance 43, use the commands:

```
awplus# configure terminal
awplus(config)# ping-poll 43
awplus(config-ping-poll)# no timeout
```

**Related Commands**

- [critical-interval](#)
- [fail-count](#)
- [normal-interval](#)
- [ping-poll](#)
- [sample-size](#)
- [show ping-poll](#)
- [up-count](#)



# up-count

**Overview** This command sets the number of consecutive pings that the polling instance must receive a reply to before classifying the device reachable again.

The **no** variant of this command resets the up count to the default of 30.

**Syntax** `up-count <1-100>`  
`no up-count`

| Parameter                  | Description                                                                      |
|----------------------------|----------------------------------------------------------------------------------|
| <code>&lt;1-100&gt;</code> | Number of replied pings before an unreachable device is classified as reachable. |

**Default** The default is 30.

**Mode** Ping-Polling Configuration

**Examples** To set the upcount to 5 consecutive pings for ping-polling instance 45, use the commands:

```
awplus# configure terminal
awplus(config)# ping-poll 45
awplus(config-ping-poll)# up-count 5
```

To reset the upcount to the default value of 30 consecutive pings for ping-polling instance 45, use the commands:

```
awplus# configure terminal
awplus(config)# ping-poll 45
awplus(config-ping-poll)# no up-count
```

**Related  
Commands**

[critical-interval](#)  
[fail-count](#)  
[normal-interval](#)  
[ping-poll](#)  
[sample-size](#)  
[show ping-poll](#)  
[timeout \(ping polling\)](#)

# undebbug ping-poll

**Overview** This command applies the functionality of the no `debug ping-poll` command.

# Part 8: Firewall and Network Address Translation (NAT)

# 59

# Firewall Commands

## Introduction

**Overview** This chapter provides an alphabetical reference of commands used to configure AlliedWare Plus Firewall. For more information see the [Firewall\\_and Network Address Translation \(NAT\) Feature Overview and Configuration\\_Guide](#).

The table below lists the firewall commands and their applicable modes.

Figure 59-1: Firewall commands and applicable modes

| Mode                   | Command                                      |
|------------------------|----------------------------------------------|
| Privileged Exec        | <code>clear firewall connections</code>      |
|                        | <code>debug firewall</code>                  |
|                        | <code>show debugging firewall</code>         |
|                        | <code>show firewall</code>                   |
|                        | <code>show firewall connections</code>       |
|                        | <code>show firewall rule</code>              |
|                        | <code>show firewall rule config-check</code> |
|                        | <code>show running-config firewall</code>    |
| Global Configuration   | <code>firewall</code>                        |
| Firewall Configuration | <code>protect (Firewall)</code>              |
|                        | <code>rule (Firewall)</code>                 |
|                        | <code>move rule (Firewall)</code>            |

- Command List**
- “[clear firewall connections](#)” on page 2630
  - “[connection-limit \(Firewall\)](#)” on page 2631
  - “[connection-log events](#)” on page 2632

- [“firewall”](#) on page 2633
- [“debug firewall”](#) on page 2634
- [“ip tcp timeout established”](#) on page 2635
- [“move rule \(Firewall\)”](#) on page 2636
- [“protect \(Firewall\)”](#) on page 2637
- [“rule \(Firewall\)”](#) on page 2638
- [“show connection-log events”](#) on page 2640
- [“show firewall”](#) on page 2641
- [“show firewall connections”](#) on page 2642
- [“show firewall connections limits”](#) on page 2643
- [“show firewall connections limits config-check”](#) on page 2644
- [“show firewall rule”](#) on page 2645
- [“show firewall rule config-check”](#) on page 2647
- [“show debugging firewall”](#) on page 2648
- [“show running-config firewall”](#) on page 2649

# clear firewall connections

**Overview** Use this command to clear firewall connections.

**Syntax** `clear firewall connections`

**Mode** Privileged Exec

**Usage** Removing the Network Address Translation (NAT) rule by using the **no nat rule** command for an actively translated flow does not stop translating immediately. This means subsequent packets in the flow are continued to be translated.

The continued translation after associated NAT rule is removed will only stop when:

- You use the **clear firewall connections** command to manually stop translations immediately, when the associated rule has been deleted regardless whether the firewall feature is actually configured with NAT or not.
- The traffic flow ends naturally, for example, when it is stopped from the source. If the flow is re-initiated from a host, it will not be translated by the firewall, as the rule is deleted after the first flow stopped.

**Examples** To clear firewall connections, use the command:

```
awplus# clear firewall connections
```

**Validation commands** [show firewall connections](#)

**Related commands** [rule \(NAT\)](#)

# connection-limit (Firewall)

**Overview** Use this command to limit firewall connections for an entity.

Use the **no** variant of this command to remove the limit.

**Syntax** `connection-limit [<1-65535>] from <entity_name> with limit <0-100000>`  
`no connection-limit {<1-65535>|all}`

| Parameter     | Description                                                                                                                                                           |
|---------------|-----------------------------------------------------------------------------------------------------------------------------------------------------------------------|
| <1-65535>     | Unique numeric identifier for the limit.                                                                                                                              |
| <entity_name> | An entity represents a logical grouping of subnets, hosts or interfaces. For more information about entity, see the <a href="#">Application and Entity Commands</a> . |
| <0-100000>    | The maximum number of permitted connections for the entity.                                                                                                           |
| all           | Delete all limits.                                                                                                                                                    |

**Default** The limiting is disabled by default and the number of connections will not be limited. However, the number is up to the maximum total number of allowed connections.

**Mode** Firewall Configuration

**Usage** This command allows you to limit the number of firewall sessions associated with a specific entity. The limit will be applied to each host on that entity. This means connection limits applied to an entity with multiple addresses will apply the limit to individual hosts, not the total connections for the entity. The limit applies to both IPv4 and IPv6.

If a connection limit rule is removed, any running connections are not stopped. Changes to limits only affect new connections. Adding a lower limit will not affect existing connections.

**Examples** To set a connection limit for entity DMZ, use the following command:

```
awplus(config-firewall)# connection-limit
1 from DMZ with limit 10000
```

To remove the connection limit, use the following command:

```
awplus(config-firewall)# no connection-limit
1
```

**Validation commands** [show firewall connections](#)  
[show firewall connections limits](#)

# connection-log events

**Overview** Use this command to enable extra logging for indicating the start and the end of connections passing through the firewall.

Use the **no** variant of this command to turn off the extra logging of connections passing through the firewall.

**Syntax** `connection-log events [new|end|all]`  
`no connection-log events [new|end|all]`

| Parameter | Description                                          |
|-----------|------------------------------------------------------|
| new       | New connection                                       |
| end       | Connections closed                                   |
| all       | All new connections and connections closed. Default. |

**Default** Connection logging is not enabled by default.

**Mode** Global Configuration.

**Usage** There are two types of messages you can log: new connections and connections that ended. You can control the amount of messages you log by choosing to log either type of message or all of the message types.

Messages contain the following information:

- time
- source and destination addresses (NATed and unNATed)
- protocol
- source and destination ports (NATed and unNATed)
- bytes and packets passed (found in the connection end message)

**Example** To log all of the new connections and all of the closed connections, use the commands:

```
awplus# configure terminal
awplus(config)# connection-log events all
```

**Related Commands** [show connection-log events](#)

**Command changes** Version 5.4.7-1.1: command added.



# firewall

**Overview** Use this command to configure the firewall.  
Use the **no** variant of this command to remove all firewall configuration.

**Syntax** `firewall`  
`no firewall`

**Mode** Global Configuration

**Usage** This command allows you to enter the Firewall Configuration mode. The command prompt for this mode is **awplus(config-firewall)#**

In the Firewall Configuration mode, you can:

- Enable or disable firewall protection, see the [protect \(Firewall\)](#) command.
- Create, move, or delete rules for the firewall, see the [rule \(Firewall\)](#) command and the [move rule \(Firewall\)](#) command.

**Examples** To configure the firewall, use the commands:

```
awplus# configure terminal
awplus(config)# firewall
awplus(config-firewall)#
```

To remove all firewall configuration, use the commands:

```
awplus# configure terminal
awplus(config)# no firewall
```

**Validation commands** `show firewall`  
`show running-config firewall`

# debug firewall

**Overview** Use this command to enable firewall debugging and Network Address Translation (NAT) debugging. This will cause additional detailed debugging information to be logged at the “informational” and “debugging” levels.

Use the **no** variant of this command to disable firewall debugging and NAT debugging.

For more information about NAT, see the [Firewall\\_and Network Address Translation \(NAT\) Feature Overview and Configuration\\_Guide](#).

**Syntax** `debug firewall`  
`no debug firewall`

**Default** Firewall debugging and NAT debugging are disabled by default.

**Mode** Privileged Exec

**Examples** To enable firewall debugging and NAT debugging, use the command:

```
awplus# debug firewall
```

To disable firewall debugging and NAT debugging, use the command:

```
awplus# no debug firewall
```

**Validation commands** [show debugging firewall](#)

# ip tcp timeout established

**Overview** Use this command to set the idle timeout for all established TCP connections. Use the **no** variant of this command to set the idle timeout back to the default of 3600 seconds.

**Syntax** `ip tcp timeout established <1-31536000>`  
`no ip tcp timeout established`

| Parameter                       | Description                                                                |
|---------------------------------|----------------------------------------------------------------------------|
| <code>&lt;1-31536000&gt;</code> | Idle timeout for established TCP connections in seconds from 1 to 3153600. |

**Default** 3600 seconds (1 hour)

**Mode** Global Configuration

**Usage** By default, when a TCP session is successfully established through the firewall, when the session goes idle, it automatically times out of the firewall connection tracking table after 3600 seconds. In some situations it may be beneficial to time out unused established TCP sessions earlier.

For example, in a busy environment where there is an excessive number of sessions being established, the firewall connection tracking table could become oversubscribed, with new connections being blocked until older sessions are timed out.

**Example** To set a non-default TCP session timeout for established idle sessions of 1800 seconds (30 minutes), use the commands:

```
awplus# configure terminal
awplus(config)# ip tcp timeout established 1800
```

**Example** To set the TCP session timeout for established idle sessions back to the default setting of 3600 seconds, use the commands:

```
awplus# configure terminal
awplus(config)# no ip tcp timeout established
```

**Related Commands** [show running-config](#)

**Command changes** Version 5.4.6-1.1: command added

# move rule (Firewall)

**Overview** Use this command to change the order of firewall rules.

Firewall rules are applied in rule ID order. When rules match the same application, source entity and destination entity, only the rule with the lowest ID is applied.

Note that you can move an existing rule ID only to an ID that is not assigned to any rule; otherwise you will be given an error message. Also note that a change to the rule order may change the rule results.

**Syntax** `move rule <1-65535> to <1-65535>`

| Parameter                                  | Description                                                                                                                                                                                                                          |
|--------------------------------------------|--------------------------------------------------------------------------------------------------------------------------------------------------------------------------------------------------------------------------------------|
| <code>move rule<br/>&lt;1-65535&gt;</code> | Move the ID of a given rule. The rule ID of the given rule must exist.<br>Each rule has an ID which is either designated by the user or automatically generated when the rule is created. The rule ID is an integer from 1 to 65535. |
| <code>to &lt;1-65535&gt;</code>            | New rule ID to assign. The new rule ID must not be used by any existing rule.                                                                                                                                                        |

**Mode** Firewall Configuration

**Examples** To change the rule ID from 20 to 10, use the commands:

```
awplus# configure terminal
awplus(config)# firewall
awplus(config-firewall)# move rule 20 to 10
```

**Validation commands** [show firewall rule](#)  
[show running-config firewall](#)

**Related commands** [rule \(Firewall\)](#)

# protect (Firewall)

**Overview** Use this command to enable firewall protection.

Use the **no** variant of this command to disable firewall protection without losing the existing firewall configuration.

**Syntax** protect  
no protect

**Default** Firewall protection is disabled by default.

**Mode** Firewall Configuration

**Usage** Firewall protection is disabled by default and all traffic can pass through the firewall. When the firewall is enabled and no rules are added, all traffic will be blocked by default. You can use the [rule \(Firewall\)](#) command to configure rules to allow traffic to pass through the firewall.

**Examples** To enable firewall protection, use the commands:

```
awplus# configure terminal
awplus(config)# firewall
awplus(config-firewall)# protect
```

To disable firewall protection, use the commands:

```
awplus# configure terminal
awplus(config)# firewall
awplus(config-firewall)# no protect
```

**Validation commands** [show firewall](#)  
[show running-config firewall](#)

# rule (Firewall)

**Overview** Use this command to create a rule for the firewall. Firewall security policy is specified in the form of firewall rules. Each rule defines the appropriate processing of a type of traffic passing through the firewall.

Use the **no** variant of this command to remove a rule.

**Syntax**

```
rule [<1-65535>] {permit|deny|reject|log} <application-name>
from <source-entity> to <destination-entity>
[no-state-enforcement] [log]

no rule {<1-65535>|all}
```

| Parameter            | Description                                                                                                                                                                                                                                                                                     |
|----------------------|-------------------------------------------------------------------------------------------------------------------------------------------------------------------------------------------------------------------------------------------------------------------------------------------------|
| <1-65535>            | Rule ID is an integer in the range <1-65535>. If you don't designate a rule ID, a rule ID will be automatically generated and it will be greater than the current highest rule ID.                                                                                                              |
| permit               | Permit connections that match the application, source entity and destination entity specified with this command.                                                                                                                                                                                |
| deny                 | Drop connections that match the application, source entity and destination entity specified with this command. No error message is sent back to the source host.                                                                                                                                |
| reject               | Reject connections that match the application, source entity and destination entity specified with this command. An error message (for instance, a TCP reset for a rejected TCP connection, or a destination unreachable message for an ICMP connection, etc.) is sent back to the source host. |
| log                  | When 'log' is the action for the rule, log an event each time the rule is hit. The traffic will also be processed by subsequent firewall rules which may permit, deny or reject the connection.                                                                                                 |
| <application-name>   | Application name. You can either specify an application name or use the word <i>any</i> , which stands for all applications. For more information about applications, see Application and Entity Commands.                                                                                      |
| <source-entity>      | Source entity name. An entity represents a logical grouping of subnets, hosts or interfaces. For more information about entities, see Application and Entity Commands.                                                                                                                          |
| <destination-entity> | Destination entity name.                                                                                                                                                                                                                                                                        |

| Parameter            | Description                                                                                                                                                                                                                                                                                                   |
|----------------------|---------------------------------------------------------------------------------------------------------------------------------------------------------------------------------------------------------------------------------------------------------------------------------------------------------------|
| no-state-enforcement | Optionally disable state enforcement for this rule. Use this option with caution as it will allow reverse path connection initiation. It should be used only when the traffic forward and reverse paths must be different and there is no alternative approach available. This option is disabled by default. |
| log                  | When 'log' is appended to a rule, the action is applied and a log message is also generated each time the rule is hit.                                                                                                                                                                                        |
| all                  | Delete all rules.                                                                                                                                                                                                                                                                                             |

**Mode** Firewall Configuration

**Usage** When the firewall is enabled and no rules are added, all traffic is blocked by default, you can use this command to create rules for permitting packets between entities.

The rule is not valid and cannot be hit if either the application, source entity or destination entity the rule applies to is not properly configured, for example, the application does not exist or does not have a protocol configured or the entity does not exist. To configure applications and entities, see Application and Entity Commands. You can also use the [show firewall rule config-check](#) command to check rule configuration validity.

You can change the rule order by using the [move rule \(Firewall\)](#) command.

**Examples** To create a rule for permitting application ping between 'public' and 'private', use the command:

```
awplus(config-firewall)# rule 10 permit
ping from public to private
```

To create a rule for denying application http between 'public.wan' and 'private.lan', use the command:

```
awplus(config-firewall)# rule 20 deny
http from public.wan to private.lan
```

To create a firewall rule to permit application 'ping' between 'public' and 'dmz' entities and to log the results, use the commands:

```
awplus(config-firewall)# rule 30 permit
ping from public to dmz log
```

**Related commands**

- [move rule \(Firewall\)](#)
- [show firewall rule](#)
- [show firewall rule config-check](#)

**Command changes** Version 5.4.7-0.1: **no-state-enforcement** option added.

# show connection-log events

**Overview** This command displays the configuration state (enabled or disabled) for the logging of connections passing through the firewall, as configured by the [connection-log events](#) command.

**Syntax** `show connection-log events`

**Mode** User Exec

**Example** To show the logging configuration state for the connections passing through the firewall, use the command:

```
awplus# show connection-log events
```

**Output** Figure 59-2: Example output from **show connection-log events**

```
awplus#show connection-log events
Log new connection events: Disabled
Log connection end events: Enabled
```

**Related Commands** [connection-log events](#)

**Command changes** Version 5.4.7-1.1: command added.



# show firewall

**Overview** Use this command to show the protection state of the firewall and the number of active connections being handled by the firewall.

You can use the [protect \(Firewall\)](#) command to enable firewall protection.

**Syntax** `show firewall`

**Mode** Privileged Exec

**Examples** To show the state of the firewall, use the command:

```
awplus# show firewall
```

**Output** Figure 59-3: Example output from the **show firewall** command

```
awplus#show firewall
Firewall protection is enabled
Active connections: 9
```

**Related commands** [protect \(Firewall\)](#)

# show firewall connections

**Overview** Use this command to show the connections currently being tracked by the firewall.

**Syntax** show firewall connections

**Mode** Privileged Exec

**Examples** To show the connections currently being tracked by the firewall, use the command:

```
awplus# show firewall connections
```

**Output** Figure 59-4: Example output from the **show firewall connections** command

```
awplus#show firewall connections
tcp ESTABLISHED src=192.168.1.2 dst=172.16.1.2 sport=58616
dport=23 packets=16
bytes=867 src=172.16.1.2 dst=172.16.1.1 sport=23 dport=58616
packets=11 bytes=636
[ASSURED]
icmpv6 src=2001:db8::2 dst=2001:db8::1 type=128 code=0 id=1416
packets=34
bytes=3536 src=2001:db8::1 dst=2001:db8::2 type=129 code=0 id=1416
packets=34
bytes=3536
tcp TIME_WAIT src=2001:db8:1::2 dst=2001:db8:2::2 sport=42532
dport=80 packets=7
bytes=597 src=2001:db8:2::2 dst=2001:db8:1::2 sport=80 dport=42532
packets=5
bytes=651 [ASSURED]
tcp TIME_WAIT src=2001:db8:1::2 dst=2001:db8:2::2 sport=48740
dport=80 packets=5
bytes=564 src=2001:db8:2::2 dst=2001:db8:1::2 sport=80 dport=48740
packets=5
bytes=594 [ASSURED]
```

**Related commands** [clear firewall connections](#)

# show firewall connections limits

**Overview** Use this command to show the configured firewall connection-limits for a given entity.

**Syntax** `show firewall connections limits`

**Mode** Privileged Exec

**Examples** To show the information about all the firewall connection limits, use the command:

```
awplus# show firewall connections limits
```

**Output** Figure 59-5: Example output from the **show firewall connections limits** command

```
awplus#show firewall connections limits
```

| ID | Entity | Limit | Hit Count |
|----|--------|-------|-----------|
| 10 | DMZ    | 100   | 42        |

**Related commands** [show firewall connections limits config-check](#)

# show firewall connections limits config-check

**Overview** Use this command to check configuration validity of firewall connection limits.

An invalid rule will not be active and cannot be hit. This command also shows the reasons why a limit configuration is not valid.

**Syntax** `show firewall connections limits config-check`

**Mode** Privileged Exec

**Usage** Firewall limits are applied to entities only. A limit is not valid if the source entity (zone) is not configured properly. This command checks if the entity exists at all, and if it does it also checks if the entity (zone) has a valid subnet.

**Examples** To check configuration validity of connection-limit rules, use the command:

```
awplus# show firewall connections limits
config-check
```

**Output** Figure 59-6: Example output from the **show firewall connections limits config-check** command on the console if rule configuration errors are detected. Connection-limit 10 uses an entity that exists; however no subnet has been specified. Connection-limit 20 uses an entity that doesn't exist.

```
awplus#show firewall connections limits config-check
Connection-limit 10:
 "From" entity has no subnet or host addresses
Connection-limit 20:
 "From" entity does not exist
```

**Output** Figure 59-7: Example output from the **show firewall connections limits config-check** command if all limit rules are valid

```
awplus#show firewall connection limits config-check
All rules are valid
```

**Related commands** [show firewall connections limits](#)

# show firewall rule

**Overview** Use this command to show information about firewall rules.

**Syntax** show firewall rule [<1-65535>]

| Parameter | Description |
|-----------|-------------|
| <1-65535> | Rule ID     |

**Mode** Privileged Exec

**Examples** To show information about all firewall rules, use the command:

```
awplus# show firewall rule
```

**Output** Figure 59-8: Example output from the **show firewall rule** command

```
awplus#show firewall rule

[* = Rule is not valid - see "show firewall rule config-check"]
 ID Action App From To
Hits

 10 permit ping public private
 0
 20 permit ping public dmz
 0
 40 permit ping private dmz
 0
 * 50 permit voice public private
 0
```

To show information about a specific firewall rule, use the command:

```
awplus# show firewall rule 10
```

**Output** Figure 59-9: Example output from the **show firewall rule** command

```
awplus#show firewall rule 10

[* = Rule is not valid - see "show firewall rule config-check"]
 ID Action App From To
Hits

 10 permit ping public private
 0
```

| Output Parameter | Description                                                                                                         |
|------------------|---------------------------------------------------------------------------------------------------------------------|
| *                | Indicates the rule is not valid and cannot be hit, see the <a href="#">show firewall rule config-check</a> command. |
| Action           | The rule action set by the <a href="#">rule (Firewall)</a> command.                                                 |
| App              | Application name.                                                                                                   |
| From             | Source entity.                                                                                                      |
| To               | Destination entity.                                                                                                 |
| Hits             | The number of times the firewall rule has been hit.                                                                 |

**Related commands** [rule \(Firewall\)](#)

# show firewall rule config-check

**Overview** Use this command to check configuration validity of firewall rules.  
An invalid rule will not be active and cannot be hit. This command also shows the reasons why a rule is not valid.

**Syntax** `show firewall rule config-check`

**Mode** Privileged Exec

**Usage** Firewall rules are applied to applications and entities. A rule is not valid if either the application, source entity or destination entity the rule applies to is not configured properly.

To configure applications and entities, see Application and Entity Commands.

**Examples** To check configuration validity of firewall rules, use the command:

```
awplus# show firewall rule config-check
```

**Output** Figure 59-10: Example output from the **show firewall rule config-check** command if rule configuration errors are detected

```
awplus#show firewall rule config-check
Rule 10:
 Application does not have a protocol configured
 "From" entity does not exist
 "To" entity has no subnet or host addresses
```

**Output** Figure 59-11: Example output from the **show firewall rule config-check** command if all rules are valid

```
awplus#show firewall rule config-check
All rules are valid
```

**Related commands** [rule \(Firewall\)](#)  
[show firewall rule](#)

# show debugging firewall

**Overview** Use this command to show the firewall and Network Address Translation (NAT) debugging status.

You can use the [debug firewall](#) command to enable firewall and NAT debugging.

For more information about NAT, see the [Firewall\\_and Network Address Translation \(NAT\) Feature Overview and Configuration\\_Guide](#).

**Syntax** `show debugging firewall`

**Mode** Privileged Exec

**Examples** To show the firewall and NAT debugging status, use the command:

```
awplus# show debugging firewall
```

**Output** Figure 59-12: Example output from the **show debugging firewall** command

```
awplus#show debugging firewall
Firewall Debugging Status: on
```

**Related commands** [debug firewall](#)



# show running-config firewall

**Overview** Use this command to show the configuration commands that have been used to configure the firewall.

**Syntax** `show running-config firewall`

**Mode** Privileged Exec

**Examples** To show the configuration commands that have been used to configure the firewall, use the command:

```
awplus# show running-config firewall
```

**Output** Figure 59-13: Example output from the **show running-config firewall** command

```
awplus#show running-config firewall
firewall
 rule 10 permit ping from public to private
 protect
!
```

# 60

# Application and Entity Commands

## Introduction

This chapter provides an alphabetical reference of commands used to configure application and entity. For more information, see the [Firewall\\_and Network Address Translation \(NAT\) Feature Overview and Configuration\\_Guide](#).

The table below lists the application commands and their applicable modes.

Figure 60-1: Application commands and applicable modes

| Mode                 | Command                              |
|----------------------|--------------------------------------|
| Privileged Exec      | <code>show application</code>        |
|                      | <code>show application detail</code> |
| Global Configuration | <code>application</code>             |
| Application Mode     | <code>protocol</code>                |
|                      | <code>icmp-type</code>               |
|                      | <code>icmp-code</code>               |
|                      | <code>sport</code>                   |
|                      | <code>dport</code>                   |

The table below lists the entity commands and their applicable modes.

Figure 60-2: Entity commands

| Mode                 | Command                       |
|----------------------|-------------------------------|
| Privileged Exec      | <code>show entity</code>      |
| Global Configuration | <code>zone</code>             |
| Zone Mode            | <code>network (Entity)</code> |

---

| Mode         | Command                            |
|--------------|------------------------------------|
| Network Mode | <code>ip subnet</code>             |
|              | <code>ipv6 subnet</code>           |
|              | <code>host (Entity)</code>         |
| Host Mode    | <code>ip address (Entity)</code>   |
|              | <code>ipv6 address (Entity)</code> |

- Command List**
- `"application"` on page 2652
  - `"dport"` on page 2654
  - `"dscp"` on page 2656
  - `"host (Entity)"` on page 2658
  - `"icmp-code"` on page 2660
  - `"icmp-type"` on page 2662
  - `"ip address (Entity)"` on page 2664
  - `"ip subnet"` on page 2666
  - `"ipv6 address (Entity)"` on page 2668
  - `"ipv6 subnet"` on page 2670
  - `"network (Entity)"` on page 2672
  - `"protocol"` on page 2674
  - `"show application"` on page 2676
  - `"show application detail"` on page 2677
  - `"show entity"` on page 2680
  - `"sport"` on page 2682
  - `"zone"` on page 2684

# application

**Overview** Use this command to create or modify a custom application.

Application is a high level abstraction of application packets being transported by network traffic. Traffic matching for applications can be achieved through the firewall by using several techniques, for example, matching packets to port numbers or searching for application signatures in flows of packets.

Use the **no** variant of this command to delete a custom application.

**Syntax** `application <application-name>`  
`no application <application-name>`

| Parameter                             | Description                                                                                                                                                                                                                                                                                                                                                 |
|---------------------------------------|-------------------------------------------------------------------------------------------------------------------------------------------------------------------------------------------------------------------------------------------------------------------------------------------------------------------------------------------------------------|
| <code>&lt;application-name&gt;</code> | Application name.<br>You can use all alphanumeric ASCII characters, and the dash (-) and underscore (_) characters. The name can be 1 to 64 characters long. The application name is case-sensitive. If you create two application names with the same spelling but one in upper case and the other one in lower case, the last overwrites the first entry. |

**Mode** Global Configuration

**Usage** This command allows you to enter the Application Mode with the prompt **awplus(config-application)#**. You can use this command to create a custom application or to configure an exiting application. You can configure source port, destination port, protocol, ICMP code and ICMP type for the application. Application is invalid if its protocol, source or destination are not properly configured, for example, application has no protocol configured, or, source and destination ports are applied to protocols that are not TCP, UDP or SCTP.

There are 40 predefined applications with protocols, source and destinations ports.

You can change the protocol, source and destination ports of the predefined applications. You can only delete the predefined application when you change either of its protocol, source or destination port.

Use the [show application](#) command to show all the custom and predefined applications.

**Examples** To create a custom application named `openVPN`, use the commands:

```
awplus# configure terminal
awplus(config)# application openVPN
awplus(config-application)#
```

To delete custom application openVPN, use the commands:

```
awplus# configure terminal
```

```
awplus(config)# no application openVPN
```

**Validation commands** show application

**Related commands** dport  
icmp-code  
icmp-type  
protocol  
sport

# dport

**Overview** Use this command to specify a destination port or port range for an application.

A port number is part of the addressing information used to identify a specific process to which a network message is to be forwarded between a sender and a receiver. For the full list of port numbers and their assignment, you can visit the Internet Assigned Numbers Authority (IANA) Web site: [www.iana.org](http://www.iana.org).

Use the **no** variant of this command to delete a port or a port range from an application. Note that

**NOTE:**

The port or port range that you want to delete must match exactly the existing port or port range. You cannot remove a port range that is part of an existing port range.

**Syntax** `dport {<destination-port>|any|<start-range> to <end-range>}`  
`no dport {<destination-port>|any|<start-range> to <end-range>}`

| Parameter                             | Description                                                                                     |
|---------------------------------------|-------------------------------------------------------------------------------------------------|
| <code>&lt;destination-port&gt;</code> | The destination port number, either TCP or UDP, specified as an integer in the range <1-65535>. |
| <code>any</code>                      | Any port number in the range <1-65535>. This equals to a range of 1 to 65535.                   |
| <code>&lt;start-range&gt;</code>      | Starting port number in the range <1-65535>.                                                    |
| <code>to &lt;end-range&gt;</code>     | Ending port number in the range <1-65535> or max.                                               |

**Mode** Application Mode

**Usage** You can create more than one destination port number or port range for an application.

**Examples** To specify destination port 13 for application `openVPN`, use the commands:

```
awplus# configure terminal
awplus(config)# application openVPN
awplus(config-application)# dport 13
```

To specify destination port 15 and port ranges for application `openVPN`, use the commands:

```
awplus# configure terminal
awplus(config)# application openVPN
awplus(config-application)# dport 15
awplus(config-application)# dport 30 to 37
awplus(config-application)# dport 50 to max
```

To specify destination port any, that is a port number range of <1-65535>, for application openVPN, use the commands:

```
awplus# configure terminal
awplus(config)# application openVPN
awplus(config-application)# dport any
```

To remove destination port 15 from application openVPN, use the commands:

```
awplus# configure terminal
awplus(config)# application openVPN
awplus(config-application)# no dport 15
```

To remove port any from application openVPN, use the commands:

```
awplus# configure terminal
awplus(config)# application openVPN
awplus(config-application)# no dport 1 to 65535
```

**Validation commands** [show application](#)

**Related commands** [application](#)  
[sport](#)

# dscp

**Overview** Use this command to specify one or more DSCP values used by an application.

Use the **no** variant of this command to remove one or more DSCP values from an application.

**Syntax** `dscp <dscp-list>`

`dscp {af11|af12|af13|af21|af22|af23|af31|af32|af33|af41|af42|af43|ef|be}`

`dscp {cs0|cs1|cs2|cs3|cs4|cs5|cs6|cs7}`

`no dscp`

`no dscp <dscp-list>`

`no dscp {af11|af12|af13|af21|af22|af23|af31|af32|af33|af41|af42|af43|ef|be}`

`no dscp {cs0|cs1|cs2|cs3|cs4|cs5|cs6|cs7}`

| Parameter                      | Description                                                                                                                                                                                                                                                                      |
|--------------------------------|----------------------------------------------------------------------------------------------------------------------------------------------------------------------------------------------------------------------------------------------------------------------------------|
| <code>&lt;dscp-list&gt;</code> | One or more DSCP values, in the range 0-63. Use spaces to separate values.                                                                                                                                                                                                       |
| <code>af11 ... be</code>       | One or more DSCP values specified according to the Assured Forwarding group, as defined in RFC 2597 and RFC 3260. See the table below for values. "ef" means expedited forwarding (DSCP 46) and "be" means best effort (DSCP 0). Voice traffic is typically given a value of ef. |
| <code>cs0 ... cs7</code>       | One or more DSCP values specified according to the Class Selector group. This is equivalent to TOS IP precedence values, so that CS0 is equivalent to an IP precedence value of 0, CS1 is equivalent to an IP precedence value of 1, and so on.                                  |

Table 60-1: Assured Forwarding (AF) behavior group

|                         | Class 1           | Class 2           | Class 3           | Class 4           |
|-------------------------|-------------------|-------------------|-------------------|-------------------|
| Low drop probability    | AF11<br>(DSCP 10) | AF21<br>(DSCP 18) | AF31<br>(DSCP 26) | AF41<br>(DSCP 34) |
| Medium drop probability | AF12<br>(DSCP 12) | AF22<br>(DSCP 20) | AF32<br>(DSCP 28) | AF42<br>(DSCP 36) |
| High drop probability   | AF13<br>(DSCP 14) | AF23<br>(DSCP 22) | AF33<br>(DSCP 30) | AF43<br>(DSCP 38) |

**Mode** Application Mode



**Usage** You can specify only one set of DSCP values for an application. The newly specified list will replace the existing one; it will not be added to the existing one.

**Example** To specify a DSCP of **ef** for the application named **voice**, use the commands:

```
awplus# configure terminal
awplus(config)# application voice
awplus(config-application)# dscp ef
```

To specify DSCPs of 12 and 13 for the application named **test**, use the commands:

```
awplus# configure terminal
awplus(config)# application test
awplus(config-application)# dscp 12 13
```

To remove DSCP12 from the application named **test**, use the commands:

```
awplus# configure terminal
awplus(config)# application test
awplus(config-application)# no dscp 12
```

To stop the application named **test** from using DSCP values, use the commands:

```
awplus# configure terminal
awplus(config)# application test
awplus(config-application)# no dscp
```

**Related  
Commands**

- [application](#)
- [show application](#)
- [show application detail](#)

# host (Entity)

**Overview** Use this command to add a host to a network entity or to configure an existing host.

Host is a high level abstraction of a single node in a network. This is commonly used if a particular device, for example a server, has a static IP address that needs to be specified in a firewall policy.

Use the **no** variant of this command to remove a host from a network entity.

**Syntax** `host <host-name>`  
`no host <host-name>`

| Parameter                      | Description                                                                                                                                              |
|--------------------------------|----------------------------------------------------------------------------------------------------------------------------------------------------------|
| <code>&lt;host-name&gt;</code> | Host name.<br>You can use all alphanumeric ASCII characters, and the dash (-) and underscore (_) characters. The name can be 1 to 64 characters in long. |

**Mode** Network Mode

**Usage** You can create multiple hosts for a network. A host entity is identified by its parent network using the dot notation, for example, `ZoneName.NetworkName.HostName`.

This commands allows you to enter the Host Mode with the prompt **awplus(config-host)#**. The Host Mode enables you to configure IPv4 address and IPv6 address for the host. For more information about host IPv4 address and IPv6 address, see [ip address \(Entity\)](#) command and [ipv6 address \(Entity\)](#) command respectively.

**Example** To create a host entity named `ftp` under network entity `servers`, use the commands:

```
awplus# configure terminal
awplus(config)# zone dmz
awplus(config-zone)# network servers
awplus(config-network)# host ftp
awplus(config-host)#
```

To remove host entity `ftp` and its IP address configuration from network entity `servers`, use the commands:

```
awplus# configure terminal
awplus(config)# zone dmz
awplus(config-zone)# network servers
awplus(config-network)# no host ftp
```

**Validation  
commands** show entity

**Related  
commands** ip address (Entity)  
ipv6 address (Entity)  
network (Entity)

# icmp-code

**Overview** Use this command to configure an ICMP message code for an application.

ICMP has many messages that are identified by a “type” field and many of these ICMP types have a “code” field. Use the `icmp-type` command to specify the ICMP type. For the full list of the ICMP code assignments, you can visit the Internet Assigned Numbers Authority (IANA) Web site: [www.iana.org](http://www.iana.org).

Use the **no** variant of this command to restore the ICMP message code to its default, which is any.

**Syntax** `icmp-code {<code-number>|any}`  
`no icmp-code`

| Parameter                        | Description                                                   |
|----------------------------------|---------------------------------------------------------------|
| <code>&lt;code-number&gt;</code> | Specify an ICMP message code number in the range of 0 to 255. |
| <code>any</code>                 | Any ICMP message code in the range of 0 to 255.               |

**Default** The default ICMP code number is any.

**Mode** Application Mode

**Usage** You should configure the ICMP code only for applications that use protocol ICMP. To configure the application protocol, see the `protocol` command.

You can specify only one ICMP message code for an application. The newly specified code will replace the previous one.

**Examples** To specify ICMP code 5 (redirect) for application `openVPN`, use the commands:

```
awplus# configure terminal
awplus(config)# application openVPN
awplus(config-application)# icmp-code 5
```

To specify ICMP code as any code for application `openVPN`, use the commands: To restore the ICMP message code to its default for application `openVPN`, use the commands:

```
awplus# configure terminal
awplus(config)# application openVPN
awplus(config-application)# icmp-code any
awplus# configure terminal
awplus(config)# application openVPN
awplus(config-application)# no icmp-code
```

**Validation commands** `show application`

**Related  
commands** [application](#)  
[icmp-type](#)  
[protocol](#)

# icmp-type

**Overview** Use this command to configure an ICMP message type for an application.

The ICMP protocol has many messages that are identified by a “type” field. For the full list of the ICMP type assignments, you can visit the Internet Assigned Numbers Authority (IANA) Web site: [www.iana.org](http://www.iana.org).

Use the **no** variant of this command to restore the ICMP message type its default, which is deny.

**Syntax** `icmp-type {<type-number>|any}`  
`no icmp-type`

| Parameter                        | Description                                                   |
|----------------------------------|---------------------------------------------------------------|
| <code>&lt;type-number&gt;</code> | Specify an ICMP message type number in the range of 0 to 255. |
| <code>any</code>                 | Any ICMP message type in the range of 0 to 255.               |

**Default** The default ICMP type is any.

**Mode** Application Mode

**Usage** You should configure the ICMP type only for applications that use protocol ICMP. To configure the application protocol, see the [protocol](#) command.

You can specify only one ICMP message type for an application. The newly specified type will replace the previous one.

**Examples** To specify ICMP message type 8 (echo) for application `openVPN`, use the commands:

```
awplus# configure terminal
awplus(config)# application openVPN
awplus(config-application)# icmp-type 8
```

To specify ICMP message type as any type for application `openVPN`, use the commands:

```
awplus# configure terminal
awplus(config)# application openVPN
awplus(config-application)# icmp-type any
```

To restore the ICMP message type to its default for application `openVPN`, use the commands:

```
awplus# configure terminal
awplus(config)# application openVPN
awplus(config-application)# no icmp-type
```

**Validation commands** [show application](#)

**Related commands** [application](#)  
[icmp-code](#)  
[network \(Entity\)](#)

# ip address (Entity)

**Overview** Use this command to assign an IPv4 address to a host entity.  
Use the **no** variant of this command to remove an IPv4 address from the host.

**Syntax**

```
ip address <ipv4-address>
ip address dynamic interface <interface_name>
no ip address <ipv4-address>
no ip address dynamic interface <interface_name>
```

| Parameter        | Description                                                   |
|------------------|---------------------------------------------------------------|
| <ipv4-address>   | The IPv4 address uses the format A.B.C.D.                     |
| dynamic          | Dynamic IP address, for example, obtained from a DHCP server. |
| <interface_name> | Interface to acquire IP addresses from.                       |

**Mode** Host Mode

**Usage** You can add multiple IP addresses to a host entity. If the IP address is not in the scope of any of its parent network's IPv4 subnets, a warning message will be given. Such an IP address is still acceptable because in the future the user may assign a network subnet that contains the host's IP address. Firewall policy rules will not apply to an IP address that is not in at least one of the network's subnets.

**Examples** To add an IP address to host ftp, use the commands:

```
awplus# configure terminal
awplus(config)# zone dmz
awplus(config-zone)# network servers
awplus(config-network)# ip subnet 192.168.1.0/24
awplus(config-network)# host ftp
awplus(config-host)# ip address 192.168.1.5
```

To add multiple IP addresses to host ftp, use the commands:

```
awplus# configure terminal
awplus(config)# zone dmz
awplus(config-zone)# network servers
awplus(config-network)# ip subnet 192.168.1.0/24
awplus(config-network)# host ftp
awplus(config-host)# ip address 192.168.1.8
awplus(config-host)# ip address 192.168.1.9
awplus(config-host)# ip address 192.168.1.10
```



To remove an IP address from host ftp, use the commands:

```
awplus# configure terminal
awplus(config)# zone dmz
awplus(config-zone)# network servers
awplus(config-network)# host ftp
awplus(config-host)# no ip address 192.168.1.5
```

**Validation  
commands** [show entity](#)

**Related  
commands** [host \(Entity\)](#)

# ip subnet

**Overview** Use this command to add an IPv4 subnet to a network entity.  
Use the **no** variant of this command to remove a subnet from a network entity.

**Syntax** `ip subnet <ip-network/m> [interface <interface-name>]`  
`no ip subnet <ip-network/m> [interface <interface-name>]`

| Parameter                           | Description                                                                                                                                                                                                      |
|-------------------------------------|------------------------------------------------------------------------------------------------------------------------------------------------------------------------------------------------------------------|
| <code>&lt;ip-network/m&gt;</code>   | IP address of the network, entered in the form A.B.C.D/M. Dotted decimal notation followed by a forward slash, and then the subnet mask length.                                                                  |
| <code>interface</code>              | Specify an interface name. An interface may be specified to add a further restriction on the subnet. No interface configured indicates that any matching address from any interface is a member of this network. |
| <code>&lt;interface-name&gt;</code> | Interface name. Any AlliedWare Plus interface type (eth, vlan, ppp, tunnel, lo and so on). A warning message is given if the interface does not match an existing interface on the device.                       |

**Mode** Network Mode

**Usage** You can create multiple subnets to a network entity.

**Examples** To add a subnet to network `servers`, use the commands:

```
awplus# configure terminal
awplus(config)# zone dmz
awplus(config-zone)# network servers
awplus(config-network)# ip subnet 192.168.2.0/24
```

To add a subnet and an interface to network `servers`, use the commands:

```
awplus# configure terminal
awplus(config)# zone dmz
awplus(config-zone)# network servers
awplus(config-network)# ip subnet 192.168.2.0/24 interface eth1
```

To add multiple subnets to network servers, use the commands:

```
awplus# configure terminal
awplus(config)# zone dmz
awplus(config-zone)# network servers
awplus(config-network)# ip subnet 192.168.2.0/24 interface eth1
awplus(config-network)# ip subnet 10.1.0.0/16 interface eth1
```

To remove a subnet from network servers, use the commands:

```
awplus# configure terminal
awplus(config)# zone dmz
awplus(config-zone)# network servers
awplus(config-network)# no ip subnet 192.168.2.0/24
```

**Validation commands** [show entity](#)

**Related commands** [network \(Entity\)](#)

# ipv6 address (Entity)

**Overview** Use this command to assign an IPv6 address to a host entity.  
Use the **no** variant of this command to remove an IPv6 address from an host entity.

**Syntax** `ipv6 address <ipv6-address>`  
`ipv6 address dynamic interface <interface_name>`  
`no ipv6 address <ipv6-address>`  
`no ipv6 address dynamic interface <interface_name>`

| Parameter                           | Description                                                     |
|-------------------------------------|-----------------------------------------------------------------|
| <code>&lt;ipv6-address&gt;</code>   | The IPv6 address in the format x:x::x:x.                        |
| <code>dynamic</code>                | Dynamic IPv6 address, for example, obtained from a DHCP server. |
| <code>&lt;interface_name&gt;</code> | Interface to acquire IP addresses from.                         |

**Mode** Host Mode

**Usage** You can add multiple IPv6 addresses to a host entity. If the IPv6 address is not in the scope of any of its parent network's IPv6 subnets, a warning message will be given. Such an IP address is still acceptable because in the future the user may assign a network subnet that contains the host's IPv6 address. Firewall policy rules will not apply to an IPv6 address that is not in at least one of the network's subnets.

**Examples** To add an IPv6 address to host `web-server`, use the commands:

```
awplus# configure terminal
awplus(config)# zone dmz
awplus(config-zone)# network servers
awplus(config-network)# ipv6 subnet 2001:db8:24:100::/64
awplus(config-network)# host web-server
awplus(config-host)# ipv6 address 2001:db8:24:100::1
```

To add multiple IP addresses to host `web-server`, use the commands:

```
awplus# configure terminal
awplus(config)# zone dmz
awplus(config-zone)# network servers
awplus(config-network)# ipv6 subnet 2001:db8:24:100::/64
awplus(config-network)# host web-server
awplus(config-host)# ipv6 address 2001:db8:24:100::2
awplus(config-host)# ipv6 address 2001:db8:24:100::3
awplus(config-host)# ipv6 address 2001:db8:24:100::4
```

To remove an IPv6 address from host `web-server`, use the commands:

```
awplus# configure terminal
awplus(config)# zone dmz
awplus(config-zone)# network servers
awplus(config-network)# host web-server
awplus(config-host)# no ipv6 address 2001:db8:24:100::2
```

**Validation  
commands** [show entity](#)

**Related  
commands** [host \(Entity\)](#)

# ipv6 subnet

**Overview** Use this command to assign an IPv6 subnet to a network entity.  
Use the **no** variant of this command to remove a IPv6 subnet from a network entity.

**Syntax** `ipv6 subnet <ip-network/m> [interface <interface-name>]`  
`no ipv6 subnet <ip-network/m> [interface <interface-name>]`

| Parameter                           | Description                                                                                                                                                                                                              |
|-------------------------------------|--------------------------------------------------------------------------------------------------------------------------------------------------------------------------------------------------------------------------|
| <code>&lt;ip-network/m&gt;</code>   | IPv6 address of the network, entered in the form X:X::X/M, followed by the prefix length in slash notation.                                                                                                              |
| <code>interface</code>              | Specify an interface name. An interface may be specified to add a further restriction on the subnet. No interface configured indicates that any matching address from any interface is a member of this network.         |
| <code>&lt;interface-name&gt;</code> | Interface name. Any AlliedWare Plus interface type (eth, vlan, ppp, tunnel, lo and so on.) followed by any character.<br>A warning message is given if the interface does not match an existing interface on the device. |

**Mode** Network Mode

**Usage** You can create multiple subnets for a network entity.

**Examples** To add a subnet to network `servers`, use the commands:

```
awplus# configure terminal
awplus(config)# zone dmz
awplus(config-zone)# network servers
awplus(config-network)# ipv6 subnet 2001:db8::/32
```

To add a subnet and an interface to network `servers`, use the commands:

```
awplus# configure terminal
awplus(config)# zone dmz
awplus(config-zone)# network servers
awplus(config-network)# ipv6 subnet 2001:db8::/32 interface
eth1
```

To add multiple subnets to network servers, use the commands:

```
awplus# configure terminal
awplus(config)# zone dmz
awplus(config-zone)# network servers
awplus(config-network)# ipv6 subnet 2001:db8::7/32 interface
eth1
awplus(config-network)# ipv6 subnet 2001:db8::8/32 interface
eth1
```

To remove a subnet from network servers, use the commands:

```
awplus# configure terminal
awplus(config)# zone dmz
awplus(config-zone)# network servers
awplus(config-network)# no ipv6 subnet 2001:db8::/32
```

**Validation commands** [show entity](#)

**Related commands** [network \(Entity\)](#)

# network (Entity)

**Overview** Use this command to add a network to a zone entity or configure an existing network.

A network is a high level abstraction of a logical network in a zone. This consists of the IP subnets and interfaces over which it is reachable. Subnets are grouped into networks to apply a common set of rules among the subnets.

Use the **no** variant of this command to destroy a network entity.

**Syntax** `network <network-name>`  
`no network <network-name>`

| Parameter                         | Description                                                                                                                                                 |
|-----------------------------------|-------------------------------------------------------------------------------------------------------------------------------------------------------------|
| <code>&lt;network-name&gt;</code> | Network name.<br>You can use all alphanumeric ASCII characters, and the dash (-) and underscore (_) characters. The name can be 1 to 64 characters in long. |

**Mode** Zone Mode

**Usage** A network is a member of a zone. You can create multiple networks in a zone. A network entity is identified with its parent zone using the dot notation, for example, ZoneName.NetworkName.

This commands allows you to enter the Network Mode with the prompt **awplus(config-network)#**. In the Network Mode, you can:

- Configure subnets and interfaces for the network entity
- Create and delete host entities in the network

A network must have at least one valid network address for it to result in functioning rules using that network entity. For more information about how to add network address, see the [ip subnet](#) command and the [ipv6 subnet](#) command.

Note that if the network entity is destroyed, the subnets and hosts in the network entity will be destroyed as well.

**Example** To create a network entity named `servers`, use the commands:

```
awplus# configure terminal
awplus(config)# zone dmz
awplus(config-zone)# network servers
awplus(config-network)#
```



To destroy a network entity named `servers`, use the commands:

```
awplus# configure terminal
awplus(config)# zone dmz
awplus(config-zone)# no network servers
```

**Validation  
commands** `show entity`

**Related  
commands** `host (Entity)`  
`ip subnet`  
`ipv6 subnet`  
`zone`

# protocol

**Overview** Use this command to specify a protocol used by an application.

Protocol numbers are used to configure firewalls, routers, and proxy servers. The protocol number is in the protocol field of the IPv4 header and the next header field of IPv6 header. For the full list of the IP Protocol assignments, you can visit the Internet Assigned Numbers Authority (IANA) Web site: [www.iana.org](http://www.iana.org).

Use the **no** variant of this command to unset the protocol in an application.

**Syntax** `protocol {tcp|udp|icmp|ipv6-icmp|<protocol-number>}`  
`no protocol`

| Parameter         | Description                                                                                   |
|-------------------|-----------------------------------------------------------------------------------------------|
| tcp               | Transmission Control Protocol. The protocol number is 6.                                      |
| udp               | User Datagram Protocol. The protocol number is 17.                                            |
| icmp              | Internet Control Message Protocol for Internet Protocol version 4. The protocol number is 1.  |
| ipv6-icmp         | Internet Control Message Protocol for Internet Protocol version 6. The protocol number is 58. |
| <protocol-number> | Protocol number in the range of 0 to 255.                                                     |

**Mode** Application Mode

**Usage** You can specify only one protocol for an application. The newly specified protocol will replace the previous one.

**Examples** To specify protocol `tcp` for application `openVPN`, use the commands:

```
awplus# configure terminal
awplus(config)# application openVPN
awplus(config-application)# protocol tcp
```

To specify protocol `udp` for application `openVPN`, use the commands:

```
awplus# configure terminal
awplus(config)# application openVPN
awplus(config-application)# protocol udp
```

To specify protocol `icmp` for application `openVPN`, use the commands:

```
awplus# configure terminal
awplus(config)# application openVPN
awplus(config-application)# protocol icmp
```

To specify protocol 41 (IPv6) for application openVPN, use the commands:

```
awplus# configure terminal
awplus(config)# application openVPN
awplus(config-application)# protocol 41
```

To unset the protocol in application openVPN, use the commands:

```
awplus# configure terminal
awplus(config)# application openVPN
awplus(config-application)# no protocol
```

**Validation commands** [show application](#)

**Related commands** [application](#)

# show application

**Overview** Use this command to show the custom and predefined applications currently configured.

You can use the [show application detail](#) command to show detailed information of the applications.

**Syntax** `show application`

**Mode** Privileged Exec

**Examples** To show all applications currently configured, use the command:

```
awplus# show application
```

**Output** Figure 60-3: Example output from **show application**

```
awplus#show application
aim cvs dns ftp http https icq
ident
imap imaps irc jabber l2tp ldap lisa
msn
mysql news nfs-tcp nfs-udp ntp openvpn
pcanywhere-tcp

pcanywhere

-
udp
ping pop3 pop3s pptp rdp rsync
samba-tcp
samba-udp
smtp socks ssh syslog telnet traceroute
 vnc
whois
```

**Related commands** [show application detail](#)

# show application detail

**Overview** Use this command to show detailed information about custom and predefined applications currently configured. The protocol, destination port, source port, ICMP code, ICMP type, DSCP and the name of the applications will be displayed.

**Syntax** `show application detail [<name>|custom|dpi]`

| Parameter | Description                                                                                                                                                                           |
|-----------|---------------------------------------------------------------------------------------------------------------------------------------------------------------------------------------|
| <name>    | The name of a specific application.                                                                                                                                                   |
| custom    | User-defined application.                                                                                                                                                             |
| dpi       | DPI applications. You need to use the <a href="#">enable (DPI)</a> command and the <a href="#">provider procera</a> command to enable DPI. Otherwise, DPI applications will not show. |

**Mode** Privileged Exec

**Examples** To show the information about all applications, use the command:

```
awplus# show application detail
```

**Output** Figure 60-4: Example output from **show application detail**

```
awplus#show application detail
```

| Name           | Protocol | Detail                                    |
|----------------|----------|-------------------------------------------|
| aim            | TCP      | sport=1024-65535 dport=9898               |
| cvs            | TCP      | sport=1024-65535 dport=2401               |
| dns            | UDP      | sport=1024-65535 dport=53                 |
| ftp            | TCP      | sport=1024-65535 dport=21                 |
| http           | TCP      | sport=1024-65535 dport=80                 |
| https          | TCP      | sport=1024-65535 dport=443                |
| icq            | TCP      | sport=1024-65535 dport=5190               |
| ident          | TCP      | sport=1024-65535 dport=113                |
| imap           | TCP      | sport=1024-65535 dport=143                |
| imaps          | TCP      | sport=1024-65535 dport=993                |
| irc            | TCP      | sport=1024-65535 dport=6667               |
| jabber         | TCP      | sport=1024-65535 dport=5222-5223          |
| l2tp           | UDP      | sport=1701 dport=1701                     |
| ldap           | TCP      | sport=1024-65535 dport=389                |
| lisa           | TCP      | sport=1024-65535 dport=7741               |
| msn            | TCP      | sport=1024-65535 dport=1863               |
| mysql          | TCP      | sport=1024-65535 dport=3306               |
| news           | TCP      | sport=1024-65535 dport=119                |
| nfs-tcp        | TCP      | sport=1024-65535 dport=2049               |
| nfs-udp        | UDP      | sport=1024-65535 dport=2049               |
| ntp            | UDP      | sport=123,1024-65535 dport=123            |
| openvpn        | UDP      | sport=1024-65535 dport=1194               |
| pcanywhere-tcp | TCP      | sport=1024-65535 dport=5631               |
| pcanywhere-udp | UDP      | sport=1024-65535 dport=5631-5632          |
| ping           | ICMP     | type=8 code=0                             |
| pop3           | TCP      | sport=1024-65535 dport=110                |
| pop3s          | TCP      | sport=1024-65535 dport=995                |
| pptp           | TCP      | sport=1024-65535 dport=1723               |
| rdp            | TCP      | sport=1024-65535 dport=3389               |
| rsync          | TCP      | sport=1024-65535 dport=873                |
| samba-tcp      | TCP      | sport=1024-65535 dport=139,445            |
| samba-udp      | UDP      | sport=137-138,1024-65535<br>dport=137-138 |
| smtp           | TCP      | sport=1024-65535 dport=25                 |
| socks          | TCP      | sport=1024-65535 dport=1080               |
| ssh            | TCP      | sport=1024-65535 dport=22                 |
| syslog         | UDP      | sport=1024-65535 dport=514                |
| telnet         | TCP      | sport=1024-65535 dport=23                 |
| traceroute     | UDP      | sport=1024-65535 dport=33434-33523        |
| vnc            | TCP      | sport=1024-65535 dport=5900               |
| whois          | TCP      | sport=1024-65535 dport=43                 |

To show the information about the application ping, use the command:

```
awplus# show application detail ping
```

**Output** Figure 60-5: Example output from **show application detail** for a particular application

```
awplus#show application detail ping
Name Protocol Detail

ping ICMP type=8 code=0
```

**Related Commands** [show application](#)

# show entity

**Overview** Use this command to show entity information.

Entity is a high level abstraction of a network device, a group of networks or subnets. It is the instance that firewall policy can be applied to. There are three types of entity:

- zone
- network
- host

**Syntax** `show entity [<entity>]`

| Parameter | Description                      |
|-----------|----------------------------------|
| <entity>  | Specific entity in dot notation. |

**Mode** Privileged Exec

**Examples** To show the information about all entities, use the command:

```
awplus# show entity
```

**Output** Figure 60-6: Example output from the **show entity** command

```
awplus#show entity
Zone: zone1
Network: zone1.network1
Subnet: 1:db8:24:100::/64
Subnet: 2001:db8:24:100::/64
Host: zone1.network1.host1
Address: 2001:db8:24:100::1

Zone: zone2
Network: zone2.network2
Host: zone2.network2.host1
```

To show information associated with the network entity `zone1.network1`, use the command:

```
awplus# show entity zone1.network1
```



**Output** Figure 60-7: Example output from the **show entity** command

```
awplus#show entity zone1.network1
Network: zone1.network1
Subnet: 1:db8:24:100::/64
Subnet: 2001:db8:24:100::/64
Host: zone1.network1.host1
Address: 2001:db8:24:100::1
```

To show information associated with the host entity `zone1.network1.host1`, use the command:

```
awplus# show entity zone1.network1.host1
```

**Output** Figure 60-8: Example output from the **show entity** command

```
awplus#show entity zone1.network1.host1
Host: zone1.network1.host1
Address: 192.168.1.5
```

# sport

**Overview** Use this command to specify a source port or a port range used for an application.

A port number is part of the addressing information used to identify a specific process to which a network message is to be forwarded between a sender and a receiver. For the full list of port numbers and their assignment, you can visit the Internet Assigned Numbers Authority (IANA) Web site: [www.iana.org](http://www.iana.org).

Use the **no** variant of this command to delete ports or port ranges from an application.

**NOTE:**

The port or port range that you want to delete must match exactly the existing port or port range. You cannot remove a port range that is part of an existing port range.

**Syntax** `sport {<source-port>|any|<start-range> to <end-range>}`  
`no sport {<source-port>|any|<start-range> to <end-range>}`

| Parameter                                         | Description                                                                                       |
|---------------------------------------------------|---------------------------------------------------------------------------------------------------|
| <code>&lt;source-port&gt;</code>                  | The source port number, either TCP or UDP, specified as an integer between 1 and 65535.           |
| <code>any</code>                                  | Any port number in the range <code>&lt;1-65535&gt;</code> . This equals to a range of 1 to 65535. |
| <code>&lt;start-range&gt;</code>                  | Starting port number in the range <code>&lt;1-65535&gt;</code> .                                  |
| <code>to</code><br><code>&lt;end-range&gt;</code> | Ending port number in the range <code>&lt;1-65535&gt;</code> or max.                              |

**Mode** Application Mode

**Usage** You can create more than one source port number or port range for an application.

**Examples** To specify source port 13 for application `openVPN`, use the commands:

```
awplus# configure terminal
awplus(config)# application openVPN
awplus(config-application)# sport 13
```

To specify source port 15 and port ranges for application `openVPN`, use the commands:

```
awplus# configure terminal
awplus(config)# application openVPN
awplus(config-application)# sport 15
awplus(config-application)# sport 30 to 37
awplus(config-application)# sport 50 to 80
```

To specify source port any, that is a port number range of <1-65535>, for application openVPN, use the commands:

```
awplus# configure terminal
awplus(config)# application openVPN
awplus(config-application)# sport any
```

To remove source port 15 from application openVPN, use the commands:

```
awplus# configure terminal
awplus(config)# application openVPN
awplus(config-application)# no sport 15
```

To remove port any from application openVPN, use the commands:

```
awplus# configure terminal
awplus(config)# application openVPN
awplus(config-application)# no sport 1 to 65535
```

**Validation commands** [show application](#)

**Related commands** [application](#)  
[dport](#)

# zone

**Overview** Use this command to create a zone entity or configure an existing zone.

Zone is a high level abstraction for a logical grouping or segmentation of physical networks. This is the highest level of partitioning that firewall policy can be applied to. Zone establishes the security border of your networks. A zone defines a boundary where traffic is subjected to policy restrictions as it crosses to another region of your networks. The minimum zones normally implemented would be a trusted zone for the private network behind the firewall and a untrusted zone for the Internet. Other common zones are a Demilitarized Zone (DMZ) for publicly visible web servers and a Virtual Private Network (VPN) zone for remote access users or tunnels to other networks.

Use the **no** variant of this command to destroy a zone entity.

**Syntax** `zone <zone-name>`  
`no zone <zone-name>`

| Parameter                      | Description                                                                                                                                           |
|--------------------------------|-------------------------------------------------------------------------------------------------------------------------------------------------------|
| <code>&lt;zone-name&gt;</code> | Zone name.<br>You can use all alphanumeric ASCII characters, and the dash (-) and underscore (_) characters. The name can be 1 to 64 characters long. |

**Mode** Global Configuration

**Usage** This command allows you to enter the Zone Mode with the prompt **awplus(config-category)#**. The Zone Mode enables you to create, configure and delete network entities. For more information about network entity, see the [network \(Entity\)](#) command.

A zone entity must have at least one network entity for it to result in functioning rules using that zone entity. For more information about how to add network entities, see the [network \(Entity\)](#) command.

Note that if the zone entity is destroyed, the networks and hosts of this zone will be destroyed as well.

**Examples** To create a zone named `private`, use the commands:

```
awplus# configure terminal
awplus(config)# zone private
awplus(config-zone)#
```

To destroy zone `private` and all its networks, subnets and hosts, use the commands:

```
awplus# configure terminal
awplus(config)# no zone private
```

**Validation** show entity  
**commands**

# 61

# NAT Commands

## Introduction

This chapter provides an alphabetical reference of commands used to configure Network Address Translation (NAT). For more information about NAT introduction and configuration example, see the [Firewall\\_and Network Address Translation \(NAT\) Feature Overview and Configuration\\_Guide](#).

The following figure lists the NAT commands and their applicable modes.

Figure 61-1: NAT commands and applicable modes

| Mode                 | Command                                 |
|----------------------|-----------------------------------------|
| Privileged Exec      | <code>show nat</code>                   |
|                      | <code>show nat rule</code>              |
|                      | <code>show nat rule config-check</code> |
|                      | <code>show running-config nat</code>    |
| Global Configuration | <code>nat</code>                        |
| NAT Configuration    | <code>enable (NAT)</code>               |
|                      | <code>move rule (NAT)</code>            |
|                      | <code>rule (NAT)</code>                 |

- Command List**
- [“enable \(NAT\)”](#) on page 2688
  - [“ip limited-local-proxy-arp”](#) on page 2689
  - [“local-proxy-arp”](#) on page 2691
  - [“move rule \(NAT\)”](#) on page 2692
  - [“nat”](#) on page 2693
  - [“rule \(NAT\)”](#) on page 2694

- [“show nat”](#) on page 2698
- [“show nat rule”](#) on page 2699
- [“show nat rule config-check”](#) on page 2701
- [“show running-config nat”](#) on page 2702

# enable (NAT)

**Overview** Use this command to enable NAT .

Use the **no** variant of this command to disable NAT without losing existing NAT configuration.

**Syntax** enable  
no enable

**Default** NAT is disabled by default.

**Mode** NAT Configuration

**Examples** To enable NAT, use the commands:

```
awplus# configure terminal
awplus(config)# nat
awplus(config-nat)# enable
```

To disable NAT, use the commands:

```
awplus# configure terminal
awplus(config)# nat
awplus(config-nat)# no enable
```

**Validation commands** show nat  
show running-config nat



# ip limited-local-proxy-arp

**Overview** Use this command to enable local proxy ARP, but only for a specified set of IP addresses. This makes the device respond to ARP requests for those IP addresses when the addresses are reachable via the interface you are configuring.

To specify the IP addresses, use the command [local-proxy-arp](#).

Use the **no** variant of this command to disable limited local proxy ARP. This stops your device from intercepting and responding to ARP requests for the specified hosts. This allows the hosts to use MAC address resolution to communicate directly with one another.

**Syntax** `ip limited-local-proxy-arp`  
`no ip limited-local-proxy-arp`

**Default** Limited local proxy ARP is disabled by default.

**Mode** Interface Configuration

**Usage** Limited local proxy ARP supports Static NAT configurations in which the NAT configuration's public address is different to the ethernet interface's address.

On such ethernet interfaces, the device needs to respond to ARP requests for the public address so that it will receive packets targeted at that address.

Limited local proxy ARP makes this possible. It is especially useful when you have a number of 1-1 NAT configurations and each public address falls within the public interface's subnet. If you enable limited local proxy ARP on the public interface and specify suitable addresses, the device will respond to ARP requests for those addresses, as long as the addresses are routed out the interface the ARP requests are received on. The device responds with its own MAC address.

**Example** The following configuration snippet shows how to use limited local proxy ARP, if you are using NAT for an HTTP server with an address of 172.22.0.3 connected via eth1, and eth1 has an address of 172.22.0.1:

```
! Create a private zone for the HTTP server with address 172.22.200.3:
zone private
network vlan1
ip subnet 172.22.200.0/24
host http_server
ip address 172.22.200.3
!
! Create a public zone for the HTTP server with address 172.22.0.3:
zone public
network eth1
ip subnet 0.0.0.0/0 interface eth1
host http_server
ip address 172.22.0.3
!
! Create a NAT rule to map from the public to the private zone:
nat
rule 10 portfwd http from public.eth1 to public.eth1.http_server with dst
private.vlan1.http_server
enable
!
! Configure eth1. It has a different public address than the HTTP server:
interface eth1
ip limited local-proxy-arp
ip address 172.22.0.1/24
!
! Configure vlan1:
interface vlan1
ip address 172.22.200.5/24
!
! Tell the device to respond to ARPs for the HTTP server public address:
local-proxy-arp 172.22.0.3/32
```

**Related** [ip local-proxy-arp](#)  
**Commands** [local-proxy-arp](#)

# local-proxy-arp

**Overview** Use this command to specify an IP subnet for use with limited local proxy ARP. When limited local proxy ARP is enabled with the command `ip limited-local-proxy-arp`, the device will respond to ARP requests for addresses in that subnet.

Use the **no** variant of this command to stop specifying a subnet for use with limited local proxy ARP.

**Syntax** `local-proxy-arp [<ip-add/mask>]`  
`no local-proxy-arp [<ip-add/mask>]`

| Parameter                        | Description                                                                                                                                 |
|----------------------------------|---------------------------------------------------------------------------------------------------------------------------------------------|
| <code>&lt;ip-add/mask&gt;</code> | The IP subnet to use with limited local proxy ARP, in dotted decimal format (A.B.C.D/M). To specify a single IP address, use a 32-bit mask. |

**Default** No subnets are specified for use with limited local proxy ARP.

**Mode** Global Configuration

**Example** To specify limited local proxy ARP for the address 172.22.0.3, use the following commands:

```
awplus# configure terminal
awplus(config)# local-proxy-arp 172.22.0.3/32
```

This is part of a configuration snippet that shows how to use limited local proxy ARP with static NAT. See the command `ip limited-local-proxy-arp` for the whole example.

**Related Commands** [ip limited-local-proxy-arp](#)

# move rule (NAT)

**Overview** Use this command to change the order of a NAT rule.

You can move an existing rule ID only to an ID that is not assigned to any rule, otherwise you will receive an error message.

**Syntax** `move rule <1-65535> to <1-65535>`

| Parameter                                  | Description                                                                                                                                                                                                                             |
|--------------------------------------------|-----------------------------------------------------------------------------------------------------------------------------------------------------------------------------------------------------------------------------------------|
| <code>move rule<br/>&lt;1-65535&gt;</code> | Move the order of a given rule. The rule ID of the given rule must exist.<br>Each rule has an ID which is either designated by the user or automatically generated when the rule is created. The rule ID is an integer from 1 to 65535. |
| <code>to &lt;1-65535&gt;</code>            | New rule ID to assign. The new rule ID must not be used by any existing rule.                                                                                                                                                           |

**Mode** NAT Configuration

**Examples** To change the ID of a rule from 10 to 30, use the commands:

```
awplus# configure terminal
awplus(config)# nat
awplus(config-nat)# move rule 10 to 30
```

**Validation commands** `show nat rule`  
`show running-config nat`

**Related commands** `rule (NAT)`

# nat

**Overview** Use this command to configure NAT.

Use the **no** variant of this command to remove all NAT configuration.

**Syntax** nat  
no nat

**Mode** Global Configuration

**Usage** This command allows you to enter the NAT Configuration mode. The command prompt for this mode is **awplus(config-nat)#**.

In the NAT Configuration mode, you can:

- Enable NAT, see the [enable \(NAT\)](#) command.
- Create NAT rules or change the order of NAT rules, see the [rule \(NAT\)](#) command and the [move rule \(NAT\)](#) command.

**Examples** To configure NAT, use the commands:

```
awplus# configure terminal
awplus(config)# nat
awplus(config-nat)#
```

To remove all NAT configuration, use the commands:

```
awplus# configure terminal
awplus(config)# no nat
```

**Validation commands** [show nat](#)

# rule (NAT)

**Overview** Use this command to create a NAT rule.

Use the **no** variant of this command to remove a specified rule or all rules.

**Syntax**

```
rule [<1-65535>] masq <application-name> from <source-entity>
to <destination-entity> [with src <source-host-entity>]

rule [<1-65535>] portfw <application-name> from <source-entity>
[to <destination-entity>] with dst <destination-host-entity>
[dport <1-65535>]

rule [<1-65535>] netmap <application-name> from
<source-subnet-entity> to <destination-subnet-entity> with
{src|dst} <translated-subnet-entity>

no rule {<1-65535>|all}
```

| Parameter          | Description                                                                                                                                                                                                                                                               |
|--------------------|---------------------------------------------------------------------------------------------------------------------------------------------------------------------------------------------------------------------------------------------------------------------------|
| <1-65535>          | Rule ID is an integer in the range 1 to 65535. If you do not designate a rule ID, a rule ID will be automatically generated and it will be greater than the current highest rule ID.                                                                                      |
| masq               | The type of NAT rule. NAT with IP Masquerade is a case where all or a range of addresses are mapped to a single address with source port translation to identify the association. This single address masquerades as the public source address for the private addresses. |
| portfw             | The type of NAT rule. Port forwarding allows remote hosts to connect to a specific host or service within a private LAN. This will forward IPv4 packets on to another device, for example, forward HTTP traffic to an internal web server.                                |
| netmap             | The type of NAT rule. Use subnet-based NAT to translate the subnet portion of IP addresses while leaving the host portion unchanged.                                                                                                                                      |
| <application-name> | In all NAT rules, the application name, either one of the predefined applications or an application defined by using the <b>application</b> command.                                                                                                                      |

| Parameter                                      | Description                                                                                                                                                                                                                                                                                                                                                                                                                                                                                                                                                                                                                                                                                                                                             |
|------------------------------------------------|---------------------------------------------------------------------------------------------------------------------------------------------------------------------------------------------------------------------------------------------------------------------------------------------------------------------------------------------------------------------------------------------------------------------------------------------------------------------------------------------------------------------------------------------------------------------------------------------------------------------------------------------------------------------------------------------------------------------------------------------------------|
| <code>&lt;source-entity&gt;</code>             | Source entity name. An entity represents a logical grouping of subnets, hosts or interfaces, created by the <b>zone</b> , <b>network (Entity)</b> , or <b>host (Entity)</b> commands. In a <b>masq</b> rule, the source entity defines the private side of the router. You assign private IP addresses (RFC 1918) to hosts on the private side of the router. When those hosts send traffic, the router translates the private addresses to one or more publicly valid addresses before routing the traffic. When the router receives traffic that is destined for those hosts, it translates the public addresses back to the appropriate private addresses. In a <b>portfw</b> rule, the source entity may be an entity outside your private network. |
| <code>&lt;destination-entity&gt;</code>        | The destination entity name. The destination entity defines the pool of public-valid IP addresses. It can be a zone (created by the <b>zone</b> command), network ( <b>network (Entity)</b> command) or host ( <b>host (Entity)</b> command).                                                                                                                                                                                                                                                                                                                                                                                                                                                                                                           |
| <code>&lt;source-host-entity&gt;</code>        | In a <b>masq</b> rule, the specific source host address that the traffic will masquerade as. The source -host-entity must be a host with one IP address, created by using the <b>host (Entity)</b> command.                                                                                                                                                                                                                                                                                                                                                                                                                                                                                                                                             |
| <code>&lt;destination-host-entity&gt;</code>   | In a <b>portfw</b> rule, the target entity name of the specific destination host that the traffic will be port-forwarded to. The target entity must be a host with one IP address, created by using the <b>host (Entity)</b> command.                                                                                                                                                                                                                                                                                                                                                                                                                                                                                                                   |
| <code>dport &lt;1-65535&gt;</code>             | In a <b>portfw</b> rule, modify the destination port to the specified port. (Only for protocols that have ports.)                                                                                                                                                                                                                                                                                                                                                                                                                                                                                                                                                                                                                                       |
| <code>&lt;source-subnet-entity&gt;</code>      | The source entity that the netmap rule will apply to, for instance a network created by the <b>network (Entity)</b> command. When the <b>with src</b> parameter is used, this source-subnet-entity is translated to the <code>&lt;translated-subnet-entity&gt;</code> specified.                                                                                                                                                                                                                                                                                                                                                                                                                                                                        |
| <code>&lt;destination-subnet-entity&gt;</code> | The destination entity that the <b>netmap</b> rule applies to, for instance a network created by the <b>network (Entity)</b> command. When the <b>with dst</b> parameter is used, this destination subnet is translated to the <code>&lt;translated-subnet-entity&gt;</code> specified.                                                                                                                                                                                                                                                                                                                                                                                                                                                                 |

| Parameter                                     | Description                                                                                                                                                                                                                                                                                                                                                                                                                                                                                                                     |
|-----------------------------------------------|---------------------------------------------------------------------------------------------------------------------------------------------------------------------------------------------------------------------------------------------------------------------------------------------------------------------------------------------------------------------------------------------------------------------------------------------------------------------------------------------------------------------------------|
| <code>&lt;translated-subnet-entity&gt;</code> | In a <b>netmap</b> rule:<br><b>with src:</b> Modify the source-subnet-entity to the specified translated-subnet-entity, for instance a network created by the <b>network (Entity)</b> command. Both network entities must contain one subnet with a matching subnet mask.<br><b>with dst:</b> Modify the destination-subnet-entity to the specified translated-subnet-entity, for instance a network created by the <b>network (Entity)</b> command. Both network entities must contain one subnet with a matching subnet mask. |
| <code>all</code>                              | Remove all rules.                                                                                                                                                                                                                                                                                                                                                                                                                                                                                                               |

**Mode** NAT Configuration

**Usage** You can change the rule order by using the [move rule \(NAT\)](#) command.

Firewall is used in conjunction with NAT. Port forwarding (**portfw**) and masquerade (**masq**) rules do not implicitly permit packets. **Portfw** rules (actions) are applied before any other firewall and **masq** rules (actions) are applied after any other firewall rules. When firewall protection is enabled, all traffic is blocked by default. Use the [rule \(Firewall\)](#) command to configure firewall rules which allow the same application, source and destination entities you configure for the NAT rules.

Netmap **dst** rules are applied to traffic before it reaches the firewall rules, and netmap **src** rules are applied after the firewall has permitted the traffic. Firewall rules must be written to permit the traffic after it has been translated by the netmap **dst** rules.

Entities should have valid interfaces on which inbound and outbound traffic can be properly translated. You can use the [ip subnet](#) command and the [ipv6 subnet](#) command to configure the interfaces.

Removing a NAT rule for an actively translated flow does not stop it translating immediately. This means subsequent packets in the flow continue to be translated.

The continued translation after the associated NAT rule is removed will only stop when:

- The [clear firewall connections](#) command is executed or the flow stops.
- One of the following actions occurs:
  - You can use the [clear firewall connections](#) command to manually stop translations immediately, when the associated rule has been deleted regardless whether the firewall feature is actually configured with NAT or not.
  - The NAT rule is cleared when the traffic flow ends naturally, for example, stopped from the source. If the flow is re-initiated from a host, it will not be translated by the firewall, as the rule is deleted after the first flow stopped.



**Examples** To perform network address translation and port forward application 'http' from entity 'public' to any with target destination dmz.servers.web\_server, use the commands:

```
awplus# configure terminal
awplus(config)# nat
awplus(config-nat)# rule 10 portfw
http from public with dst dmz.servers.web_server
```

To perform network address translation and masquerade application 'http' from entity 'private' to 'public', use the commands:

```
awplus# configure terminal
awplus(config)# nat
awplus(config-nat)# rule 20 masq
http from private to public
```

To use subnet-based NAT to translate the source address of all traffic from 'private.lan' going to 'remote.lan' with the new subnet specified in 'private.global', use the commands:

```
awplus# configure terminal
awplus(config)# nat
awplus(config-nat)# rule 30 netmap all from private.lan to
remote.lan with src private.global
```

To remove NAT rule 10, use the command:

```
awplus(config-nat)# no rule 10
```

**Related  
commands**

[application](#)  
[clear firewall connections](#)  
[host \(Entity\)](#)  
[move rule \(NAT\)](#)  
[nat](#)  
[network \(Entity\)](#)  
[show nat rule](#)  
[show nat rule config-check](#)  
[show running-config nat](#)  
[zone](#)

**Command  
changes** Version 5.4.7-0.1: **netmap** option added.

# show nat

**Overview** Use this command to show the configuration state of NAT.

**Syntax** show nat

**Mode** Privileged Exec

**Examples** To show the configuration state of NAT, use the commands:

```
awplus# show nat
```

**Output** Figure 61-2: Example output from the **show nat** command

```
awplus#show nat
NAT is enabled
```

**Related commands** [enable \(NAT\)](#)

# show nat rule

**Overview** Use this command to show information about NAT rules.

**Syntax** show nat rule [<1-65535>]

| Parameter | Description |
|-----------|-------------|
| <1-65535> | Rule ID     |

**Mode** Privileged Exec

**Examples** To show information about all NAT rules, use the command:

```
awplus# show nat rule
```

**Output** Figure 61-3: Example output from the **show nat rule** command

```
awplus#show nat rule

[* = Rule is not valid - see "show nat rule config-check"]
 ID Action App From To With Hits

* 30 masq any private public - 0
 10 portfw http public - dmz.a.b 0
```

To show information about a specific NAT rule, use the command:

```
awplus# show nat rule 10
```

**Output** Figure 61-4: Example output from the **show nat rule** command

```
awplus#show nat rule 10

[* = Rule is not valid - see "show nat rule config-check"]
 ID Action App From To With Hits

 10 portfw http public - dmz.a.b 0
```

| Output Parameter | Description                                                                                                    |
|------------------|----------------------------------------------------------------------------------------------------------------|
| *                | Indicates the rule is not valid and cannot be hit, see the <a href="#">show nat rule config-check</a> command. |
| App              | Application name.                                                                                              |
| From             | Source entity.                                                                                                 |

| Output Parameter | Description                                    |
|------------------|------------------------------------------------|
| with             | Target entity name.                            |
| To               | Destination entity.                            |
| Hits             | The number of times the NAT rule has been hit. |

**Related commands** [rule \(NAT\)](#)  
[show nat rule config-check](#)

# show nat rule config-check

**Overview** Use this command to check configuration validity of NAT rules.

An invalid rule will not be active and cannot be hit.

This command also shows the reasons why a rule is not valid.

**Syntax** `show nat rule config-check`

**Mode** Privileged Exec

**Usage** NAT rules are applied to applications and entities. A rule is not valid if either the application, source entity or destination entity the rule applies to is not configured properly.

To configure applications and entities, see Application and Entity Commands.

**Examples** To check configuration validity of NAT rules, use the command:

```
awplus# show nat rule config-check
```

**Output** Figure 61-5: Example output from the **show nat rule config-check** command if rule configuration errors are detected

```
awplus#show nat rule config-check
Rule 10:
 Application does not have a protocol configured
 "From" entity does not exist
 "To" entity has no subnet or host addresses
```

**Output** Figure 61-6: Example output from the **show nat rule config-check** command if all rules are valid

```
awplus#show nat rule config-check
All rules are valid
```

# show running-config nat

**Overview** Use this command to show the configuration commands that have been used to configure NAT.

**Syntax** show running-config nat

**Mode** Privileged Exec

**Examples** To show the configuration commands that have been used to configure NAT, use the commands:

```
awplus# show running-config nat
```

**Output** Figure 61-7: Example output from the **show running-config nat** command

```
awplus#show running-config nat
nat
 rule 10 masq http from private to public
 rule 20 portfw http from public with dst dmz.servers.wb
 enable
!
```

# Part 9: Advanced Network Protection

# 62

# IPS Commands

## Introduction

This chapter provides an alphabetical reference of commands used to configure Intrusion Prevention System (IPS). For more information, see the [IPS Feature Overview and Configuration\\_Guide](#).

The table below lists the IPS commands and their applicable modes.

Figure 62-1: IPS Commands and Applicable Modes

| Mode                 | Command                              |
|----------------------|--------------------------------------|
| Privileged Exec      | <code>show ips</code>                |
|                      | <code>show ips categories</code>     |
|                      | <code>show running-config ips</code> |
| Global Configuration | <code>ips</code>                     |
| IPS Mode             | <code>category action (IPS)</code>   |
|                      | <code>protect (IPS)</code>           |

- Command List**
- [“category action \(IPS\)” on page 2705](#)
  - [“ips” on page 2706](#)
  - [“protect \(IPS\)” on page 2707](#)
  - [“show ips” on page 2708](#)
  - [“show ips categories” on page 2709](#)
  - [“show running-config ips” on page 2711](#)



# category action (IPS)

**Overview** Use this command to configure an action for a specified category.  
Use the **no** variant of this command to set the default action of alert for a specified category.

**Syntax** `category <category-name> action {alert|deny|disable}`  
`no category <category-name> action`

| Parameter                          | Description                                                                                                                                                                                                                                                                                                                                                    |
|------------------------------------|----------------------------------------------------------------------------------------------------------------------------------------------------------------------------------------------------------------------------------------------------------------------------------------------------------------------------------------------------------------|
| <code>&lt;category-name&gt;</code> | Category name. A category is a label that helps to classify the nature of traffic, for example, whether it is spammer, spot or spyware and so on. Once IPS protection is enabled, traffic will be categorized according to the available IPS categories. You can use the <a href="#">show ips categories</a> command to view the categories and their actions. |
| <code>alert</code>                 | Generate a log message. This is the default action.                                                                                                                                                                                                                                                                                                            |
| <code>deny</code>                  | Drop the matching packets. No error message is sent back to the source host.                                                                                                                                                                                                                                                                                   |
| <code>disable</code>               | Ignore a specified category. Ignored categories will not be used to categorize traffic.                                                                                                                                                                                                                                                                        |

**Default** The default action is alert.

**Mode** IPS Mode

**Examples** To drop packet categorized as `checksum`, use the commands:

```
awplus# configure terminal
awplus(config)# ips
awplus(config-ips)# category checksum action deny
```

To set the default action for category `checksum`, use the commands:

```
awplus# configure terminal
awplus(config)# ips
awplus(config-ips)# no category checksum action
```

**Validation Commands** [show ips categories](#)  
[show running-config ips](#)

# ips

**Overview** Use this command to configure IPS.

Use the **no** variant of this command to remove all IPS configuration.

**Syntax** `ips`  
`no ips`

**Mode** Global Configuration

**Usage** This command allows you to enter the IPS mode. The command prompt for this mode is **awplus(config-ips)#**.

In the IPS mode, you can:

- Enable or disable IPS protection, see the [protect \(IPS\)](#) command.
- Configure an action for specified categories, see the [category action \(IPS\)](#) command.

**Examples** To configure IPS, use the commands:

```
awplus# configure terminal
awplus(config)# ips
awplus(config-ips)#
```

To remove all IPS configuration, use the commands:

```
awplus# configure terminal
awplus(config)# no ips
```

# protect (IPS)

**Overview** Use this command to enable IPS protection .  
Use the **no** variant of this command to disable IPS protection.

**Syntax** protect  
no protect

**Usage** Once IPS protection is enabled, traffic will be categorized according to the available IPS categories. See the [show ips categories](#) command for the list of available IPS categories.

**Default** IPS is disabled by default.

**Mode** IPS Mode

**Examples** To enable IPS protection, use the commands:

```
awplus# configure terminal
awplus(config)# ips
awplus(config-ips)# protect
```

To disable IPS protection, use the commands:

```
awplus# configure terminal
awplus(config)# ips
awplus(config-ips)# no protect
```

**Validation Commands** [show ips](#)  
[show running-config ips](#)

# show ips

**Overview** Use this command to show the IPS configuration state and event count for the Intrusion Prevention System (IPS).

**Syntax** `show ips`

**Mode** Privileged Exec

**Examples** To display information about IPS, use the command:

```
awplus# show ips
```

**Output** Figure 62-2: Example output from the **show ips** command

```
awplus#show ips
Status: Enabled (Active)
Events: 4
```

**Command changes** Version 5.4.7-0.1: Event count added to the command output.

# show ips categories

**Overview** Use this command to show the IPS categories and their actions.

Note that if the IPS database provider is configured, this commands shows only the provider's categories.

**Syntax** `show ips categories`

**Mode** Privileged Exec

**Examples** To show the IPS categories and their actions, use the command:

```
awplus# show ips categories
```

**Output** Figure 62-3: Example output of built-in categories from the **show ips categories** command

```
awplus#show ips categories
Category (* = invalid) Action

checksum alert
ftp-bounce alert
gre-decoder-events alert
http-events alert
icmp-decoder-events alert
ip-decoder-events alert
ppp-decoder-events alert
smtp-events alert
stream-events alert
udp-decoder-events alert
```

| Parameter          | Description                                                                                                                                                                                                                                                                                                                          |
|--------------------|--------------------------------------------------------------------------------------------------------------------------------------------------------------------------------------------------------------------------------------------------------------------------------------------------------------------------------------|
| checksum           | Invalid checksums, e.g. IPv4, TCPv4, UDPv4, ICMPv4,TCPv6, UDPv6, ICMPv6.                                                                                                                                                                                                                                                             |
| ftp-bounce         | GPL FTP PORT bounce attempt.                                                                                                                                                                                                                                                                                                         |
| gre-decoder events | GRE anomalies, e.g. GRE packet too small, GRE wrong version, GRE v0 recursion control, GRE v0 flags, GRE v0 header too big, GRE v1 checksum present, GRE v1 routing present, GRE v1 strict source route, GRE v1 recursion control.                                                                                                   |
| http-events        | HTTP anomalies, e.g. HTTP unknown error, HTTP gzip decompression failed, HTTP request field missing colon, HTTP response field missing colon, HTTP invalid request chunk len, HTTP invalid response chunk len, HTTP status 100-Continue already seen, HTTP unable to match response to request, HTTP invalid server port in request. |

| Parameter           | Description                                                                                                                                                                                                                                                                                                                                                                                                                                                    |
|---------------------|----------------------------------------------------------------------------------------------------------------------------------------------------------------------------------------------------------------------------------------------------------------------------------------------------------------------------------------------------------------------------------------------------------------------------------------------------------------|
| icmp-decoder-events | ICMP anomalies, e.g. IPv6 with ICMPv4 header, ICMPv4 packet too small, ICMPv4 unknown type, ICMPv6 truncated packet, ICMPv6 unknown version.                                                                                                                                                                                                                                                                                                                   |
| ip-decoder-events   | IPv4 & IPv6 anomalies, e.g. IPv4 packet too small, IPv4 header size too small, IPv4 wrong IP version, IPv6 packet too small, IPv6 duplicated Routing extension header, IPv6 duplicated Hop-By-Hop Options extension header, IPv6 DSTOPTS only padding, SLL packet too small, Ethernet packet too small, VLAN header too small, FRAG IPv4 Fragmentation overlap, FRAG IPv6 Packet size too large, IPv4-in-IPv6 invalid protocol, IPv6-in-IPv6 packet too short. |
| ppp-decoder-events  | PPP anomalies, e.g. PPP packet too small, PPP IPv6 too small, PPP wrong type, PPPoE wrong code, PPPoE malformed tags.                                                                                                                                                                                                                                                                                                                                          |
| smtp-events         | SMTP anomalies, e.g. SMTP invalid reply, SMTP max reply line len exceeded, SMTP tls rejected, SMTP data command rejected.                                                                                                                                                                                                                                                                                                                                      |
| stream-events       | TCP anomalies, e.g. 3way handshake with ack in wrong dir, 3way handshake async wrong sequence, 3way handshake right seq wrong ack evasion, 4way handshake SYNACK with wrong ACK, STREAM CLOSEWAIT FIN out of window, STREAM ESTABLISHED SYNACK resend, STREAM FIN invalid ack, STREAM FIN1 ack with wrong seq, STREAM TIMEWAIT ACK with wrong seq, stream-events TCP packet too small, stream-events TCP duplicated option)                                    |
| udp-decoder-events  | UDP anomalies, e.g. UDP packet too small, UDP header length too small, UDP invalid header length                                                                                                                                                                                                                                                                                                                                                               |

# show running-config ips

**Overview** Use this command to show the configuration commands that have been used to configure IPS.

**Syntax** `show running-config dpi`

**Mode** Privileged Exec

**Examples** To show the commands that have been used to configure IPS, use the command:

```
awplus# show running-config ips
```

**Output** Figure 62-4: Example output from the **show running-config ips** command

```
awplus#show running-config ips
ips
 protect
!
```

# 63

# Malware Protection Commands

## Introduction

This chapter provides an alphabetical reference of commands used to configure Malware Protection. For more information about Malware Protection and a configuration example, see the [Malware Protection Feature Overview and Configuration Guide](#).

The table below lists the Malware Protection commands and their applicable modes.

Figure 63-1: Malware Protection commands and applicable modes

| Mode                    | Command                                              |
|-------------------------|------------------------------------------------------|
| Privileged Exec         | <code>show malware-protection</code>                 |
|                         | <code>show running-config malware-protection</code>  |
| Global Configuration    | <code>malware-protection</code>                      |
| Malware Protection Mode | <code>protect (Malware Protection)</code>            |
|                         | <code>provider kaspersky (Malware Protection)</code> |
|                         | <code>update-interval (Malware Protection)</code>    |

- Command List**
- [“malware-protection”](#) on page 2713
  - [“protect \(Malware Protection\)”](#) on page 2714
  - [“provider kaspersky \(Malware Protection\)”](#) on page 2715
  - [“show malware-protection”](#) on page 2716
  - [“show running-config malware-protection”](#) on page 2717
  - [“update-interval \(Malware Protection\)”](#) on page 2718



# malware-protection

**Overview** Use this command to configure Malware Protection.

Use the **no** variant of this command to remove all Malware Protection configuration.

**Syntax** `malware-protection`  
`no malware-protection`

**Mode** Global Configuration

**Usage** This command allows you to enter the Malware Protection Mode. The command prompt for this mode is **awplus(config-malware)#**.

In the Malware Protection Mode, you can:

- Set the Malware Protection provider, see the [provider kaspersky \(Malware Protection\)](#) command.
- Enable or disable Malware Protection, see the [protect \(Malware Protection\)](#) command.

**Examples** To configure Malware Protection settings, use the commands:

```
awplus# configure terminal
awplus(config)# malware-protection
awplus(config-malware)#
```

To remove all Malware Protection configuration, use the commands:

```
awplus# configure terminal
awplus(config)# no malware-protection
```

**Validation Commands** [show malware-protection](#)

# protect (Malware Protection)

**Overview** Use this command to enable Malware Protection.

Use the **no** variant of this command to disable Malware Protection without losing existing Malware Protection configuration.

Note that you need to use the [provider kaspersky \(Malware Protection\)](#) command to set Malware Protection provider before issuing this command to enable Malware Protection.

**Syntax** protect  
no protect

**Default** Malware Protection is disabled by default.

**Mode** Malware Protection Mode

**Examples** To enable Malware Protection, use the commands:

```
awplus# configure terminal
awplus(config)# malware-protection
awplus(config-malware)# provider kaspersky
awplus(config-malware)# protect
```

To disable Malware Protection, use the commands:

```
awplus# configure terminal
awplus(config)# malware-protection
awplus(config-malware)# no protect
```

**Validation Commands** [show malware-protection](#)  
[show running-config malware-protection](#)

**Related Commands** [provider kaspersky \(Malware Protection\)](#)

# provider kaspersky (Malware Protection)

**Overview** Use this command to set Malware Protection provider.

Malware Protection provider provides a signature database containing a list of known threat patterns. The database is kept up-to-date to ensure the effectiveness of the detection. You can use the [update-interval \(Malware Protection\)](#) command to configure the update check interval and update local database if needed.

Note that you need to set Malware Protection provider before issuing [protect \(Malware Protection\)](#) command to enable Malware Protection.

**Syntax** `provider kaspersky`

**Default** No Malware Protection provider is set.

**Mode** Malware Protection Mode

**Examples** To set Malware Protection provider, use the commands:

```
awplus# configure terminal
awplus(config)# malware-protection
awplus(config-malware)# provider kaspersky
```

**Validation Commands** [show malware-protection](#)  
[show running-config malware-protection](#)

**Related Commands** [protect \(Malware Protection\)](#)

# show malware-protection

**Overview** Use this command to show the information about the operation of Malware Protection.

**Syntax** `show malware-protection`

**Mode** Privileged Exec

**Examples** To show the operation of Malware Protection, use the command:

```
awplus# show malware-protection
```

**Output** Figure 63-2: Example output from **show malware-protection** if the subscription license for Malware Protection is active.

```
awplus#show malware-protection
Status: Enabled (Active)
Events: 0
Provider: Kaspersky
Resource version: 1.0
Resource update interval: 1 hour
```

**Command changes** Version 5.4.7-0.1: Event count added to the command output.

# show running-config malware-protection

**Overview** Use this command to show the configuration information about Malware Protection.

**Syntax** `show running-config malware-protection`

**Mode** Privileged Exec

**Examples** To show the running configuration of Malware Protection, use the command:

```
awplus# show running-config malware-protection
```

**Output** Figure 63-3: Example output from the **show running-config malware-protection** command on the console

```
awplus#show running-config malware-protection
malware-protection
 provider kaspersky
 protect
!
```

# update-interval (Malware Protection)

**Overview** Use this command to configure an update check interval for the Malware Protection resource files.

Use the **no** variant of this command to restore the default update check interval to 1 hour.

**Syntax** `update-interval {minutes <10-525600>|hours <1-8760>|days <1-365>|weeks <1-52>|never}`

`no update-interval`

| Parameter           | Description                                                                                                                                                                                                                                   |
|---------------------|-----------------------------------------------------------------------------------------------------------------------------------------------------------------------------------------------------------------------------------------------|
| minutes <10-525600> | Update interval from 10 through 52600 minutes                                                                                                                                                                                                 |
| hours <1-8760>      | Update interval from 1 hour through 8760 hours                                                                                                                                                                                                |
| days <1-365>        | Update interval from 1 day through 365 days                                                                                                                                                                                                   |
| weeks <1-52>        | Update interval from 1 week through 52 weeks                                                                                                                                                                                                  |
| never               | Never update the resource. If Malware Protection becomes enabled, the Update Manager will do update check and update the resource files if needed. Use the <a href="#">protect (Malware Protection)</a> command to enable Malware Protection. |

**Default** The default update interval is 1 hour.

**Mode** Malware Protection Mode

**Usage** The Update Manager will perform an update check for a resource when triggered by an update check interval. It will request the current version number of the resource from the Update Server, then compare it with the current local version. If they are different, the Update Manager will initiate an update of the local resource.

The Update Manager will revert to last known good resource file if installation of an updated resource fails.

Note that when a feature is disabled, regular and manual update checks for its resources are disabled.

Also note that an update check for a resource will not proceed if an update of that resource is already in progress.

**Examples** To check and update the Malware Protection resource files once a week, use the command:

```
awplus(config-malware)# update-interval weeks 1
```

To disable updating of the resource, use the command:

```
awplus(config-malware)# update-interval never
```

To restore the default update interval, which is 1 hour, use the command:

```
awplus(config-malware)# no update-interval
```

**Validation** [show resource](#)  
**Commands**

# 64

# Antivirus Commands

## Introduction

**Overview** This chapter provides an alphabetical reference of commands used to configure Antivirus. For more information about Antivirus introduction and configuration example, see the [Antivirus Feature Overview and Configuration\\_Guide](#).

The following table lists the Antivirus commands and their applicable modes.

Figure 64-1: Antivirus commands and applicable modes

| Mode                 | Command                                     |
|----------------------|---------------------------------------------|
| Privileged Exec      | <code>show antivirus</code>                 |
|                      | <code>show antivirus statistics</code>      |
|                      | <code>show running-config antivirus</code>  |
|                      | <code>debug antivirus</code>                |
|                      | <code>show debugging antivirus</code>       |
| Global Configuration | <code>antivirus</code>                      |
| Antivirus Mode       | <code>action (Antivirus)</code>             |
|                      | <code>protect (Antivirus)</code>            |
|                      | <code>provider kaspersky (Antivirus)</code> |
|                      | <code>update-interval (Antivirus)</code>    |

- Command List**
- [“action \(Antivirus\)”](#) on page 2722
  - [“antivirus”](#) on page 2724
  - [“debug antivirus”](#) on page 2725
  - [“protect \(Antivirus\)”](#) on page 2726
  - [“provider kaspersky \(Antivirus\)”](#) on page 2727



- [“show antivirus”](#) on page 2728
- [“show antivirus statistics”](#) on page 2729
- [“show debugging antivirus”](#) on page 2730
- [“show running-config antivirus”](#) on page 2731
- [“update-interval \(Antivirus\)”](#) on page 2732

# action (Antivirus)

**Overview** Use this command to set the action to take when a scan fails or when a scan limit is exceeded.

Use the **no** variant of this command to restore the default action, which is deny.

**Syntax** `action {scan-failed|limit-exceeded} {deny|permit}`  
`no action {scan-failed|limit-exceeded}`

| Parameter      | Description                                                                                                                                                                                                                                                                                   |
|----------------|-----------------------------------------------------------------------------------------------------------------------------------------------------------------------------------------------------------------------------------------------------------------------------------------------|
| scan-failed    | Scan failed for a wide variety of possible reasons, for example, encrypted or corrupt file type, out of temporary memory, license expired.                                                                                                                                                    |
| limit-exceeded | Scan failed due to a nesting limit or memory limit being exceeded. Antivirus can extract and scan nested files up to 3 levels deep. The maximum size of a file object that can be sent for scanning is 10MB. The maximum total size of all objects that can be concurrently scanned is 100MB. |
| deny           | Block HTTP request.                                                                                                                                                                                                                                                                           |
| permit         | Allow HTTP request.                                                                                                                                                                                                                                                                           |

**Default** The default action is deny when a scan failed or a scan limit is exceeded.

**Mode** Antivirus Mode

**Examples** To allow HTTP traffic when a scan fails, use the commands:

```
awplus# configure terminal
awplus(config)# antivirus
awplus(config-antivirus)# action scan-failed permit
```

To block HTTP request when a scan fails, use the commands:

```
awplus# configure terminal
awplus(config)# antivirus
awplus(config-antivirus)# action scan-failed deny
```

To allow HTTP request when a scan limit is exceeded, use the commands:

```
awplus# configure terminal
awplus(config)# antivirus
awplus(config-antivirus)# action limit-exceeded permit
```

To block HTTP traffic when a scan limit is exceeded, use the commands:

```
awplus# configure terminal
awplus(config)# antivirus
awplus(config-antivirus)# action limit-exceeded deny
```

To restore the default action when a scan fails, use the commands:

```
awplus# configure terminal
awplus(config)# antivirus
awplus(config-antivirus)# no action scan-failed
```

To restore the default action when a scan limit is exceeded, use the commands:

```
awplus# configure terminal
awplus(config)# antivirus
awplus(config-antivirus)# no action limit-exceeded
```

**Validation** `show antivirus`  
**Commands**

# antivirus

**Overview** Use this command to configure Antivirus.

Use the **no** variant of this command to remove all Antivirus configuration.

**Syntax** `antivirus`  
`no antivirus`

**Mode** Global Configuration

**Usage** This command allows you to enter the Antivirus Mode. The command prompt for this mode is **awplus(config-antivirus)#**.

In the Antivirus Mode, you can:

- Set the action to take if a scan failed or a scan limit is exceeded, see the [action \(Antivirus\)](#) command.
- Enable or disable Antivirus protection, see the [protect \(Antivirus\)](#) command.

**Examples** To configure Antivirus settings, use the commands:

```
awplus# configure terminal
awplus(config)# antivirus
awplus(config-antivirus)#
```

To remove all Antivirus configuration, use the commands:

```
awplus# configure terminal
awplus(config)# no antivirus
```

**Validation  
Commands** `show antivirus`

# debug antivirus

**Overview** Use this command to enable Antivirus debugging. This will cause additional detailed debugging information to be logged at the “informational” and “debugging” levels.

Use the **no** variant of this command to disable Antivirus debugging.

**Syntax** debug antivirus  
no debug antivirus

**Default** Antivirus debugging is disabled by default.

**Mode** Privileged Exec

**Examples** To enable Antivirus debugging, use the command:

```
awplus# debug antivirus
```

To disable Antivirus debugging, use the command:

```
awplus# no debug antivirus
```

**Validation  
Commands** show debugging antivirus  
show antivirus

# protect (Antivirus)

**Overview** Use this command to enable Antivirus protection.

Use the **no** variant of this command to disable Antivirus protection without losing existing Antivirus configuration.

Note that you need to use the [provider kaspersky \(Antivirus\)](#) command to set Antivirus provider before issuing this command to enable Antivirus protection.

**Syntax** protect  
no protect

**Default** Antivirus is disabled by default.

**Mode** Antivirus Mode

**Examples** To enable Antivirus protection, use the commands:

```
awplus# configure terminal
awplus(config)# antivirus
awplus(config-antivirus)# provider kaspersky
awplus(config-antivirus)# protect
```

To disable Antivirus protection, use the commands:

```
awplus# configure terminal
awplus(config)# antivirus
awplus(config-antivirus)# no protect
```

**Validation Commands** show antivirus  
show running-config antivirus

**Related Commands** provider kaspersky (Antivirus)

# provider kaspersky (Antivirus)

**Overview** Use this command to set Antivirus provider.

Antivirus provider provides a signature database containing a list of known threat patterns. The database is kept up-to-date to ensure the effectiveness of the detection. You can use the [update-interval \(Antivirus\)](#) command to configure the update check interval and update local database if needed.

Note that you need to set Antivirus provider before issuing [protect \(Antivirus\)](#) command to enable Antivirus protection.

**Syntax** `provider kaspersky`

**Default** No Antivirus provider is set.

**Mode** Antivirus Mode

**Examples** To set Antivirus provider, use the commands:

```
awplus# configure terminal
awplus(config)# antivirus
awplus(config-antivirus)# provider kaspersky
```

**Validation Commands** [show antivirus](#)  
[show running-config antivirus](#)

**Related Commands** [protect \(Antivirus\)](#)

# show antivirus

**Overview** Use this command to show the information about the operation of Antivirus.

**Syntax** show antivirus

**Mode** Privileged Exec

**Examples** To show the operation of Antivirus, use the command:

```
awplus# show antivirus
```

**Output** Figure 64-2: Example output from the **show antivirus** command on the console if the subscription license of Antivirus is active.

```
Status: Enabled (Active)
Provider: Kaspersky
Scan failed action: block
Limit exceeded action: block
Resource version: 1.0
Resource update interval: 1 hour
```

Figure 64-3: Example output from the **show antivirus** command on the console if the subscription license of Antivirus is inactive.

```
awplus#show antivirus
Status: Enabled (Inactive Unlicensed)
Provider: Kaspersky
Scan failed action: block
Limit exceeded action: block
Resource version: not set
Resource update interval: 1 hour
```



# show antivirus statistics

**Overview** Use this command to show Antivirus statistics.

**Syntax** show antivirus statistics

**Mode** Privileged Exec

**Examples** To show Antivirus statistics, use the command:

```
awplus# show antivirus statistics
```

**Output** Figure 64-4: Example output from the **show antivirus statistics** command

```
awplus#show antivirus statistics
Proxy Antivirus Statistics:
Files scanned: 1572
Files skipped: 0
Viruses found: 3 (0.2%)
Scan failures: 0 (0.0%)
Limit exceeded: 0 (0.0%)
```

| Output Parameter | Description                                                                                            |
|------------------|--------------------------------------------------------------------------------------------------------|
| Files scanned    | The number of files that have been scanned.                                                            |
| Files skipped    | The number of files that could not be scanned.                                                         |
| Viruses found    | The number of files that contain a virus. Also shown as a percentage of total number of scanned files. |
| Scan failures    | The number of times a scan failed. Also shown as a total number of scans.                              |
| Limit exceeded   | The number of times a scan limit is exceeded. Also shown as a total number of scans.                   |

# show debugging antivirus

**Overview** Use this command to show the Antivirus debugging setting.

**Syntax** show debugging antivirus

**Mode** Privileged Exec

**Examples** To show the Antivirus debugging setting, use the command:

```
awplus# show debugging antivirus
```

**Output** Figure 64-5: Example output from the **show debugging antivirus** command

```
awplus#show debugging antivirus
Antivirus Debugging Status: on
```

**Related Commands** [debug antivirus](#)

# show running-config antivirus

**Overview** Use this command to show the configuration information about Antivirus.

**Syntax** show running-config antivirus

**Mode** Privileged Exec

**Examples** To show the running configuration of Antivirus, use the command:

```
awplus# show running-config antivirus
```

**Output** Figure 64-6: Example output from the **show running-config antivirus** command

```
awplus#show running-config antivirus
antivirus
 provider kaspersky
 action scan-failed permit
 update-interval weeks 1
 protect
!
```

# update-interval (Antivirus)

**Overview** Use this command to configure an update check interval for the Antivirus resource files.

Use the **no** variant of this command to restore the default update check interval to 1 hour.

**Syntax** `update-interval {minutes <10-525600>|hours <1-8760>|days <1-365>|weeks <1-52>|never}`  
`no update-interval`

| Parameter           | Description                                                                                                                                                                                                        |
|---------------------|--------------------------------------------------------------------------------------------------------------------------------------------------------------------------------------------------------------------|
| minutes <10-525600> | Update interval from 10 through 52600 minutes                                                                                                                                                                      |
| hours <1-8760>      | Update interval from 1 hour through 8760 hours                                                                                                                                                                     |
| days <1-365>        | Update interval from 1 day through 365 days                                                                                                                                                                        |
| weeks <1-52>        | Update interval from 1 week through 52 weeks                                                                                                                                                                       |
| never               | Never update the resource. If Antivirus becomes enabled, the Update Manager will do update check and update the resource files if needed. Use the <a href="#">protect (Antivirus)</a> command to enable Antivirus. |

**Default** The default update interval is 1 hour.

**Mode** Antivirus Mode

**Usage** The Update Manager will perform an update check for a resource when triggered by an update check interval. It will request the current version number of the resource from the Update Server, then compare it with the current local version. If they are different, the Update Manager will initiate an update of the local resource.

The Update Manager will revert to last known good resource file if installation of an updated resource fails.

Note that when a feature is disabled, regular and manual update checks for its resources are disabled.

Also note that an update check for a resource will not proceed if an update of that resource is already in progress.

**Examples** To check and update the Antivirus resource files once a week, use the command:

```
awplus(config-antivirus)# update-interval weeks 1
```

To disable updating of the resource, use the command:

```
awplus(config-antivirus)# update-interval never
```

To restore the default update interval, which is 1 hour, use the command:

```
awplus(config-antivirus)# no update-interval
```

**Validation** show resource  
**Commands**

# 65

# URL Filtering Commands

## Introduction

This chapter provides an alphabetical reference of commands used to configure URL filtering.

URL filtering blocks all HTTP and HTTPS access to a list of websites. You can either specify a short list of websites to block (up to 1000 blacklist and 1000 whitelist rules), or subscribe to the blacklist service offered by Kaspersky. If you subscribe to the Kaspersky service, you can create custom blacklists to block additional URLs not in the Kaspersky blacklist or custom whitelists to allow URLs that the Kaspersky service blocks.

For more information, see the [URL Filtering Feature Overview\\_and Configuration Guide](#).

The following table lists the URL filtering commands and their applicable modes.

Figure 65-1: URL filtering commands and applicable modes

| Mode                     | Command                                      |
|--------------------------|----------------------------------------------|
| Privileged Exec          | <code>show running-config url-filter</code>  |
|                          | <code>show url-filter</code>                 |
|                          | <code>url-filter reload custom-lists</code>  |
| Global Configuration     | <code>url-filter</code>                      |
| URL Filter Configuration | <code>blacklist</code>                       |
|                          | <code>protect (URL filtering)</code>         |
|                          | <code>provider kaspersky</code>              |
|                          | <code>update-interval (URL Filtering)</code> |
|                          | <code>whitelist</code>                       |

**Command List** • [“blacklist” on page 2736](#)

- [“log url-requests”](#) on page 2737
- [“protect \(URL filtering\)”](#) on page 2738
- [“provider kaspersky”](#) on page 2739
- [“show running-config url-filter”](#) on page 2740
- [“show url-filter”](#) on page 2741
- [“update-interval \(URL Filtering\)”](#) on page 2742
- [“url-filter reload custom-lists”](#) on page 2744
- [“url-filter”](#) on page 2745
- [“whitelist”](#) on page 2746

# blacklist

**Overview** Use this command to add a custom blacklist file to the URL filtering configuration. Use the **no** variant of this command to remove a blacklist from the URL filtering configuration.

**Syntax** `blacklist <url_of_blacklist_file>`  
`no blacklist <url_of_blacklist_file>`

| Parameter                                  | Description                                                                                    |
|--------------------------------------------|------------------------------------------------------------------------------------------------|
| <code>&lt;url_of_blacklist_file&gt;</code> | URL of the blacklist file. The blacklist file can be located in flash, SD card, or USB device. |

**Mode** URL Filter Configuration

**Usage** You can use custom blacklists to specify URLs to be blocked.

If you are using the Kaspersky service, custom blacklists are processed before the Kaspersky blacklist.

For information about blacklist rule format, see the [URL Filtering Feature Overview and Configuration Guide](#).

You can use the [whitelist](#) command to add a whitelist that will override any corresponding blacklist entries.

**Examples** To add a blacklist that uses a custom file (that is stored on USB, for example) and then enable URL filtering, use the commands:

```
awplus# configure terminal
awplus(config)# url-filter
awplus(config-url-filter)# blacklist usb:/my_blacklist.txt
awplus(config-url-filter)# protect
```

To remove the blacklist file from the URL filtering configuration, use the commands:

```
awplus# configure terminal
awplus(config)# url-filter
awplus(config-url-filter)# no blacklist usb:/my_blacklist.txt
```

**Related commands**

- [protect \(URL filtering\)](#)
- [show url-filter](#)
- [url-filter reload custom-lists](#)
- [whitelist](#)



# log url-requests

**Overview** If URL Filtering is enabled, then by default, black list hits and issues with match criteria and list files are logged.

Use this command to enable logging of all HTTP and HTTPS URL requests (both permitted and denied) passing through the firewall.

Use the **no** variant of this command to disable extra logging of HTTP and HTTPS URL requests passing through the firewall.

**Syntax** `log url-requests`  
`no log url-requests`

**Default** Disabled by default.

**Mode** URL Filter Configuration

**Usage** When enabled, additional log messages for HTTP and HTTPS URL requests passing through the firewall contain the:

- URL being accessed
- IP address of the user that requested the URL

**Example** To configure logging of all HTTP and HTTPS URL requests passing through the firewall (permitted as well as denied), use the following commands:

```
awplus# configure terminal
awplus(config)# url-filter
awplus(config-url-filter)# log url-requests
```

**Related Commands** [url-filter](#)

**Command changes** Version 5.4.7-1.1: command added

# protect (URL filtering)

**Overview** Use this command to enable URL filter protection.  
Use the **no** variant of this command to disable URL filter protection without losing the existing URL filter configuration.

**Syntax** protect  
no protect

**Default** URL filter protection is disabled by default and all HTTP and HTTPS traffic is allowed.

**Mode** URL Filter Configuration

**Usage** If you are subscribed to the Kaspersky service, you must enter the [provider kaspersky](#) command before entering this command.

**Examples** To enable URL filter protection, use the commands:

```
awplus# configure terminal
awplus(config)# url-filter
awplus(config-url-filter)# provider kaspersky
awplus(config-url-filter)# protect
```

To disable URL filter protection, use the commands:

```
awplus# configure terminal
awplus(config)# url-filter
awplus(config-url-filter)# no protect
```

**Related commands** [provider kaspersky](#)  
[show url-filter](#)

**Command changes** Version 5.4.7-1.1: HTTPS support added.

# provider kaspersky

**Overview** Use this command to set Kaspersky as the URL filter blacklist provider, and register Kaspersky's blacklist file with the update manager. This feature requires a Kaspersky subscription. For more information on Kaspersky see their website <https://support.kaspersky.com>

**Syntax** `provider kaspersky`

**Mode** URL Filter Configuration

**Usage** Kaspersky provides constantly updated blacklists that can be used for URL filtering. An HTTP or HTTPS request that includes a URL that matches an entry in the blacklist will be dropped.

**NOTE:** *that if you are using the Kaspersky service, you must enter this command before enabling URL filtering with the **protect** command.*

**Examples** To configure Kaspersky as the URL filter blacklist provider and then enable URL filtering, use the commands:

```
awplus# configure terminal
awplus(config)# url-filter
awplus(config-url-filter)# provider kaspersky
awplus(config-url-filter)# protect
```

**Related commands** [protect \(URL filtering\)](#)  
[show url-filter](#)

**Command changes** Version 5.4.7-1.1: HTTPS support added.

# show running-config url-filter

**Overview** Use this command to show the running configuration information for URL filtering

**Syntax** `show running-config url-filter`

**Mode** Privileged Exec

**Examples** To show the running configuration of URL filtering, use the command:

```
awplus# show running-config url-filter
```

**Output** Figure 65-2: Example output from the **show running-config url-filter** command

```
awplus#show running-config url-filter
url-filter
 provider kaspersky
 protect
!
```

# show url-filter

**Overview** Use this command to show information about the configuration state of URL filtering.

**Syntax** `show url-filter`

**Mode** Privileged Exec

**Examples** To show information about the configuration state of URL filtering, use the command:

```
awplus# show url-filter
```

**Output** Figure 65-3: Example output from **show url-filter**

```
awplus#show url-filter
Status: Enabled (Active)
Events: 104
Custom blacklists Entries
blacklist-example.txt 365
Custom whitelists Entries
whitelist-example.txt 4
```

**Output** Figure 65-4: Example output from **show url-filter** if the Kaspersky URL blacklist subscription license is active.

```
awplus#show url-filter
Status: Enabled (Active)
Provider: Kaspersky
Status: Enabled (Active)
Events: 104
Resource version: 1.0
Update interval: 1 hour
Blacklist entries: 63457
Custom blacklists Entries
blacklist-example.txt 3
Custom whitelists Entries
whitelist-example.txt 1
```

**Command changes** Version 5.4.7-0.1: Event count added to the command output.

# update-interval (URL Filtering)

**Overview** Use this command to configure the update-interval for the URL filter provider blacklist resource file.

Use the **no** variant of this command to restore the default update check interval of 1 hour.

**Syntax** `update-interval {minutes <10-525600>|hours <1-8760>|days <1-365>|weeks <1-52>|never}`  
`no update-interval`

| Parameter           | Description                                                                                                                                                                                                                                             |
|---------------------|---------------------------------------------------------------------------------------------------------------------------------------------------------------------------------------------------------------------------------------------------------|
| minutes <10-525600> | Update interval from 10 through 52600 minutes                                                                                                                                                                                                           |
| hours <1-8760>      | Update interval from 1 hour through 8760 hours                                                                                                                                                                                                          |
| days <1-365>        | Update interval from 1 day through 365 days                                                                                                                                                                                                             |
| weeks <1-52>        | Update interval from 1 week through 52 weeks                                                                                                                                                                                                            |
| never               | Never update the resource. When URL filtering protection is enabled, the update manager will do an update check and update the resource files if necessary. Use the <a href="#">protect (URL filtering)</a> command to enable URL filtering protection. |

**Default** The default update interval is 1 hour.

**Mode** URL Filter Configuration

**Usage** The update manager will perform an update check for a resource when triggered by an update check interval. It will request the current version number of the resource from the update server, then compare it with the current local version. If they are different, the update manager will initiate an update of the local resource.

The update manager will revert to the last known good resource file if installation of an updated resource fails.

Note that when a feature is disabled, regular and manual update checks for its resources are also disabled.

Also note that an update check for a resource will not proceed if an update of that resource is already in progress.

**Examples** To check and update the URL filter provider blacklist every 3 hours, use the command:

```
awplus(config-url-filter)# update-interval hours 3
```

To disable updating of the provider blacklist, use the command:

```
awplus(config-url-filter)# update-interval never
```

To configure resource update checking for URL filter to the default interval, which is 1 hour, use the command:

```
awplus(config-url-filter)# no update-interval
```

**Related  
Commands**    [protect \(URL filtering\)](#)  
                  [show resource](#)

# url-filter reload custom-lists

**Overview** Use this command to reload all custom blacklists and whitelists after editing one or more of them.

**Syntax** `url-filter reload custom-lists`

**Mode** Privileged Exec

**Examples** To reload all custom blacklists and whitelists, use the following command:

```
awplus# url-filter reload custom-lists
```

**Related commands** [blacklist](#)  
[whitelist](#)



# url-filter

**Overview** Use this command to enter URL Filter Configuration mode and configure URL filtering functionality.

Use the **no** variant of this command to remove all URL filtering configuration.

**Syntax** `url-filter`  
`no url-filter`

**Mode** Global Configuration

**Usage** This command allows you to enter the URL Filter Configuration mode and changes the command prompt to **awplus(config-url-filter)#**.

The URL Filter Configuration mode enables you to:

- Enable URL filtering protection; see the [protect \(URL filtering\)](#) command.
- Configure the provider blacklist; see the [provider kaspersky](#) command.
- Configure custom blacklists; see the [blacklist](#) command.
- Configure custom whitelists; see the [whitelist](#) command.

**Examples** To enter the URL Filter Configuration mode, use the commands:

```
awplus# configure terminal
awplus(config)# url-filter
awplus(config-url-filter)#
```

To remove all URL filter configuration, use the commands:

```
awplus# configure terminal
awplus(config)# no url-filter
```

**Related commands**

- [blacklist](#)
- [protect \(URL filtering\)](#)
- [provider kaspersky](#)
- [show running-config](#)
- [show url-filter](#)
- [whitelist](#)

# whitelist

**Overview** Use this command to add a custom whitelist file to the URL filtering configuration. Use the **no** variant of this command to remove a whitelist from the URL filter configuration.

**Syntax** `whitelist <url_of_whitelist_file>`  
`no whitelist <url_of_whitelist_file>`

| Parameter                                  | Description                                                                                    |
|--------------------------------------------|------------------------------------------------------------------------------------------------|
| <code>&lt;url_of_whitelist_file&gt;</code> | URL of the whitelist file. The whitelist file can be located in flash, SD card, or USB device. |

**Mode** URL Filter Configuration

**Usage** Whitelist matching precedes blacklist matching. You can use custom whitelists to override any corresponding blacklist entries. An HTTP or HTTPS request that includes a URL that matches an entry in a whitelist will be permitted.

For information about whitelist rule format, see the [URL Filtering Feature Overview and Configuration Guide](#).

**Examples** To add a whitelist that uses a custom file (that is stored on USB, for example) and then enable URL filtering, use the commands:

```
awplus# configure terminal
awplus(config)# url-filter
awplus(config-url-filter)# whitelist usb:/my_whitelist.txt
awplus(config-url-filter)# protect
```

To remove the whitelist file from the URL filtering configuration, use the commands:

```
awplus# configure terminal
awplus(config)# url-filter
awplus(config-url-filter)# no whitelist usb:/my_whitelist.txt
```

**Related commands** [blacklist](#)  
[protect \(URL filtering\)](#)  
[show url-filter](#)  
[url-filter reload custom-lists](#)

**Command changes** Version 5.4.7-1.1: HTTPS support added.

# 66

# Web Control Commands

## Introduction

This chapter provides an alphabetical reference of commands used to configure Web Control. For more information, see the [Web Control Feature Overview and Configuration\\_Guide](#).

The table lists the Web Control commands and their applicable modes.

Figure 66-1: Web Control commands and applicable modes

| Mode                                    | Command                                      |
|-----------------------------------------|----------------------------------------------|
| Privileged Exec                         | <code>debug web-control</code>               |
|                                         | <code>show web-control</code>                |
|                                         | <code>show web-control categories</code>     |
|                                         | <code>show debugging web-control</code>      |
|                                         | <code>show running-config web-control</code> |
|                                         | <code>show web-control rules</code>          |
| Global Configuration                    | <code>web-control</code>                     |
| Web Control Configuration               | <code>action (Web Control)</code>            |
|                                         | <code>category (Web Control)</code>          |
|                                         | <code>provider digitalarts</code>            |
|                                         | <code>protect (Web Control)</code>           |
|                                         | <code>rule (Web Control)</code>              |
|                                         | <code>move rule (Web Control)</code>         |
| Web Control Category Configuration mode | <code>match (Web-Control)</code>             |

**Command List** • [“action \(Web Control\)” on page 2749](#)

- [“category \(Web Control\)”](#) on page 2750
- [“debug web-control”](#) on page 2752
- [“match \(Web-Control\)”](#) on page 2753
- [“move rule \(Web Control\)”](#) on page 2755
- [“protect \(Web Control\)”](#) on page 2756
- [“provider digitalarts”](#) on page 2757
- [“rule \(Web Control\)”](#) on page 2758
- [“show debugging web-control”](#) on page 2761
- [“show running-config web-control”](#) on page 2762
- [“show web-control”](#) on page 2763
- [“show web-control categories”](#) on page 2765
- [“show web-control rules”](#) on page 2767
- [“web-control”](#) on page 2768

# action (Web Control)

**Overview** Use this command to set the action to take on uncategorized websites and categorized websites that don't hit any rule.

Use the **no** variant of this command to restore the default action which is deny.

**Syntax** `action {permit|deny}`  
`no action`

| Parameter | Description  |
|-----------|--------------|
| permit    | Allow access |
| deny      | Block access |

**Default** The default action is deny.

**Mode** Web Control Configuration

**Examples** To allow HTTP and HTTPS requests when no rules are hit, use the commands:

```
awplus# configure terminal
awplus(config)# web-control
awplus(config-web-control)# action permit
```

To restore the default action and block all HTTP and HTTPS requests when no rules are hit, use the commands:

```
awplus# configure terminal
awplus(config)# web-control
awplus(config-web-control)# no action
```

**Related commands** [show web-control](#)

**Command changes** Version 5.4.7-1.1: HTTPS support added.

# category (Web Control)

**Overview** Use this command to configure a category.

A category is a text string that represents a logical grouping of websites. For example "Blog" is the category given to URLs that link to websites that are classified as being associated with blogging. There are two types of category: provider categories and custom categories. Provider categories are pre-defined categories. Digital Arts provides and constantly updates about 100 provider categories. Custom categories are defined by the users.

Use the **no** variant of this command to delete a custom category and delete all its match criteria.

**NOTE:** You cannot delete a provider category, but you can use the **no** variant of this command to delete the custom match criteria from the provider category.

**Syntax** `category <category-name>`  
`no category <category-name>`

| Parameter                          | Description                                                                                                                                                                                                                            |
|------------------------------------|----------------------------------------------------------------------------------------------------------------------------------------------------------------------------------------------------------------------------------------|
| <code>&lt;category-name&gt;</code> | Category name.<br>Category names are case insensitive and can be up to 64 characters long composed of printable ASCII characters. Spaces are allowed in category names, but the category names must be enclosed in double quotes (""). |

**Mode** Web Control Configuration

**Usage** You can use the to display both provider categories and custom categories.

You cannot delete the provider categories or modify their names, but you can configure custom match criteria for provider categories. Custom match criteria precede and override provider categorization. This means if a website matches the match criteria from custom categories, the website will not be further categorized by Digital Arts.

This command allows you to enter the Web Control Category Configuration mode with the prompt **awplus(config-category)#**. You can create a set of match criteria for a category in this sub-mode. The match criteria are applied to website URLs as a simple string comparison. For more information about match criteria, see the [match \(Web-Control\)](#) command.

You can also create a set of rules for a category. Rules set the action to take for an HTTP or HTTPS request from a specific entity. For more information about rules, see the [rule \(Web Control\)](#) command. For more information about entities, see the [Application and Entity Commands](#) chapter.

**Examples** To create a custom category named `work` and create match criteria for this category, use the commands:

```
awplus# configure terminal
awplus(config)# web-control
awplus(config-web-control)# category work
awplus(config-category)# match alliedtelesis
awplus(config-category)# match example
awplus(config-category)# match www.ietf.org
```

To delete the custom category and its match criteria, use the commands:

```
awplus# configure terminal
awplus(config)# web-control
awplus(config-web-control)# no category work
```

**Related commands** [match \(Web-Control\)](#)  
[rule \(Web Control\)](#)  
[show web-control categories](#)

**Command changes** Version 5.4.7-1.1: HTTPS support added.

# debug web-control

**Overview** Use this command to enable Web Control debugging. This will cause additional detailed debugging information to be logged at the “informational” and “debugging” levels.

Use the **no** variant of this command to disable Web Control debugging.

**Syntax** `debug web-control`  
`no debug web-control`

**Default** Web Control debugging is disabled by default.

**Mode** Privileged Exec

**Examples** To enable Web Control debugging, use the commands:

```
awplus# debug web-control
```

To disable Web Control debugging, use the commands:

```
awplus# no debug web-control
```

**Related commands** [show debugging web-control](#)



# match (Web-Control)

**Overview** Use this command to add a match criterion for a category.

A match criterion is a static string that is compared to a website URL (domain name or IP address) for a partial or complete match. A URL will be searched to see if it contains the given match criterion string. If the URL contains the string, then the match criterion is matched.

Note that the match criterion is not applied to the web page content.

Use the **no** variant of this command to delete a match criterion.

**NOTE:** *If a custom category's last match criterion is deleted, then the category is automatically deleted.*

**Syntax** `match <word>`  
`no match <word>`

| Parameter                 | Description                                                         |
|---------------------------|---------------------------------------------------------------------|
| <code>&lt;word&gt;</code> | A string that is used to compare with IP addresses or domain names. |

**Mode** Web Control Category Configuration

**Usage** Match criteria are case-insensitive and matched up to the first appearance of '?' (query string marker) or '#' (fragment identifier) in a website URL. For example, URL [www.alliedtelesis.com/search.aspx?keyword=routers](http://www.alliedtelesis.com/search.aspx?keyword=routers) does not match the match criterion `match router` but [www.alliedtelesis.com/routers](http://www.alliedtelesis.com/routers) does match that criterion.

When a URL matches a match criterion, the URL is categorized to the match criterion's category. A URL can be matched to more than one category. Custom match criteria override and precede provider categorization. If a URL or website matches custom criteria, then the URL will not be further sent for categorization by the provider criteria.

You can create up to 50 match criteria in total, so a category can have a maximum of 50 match criteria, or 50 categories can each have one match criterion, as long as the total number of the match criteria does not exceed 50.

For more information about categories, see the [category \(Web Control\)](#) command.

**Examples** To create a match criterion with a string `ietf` for category `work`, use the commands:

```
awplus# configure terminal
awplus(config)# web-control
awplus(config-web-control)# category work
awplus(config-category)# match ietf
```

To delete a match criterion, use the commands:

```
awplus# configure terminal
awplus(config)# web-control
awplus(config-web-control)# category work
awplus(config-category)# no match ietf
```

To create a set of match criteria for category `movie`, use the commands:

```
awplus# configure terminal
awplus(config)# web-control
awplus(config-web-control)# category movie
awplus(config-category)# match youtube
awplus(config-category)# match imdb
awplus(config-category)# match rottentomatoes
```

**Related  
commands**

[category \(Web Control\)](#)  
[show web-control categories](#)

# move rule (Web Control)

**Overview** Use this command to change the order of the Web Control rules. Note that a change to the rule order may change the Web Control results.

**Syntax** `move rule <1-65535> to <1-65535>`

| Parameter                                  | Description                                                                                                                                                                                                                          |
|--------------------------------------------|--------------------------------------------------------------------------------------------------------------------------------------------------------------------------------------------------------------------------------------|
| <code>move rule<br/>&lt;1-65535&gt;</code> | Move the ID of a given rule. The rule ID of the given rule must exist.<br>Each rule has an ID which is either designated by the user or automatically generated when the rule is created. The rule ID is an integer from 1 to 65535. |
| <code>to &lt;1-65535&gt;</code>            | New rule ID to assign. The new rule ID must not be used by any existing rule.                                                                                                                                                        |

**Mode** Web Control Configuration

**Usage** If a website is categorized into multiple categories because they have overlapping match criteria that have associated rules, only the rule with the lowest ID is applied. For example, a website is categorized into both category A associated with rule ID 1 and category B associated with ID 2. In this case, only category A's rule with ID 1 is applied to the website. To see the rule IDs, use the [show web-control rules](#) command.

You can move an existing rule ID only to an ID that is not assigned to any rule, otherwise you will be given an error message.

**Examples** To change the ID of a rule from 20 to 10, use the commands:

```
awplus# configure terminal
awplus(config)# web-control
awplus(config-web-control)# move rule 20 to 10
```

**Related commands** [rule \(Web Control\)](#)  
[show web-control rules](#)

# protect (Web Control)

**Overview** Use this command to enable Web Control protection.  
Use the **no** variant of this command to disable Web Control protection without losing existing Web Control configuration.

**Syntax** protect  
no protect

**Default** Web Control protection is disabled by default.

**Mode** Web Control Configuration

**Usage** Web Control protection is disabled and all HTTP and HTTPS traffic is allowed by default. You must issue the [provider digitalarts](#) command to configure the categorization provider before using this command.

**Examples** To enable Web Protection protection, use the commands:

```
awplus# configure terminal
awplus(config)# web-control
awplus(config-web-control)# provider digitalarts
awplus(config-web-control)# protect
```

To disable Web Control protection, use the commands:

```
awplus# configure terminal
awplus(config)# web-control
awplus(config-web-control)# no protect
```

**Related commands** [provider digitalarts](#)  
[show web-control](#)

**Command changes** Version 5.4.7-1.1: HTTPS support added.

# provider digitalarts

**Overview** Use this command to set Digital Arts as the website categorization provider.

**Syntax** `provider digitalarts`

**Mode** Web Control Configuration

**Usage** Digital Arts provides about 100 pre-defined categories. You can use the [show web-control categories](#) command to display the list of categories. For more information about categories, see the [category \(Web Control\)](#) command.

Note that Web Control protection cannot be enabled by using the [protect \(Web Control\)](#) command until the provider is configured.

**Examples** To configure Digital Arts as the website categorization provider, use the commands:

```
awplus# configure terminal
awplus(config)# web-control
awplus(config-web-control)# provider digitalarts
awplus(config-web-control)# protect
```

**Related commands** [protect \(Web Control\)](#)  
[show web-control](#)

# rule (Web Control)

**Overview** Use this command to create a Web Control rule for a category.

Use the **no** variant of this command to remove a rule.

**Syntax** `rule [<rule-ID>] {permit|deny} <category> from <entity>`  
`no rule <1-65535>`

| Parameter  | Description                                                                                                                                                                                                           |
|------------|-----------------------------------------------------------------------------------------------------------------------------------------------------------------------------------------------------------------------|
| <rule-ID>  | Rule ID in the range from 1 through 65535. If you don't designate a rule ID, a rule ID will be automatically generated and it will be greater than the current highest rule ID.                                       |
| permit     | Set the rule's action to permit the access.                                                                                                                                                                           |
| deny       | Set the rule's action to block the access.                                                                                                                                                                            |
| <category> | Website category the rule applies to.                                                                                                                                                                                 |
| <entity>   | Source entity the rule applies to. Entity is a high level abstraction of a network device, a group of networks or subnets. For more information about entities, see <a href="#">Application and Entity Commands</a> . |

**Mode** Web Control Configuration

**Usage** A rule sets the action to take if a website matches one or more of the match criteria of the rule's category and the request's source matches the entity the rule applies to. You may create multiple rules for a category. If the request does not hit the first rule, then the request is assessed against the next. If the request does not hit any rule, then the action set by the [action \(Web Control\)](#) command is taken. The default action Web Control performs for uncategorized websites and categorized websites that do not match a rule is to deny.

A rule's action can either deny or permit an HTTP or HTTPS request. If a request hits a rule with a permit action, then the HTTP or HTTPS traffic of that website is allowed to pass through the device. If a request hits a rule with a deny action, then the HTTP or HTTPS traffic of that website is blocked and the client gets a notification page.

Entities represent logical groupings of subnets, hosts or interfaces. For more information about entities, see [Application and Entity Commands](#).

Rules are applied in order. Each rule has an ID which is either designated by the user or automatically generated. If a website is categorized into multiple categories because they have overlapping match criteria that have associated rules, only the rule with the lowest ID is applied. For example, a website is categorized into two categories: category A and category B. The rules for category A is allow, and for B is deny. If the rule ID of category A is lower than category B's,

then the action allow is applied. To see the rule IDs, use the [show web-control rules](#) command.

You can change the rule order by using the [move rule \(Web Control\)](#) command. A change to the rule order may change the Web Control results.

A new reserved keyword **any** has been added to the parameter **<category>** from release 5.4.6-2 onwards. This new keyword allows you to apply Web Control on a per entity basis. See the [Web Control Feature Overview\\_and Configuration Guide](#) for configuration examples.

If a configuration with the reserved word **any** was configured by an old release, the following error message appears at boot time:

Figure 66-2: Example error message when the reserved keyword **any** was used prior to release 5.4.6-2.

```
*WARNING: Failed to execute the following commands:
43: category any - % Category "any" is a reserved keyword
44: match a - % Invalid command or arguments
45: match b - % Invalid command or arguments
46: match c - % Invalid command or arguments
done! *
```

**Examples** To create a rule that blocks `engineer` entity from accessing websites categorized as `movie`, use the commands:

```
awplus(config-web-control)# category movie
awplus(config-category)# match youtube
awplus(config-category)# match imdb
awplus(config-category)# exit
awplus(config-web-control)# rule 10 deny movie from engineer
```

To create a rule that allows entity `engineer` to access category `work`, use the commands:

```
awplus(config-web-control)# category work
awplus(config-category)# match alliedtelesis
awplus(config-category)# exit
awplus(config-web-control)# rule permit work from engineer
```

To delete a rule, use the commands:

```
awplus(config-web-control)#no rule 10
```

To create a rule using the reserved keyword `any`:

```
awplus(config-web-control)#rule deny badsites from private
awplus(config-web-control)# rule permit any from private
```

Rules are processed in order. In this example above the access to URLs associated with the named category "badsites" being accessed from the named firewall entity `private` will be blocked via the deny rule. Access to all other URLs originating from that specific firewall entity will be allowed via the subsequent permit any rule.

**Related commands** show running-config  
show running-config web-control  
show web-control categories  
show web-control rules

**Command changes** Version 5.4.7-1.1: HTTPS support added.  
Version 5.4.6-2.1: New category keyword 'any' added.



# show debugging web-control

**Overview** Use this command to show the Web Control debugging status.

**Syntax** `show debugging web-control`

**Mode** Privileged Exec

**Examples** To show the Web Control debugging status, use the command:

```
awplus# show debugging web-control
```

**Output** Figure 66-3: Example output from the **show debugging web-control** command

```
awplus#show debugging web-control
Web Control Debugging Status: on
```

**Related commands** [debug web-control](#)

# show running-config web-control

**Overview** Use this command to show the configuration information about Web Control.

**Syntax** `show running-config web-control`

**Mode** Privileged Exec

**Examples** To show the running configuration of Web Control, use the command:

```
awplus# show running-config web-control
```

**Output** Figure 66-4: Example output from **show running-config web-control**

```
awplus#show running-config web-control
web-control
 provider digitalarts
 protect
!
```

**Related commands**

- [rule \(Web Control\)](#)
- [show running-config](#)
- [show web-control](#)
- [web-control](#)

# show web-control

**Overview** Use this command to display the information about the state of Web Control.

**Syntax** show web-control

**Mode** Privileged Exec

**Examples** To show the Web Control configuration, use the command:

```
awplus# show web-control
```

**Output** Figure 66-5: Example output from the **show web-control** command if the subscription license of Web Control is active.

```
awplus#show web-control
Web Control protection is enabled
Web Control default action is deny
Web Control is licensed
Categorization provider is Digital Arts
Statistics:
 Categorization hits: 40/40 (100.0%)
 Rule hits: 20/40 (50.0%)
 Cache hits: 30/40 (75.0%)
 Cache size: 40
```

Figure 66-6: Example output from the **show web-control** command if the subscription license of Web Control is inactive.

```
awplus#show web-control
Web Control protection is enabled
Web Control default action is deny
Web Control is unlicensed
Categorization provider is Digital Arts
Statistics:
 Categorization hits: 0/0 (0.0%)
 Rule hits: 0/0 (0.0%)
 Cache hits: 0/0 (0.0%)
 Cache size: 0
```

| Output Parameter for Statistics | Description                                                                                              |
|---------------------------------|----------------------------------------------------------------------------------------------------------|
| Categorization hits             | The number of times the categories have been hit divided by the total number of HTTP and HTTPS requests. |
| Rule hits                       | The number of times the rules have been hit divided by the total number of requests.                     |

| Output Parameter for Statistics | Description                                                                                                |
|---------------------------------|------------------------------------------------------------------------------------------------------------|
| Cache hits                      | The number of times the cached websites have been hit divided by the total number of request to the cache. |
| Cache size                      | The number of websites that are currently cached in the system.                                            |

**Related commands**

- [rule \(Web Control\)](#)
- [show running-config](#)
- [show running-config web-control](#)
- [show web-control categories](#)
- [web-control](#)

# show web-control categories

**Overview** Use this command to display all Web Control categories, including custom and provider categories.  
For more information about categories, see the [category \(Web Control\)](#) command.

**Syntax** `show web-control categories`

**Mode** Privileged Exec

**Examples** To show all Web Control categories, use the command:

```
awplus# show web-control categories
```

**Output** Figure 66-7: Example output from the **show web-control categories** command

| Category                                | Category Hits | Custom |
|-----------------------------------------|---------------|--------|
| Custom Matches                          |               |        |
| -----                                   |               |        |
| Advertisement                           | 0             | yes    |
| AdWords                                 |               |        |
| YellowPages                             |               |        |
| Advocacy                                | 0             |        |
| "Alcohol, Tobacco"                      | 0             |        |
| "Amusement Facilities"                  | 0             |        |
| "Audio Streaming"                       | 0             |        |
| Blogs                                   | 0             |        |
| "Browser Crashing Sites"                | 0             |        |
| "Celebrities, Entertainment"            | 0             |        |
| Chat                                    | 0             |        |
| "Comics, Animation"                     | 0             |        |
| "Consumer Lending"                      | 0             |        |
| "Coupon Sites"                          | 0             |        |
| "Credit Cards, Online Payment, E-Money" | 0             |        |
| "Crime, Weapons"                        | 0             |        |
| --More--                                |               |        |

| Output Parameter | Description                                                                                                                    |
|------------------|--------------------------------------------------------------------------------------------------------------------------------|
| Category         | Category names, including both provider categories and custom categories.                                                      |
| Custom Matches   | Custom match criteria.                                                                                                         |
| Category Hits    | The number of times the category has been hit - that is, the number of times a website has been categorized into the category. |
| Custom           | Indicate whether the category is custom category or not. Those that are not custom are provider categories.                    |

**Related commands** rule (Web Control)  
show running-config web-control  
show web-control rules  
web-control

# show web-control rules

**Overview** Use this command to display the Web Control rules.  
For more information about rules, see the [rule \(Web Control\)](#) command.

**Syntax** `show web-control rules`

**Mode** Privileged Exec

**Examples** To show all Web Control rules, use the command:

```
awplus# show web-control rules
```

**Output** Figure 66-8: Example output from the **show web-control rules** command

```
#show web-control rules
ID Action Category From Hits

10 deny "Online Trading" rd.test.qa 0
20 permit "Browser Crashing Sites" market.sales 1
25 permit suspicious_sites rd 2
```

| Output Parameter | Description                                |
|------------------|--------------------------------------------|
| ID               | Rule ID.                                   |
| Action           | The action taken whenever the rule is hit. |
| Category         | The category the rule applies to.          |
| From             | The source entity the rule applies to.     |
| Hits             | The number of times the rule has been hit. |

**Related commands**

- [rule \(Web Control\)](#)
- [show running-config web-control](#)
- [show web-control categories](#)
- [web-control](#)

# web-control

**Overview** Use this command to enter the Web Control Configuration mode and configure Web Control functionality.

Use the **no** variant of this command to remove all configuration for Web Control. Custom categories, rules and other configuration associated with Web Control will be deleted.

**Syntax** `web-control`  
`no web-control`

**Mode** Global Configuration

**Usage** This command allows you to enter the Web Control Configuration mode. This mode also contains the sub- mode of Web Control Category Configuration. For more information about the sub-mode, see the [category \(Web Control\)](#) command.

The Web Control Configuration mode enables you to:

- Enable Web Control protection, see the [protect \(Web Control\)](#) command.
- Configure the website categorization provider, see the [provider digitalarts](#) command.
- Create categories and associated match criteria, see the [category \(Web Control\)](#) command.
- Create, delete and move rules for categories, see the [rule \(Web Control\)](#) command and the [move rule \(Web Control\)](#) command.
- Configure the default action for HTTP and HTTPS requests that do not hit any rule, see the [action \(Web Control\)](#) command.

If you want to disable Web Control protection without removing the configuration, you can use the **no** variant of the [protect \(Web Control\)](#) command to do so.

**Examples** To enter the Web Control Configuration mode, use the commands:

```
awplus# configure terminal
awplus(config)# web-control
awplus(config-web-control)#
```

To destroy all Web Control configuration, use the commands:

```
awplus# configure terminal
awplus(config)# no web-control
```

**Related commands** [show running-config](#)  
[show running-config web-control](#)  
[show web-control](#)



**Command changes** Version 5.4.7-1.1: HTTPS support added.

# 67

# Application Control Commands

## Introduction

This chapter provides an alphabetical reference of commands used to configure Application Control which uses Deep Packet Inspection (DPI). For more information about Application Control introduction and configuration example, see the [Application Control Feature Overview and Configuration\\_Guide](#).

The table below lists the Application Control commands and their applicable modes.

Figure 67-1: Application Control Commands and Applicable Modes

| Mode                 | Command                                            |
|----------------------|----------------------------------------------------|
| Privileged Exec      | <code>show dpi</code>                              |
|                      | <code>show dpi statistics</code>                   |
|                      | <code>show running-config dpi</code>               |
| Global Configuration | <code>dpi</code>                                   |
| DPI Mode             | <code>enable (DPI)</code>                          |
|                      | <code>provider procera</code>                      |
|                      | <code>update-interval (Application Control)</code> |

- Command List**
- [“dpi”](#) on page 2772
  - [“enable \(DPI\)”](#) on page 2773
  - [“provider procera”](#) on page 2774
  - [“show dpi”](#) on page 2775
  - [“show dpi statistics”](#) on page 2776
  - [“show running-config dpi”](#) on page 2777

- [“update-interval \(Application Control\)”](#) on page 2778

# dpi

**Overview** Use this command to configure DPI.

Use the **no** variant of this command to remove all DPI configuration.

**Syntax** dpi  
no dpi

**Mode** Global Configuration

**Usage** This command allows you to enter the DPI mode. The command prompt for this mode is **awplus(config-dpi)#**.

In the DPI mode, you can:

- Set the DPI provider, see the [provider procera](#) command.
- Enable DPI, see the [enable \(DPI\)](#) command.

**Examples** To configure DPI, use the commands:

```
awplus# configure terminal
awplus(config)# dpi
awplus(config-dpi)#
```

To remove all DPI configuration, use the commands:

```
awplus# configure terminal
awplus(config)# no dpi
```

# enable (DPI)

**Overview** Use this command to enable DPI .

Use the **no** variant of this command to disable DPI without losing existing DPI configuration.

**Syntax** enable  
no enable

**Default** DPI is disabled by default.

**Mode** DPI Mode

**Usage** You need to use the [provider procera](#) command to configure the DPI provider before enabling DPI.

When DPI is enabled, the DPI engine can classify network traffic and identify today's most common applications.

DPI itself does not control or apply rules to the traffic. You can use the [rule \(Firewall\)](#) command to enforce security policy and apply rules to the DPI applications. You can use the [show dpi statistics](#) command to show statistics for the applications being inspected by DPI.

DPI is disabled by default and all traffic is not classified.

**Examples** To enable DPI, use the commands:

```
awplus# configure terminal
awplus(config)# dpi
awplus(config-dpi)# provider procera
awplus(config-dpi)# enable
```

To disable DPI, use the commands:

```
awplus# configure terminal
awplus(config)# dpi
awplus(config-dpi)# no enable
```

**Related Commands** [provider procera](#)

**Validation Commands** [show dpi](#)  
[show running-config dpi](#)

# provider procera

**Overview** Use this command to set DPI provider.

Application Control using DPI identifies applications by matching packets to a database of up-to-date and predefined application signature provided by Procera Networks.

You can use the [show dpi](#) command to view the provider's current version.

**Syntax** `provider procera`

**Mode** DPI Mode

**Usage** If DPI is enabled, you can use the [show application](#) command and the [show application detail](#) command to view all DPI applications defined by Procera.

Note that custom applications override DPI applications, which override AlliedWare Plus predefined applications. For more information about applications, see the [application](#) command.

Note that you need to issue this command before using the [enable \(DPI\)](#) command to enable DPI.

**Examples** To set DPI provider, use the commands:

```
awplus# configure terminal
awplus(config)# dpi
awplus(config-dpi)# provider procera
```

**Related Commands** [enable \(DPI\)](#)

**Validation Commands** [show application detail](#)  
[show dpi](#)  
[show running-config dpi](#)

# show dpi

**Overview** Use this command to show the DPI configuration state, including the provider's current version.

**Syntax** show dpi

**Mode** Privileged Exec

**Examples** To show the DPI configuration state and provider's current version, use the command:

```
awplus# show dpi
```

**Output** Figure 67-2: Example output from the **show dpi** command if the subscription license of Application Control is active.

```
awplus#show dpi
Status: running
Provider: procera
Resource version: 1.0
Resource update interval: 1 hour
```

Figure 67-3: Example output from the **show dpi** command if the subscription license of Application Control is inactive.

```
awplus#show dpi
awplus#show dpi
Status: unlicensed
Provider: procera
Resource version: not set
Resource update interval: 1 hour
```

# show dpi statistics

**Overview** Use this command to show statistics for each application being inspected by DPI. This command gives you counts of the total number of packets and bytes of the applications being inspected by DPI. You can use the [rule \(Firewall\)](#) command to enforce security policy and apply rules to the DPI applications.

**Syntax** `show dpi statistics`

**Mode** Privileged Exec

**Examples** To display the statistics for each application being inspected by DPI, use the command:

```
awplus# show dpi statistics
```

**Output** Figure 67-4: Example output from the **show dpi statistics** command on the console.

```
awplus#show dpi statistics
```

| Application | Packets | Bytes |
|-------------|---------|-------|
| http        | 30      | 2020  |
| icmp        | 348     | 29232 |
| telnet      | 45      | 2553  |



# show running-config dpi

**Overview** Use this command to show the configuration commands that have been used to configure DPI.

**Syntax** `show running-config dpi`

**Mode** Privileged Exec

**Examples** To show the configuration commands that have been used to configure DPI, use the command:

```
awplus# show running-config dpi
```

**Output** Figure 67-5: Example output from the **show running-config dpi** command

```
awplus#show running-config dpi
dpi
 provider procera
 enable
!
```

# update-interval (Application Control)

**Overview** Use this command to configure the update check interval for the DPI resource files. Use the **no** variant of this command to restore the default update check interval to 1 hour.

**Syntax** `update-interval {minutes <10-525600>|hours <1-8760>|days <1-365>|weeks <1-52>|never}`  
`no update-interval`

| Parameter           | Description                                                                                                                                                                                     |
|---------------------|-------------------------------------------------------------------------------------------------------------------------------------------------------------------------------------------------|
| minutes <10-525600> | Update interval from 10 through 52600 minutes                                                                                                                                                   |
| hours <1-8760>      | Update interval from 1 hour through 8760 hours                                                                                                                                                  |
| days <1-365>        | Update interval from 1 day through 365 days                                                                                                                                                     |
| weeks <1-52>        | Update interval from 1 week through 52 weeks                                                                                                                                                    |
| never               | Never update the resource. If DPI becomes enabled, the Update Manager will do update check and update the resource files if needed. Use the <a href="#">enable (DPI)</a> command to enable DPI. |

**Default** The default update interval is 1 hour.

**Mode** DPI Mode

**Usage** The Update Manager will perform an update check for a resource when triggered by an update check interval. It will request the current version number of the resource from the Update Server, then compare it with the current local version. If they are different, the Update Manager will initiate an update of the local resource.

Note that when a feature is disabled, regular and manual update checks for its resources are disabled.

Also note that an update check for a resource will not proceed if an update of that resource is already in progress.

**Examples** To check and update the DPI resource files once a week, use the following command:

```
awplus(config-dpi)# update-interval weeks 1
```

To disable updating of the resource, use the following command:

```
awplus(config-dpi)# update-interval never
```

To restore the default update interval, which is 1 hour, use the following command:

```
awplus(config-dpi)# no update-interval
```

**Validation** show resource  
**Command**

# 68

# IP Reputation Commands

## Introduction

This chapter provides an alphabetical reference of commands used to configure AlliedWare Plus IP Reputation. For more information about IP Reputation introduction and configuration example, see the [IP Reputation Feature Overview and Configuration\\_Guide](#).

The table below lists the IP Reputation commands and their applicable modes.

Figure 68-1: IP Reputation Commands and Applicable Modes

| Mode                 | Command                                          |
|----------------------|--------------------------------------------------|
| Privileged Exec      | <code>show ip-reputation</code>                  |
|                      | <code>show ip-reputation categories</code>       |
|                      | <code>show running-config ip-reputation</code>   |
| Global Configuration | <code>ip-reputation</code>                       |
| IP Reputation Mode   | <code>category action (IP Reputation)</code>     |
|                      | <code>protect (IP Reputation)</code>             |
|                      | <code>provider proofpoint (IP Reputation)</code> |
|                      | <code>update-interval (IP Reputation)</code>     |

- Command List**
- “[category action \(IP Reputation\)](#)” on page 2782
  - “[ip-reputation](#)” on page 2784
  - “[protect \(IP Reputation\)](#)” on page 2785
  - “[provider proofpoint \(IP Reputation\)](#)” on page 2786
  - “[show ip-reputation](#)” on page 2787
  - “[show ip-reputation categories](#)” on page 2788

- [“show running-config ip-reputation”](#) on page 2790
- [“update-interval \(IP Reputation\)”](#) on page 2791

# category action (IP Reputation)

**Overview** Use this command to configure an action for a specified category.  
Use the **no** variant of this command to set action for a specified category to default, which is alert.

**Syntax** `category <category-name> action {alert|deny|disable}`  
`no category <category-name> action`

| Parameter                          | Description                                                                                                                                                                                                                                                                                         |
|------------------------------------|-----------------------------------------------------------------------------------------------------------------------------------------------------------------------------------------------------------------------------------------------------------------------------------------------------|
| <code>&lt;category-name&gt;</code> | Category name. A category contains a group of IP reputation criteria that are used to classify the nature of a host reputation. A host may have a reputation in multiple categories. You can use the <a href="#">show ip-reputation categories</a> command to view the categories and their status. |
| <code>alert</code>                 | Generate a log message. This is the default action.                                                                                                                                                                                                                                                 |
| <code>deny</code>                  | Drop matching packets. No error message is sent back to the source host.                                                                                                                                                                                                                            |
| <code>disable</code>               | Ignore a specified category. Ignored categories will not be used to categorize traffic.                                                                                                                                                                                                             |

**Default** The default action is alert.

**Mode** IP Reputation Mode

**Usage** You can only configure the categories from the IP Reputation database provider, which is Proofpoint. You can use the [show ip-reputation categories](#) command to see the list of IP Reputation categories.

**NOTE:** Note that you should use the [provider proofpoint \(IP Reputation\)](#) command to configure the provider before configuring the action.

**Examples** To drop packets categorized as P2P, use the commands:

```
awplus# configure terminal
awplus(config)# ip-reputation
awplus(config-ip-reputation)# provider proofpoint
awplus(config-ip-reputation)# category P2P action deny
```

To set the action for category P2P to default, use the commands:

```
awplus# configure terminal
awplus(config)# ip-reputation
awplus(config-ip-reputation)# no category P2P action
```

**Related  
Commands**    `show ip-reputation categories`  
                  `show running-config ip-reputation`

# ip-reputation

**Overview** Use this command to configure IP Reputation.  
Use the **no** variant of this command to remove all IP Reputation configuration.

**Syntax** ip-reputation  
no ip-reputation

**Mode** Global Configuration

**Usage** This command allows you to enter the IP Reputation mode. The command prompt for this mode is **awplus(config-ip-reputation)#**.

In the IP Reputation mode, you can:

- Set or remove the IP Reputation database provider, see the [provider proofpoint \(IP Reputation\)](#) command.
- Enable or disable IP Reputation protection, see the [protect \(IP Reputation\)](#) command.
- Configure the action for specified categories, see the [category action \(IP Reputation\)](#) command.

**Examples** To configure IP Reputation, use the commands:

```
awplus# configure terminal
awplus(config)# ip-reputation
awplus(config-ip-reputation)#
```

To remove all IP Reputation configuration, use the commands:

```
awplus# configure terminal
awplus(config)# no ip-reputation
```

**Related Commands** [show ip-reputation](#)  
[show running-config ip-reputation](#)



# protect (IP Reputation)

**Overview** Use this command to enable IP Reputation protection.

Use the **no** variant of this command to disable IP Reputation protection without losing existing configuration.

Once IP Reputation protection is enabled, traffic will be categorized according to the available IP Reputation categories. See the [show ip-reputation categories](#) command for the list of available IP Reputation categories.

Note that you should use the [provider proofpoint \(IP Reputation\)](#) command to set the IP Reputation database provider before issuing this command.

**Syntax** protect  
no protect

**Default** IP Reputation protection is disabled by default.

**Mode** IP Reputation Mode

**Examples** To enable IP Reputation protection, use the commands:

```
awplus# configure terminal
awplus(config)# ip-reputation
awplus(config-ip-reputation)# provider proofpoint
awplus(config-ip-reputation)# protect
```

To disable IP Reputation protection, use the commands:

```
awplus# configure terminal
awplus(config)# ip-reputation
awplus(config-ip-reputation)# no protect
```

**Related Commands** [show ip-reputation](#)  
[show running-config ip-reputation](#)

# provider proofpoint (IP Reputation)

**Overview** Use this command to set the IP Reputation database provider.

Proofpoint provides a database of IP reputation based on threat analysis. The database is regularly updated and can deliver the latest information of identified and potentially harmful IP addresses classified in categories.

If the provider is configured, you can use the [show ip-reputation categories](#) command to show the category details from the provider.

The default action for all categories is alert and you can use the [category action \(IP Reputation\)](#) command to set the action for a specified category.

**Syntax** `provider proofpoint`

**Mode** IP Reputation Mode

**Examples** To set the IP Reputation database provider, use the commands:

```
awplus# configure terminal
awplus(config)# ip-reputation
awplus(config-ip-reputation)# provider proofpoint
```

**Related Commands**

- [show ip-reputation](#)
- [show running-config ip-reputation](#)
- [show ip-reputation categories](#)

# show ip-reputation

**Overview** Use this command to show the IP Reputation configuration state, including the IP Reputation database provider.

**Syntax** `show ip-reputation`

**Mode** Privileged Exec

**Examples** To show the IP Reputation configuration state, use the command:

```
awplus# show ip-reputation
```

**Output** Figure 68-2: Example output from **show ip-reputation** if the IP Reputation subscription license is active.

```
awplus#show ip-reputation
Status: Enabled (Active)
Events: 23
Provider: Proofpoint
 Resource version: 1.0
 Entry count: 148357
 Status: Enabled
Resource update interval: 1 hour
```

**Related Commands** [ip-reputation](#)

**Command changes** Version 5.4.7-0.1: Event count added to the command output.

# show ip-reputation categories

**Overview** Use this command to show the IP Reputation category details.

Note that you need to use the [provider proofpoint \(IP Reputation\)](#) command to set the IP Reputation database provider before issuing this command.

**Syntax** `show ip-reputation categories`

**Mode** Privileged Exec

**Examples** To show the IP Reputation category details, use the command:

```
awplus# show ip-reputation categories
```

**Output** Figure 68-3: Example output from the **show ip-reputation categories** command

```
awplus#show ip-reputation categories

Category(* = invalid) Action Description

AbusedTLD alert Abused or free TLD Related
Bitcoin_Related alert Bitcoin Mining and related
Blackhole alert Blackhole or Sinkhole systems
Bot alert Known Infected Bot
Brute_Forcer alert SSH or other brute forcer
ChatServer alert POLICY Chat Server
CnC alert Malware Command and Control Server
Compromised alert Known compromised or Hostile
DDoSAttacker alert DDoS Source
DriveBySrc alert Driveby Source
Drop alert Drop site for logs or stolen credentials
DynDNS alert Domain or IP Related to a Dynamic DNS Entry
 or Request
EXE_Source alert Suspicious exe or dropper service
FakeAV alert Fake AV and AS Products
IPCheck alert IP Check Services
Mobile_CnC alert Known CnC for Mobile specific Family
Mobile_Spyware_CnC alert Spyware CnC specific to mobile devices
OnlineGaming alert Questionable Gaming Site
P2P alert P2P Node
P2PCnC alert Distributed CnC Nodes
Parking alert Domain or SEO Parked
RemoteAccessService alert GoToMyPC and similar remote access services
Scanner alert Host Performing Scanning
Skype_SuperNode alert Observed Skype Bootstrap or Supernode
Spam alert Known Spam Source
SpywareCNS alert Spyware Reporting Server
TorNode alert POLICY Tor Node
Undesirable alert Undesirable but not illegal
Utility alert Known Good Public Utility
VPN alert VPN Server
```

**Related  
Commands** [category action \(IP Reputation\)](#)

# show running-config ip-reputation

**Overview** Use this command to show the configuration commands that have been used to configure IP Reputation.

**Syntax** `show running-config ip-reputation`

**Mode** Privileged Exec

**Examples** To show the commands that have been used to configure IP Reputation, use the command:

```
awplus# show running-config ip-reputation
```

**Output** Figure 68-4: Example output from the **show running-config ip-reputation** command

```
awplus#show running-config ip-reputation
ip-reputation
 provider proofpoint
 protect
!
```

# update-interval (IP Reputation)

**Overview** Use this command to configure an update check interval for the IP Reputation resource files.

Use the **no** variant of this command to restore the default update check interval to 1 hour.

**Syntax** `update-interval {minutes <10-525600>|hours <1-8760>|days <1-365>|weeks <1-52>|never}`  
`no update-interval`

| Parameter           | Description                                                                                                                                                                                                                    |
|---------------------|--------------------------------------------------------------------------------------------------------------------------------------------------------------------------------------------------------------------------------|
| minutes <10-525600> | Update interval from 10 through 52600 minutes                                                                                                                                                                                  |
| hours <1-8760>      | Update interval from 1 hour through 8760 hours                                                                                                                                                                                 |
| days <1-365>        | Update interval from 1 day through 365 days                                                                                                                                                                                    |
| weeks <1-52>        | Update interval from 1 week through 52 weeks                                                                                                                                                                                   |
| never               | Never update the resource. If IP Reputation becomes enabled, the Update Manager will do update check and update the resource files if needed. Use the <a href="#">protect (IP Reputation)</a> command to enable IP Reputation. |

**Default** The default update interval is 1 hour.

**Mode** IP Reputation Mode

**Usage** The Update Manager will perform an update check for a resource when triggered by an update check interval. It will request the current version number of the resource from the Update Server, then compare it with the current local version. If they are different, the Update Manager will initiate an update of the local resource.

Note that when a feature is disabled, regular and manual update checks for its resources are disabled.

Also note that an update check for a resource will not proceed if an update of that resource is already in progress.

**Examples** To check and update the IP Reputation resource files once a week, use the following command:

```
awplus(config-ip-reputation)# update-interval weeks 1
```

To disable updating of the resource, use the following command:

```
awplus(config-ip-reputation)# update-interval never
```

To restore the default update interval, which is 1 hour, use the following command:

```
awplus(config-ip-reputation)# no update-interval
```

**Related  
Commands** [show resource](#)



# Part 10: Virtual Private Networks (VPNs)

# 69

# IPsec Commands

## Introduction

This chapter provides an alphabetical reference of commands used to configure Internet Protocol Security (IPsec) tunnel.

For introductory information about IPsec tunnel in AlliedWare Plus, including overview and configuration information, see the [Internet Protocol Security \(IPsec\) Feature Overview and Configuration Guide](#).

- Command List**
- [“clear isakmp sa”](#) on page 2796
  - [“crypto ipsec profile”](#) on page 2797
  - [“crypto isakmp key”](#) on page 2799
  - [“crypto isakmp peer”](#) on page 2801
  - [“crypto isakmp profile”](#) on page 2803
  - [“debug isakmp”](#) on page 2805
  - [“dpd-interval”](#) on page 2807
  - [“dpd-timeout”](#) on page 2808
  - [“interface tunnel”](#) on page 2809
  - [“lifetime \(IPsec Profile\)”](#) on page 2810
  - [“lifetime \(ISAKMP Profile\)”](#) on page 2811
  - [“no debug isakmp”](#) on page 2812
  - [“pfs”](#) on page 2813
  - [“show debugging isakmp”](#) on page 2815
  - [“show interface tunnel \(IPsec\)”](#) on page 2816
  - [“show ipsec counters”](#) on page 2817
  - [“show ipsec peer”](#) on page 2818
  - [“show ipsec policy”](#) on page 2819

- [“show ipsec profile”](#) on page 2820
- [“show ipsec sa”](#) on page 2822
- [“show isakmp counters”](#) on page 2823
- [“show isakmp key \(IPsec\)”](#) on page 2824
- [“show isakmp peer”](#) on page 2825
- [“show isakmp profile”](#) on page 2826
- [“show isakmp sa”](#) on page 2828
- [“transform \(IPsec Profile\)”](#) on page 2829
- [“transform \(ISAKMP Profile\)”](#) on page 2830
- [“tunnel destination \(IPsec\)”](#) on page 2832
- [“tunnel local name \(IPsec\)”](#) on page 2834
- [“tunnel local selector”](#) on page 2835
- [“tunnel mode \(IPsec\)”](#) on page 2837
- [“tunnel protection ipsec \(IPsec\)”](#) on page 2838
- [“tunnel remote name \(IPsec\)”](#) on page 2839
- [“tunnel remote selector”](#) on page 2840
- [“tunnel source \(IPsec\)”](#) on page 2842
- [“undebg isakmp”](#) on page 2844
- [“version \(ISAKMP\)”](#) on page 2845

# clear isakmp sa

**Overview** Use this command to delete Internet Security Association Key Management Protocol (ISAKMP) Security Associations (SAs). SAs specify the Security Parameter Index (SPI), protocols, algorithms and keys for protecting a single flow of traffic between two IPsec peers. For more information about SA, see the [Internet Protocol Security \(IPSec\) Feature Overview and Configuration Guide](#).

**Syntax** `clear [crypto] isakmp sa [peer <ipv4-addr>|<ipv6-addr>|<hostname>] [force]`

| Parameter   | Description                                                          |
|-------------|----------------------------------------------------------------------|
| <ipv4-addr> | Destination IPv4 address. The IPv4 address uses the format A.B.C.D.  |
| <ipv6-addr> | Destination IPv6 address. The IPv4 address uses the format X:X::X:X. |
| <hostname>  | Destination host name.                                               |
| force       | Force to clear ISAKMP SAs without negotiating with the peer.         |

**Mode** Privileged Exec

**Examples** To delete the ISAKMP security associations at the peer for an IPv6 address, use the command:

```
awplus# clear isakmp sa peer 2001:0db8::1
```

To delete the ISAKMP security associations at the peer for an IPv4 address, use the command:

```
awplus# clear isakmp sa peer 192.168.2.1
```

To delete the ISAKMP security associations at the peer for a host name, use the command:

```
awplus# clear isakmp sa peer remote.example.com
```

**Related Commands** [crypto isakmp key](#)  
[show isakmp sa](#)

**Command Changes** Version 5.4.7-0.1: Parameter <hostname> added for DDNS feature.

# crypto ipsec profile

**Overview** Use this command to configure a custom IPsec profile.

An IPsec profile comprises one or more transforms that can be configured by using the [transform \(IPsec Profile\)](#) command.

Use the **no** variant to delete a previously created profile.

**Syntax** `crypto ipsec profile <profile_name>`  
`no crypto ipsec profile <profile_name>`

| Parameter                         | Description                                                                                                                                                                                                                                |
|-----------------------------------|--------------------------------------------------------------------------------------------------------------------------------------------------------------------------------------------------------------------------------------------|
| <code>&lt;profile_name&gt;</code> | Profile name. Profile names are case insensitive and can be up to 64 characters long composed of printable ASCII characters. Profile names can have only letters from a to z and A to Z, numbers from 0 to 9, - (dash), or _ (underscore). |

**Default** The default IPsec profile with transforms in order of preference is listed in the following table. Which IPsec profile will actually be used depends on how the negotiation between the peers is carried out when establishing the connection. Note that you cannot delete or edit the default profile. Expiry time of 8 hours applies to the default IPsec profile.

Table 69-1: IPsec default profile

| Attribute            | Transform 1 | Transform 2 | Transform 3 | Transform 4 | Transform 5 | Transform 6 |
|----------------------|-------------|-------------|-------------|-------------|-------------|-------------|
| Protocol             | ESP         | ESP         | ESP         | ESP         | ESP         | ESP         |
| Encryption (all CBC) | AES256      | AES256      | AES128      | AES128      | 3DES        | 3DES        |
| Integrity (all HMAC) | SHA256      | SHA1        | SHA256      | SHA1        | SHA256      | SHA1        |

**Mode** Global Configuration

**Examples** To configure a custom IPsec profile for establishing IPsec SAs with a remote peer, use the following commands:

```
awplus# configure terminal
awplus(config)# crypto ipsec profile my_profile
awplus(config-ipsec-profile)# transform 2 protocol esp
integrity sha1 encryption 3des
```

To delete a custom profile, use the following commands:

```
awplus# configure terminal
awplus(config)# no crypto ipsec profile my_profile
```

**Related  
Commands**    lifetime (IPsec Profile)  
                  transform (IPsec Profile)

**Validation  
Commands**    show ipsec profile

# crypto isakmp key

**Overview** Use this command to configure a pre-shared authentication key.

Pre-shared key authentication uses optionally encrypted shared keys identified by hostname, IPv4 or IPv6 address. Pre-shared keys are not viewable and stored encrypted in the running-configuration.

You must configure this key whenever you specify pre-shared keys in an (Internet Key Exchange) IKE policy and at both peers.

To use the **no** variant to remove a previously created pre-shared key.

**Syntax** `crypto isakmp key [8] <key> {hostname <hostname>|address {<ipv4-addr>|<ipv6-addr>}}`  
`no crypto isakmp key [8] <key> {hostname <hostname>|address {<ipv4-addr>|<ipv6-addr>}}`

| Parameter   | Description                                                                                                           |
|-------------|-----------------------------------------------------------------------------------------------------------------------|
| crypto      | Security specific command.                                                                                            |
| isakmp      | Internet Security Association Key Management Protocol provides a common framework for key management implementations. |
| key         | Pre-shared key.                                                                                                       |
| <key>       | Specify the pre-shared key. Us any combination of alphanumeric characters up to 128 bytes.                            |
| 8           | Specifies that an encrypted key follows.                                                                              |
| <hostname>  | Destination hostname.                                                                                                 |
| <ipv4-addr> | Destination IPv4 address. The IPv4 address uses the format A.B.C.D.                                                   |
| <ipv6-addr> | Destination IPv6 address. The IPv6 address uses the format X:X::X:X.                                                  |

**Default** ISAKMP keys do not exist.

**Mode** Global Configuration

**Examples** To configure a pre-shared authentication key for a destination host, use the commands below:

```
awplus# configure terminal
awplus(config)# crypto isakmp key friend hostname
mypeer@my.domain.com
```

To configure a pre-shared authentication key at a peer with IPv4 address, use the commands below:

```
awplus# configure terminal
awplus(config)# crypto isakmp key friend address
192.168.1.1
```

To configure a pre-shared encrypted authentication key at a peer with IPv4 address, use the commands below:

```
awplus# configure terminal
awplus(config)# crypto isakmp
key 8 Nhe6ioQmzbysQaJr6Du+cA== address 192.168.1.2
```

To remove a pre-shared key at a peer, use the commands below:

```
awplus# configure terminal
awplus(config)# no crypto isakmp key friend hostname
mypeer@my.domain.com
```

**Related  
Commands** [show isakmp key \(IPsec\)](#)



# crypto isakmp peer

**Overview** Use this command to configure a peer to use a specific ISAKMP profile.

Use the **no** variant to set the peer back to using the default profile.

**Syntax** `crypto isakmp peer address {<ipv4-addr>|<ipv6-addr>} hostname <hostname> profile <profile-name>`

`crypto isakmp peer dynamic profile <profile-name>`

`no crypto isakmp peer address {<ipv4-addr>|<ipv6-addr>} hostname <hostname> profile`

`no crypto isakmp peer dynamic profile`

| Parameter      | Description                                                          |
|----------------|----------------------------------------------------------------------|
| <ipv4-addr>    | Destination IPv4 address. The IPv4 address uses the format A.B.C.D.  |
| <ipv6-addr>    | Destination IPv6 address. The IPv6 address uses the format X:X::X:X. |
| <hostname>     | Remote endpoint with a host name as the destination.                 |
| dynamic        | Remote endpoint with a dynamic IP address.                           |
| <profile-name> | Profile name.                                                        |

**Default** By default, all peers use the default profile.

**Mode** Global Configuration

**Examples** To configure a profile for a peer with a dynamic IP address, use the following commands:

```
awplus# configure terminal
```

```
awplus(config)# crypto isakmp peer dynamic profile peer_profile
```

To configure a profile for a peer with IPv4 address, use the following commands:

```
awplus# configure terminal
```

```
awplus(config)# crypto isakmp peer address 192.168.1.2 profile peer_profile
```

To set the profile for the peer back to default, use the following commands:

```
awplus# configure terminal
```

```
awplus(config)# no crypto isakmp peer dynamic profile
```

```
awplus# configure terminal
```

To configure a profile for a peer with a host name, use the following commands:

```
awplus(config)# crypto isakmp peer hostname user.domain.com
profile peer_profile
awplus# configure terminal
```

To set the profile for the peer back to the default, use the following commands:

```
awplus(config)# no crypto isakmp peer hostname user.domain.com
profile peer_profile
```

**Related  
Commands** [show isakmp peer](#)

**Command  
Changes** Version 5.4.7-0.1: Parameter <hostname> added for DDNS feature.

# crypto isakmp profile

**Overview** Use this command to configure a custom ISAKMP profile.

An ISAKMP profile comprises one or more transforms that can be configured by using the [transform \(ISAKMP Profile\)](#) command.

Use the **no** variant to delete a previously created profile.

**Syntax** `crypto isakmp profile <profile_name>`  
`no crypto isakmp profile <profile_name>`

| Parameter                         | Description                                                                                                                                                                                                                                |
|-----------------------------------|--------------------------------------------------------------------------------------------------------------------------------------------------------------------------------------------------------------------------------------------|
| <code>&lt;profile_name&gt;</code> | Profile name. Profile names are case insensitive and can be up to 64 characters long composed of printable ASCII characters. Profile names can have only letters from a to z and A to Z, numbers from 0 to 9, - (dash), or _ (underscore). |

**Default** Which ISAKMP profile transform will actually be used depends on how the negotiation between the peers is carried out when establishing the connection. For more information about default ISAKMP profiles, see the following table. Note that you cannot delete or edit the default profile. Expiry time of 24 hours applies to the default profile.

Table 69-2: ISAKMP default profile

| Attribute    | Encryption | Integrity | Group | Authentication |
|--------------|------------|-----------|-------|----------------|
| Transform 1  | AES256     | SHA256    | 14    | Pre-shared     |
| Transform 2  | AES256     | SHA256    | 16    | Pre-shared     |
| Transform 3  | AES256     | SHA1      | 14    | Pre-shared     |
| Transform 4  | AES256     | SHA1      | 16    | Pre-shared     |
| Transform 5  | AES128     | SHA256    | 14    | Pre-shared     |
| Transform 6  | AES128     | SHA256    | 16    | Pre-shared     |
| Transform 7  | AES128     | SHA1      | 14    | Pre-shared     |
| Transform 8  | AES128     | SHA1      | 16    | Pre-shared     |
| Transform 9  | 3DES       | SHA256    | 14    | Pre-shared     |
| Transform 10 | 3DES       | SHA256    | 16    | Pre-shared     |
| Transform 11 | 3DES       | SHA1      | 14    | Pre-shared     |
| Transform 12 | 3DES       | SHA1      | 16    | Pre-shared     |

**Mode** Global Configuration

**Examples** To configure a custom ISAKMP profile for establishing ISAKMP SAs with a remote peer, use the following commands:

```
awplus# configure terminal
awplus(config)# crypto isakmp profile my_profile
awplus(config-isakmp-profile)# transform 2 integrity sha1
encryption 3des group 5
```

To delete a custom profile, use the following commands:

```
awplus# configure terminal
awplus(config)# no crypto isakmp profile my_profile
```

**Related  
Commands**

[dpd-interval](#)  
[dpd-timeout](#)  
[lifetime \(ISAKMP Profile\)](#)  
[transform \(ISAKMP Profile\)](#)  
[version \(ISAKMP\)](#)

**Validation  
Commands**

[show isakmp profile](#)

# debug isakmp

**Overview** Use this command to enable debugging ISAKMP.

To disable debugging ISAKMP, see [no debug isakmp](#) or [undebug isakmp](#).

**Syntax** debug [crypto] isakmp [info|trace|all]

| Parameter | Description                                                                                                           |
|-----------|-----------------------------------------------------------------------------------------------------------------------|
| debug     | Debugging function.                                                                                                   |
| crypto    | Security specific command.                                                                                            |
| isakmp    | Internet Security Association Key Management Protocol provides a common framework for key management implementations. |
| info      | Informational debug messages such as protocol events.                                                                 |
| trace     | Verbose debug messages including protocol events and message traces.                                                  |
| all       | All debug enabled.                                                                                                    |

**Mode** Privileged Exec

**Examples** Figure 69-1: Example output from the **debug isakmp** command on the console.

```
awplus#debug isakmp info
awplus#terminal monitor
% Warning: Console logging enabled
awplus#show ipsec peer
21:03:42 awplus IMISH[30349]: show ipsec peer

10.2.0.10
IPSEC
 Selector: 0.0.0.0/0 0.0.0.0/0 tunnel1
 Profile: default
ISAKMP
 LocalID: 10.1.0.10
 RemoteID: 10.2.0.10
awplus#ping 192.168.1.2

PING 192.168.1.2 (192.168.1.2) 56(84) bytes of data.
21:04:13 awplus iked: [DEBUG]: ike_pfkey.c:622:sadb_acquire_callback():
sadb_acquire_callback: seq=6 reqid=409
6 satype=96 sa_src=10.1.0.10[0] sa_dst=10.2.0.10[0] samode=229 selid=1
21:04:13 awplus iked: [DEBUG]: isakmp.c:918:isakmp_initiate(): new request (seq:6
spid:1 reqid:4096)
21:04:13 awplus iked: [DEBUG]: ikev2.c:758:ikev2_initiate(): creating new ike_sa
21:04:13 awplus iked: [DEBUG]: ike_sa.c:431:ikev2_allocate_sa():
ikev2_create_sa(nil), 10.1.0.10[500], 10.2.0
.10[500], 0x810b678)
21:04:13 awplus iked: [DEBUG]: ike_sa.c:434:ikev2_allocate_sa(): sa: 0x810d3a0
21:04:13 awplus iked: [DEBUG]: ikev2.c:800:ikev2_initiate(): child_sa: 0x810dd60
21:04:13 awplus iked: [DEBUG]: ikev2_child.c:139:ikev2_child_state_set(): child_sa
0x810dd60 state IDLING -> G
ETSPI
21:04:13 awplus iked: [DEBUG]: ike_pfkey.c:269:sadb_getspi(): sadb_getspi: seq=6,
satype=96
21:04:13 awplus iked: [DEBUG]: ike_pfkey.c:622:sadb_acquire_callback():
sadb_acquire_callback: seq=7 reqid=409
6 satype=96 sa_src=10.1.0.10[0] sa_dst=10.2.0.10[0] samode=229 selid=1
21:04:13 awplus iked: [DEBUG]: isakmp.c:918:isakmp_initiate(): new request (seq:7
spid:1 reqid:4096)
21:04:13 awplus iked: [DEBUG]: ikev2.c:800:ikev2_initiate(): child_sa: 0x810ec68
21:04:13 awplus iked: [DEBUG]: ikev2_child.c:139:ikev2_child_state_set(): child_sa
0x810ec68 state IDLING -> G
ETSPI

awplus#no debug isakmp
awplus#show debugging isakmp

ISAKMP Debugging status:
 ISAKMP Informational debugging is disabled
 ISAKMP Trace debugging is disabled
```

**Related  
Commands** [no debug isakmp](#)  
[undebug isakmp](#)

# dpd-interval

**Overview** Use this command to specify the Dead Peer Detection (DPD) interval for an ISAKMP profile.

DPD is an IKE mechanism using a form of keep-alive to determine if a tunnel peer is still active.

The interval parameter specifies the amount of time the device waits for traffic from its peer before sending a DPD acknowledgment message.

Use the **no** variant to set the interval to its default (30 seconds).

**Syntax** `dpd-interval <10-86400>`  
`no dpd-interval`

| Parameter                     | Description                    |
|-------------------------------|--------------------------------|
| <code>&lt;10-86400&gt;</code> | Interval expressed in seconds. |

**Default** If you do not specify an interval, the default interval of 30 seconds applies.

**Mode** ISAKMP Profile Configuration

**Examples** To specify a DPD interval, use the following commands:

```
awplus(config)# crypto isakmp profile my_profile
awplus(config-isakmp-profile)# dpd-interval 20
```

To set the interval to its default, use the following commands:

```
awplus(config-isakmp-profile)# no dpd-interval
```

**Related Commands** [crypto isakmp profile](#)

**Validation Commands** [show isakmp profile](#)

# dpd-timeout

- Overview** Use this command to specify a Dead Peer Detection (DPD) timeout for IKEv1. DPD is an IKE mechanism using a form of keep-alive to determine if a tunnel peer is still active. DPD timeout defines the timeout interval after which all connections to a peer are deleted in case of inactivity. This only applies to IKEv1, in IKEv2 the default retransmission timeout applies as every exchange is used to detect dead peers. Use the **no** variant to set the timeout to its default (150 seconds).

- Syntax** `dpd-timeout <10-86400>`  
`no dpd-timeout`

| Parameter                     | Description         |
|-------------------------------|---------------------|
| <code>&lt;10-86400&gt;</code> | Timeout in seconds. |

- Default** If you do not specify a timeout, the default timeout of 150 seconds applies.

- Mode** ISAKMP Profile Configuration

- Examples** To specify a DPD timeout for IKEv1, use the following commands:

```
awplus(config)# crypto isakmp profile my_profile
awplus(config-isakmp-profile)# dpd-timeout 200
```

To set the timeout to its default, use the following command:

```
awplus(config-isakmp-profile)# no dpd-timeout
```

- Related Commands** [crypto isakmp profile](#)

- Related Commands** [show isakmp profile](#)



# interface tunnel

**Overview** Use this command to create a tunnel interface. Tunnel interfaces are identified by an index identifier that is an integer in the range from 0 through 255. Note that the **tunnel mode** command is needed to enable the tunnel.

Use the **no** variant of this command to remove a previously created tunnel interface.

**Syntax** `interface tunnel<0-255>`  
`no interface tunnel<tunnel-index>`

| Parameter | Description                                                                  |
|-----------|------------------------------------------------------------------------------|
| <0-255>   | Specify a tunnel interface index identifier in the range from 0 through 255. |

**Default** Tunnel interfaces do not exist.

**Mode** Global Configuration

**Usage** This command creates a new tunnel interface to configure in Global Configuration mode.

This command is also used to enter Interface Configuration mode for existing tunnel interfaces.

**Usage** Note that you need to designate a tunnel mode, tunnel source address, tunnel destination address, IP address of tunnel interface and use [tunnel protection ipsec \(IPsec\)](#) command to encrypt and authenticate the packets travelling though the tunnel.

**Examples** To configure an IPsec tunnel interface with index 100, enter the commands below:

```
awplus# configure terminal
awplus(config)# interface tunnel100
awplus(config-if)# tunnel mode ipsec ipv4
```

To remove the IPsec tunnel interface tunnel100, enter the commands below:

```
awplus# configure terminal
awplus(config)# no interface tunnel100
```

# lifetime (IPsec Profile)

- Overview** Use this command to specify a lifetime for an IPsec SA.
- Lifetime measures how long the IPsec SA can be maintained before it expires. Lifetime prevents a connection from being used too long.
- Use the **no** variant to set the lifetime to default (28800 seconds).

**Syntax** `lifetime seconds <300-31449600>`  
`no lifetime seconds`

| Parameter                         | Description          |
|-----------------------------------|----------------------|
| <code>&lt;300-31449600&gt;</code> | Lifetime in seconds. |

**Default** If you do not specify a lifetime, the default lifetime of 28800 seconds (8 hours) applies.

**Mode** IPsec Profile Configuration

**Examples** To specify a lifetime for an IPsec SA, use the following commands:

```
awplus(config)# crypto ipsec profile my_profile
awplus(config-ipsec-profile)# lifetime seconds 400
```

To set the lifetime to its default, use the following commands:

```
awplus(config)# crypto ipsec profile my_profile
awplus(config-ipsec-profile)# no lifetime seconds
```

**Related Commands** [crypto ipsec profile](#)

# lifetime (ISAKMP Profile)

- Overview** Use this command to specify a lifetime for an ISAKMP SA.
- Lifetime measures how long the ISAKMP SA can be maintained before it expires. Lifetime prevents a connection from being used too long.
- Use the **no** variant to set the lifetime to default (86400 seconds).

**Syntax** `lifetime <600-31449600>`  
`no lifetime`

| Parameter                         | Description          |
|-----------------------------------|----------------------|
| <code>&lt;600-31449600&gt;</code> | Lifetime in seconds. |

**Default** If you do not specify a lifetime, the default lifetime of 86400 seconds (8 hours) applies.

**Mode** ISAKMP Profile Configuration

**Examples** To specify a lifetime for an ISAKMP SA, use the following commands:

```
awplus(config)# configure isakmp profile my_profile
awplus(config-isakmp-profile)# lifetime 700
```

To set the lifetime to its default, use the following commands:

```
awplus(config-isakmp-profile)# no lifetime
```

**Related Commands** [crypto isakmp profile](#)

# no debug isakmp

**Overview** Use this command to disable debugging ISAKMP.  
To enable debugging ISAKMP, see [debug isakmp](#).

**Syntax** no [crypto] isakmp [info|trace|all]

| Parameter | Description                                                                                                           |
|-----------|-----------------------------------------------------------------------------------------------------------------------|
| no        | Disable debugging function.                                                                                           |
| crypto    | Security specific.                                                                                                    |
| isakmp    | Internet Security Association Key Management Protocol provides a common framework for key management implementations. |
| info      | Informational debug messages such as protocol events.                                                                 |
| trace     | Verbose debug messages including protocol events and message traces.                                                  |
| all       | All debug enabled.                                                                                                    |

**Mode** Privileged Exec

**Related Commands** [debug isakmp](#)  
[undebug isakmp](#)

# pfs

**Overview** Use this command to enable PFS and set a Diffie-Hellman group for PFS in an IPsec profile.

Use the **no** variant to disable PFS.

**Syntax** `pfs {2|5|14|15|16|18}`  
`no pfs`

| Parameter | Description         |
|-----------|---------------------|
| 2         | 1024-bit MODP Group |
| 5         | 1536-bit MODP Group |
| 14        | 2048-bit MODP Group |
| 15        | 3072-bit MODP Group |
| 16        | 4096-bit MODP Group |
| 18        | 8192-bit MODP Group |

**Default** PFS is disabled.

**Mode** IPsec Profile Configuration

**Usage** Perfect Forward Secrecy (PFS) ensures generated keys, for example IPsec SA keys are not compromised if any other keys, for example, ISAKMP SA keys are compromised.

The specified PFS group must match the PFS group setting on the peer - especially when IKEv2 is used for ISAKMP SA negotiation. With IKEv2, if there is a PFS group mismatch an IPsec SA will be established and the tunnel will come up because PFS is not required for the initial child SA negotiation. However, when the IPsec SA rekeys it will fail due to the PFS group mismatch, and upon IPsec SA expiry the tunnel will no longer be able to carry traffic.

**Examples** To enable PFS and set a Diffie-Hellman group for PFS, use the following commands:

```
awplus(config)# crypto ipsec profile my_profile
awplus(config-ipsec-profile)# pfs 15
```

To disable PFS, use the following command:

```
awplus(config-ipsec-profile)# no pfs
```

**Related Commands** [crypto ipsec profile](#)

**Validation** show ipsec profile  
**Commands**

# show debugging isakmp

**Overview** Use this command to show if debugging ISAKMP is enabled.

**Syntax** show debugging [crypto] isakmp

| Parameter | Description                                                                                                           |
|-----------|-----------------------------------------------------------------------------------------------------------------------|
| debugging | Debugging information.                                                                                                |
| crypto    | Security specific command.                                                                                            |
| isakmp    | Internet Security Association Key Management Protocol provides a common framework for key management implementations. |

**Mode** Privileged Exec

**Examples** To show if debugging ISAKMP is enabled, enter the command below:

```
awplus# show debugging isakmp
```

**Output** Figure 69-2: Example output from the **show debugging isakmp** command

```
awplus#show debugging isakmp
ISAKMP Debugging status:
 ISAKMP Informational debugging is enabled
 ISAKMP Trace debugging is disabled
```

# show interface tunnel (IPsec)

**Overview** Use this command to display status information of tunnels.

The tunnel remains inactive if no valid tunnel source or tunnel destination is configured.

**Syntax** `show interface tunnel <tunnel-index>`

| Parameter      | Description                                                                                                               |
|----------------|---------------------------------------------------------------------------------------------------------------------------|
| tunnel         | Specify this parameter to display tunnel status information of a given tunnel identified by the <tunnel-index> parameter. |
| <tunnel-index> | Specify a tunnel index in the range from 0 through 255.                                                                   |

**Mode** Privileged Exec

**Examples** To display status information for IPsec tunnel1, enter the command below:

```
awplus# show interface tunnel1
```

**Output** Figure 69-3: Example output from the **show interface tunnel** command

```
awplus#show interface tunnel1
Interface tunnel1
 Link is UP, administrative state is UP
 Hardware is Tunnel
 IPv4 address 192.168.1.1/24 point-to-point 192.168.1.255
 index 21 metric 1 mtu 1438
 <UP, POINT-TO-POINT, RUNNING, MULTICAST>
 SNMP link-status traps: Disabled
 Tunnel source 10.1.0.10, destination 10.2.0.10
 Tunnel name local 10.1.0.10, remote 10.2.0.10
 Tunnel traffic selectors (ID, local, remote)
 1 192.168.2.0/24 192.168.3.0/24
 2 0.0.0.0/0 192.168.10.0/24
 Tunnel protocol/transport ipsec ipv4, key disabled, sequencing disabled
 Checksumming of packets disabled, path MTU discovery disabled
 Tunnel protection via IPsec (profile "default")
 input packets 11, bytes 924, dropped 0, multicast packets 0
 output packets 0, bytes 0, multicast packets 0 broadcast packets 0
 Time since last state change: 0 days 03:23:10
```

**Related Commands** [interface tunnel](#)



# show ipsec counters

**Overview** Use this command to show IPsec counters.

**Syntax** show [crypto] ipsec counters

| Parameter | Description                                                                                          |
|-----------|------------------------------------------------------------------------------------------------------|
| crypto    | Security specific command.                                                                           |
| ipsec     | Internet Protocol Security defines the protection of IP packets using encryption and authentication. |
| counters  | Show IPsec transformation statistic.                                                                 |

**Mode** Privileged Exec

**Examples** To show IPsec counters, enter the command below:

```
awplus# show ipsec counters
```

**Output** Figure 69-4: Example output from the **show ipsec counters** command

```
awplus#show ipsec counters
Name Value

InError 0
InBufferError 0
InHdrError 0
InNoStates 0
InStateProtoError 0
InStateModeError 0
InStateSeqError 0
InStateExpired 0
InStateMismatch 0
InStateInvalid 0
InTmplMismatch 0
InNoPols 0
InPolBlock 0
InPolError 0
OutError 0
OutBundleGenError 0
OutBundleCheckError 0
OutNoStates 0
OutStateProtoError 0
OutStateModeError 0
OutStateSeqError 0
OutStateExpired 0
OutPolBlock 0
OutPolDead 0
OutPolError 0
FwdHdrError 0
```

# show ipsec peer

**Overview** Use this command to show IPsec information on a per peer basis.

**Syntax** show [crypto] ipsec peer [<hostname>|<ipv4-addr>|<ipv6-addr>]

| Parameter   | Description                                                          |
|-------------|----------------------------------------------------------------------|
| crypto      | Security specific command.                                           |
| peer        | Remote endpoint.                                                     |
| <hostname>  | Destination hostname.                                                |
| <ipv4-addr> | Destination IPv4 address. The IPv4 address uses the format A.B.C.D.  |
| <ipv6-addr> | Destination IPv6 address. The IPv6 address uses the format X:X::X:X. |

**Mode** Privileged Exec

**Examples** To show IPsec information on a per peer basis, enter the command below:

```
awplus# show ipsec peer 172.16.0.1
```

**Output** Figure 69-5: Example output from the **show ipsec peer** command

```
awplus#show ipsec peer 172.16.0.1
172.16.0.2
IPsec
 Selectors (local:remote)
 Address: 0.0.0.0/0 : 0.0.0.0/0
 Protocol: any:any
 Port: any:any
 Mark: 1:1
 Profile: default
 SAs:
 SPI (In:Out): ca865389:c9c7e3d3
 Selectors: 192.168.1.0/24 : 192.168.2.0/24
 Proto: ESP
 Mode: tunnel
 Encryption: AES256
 Integrity: SHA256
 Expires: 28796s
ISAKMP
 LocalID: 172.16.0.1
 RemoteID: 172.16.0.2
 SAs:
 Cookies (Initiator:Responder) 03071749781e5992:93f8457816d3d40d
 Ver: 2 Lifetime: 84569s State: Established
 Authentication: PSK Group: 14
 Encryption: AES256 NATT: no
 Integrity: SHA256 DPD: yes
```

# show ipsec policy

**Overview** Use this command to show IPsec policies.

**Syntax** `show [crypto] ipsec policy`

| Parameter | Description                                                                                          |
|-----------|------------------------------------------------------------------------------------------------------|
| crypto    | Security specific command.                                                                           |
| ipsec     | Internet Protocol Security defines the protection of IP packets using encryption and authentication. |
| policy    | Policy.                                                                                              |

**Mode** Privileged Exec

**Examples** To show IPsec policies, enter the command below:

```
awplus# show ipsec policy
```

**Output** Figure 69-6: Example output from the **show ipsec policy** command

```
awplus#show ipsec policy
Traffic Selector (addresses protocol ports interface)
 Profile Peer
0.0.0.0/0 0.0.0.0/0 tunnel1
 default 10.2.0.10
```

# show ipsec profile

**Overview** Use this command to show IPsec default and custom profiles.

An IPsec profile consists of a set of parameters that are used by IPsec when establishing IPsec SAs with a remote peer. AlliedWare Plus provides default ISAKMP and IPsec profiles that contain a priority ordered set of transforms that are considered secure by the security community.

**Syntax** `show [crypto] ipsec profile [<profile_name>]`

| Parameter      | Description                                                                                          |
|----------------|------------------------------------------------------------------------------------------------------|
| crypto         | Security specific.                                                                                   |
| ipsec          | Internet Protocol Security defines the protection of IP packets using encryption and authentication. |
| profile        | An IPsec profile consists of a set of parameters that are used by IPsec SAs with a remote peer.      |
| <profile_name> | Custom profile name.                                                                                 |

**Mode** Privileged Exec

**Examples** To show all IPsec profiles, including the default profile, use the following command:

```
awplus# show ipsec profile
```

**Output** Figure 69-7: Example output from the **show ipsec profile** command

```
awplus#show ipsec profile
IPsec Profile: default
 Replay-window: 32
 Expiry: 8h
 PFS group: disabled
 Transforms:
 Protocol Integrity Encryption
 1 ESP SHA256 AES256
 2 ESP SHA1 AES256
 3 ESP SHA256 AES128
 4 ESP SHA1 AES128
 5 ESP SHA256 3DES
 6 ESP SHA1 3DES
IPsec Profile: my_profile
 Replay-window: 32
 Expiry: 8h
 PFS group: disabled
 Transforms:
 Protocol Integrity Encryption
 2 ESP SHA1 3DES
```

**Examples** To show IPsec profile “my\_profile”, use the command:

```
awplus# show ipsec profile my_profile
```

**Output** Figure 69-8: Example output from the **show ipsec profile** command

```
awplus#show ipsec profile my_profile
IPsec Profile: my_profile
Replay-window: 32
Expiry: 8h
PFS group: disabled
Transforms:
 Protocol Integrity Encryption
 2 ESP SHA1 3DES
```

**Related Commands** [crypto ipsec profile](#)

# show ipsec sa

**Overview** Use this command to view the settings used by current security associations. SAs specify the Security Parameter Index (SPI), protocols, algorithms and keys for protecting a single flow of traffic between two IPsec peers. For more information about SA, see the [Internet Protocol Security \(IPSec\) Feature Overview and Configuration Guide](#).

**Syntax** show [crypto] ipsec sa

| Parameter | Description                                                                                          |
|-----------|------------------------------------------------------------------------------------------------------|
| crypto    | Security specific command.                                                                           |
| ipsec     | Internet Protocol Security defines the protection of IP packets using encryption and authentication. |
| sa        | Security Association.                                                                                |

**Mode** Privileged Exec

**Examples** To view the settings used by current security associations, enter the command below:

```
awplus# show ipsec sa
```

**Output** Figure 69-9: Example output from the **show ipsec sa** command

```
awplus#show ipsec sa
```

| Peer      | SPI (in:out)<br>Encryption  | Mode<br>Integrity | Proto<br>PFS | Expires |
|-----------|-----------------------------|-------------------|--------------|---------|
| 10.0.0.20 | c2d8c150:7b24d3f5<br>AES256 | tunnel<br>SHA256  | ESP<br>-     | 28786s  |
| 10.0.0.22 | c6c2ad0d:0d008e3d<br>3DES   | tunnel<br>SHA1    | ESP<br>-     | 3582s   |
| 10.0.0.25 | cb36f9dd:cd87a834<br>AES128 | tunnel<br>SHA1    | ESP<br>2     | 28778s  |

# show isakmp counters

**Overview** Use this command to show ISAKMP counters.

**Syntax** show [crypto] isakmp counters

| Parameter | Description                                                                                                           |
|-----------|-----------------------------------------------------------------------------------------------------------------------|
| crypto    | Security specific command.                                                                                            |
| isakmp    | Internet Security Association Key Management Protocol provides a common framework for key management implementations. |
| counters  | Show ISAKMP counters.                                                                                                 |

**Mode** Privileged Exec

**Examples** To show ISAKMP counters, enter the command below:

```
awplus# show isakmp counters
```

**Output** Figure 69-10: Example output from the **show isakmp counters** command

```
awplus#show isakmp counters
Name Value

ikeInitRekey 0
ikeRspRekey 0
ikeChildSaRekey 0
ikeInInvalid 0
ikeInInvalidSpi 0
ikeInInitReq 0
ikeInInitRsp 0
ikeOutInitReq 0
ikeOutInitRsp 0
ikeInAuthReq 0
ikeInAuthRsp 0
ikeOutAuthReq 0
ikeOutAuthRsp 0
ikeInCrChildReq 0
ikeInCrChildRsp 0
ikeOutCrChildReq 0
ikeOutCrChildRsp 0
ikeInInfoReq 0
ikeInInfoRsp 0
ikeOutInfoReq 0
ikeOutInfoRsp 0
```

# show isakmp key (IPsec)

**Overview** Use this command to show the ISAKMP pre-shared key. Pre-shared key authentication using optionally encrypted shared keys identified by hostname, IPv4 or IPv6 address. Pre-shared keys are not viewable and stored encrypted in the running-configuration.

**Syntax** `show [crypto] isakmp key`

| Parameter | Description                                                                                                           |
|-----------|-----------------------------------------------------------------------------------------------------------------------|
| crypto    | Security specific command.                                                                                            |
| isakmp    | Internet Security Association Key Management Protocol provides a common framework for key management implementations. |
| key       | Pre-shared key.                                                                                                       |

**Mode** Privileged Exec

**Examples** To show ISAKMP pre-shared key, enter the command below:

```
awplus# show isakmp key
```

**Output** Figure 69-11: Example output from the **show isakmp key** command

```
awplus#show isakmp key
Hostname/IP address Key
10.2.0.10 mytunnelkey
```



# show isakmp peer

**Overview** Use this command to show ISAKMP profile and key status for ISAKMP peers.

**Syntax** `show isakmp peer [<hostname>|<ipv4-addr>|<ipv6-addr>]`

| Parameter                      | Description                                                          |
|--------------------------------|----------------------------------------------------------------------|
| <code>&lt;hostname&gt;</code>  | Destination hostname.                                                |
| <code>&lt;ipv4-addr&gt;</code> | Destination IPv4 address. The IPv4 address uses the format A.B.C.D.  |
| <code>&lt;ipv6-addr&gt;</code> | Destination IPv6 address. The IPv6 address uses the format X:X::X:X. |

**Mode** Privileged Exec

**Examples** To show ISAKMP profile and key status for ISAKMP peers, use the following command:

```
awplus# show isakmp peer
```

**Output** Figure 69-12: Example output from the **show isakmp peer** command

```
awplus#show isakmp peer
Peer Profile (* incomplete) Key

example.com LEGACY Not Found
2.2.2.2 default PSK
1.1.1.1 SECURE PSK
```

**Related Commands** [crypto isakmp peer](#)

**Command changes** Version 5.4.7-0.1: Parameter <hostname> added for DDNS feature.

# show isakmp profile

**Overview** Use this command to show ISAKMP default and custom profiles.

**Syntax** show [crypto] isakmp profile [<profile\_name>]

| Parameter      | Description          |
|----------------|----------------------|
| <profile_name> | Custom profile name. |

**Mode** Privileged Exec

**Examples** To show ISAKMP profiles, including the default profile, use the command:

```
awplus# show isakmp profile
```

**Output** Figure 69-13: Example output from the **show isakmp profile** command

```
awplus#show isakmp profile
ISAKMP Profile: default
 Version: IKEv2
 Authentication: PSK
 Expiry: 24h
 DPD Interval: 30s
 Transforms:
 Integrity Encryption DH Group
 1 SHA256 AES256 14
 2 SHA256 AES256 16
 3 SHA1 AES256 14
 4 SHA1 AES256 16
 5 SHA256 AES128 14
 6 SHA256 AES128 16
 7 SHA1 AES128 14
 8 SHA1 AES128 16
 9 SHA256 3DES 14
 10 SHA256 3DES 16
 11 SHA1 3DES 14
 12 SHA1 3DES 16

ISAKMP Profile: my_profile
 Version: IKEv2
 Authentication: PSK
 Expiry: 24h
 DPD Interval: 30s
 Transforms:
 Integrity Encryption DH Group
 2 SHA1 3DES 5
```

**Examples** To show ISAKMP profile “my\_profile”, use the command:

```
awplus# show isakmp profile my_profile
```

**Output** Figure 69-14: Example output from the **show isakmp profile** command

```
awplus#show isakmp profile my_profile
ISAKMP Profile: my_profile
Version: IKEv2
Authentication: PSK
Expiry: 24h
DPD Interval: 30s
Transforms:
 Integrity Encryption DH Group
 2 3DES 5
```

**Related Commands** [crypto isakmp profile](#)

# show isakmp sa

**Overview** Use this command to show current IKE security associations at a peer.

**Syntax** show [crypto] isakmp sa

| Parameter | Description                                                                                                           |
|-----------|-----------------------------------------------------------------------------------------------------------------------|
| crypto    | Security specific command.                                                                                            |
| isakmp    | Internet Security Association Key Management Protocol provides a common framework for key management implementations. |
| sa        | Security Association.                                                                                                 |

**Mode** Privileged Exec

**Examples** To show current IKE security associations at a peer, enter the command below:

```
awplus# show isakmp sa
```

**Output** Figure 69-15: Example output from the **show isakmp sa** command

```
awplus#show isakmp sa
```

| Peer      | Cookies (initiator:responder)<br>Encryption Integrity Group | Auth<br>DPD | Ver<br>NATT | Expires<br>State      |
|-----------|-------------------------------------------------------------|-------------|-------------|-----------------------|
| 10.0.0.20 | f93c2717a1ece407:972bc0c77344d7a4<br>AES256 SHA256 2        | PSK<br>yes  | 1<br>no     | 78340s<br>Established |
| 10.0.0.22 | ccb7f90b54945375:2642525bd20f3428<br>3DES SHA1 2            | PSK<br>yes  | 1<br>no     | 3334s<br>Established  |
| 10.0.0.25 | bd0efef134c86656:d46d0b1b72b46444<br>AES128 SHA1 2          | PSK<br>yes  | 1<br>no     | 819s<br>Established   |

# transform (IPsec Profile)

**Overview** Use this command to create an IPsec profile transform, which specifies the encryption and authentication algorithms used to protect data.

Use the **no** variant to delete a previously created transform.

**Syntax** `transform <1-255> protocol esp integrity {sha1|sha256|sha512}  
encryption {3des|aes128|aes192|aes256|null}`  
`no transform <1-255>`

| Parameter | Description                                                                                                        |
|-----------|--------------------------------------------------------------------------------------------------------------------|
| <1-255>   | Transform priority (1 is the highest)                                                                              |
| sha1      | Secure Hash Standard with 160-bit digest size                                                                      |
| sha256    | Secure Hash Standard with 256-bit digest size                                                                      |
| sha512    | Secure Hash Standard with 512 bit digest size                                                                      |
| 3des      | Triple DES symmetric key block cipher with a 168-bit key                                                           |
| aes128    | Advanced Encryption Standard symmetric key block cipher with a 128-bit key                                         |
| aes192    | Advanced Encryption Standard symmetric key block cipher with a 192-bit key                                         |
| aes256    | Advanced Encryption Standard symmetric key block cipher with a 256-bit key                                         |
| null      | No encryption. This option is not intended for use in a live network. It should only be used for testing purposes. |

**Default** By default, an IPsec profile has no transforms and so will not be active.

**Mode** IPsec Profile Configuration

**Examples** To configure an IPsec profile transform, use the following commands:

```
awplus(config)# crypto ipsec profile my_profile
awplus(config-ipsec-profile)# transform 2 protocol esp
integrity sha1 encryption 3des
```

To delete a created transform, use the following command:

```
awplus(config-ipsec-profile)# no transform 2
```

**Related Commands** [crypto ipsec profile](#)

**Validation Commands** [show ipsec profile](#)

# transform (ISAKMP Profile)

**Overview** Use this command to create an ISAKMP profile transform which specifies the encryption and authentication algorithms used to protect data in the tunnel.

Use the **no** variant to delete a previously created transform.

**Syntax** `transform <1-255> integrity {sha1|sha256|sha512} encryption {3des|aes128|aes192|aes256} group {2|5|14|15|16|18}`  
`no transform <1-255>`

| Parameter | Description                                                                |
|-----------|----------------------------------------------------------------------------|
| <1-255>   | Transform priority (1 is the highest)                                      |
| sha1      | Secure Hash Standard with 160-bit digest size                              |
| sha256    | Secure Hash Standard with 256-bit digest size                              |
| sha512    | Secure Hash Standard with 512 bit digest size                              |
| 3des      | Triple DES symmetric key block cipher with a 168-bit key                   |
| aes128    | Advanced Encryption Standard symmetric key block cipher with a 128-bit key |
| aes192    | Advanced Encryption Standard symmetric key block cipher with a 192-bit key |
| aes256    | Advanced Encryption Standard symmetric key block cipher with a 256-bit key |
| group     | Diffie-Hellman group                                                       |
| 2         | 1024-bit MODP Group                                                        |
| 5         | 1536-bit MODP Group                                                        |
| 14        | 2048-bit MODP Group                                                        |
| 15        | 3072-bit MODP Group                                                        |
| 16        | 4096-bit MODP Group                                                        |
| 18        | 8192-bit MODP Group                                                        |

**Default** By default, an ISASMP profile has no transforms and so will not be active.

**Mode** ISAKMP Profile Configuration

**Examples** To create an ISAKMP profile transform, use the following commands:

```
awplus(config)# crypto isakmp profile my_profile
awplus(config-isakmp-profile)# transform 2 integrity sha1
encryption 3des group 5
```

To delete a created transform, use the following command:

```
awplus(config-isakmp-profile)# no transform 2
```

**Related  
Commands** [crypto isakmp profile](#)

# tunnel destination (IPsec)

**Overview** Use this command to specify a destination IPv4 or IPv6 address or destination network name for the remote end of the tunnel.

Use the **no** variant of this command to remove a configured tunnel destination address.

**Syntax** tunnel destination {<WORD>|<ipv4-address>|<ipv6-address>}  
no tunnel destination {<WORD>|<ipv4-address>|<ipv6-address>}

| Parameter      | Description                                                                                                                                                                                       |
|----------------|---------------------------------------------------------------------------------------------------------------------------------------------------------------------------------------------------|
| <WORD>         | Destination network name or "dynamic". The "dynamic" parameter allows you to specify a dynamic IP address for the remote endpoint. The dynamic IP address can be obtained, for example, via DHCP. |
| <ipv4-address> | Destination IPv4 address. The IPv4 address uses the format A.B.C.D.                                                                                                                               |
| <ipv6-address> | Destination IPv6 address. The IPv6 address uses the format X:X::X:X.                                                                                                                              |

**Mode** Interface Configuration

**Examples** To configure a destination IPv4 address for IPsec tunnel145, use the commands below:

```
awplus# configure terminal
awplus(config)# interface tunnel145
awplus(config-if)# tunnel mode ipsec ipv4
awplus(config-if)# tunnel destination 192.0.3.1
```

To configure a destination IPv6 address for IPsec tunnel145, use the commands below:

```
awplus# configure terminal
awplus(config)# interface tunnel145
awplus(config-if)# tunnel mode ipsec ipv6
awplus(config-if)# tunnel destination 2001:0db8::
```

To configure a destination network name for IPsec tunnel145, use the commands below:

```
awplus# configure terminal
awplus(config)# interface tunnel145
awplus(config-if)# tunnel mode ipsec ipv4
awplus(config-if)# tunnel destination www.z.com
```



To configure a dynamic IP address for the tunnel destination, use the commands below:

```
awplus# configure terminal
awplus(config)# interface tunnel145
awplus(config-if)# tunnel mode ipsec ipv4
awplus(config-if)# tunnel destination dynamic
```

To remove the destination address of IPsec tunnel145, use the commands below:

```
awplus# configure terminal
awplus(config)# interface tunnel145
awplus(config-if)# no tunnel destination 192.0.3.1
```

**Related  
Commands** [tunnel source \(IPsec\)](#)

# tunnel local name (IPsec)

**Overview** Use this command to specify an IPsec tunnel hostname to send to the peer for authentication when you apply [tunnel protection ipsec \(IPsec\)](#) to encrypt the packets and configure an ISAKMP key.

Use the **no** variant of this command to remove a previously configured IPsec tunnel hostname.

**Syntax** tunnel local name *<local-name>*  
no tunnel local name

| Parameter                 | Description             |
|---------------------------|-------------------------|
| <i>&lt;local-name&gt;</i> | Source tunnel hostname. |

**Default** The default tunnel local name is the IP address of tunnel source.

**Mode** Interface Configuration

**Examples** To configure the tunnel local name office1 for tunnel6, use the commands below:

```
awplus# configure terminal
awplus(config)# interface tunnel6
awplus(config-if)# tunnel local name office1
```

To remove a configured tunnel local name for tunnel6, use the commands below:

```
awplus# configure terminal
awplus(config)# interface tunnel6
awplus(config-if)# no tunnel local name
```

**Related Commands** [tunnel remote name \(IPsec\)](#)

# tunnel local selector

**Overview** Use this command to specify a local subnet for a traffic selector pair.

Use the **no** variant of this command to unset the local subnet for the traffic selector pair so that it matches all sources, i.e. 0.0.0.0/0 or ::/0 for IPv4 and IPv6, respectively. When local and remote subnets for a traffic selector pair are both unset, the traffic selector pair is removed.

**Syntax** tunnel local selector [*<traffic-selector-ID>*]  
{*<ipv4-subnet>*|*<ipv6-subnet>*}  
no tunnel local selector [*<traffic-selector-ID>*]

| Parameter                          | Description                                                          |
|------------------------------------|----------------------------------------------------------------------|
| <i>&lt;traffic-selector-ID&gt;</i> | Optional traffic selector ID from 1 through 65535. The default is 1. |
| <i>&lt;ipv4-subnet&gt;</i>         | IPv4 subnet in the format A.B.C.D/M.                                 |
| <i>&lt;ipv6-subnet&gt;</i>         | IPv6 subnet in the format of X:X::X:X/M                              |

**Default** When no traffic selector pairs are configured there is an implicit traffic selector pair, where the local and remote subnets are 0.0.0.0/0 or ::/0 depending on the tunnel IPsec mode.

**Mode** Interface configuration

**Usage** A traffic selector pair is an agreement between IKE peers to permit traffic through a tunnel if the traffic matches a specified pair of local and remote subnets. When the local selector is specified but the remote selector is not, the selector pair implicitly matches all destinations.

**Examples** To specify an IPv4 destination address as the traffic selector for the traffic to match for tunnel0, use the commands below:

```
awplus# configure terminal
awplus(config)# interface tunnel0
awplus(config-if)# tunnel source eth1
awplus(config-if)# tunnel destination 10.0.0.2
awplus(config-if)# tunnel local name office
awplus(config-if)# tunnel mode ipsec ipv4
awplus(config-if)# tunnel local selector 192.168.1.0/24
awplus(config-if)# tunnel remote selector 192.168.2.0/24
```

To configure an additional source and destination traffic selector pair for the traffic to match for tunnel0, use the commands:

```
awplus(config-if)# tunnel local selector 5 192.168.1.0/24
awplus(config-if)# tunnel remote selector 5 192.168.2.0/24
```

To specify an IPv6 source address as the traffic selector for the traffic to match for tunnel0, use the commands below:

```
awplus# configure terminal
awplus(config)# interface tunnel0
awplus(config-if)# tunnel source eth1
awplus(config-if)# tunnel destination 2001:db8:10::1
awplus(config-if)# tunnel local name office
awplus(config-if)# tunnel mode ipsec ipv6
awplus(config-if)# tunnel local selector 2001:db8:1::/64
awplus(config-if)# tunnel remote selector 2001:db8:2::/64
```

To configure an additional source and destination traffic selector pair for the traffic to match for tunnel0, use the commands:

```
awplus(config-if)# tunnel local selector 5 2001:db8:1::/64
awplus(config-if)# tunnel remote selector 5 2001:db8:2::/64
```

To unset the destination traffic selector for the traffic selector pair with ID 1, for tunnel 6, use the commands:

```
awplus# configure terminal
awplus(config)# interface tunnel6
awplus(config-if)# no tunnel remote selector

or

awplus(config-if)# no tunnel remote selector 1
```

**Related Commands** [tunnel remote selector](#)  
[show interface tunnel \(IPsec\)](#)

# tunnel mode (IPsec)

**Overview** Use this command to configure the encapsulation tunneling mode to use.

Use the **no** variant of this command to remove an established tunnel.

**Syntax** tunnel mode {gre [ipv6]|ipsec {ipv4|ipv6}|l2tp v3  
[ipv6]|openvpn {tap|tun}}  
no tunnel mode

| Parameter    | Description                                                                         |
|--------------|-------------------------------------------------------------------------------------|
| gre          | GRE IPv4 or IPv6 as the payload over IPv4 tunneling. IPv4 is the delivery protocol. |
| gre ipv6     | GRE IPv4 or IPv6 as the payload over IPv6 tunneling. IPv6 is the delivery protocol. |
| ipsec ipv4   | IPv4 IPsec tunnel                                                                   |
| ipsec ipv6   | IPv6 IPsec tunnel                                                                   |
| l2tp v3      | Layer 2 Tunneling Protocol version 3. By default, IPv4 is the deliver protocol.     |
| l2tp v3 ipv6 | Set IPv6 as the deliver protocol for L2TPv3                                         |
| openvpn      | OpenVPN tunneling mode                                                              |
| openvpn tap  | OpenVPN TAP mode                                                                    |
| openvpn tun  | OpenVPN TUN mode                                                                    |

**Default** Virtual tunnel interfaces have no mode set.

**Mode** Interface Configuration

**Usage** A tunnel will not become operational until it is configured with this command.

**Examples** To configure IPsec in IPv4 tunnel mode, use the commands:

```
awplus# configure terminal
awplus(config)# interface tunnel6
awplus(config-if)# tunnel mode ipsec ipv4
```

To remove configured IPsec tunnels for tunnel6, use the commands:

```
awplus# configure terminal
awplus(config)# interface tunnel6
awplus(config-if)# no tunnel mode
```

# tunnel protection ipsec (IPsec)

**Overview** Use this command to enable IPsec protection for packets encapsulated by this tunnel.

Use the **no** variant to disable IPsec protection.

**Syntax** tunnel protection ipsec [profile <profile\_name>]  
no tunnel protection ipsec

**Default** IPsec protection for packets encapsulated by tunnel is disabled. If no custom profile is specified, the default profile is used.

| Parameter      | Description                                                                                                  |
|----------------|--------------------------------------------------------------------------------------------------------------|
| <profile_name> | Custom profile name. You can use the <a href="#">crypto ipsec profile</a> command to create custom profiles. |

**Mode** Interface Configuration

**Usage** IPsec mode tunnels (IPv4 and IPv6) require this command for them to work. GRE IPv6 and L2TPv3 IPv6 tunnel have IPsec protection as an option.

**Examples** To enable IPsec protection by using default profile, use the following commands:

```
awplus# configure terminal
awplus(config)# interface tunnel14
awplus(config-if)# tunnel protection ipsec
```

To enable IPsec protection by using a custom profile, use the following commands:

```
awplus(config)# interface tunnel14
awplus(config-if)# tunnel protection ipsec profile
my_profile
```

To disable IPsec protection for packets encapsulated by tunnel14, use the following commands:

```
awplus# configure terminal
awplus(config)# interface tunnel14
awplus(config-if)# no tunnel protection ipsec
```

**Related Commands** [crypto ipsec profile](#)

# tunnel remote name (IPsec)

**Overview** Use this command to specify a tunnel remote name to authenticate the tunnel's remote peer device when you apply [tunnel protection ipsec \(IPsec\)](#) to encrypt the packets and configure an ISAKMP key.

Use the **no** variant of this command to remove a previously configured tunnel remote name.

**Syntax** tunnel remote name *<remote-name>*  
no tunnel local name

| Parameter                  | Description                 |
|----------------------------|-----------------------------|
| <i>&lt;remote-name&gt;</i> | Destination tunnel hostname |

**Default** The default tunnel remote name is the IP address of tunnel destination.

**Mode** Interface Configuration

**Examples** To configure tunnel remote name *office2* for *tunnel6*, use the commands below:

```
awplus# configure terminal
awplus(config)# interface tunnel6
awplus(config-if)# tunnel remote name office2
```

To remove a configured tunnel local name for *tunnel6*, use the commands below:

```
awplus# configure terminal
awplus(config)# interface tunnel6
awplus(config-if)# no tunnel remote name
```

**Related Commands** [tunnel local name \(IPsec\)](#)

# tunnel remote selector

**Overview** Use this command to specify a destination subnet for a traffic selector pair.

Use the **no** variant of this command to unset the remote subnet for a traffic selector pair so that it matches all destinations, i.e. 0.0.0.0/0 or ::/0 for IPv4 and IPv6, respectively. When local and remote subnets for a traffic selector pair are both unset, the traffic selector pair is removed.

**Syntax** tunnel remote selector [<traffic-selector-ID>]  
{<IPv4-subnet>|<IPv6-subnet>}  
  
no tunnel remote selector [<traffic-selector-ID>]

| Parameter             | Description                                                                             |
|-----------------------|-----------------------------------------------------------------------------------------|
| <traffic-selector-ID> | Traffic selector ID from 1 through 65535. If not specified the default value 1 is used. |
| <ipv4-subnet>         | IPv4 subnet in the format A.B.C.D/M.                                                    |
| <ipv6-subnet>         | IPv6 subnet in the format of X:X::X/M                                                   |

**Default** When no traffic selector pairs are configured there is an implicit traffic selector pair, where the local and remote subnets are 0.0.0.0/0 or ::/0 depending on the tunnel IPsec mode.

**Mode** Interface configuration

**Usage** A traffic selector pair is an agreement between IKE peers to permit traffic through a tunnel if the traffic matches a specified pair of local and remote subnets. When the remote selector is specified but the local selector is not, the selector pair implicitly matches all sources.

**Examples** To specify an IPv4 destination address as the traffic selector for the traffic to match for tunnel0, use the commands below:

```
awplus# configure terminal
awplus(config)# interface tunnel0
awplus(config-if)# tunnel source eth1
awplus(config-if)# tunnel destination 10.0.0.2
awplus(config-if)# tunnel local name office
awplus(config-if)# tunnel mode ipsec ipv4
awplus(config-if)# tunnel local selector 192.168.1.0/24
awplus(config-if)# tunnel remote selector 192.168.2.0/24
```

When no traffic selector ID is specified the default ID value is used. By specifying a traffic selector ID, additional selector pairs can be configured.



To configure an additional source and destination traffic selector pair for the traffic to match for tunnel0, use the commands:

```
awplus(config-if)# tunnel local selector 5 192.168.1.0/24
awplus(config-if)# tunnel remote selector 5 192.168.2.0/24
```

To specify an IPv6 source address as the traffic selector for the traffic to match for tunnel0, use the commands below:

```
awplus# configure terminal
awplus(config)# interface tunnel0
awplus(config-if)# tunnel source eth1
awplus(config-if)# tunnel destination 2001:db8:10::1
awplus(config-if)# tunnel local name office
awplus(config-if)# tunnel mode ipsec ipv6
awplus(config-if)# tunnel local selector 2001:db8:1::/64
awplus(config-if)# tunnel remote selector 2001:db8:2::/64
```

To configure an additional source and destination traffic selector pair for the traffic to match for tunnel0, use the commands:

```
awplus(config-if)# tunnel local selector 5 2001:db8:1::/64
awplus(config-if)# tunnel remote selector 5 2001:db8:2::/64
```

To unset the destination traffic selector for the traffic selector pair with ID 1, for tunnel6, use the commands:

```
awplus# configure terminal
awplus(config)# interface tunnel6
awplus(config-if)# no tunnel remote selector
```

or

```
awplus(config-if)# no tunnel remote selector 5
```

**Related Commands** [tunnel local selector](#)  
[show interface tunnel \(IPsec\)](#)

# tunnel source (IPsec)

**Overview** Use this command to specify an IPv4 or IPv6 source address or interface name for packets being encapsulated in the IPsec tunnel. The source address should be an existing IPv4 address or IPv6 address or interface name configured for an interface.

Note that if the tunnel source interface has multiple IP addresses, for example, one primary and one or more secondary IP addresses, the lowest IP address on the interface is used for transporting the tunnel encapsulated traffic.

Use the **no** variant of this command to remove a tunnel source address for a tunnel interface.

**Syntax** `tunnel source {<interface-name>|<ipv4-address>|<ipv6-address>}`  
`no tunnel source`  
`{<interface-name>|<ipv4-address>|<ipv6-address>}`

| Parameter                         | Description                                |
|-----------------------------------|--------------------------------------------|
| <code>&lt;interface&gt;</code>    | Interface name.                            |
| <code>&lt;ipv4-address&gt;</code> | The IPv4 address uses the format A.B.C.D.  |
| <code>&lt;ipv6-address&gt;</code> | The IPv6 address uses the format X:X::X:X. |

**Mode** Interface Configuration

**Examples** To configure a source IPv4 address for IPsec tunnel145, use the commands below:

```
awplus# configure terminal
awplus(config)# interface tunnel145
awplus(config-if)# tunnel mode ipsec ipv4
awplus(config-if)# tunnel source 192.168.1.1
```

To configure a source IPv6 address for IPsec tunnel145, use the commands below:

```
awplus# configure terminal
awplus(config)# interface tunnel145
awplus(config-if)# tunnel mode ipsec ipv6
awplus(config-if)# tunnel source 2001:db8::
```

To configure a source interface for IPsec tunnel145, use the commands below:

```
awplus# configure terminal
awplus(config)# interface tunnel145
awplus(config-if)# tunnel mode ipsec ipv4
awplus(config-if)# tunnel source eth1
```

To remove the source address of IPsec tunnel145, use the commands below:

```
awplus# configure terminal
awplus(config)# interface tunnel145
awplus(config-if)# no tunnel source 192.168.1.1
```

**Related  
Commands** [tunnel destination \(IPsec\)](#)

# undebg isakmp

**Overview** Use this command to disable debugging ISAKMP.

To enable debugging ISAKMP, see [debug isakmp](#).

**Syntax** undebg [crypto] isakmp [info|trace|all]

| Parameter | Description                                                                                                           |
|-----------|-----------------------------------------------------------------------------------------------------------------------|
| undebg    | Disable debugging function.                                                                                           |
| crypto    | Security specific command.                                                                                            |
| isakmp    | Internet Security Association Key Management Protocol provides a common framework for key management implementations. |
| info      | Informational debug messages such as protocol events.                                                                 |
| trace     | Verbose debug messages including protocol events and message traces.                                                  |
| all       | All debug enabled.                                                                                                    |

**Mode** Privileged Exec

**Related Commands** [debug isakmp](#)  
[no debug isakmp](#)

# version (ISAKMP)

**Overview** Use this command to set the ISAKMP protocol version.  
Use the **no** variant to set the protocol version to default (IKEv2).

**Syntax** `version {1 mode {aggressive|main}|2}`  
`no version`

| Parameter  | Description                                                                                                                                                                                                                                                                                                                                                                           |
|------------|---------------------------------------------------------------------------------------------------------------------------------------------------------------------------------------------------------------------------------------------------------------------------------------------------------------------------------------------------------------------------------------|
| 1          | IKEv1                                                                                                                                                                                                                                                                                                                                                                                 |
| main       | IKEv1 Main mode. An IKE session begins with the initiator and recipient sending three two-way exchanges to define what encryption and authentication protocols are acceptable, how long keys should remain active, and whether perfect forward secrecy should be enforced. Main mode uses more packets for the process than Aggressive mode, but Main mode is considered more secure. |
| aggressive | IKEv1 Aggressive mode. The initiator and recipient accomplish the same objectives, but in only two exchanges.                                                                                                                                                                                                                                                                         |
| 2          | IKEv2                                                                                                                                                                                                                                                                                                                                                                                 |

**Default** If you do not specify the version, the default version is IKEv2

**Mode** IPsec ISAKMP Configuration

**Examples** To set the ISAKMP protocol version of profile "my\_profile" to IKEv1 main mode, use the following commands:

```
awplus(config)# configure isakmp profile my_profile
awplus(config-isakmp-profile)# version 1 mode main
```

To set the version to its default, use the following command:

```
awplus# no version
```

**Related Commands** [crypto isakmp profile](#)

**Validation Commands** [show isakmp profile](#)

# 70

# GRE Tunneling Commands

## Introduction

**Overview** This chapter provides an alphabetical reference of commands used to configure IPv6 tunnels. For more information about IPv6 tunnels, see the [Generic Routing Encapsulation \(GRE\) Feature Overview and Configuration Guide](#).

- Command List**
- “[crypto isakmp key](#)” on page 2847
  - “[interface tunnel](#)” on page 2849
  - “[ip address \(GRE\)](#)” on page 2850
  - “[ip tcp adjust-mss](#)” on page 2852
  - “[ipv6 address \(GRE\)](#)” on page 2854
  - “[ipv6 tcp adjust-mss](#)” on page 2856
  - “[show interface tunnel \(GRE\)](#)” on page 2858
  - “[show isakmp key \(GRE\)](#)” on page 2859
  - “[tunnel checksum](#)” on page 2860
  - “[tunnel dscp](#)” on page 2861
  - “[tunnel destination \(GRE\)](#)” on page 2862
  - “[tunnel local name \(GRE\)](#)” on page 2864
  - “[tunnel mode \(GRE\)](#)” on page 2865
  - “[tunnel protection ipsec \(GRE\)](#)” on page 2866
  - “[tunnel remote name \(GRE\)](#)” on page 2867
  - “[tunnel source \(GRE\)](#)” on page 2868
  - “[tunnel ttl](#)” on page 2870

# crypto isakmp key

**Overview** Use this command to configure a pre-shared authentication key.

Pre-shared key authentication uses optionally encrypted shared keys identified by hostname, IPv4 or IPv6 address. Pre-shared keys are not viewable and stored encrypted in the running-configuration.

You must configure this key whenever you specify pre-shared keys in an (Internet Key Exchange) IKE policy and at both peers.

To use the **no** variant to remove a previously created pre-shared key.

**Syntax** `crypto isakmp key [8] <key> {hostname <host-name>|address <ipv4-addr>|<ipv6-addr>}`  
`no crypto isakmp key [8] <key> {hostname <host-name>|address <ipv4-addr>|<ipv6-addr>}`

| Parameter   | Description                                                                                                           |
|-------------|-----------------------------------------------------------------------------------------------------------------------|
| crypto      | Security specific command.                                                                                            |
| isakmp      | Internet Security Association Key Management Protocol provides a common framework for key management implementations. |
| key         | Pre-shared key.                                                                                                       |
| <key>       | Specify the pre-shared key. Us any combination of alphanumeric characters up to 128 bytes.                            |
| 8           | Specifies that an encrypted key follows.                                                                              |
| <host-name> | Destination hostname.                                                                                                 |
| <ipv4-addr> | Destination IPv4 address. The IPv4 address uses the format A.B.C.D.                                                   |
| <ipv6-addr> | Destination IPv6 address. The IPv4 address uses the format X:X::X:X.                                                  |

**Default** ISAKMP keys do not exist.

**Mode** Global Configuration

**Examples** To configure a pre-shared authentication key for a destination host, use the commands below:

```
awplus# configure terminal
awplus(config)# crypto isakmp key friend hostname
mypeer@my.domain.com
```

To configure a pre-shared authentication key at a peer with IPv4 address, use the commands below:

```
awplus# configure terminal
awplus(config)# crypto isakmp key friend address
192.168.1.1
```

To configure a pre-shared encrypted authentication key at a peer with IPv4 address, use the commands below:

```
awplus# configure terminal
awplus(config)# crypto isakmp key 8 Nhe6ioQmzbysQaJr6Du+cA==
address
192.168.1.2
```

To remove a pre-shared key at a peer, use the commands below:

```
awplus# configure terminal
awplus(config)# no crypto isakmp key friend hostname
mypeer@my.domain.com
```



# interface tunnel

**Overview** Use this command to create a tunnel interface. Tunnel interfaces are identified by an index identifier that is an integer in the range from 0 through 255. Note that the **tunnel mode** command is needed to enable the tunnel.

Use the **no** variant of this command to remove a previously created tunnel interface.

**Syntax** `interface tunnel<0-255>`  
`no interface tunnel<tunnel-index>`

| Parameter | Description                                                                  |
|-----------|------------------------------------------------------------------------------|
| <0-255>   | Specify a tunnel interface index identifier in the range from 0 through 255. |

**Default** Tunnel interfaces do not exist.

**Mode** Global Configuration

**Usage** This command creates a new tunnel interface to configure in Global Configuration mode.

This command is also used to enter Interface Configuration mode for existing tunnel interfaces.

**Examples** To configure a tunnel interface with index 30 and enable GRE, use the commands:

```
awplus# configure terminal
awplus(config)# interface tunnel30
awplus(config-if)# tunnel mode gre
```

To remove the GRE tunnel interface tunnel30, use the commands:

```
awplus# configure terminal
awplus(config)# no interface tunnel30
```

# ip address (GRE)

**Overview** This command sets a static IP address on a tunnel interface. To set the primary IP address on the interface, specify only **ip address**<ip-address/m>. This overwrites any configured primary IP address. To add additional IP addresses on this interface, use the **secondary** parameter. You must configure a primary address on the interface before configuring a secondary address. The secondary address should not be the same as the primary address.

**NOTE:** Use **show running-config interface** not **show ip interface brief** when you need to view a secondary address configured on an interface. **show ip interface brief** will only show the primary address not a secondary address for an interface.

The **no** variant of this command removes the IP address from the tunnel interface. You cannot remove the primary address when a secondary address is present.

**Syntax** ip address <ip-addr/prefix-length> [secondary] [label <label>]  
no ip address <ip-addr/prefix-length> [secondary]  
no ip address

| Parameter               | Description                                                                                                      |
|-------------------------|------------------------------------------------------------------------------------------------------------------|
| <ip-addr/prefix-length> | The IPv4 address and prefix length you are assigning to the tunnel interface.                                    |
| <label>                 | A user-defined description of the secondary IP address. Valid characters are any printable character and spaces. |

**Mode** Interface Configuration

**Examples** To add the primary IP address 172.16.1.1/24 to the tunnel interface tunnel20, use the commands:

```
awplus# configure terminal
awplus(config)# interface tunnel20
awplus(config-if)# ip address 172.16.1.1/24
```

To add the secondary IP address 172.16.2.1/24 to the same tunnel interface, use the commands:

```
awplus# configure terminal
awplus(config)# interface tunnel20
awplus(config-if)# ip address 172.168.2.1/24 secondary
```

To remove the secondary IP address 172.16.2.1/24, use the commands:

```
awplus# configure terminal
awplus(config)# interface tunnel20
awplus(config-if)# no ip address 172.168.2.1/24 secondary
```

**Related  
Commands**    interface tunnel  
                  show ip interface  
                  show running-config interface

# ip tcp adjust-mss

**Overview** Use this command to set the Maximum Segment Size (MSS) size for an interface, where MSS is the maximum TCP data packet size that the interface can transmit before fragmentation.

Use the **no** variant of this command to remove a previously specified MSS size for a PPP interface, and restore the default MSS size.

**Syntax** `ip tcp adjust-mss {<mss-size>|pmtu}`  
`no ip tcp adjust-mss`

| Parameter                     | Description                                                            |
|-------------------------------|------------------------------------------------------------------------|
| <code>&lt;mss-size&gt;</code> | <code>&lt;64-1460&gt;</code> Specifies the MSS size in bytes.          |
| <code>pmtu</code>             | Adjust TCP MSS automatically with respect to the MTU on the interface. |

**Default** The default setting allows a TCP server or a TCP client to set the MSS value for itself.

**Mode** Interface Configuration

**Usage** When a host initiates a TCP session with a server it negotiates the IP segment size by using the MSS option field in the TCP packet. The value of the MSS option field is determined by the Maximum Transmission Unit (MTU) configuration on the host.

You can set a feasible MSS value on the following interfaces:

- PPPoE
- Ethernet
- VTI Tunnels (IPsec, GRE, IPv6, L2TP, OpenVPN)
- VLAN

**Examples** To configure an MSS size of 1452 bytes on PPP interface ppp0, use the commands:

```
awplus# configure terminal
awplus(config)# interface ppp0
awplus(config-if)# ip tcp adjust-mss 1452
```

To configure an MSS size of 1452 bytes on Ethernet interface eth1, use the commands:

```
awplus# configure terminal
awplus(config)# interface eth1
awplus(config-if)# ip tcp adjust-mss 1452
```

To restore the MSS size to the default size on PPP interface `ppp0`, use the commands:

```
awplus# configure terminal
awplus(config)# interface ppp0
awplus(config-if)# no ip tcp adjust-mss
```

**Related  
Commands**

[mtu \(PPP\)](#)  
[show interface](#)  
[show interface \(PPP\)](#)  
[show interface tunnel \(GRE\)](#)

# ipv6 address (GRE)

**Overview** Use this command to set an IPv6 address on a tunnel interface and enable IPv6. Use the optional **eui64** parameter to derive the interface identifier of the IPv6 address from the MAC address of the first Ethernet port.

Use the **no** variant of this command to remove the IPv6 address assigned and disable IPv6. Note that if no global addresses are left after removing the IPv6 address then IPv6 is disabled.

**Syntax** `ipv6 address <ipv6-addr/prefix-length> [eui64]`  
`no ipv6 address <ipv6-addr/prefix-length> [eui64]`

| Parameter                                    | Description                                                                                                                                                                                                                                                                  |
|----------------------------------------------|------------------------------------------------------------------------------------------------------------------------------------------------------------------------------------------------------------------------------------------------------------------------------|
| <code>&lt;ipv6-addr/prefix-length&gt;</code> | Specifies an IPv6 address. The IPv6 address uses the format X:X::X/prefix-length.                                                                                                                                                                                            |
| <code>eui64</code>                           | Specifies the lower 64 bits of the IPv6 address from the eui64 interface identifier (EUI - Extended Unique Identifier). EUI-64 identifiers are used as the least significant 64 bits of a unicast network address or a link-local address using stateless autoconfiguration. |

**Mode** Interface Configuration

**Usage** If the **eui64** parameter is specified then the lower 64 bits of the IPv6 address are replaced with the same address that would be acquired through stateless address autoconfiguration (SLAAC) if the device received an RA (Router Advertisement) specifying this prefix. See [ipv6 address autoconfig](#) for a detailed command description and examples to enable and disable SLAAC.

Note that link-local addresses are retained in the system until they are negated by using the no variant of the command that established them. See the [ipv6 enable](#) command for more information.

Also note that the link-local address is retained in the system if the global address is removed using another command, which was not used to establish the link-local address. For example, if a link local address is established with the [ipv6 enable](#) command then it will not be removed using a **no ipv6 address** command.

**Example** To assign the IPv6 address 2001:0db8::a2/64 to the tunnel interface `tunnel2`, use the commands:

```
awplus# configure terminal
awplus(config)# interface tunnel2
awplus(config-if)# ipv6 address 2001:0db8::a2/64
```

To remove the IPv6 address 2001:0db8::a2/64 from the tunnel interface `tunnel2`, use the commands:

```
awplus# configure terminal
awplus(config)# interface tunnel2
awplus(config-if)# no ipv6 address 2001:0db8::a2/64
```

To assign the **eui64** derived address in the prefix 2001:db8::/48 to tunnel interface `tunnel2`, use the commands:

```
awplus# configure terminal
awplus(config)# interface tunnel2
awplus(config-if)# ipv6 address 2001:0db8::/48 eui64
```

To remove the **eui64** derived address in the prefix 2001:db8::/48 from tunnel interface `tunnel2`, use the commands:

```
awplus# configure terminal
awplus(config)# interface tunnel2
awplus(config-if)# no ipv6 address 2001:0db8::/48 eui64
```

**Validation commands** [show running-config](#)  
[show ipv6 interface brief](#)

**Related commands** [ipv6 address autoconfig](#)

# ipv6 tcp adjust-mss

**Overview** Use this command to set the IPv6 Maximum Segment Size (MSS) size for an interface, where MSS is the maximum TCP data packet size that the interface can transmit before fragmentation.

Use the **no** variant of this command to remove a previously specified MSS size for a PPP interface, and restore the default MSS size.

**Syntax** `ip tcp adjust-mss {<mss-size>|pmtu}`  
`no ip tcp adjust-mss`

| Parameter                     | Description                                                            |
|-------------------------------|------------------------------------------------------------------------|
| <code>&lt;mss-size&gt;</code> | <code>&lt;64-1460&gt;</code> Specifies the MSS size in bytes.          |
| <code>pmtu</code>             | Adjust TCP MSS automatically with respect to the MTU on the interface. |

**Default** The default setting allows a TCP server or a TCP client to set the MSS value for itself.

**Mode** Interface Configuration

**Usage** When a host initiates a TCP session with a server it negotiates the IP segment size by using the MSS option field in the TCP packet. The value of the MSS option field is determined by the Maximum Transmission Unit (MTU) configuration on the host.

You can set a feasible MSS value on the following interfaces:

- PPPoE
- Ethernet
- VTI Tunnels (IPSec, GRE, IPv6, L2TP, OpenVPN)
- VLAN

**Examples** To configure an IPv6 MSS size of 1452 bytes on PPP interface ppp0, use the commands:

```
awplus# configure terminal
awplus(config)# interface ppp0
awplus(config-if)# ipv6 tcp adjust-mss 1452
```

To configure an IPv6 MSS size of 1452 bytes on Ethernet interface eth1, use the commands:

```
awplus# configure terminal
awplus(config)# interface eth1
awplus(config-if)# ip tcp adjust-mss 1452
```



To restore the MSS size to the default size on PPP interface `ppp0`, use the commands:

```
awplus# configure terminal
awplus(config)# interface ppp0
awplus(config-if)# no ip tcp adjust-mss
```

**Related  
Commands**

[mtu \(PPP\)](#)  
[show interface](#)  
[show interface \(PPP\)](#)  
[show interface tunnel \(GRE\)](#)

# show interface tunnel (GRE)

**Overview** Use this command to display status information of tunnels.

The tunnel remains inactive if no valid tunnel source or tunnel destination is configured.

**Syntax** `show interface tunnel<tunnel-index>`

| Parameter | Description                                                                                                        |
|-----------|--------------------------------------------------------------------------------------------------------------------|
| tunnel    | Specify this parameter to display tunnel status information of a given tunnel identified by the <0-255> parameter. |
| <0-255>   | Specify a tunnel index in the range from 0 through 255.                                                            |

**Mode** Privileged Exec

**Example** To display status information for GRE tunnel tunnel20, use the command:

```
awplus# show interface tunnel20
```

Figure 70-1: Example output from the **show interface tunnel** command

```
awplus#show interface tunnel20
Interface tunnel20
 Link is UP, administrative state is UP
 Hardware is Tunnel
 IPv4 address 172.16.1.1/24 pointopoint 172.16.1.255
 index 4750 metric 1 mtu 1480
 arp ageing timeout 300
 <UP,POINTOPOINT,RUNNING,MULTICAST>
 SNMP link-status traps: Disabled
 Tunnel source 192.168.1.1, destination 192.168.2.1
 Tunnel local 192.168.1.1, remote 192.168.2.1
 Tunnel protocol/transport gre, key disabled, sequencing disabled
 Tunnel TTL inherit
 Checksumming of packets disabled, path MTU discovery disabled
 input packets 0, bytes 0, dropped 0, multicast packets 0
 output packets 0, bytes 0, multicast packets 0 broadcast
 packets 0
 Time since last state change: 0 days 00:05:25
```

# show isakmp key (GRE)

**Overview** Use this command to show the ISAKMP pre-shared key. Pre-shared key authentication using optionally encrypted shared keys identified by hostname, IPv4 or IPv6 address. Pre-shared keys are not viewable and stored encrypted in the running-configuration.

**Syntax** `show [crypto] isakmp key`

| Parameter | Description                                                                                                           |
|-----------|-----------------------------------------------------------------------------------------------------------------------|
| crypto    | Security specific command.                                                                                            |
| isakmp    | Internet Security Association Key Management Protocol provides a common framework for key management implementations. |
| key       | Pre-shared key.                                                                                                       |

**Mode** Privileged Exec

**Examples** To show ISAKMP pre-shared key, enter the command below:

```
awplus# show isakmp key
```

**Output** Figure 70-2: Example output from the **show isakmp key** command

```
awplus#show isakmp key
Hostname/IP address Key
10.2.0.10 mytunnelkey
```

# tunnel checksum

**Overview** Use this command to enable GRE tunnel checksum insertion and checking. This results in the first two bytes after the protocol field in the IPv4 header containing the checksum. The tunnel checksum is used to detect packet corruption.

Use the **no** variant of this command to disable checksum insertion and checking.

**Syntax** tunnel checksum  
no tunnel checksum

**Default** Checksum insertion and checking is disabled.

**Mode** Interface Configuration

**Examples** To enable checksum insertion and checking, use the commands:

```
awplus# configure terminal
awplus(config)# interface tunnel2
awplus(config-if)# tunnel mode gre
awplus(config-if)# tunnel checksum
```

To disable checksum insertion and checking, use the commands:

```
awplus# configure terminal
awplus(config)# interface tunnel2
awplus(config-if)# no tunnel checksum
```

# tunnel dscp

**Overview** Use this command to configure the Differentiated Services Code Point (DSCP) value for the DSCP field in the packet header that encapsulates the tunneled packets.

Use the **no** variant of this command to reset the DSCP field to its default value.

**Syntax** tunnel dscp <0-63>  
no tunnel dscp

| Parameter | Description                                                                                                                           |
|-----------|---------------------------------------------------------------------------------------------------------------------------------------|
| <0-63>    | Specify the DSCP value in the range from 0 through 63 for the DSCP field in the packet header that encapsulates the tunneled packets. |

**Default** The IPv4 DSCP field value is inherited from the inner header to the outer header.

**Mode** Interface Configuration

**Examples** To configure the DSCP value to 10 for tunnel2, use the commands:

```
awplus# configure terminal
awplus(config)# interface tunnel2
awplus(config-if)# tunnel mode gre
awplus(config-if)# tunnel dscp 10
```

To remove a configured DSCP value for tunnel2, use the commands:

```
awplus# configure terminal
awplus(config)# interface tunnel2
awplus(config-if)# no tunnel dscp
```

**Related commands** interface tunnel  
tunnel mode (GRE)

# tunnel destination (GRE)

**Overview** Use this command to specify a tunnel destination for the remote end of the tunnel. Tunnel destination can be specified by using a destination network name or an IPv4 address.

Use the **no** variant of this command to remove a configured tunnel destination.

**Syntax** tunnel source {<ipv4-addr>|<destination-network-name>}  
no tunnel destination

| Parameter                            | Description                                                                                                                                                                                                                                                                  |
|--------------------------------------|------------------------------------------------------------------------------------------------------------------------------------------------------------------------------------------------------------------------------------------------------------------------------|
| <ipv4-addr>                          | Specify the tunnel destination IPv4 address in the dotted decimal format A.B.C.D.<br>The endpoints of the tunnel must be configured by mirroring IP addresses, that is, the tunnel source on one endpoint must be specified as the tunnel destination on the other endpoint. |
| <destination-network-name><br>-<br>> | Destination network name.<br>If the destination network name cannot be resolved, then the GRE tunnel remains inactive.                                                                                                                                                       |

**Mode** Interface Configuration

**Examples** To configure an IPv4 tunnel destination by using an IPv4 address, use the commands:

```
awplus# configure terminal
awplus(config)# interface tunnel40
awplus(config-if)# tunnel mode gre
awplus(config-if)# tunnel destination 2.2.2.2
```

To configure a GRE tunnel destination by using a destination network name, use the commands:

```
awplus# configure terminal
awplus(config)# interface tunnel40
awplus(config-if)# tunnel mode gre
awplus(config-if)# tunnel destination
corporate_lan.example.com
```

To remove a GRE tunnel destination, use the commands:

```
awplus# configure terminal
awplus(config)# interface tunnel40
awplus(config-if)# no tunnel destination
```

**Related commands** [interface tunnel](#)  
[tunnel mode \(GRE\)](#)  
[tunnel source \(GRE\)](#)

# tunnel local name (GRE)

**Overview** Use this command to specify an IPsec tunnel hostname to send to the peer for authentication when you apply [tunnel protection ipsec \(GRE\)](#) to encrypt the packets and configure an ISAKMP key.

Use the **no** variant of this command to remove a previously configured IPsec tunnel hostname.

**Syntax** tunnel local name *<local-name>*  
no tunnel local name

| Parameter                 | Description             |
|---------------------------|-------------------------|
| <i>&lt;local-name&gt;</i> | Source tunnel hostname. |

**Default** The default tunnel local name is the IP address of tunnel source.

**Mode** Interface Configuration

**Examples** To configure the tunnel local name office1 for tunnel6, use the commands below:

```
awplus# configure terminal
awplus(config)# interface tunnel6
awplus(config-if)# tunnel local name office1
```

To remove a configured tunnel local name for tunnel6, use the commands below:

```
awplus# configure terminal
awplus(config)# interface tunnel6
awplus(config-if)# no tunnel local name
```

**Related Commands** [tunnel remote name \(GRE\)](#)



# tunnel mode (GRE)

**Overview** Use this command to configure the encapsulation tunneling mode to use.

Use the **no** variant of this command to remove an established tunnel.

**Syntax** tunnel mode {gre [ipv6]|ipsec {ipv4|ipv6}|l2tp v3 [ipv6]|openvpn {tap|tun}}

no tunnel mode

| Parameter    | Description                                                                         |
|--------------|-------------------------------------------------------------------------------------|
| gre          | GRE IPv4 or IPv6 as the payload over IPv4 tunneling. IPv4 is the delivery protocol. |
| gre ipv6     | GRE IPv4 or IPv6 as the payload over IPv6 tunneling. IPv6 is the delivery protocol. |
| ipsec ipv4   | IPv4 IPsec tunnel                                                                   |
| ipsec ipv6   | IPv6 IPsec tunnel                                                                   |
| l2tp v3      | Layer 2 Tunneling Protocol version 3. By default, IPv4 is the deliver protocol.     |
| l2tp v3 ipv6 | Set IPv6 as the deliver protocol for L2TPv3                                         |
| openvpn tap  | OpenVPN TAP mode                                                                    |
| openvpn tun  | OpenVPN TUN mode                                                                    |

**Default** Virtual tunnel interfaces have no mode set.

**Mode** Interface Configuration

**Usage** A tunnel will not become operational until it is configured with this command.

**Examples** To configure GRE as the encapsulation mode, use the commands:

```
awplus# configure terminal
awplus(config)# interface tunnel2
awplus(config-if)# tunnel mode gre
```

To remove a configured GRE tunnel for tunnel2, use the commands:

```
awplus# configure terminal
awplus(config)# interface tunnel2
awplus(config-if)# no tunnel mode
```

**Related commands** [interface tunnel](#)

# tunnel protection ipsec (GRE)

**Overview** Use this command to optionally enable IPsec protection for packets encapsulated by this tunnel.

Use the **no** variant to disable IPsec protection.

**Syntax** tunnel protection ipsec  
no tunnel protection ipsec

**Default** IPsec protection for packets encapsulated by tunnel is disabled.

**Mode** Interface Configuration

**Usage** You also need to configure a pre-shared key in conjunction with this command. See the [crypto isakmp key](#) command for more information about configuring the pre-share key.

**Examples** To enable IPsec protection for packets encapsulated by tunnel14, use the commands below:

```
awplus# configure terminal
awplus(config)# interface tunnel14
awplus(config-if)# tunnel protection ipsec
```

To disable IPsec protection for packets encapsulated by tunnel14, use the commands below:

```
awplus# configure terminal
awplus(config)# interface tunnel14
awplus(config-if)# no tunnel protection ipsec
```

# tunnel remote name (GRE)

**Overview** Use this command to specify a tunnel remote name to authenticate the tunnel's remote peer device when you apply [tunnel protection ipsec \(GRE\)](#) to encrypt the packets and configure an ISAKMP key.

Use the **no** variant of this command to remove a previously configured tunnel remote name.

**Syntax** tunnel remote name *<remote-name>*  
no tunnel local name

| Parameter                  | Description                 |
|----------------------------|-----------------------------|
| <i>&lt;remote-name&gt;</i> | Destination tunnel hostname |

**Default** The default tunnel remote name is the IP address of tunnel destination.

**Mode** Interface Configuration

**Examples** To configure tunnel remote name *office2* for *tunnel6*, use the commands below:

```
awplus# configure terminal
awplus(config)# interface tunnel6
awplus(config-if)# tunnel remote name office2
```

To remove a configured tunnel local name for *tunnel6*, use the commands below:

```
awplus# configure terminal
awplus(config)# interface tunnel6
awplus(config-if)# no tunnel remote name
```

**Related Commands** [tunnel local name \(GRE\)](#)

# tunnel source (GRE)

**Overview** Use this command to specify a tunnel source for the tunnel interface. Tunnel source can be specified by using an interface name or an IPv4 address. The source address must be an existing IPv4 address configured for an interface.

Use the **no** variant of this command to remove a tunnel source for a tunnel interface.

**Syntax** tunnel source {<ipv4-addr>|<interface-name>}  
no tunnel source

| Parameter        | Description                                                                                                                                                                                                                                                                                       |
|------------------|---------------------------------------------------------------------------------------------------------------------------------------------------------------------------------------------------------------------------------------------------------------------------------------------------|
| <ipv4-addr>      | Specify the tunnel source IPv4 address for the GRE tunnel interface in the dotted decimal format A.B.C.D. The endpoints of the tunnel must be configured by mirroring IP addresses, that is, the tunnel source on one endpoint must be specified as the tunnel destination on the other endpoint. |
| <interface-name> | Available interface name. Any AlliedWare Plus interface type (eth, vlan, ppp, tunnel, lo and so on). Using interface name can minimize the number of user-configured IP addresses and allow the tunnel source IP address to be dynamically issued via, for example, DHCP.                         |

**Mode** Interface Configuration

**Examples** To configure a GRE tunnel source IPv4 address, use the commands:

```
awplus# configure terminal
awplus# interface eth1
awplus(config-if)# ip address 1.1.1.1/24
awplus(config-if)# interface tunnel1
awplus(config-if)# tunnel mode gre
awplus(config-if)# tunnel source 1.1.1.1
```

To use an interface name as the tunnel source, use the commands:

```
awplus# configure terminal
awplus(config)# interface tunnel2
awplus(config-if)# tunnel mode gre
awplus(config-if)# tunnel source eth2
```

To remove a GRE tunnel source, use the commands:

```
awplus# configure terminal
awplus(config)# interface tunnel1
awplus(config-if)# no tunnel source
```

**Related commands** interface tunnel  
tunnel destination (GRE)  
tunnel mode (GRE)

# tunnel ttl

**Overview** Use this command to configure the value to use for the Time to Live (TTL) field in the IPv4 header that encapsulates the tunneled IPv4 or IPv6 packets.

Use the **no** variant of this command to set the TTL value to its default.

**Syntax** tunnel ttl <1-255>  
no tunnel ttl

| Parameter | Description                   |
|-----------|-------------------------------|
| <1-255>   | TTL value from 1 through 255. |

**Default** The default TTL value is inherited from the encapsulated packet.

**Mode** Interface Configuration

**Example** To set the TTL value of the packet to 255, use the commands:

```
awplus# configure terminal
awplus(config)# interface tunnel20
awplus(config-if)# tunnel ttl 255
```

To remove the configured TTL value of the packet, use the commands:

```
awplus# configure terminal
awplus(config)# interface tunnel20
awplus(config-if)# no tunnel ttl
```

**Related commands** [interface tunnel](#)

## Introduction

This chapter provides an alphabetical reference of commands used to configure AlliedWare Plus OpenVPN.

For introductory information about AlliedWare Plus OpenVPN, including overview and configuration information, see the [OpenVPN Feature Overview and Configuration\\_Guide](#).

The table below lists the OpenVPN commands and their applicable modes.

Figure 71-1: OpenVPN commands and applicable modes

| Mode                    | Command                                      |
|-------------------------|----------------------------------------------|
| Privileged Exec         | <code>show openvpn connections</code>        |
|                         | <code>show openvpn connections detail</code> |
| Interface Configuration | <code>tunnel mode openvpn tap</code>         |
|                         | <code>tunnel mode openvpn tun</code>         |
|                         | <code>tunnel openvpn port</code>             |
|                         | <code>tunnel openvpn tagging</code>          |

- Command List**
- “`ip tcp adjust-mss`” on page 2873
  - “`ipv6 tcp adjust-mss`” on page 2875
  - “`show interface tunnel (OpenVPN)`” on page 2877
  - “`show openvpn connections`” on page 2878
  - “`show openvpn connections detail`” on page 2879
  - “`tunnel openvpn authentication`” on page 2880
  - “`tunnel openvpn cipher`” on page 2881

- [“tunnel mode openvpn tap”](#) on page 2883
- [“tunnel mode openvpn tun”](#) on page 2884
- [“tunnel openvpn expiry-bytes”](#) on page 2885
- [“tunnel openvpn expiry-seconds”](#) on page 2886
- [“tunnel openvpn port”](#) on page 2887
- [“tunnel openvpn tagging”](#) on page 2888



# ip tcp adjust-mss

**Overview** Use this command to set the Maximum Segment Size (MSS) size for an interface, where MSS is the maximum TCP data packet size that the interface can transmit before fragmentation.

Use the **no** variant of this command to remove a previously specified MSS size for a PPP interface, and restore the default MSS size.

**Syntax** `ip tcp adjust-mss {<mss-size>|pmtu}`  
`no ip tcp adjust-mss`

| Parameter                     | Description                                                            |
|-------------------------------|------------------------------------------------------------------------|
| <code>&lt;mss-size&gt;</code> | <code>&lt;64-1460&gt;</code> Specifies the MSS size in bytes.          |
| <code>pmtu</code>             | Adjust TCP MSS automatically with respect to the MTU on the interface. |

**Default** The default setting allows a TCP server or a TCP client to set the MSS value for itself.

**Mode** Interface Configuration

**Usage** When a host initiates a TCP session with a server it negotiates the IP segment size by using the MSS option field in the TCP packet. The value of the MSS option field is determined by the Maximum Transmission Unit (MTU) configuration on the host.

You can set a feasible MSS value on the following interfaces:

- PPPoE
- Ethernet
- VTI Tunnels (IPsec, GRE, IPv6, L2TP, OpenVPN)
- VLAN

**Examples** To configure an MSS size of 1452 bytes on PPP interface ppp0, use the commands:

```
awplus# configure terminal
awplus(config)# interface ppp0
awplus(config-if)# ip tcp adjust-mss 1452
```

To configure an MSS size of 1452 bytes on Ethernet interface eth1, use the commands:

```
awplus# configure terminal
awplus(config)# interface eth1
awplus(config-if)# ip tcp adjust-mss 1452
```

To restore the MSS size to the default size on PPP interface `ppp0`, use the commands:

```
awplus# configure terminal
awplus(config)# interface ppp0
awplus(config-if)# no ip tcp adjust-mss
```

**Related  
Commands**

[mtu \(PPP\)](#)  
[show interface](#)  
[show interface \(PPP\)](#)  
[show interface tunnel \(GRE\)](#)

# ipv6 tcp adjust-mss

**Overview** Use this command to set the IPv6 Maximum Segment Size (MSS) size for an interface, where MSS is the maximum TCP data packet size that the interface can transmit before fragmentation.

Use the **no** variant of this command to remove a previously specified MSS size for a PPP interface, and restore the default MSS size.

**Syntax** `ip tcp adjust-mss {<mss-size>|pmtu}`  
`no ip tcp adjust-mss`

| Parameter                     | Description                                                            |
|-------------------------------|------------------------------------------------------------------------|
| <code>&lt;mss-size&gt;</code> | <code>&lt;64-1460&gt;</code> Specifies the MSS size in bytes.          |
| <code>pmtu</code>             | Adjust TCP MSS automatically with respect to the MTU on the interface. |

**Default** The default setting allows a TCP server or a TCP client to set the MSS value for itself.

**Mode** Interface Configuration

**Usage** When a host initiates a TCP session with a server it negotiates the IP segment size by using the MSS option field in the TCP packet. The value of the MSS option field is determined by the Maximum Transmission Unit (MTU) configuration on the host.

You can set a feasible MSS value on the following interfaces:

- PPPoE
- Ethernet
- VTI Tunnels (IPSec, GRE, IPv6, L2TP, OpenVPN)
- VLAN

**Examples** To configure an IPv6 MSS size of 1452 bytes on PPP interface ppp0, use the commands:

```
awplus# configure terminal
awplus(config)# interface ppp0
awplus(config-if)# ipv6 tcp adjust-mss 1452
```

To configure an IPv6 MSS size of 1452 bytes on Ethernet interface eth1, use the commands:

```
awplus# configure terminal
awplus(config)# interface eth1
awplus(config-if)# ip tcp adjust-mss 1452
```

To restore the MSS size to the default size on PPP interface `ppp0`, use the commands:

```
awplus# configure terminal
awplus(config)# interface ppp0
awplus(config-if)# no ip tcp adjust-mss
```

**Related  
Commands**

[mtu \(PPP\)](#)  
[show interface](#)  
[show interface \(PPP\)](#)  
[show interface tunnel \(GRE\)](#)

# show interface tunnel (OpenVPN)

**Overview** Use this command to display status information of tunnels.

The tunnel remains inactive if no valid tunnel source or tunnel destination is configured.

**Syntax** `show interface tunnel<tunnel-index>`

| Parameter      | Description                                                                                                        |
|----------------|--------------------------------------------------------------------------------------------------------------------|
| tunnel         | Specify this parameter to display tunnel status information of a given tunnel identified by the <0-255> parameter. |
| <tunnel-index> | Specify a tunnel index in the range from 0 through 255.                                                            |

**Mode** Privileged Exec

**Examples** To display brief status information for OpenVPN tunnel0, enter the command below:

```
awplus# show interface tunnel0
```

**Output** Figure 71-2: Example output from the **show interface tunnel** command

```
awplus#show interface tunnel0
Interface tunnel0
 Link is UP, administrative state is UP
 Hardware is Tunnel
 IPv4 address 192.168.1.1/24 pointopoint 192.168.1.255
 IPv6 address 2001:db8:1::1/64
 IPv6 address fe80::200:cdff:fe38:111/64
 index 12 metric 1 mtu 1500
 <UP, POINTOPOINT, RUNNING, MULTICAST>
 SNMP link-status traps: Disabled
 Tunnel source UNKNOWN, destination UNKNOWN
 Tunnel name local AR3050S, remote UNKNOWN
 Tunnel ID local (not set), remote (not set)
 Tunnel protocol/transport openvpn tun, key disabled, sequencing disabled
 Tunnel TTL -
 Checksumming of packets disabled, path MTU discovery disabled
 input packets 0, bytes 0, dropped 0, multicast packets 0
 output packets 8, bytes 488, multicast packets 0 broadcast packets 0
 Time since last state change: 0 days 00:00:36
```

# show openvpn connections

**Overview** Use this command to show information about connected OpenVPN users.

**Syntax** show openvpn connections

**Mode** Privileged Exec

**Examples** To show information about connected OpenVPN users, use the command:

```
awplus# show openvpn connections
```

**Output** Figure 71-3: Example output from the **show openvpn connections** command

```
awplus#show openvpn connections

Maximum connections: 100

Interface: tunnel0

Username Real Address Rx Tx Bytes Bytes Connected
Since

foo ::ffff:192.168.1.2 3553 3906 Wed Aug 13
01:09:07 2014
```

**Related Commands** [show openvpn connections detail](#)

# show openvpn connections detail

**Overview** Use this command to show detailed information about connected OpenVPN users.

Note that in the output parameters (such as Route, Address, DNS Server) for a specific user may vary because the parameters depend on the configuration information of the RADIUS server associated with the user.

**Syntax** `show openvpn connections detail`

**Mode** Privileged Exec

**Examples** To show detailed information about connected OpenVPN users, use the command:

```
awplus# show openvpn connections detail
```

**Output** Figure 71-4: Example output from the **show openvpn connections detail** command

```
awplus#show openvpn connections detail

Interface: tunnel0
Username: user1
Route: 192.168.20.0 255.255.255.0 192.168.10.2
Address: 192.168.10.3 255.255.255.0
DNS Server: 192.168.10.253
DNS Server: 192.168.10.254
VID: 20
Username: user2
Route: 192.168.20.0 255.255.255.0 192.168.10.2
Address: 192.168.10.4 255.255.255.0
DNS Server: 192.168.10.253
DNS Server: 192.168.10.254
VID: 20
```

**Related Commands** [show openvpn connections](#)

# tunnel openvpn authentication

**Overview** Use this command to configure the data channel authentication digest for an OpenVPN tunnel.

Use the **no** variant of this command to set the data channel authentication digest for an OpenVPN tunnel to its default value of SHA1.

**Syntax** tunnel openvpn authentication {sha1|sha256}  
no tunnel openvpn authentication

| Parameter | Description                                                                                  |
|-----------|----------------------------------------------------------------------------------------------|
| aes128    | Use Secure Hash Standard with 160-bit digest size as the data channel authentication digest. |
| aes256    | Use Secure Hash Standard with 256-bit digest size as the data channel authentication digest. |

**Default** SHA1

**Mode** Interface configuration

**Usage** You need to configure the client to use the same setting as the server. To do this, include one of the following lines in your client's OpenVPN configuration (.ovpn) file:

| Setting | Line        |
|---------|-------------|
| SHA1    | auth SHA1   |
| SHA256  | auth SHA256 |

**Example** To configure tunnel 5, which is an OpenVPN tunnel, to use SHA256 data channel authentication, use the commands:

```
awplus# configure terminal
awplus(config)# interface tunnel5
awplus(config-if)# tunnel openvpn authentication SHA256
```

**Related Commands** [tunnel openvpn cipher](#)

**Command changes** Version 5.4.7-0.1: command added



# tunnel openvpn cipher

**Overview** Use this command to configure the data channel encryption cipher for an OpenVPN tunnel.

Use the **no** variant of this command to set the data channel encryption cipher for an OpenVPN tunnel to its default value of AES-128.

**Syntax** tunnel openvpn cipher {aes128|aes256}  
no tunnel openvpn cipher

| Parameter | Description                                                                                                           |
|-----------|-----------------------------------------------------------------------------------------------------------------------|
| aes128    | Use Advanced Encryption Standard symmetric key block cipher with a 128-bit key as the data channel encryption cipher. |
| aes256    | Use Advanced Encryption Standard symmetric key block cipher with a 256-bit key as the data channel encryption cipher. |

**Default** AES-128

**Mode** Interface configuration

**Usage** You need to configure the client to use the same setting as the server. To do this, include one of the following lines in your client's OpenVPN configuration (.ovpn) file:

| Setting | Line               |
|---------|--------------------|
| AES-128 | cipher AES-128-CBC |
| AES-256 | cipher AES-256-CBC |

For example, consider a client file tun.ovpn that has the following settings:

```
tun.ovpn
client
auth-user-pass
cipher AES-128-CBC
dev tap
proto udp
remote 192.168.1.1
ca c:/users/support/cacert.pem
verb 7
```

To change the client to AES-256, replace the line "cipher AES-128-CBC" with "cipher AES-256-CBC".

**Example** To configure tunnel 5, which is an OpenVPN tunnel, to use AES-256 data channel encryption, use the commands:

```
awplus# configure terminal
awplus(config)# interface tunnel5
awplus(config-if)# tunnel openvpn cipher aes256
```

**Related Commands** [tunnel openvpn authentication](#)

**Command changes** Version 5.4.7-0.1: command added

# tunnel mode openvpn tap

**Overview** Use this command to set the tunnel mode to OpenVPN TAP for a tunnel interface.

Use the **no** variant of this command to remove the mode.

TAP is a virtual network device. TAP creates a Virtual Tunnel Interface (VTI) that carries layer 2 frames. You may want to use TAP in the following scenarios:

- You want to use bridges to transport Ethernet frames
- You want to transport any network protocol, such as IPv4, IPv6, IPX

Note that TAP will cause broadcast overhead on the VPN tunnel and add the overhead of Ethernet headers on all packets transported over the VPN tunnel.

Note that the distribution of client IP addresses through DHCP is only supported in TAP mode.

**Syntax** tunnel mode openvpn tap  
no tunnel mode

**Mode** Interface Configuration

**Examples** To set tunnel15 to be an OpenVPN tunnel in TAP mode, use the commands:

```
awplus# configure terminal
awplus(config)# interface tunnel15
awplus(config-if)# tunnel mode openvpn tap
```

To remove tunnel mode, use the commands:

```
awplus# configure terminal
awplus(config)# interface tunnel15
awplus(config-if)# no tunnel mode
```

**Related Commands** [tunnel mode openvpn tun](#)

# tunnel mode openvpn tun

**Overview** Use this command to set the tunnel mode to OpenVPN TUN for a tunnel interface.

Use the **no** variant of this command to remove the mode.

TUN is a virtual network device. TUN creates a Virtual Tunnel Interface (VTI) that carries layer 3 packets. You may want to use TUN in the following scenarios:

- You want to transport traffic that is destined for the VPN client
- You want to transport only layer 3 packets
- You want to support VPN on mobile devices

Note that TUN cannot be used in bridges and broadcast traffic is not transported in TUN mode.

**Syntax** tunnel mode openvpn tun  
no tunnel mode

**Mode** Interface Configuration

**Examples** To set tunnel15 to be an OpenVPN tunnel in TUN mode, use the commands:

```
awplus# configure terminal
awplus(config)# interface tunnel15
awplus(config-if)# tunnel mode openvpn tun
```

To remove tunnel mode, use the commands:

```
awplus# configure terminal
awplus(config)# interface tunnel15
awplus(config-if)# no tunnel mode
```

**Related Commands** [tunnel mode openvpn tap](#)

# tunnel openvpn expiry-bytes

**Overview** Use this command to change how the firewall decides when to renegotiate client keys. By default, client keys are renegotiated after an hour; you can use this command to base rekeying on data usage instead of time.

Use the **no** variant of this command to return to time-based rekeying instead.

**Syntax** `tunnel openvpn expiry-bytes <0-4294967295>`  
`no tunnel openvpn expiry-bytes`

| Parameter                                                      | Description                                                                                                                                                                                                                                                                                              |
|----------------------------------------------------------------|----------------------------------------------------------------------------------------------------------------------------------------------------------------------------------------------------------------------------------------------------------------------------------------------------------|
| <code>expiry-bytes</code><br><code>&lt;0-4294967295&gt;</code> | The number of bytes of traffic after which the firewall renegotiates client keys. A value of 0 bytes means that keys are not renegotiated after the VPN is formed. Otherwise, setting the expiry-bytes to a non-zero value will cause a rekey when the firewall has received that many bytes of traffic. |

**Default** Not configured - the firewall renegotiates keys every hour instead.

**Mode** Interface mode for a tunnel

**Usage** If you intend to use more than 100 concurrent tunnels, we recommend you use this command to change to rekeying based on data usage per VPN tunnel instead of timer-based rekeying. Each VPN tunnel will then independently rekey once it reaches the data limit. This prevents all tunnels from rekeying at the same time.

**Example** To configure tunnel2 to rekey after 1Gbyte of traffic, use the following commands:

```
awplus# configure terminal
awplus(config)# interface tunnel2
awplus(config-if)# tunnel openvpn expiry-bytes 1000000000
```

To return tunnel2 to the default of rekeying hourly, use the following commands:

```
awplus# configure terminal
awplus(config)# interface tunnel2
awplus(config-if)# no tunnel openvpn expiry-bytes
```

**Related Commands** [tunnel openvpn expiry-seconds](#)

**Command changes** Version 5.4.7-0.1: command added

# tunnel openvpn expiry-seconds

**Overview** Use this command to change when client keys are renegotiated. By default, client keys are renegotiated after an hour; you can use this command to turn off renegotiation or to change that time period.

Use the **no** variant of this command to return to the default of 1 hour.

**Syntax** tunnel openvpn expiry-seconds <0-4294967295>  
no tunnel openvpn expiry-seconds

| Parameter                        | Description                                                                                                                                                                                                                                                             |
|----------------------------------|-------------------------------------------------------------------------------------------------------------------------------------------------------------------------------------------------------------------------------------------------------------------------|
| expiry-seconds<br><0-4294967295> | The length of time after which the firewall renegotiates client keys. A value of 0 seconds means that keys are not renegotiated after the VPN is formed. Otherwise, setting the expiry-seconds to a non-zero timer value will cause a rekey when that time is exceeded. |

**Default** 3600 seconds (1 hour).

**Mode** Interface mode for a tunnel

**Usage** If you intend to use more than 100 concurrent tunnels, we recommend you change to rekeying based on data usage per VPN tunnel instead of timer-based rekeying. Each VPN tunnel will then independently rekey once it reaches the data limit. This prevents all tunnels from rekeying at the same time. To rekey based on data usage per VPN, use the [tunnel openvpn expiry-bytes](#) command.

**Example** To configure tunnel2 to rekey every 30 minutes, use the following commands:

```
awplus# configure terminal
awplus(config)# interface tunnel2
awplus(config-if)# tunnel openvpn expiry-seconds 1800
```

To return tunnel2 to the default of rekeying hourly, use the following commands:

```
awplus# configure terminal
awplus(config)# interface tunnel2
awplus(config-if)# no tunnel openvpn expiry-seconds
```

**Related Commands** [tunnel openvpn expiry-bytes](#)

**Command changes** Version 5.4.7-0.1: command added

# tunnel openvpn port

**Overview** Use this command to specify the UDP listening port that is used to receive OpenVPN tunnel connections.

Use the **no** variant to set the port number to its default value which is 1194.

**Syntax** tunnel openvpn port <1-65535>  
no tunnel openvpn port

| Parameter | Description                       |
|-----------|-----------------------------------|
| <1-65535> | Port number from 1 through 65535. |

**Default** The default UDP port number is 1194.

**Mode** Interface Configuration

**Usage** If firewall protection is enabled, you need to create a firewall rule that allows the OpenVPN application traffic to traverse the firewall. OpenVPN is a pre-defined application with destination port number 1194. You can use the [show application detail](#) command to see the application details. If you specify a UDP number that is different to the default port number, you need to create an application with the same specified UDP port number for OpenVPN, and then create a firewall rule to allow the application to traverse the firewall. For more information about firewall rules, see the [rule \(Firewall\)](#) command.

**Examples** To configure tunnel `tunnel15` to receive incoming tunnel connections on UDP port 4567, use the commands:

```
awplus(config)# interface tunnel15
awplus(config-if)# tunnel openvpn port 4567
```

To remove the specified UDP port for tunnel `tunnel15` and set the UDP port to its default value, use the commands:

```
awplus# configure terminal
awplus(config)# interface tunnel15
awplus(config-if)# no tunnel openvpn port
```

# tunnel openvpn tagging

**Overview** This command configures an OpenVPN tunnel to add an 802.1Q tag (a VLAN ID) to traffic received over the tunnel. VLAN ID (VID) is a VLAN identifier that is used to determine which VLAN the traffic belongs to. The VID is determined from information received from the RADIUS server during the authentication process. If no VID information is received from the RADIUS server, the value specified in this command is used.

Use the **no** variant of this command to remove the VID over the tunnel.

Note that you can add an 802.1Q tag in the TAP mode only.

**Syntax** tunnel openvpn tagging <1-4094>  
no tunnel openvpn tagging

| Parameter | Description                 |
|-----------|-----------------------------|
| <1-4094>  | VLAN ID from 1 through 4094 |

**Mode** Interface Configuration

**Examples** To add a 802.1Q tag to packets received over tunnel `tunnel5`, use the commands:

```
awplus# configure terminal
awplus(config)# interface tunnel5
awplus(config-if)# tunnel openvpn tagging 1
```

To remove the 802.1Q tag over tunnel `tunnel5`, use the commands:

```
awplus# configure terminal
awplus(config)# interface tunnel5
awplus(config-if)# no tunnel openvpn tagging
```



# 72

# L2TP Commands

## Introduction

This chapter provides an alphabetical reference of commands used to configure L2TPv2 and L2TPv3 tunnels.

For introductory information about L2TPv3 in AlliedWare Plus, including overview and configuration information, see the [L2TPv3 Ethernet Pseudowire Feature Overview and Configuration Guide](#).

For introductory information about tunneling of PPP over L2TPv2 in AlliedWare Plus, including overview and configuration information, see the [L2TPv2 Feature Overview and Configuration Guide](#).

- Command List**
- ["crypto isakmp key"](#) on page 2891
  - ["debug l2tp"](#) on page 2893
  - ["destination"](#) on page 2894
  - ["encapsulation ppp"](#) on page 2895
  - ["ip-version"](#) on page 2897
  - ["l2tp tunnel"](#) on page 2898
  - ["l2tp unmanaged port"](#) on page 2900
  - ["l2tp-profile"](#) on page 2901
  - ["local-subaddress"](#) on page 2902
  - ["protection ipsec"](#) on page 2903
  - ["protection local-name"](#) on page 2904
  - ["protection profile"](#) on page 2906
  - ["protection remote-name"](#) on page 2907
  - ["remote-subaddress"](#) on page 2909
  - ["shared-secret"](#) on page 2910

- [“show debugging l2tp”](#) on page 2911
- [“show interface tunnel \(L2TPv3\)”](#) on page 2912
- [“show isakmp key \(L2TPv3\)”](#) on page 2913
- [“show l2tp session”](#) on page 2914
- [“show l2tp tunnel”](#) on page 2916
- [“show l2tp tunnel config-check”](#) on page 2920
- [“show running-config l2tp-profile”](#) on page 2922
- [“show running-config l2tp-tunnel”](#) on page 2923
- [“source”](#) on page 2924
- [“tunnel local id”](#) on page 2925
- [“tunnel mode \(L2TPv3\)”](#) on page 2926
- [“tunnel protection ipsec”](#) on page 2927
- [“tunnel remote id”](#) on page 2928
- [“version”](#) on page 2929

# crypto isakmp key

**Overview** Use this command to configure a pre-shared authentication key.

Pre-shared key authentication uses optionally encrypted shared keys identified by hostname, IPv4 or IPv6 address. Pre-shared keys are not viewable and stored encrypted in the running-configuration.

You must configure this key whenever you specify pre-shared keys in an (Internet Key Exchange) IKE policy and at both peers.

To use the no variant to remove a previously created pre-shared key.

**Syntax** `crypto isakmp key [8] <key> {hostname <host-name>|address {<ipv4-address>|<ipv6-address>}}`  
`no crypto isakmp key [8] <key> {hostname <host-name>|address {<ipv4-address>|<ipv6-address>}}`

| Parameter   | Description                                                                                                           |
|-------------|-----------------------------------------------------------------------------------------------------------------------|
| crypto      | Security specific command.                                                                                            |
| isakmp      | Internet Security Association Key Management Protocol provides a common framework for key management implementations. |
| key         | Pre-shared key.                                                                                                       |
| <key>       | Specify the pre-shared key. Us any combination of alphanumeric characters up to 128 bytes.                            |
| 8           | Specifies that an encrypted key follows.                                                                              |
| <host-name> | Destination hostname.                                                                                                 |
| <ipv4-addr> | Destination IPv4 address. The IPv4 address uses the format A.B.C.D.                                                   |
| <ipv6-addr> | Destination IPv6 address. The IPv4 address uses the format X:X::X:X.                                                  |

**Default** ISAKMP keys do not exist.

**Mode** Global Configuration

**Examples** To configure a pre-shared authentication key for a destination host, use the commands:

```
awplus#configure terminal
awplus(config)#crypto isakmp key friend hostname
mypeer@my.domain.com
```

To configure a pre-shared authentication key at a peer with IPv4 address, use the commands:

```
awplus#configure terminal
awplus(config)#crypto isakmp key friend address 192.168.1.1
```

To configure a pre-shared encrypted authentication key at a peer with IPv4 address, use the commands:

```
awplus#configure terminal
awplus(config)#crypto isakmp key 8 Nhe6ioQmzbysQaJr6Du+cA==
address 192.168.1.2
```

To remove a pre-shared key at a peer, use the commands:

```
awplus#configure terminal
awplus(config)#no crypto isakmp key friend hostname
mypeer@my.domain.com
```

# debug l2tp

**Overview** Use this command to enable debugging of L2TPv2 tunnels.  
Use the **no** variant of this command to disable debugging of L2TPv2 tunnels.

**Syntax** debug l2tp  
no debug l2tp  
undebug l2tp

**Default** Debugging of L2TPv2 tunnels is disabled by default.

**Mode** Privileged Exec

**Example** To enable debugging for L2TPv2 tunnels, use the commands:

```
awplus# debug l2tp
awplus# terminal monitor
% Warning: Console logging enabled
```

To disable debugging of L2TPv2 tunnels, use the command:

```
awplus# no debug l2tp
```

or the command:

```
awplus# undebug l2tp
```

**Related  
Commands** [debug pppoe-ac](#)  
[show debugging l2tp](#)

# destination

**Overview** Use this command to set the destination of an L2TP tunnel.

Use the **no** variant of this command to remove the destination from the L2TP tunnel.

**Syntax** `destination [<ipv4-addr>|<ipv6-addr>|<domain-name>]`  
`no destination`

| Parameter                        | Description                                                          |
|----------------------------------|----------------------------------------------------------------------|
| <code>&lt;ipv4-addr&gt;</code>   | The destination of the L2TP tunnel as an IPv4 address.               |
| <code>&lt;ipv6-addr&gt;</code>   | The destination of the L2TP tunnel as an IPv6 address.               |
| <code>&lt;domain-name&gt;</code> | The destination of the L2TP tunnel as a fully-qualified domain name. |

**Default** No destination is set by default.

**Mode** L2TP Tunnel Configuration

**Example** To set the destination IP address for tunnel1 to 10.1.1.1, use the commands:

```
awplus# configure terminal
awplus(config)# l2tp tunnel tunnel1
awplus(config-l2tp-tunnel)# destination 10.1.1.1
```

To remove the destination IP address from tunnel1, use the commands:

```
awplus# configure terminal
awplus(config)# l2tp tunnel tunnel1
awplus(config-l2tp-tunnel)# no destination
```

**Related Commands**

- [encapsulation ppp](#)
- [ip-version](#)
- [l2tp tunnel](#)
- [show l2tp tunnel config-check](#)
- [show running-config l2tp-tunnel](#)
- [source](#)
- [version](#)

# encapsulation ppp

**Overview** Use this command to enable PPP encapsulation and create one or more PPP interfaces over Ethernet, a cellular interface, or a L2TPv2 managed VPN.

Use the **no** variant of this command to disable PPP encapsulation and remove the specified PPP interface.

**Syntax** encapsulation ppp <index>  
no encapsulation ppp <index>

| Parameter | Description                                                |
|-----------|------------------------------------------------------------|
| <index>   | The PPP interface index number in the range from 0 to 255. |

**Default** No PPP encapsulation or interfaces are configured by default.

**Mode** Interface Configuration mode for an Ethernet interface (e.g. **interface eth1**), or an Ethernet sub-interface (e.g. **interface eth1.1**), or a cellular interface (e.g. **interface cellular0**).

L2TP Tunnel Configuration mode for an L2TP tunnel (e.g. **l2tp tunnel tunnel0**).

**Examples** To configure a PPP interface with index 0 for Ethernet interface eth1, use the commands:

```
awplus# configure terminal
awplus(config)# interface eth1
awplus(config-if)# encapsulation ppp 0
```

To shut down the ppp0 interface and remove it from Ethernet interface eth1, use the commands:

```
awplus# configure terminal
awplus(config)# interface ppp0
awplus(config-if)# shutdown
awplus(config-if)# interface eth1
awplus(config-if)# no encapsulation ppp 0
```

To set the L2TP tunnel tunnel1 to encapsulate the PPP interface with index 1, use the commands:

```
awplus# configure terminal
awplus(config)# l2tp tunnel tunnel1
awplus(config-l2tp-tunnel)# encapsulation ppp 1
```

To remove the PPP interface with index 1 from L2TP tunnel tunnel1, use the commands:

```
awplus# configure terminal
awplus(config)# l2tp tunnel tunnel1
awplus(config-l2tp-tunnel)# no encapsulation ppp 1
```

**Related  
Commands**

[l2tp tunnel](#)  
[ppp service-name \(PPPoE\)](#)  
[show interface \(PPP\)](#)



# ip-version

**Overview** Use this command to set the IP version for the L2TP tunnel.  
The IP version must be set to the same value at both ends of the tunnel.

**Syntax** `ip-version [4|6]`

| Parameter | Description |
|-----------|-------------|
| 4         | IPv4        |
| 6         | IPv6        |

**Default** The IP version is set to IPv4 by default.

**Mode** L2TP Tunnel Configuration

**Example** To set the IP version for tunnel1 to IPv6, use the commands:

```
awplus# configure terminal
awplus(config)# l2tp tunnel tunnel1
awplus(config-l2tp-tunnel)# ip-version 6
```

To set the IP version for tunnel1 to the default (IPv4), use the commands:

```
awplus# configure terminal
awplus(config)# l2tp tunnel tunnel1
awplus(config-l2tp-tunnel)# ip-version 4
```

**Related Commands**

- [encapsulation ppp](#)
- [ip-version](#)
- [l2tp tunnel](#)
- [show running-config l2tp-tunnel](#)
- [show l2tp tunnel config-check](#)
- [source](#)
- [version](#)

# l2tp tunnel

**Overview** Use this command to create a named L2TP tunnel, and to enter L2TP Tunnel Configuration mode to configure it.

Use the **no** variant of this command to remove the named tunnel and all of its configuration.

**Syntax** `l2tp tunnel <tunnel-name>`  
`no l2tp tunnel <tunnel-name>`

| Parameter                        | Description                                         |
|----------------------------------|-----------------------------------------------------|
| <code>&lt;tunnel-name&gt;</code> | The name of the tunnel to create, change or delete. |

**Default** No L2TP tunnel is configured by default.

**Mode** Global Configuration

**Example** To create and begin configuring a new L2TP tunnel named 'tunnel1', use the commands:

```
awplus# configure terminal
awplus(config)# l2tp tunnel tunnel1
awplus(config-l2tp-tunnel)#
```

To remove the tunnel 'tunnel1' and its configuration, use the commands:

```
awplus# configure terminal
awplus(config)# no l2tp tunnel tunnel1
```

**Related Commands**

- [destination](#)
- [encapsulation ppp](#)
- [ip-version](#)
- [local-subaddress](#)
- [protection ipsec](#)
- [protection local-name](#)
- [protection profile](#)
- [protection remote-name](#)
- [remote-subaddress](#)
- [shared-secret](#)
- [show l2tp session](#)
- [show l2tp tunnel](#)

show l2tp tunnel config-check  
show running-config l2tp-tunnel  
source  
version

# l2tp unmanaged port

**Overview** Use this command to set the UDP port for an (IPv4 and IPv6) unmanaged L2TP tunnel (L2TPv3 Ethernet Pseudowires).

This command can only change the UDP port when there is no unmanaged L2TP tunnel (L2TPv3 Ethernet Pseudowires) configured.

Use the **no** variant of this command to reset the UDP port to the default (1701).

**Syntax** `l2tp unmanaged port [<1-65535>]`  
`no l2tp unmanaged port`

| Parameter | Description                                                                                   |
|-----------|-----------------------------------------------------------------------------------------------|
| <1-65535> | The number of the UDP port to use for an unmanaged L2TP tunnel (L2TPv3 Ethernet Pseudowires). |

**Default** The UDP port is 1701 by default.

**Mode** Global Configuration

**Usage** The default UDP port for both unmanaged and managed L2TP tunnels is 1701. If both kinds of tunnel will be configured, the UDP port for the unmanaged tunnel must be changed to a different port by using the **l2tp unmanaged port** command.

Be aware of potential clashes with other UDP port users. Unless it is likely to be used for other purposes, we recommend configuring UDP port 1702 as a suitable alternative.

**Example** To set the UDP port for an L2TP unmanaged tunnel (L2TPv3 Ethernet Pseudowires) to 1702, use the following commands:

```
awplus# configure terminal
awplus(config)# l2tp unmanaged port 1702
```

**Related Commands** [tunnel mode \(L2TPv3\)](#)  
[show running-config](#)

# l2tp-profile

**Overview** Use this command to create an L2TP profile and to enter the L2TP Profile Configuration mode.

Use the **no** variant of this command to remove the L2TP profile and all its configuration.

**Syntax** `l2tp-profile <name>`  
`no l2tp-profile <name>`

| Parameter                 | Description                                               |
|---------------------------|-----------------------------------------------------------|
| <code>&lt;name&gt;</code> | The name of the L2TP profile being created or configured. |

**Default** No L2TP profile is configured by default. This command is not configured by default.

**Mode** Global Configuration

**Example** To create a L2TP profile named "public", use the commands:

```
awplus# configure terminal
awplus(config)# l2tp-profile public
awplus(config-l2tp-profile)#
```

To remove all configuration of this L2TP profile, use the commands:

```
awplus# configure terminal
awplus(config)# no l2tp-profile public
```

**Related Commands**

- [l2tp profile](#)
- [pppoe-ac](#)
- [shared-secret](#)
- [show running-config l2tp-profile](#)
- [version](#)

# local-subaddress

**Overview** Use this command to set the local sub-address for L2TPv2 tunnel authentication. Use the **no** variant of this command to remove the configured local sub-address.

**Syntax** `local-subaddress [<sub-address>]`  
`no local-subaddress`

| Parameter                        | Description                           |
|----------------------------------|---------------------------------------|
| <code>&lt;sub-address&gt;</code> | The local sub-address for the tunnel. |

**Default** The local sub-address is not set by default; by default, the received L2TPv2 sub-address AVP will not be checked before establishing the tunnel.

**Mode** L2TP Tunnel Configuration

**Usage** If a local sub-address is set, this is checked against incoming the sub-address AVP as a requirement for tunnel establishment. The received sub-address AVP content must match the configured local sub-address.

**Example** To set the local-sub address of tunnel1 to 'office1', use the commands:

```
awplus# configure terminal
awplus(config)# l2tp tunnel tunnel1
awplus(config-l2tp-tunnel)# local-subaddress office1
```

To remove the local sub-address configuration from tunnel1, use the commands:

```
awplus# configure terminal
awplus(config)# l2tp tunnel tunnel1
awplus(config-l2tp-tunnel)# no local-subaddress
```

**Related Commands**

- [l2tp tunnel](#)
- [remote-subaddress](#)
- [show l2tp tunnel config-check](#)
- [show running-config l2tp-tunnel](#)

# protection ipsec

**Overview** Use this command to enable IPsec protection on the L2TP tunnel.  
Use the **no** variant of this command to disable IPsec on the tunnel.

**Syntax** `protection ipsec`  
`no protection ipsec`

**Default** IPsec protection is disabled by default.

**Mode** L2TP Tunnel Configuration

**Example** To protect tunnel1 with IPsec, use the commands:

```
awplus# configure terminal
awplus(config)# l2tp tunnel tunnel1
awplus(config-l2tp-tunnel)# protection ipsec
```

To disable IPsec protection for tunnel1, use the commands:

```
awplus# configure terminal
awplus(config)# l2tp tunnel tunnel1
awplus(config-l2tp-tunnel)# no protection ipsec
```

**Related Commands**

- [l2tp tunnel](#)
- [protection ipsec](#)
- [protection local-name](#)
- [protection profile](#)
- [protection remote-name](#)
- [show l2tp tunnel config-check](#)
- [show running-config l2tp-tunnel](#)

# protection local-name

**Overview** Use this command to set the IPsec local name for the L2TP tunnel. This is the local identifier for IKE.

Use the **no** variant of this command to reset the local name to the default—the source IP address of the L2TP tunnel.

**Syntax** protection local-name [<ipsec-local-name>]  
no protection local-name

| Parameter          | Description                          |
|--------------------|--------------------------------------|
| <ipsec-local-name> | The IPsec local name for the tunnel. |

**Default** By default, the IPsec local name is set to the source IP address of the L2TP tunnel.

**Mode** L2TP Tunnel Configuration

**Usage** If no local name is configured with this command, the source IP address of the tunnel is used. If a local name is configured with this command, the **crypto isakmp key** command is required to configure a preshared authentication key using this local name as the hostname.

**Example** To set the IPsec local name for tunnel1 to office1 and set the key to 'friend', use the commands:

```
awplus# configure terminal
awplus(config)# l2tp tunnel tunnel1
awplus(config-l2tp-tunnel)# protection ipsec
awplus(config-l2tp-tunnel)# protection local-name office1
awplus(config)# crypto isakmp key friend hostname office1
```

To remove the IPsec local name for tunnel1, use the commands:

```
awplus# configure terminal
awplus(config)# l2tp tunnel tunnel1
awplus(config-l2tp-tunnel)# no protection local-name
```

**Related Commands**

- [crypto isakmp key](#)
- [l2tp tunnel](#)
- [protection ipsec](#)
- [protection profile](#)
- [protection remote-name](#)
- [show l2tp tunnel config-check](#)



show running-config l2tp-tunnel

# protection profile

**Overview** Use this command to set the IPsec profile to use for this L2TP tunnel.  
Use the **no** variant of this command to set it back to the default IPsec profile: the profile named 'default'.

**Syntax** protection profile [*<profile-name>*]  
no protection profile

| Parameter                   | Description                                                                                                   |
|-----------------------------|---------------------------------------------------------------------------------------------------------------|
| <i>&lt;profile-name&gt;</i> | The name of the IPsec profile to use. This is the profile created by the <b>crypto ipsec profile</b> command. |

**Default** The L2TP tunnel protection profile is set to the IPsec profile named 'default' by default.

**Mode** L2TP Tunnel Configuration

**Example** To set up tunnel1 with IPsec protection using IPsec profile 'profile1', use the commands:

```
awplus# configure terminal
awplus(config)# l2tp tunnel tunnel1
awplus(config-l2tp-tunnel)# protection ipsec
awplus(config-l2tp-tunnel)# protection profile profile1
```

To reset tunnel1 to use IPsec protection with IPsec profile 'default', use the commands:

```
awplus# configure terminal
awplus(config)# l2tp tunnel tunnel1
awplus(config-l2tp-tunnel)# no protection profile
```

**Related Commands**

- [crypto ipsec profile](#)
- [l2tp tunnel](#)
- [protection ipsec](#)
- [protection local-name](#)
- [protection remote-name](#)
- [show l2tp tunnel config-check](#)
- [show running-config l2tp-tunnel](#)

# protection remote-name

**Overview** Use this command to set the L2TP tunnel IPsec remote name. This is the remote identifier for IKE.

Use the **no** variant of this command to reset the remote name to the default—the destination IP address of the tunnel.

**Syntax** `protection remote-name [<ipsec-remote-name>]`  
`no protection remote-name`

| Parameter                              | Description                           |
|----------------------------------------|---------------------------------------|
| <code>&lt;ipsec-remote-name&gt;</code> | The IPsec remote name for the tunnel. |

**Default** By default, the IPsec remote name is set to the destination IP address of the tunnel.

**Mode** L2TP Tunnel Configuration

**Usage** In order to set the IPsec remote name for the tunnel and add a corresponding ISAKMP key for the tunnel, set the IPsec remote name with this command (**protection remote-name**) and set the key for this by using the **crypto isakmp key** command with this remote name as the hostname.

**Example** To set the IPsec remote name for tunnel1 to 'office2' and set the key to 'friend', use the commands:

```
awplus# configure terminal
awplus(config)# l2tp tunnel tunnel1
awplus(config-l2tp-tunnel)# protection ipsec
awplus(config-l2tp-tunnel)# protection remote-name office2
awplus(config)# crypto isakmp key friend hostname office2
```

To reset the IPsec remote name for tunnel1 to default (destination IP address of the tunnel), use the commands:

```
awplus# configure terminal
awplus(config)# l2tp tunnel tunnel1
awplus(config-l2tp-tunnel)# no protection remote-name
```

**Related Commands**

- [crypto isakmp key](#)
- [l2tp tunnel](#)
- [protection ipsec](#)
- [protection local-name](#)
- [protection profile](#)
- [show l2tp tunnel config-check](#)

show running-config l2tp-tunnel

# remote-subaddress

**Overview** Use this command to set the remote sub-address for L2TPv2 tunnel authentication.

Use the **no** variant of this command to remove the sub-address from the tunnel configuration.

**Syntax** `remote-subaddress [<sub-address>]`  
`no remote-subaddress`

| Parameter                        | Description                            |
|----------------------------------|----------------------------------------|
| <code>&lt;sub-address&gt;</code> | The remote sub-address for the tunnel. |

**Default** The remote sub-address is not set by default; the outgoing L2TP sub-address AVP for the tunnel will not be populated.

**Mode** L2TP Tunnel Configuration

**Usage** If the L2TP peer is also an AR-Series firewall, the remote-subaddress must match the local sub-address configured at the other end of the tunnel.

If a remote sub-address is configured for the tunnel, this value is placed in the outgoing sub-address AVP. The other tunnel end point can check this value against its configured local sub-address for the tunnel before establishing the tunnel.

**Example** To set the remote sub-address of tunnel1 to 'office1', use the commands:

```
awplus# configure terminal
awplus(config)# l2tp tunnel tunnel1
awplus(config-l2tp-tunnel)# remote-subaddress office1
```

To remove the remote sub-address configuration from tunnel1, use the commands:

```
awplus# configure terminal
awplus(config)# l2tp tunnel tunnel1
awplus(config-l2tp-tunnel)# no remote-subaddress
```

**Related  
Commands**

- [l2tp tunnel](#)
- [local-subaddress](#)
- [show l2tp tunnel config-check](#)
- [show running-config l2tp-tunnel](#)

# shared-secret

**Overview** Use this command to set the secret password that is shared with L2TP tunnel peers. Use the **no** variant of this command to remove the shared secret.

**Syntax** `shared-secret <secret>`  
`no shared-secret`

| Parameter                   | Description                               |
|-----------------------------|-------------------------------------------|
| <code>&lt;secret&gt;</code> | The password shared with the tunnel peer. |

**Default** No shared secret is configured by default.

**Mode** L2TP Profile Configuration and L2TP Tunnel Configuration

**Example** To set tunnel secret to "my\_password" for tunnel profile "public", use the commands:

```
awplus# configure terminal
awplus(config)# l2tp-profile public
awplus(config-l2tp-profile)# shared-secret my_password
```

To set tunnel secret to "my\_password" for tunnel "tunnelone", use the commands:

```
awplus# configure terminal
awplus(config)# l2tp tunnel tunnelone
awplus(config-l2tp-tunnel)# shared-secret my_password
```

To remove the tunnel secret for the tunnel profile, use the commands:

```
awplus# configure terminal
awplus(config)# l2tp-profile public
awplus(config-l2tp-profile)# no shared-secret
```

To remove the tunnel secret for the tunnel 'tunnelone', use the commands:

```
awplus# configure terminal
awplus(config)# l2tp tunnel tunnelone
awplus(config-l2tp-tunnel)# no shared-secret
```

**Related Commands**

- [l2tp tunnel](#)
- [l2tp-profile](#)
- [show running-config l2tp-profile](#)
- [version](#)

# show debugging l2tp

**Overview** Use this command to display whether debugging of L2TP tunnels is on or off.

**Syntax** `show debugging l2tp`

**Mode** Privileged Exec

**Example** To display whether debugging of L2TP tunnels is on or off, use the command:

```
awplus# show debugging l2tp
```

**Output** Figure 72-1: Example output from **show debugging l2tp**

```
awplus#show debugging l2tp
L2TP Tunnel Debugging is on
```

**Related  
Commands** [debug l2tp](#)

# show interface tunnel (L2TPv3)

**Overview** Use this command to display status information of L2TPv3 tunnels.

**Syntax** show interface tunnel<0-255>

| Parameter | Description                                                     |
|-----------|-----------------------------------------------------------------|
| <0-255>   | Specify an L2TPv3 tunnel index in the range from 0 through 255. |

**Mode** Privileged Exec

**Examples** To display status information for L2TPv3 tunnel tunnel20, use the command.

```
awplus#show interface tunnel20
```

**Output** Figure 72-2: Example output of the **show tunnel interface** command on the console.

Table 72-1:

```
awplus#show interface tunnel20
Interface tunnel20
 Link is UP, administrative state is UP
 Hardware is Tunnel
 IPv4 address 192.168.10.1/24 broadcast 192.168.10.255
 IPv6 address 2001:db8:10::1/64
 IPv6 address fe80::5054:d4ff:fe84:d1aa/64
 index 16795714 metric 1 mtu 1480
 arp ageing timeout 300
 <UP,BROADCAST,RUNNING,MULTICAST>
 SNMP link-status traps: Disabled
 Tunnel source 192.168.1.1, destination 192.168.1.2
 Tunnel name local 192.168.1.1, remote 192.168.1.2
 Tunnel ID local 66, remote 77
 Tunnel protocol/transport l2tp v3, key disabled, sequencing
 disabled
 Tunnel TTL inherit
 Checksumming of packets disabled, path MTU discovery disabled
 input packets 0, bytes 0, dropped 0, multicast packets 0
 output packets 5, bytes 366, multicast packets 0 broadcast
 packets 0
 Time since last state change: 0 days 00:00:24
```



# show isakmp key (L2TPv3)

**Overview** Use this command to show the ISAKMP pre-shared key. Pre-shared key authentication using optionally encrypted shared keys identified by hostname, IPv4 or IPv6 address. Pre-shared keys are not viewable and stored encrypted in the running-configuration.

**Syntax** `show [crypto] isakmp key`

| Parameter | Description                                                                                                           |
|-----------|-----------------------------------------------------------------------------------------------------------------------|
| crypto    | Security specific command.                                                                                            |
| isakmp    | Internet Security Association Key Management Protocol provides a common framework for key management implementations. |
| key       | Pre-shared key.                                                                                                       |

**Mode** Privileged Exec

**Examples** To show ISAKMP pre-share key, use the command.

```
awplus#show isakmp key
```

**Output** Figure 72-3: Example output of the **show isakmp key** command on the console.

Table 72-2:

|                        |             |
|------------------------|-------------|
| awplus#show isakmp key |             |
| Hostname/IP address    | key         |
| 10.2.0.10              | mytunnelkey |

# show l2tp session

**Overview** Use this command to display a summary or detailed list of information about L2TP sessions.

**Syntax** `show l2tp session [detail]`

| Parameter | Description                                             |
|-----------|---------------------------------------------------------|
| detail    | Displays more detailed information about L2TP sessions. |

**Mode** Privileged Exec

**Example** To display summary information about all L2TPv2 sessions, use the command:

```
awplus# show l2tp session
```

**Output** Figure 72-4: Example output from **show l2tp session**

```
awplus#show l2tp session

L2TP Session Information

Session ID: 59400
Tunnel ID: 25351
State: RETRY
Type: LAIC
Created At: May 31 20:03:04 2016
Interface Name: ppp1
Remote Session ID: 61156
Establish Timeout: 120
```

Table 72-3: Parameters in the output from **show l2tp session**

| Parameter  | Description                                 |
|------------|---------------------------------------------|
| Session ID | L2TP session ID.                            |
| Tunnel ID  | The ID of the L2TP tunnel for this session. |

Table 72-3: Parameters in the output from **show l2tp session** (cont.)

| Parameter         | Description                                                                                                                                                                                                                                                                                                                                  |
|-------------------|----------------------------------------------------------------------------------------------------------------------------------------------------------------------------------------------------------------------------------------------------------------------------------------------------------------------------------------------|
| State             | The current state of the L2TP session: <ul style="list-style-type: none"> <li>idle—Idle</li> <li>wait-tunnel—Await tunnel</li> <li>wait-reply—Await reply</li> <li>wait-connect—Await connect</li> <li>wait-cs-answer—Await circuit switched answer</li> <li>established—Successful connection</li> <li>retry—Retrying connection</li> </ul> |
| Type              | The type of the L2TP session: <ul style="list-style-type: none"> <li>LAIC—LAC incoming call</li> <li>LAOC—LAC outgoing call</li> <li>LNIC—LNS incoming call</li> <li>LNOC—LNS outgoing call</li> <li>UNSPEC—unspecified call type</li> </ul>                                                                                                 |
| Created At        | The date and time when the session was created.                                                                                                                                                                                                                                                                                              |
| Interface Name    | The name of the interface for this session.                                                                                                                                                                                                                                                                                                  |
| Remote Session ID | The ID of the session on the peer.                                                                                                                                                                                                                                                                                                           |
| Establish Timeout | The time (in seconds) that a session will wait for the peer to complete the session setup message exchange.                                                                                                                                                                                                                                  |

**Related Commands** [l2tp tunnel](#)  
[show l2tp tunnel](#)

# show l2tp tunnel

**Overview** Use this command to display information about all the current L2TP tunnels.

**Syntax** `show l2tp tunnel [detail]`

| Parameter | Description                                                |
|-----------|------------------------------------------------------------|
| detail    | Display additional detailed information about the tunnels. |

**Mode** Privileged Exec

**Usage** The output from this command depends on whether it won the tiebreaker and took the LAC role for the tunnel, or lost the tiebreaker and took the LNS role. In the latter case, a corresponding idle LAC tunnel is also displayed.

**Example** To display information about all L2TPv2 tunnels, use the command:

```
awplus# show l2tp tunnel
```

**Output** Figure 72-5: Example output from **show l2tp tunnel**

```
AWP-2#show l2tp tunnel

L2TP Tunnel Information

Tunnel ID: 25351
Tunnel Name: tunnell
Local IP Address: 10.1.1.2
Remote IP Address: 10.1.1.1
State: ESTABLISHED
Created At: May 31 20:03:04 2016
Tunnel Mode: LAC
Remote Tunnel ID: 43832
Remote Host Name: AWP-1
Remote Vendor Name: Allied Telesis International
Local UDP Port: 1701
Remote UDP Port: 1701
Hello Timeout: 60
Retry Timeout: 1
Idle Timeout: 0
Establish Timeout: 60
```

Figure 72-6: Example output from **show l2tp tunnel detail**

```
awplus#show l2tp tunnel detail

L2TP Tunnel Information details

Tunnel 25351, from 10.1.1.2 to 10.1.1.1:-
 state: ESTABLISHED
 created at: May 31 20:03:04 2016
 administrative name: 'tunnell1'
 created by admin: YES, tunnel mode: LAC, persist: YES
 peer tunnel id: 43832, host name: AWP-1
 UDP ports: local 1701, peer 1701
 authorization mode: CHALLENGE, hide AVPs: OFF
 digest type: md5
 tunnel secret: 'hello'
 session limit: 0, session count: 1
 tunnel profile: tunnel_profile_tunnell1, session profile:
 session_profile_tunnell1, peer profile: peer_profile_tunnell1
 hello timeout: 60, retry timeout: 1, idle timeout: 0
 establish timeout: 60
 persist pend timeout: 60
 rx window size: 10, tx window size: 10, max retries: 5
 use udp checksums: ON
 do pmtu discovery: OFF, mtu: 1460
 tos: inherit
 framing capability: SYNC ASYNC, bearer capability: DIGITAL
ANALOG
 use tiebreaker: ON
 tiebreaker: f6 5e 50 9c 02 99 45 83
 interoperability flags: 128
 trace flags: PROTOCOL FSM API AVP FUNC XPRT DATA PPP SYSTEM
Status:-
 peer vendor name: Allied Telesis International
 peer protocol version: 1.0, firmware 385
 peer framing capability: SYNC ASYNC
 peer bearer capability: DIGITAL ANALOG
 peer rx window size: 10
Transport status:-
 ns/nr: 8/9, peer 8/8
 cwnd: 9, ssthresh: 10, congpkt_acc: 0
Transport statistics:-
 out-of-sequence control/data discards: 0/0
 zlbs tx/txfail/rx: 6/0/5
 retransmits: 0, duplicate pkt discards: 0, data pkt discards:
 0
 hellos tx/txfail/rx: 1/0/5
 control rx packets: 14, rx bytes: 413
 control tx packets: 14, tx bytes: 542
 data rx packets: 4, rx bytes: 100, rx errors: 0
 data tx packets: 14, tx bytes: 512, tx errors: 0
memory usage: 2111 bytes
Events:-
 20:03:04 OPEN_REQ in state IDLE, new state WAITCTLREPLY
 20:03:04 SCCRP_ACCEPT in state WAITCTLREPLY, new state
ESTABLISHED
```

**Table 73:** Parameters in the output from **show l2tp tunnel** .

| Parameter          | Description                                                                                                                                                                                                                                                                                                             |
|--------------------|-------------------------------------------------------------------------------------------------------------------------------------------------------------------------------------------------------------------------------------------------------------------------------------------------------------------------|
| Tunnel ID          | The L2TP tunnel ID, (assigned automatically by the device).                                                                                                                                                                                                                                                             |
| Tunnel Name        | The name of the L2TP tunnel as specified by the <b>l2tp tunnel</b> command.                                                                                                                                                                                                                                             |
| Local IP Address   | The IPv4 or IPv6 address of the tunnel on this device. This is either specified by the configuration if the device is in LAC mode, or assigned automatically by the device if it is in LNS mode. This may be specified directly by the <b>source</b> command, or derived from the interface set by that command.        |
| Remote IP Address  | The IPv4 or IPv6 address of the device at the remote end of the tunnel. This may be specified directly by the <b>destination</b> command, or derived from a domain name set by that command.                                                                                                                            |
| State              | The current state of the tunnel: <ul style="list-style-type: none"> <li>idle—Idle</li> <li>wait-ctl-reply—Await control reply</li> <li>wait-ctl-conn—Await connect reply</li> <li>established—Successful connection</li> <li>closing—Closing connection</li> <li>retry—Tie breaker lost, retrying connection</li> </ul> |
| Created at         | The date and time when the tunnel was created.                                                                                                                                                                                                                                                                          |
| Tunnel Mode        | The tunnel mode: <ul style="list-style-type: none"> <li>LAC—L2TP Access Concentrator—the initiating end of the tunnel</li> <li>LNS—L2TP Network Server—the other end of the tunnel, authenticates the user and starts the PPP negotiation.</li> </ul>                                                                   |
| Remote Tunnel ID   | The tunnel ID on the L2TP peer.                                                                                                                                                                                                                                                                                         |
| Remote Host Name   | The host name of the L2TP peer.                                                                                                                                                                                                                                                                                         |
| Remote Vendor Name | The name of the vendor for the L2TP peer device. E.g. Allied Telesis International.                                                                                                                                                                                                                                     |
| Local UDP Port     | By default the local UDP port used for both L2TPv2 managed tunnels and L2TPv3 unmanaged tunnels (Ethernet Pseudowires) is 1701. If both are configured, change the UDP port for the unmanaged tunnel ( <b>l2tp unmanaged port</b> command).                                                                             |
| Remote UDP Port    | The UPD port used by the remote device for this L2TP tunnel.                                                                                                                                                                                                                                                            |

**Table 73:** Parameters in the output from **show l2tp tunnel** . (cont.)

| Parameter         | Description                                                                                               |
|-------------------|-----------------------------------------------------------------------------------------------------------|
| Hello Timeout     | The period between sending L2TP Hello messages (in seconds).                                              |
| Retry Timeout     | The delay (in seconds) before sending the first retry of unacknowledged control frames.                   |
| Idle Timeout      | The time (in seconds) that a tunnel will remain after its last session has been torn down.                |
| Establish Timeout | The time (in seconds) that a tunnel will wait for the peer to complete the tunnel setup message exchange. |

**Related  
Commands** [l2tp tunnel](#)

# show l2tp tunnel config-check

**Overview** Use this command to check the configuration of the specified L2TP tunnel or all L2TP tunnels for errors or missing required configuration.

**Syntax** `show l2tp tunnel [<tunnel-name>] config-check`

| Parameter                        | Description                                                                      |
|----------------------------------|----------------------------------------------------------------------------------|
| <code>&lt;tunnel-name&gt;</code> | The name of the L2TP tunnel to check. If not specified, all tunnels are checked. |

**Mode** Privileged Exec

**Usage** Only tunnels that have a complete configuration may appear in the **show l2tp tunnel** commands. For details of the configuration in the system, use the **show running-config l2tp-tunnel** command.

**Example** To check for missing L2TP tunnel configuration for the tunnel 'tunnel1', use the command:

```
awplus# show l2tp tunnel config-check
```

**Output** Figure 72-7: Example output from **show l2tp tunnel config-check**

```
awplus#show l2tp tunnel config-check

L2TP Tunnel tunnel1:
 Complete Configuration

L2TP Tunnel tunnel2:
 Incomplete Configuration
 Missing tunnel name or tunnel name mismatch
 Required: PPP interface
 Required: destination
 Source IP address required when IPSec protection on
```



Table 72-1: Parameters in the output from **show l2tp tunnel config-check**

| Parameter                | Description                                                                                                                                                                                                                                                                                                                                                                                                                                                                                                                                                                                  |
|--------------------------|----------------------------------------------------------------------------------------------------------------------------------------------------------------------------------------------------------------------------------------------------------------------------------------------------------------------------------------------------------------------------------------------------------------------------------------------------------------------------------------------------------------------------------------------------------------------------------------------|
| Complete configuration   | The tunnel has a complete and valid configuration.                                                                                                                                                                                                                                                                                                                                                                                                                                                                                                                                           |
| Incomplete configuration | <p>There is configuration still required or invalid for this tunnel, as specified.</p> <p>Examples of possible messages indicating missing or invalid configuration include:</p> <ul style="list-style-type: none"><li>• Missing tunnel name or tunnel name mismatch</li><li>• Required: PPP interface</li><li>• Required: destination</li><li>• Required: IP version</li><li>• Destination IP address does not match the configured IP version</li><li>• Source IP address does not match the configured IP version</li><li>• Source IP address required when IPSec protection on</li></ul> |

**Related Commands** [show running-config l2tp-tunnel](#)

# show running-config l2tp-profile

**Overview** Use this command to display the running configuration for L2Tp profiles.

**Syntax** `show running-config l2tp-profile`

**Mode** Privileged Exec

**Example** To display the running configuration of L2TP profiles, use the command:

```
awplus# show running-config l2tp-profile
```

**Output** Figure 72-8: Example output from **show running-config l2tp-profile**

```
awplus#show running-config l2tp-profile

l2tp-profile public
version 2
secret "my_password"
```

**Related  
Commands** [l2tp-profile](#)  
[shared-secret](#)  
[version](#)

# show running-config l2tp-tunnel

**Overview** Use this command to display the current details for L2TP tunnel configuration.

**Syntax** `show running-config l2tp-tunnel`

**Mode** Privileged Exec

**Example** To display the L2TP tunnel running configuration, use the command:

```
awplus# show running-config l2tp-tunnel
```

**Output** Figure 72-9: Example output from **show running-config l2tp-tunnel**

```
awplus#show running-config l2tp-tunnel
l2tp tunnel example
 version 2
 ip-version 4
 encapsulation ppp 0
 source 1.0.0.2
 destination 1.0.0.1
 local-subaddress TUNNEL2
 remote-subaddress TUNNEL1
!
```

**Related  
Commands**

[destination](#)  
[encapsulation ppp](#)  
[ip-version](#)  
[l2tp tunnel](#)  
[local-subaddress](#)  
[protection ipsec](#)  
[protection local-name](#)  
[protection profile](#)  
[protection remote-name](#)  
[remote-subaddress](#)  
[shared-secret](#)  
[show l2tp tunnel config-check](#)  
[source](#)  
[version](#)

# source

**Overview** Use this command to set the source address or interface for an L2TP tunnel.  
Use the **no** variant of this command to remove the source address or interface from an L2TP tunnel.

**Syntax** `source [<interface-name>|<ipv4-addr>|<ipv6-addr>`  
`no source`

| Parameter                           | Description                                                        |
|-------------------------------------|--------------------------------------------------------------------|
| <code>&lt;interface-name&gt;</code> | The name of the interface to be used as the tunnel starting point. |
| <code>&lt;ipv4-addr&gt;</code>      | The IPv4 address to be used as the tunnel starting point.          |
| <code>&lt;ipv6-addr&gt;</code>      | The IPv6 address to be used as the tunnel starting point.          |

**Default** If no source address or interface is configured, the source address used will be calculated based on the route to the tunnel destination.

**Mode** L2TP Tunnel Configuration

**Example** To configure IP address 10.1.1.2 as the source address for the tunnel named 'tunnel1', use the commands:

```
awplus# configure terminal
awplus(config)# l2tp tunnel tunnel1
awplus(config-l2tp-tunnel)# source 10.1.1.2
```

To remove the configured source address from 'tunnel1', so that it uses the default source, use the commands:

```
awplus# configure terminal
awplus(config)# l2tp tunnel tunnel1
awplus(config-l2tp-tunnel)# no source
```

**Related Commands** [destination](#)  
[l2tp tunnel](#)  
[show l2tp tunnel](#)

# tunnel local id

**Overview** This command specifies a tunnel local identifier sent to the peer to match. Use the **no** variant of this command to remove the tunnel local ID.

**Syntax** tunnel local id <1-2147483647>  
no tunnel local id

| Parameter      | Description                         |
|----------------|-------------------------------------|
| <1-2147483647> | Tunnel ID from 1 through 2147483647 |

**Default** No tunnel local ID is set.

**Mode** Interface Configuration

**Usage** The endpoints of the tunnel must be configured by mirroring tunnel IDs, that is, the tunnel local ID on one endpoint must be specified as the tunnel remote ID on the other endpoint.

The local session ID defaults to the tunnel local ID and the local session ID is not configurable. A session provides the data channel in L2TPv3. There is a single pseudowire per L2TP session.

**Examples** To specify a tunnel local ID, use the commands:

```
awplus#configure terminal
awplus(config)#interface tunnel20
awplus(config-if)#tunnel mode l2tp v3
awplus(config-if)#tunnel local id 22
```

To remove the tunnel local ID, use the commands:

```
awplus#configure terminal
awplus(config)#interface tunnel20
awplus(config-if)#no tunnel local id
```

**Related Commands** [tunnel remote id](#)

**Validation Commands** [show interface tunnel \(L2TPv3\)](#)

# tunnel mode (L2TPv3)

**Overview** Use this command to configure the encapsulation tunneling mode.  
Use the **no** variant of this command to remove an established tunnel.

**Syntax** tunnel mode {gre [ipv6]|ipsec {ipv4|ipv6}|ipv6|l2tp v3  
[ipv6]|openvpn {tap|tun}}  
no tunnel mode

| Parameter    | Description                                                                         |
|--------------|-------------------------------------------------------------------------------------|
| gre          | GRE IPv4 or IPv6 as the payload over IPv4 tunneling. IPv4 is the delivery protocol. |
| gre ipv6     | GRE IPv4 or IPv6 as the payload over IPv6 tunneling. IPv6 is the delivery protocol. |
| ipsec ipv4   | IPv4 IPsec tunnel                                                                   |
| ipsec ipv6   | IPv6 IPsec tunnel                                                                   |
| l2tp v3      | Layer 2 Tunneling Protocol version 3. By default, IPv4 is the deliver protocol.     |
| l2tp v3 ipv6 | Set IPv6 as the deliver protocol for L2TPv3                                         |
| openvpn tap  | OpenVPN TAP mode                                                                    |
| openvpn tun  | OpenVPN TUN mode                                                                    |

**Mode** Interface Configuration

**Usage** A tunnel will not become operational until it is configured with this command.

**Examples** To configure L2TPv3 as the encapsulation tunneling mode, use the commands:

```
awplus#configure terminal
awplus(config)#interface tunnel20
awplus(config-if)#tunnel mode l2tp v3
```

To remove the established tunnel, use the commands:

```
awplus#configure terminal
awplus(config)#interface tunnel20
awplus(config-if)#no tunnel mode
```

**Validation Commands** [show interface tunnel \(L2TPv3\)](#)

# tunnel protection ipsec

**Overview** Use this command to optionally enable IPsec protection for packets encapsulated by this tunnel.

Use the no variant of this command to disable IPsec protection.

**Syntax** tunnel protection ipsec  
no tunnel protection ipsec

**Default** IPsec protection for packets encapsulated by tunnel is disabled.

**Mode** Interface Configuration

**Usage** You also need to configure a pre-shared key in conjunction with this command. See the crypto isakmpkey command for more information about configuring the pre-share key.

**Examples** To enable IPsec protection for packets encapsulated by tunnel114, use the commands:

```
awplus#configure terminal
awplus(config)#interface tunnel114
awplus(config-if)#tunnel protection ipsec
```

To disable IPsec protection for packets encapsulated by tunnel114, use the commands:

```
awplus#configure terminal
awplus(config)#interface tunnel114
awplus(config-if)#no tunnel protection ipsec
```

# tunnel remote id

**Overview** This command specifies a tunnel remote identifier sent to the peer for match. Use the **no** variant of this command to remove the tunnel remote ID.

**Syntax** tunnel remote id <1-2147483647>  
no tunnel remote id

| Parameter      | Description                         |
|----------------|-------------------------------------|
| <1-2147483647> | Tunnel ID from 1 through 2147483647 |

**Default** No tunnel remote ID is set.

**Mode** Interface Configuration

**Usage** The endpoints of the tunnel must be configured by mirroring tunnel IDs, that is, the tunnel remote ID on one endpoint must be specified as the tunnel local ID on the other endpoint.

The remote session ID defaults to the tunnel remote ID and the remote session ID is not configurable. A session provides the data channel in L2TPv3. There is a single pseudowire per L2TP session.

**Examples** To specify a tunnel remote ID, use the commands:

```
awplus#configure terminal
awplus(config)#interface tunnel20
awplus(config-if)#tunnel mode l2tp v3
awplus(config-if)#tunnel remote id 22
```

To remove the tunnel remote ID, use the commands:

```
awplus#configure terminal
awplus(config)#interface tunnel20
awplus(config-if)#no tunnel remote id
```

**Related Commands** [tunnel local id](#)

**Validation Commands** [show interface tunnel \(L2TPv3\)](#)



# version

**Overview** Use this command to specify the protocol version of a L2TP tunnel.

**Syntax** `version [<version>]`

| Parameter                    | Description                                                      |
|------------------------------|------------------------------------------------------------------|
| <code>&lt;version&gt;</code> | The protocol version of the L2TP tunnel. Version 2 is supported. |

**Default** The L2TP version is 2 by default.

**Mode** L2TP Profile Configuration and L2TP Tunnel Configuration

**Example** To use L2TPv2 for L2TP tunnel profile 'public', use the commands:

```
awplus# configure terminal
awplus(config)# l2tp-profile public
awplus(config-l2tp-profile)# version 2
```

To use L2TPv2 for L2TP tunnel 'tunnelone', use the commands:

```
awplus# configure terminal
awplus(config)# l2tp tunnel tunnelone
awplus(config-l2tp-tunnel)# version 2
```

**Related Commands**

- [l2tp tunnel](#)
- [l2tp-profile](#)
- [shared-secret](#)
- [show running-config l2tp-profile](#)